

# **VTA's BART SILICON VALLEY— PHASE II EXTENSION PROJECT TRANSPORTATION IMPACT ANALYSIS OF THE BART EXTENSION AND VTA'S TRANSIT-ORIENTED JOINT DEVELOPMENT**

## **PREPARED FOR:**

Santa Clara Valley Transportation Authority  
U.S. Department of Transportation  
Federal Transit Administration



## **PREPARED BY:**

Hexagon Transportation Consultants, Inc.  
4 North Second Street, Suite 400  
San Jose, CA 95113

November 2017

Hexagon Transportation Consultants, Inc. 2017. VTA's BART Silicon Valley  
—Phase II Extension Project Transportation Impact Analysis of the BART  
Extension and VTA's Transit-Oriented Joint Development Only. November.  
San Jose, CA. Prepared for the Santa Clara Valley Transportation Authority,  
San Jose, CA, and the Federal Transit Administration, Washington, D.C.

## E.1 Introduction

This Errata reflects the modifications to *VTA's BART Silicon Valley Phase II Extension Project: Transportation Impact Analysis of the BART Extension and VTA's Transit-Oriented Joint Development* (BART Extension with TOJD TIA) that may have resulted from comments received during the public review of the Supplemental Environmental Impact Statement (SEIS) and Subsequent Environmental Impact Report (SEIR) for the BART Silicon Valley Phase II Extension (Phase II) Project or that were required for purposes of clarifications. Changes to the BART Extension with TOJD TIA are shown in ~~strikeout~~ text for deletions and in underline text for additions.

These modifications do not alter the conclusions of the environmental analysis such that new significant environmental impacts have been identified, nor do they constitute significant new information. The modifications are provided by chapter and indicated with the page number from the BART Extension with TOJD TIA that they would replace. This Errata is intended to be used in conjunction with the BART Extension with TOJD TIA.

## E.2 Chapter/Section Changes

### E.2.1 Global Changes to the Report

Two station names from the Phase I Extension have been renamed: the Berryessa Station (or Berryessa BART Station) is now the Berryessa/North San Jose Station. The Milpitas BART Station is officially the Milpitas Station.

### E.2.2 Changes to the *Executive Summary*

#### **Page v, *Scope of Work***

Both the Downtown San Jose Station and the Diridon Station are located within the Downtown Core Area as defined by the San Jose Downtown Strategy 2000 Environmental Impact Report (EIR), and the office and retail uses proposed for the Transit-Oriented Joint Development at these stations are fully consistent with that EIR. Therefore, based on guidance from City of San Jose staff, it is not necessary to include the Downtown and Diridon Stations in this TIA, although further traffic analysis will be required when specific TOJD development proposals are submitted to the City.

#### **Page vii, *Project Impacts under 2025 Background Plus Project Conditions***

##### **Coleman Avenue and Brokaw Road (#33)**

**Impact:** This intersection located in Santa Clara near the Santa Clara Station is expected to operate at an unacceptable level of service (LOS D~~F~~) during the PM peak hour under 2025 Background and 2025 Background Plus Project Conditions. ~~but at an unacceptable level of service (LOS F) under 2025 Background Plus Project Conditions.~~ The proposed Project would cause the intersection’s average critical delay to increase by more than 4 seconds and the critical volume-to-capacity ratio (V/C) to increase by more than 0.01 during the PM peak hour under 2025 Background Plus Project Conditions. This constitutes a significant impact to the intersection under the City of Santa Clara definition.

**Mitigation:** Widen Coleman Road to accommodate a third southbound through lane. Change the signal control for Brokaw Road (the east and west legs of this intersection) from Protected Left-Turn phasing to Split Phase. Add a shared through/left-turn lane to the east and west approaches within the existing right-of-way. Change the existing shared through/right-turn lanes to right-turn only lanes on the east and west approaches, and change the eastbound right-turn coding from Include to Overlap, indicating that many eastbound right turns would be able to turn “right on red.” With implementation of this mitigation measure, or a comparable mitigation measure as determined upon coordination with the City of Santa Clara, the intersection would operate at LOS D under 2025 Background Plus Project Mitigated Conditions; therefore, the impact would be mitigated to a *less-than-significant level*.

## **Page vii, *Project Impacts under 2035 Cumulative Plus Project Conditions***

### **De La Cruz Boulevard and Central Expressway (#30) \***

~~The Santa Clara County Department of Roads and Airports plans to convert the existing eastbound High Occupancy Vehicle (HOV) lane to a mixed-use lane at this intersection. This modification was included as a change to the roadway network under both the 2025 Background Plus Project Conditions and 2035 Cumulative Plus Project Conditions. No other feasible mitigation measures have been identified for this intersection. Therefore, the impact at this intersection would be *significant and unavoidable*. Proposed improvements at the nearby interchange of US 101 and De La Cruz Boulevard-Trimble Road are expected to improve operations at the intersection of De La Cruz Boulevard and Central Expressway, but it is uncertain how much improvement would occur.~~

State Congestion Management law requires a local jurisdiction to prepare a deficiency plan (now referred to as ‘Multimodal Improvement Plan’ in the Santa Clara County CMP maintained by VTA) when roadway level of service standards are not maintained on the designated CMP system [California Government Code Section 65098.4]. VTA maintains



guidelines for the development of Multimodal Improvement Plans which were developed in consultation with Member Agencies (i.e., the 15 cities of Santa Clara County and the County of Santa Clara) and last adopted by the VTA Board in September 2010. According to these guidelines, Multimodal Improvement Plans are prepared by Member Agencies in response to the transportation impacts of land use plans and development projects. The impact to this intersection is a result of the TOJD component of the Project and not due to the BART extension; however, VTA's guidelines do not address a situation where a land use project that is led by VTA contributes to an impact on a CMP facility. With this in mind, VTA commits to ~~work with the City of Santa Clara and the County of Santa Clara in the preparation of~~ preparing a Multimodal Improvement Plan for identified Project impacts to CMP intersections and to coordinating with the City of Santa Clara and Santa Clara County in its preparation.

## Page xii, *Parking Analysis*

Parking for kiss-and-ride BART patrons is addressed in the "BART Extension TIA." Parking for the TOJD portion of the Project is addressed in this TIA, based on the parking requirements of the appropriate city for the Alum Rock/28<sup>th</sup> Street Station and the Santa Clara Station. The discussion below regarding parking at both stations is illustrative only, and a final determination regarding the amount of required parking will be made in conjunction with each specific TOJD proposal when detailed plans are submitted to the city where the TOJD is located.

## E.2.3 **Changes to Chapter 1, Section on San Jose Downtown Strategy 2000 and Diridon Station Area Plan**

### Page 9

Because of the location of the proposed Transit-Oriented Joint Developments near the Downtown San Jose and Diridon Stations within the Downtown Core Area and because the preliminary plans for TOJD are fully consistent with the San Jose Downtown Strategy 2000 EIR, City of San Jose staff have concluded that an intersection analysis of the TOJD at those stations is not required at this stage. Site planning and design for the TOJD at these stations are still in a very preliminary stage. ~~these developments are exempt from the City of San Jose Transportation Level of Service Policy (Council Policy 5-3) and will not require preparation of a comprehensive Transportation Impact Analysis (TIA).~~ Based on guidance from City of San Jose staff<sup>1</sup>, analysis of the proposed Transit-Oriented Joint Development at these two stations was environmentally cleared at a project level covered in the San Jose Downtown Strategy 2000 EIR, and therefore is not included in this TIA.

---

<sup>1</sup> Email from Mr. Alex Wong, San Jose Department of Public Works, Development Services Division, dated October 1, 2015, to Mr. Brian Jackson and Mr. At van den Hout of Hexagon Transportation Consultants.

Also, the City of San Jose is currently in the process of updating its Downtown Strategy 2000 EIR, including a new transportation impact analysis for future development. When specific development proposals for the TOJD at the Downtown San Jose and Diridon Stations are filed with the City of San Jose, a final determination will be made as to whether project-level impacts within downtown are covered by the updated Strategy 2000 EIR.

In addition to the transportation impact analyses for the Downtown San Jose and Diridon Station TOJD after specific development proposals have been prepared, The San Jose Public Works Department has requested that a traffic operations study will also be prepared conducted at a future date prior to construction of the Project in order to identify potential operational issues at these sites that could occur as a result of the Transit-Oriented Joint Development at the Downtown San Jose and Diridon Stations.<sup>2</sup> Site planning and design for the Transit-Oriented Joint Developments at these stations are still in a very preliminary stage; therefore, a detailed traffic operations analysis of intersection queuing, site access, and on-site circulation at these locations will be prepared and submitted to the City of San Jose Public Works Department for their review at a future date when detailed site plans are available.

Because the office and retail Transit-Oriented Joint Development proposed for Diridon Station is consistent with the DSAP, it is may also be covered by that EIR, although a final determination will be made by the City of San Jose when a specific development proposal is submitted.

## **E.2.4 Changes to Chapter 2, Section on *Existing Bicycle Facilities***

### **Page 27, Alum Rock/28<sup>th</sup> Street Station**

The Alum Rock/28<sup>th</sup> Street Station site is moderately accessible by bicycle. The station site is surrounded by bicycle facilities, but none provide a direct connection to the site. Class II bike lanes are provided on Mabury Road, 21<sup>st</sup> Street, portions of San Antonio Street, and Jackson Avenue. There are currently no Class I bikeways that serve the station area, but new Class I facilities are planned in order to provide improved bike and pedestrian access to the station in the future. The streets near the station site, Santa Clara Street/Alum Rock Avenue and McKee Road, are identified as “high caution” roads in VTA’s Bikeways Map (May 2016).

San Jose’s Bike Plan 2020 includes a planned 100-mile Interconnected Trail Network, which includes two Class I bikeways near the Alum Rock/28<sup>th</sup> Street Station. The City of San Jose’s planned Coyote Creek Trail will complete a Class I bikeway along Coyote Creek between Milpitas (Dixon Landing Road) and Coyote Lake in the South County.

---

<sup>2</sup> See Appendix G, Signed Workslope for the Phase II Project from City of San Jose Department of Public Works, Development Services Division.

Currently, bicycle facilities along this corridor are missing between Montague Expressway and Tully Road and Anderson Lake County Park and Coyote Lake County Park. Coyote Creek runs west of the Alum Rock/28<sup>th</sup> Street Station. In addition, San Jose’s Bike Plan 2020 includes development of a future trail alignment along the Five Wounds corridor, which was formerly used as a rail line. This future trail will provide improved pedestrian and bicycle access to and from the Alum Rock/28<sup>th</sup> Street Station.

## **E.2.5 Changes to Chapter 3, Section on 2025 Background Transportation Network**

### **Page 53**

In addition, the following changes at eight study intersections would be constructed by the Year 2025, based on input from the Cities of Santa Clara and San Jose. Further input received from the Santa Clara County Department of Roads and Airports and from the City of Santa Clara in early 2017 regarding the definition and timing of some proposed improvements has resulted in additional changes to the 2025 network assumptions. Some of the previously assumed 2025 lane configuration changes have been deleted because they will not be implemented by 2025. These changes were incorporated into the lane geometry in the TRAFFIX software under the Background scenario:

#### Intersections Near Alum Rock/28<sup>th</sup> Street Station

- King Road and McKee Road (Study Intersection #7): Add a second eastbound left-turn lane on McKee Road.

#### Intersections Near Santa Clara Station

- Central Expressway and Scott Boulevard (#28): Convert existing through HOV lanes to mixed-flow lanes.
- Central Expressway and Lafayette Street (#29): Convert ~~existing westbound~~ through HOV lanes to a mixed-flow lanes; retain eastbound through HOV lane.
- Central Expressway and De La Cruz Boulevard (#30): ~~Convert existing eastbound HOV lane to mixed-flow lane.~~ (The existing eastbound HOV left-turn lane will be retained.)
- Coleman Avenue and Brokaw Road (#33): ~~Widen Coleman Avenue to accommodate a third southbound through lane.~~ (A third southbound through lane will not be implemented in 2025, but will be implemented in 2035.)
- Coleman Avenue and Hedding Street (#38): Add a second eastbound left-turn lane on Hedding Street.
- Coleman Avenue and Taylor Street (#39): Remove the free right-turn movement, add a westbound dedicated right-turn lane on Taylor Street.

- San Tomas Expressway and El Camino Real (#41): Add a second left-turn lane on ~~both the eastbound and westbound~~ all four intersection approaches.

## E.2.6 Changes to Chapter 3, Section on *Intersection Levels of Service under 2025 Background Conditions*

### Page 59, *Santa Clara Station*

#### City of Santa Clara Level of Service Analysis

The following three intersections would operate at unacceptable levels of service (LOS E or worse for local intersections and LOS F for expressways and CMP intersections) under 2025 Background Conditions during at least one peak hour:

- (#30) De La Cruz Boulevard and Central Expressway \* (LOS F – AM and PM peak hours)
- (#33) Coleman Avenue and Brokaw Road (LOS ~~E~~F – PM peak hour)
- (#41) San Tomas Expressway and El Camino Real \* (LOS F – ~~AM and~~ PM peak hours)

#### CMP Level of Service Analysis

The following CMP intersections would operate at unacceptable levels of service (LOS F) under 2025 Background Conditions during at least one peak hour:

- (#30) De La Cruz Boulevard and Central Expressway \* (LOS F – AM and PM peak hours)
- (#36) Coleman Avenue and I-880 Southbound Ramps \* (LOS F – AM peak hour)
- (#37) Coleman Avenue and I-880 Northbound Ramps \* (LOS F – AM peak hour)
- (#41) San Tomas Expressway and El Camino Real \* (LOS F – ~~AM and~~ PM peak hours)

### Page 59, Table 10: *2025 Background Conditions Intersection Levels of Service - Santa Clara Station*

Based on the changes to lane configurations (due to updated information from the City of Santa Clara and the County), the following changes are made to the Average Delay (in seconds) and Level of Service under 2025 Background No Project Conditions:

#29, Lafayette Street and Central Expressway\*: **AM** Average Delay ~~51.3~~51.7, LOS D;  
**PM** Average Delay ~~68.7~~77.0, LOS E

#30, De La Cruz Blvd and Central Expressway\*: **AM** Average Delay ~~310.3~~327.4, LOS F;  
**PM** Average Delay ~~401.2~~411.0, LOS F

#33, Coleman Avenue and Brokaw Road: AM Average Delay 17.217.1, LOS B; PM Average Delay 57.9123.0, LOS EF

#41, San Tomas Expressway and El Camino Real\*: AM Average Delay 83.878.9, LOS FE; PM Average Delay 129.5119.7, LOS F

## **E.2.7 Changes to Chapter 4, Section on 2025 Background Plus Project Conditions Intersection Levels of Service**

### **Page 96, Table 15: 2015 and 2025 Project Conditions Intersection Levels of Service – Santa Clara Station**

Based on the changes to lane configurations in 2025 (due to updated information from the City of Santa Clara and the County), the following changes are made to the Average Delay (in seconds) and Level of Service under 2025 Background No Project and 2025 Background Plus Project Conditions:

#29, Lafayette Street and Central Expressway\*:

**2025 No Project: AM Average Delay 51.351.7, LOS D; PM Average Delay 68.777.0, LOS E**

**2025 Plus Project: AM Average Delay 51.652.0, LOS D; PM Average Delay 68.476.5, LOS E**

This is a CMP intersection in Santa Clara, and the LOS threshold is E. The lane configuration change does not result in a change to the finding of no significant impact.

#30, De La Cruz Blvd and Central Expressway\*:

**2025 No Project: AM Average Delay 310.3327.4, LOS F; PM Average Delay 101.2111.0, LOS F**

**2025 Plus Project: AM Average Delay 306.7317.3, LOS F; PM Average Delay 102.8112.4, LOS F**

This CMP intersection would continue to operate at an unacceptable LOS with the lane configuration change. However, there is still no significant impact because the project results in an increase in critical delay of less than 4 seconds.

#33, Coleman Avenue and Brokaw Road:

**2025 No Project: AM Average Delay 17.217.1, LOS B; PM Average Delay 57.9123.0, LOS EF**

**2025 Plus Project: AM Average Delay 23.023.2, LOS C; PM Average Delay 113.7194.4, LOS F**

Prior to the lane configuration change, this intersection was significantly impacted in the PM peak hour. With the lane configuration change, there would still be a significant impact in the PM peak hour.

#41, San Tomas Expressway and El Camino Real\*:

**2025 No Project:** AM Average Delay ~~83.8~~78.9, LOS ~~E~~F; PM Average Delay ~~129.5~~119.7, LOS F

**2025 Plus Project:** AM Average Delay ~~82.8~~78.0, LOS ~~E~~F, PM Average Delay ~~126.8~~117.0, LOS F

This CMP intersection would continue to operate at an unacceptable LOS in the PM peak hour with the lane configuration change. However, there is still no significant impact because the project still results in a decrease in average delay, critical delay, and critical V/C.

Thus, the changes above do not result in a change to the impact findings.

## Page 102, Santa Clara Station

### City of Santa Clara Level of Service Analysis

The following three intersections would operate at unacceptable levels of service (LOS E or worse for local intersections and LOS F for expressways and CMP intersections) under 2025 Background Plus Project Conditions during at least one peak hour:

(#30) De La Cruz Boulevard and Central Expressway \* (LOS F – AM and PM peak hours)

(#33) Coleman Avenue and Brokaw Road (LOS F – PM peak hour)

(#41) San Tomas Expressway and El Camino Real \* (LOS F —~~AM and~~ PM peak hours)

### CMP Level of Service Analysis

The following CMP intersections would operate at unacceptable levels of service (LOS F) under 2025 Background Plus Project Conditions during at least one peak hour:

(#30) De La Cruz Boulevard and Central Expressway \* (LOS F – AM and PM peak hours)

(#36) Coleman Avenue and I-880 Southbound Ramps \* (LOS F – AM peak hour)

(#37) Coleman Avenue and I-880 Northbound Ramps \* (LOS F – AM peak hour)

(#41) San Tomas Expressway and El Camino Real \* (LOS F – ~~AM and~~ PM peak hours)

## E.2.8 Changes to Chapter 4, Section on Intersection Impacts and Proposed Mitigation Measures

### Page 102, Santa Clara Station

#### City of Santa Clara Impact Analysis

Mitigation ~~measures~~ for this intersection has been proposed as follows:

***Coleman Avenue and Brokaw Road:*** Widen Coleman Avenue to accommodate a third southbound through lane. Change the signal control for Brokaw Road (the east and west legs of this intersection) from Protected Left-Turn phasing to Split Phase. Add a shared through/left-turn lane to the east and west approaches within the existing right-of-way. Change the existing shared through/right-turn lanes to right-turn only lanes on the east and west approaches, and change the eastbound right-turn coding from Include to Overlap, indicating that many eastbound right turns would be able to turn “right on red.”

This mitigation measure is presented in Figure 30. With implementation of this mitigation measure, or a comparable mitigation measure as determined upon coordination with the City of Santa Clara, the intersection would operate at LOS D under 2025 Background Plus Project Mitigated Conditions; therefore, the impact would be mitigated to a *less-than-significant level*.

## **E.2.9 Changes to Chapter 5, Section on *Parking Analysis***

### **Page 132, Alum Rock/28<sup>th</sup> Street Station**

The discussion below regarding parking is illustrative only, and a final determination regarding the amount of required parking will be made in conjunction with the specific TOJD proposal for the Alum Rock/28<sup>th</sup> Street Station when detailed plans are submitted to the City of San Jose. For the TOJD component of the Project, a total of 2,150 parking spaces would be provided at the Alum Rock/28<sup>th</sup> Street Station: 1,650 spaces for the office use, 100 spaces for the retail use, and 400 spaces for the residential use. TOJD at the Alum Rock/28<sup>th</sup> Street Station would be subject to the parking requirements of the City of San Jose, as follows.

- Office: 4 spaces per 1,000 square feet.
- Retail: 5 spaces per 1,000 square feet.
- ~~Apartments~~Residential: 1.25 spaces per studio or 1-bedroom unit and 1.7 spaces per 2-bedroom unit.

Because the number of studio, 1-bedroom, and 2-bedroom apartments among the maximum of 275 units proposed for this station is still a preliminary estimate, the actual number of spaces required may change if the mix of different types of units is different from the estimate used in Table 24. This analysis, which is illustrative only, assumes that half of the units will be studio or 1-bedroom units and half will be 2-bedroom units.

### **Page 134, Santa Clara Station**

The discussion below regarding parking is illustrative only, and a final determination regarding the amount of required parking will be made in conjunction with the specific TOJD proposal for the Santa Clara Station when detailed plans are submitted to the City

of Santa Clara. For the TOJD component of the Project, a total of 2,200 parking spaces would be provided for the TOJD at the Santa Clara Station: 1,650 spaces for the office use, 150 spaces for the retail use, and 400 spaces for the residential use. TOJD at the Santa Clara Station would be subject to the parking requirements of the City of Santa Clara, as follows.

- Office: 3.33 spaces per 1,000 square feet.
- Retail: 5 spaces per 1,000 square feet.
- ~~Apartments~~ Residential: 1 space per studio unit, 1.5 spaces per 1-bedroom unit, and 2 spaces per 2-bedroom unit.

Based on these rates, the TOJD would be required to provide a total of 2,195 parking spaces for all the TOJD land uses. Because the number of studio, 1-bedroom, and 2-bedroom apartments among the maximum of 220 units proposed for this station is still a preliminary estimate, the actual number of spaces required may change if the mix of different types of units is different from the estimate used in Table 24. In order to make this analysis of parking requirements conservative, this estimate, which is illustrative only, assumes that there will be 10 studio units, 100 1-bedroom units, and 110 2-bedroom units.

## **E.2.10 Changes to Chapter 6, Section on Year 2035 Land Use and Transportation Network**

### **Page 136**

- The roadway network as of 2035, based on improvements identified in MTC's Regional Transportation Plan for the Bay Area and VTA's Valley Transportation Plan 2040. Information on local intersection improvements also were obtained from both the Cities of San Jose and Santa Clara. Based on early 2017 input from the Santa Clara County Department of Roads and Airports, it is assumed that the eastbound HOV lane on Central Expressway will be retained east of Scott Boulevard.

## **E.2.11 Changes to Chapter 6, Section on 2035 Cumulative Plus Project Intersection Level of Service Analysis**

### **Page 149, Table 28: 2035 Cumulative Plus Project Conditions Intersection Level of Service – Santa Clara Station**

#29, Lafayette Street and Central Expressway\*:

**2035 No Project:** AM Average Delay ~~91.3~~93.7, LOS F; PM Average Delay ~~118.7~~136.8, LOS F

**2035 Plus Project:** AM Average Delay ~~91.7~~94.2, LOS F; PM Average Delay



~~120.1134.8~~, LOS F

Both with and without the Eastbound HOV lane on Central, this intersection would operate at LOS F under No Project and Plus Project conditions during both peak hours. However, the lane configuration change does not result in a change to the finding of no significant impact.

#30, De La Cruz Blvd and Central Expressway\*:

**2035 No Project:** AM Average Delay ~~368.4~~387.4, LOS F; PM Average Delay ~~227.3~~249.1, LOS F

**2035 Plus Project:** AM Average Delay ~~364.5~~383.0, LOS F; PM Average Delay ~~243.1~~265.9, LOS F

This CMP intersection would continue to operate at an unacceptable LOS with the lane configuration change (retention of Eastbound HOV left-turn lane). However, the lane configuration change does not result in a change to the findings of no significant impact during the AM peak hour and a significant impact in the PM peak hour.

## **E.2.12 Changes to Chapter 6, Section on 2035 Cumulative Plus Project Conditions Intersection Impacts and Proposed Mitigation Measures**

### **Page 152, City of Santa Clara Impact Analysis**

~~30. De La Cruz Boulevard and Central Expressway \*: The Santa Clara County Department of Roads and Airports plans to convert the existing eastbound High Occupancy Vehicle (HOV) lane to a mixed-use lane at this intersection. This modification was included as a change to the roadway network under both the 2025 Background Plus Project Conditions and 2035 Cumulative Plus Project Conditions. No other feasible mitigation measures have been identified for this intersection. Therefore, the impact at this intersection would be *significant and unavoidable*. Proposed improvements at the nearby interchange of US 101 and De La Cruz Boulevard-Trimble Road are expected to improve operations at the intersection of De La Cruz Boulevard and Central Expressway, but it is uncertain how much improvement would occur.~~

State Congestion Management law requires a local jurisdiction to prepare a deficiency plan (now referred to as ‘Multimodal Improvement Plan’ in the Santa Clara County CMP maintained by VTA) when roadway level of service standards are not maintained on the designated CMP system [California Government Code Section 65098.4]. VTA maintains guidelines for the development of Multimodal Improvement Plans which were developed in consultation with Member Agencies (i.e., the 15 cities of Santa Clara County and the County of Santa Clara) and last adopted by the VTA Board in September 2010.

According to these guidelines, Multimodal Improvement Plans are prepared by Member Agencies in response to the transportation impacts of land use plans and development projects. The impact to this intersection is a result of the TOJD component of the Project and not due to the BART extension; however, VTA’s guidelines do not address a

situation where a land use project that is led by VTA contributes to an impact on a CMP facility. With this in mind, VTA commits to ~~work with the City of Santa Clara and the County of Santa Clara in the preparation of~~preparing a Multimodal Improvement Plan for identified Project impacts to CMP intersections and to coordinating with the City of Santa Clara and Santa Clara County in its preparation.

### **E.2.13 Addition of Appendix I**

An analysis of the potential traffic impacts related to the vehicle trips generated by the Newhall Maintenance Facility is documented in a new appendix, Appendix I, “Newhall Maintenance Facility Trip Generation and Intersection Analysis.” Appendix I is attached to this Errata sheet.

## Appendix I

# Newhall Maintenance Facility Trip Generation and Intersection Analysis

---

Trip generation estimates for the Newhall Maintenance Facility have been prepared and the resulting number of AM and PM peak hour trips have been added to the 2035 Cumulative Plus Project traffic volumes at the study intersections near the Santa Clara Station. This analysis is based on the 2035 Cumulative Plus Project scenario for the BART Extension with TOJD Alternative because that scenario includes the greatest traffic volumes and therefore represents the “worst case” scenario.

Based on information provided by VTA, approximately 225 employees are projected to work at the Newhall Maintenance Facility. The percentage of those employees expected to work during the three different shifts are as follows:

- 8:00 AM – 4:00 PM: 40% (approximately 90 employees)
- 4:00 PM – Midnight: 30% (approximately 68 employees)
- Midnight – 8:00 AM: 30% (approximately 68 employees)

In order to estimate the number of inbound and outbound vehicle trips at the facility, the employee head count for each shift was reduced by 20% in order to account for alternative mode use and a typical absentee rate. It is assumed that some employees would use transit to get to and from work, since the facility will be well-served by BART, Caltrain, ACE/Capitol Corridor service, and numerous bus routes. Some employees may also carpool or bicycle to work. Further, a small percentage of employees are absent on a typical work day due to illness or vacation. Thus, the employee counts were reduced by 20% to develop an estimate of the number of inbound and outbound vehicle trips in the AM and PM peak hours. These trips were then assigned to the Santa Clara Station study intersections.

The additional trips projected to be generated by the Newhall Maintenance Facility were added to the revised 2035 Cumulative Plus Project traffic volumes. All study intersections were re-analyzed in TRAFFIX to determine if there would be any changes to the intersection analysis included in Chapter 6 of this TIA. Also, for the intersections of Lafayette Street and Central Expressway (#29) and De La Cruz Boulevard and Central Expressway (#30), the lane configuration included retention of the HOV lane on the eastbound approach, as requested by the Santa Clara County Department of Roads and Airports in a comment received during the public comment period.

The revised intersection analysis is presented in Table I-1. Compared with the Cumulative Plus Project results presented in Table 26 in Chapter 6 of this TIA, the average delay at would increase very slightly at numerous intersections as a result of the Newhall Maintenance Facility vehicle trips. However, there was only one intersection where the addition of Newhall vehicle trips changed the level of service. At the intersection of Coleman Avenue and Newhall Drive

(#35), the level of service in the PM peak hour is projected to be LOS D with 41.1 seconds of average delay with the Newhall vehicle trips, instead of LOS C with 32.3 seconds of average delay, as shown on Table 26, without the Newhall vehicle trips. The addition of vehicle trips related to the Newhall Maintenance Facility did not change the findings of significant impact at any of the study intersections.

**Table I-1  
2035 Cumulative Plus Project Conditions (BART + TOJD + Newhall) – Santa Clara Station**

| Study Number | Intersection  | Location    | Peak Hour              | 2025 Background   |     | 2035 Cumulative No Project |     | 2035 Cumulative + Project |     |  |                                 | SJ Impact <sup>2</sup><br>% Cumulative Trips from Project | SC and/or CMP Impact<br>Cumulative Incr. in Crit. Delay (sec) |
|--------------|---|-------------|------------------------|-------------------|-----|----------------------------|-----|---------------------------|-----|--|---------------------------------|---|---|
|              |   |             |                        | Avg. Delay (sec.) | LOS | Avg. Delay (sec.)          | LOS | Avg. Delay (sec.)         | LOS | Incr. In Crit. Delay (sec.) <sup>1</sup> | Incr. In Crit. V/C <sup>1</sup> |   |   |
| 28           | Scott Blvd & Central Expy *                           | Santa Clara | AM                     | 42.9              | D   | 43.4                       | D   | 43.6                      | D   | 0.0                                      | 0.000                           | --  | 0.0   |
|              |   |             | PM                     | 75.5              | E   | 171.9                      | F   | 178.1                     | F   | 14.7                                     | -0.057                          | --  | 14.7  |
| 29           | Lafayette St & Central Expy *                         | Santa Clara | AM                     | 51.7              | D   | 93.7                       | F   | 95.1                      | F   | 0.0                                      | 0.000                           | --  | 0.0   |
|              |   |             | PM                     | 77.0              | E   | 136.8                      | F   | 136.0                     | F   | 2.0                                      | 0.008                           | --  | 2.0   |
| 30           | De La Cruz Blvd & Central Expy *                      | Santa Clara | AM                     | 327.4             | F   | 387.4                      | F   | 385.9                     | F   | 0.0                                      | 0.000                           | --  | 0.0   |
|              |   |             | PM                     | 111.0             | F   | 249.1                      | F   | 271.7                     | F   | 40.0                                     | 0.027                           | --  | 40.0  |
| 31           | De La Cruz Blvd & Martin Ave                          | Santa Clara | AM                     | 34.8              | C   | 38.2                       | D   | 40.2                      | D   | 2.1                                      | 0.026                           | --  | 2.1   |
|              |   |             | PM                     | 31.8              | C   | 32.6                       | C   | 32.9                      | C   | 0.2                                      | 0.006                           | --  | 0.2   |
| 32           | De La Cruz Blvd & Reed St                             | Santa Clara | AM                     | 10.7              | B   | 13.7                       | B   | 14.3                      | B   | 1.0                                      | 0.014                           | --  | 1.0   |
|              |   |             | PM                     | 19.0              | B   | 19.6                       | B   | 20.0                      | B   | 1.0                                      | 0.016                           | --  | 1.0   |
| 33           | Coleman Ave & Brokaw Rd                               | Santa Clara | AM                     | 17.1              | B   | 17.9                       | B   | 22.8                      | C   | 5.5                                      | 0.048                           | --  | 5.5   |
|              |   |             | PM                     | 123.0             | F   | 126.2                      | F   | 194.5                     | F   | 71.1                                     | 0.157                           | --  | 71.1  |
|              |   |             | <i>With Mitigation</i> |                   |     |                            |     |                           |     |  |                                 |   |   |
| 34           | Coleman Ave & Aviation Ave                            | San Jose    | AM                     | 31.3              | C   | 34.6                       | C   | 42.9                      | D   | 20.2                                     | 0.054                           | +23%  | --  |
|              |   |             | PM                     | 18.2              | B   | 18.2                       | B   | 18.5                      | B   | 0.6                                      | 0.025                           | +95%  | --  |
| 35           | Coleman Ave & Newhall Dr                              | San Jose    | AM                     | 14.2              | B   | 16.4                       | B   | 17.5                      | B   | 1.4                                      | 0.024                           | +9%   | --  |
|              |   |             | PM                     | 24.6              | C   | 30.5                       | C   | 41.1                      | D   | 22.5                                     | 0.108                           | +58%  | --  |
| 36           | Coleman Ave & I-880 SB Ramps *                        | San Jose    | AM                     | 107.9             | F   | 102.0                      | F   | 112.9                     | F   | 14.4                                     | 0.032                           | +7%   | --  |
|              |   |             | <i>With Mitigation</i> |                   |     |                            |     |                           |     |  |                                 |   |   |
| 37           | Coleman Ave & I-880 NB Ramps *                        | San Jose    | AM                     | 85.8              | F   | 84.8                       | F   | 91.2                      | F   | 8.6                                      | 0.020                           | -3%   | --  |
|              |   |             | PM                     | 32.6              | C   | 35.8                       | D   | 36.7                      | D   | -3.2                                     | 0.002                           | +4%   | --  |
| 38           | Coleman Ave & W. Hedding St                           | San Jose    | AM                     | 41.2              | D   | 59.4                       | E   | 60.5                      | E   | 24.5                                     | 0.129                           | -3%   | --  |
|              |   |             | PM                     | 36.7              | D   | 65.0                       | E   | 65.4                      | E   | 50.0                                     | 0.300                           | -1%   | --  |
| 39           | Coleman Ave & W. Taylor St                            | San Jose    | AM                     | 60.0              | E   | 67.3                       | E   | 67.5                      | E   | 9.3                                      | 0.039                           | -5%   | --  |
|              |   |             | PM                     | 63.7              | E   | 117.1                      | F   | 117.9                     | F   | 80.9                                     | 0.213                           | -2%   | --  |
| 40           | SR 87 & W. Taylor St                                  | San Jose    | AM                     | 28.7              | C   | 34.6                       | C   | 34.3                      | C   | 3.1                                      | 0.063                           | -8%   | --  |
|              |   |             | PM                     | 38.5              | D   | 54.4                       | D   | 53.2                      | D   | 32.0                                     | 0.124                           | -5%   | --  |
| 41           | San Tomas Expy & El Camino Real *                     | Santa Clara | AM                     | 78.9              | E   | 91.4                       | F   | 90.5                      | F   | 0.0                                      | 0.000                           | --  | 0.0   |
|              |   |             | PM                     | 119.7             | F   | 117.8                      | F   | 116.9                     | F   | -1.8                                     | 0.002                           | --  | -1.8  |
| 42           | Scott Blvd & El Camino Real *                         | Santa Clara | AM                     | 34.1              | C   | 37.1                       | D   | 37.1                      | D   | 0.5                                      | 0.012                           | --  | 0.5   |
|              |   |             | PM                     | 38.4              | D   | 41.4                       | D   | 42.0                      | D   | 1.3                                      | 0.015                           | --  | 1.3   |
| 43           | Lincoln St & El Camino Real *                         | Santa Clara | AM                     | 20.9              | C   | 28.6                       | C   | 28.6                      | C   | 0.1                                      | 0.004                           | --  | 0.1   |
|              |   |             | PM                     | 23.6              | C   | 23.8                       | C   | 23.6                      | C   | 0.0                                      | 0.006                           | --  | 0.0   |
| 44           | Monroe St & El Camino Real *                          | Santa Clara | AM                     | 35.8              | D   | 37.7                       | D   | 38.2                      | D   | 0.3                                      | 0.011                           | --  | 0.3   |
|              |   |             | PM                     | 33.4              | C   | 33.7                       | C   | 33.5                      | C   | -0.1                                     | 0.012                           | --  | -0.1  |
| 45           | Lafayette St & Reed St                                | Santa Clara | AM                     | 7.3               | A   | 7.3                        | A   | 7.4                       | A   | 0.2                                      | 0.009                           | --  | 0.2   |
|              |   |             | PM                     | 7.5               | A   | 8.1                        | A   | 8.3                       | A   | 0.3                                      | 0.010                           | --  | 0.3   |
| 46           | Lafayette St & El Camino Real *                       | Santa Clara | AM                     | 43.0              | D   | 56.8                       | E   | 57.2                      | E   | 1.7                                      | 0.008                           | --  | 1.7   |
|              |   |             | PM                     | 43.0              | D   | 45.2                       | D   | 46.0                      | D   | 1.5                                      | 0.019                           | --  | 1.5   |
| 47           | Lafayette St & Lewis St                               | Santa Clara | AM                     | 10.0              | B   | 11.2                       | B   | 11.4                      | B   | 0.0                                      | 0.000                           | --  | 0.0   |
|              |   |             | PM                     | 45.8              | D   | 66.3                       | E   | 76.9                      | E   | 12.4                                     | 0.032                           | --  | 12.4  |
|              |   |             | <i>With Mitigation</i> |                   |     |                            |     |                           |     |  |                                 |   |   |
| 48           | Lafayette St & Harrison St<br><i>Unsignalized (2)</i> | Santa Clara | AM                     | 69.9              | F   | OVER                       | F   | OVER                      | F   | --                                       | --                              | --  | N/A   |
|              |   |             | PM                     | 304.2             | F   | OVER                       | F   | OVER                      | F   | --                                       | --                              | --  | N/A   |
| 49           | Lafayette St & Benton St                              | Santa Clara | AM                     | 17.2              | B   | 20.2                       | C   | 20.2                      | C   | -0.1                                     | 0.020                           | --  | -0.1  |
|              |   |             | PM                     | 17.8              | B   | 18.1                       | B   | 18.2                      | B   | -4.3                                     | 0.024                           | --  | -4.3  |
| 50           | Lafayette St & Homestead Rd                           | Santa Clara | AM                     | 26.6              | C   | 24.6                       | C   | 31.2                      | C   | 9.8                                      | 0.039                           | --  | 9.8   |
|              |   |             | PM                     | 9.3               | A   | 8.9                        | A   | 8.6                       | A   | -0.1                                     | 0.010                           | --  | -0.1  |
| 51           | Lafayette St & Market St                              | Santa Clara | AM                     | 17.3              | B   | 22.7                       | C   | 24.5                      | C   | 2.1                                      | 0.033                           | --  | 2.1   |
|              |   |             | PM                     | 25.2              | C   | 36.6                       | D   | 37.6                      | D   | 0.7                                      | 0.024                           | --  | 0.7   |
| 52           | El Camino Real & Benton St                            | Santa Clara | AM                     | 12.6              | B   | 13.8                       | B   | 13.6                      | B   | -0.1                                     | 0.016                           | --  | -0.1  |
|              |   |             | PM                     | 15.4              | B   | 16.7                       | B   | 16.6                      | B   | -0.1                                     | 0.008                           | --  | -0.1  |
| 53           | El Camino Real & Railroad Ave                         | Santa Clara | AM                     | 10.5              | B   | 11.1                       | B   | 11.2                      | B   | 0.2                                      | 0.015                           | --  | 0.2   |
|              |   |             | PM                     | 12.4              | B   | 12.2                       | B   | 12.1                      | B   | -0.1                                     | 0.007                           | --  | -0.1  |
| 54           | El Camino Real & The Alameda *                        | Santa Clara | AM                     | 13.0              | B   | 18.7                       | B   | 18.8                      | B   | 0.4                                      | 0.011                           | --  | 0.4   |
|              |   |             | PM                     | 17.0              | B   | 20.8                       | C   | 20.8                      | C   | -0.1                                     | 0.004                           | --  | -0.1  |
| 55           | The Alameda & Newhall Dr                              | San Jose    | AM                     | 12.4              | B   | 14.7                       | B   | 14.7                      | B   | 3.3                                      | 0.070                           | -5%   | --  |
|              |   |             | PM                     | 12.6              | B   | 19.7                       | B   | 19.9                      | B   | 11.3                                     | 0.182                           | -3%   | --  |
| 56           | The Alameda & I-880 (South) *                         | San Jose    | AM                     | 20.5              | C   | 20.0                       | C   | 19.2                      | B   | -1.0                                     | -0.004                          | -9%   | --  |
|              |   |             | PM                     | 15.2              | B   | 26.1                       | C   | 25.4                      | C   | -1.0                                     | -0.015                          | -8%   | --  |
| 57           | The Alameda & I-880 (North) *                         | San Jose    | AM                     | 24.4              | C   | 40.7                       | D   | 41.1                      | D   | 0.8                                      | 0.006                           | -3%   | --  |
|              |   |             | PM                     | 21.1              | C   | 29.6                       | C   | 29.7                      | C   | 0.1                                      | 0.002                           | -7%   | --  |
| 58           | The Alameda & W. Hedding St *                         | San Jose    | AM                     | 39.2              | D   | 72.7                       | E   | 73.8                      | E   | 1.7                                      | 0.006                           | -1%   | --  |
|              |   |             | PM                     | 39.3              | D   | 93.4                       | F   | 93.6                      | F   | 0.5                                      | 0.001                           | -1%   | --  |
| 59           | The Alameda & W. Taylor St/Naglee Ave *               | San Jose    | AM                     | 42.7              | D   | 92.5                       | F   | 90.6                      | F   | -3.1                                     | -0.008                          | -2%   | --  |
|              |   |             | PM                     | 46.7              | D   | 70.0                       | E   | 72.3                      | E   | 3.2                                      | 0.012                           | +0%   | --  |
| 60           | Homestead Rd & Lincoln St/Winchester Blvd             | Santa Clara | AM                     | 21.5              | C   | 20.5                       | C   | 20.4                      | C   | -0.2                                     | 0.010                           | --  | -0.2  |
|              |   |             | PM                     | 21.6              | C   | 22.0                       | C   | 21.8                      | C   | -0.3                                     | 0.010                           | --  | -0.3  |
| 61           | Homestead Rd & Monroe St                              | Santa Clara | AM                     | 9.9               | A   | 10.5                       | B   | 10.6                      | B   | 0.0                                      | 0.002                           | --  | 0.0   |
|              |   |             | PM                     | 10.5              | B   | 11.1                       | B   | 11.1                      | B   | 0.0                                      | 0.001                           | --  | 0.0   |
| 62           | US 101 & Trimble                                      | San Jose    | AM                     | 22.8              | C   | 26.5                       | C   | 28.2                      | C   | 8.1                                      | 0.072                           | +5%   | --  |
|              |   |             | PM                     | 13.1              | B   | 15.6                       | B   | 15.8                      | B   | 4.7                                      | 0.104                           | +0%   | --  |

**Notes:**  
 \* Denotes a CMP intersection  
 (1) Increase in Critical Delay and Increase in Critical V/C are calculated as the difference between 2025 Background and 2035 Cumulative Plus Project for non-CMP San Jose intersections, and as the difference between 2035 Cumulative No Project and 2035 Cumulative Plus Project for Santa Clara and CMP intersections.  
 (2) The Project would cause an impact in San Jose under 2035 Cumulative Plus Project Conditions if the intersection would operate at an unacceptable LOS and the Project would contribute more than 25% of the total increase in traffic volume between 2025 Background and 2035 Cumulative Plus Project Conditions.  
 (3) The reported delay and corresponding level of service for signalized intersections represent the average delay for all approaches at the intersection. The reported delay and corresponding level of service for unsignalized (two-way stop-controlled) intersections are based on the stop-controlled approach with the highest delay.  
**Bold** indicates a substandard level of service (according to City of San Jose or City of Santa Clara standards).  
**Bold** with a box indicates a significant impact (according to City of San Jose, or City of Santa Clara Standards)



# **VTA's BART SILICON VALLEY— PHASE II EXTENSION PROJECT TRANSPORTATION IMPACT ANALYSIS OF THE BART EXTENSION AND VTA'S TRANSIT-ORIENTED JOINT DEVELOPMENT**

## **PREPARED FOR:**

Santa Clara Valley Transportation Authority  
U.S. Department of Transportation  
Federal Transit Administration



## **PREPARED BY:**

Hexagon Transportation Consultants, Inc.  
4 North Second Street, Suite 400  
San Jose, CA 95113

November 2016

Hexagon Transportation Consultants, Inc. 2016. VTA's BART Silicon Valley—  
Phase II Extension Project Transportation Impact Analysis of the BART  
Extension and VTA's Transit-Oriented Joint Development Only. November.  
San Jose, CA. Prepared for the Santa Clara Valley Transportation Authority,  
San Jose, CA, and the Federal Transit Administration, Washington, D.C.



## Table of Contents

---

|   |     |
|---|-----|
| <b>Executive Summary</b> .....  | iv  |
| Scope of Work .....   | v   |
| Project Trip Generation .....   | vi  |
| Project Impacts at Study Intersections .....  | vi  |
| Project Impacts on Study Freeway Segments .....   | x   |
| Other Transportation Topics .....   | x   |
| <b>1. Introduction</b> .....  | 1   |
| Project Description .....   | 1   |
| San Jose Downtown Strategy 2000 and Diridon Station Area Plan .....                                 | 9   |
| Scope of Study .....  | 10  |
| Study Time Periods .....  | 14  |
| Study Scenarios .....   | 14  |
| Methodology .....   | 15  |
| Report Organization .....   | 22  |
| <b>2. 2015 Existing Conditions</b> .....  | 23  |
| Existing Roadway Network .....  | 23  |
| Existing Pedestrian Facilities .....  | 25  |
| Existing Bicycle Facilities .....   | 26  |
| Existing Transit Services .....   | 30  |
| Existing Intersection Lane Configurations .....   | 33  |
| Existing Traffic Volumes .....  | 33  |
| Intersection Levels of Service under 2015 Existing Conditions .....                                 | 43  |
| Existing Freeway Segment Levels of Service .....  | 46  |
| Observed 2015 Existing Traffic Conditions .....   | 49  |
| <b>3. 2025 Background Conditions</b> .....  | 53  |
| 2025 Background Transportation Network .....  | 53  |
| 2025 Background Conditions Traffic Volumes at Study Intersections .....                             | 54  |
| Intersection Levels of Service under 2025 Background Conditions .....                               | 54  |
| Freeway Levels of Service under 2025 Background Conditions .....                                    | 62  |
| <b>4. 2015 and 2025 Project Conditions</b> .....  | 65  |
| Project Trip Estimates .....  | 65  |
| Significant Impact Criteria .....   | 69  |
| 2015 Existing Plus Project Conditions Intersection Levels of Service .....                          | 87  |
| Intersection Impacts under 2015 Existing Plus Project Conditions .....                              | 93  |
| 2025 Background Plus Project Conditions Intersection Levels of Service .....                        | 97  |
| Intersection Impacts and Proposed Mitigation Measures .....   | 102 |
| Freeway Segment Level of Service Analysis .....   | 107 |
| <b>5. Other Transportation Topics</b> .....   | 114 |
| Intersection Operations Analysis .....  | 114 |
| Freeway On-Ramp Meter Analysis .....  | 120 |
| Site Access .....   | 122 |
| Transit Services .....  | 125 |
| Pedestrian and Bicycle Facilities .....   | 125 |
| Unsignalized Intersection Analysis .....  | 127 |
| Bus Transit Vehicle Delay .....   | 128 |
| Vehicle Miles Traveled .....  | 131 |
| Parking Analysis .....  | 132 |
| <b>6. 2035 Cumulative Plus Project Conditions</b> .....   | 136 |
| Year 2035 Land Use and Transportation Network .....   | 136 |
| 2035 Cumulative Conditions Traffic Volumes .....  | 136 |
| Definitions of Significant Cumulative Impacts .....   | 146 |
| 2035 Cumulative Plus Project Intersection Level of Service Analysis .....                           | 147 |
| 2035 Cumulative Plus Project Conditions Intersection Impacts and Proposed Mitigation Measures ..... | 151 |
| 2035 Cumulative Conditions Freeway Segment Levels of Service .....                                  | 155 |

## Appendices

|             |   |
|-------------|---|
| Appendix A: | Study Intersections in the “BART Extension TIA” and the “BART Extension with TOJD TIA”  |
| Appendix B: | New Traffic Counts  |
| Appendix C: | City of San Jose Approved Trips Inventory and City of Santa Clara Approved Project List |
| Appendix D: | Volume Summary Tables   |
| Appendix E: | Intersection Level of Service Calculations  |
| Appendix F: | Signal Warrant Worksheets   |
| Appendix G: | VTA’s BART Silicon Valley – Phase II Extension Only Transportation Impact Analysis      |
| Appendix H: | Scope of Work Approved by City of San Jose  |

## List of Tables

|             |  |      |
|-------------|--|------|
| Table ES- 1 | Intersection Level of Service Summary – Alum Rock/28 <sup>th</sup> Street Station.....                                   | xiii |
| Table ES- 2 | Intersection Level of Service Summary – Santa Clara Station .....  | xiv  |
| Table 1     | ABAG Projections for Santa Clara County.....   | 16   |
| Table 2     | Signalized Intersection Level of Service Definitions Based on Control Delay .....  | 18   |
| Table 3     | Unsignalized Intersection Level of Service Definitions Based on Control Delay .....                                      | 20   |
| Table 4     | Freeway Segment Level of Service Definitions Based on Density .....  | 21   |
| Table 5     | Existing Weekday VTA Bus Service .....   | 30   |
| Table 6     | Existing Intersection Levels of Service – Alum Rock/28 <sup>th</sup> Street Station Area .....                           | 44   |
| Table 7     | Existing Intersection Levels of Service – Santa Clara Station Area .....   | 45   |
| Table 8     | Existing Freeway Levels of Service .....   | 47   |
| Table 9     | 2025 Background Conditions Intersection Levels of Service – Alum Rock/28 <sup>th</sup> Street Station .....              | 60   |
| Table 10    | 2025 Background Conditions Intersection Levels of Service – Santa Clara Station .....                                    | 61   |
| Table 11    | 2025 Background Conditions Freeway Levels of Service.....  | 63   |
| Table 12    | Trip Generation Estimates for Alum Rock/28 <sup>th</sup> Street and<br>Santa Clara Station Joint Development Sites ..... | 67   |
| Table 13    | Total Site-Generated Trips – Alum Rock/28 <sup>th</sup> Street and Santa Clara Stations .....                            | 68   |
| Table 14    | 2015 and 2025 Project Conditions Intersection Levels of Service –<br>Alum Rock/28 <sup>th</sup> Street Station .....     | 95   |
| Table 15    | 2015 and 2025 Project Conditions Intersection Levels of Service –Santa Clara Station .....                               | 96   |
| Table 16    | 2015 Existing Plus Project Conditions Freeway Segment Levels of Service .....  | 108  |
| Table 17    | 2025 Background Plus Project Conditions Freeway Segment Levels of Service.....   | 111  |
| Table 18    | Vehicle Queuing and Left-Turn Pocket Storage Analysis – AM Peak Hour .....   | 115  |
| Table 19    | Vehicle Queuing and Left-Turn Pocket Storage Analysis – PM Peak Hour .....   | 117  |
| Table 20    | Vehicle Queuing and Storage at Metered Freeway On-Ramps .....  | 122  |
| Table 21    | Vehicle Queuing and Left-Turn-Pocket Storage Analysis at the Future<br>N. 28 <sup>th</sup> Street Intersections.....     | 124  |
| Table 22    | Bus Delay at Corridor Study Intersections .....  | 129  |
| Table 23    | Average Daily VMT and VMT Per Capita for Santa Clara County-Based Trips .....  | 131  |
| Table 24    | Parking for Transit-Oriented Joint Development.....  | 133  |
| Table 25    | 2035 Cumulative Plus Project Conditions Intersection Level of Service – Alum Rock/28 <sup>th</sup> Street .              | 148  |
| Table 26    | 2035 Cumulative Plus Project Conditions Intersection Level of Service – Santa Clara Station .....                        | 149  |
| Table 27    | Freeway Segment Levels of Service under 2035 Cumulative Plus Project Conditions.....                                     | 156  |

## List of Figures

|          |  |    |
|----------|--|----|
| Figure 1 | Proposed VTA’s BART Silicon Valley - Phase II Extension Project Alignment and Stations .....                         | 2  |
| Figure 2 | Alum Rock/28 <sup>th</sup> Street Station and Transit-Oriented Joint Development.....                                | 5  |
| Figure 3 | Downtown and Diridon Stations and the Boundaries of the Downtown Core Area and<br>the Diridon Station Area Plan..... | 7  |
| Figure 4 | Santa Clara Station and Transit-Oriented Joint Development.....  | 8  |
| Figure 5 | Alum Rock/28 <sup>th</sup> Street BART Station Location and Study Intersections.....                                 | 12 |
| Figure 6 | Santa Clara BART Station Location and Study Intersections .....  | 13 |
| Figure 7 | Existing Bicycle Facilities – Alum Rock/28 <sup>th</sup> Street Station Area .....                                   | 28 |

|           |   |     |
|-----------|---|-----|
| Figure 8  | Existing Bicycle Facilities – Santa Clara Station Area .....  | 29  |
| Figure 9  | Existing Transit Services – Alum Rock/28 <sup>th</sup> Street Station Area.....                           | 31  |
| Figure 10 | Existing Transit Services – Santa Clara Station Area .....  | 32  |
| Figure 11 | Existing Lane Configurations – Alum Rock/28 <sup>th</sup> Street .....                                    | 35  |
| Figure 12 | Existing Lane Configurations – Santa Clara .....  | 37  |
| Figure 13 | Existing Traffic Volumes – Alum Rock/28 <sup>th</sup> Street .....  | 39  |
| Figure 14 | Existing Traffic Volumes – Santa Clara .....  | 41  |
| Figure 15 | 2025 Background Conditions Traffic Volumes – Alum Rock/28 <sup>th</sup> Street Station .....              | 55  |
| Figure 16 | 2025 Background Conditions Traffic Volumes – Santa Clara Station .....                                    | 57  |
| Figure 17 | TOJD Trips in 2015 – Alum Rock/28 <sup>th</sup> Street Station.....                                       | 70  |
| Figure 18 | TOJD Trips in 2015 – Santa Clara Station.....   | 72  |
| Figure 19 | Total BART and TOJD Trips in 2015 – Alum Rock/28 <sup>th</sup> Street Station .....                       | 74  |
| Figure 20 | Total BART and TOJD Trips in 2015 – Santa Clara Station .....   | 76  |
| Figure 21 | TOJD Trips in 2025 – Alum Rock/28 <sup>th</sup> Street Station.....                                       | 78  |
| Figure 22 | TOJD Trips in 2025 – Santa Clara Station.....   | 80  |
| Figure 23 | Total BART and TOJD Trips in 2025 – Alum Rock/28 <sup>th</sup> Street Station .....                       | 82  |
| Figure 24 | Total BART and TOJD Trips in 2025 – Santa Clara Station .....   | 84  |
| Figure 25 | 2015 Existing Plus Project Conditions Traffic Volumes – Alum Rock/28 <sup>th</sup> Street Station.....    | 88  |
| Figure 26 | 2015 Existing Plus Project Conditions Traffic Volumes – Santa Clara Station.....                          | 90  |
| Figure 27 | 2025 Background Plus Project Conditions Traffic Volumes – Alum Rock/28 <sup>th</sup> Street Station ..... | 98  |
| Figure 28 | 2025 Background Plus Project Conditions Traffic Volumes – Santa Clara Station .....                       | 100 |
| Figure 29 | Mitigation for Coleman Ave and I-880 Southbound Ramp .....  | 105 |
| Figure 30 | Mitigation for Coleman Avenue and Brokaw Road .....   | 106 |
| Figure 31 | Alum Rock/28 <sup>th</sup> Street Station Access .....  | 123 |
| Figure 32 | Transit Corridors Near TOJD Sites .....   | 130 |
| Figure 33 | 2035 Cumulative No Project Conditions Traffic Volumes – Alum Rock/28 <sup>th</sup> Street Station.....    | 138 |
| Figure 34 | 2035 Cumulative Plus Project Conditions Traffic Volumes – Alum Rock/28 <sup>th</sup> Street Station ..... | 140 |
| Figure 35 | 2035 Cumulative No Project Conditions Traffic Volumes – Santa Clara Station.....                          | 142 |
| Figure 36 | 2035 Cumulative Plus Project Conditions Traffic Volumes – Santa Clara Station .....                       | 144 |
| Figure 37 | Mitigation for Lafayette and Lewis Street.....  | 154 |

## Executive Summary

---

This report presents the results of the Transportation Impact Analysis (TIA) prepared for the proposed Santa Clara Valley Transportation Authority's (VTA's) BART Silicon Valley Phase II Extension and Transit-Oriented Joint Development Project (the "Project"), including four proposed BART Stations along the extension and VTA's Joint Development sites near those stations. The proposed Project is the second phase of the BART Silicon Valley Program and includes an approximately 6-mile extension of the BART system beginning at the terminus of the Phase I Project, south of Mabury Road and east of US 101 in San Jose. The Phase II Project would descend into an approximately 5-mile-long subway tunnel, continue through downtown San Jose, and terminate at grade in the City of Santa Clara near the Caltrain Station.

The Project includes the following four new BART stations and Transit-Oriented Joint Development sites along the Silicon Valley Rapid Transit Corridor (SVRTC):

- Alum Rock/28<sup>th</sup> Street Station, which is in the City of San Jose and outside the City's Downtown Core Area;
- Downtown San Jose Station, which is within the City of San Jose's Downtown Core Area;
- Diridon Station, which is within the City of San Jose's Downtown Core Area and the Diridon Station Area Plan (DSAP) boundaries; and
- Santa Clara Station, which is in the City of Santa Clara.

The Transit-Oriented Joint Development<sup>1</sup> portion of the Project would include a combination of office space, retail space, and residential units at the Alum Rock/28th Street and Santa Clara BART Stations, and a mix of office and retail space at the Downtown and Diridon BART Stations. The Project also proposes small supporting retail developments at two locations along the alignment in San Jose where ventilation structures for the BART tunnel would be located.

This TIA includes an analysis of the 6-mile extension of BART from Berryessa Station to Santa Clara and VTA's Transit-Oriented Joint Development (TOJD), which is also called the CEQA Project Alternative. A separate TIA which does not include the TOJD portion of the Project and analyzes only the BART extension was finalized in November 2016 and is called the "Transportation Impact Analysis of the BART Extension Only." Therefore, for purposes of this BART Extension with TOJD TIA, the word "Project" refers to the CEQA Project Alternative. In the Supplemental Environmental Impact Statement/Subsequent Environmental Impact Report (SEIS/SEIR) that includes the results of both TIAs, it is called the "BART Extension with TOJD Alternative."

---

<sup>1</sup>. The terms "Transit-Oriented Joint Development", "TOJD", and "Joint Development" are used interchangeably throughout this TIA.

## Scope of Work

A Transportation Impact Analysis of the Phase II Extension Project *without* VTA's proposed Transit-Oriented Joint Development has also been prepared by Hexagon Transportation Consultants and is referred to herein as the "BART Extension Only TIA" or the "BART Extension TIA." That TIA estimated the number of station access trips to and from the four Phase II BART stations (based on their Park-and-Ride and Kiss-and-Ride facilities) and the projected change in background traffic as BART users switch from passenger vehicles to BART. This "BART Extension with TOJD TIA" incorporates the results of that earlier analysis by adding the trips related to the Transit-Oriented Joint Development portion of the Project to the traffic volumes projected in the "BART Extension TIA."

Both the Downtown San Jose Station and the Diridon Station are located within the Downtown Core Area as defined by the San Jose Downtown Strategy 2000 Environmental Impact Report (EIR), and the office and retail uses proposed for the Transit-Oriented Joint Development at these stations are fully consistent with that EIR. Therefore, based on guidance from City of San Jose staff, it is not necessary to include the Downtown and Diridon Stations in this TIA. Also, based on guidance from San Jose staff and VTA's *TIA Guidelines*, the small retail uses at two ventilation stations near the Downtown Station fall below the trip generation threshold for which a TIA is required. This TIA therefore covers only the Alum Rock/28<sup>th</sup> Street and Santa Clara Stations.

More detailed project descriptions of these two sites are as follows:

**Alum Rock/28<sup>th</sup> Street Station** would be bounded by McKee Road on the north, Santa Clara Street on the south, US 101 on the east, and North 28<sup>th</sup> Street on the west. The station campus would include an underground station with street-level entrance portals with elevators, escalators and stairs. The station would include system facilities both above and below ground. A 1,200-space parking structure with up to seven levels for park-and-ride (PNR) BART commuters would also be constructed. Kiss-and-ride (KNR) facilities would be provided along North 28<sup>th</sup> Street and/or on the station campus. Additionally, bus and shuttle drop-off areas would be provided along North 28<sup>th</sup> Street.

The Transit-Oriented Joint Development component of Alum Rock/28<sup>th</sup> Street Station includes replacing industrial uses currently operating on the site with up to 500,000 square feet (s.f.) of office space, 275 apartment units, and 20,000 s.f. of retail space. Surface and garage parking for the office, residential, and retail uses would be provided on site and would include 2,150 parking spaces or the number of spaces in accordance with City standards at the time that site planning is finalized.

**Santa Clara Station** would be located at grade just northeast of the Caltrain tracks and the Santa Clara Caltrain Station (between Coleman Avenue and El Camino Real), at the western end of Brokaw Road. The station would be at grade with a mezzanine one level below. Access to the mezzanine would be provided via elevators, escalators, and stairs covered by canopy structures. Kiss-and-ride facilities and bus/shuttle loading areas would be provided along Brokaw Road, which would be widened. An approximately 240-foot-long pedestrian tunnel would connect from the Santa Clara BART Station to the Santa Clara Caltrain Station plaza, and an approximately 175-foot-long pedestrian tunnel would connect from the BART station to a new BART plaza on Brokaw Road.

The PNR demand at the Santa Clara Station would be accommodated in an approximately 500-space parking structure located north of Brokaw Road and east of the Caltrain tracks. Vehicular access to the parking structure would be provided from Brokaw Road and Coleman Avenue.

The Transit-Oriented Joint Development component of the Santa Clara Station includes replacing industrial uses currently operating on the site with a maximum of 500,000 s.f. of office space, 220 dwelling units, and 30,000 s.f. of retail space. One level of underground parking along with surface and garage parking for the office, residential, and retail uses would be provided on site and would include 2,200 parking spaces or the number of spaces in accordance with City standards at the time that site planning is finalized.

The potential impacts related to the proposed Project were evaluated following the standards and methodologies set forth by the City of San Jose, the City of Santa Clara, VTA, and the California Environmental Quality Act (CEQA). The VTA administers the County Congestion Management Program (CMP). The study includes an

analysis of AM and PM peak-hour traffic conditions for a total of 62 intersections (27 near the Alum Rock/28<sup>th</sup> Street Station and 35 near the Santa Clara Station) and 64 directional freeway segments. All of the 27 study intersections near the Alum Rock/28<sup>th</sup> Street Station are located in the City of San Jose. Of the 35 study intersections in the vicinity of the Santa Clara Station, 22 are located in the City of Santa Clara and 13 are located in the City of San Jose. A total of 22 of the study intersections have been designated as CMP intersections: 7 near the Alum Rock/28<sup>th</sup> Street Station and 15 near the Santa Clara Station.

## Project Trip Generation

Daily and peak-hour trip generation for the proposed Transit-Oriented Joint Development land uses at the Alum Rock/28<sup>th</sup> Street and Santa Clara Stations were based on trip rates published in the ITE *Trip Generation Manual, 9<sup>th</sup> Edition*, for office buildings, retail space, and apartments/condominiums. In accordance with VTA's *TIA Guidelines*, appropriate trip reductions were taken for (1) proximity to a transit station, (2) internalization of trips within mixed-use developments, and (3) pass-by trips for retail uses. The TOJD portion of the Project was estimated to generate 768 AM peak hour trips and 771 PM peak hour trips at the Alum Rock/28<sup>th</sup> Street Station and 755 AM peak hour trips and 763 PM peak hour trips at the Santa Clara Station.

These Transit-Oriented Joint Development trips were combined with:

- Trips going to and from the stations for their PNR and KNR facilities (this is a positive number, representing additional trips at a given intersection), and
- Trips that would be removed from the roadway network due to the mode shift from passenger vehicles to BART (this is a negative number, representing fewer trips at a given intersection).

At some intersections, particularly for those movements leading directly to the station campuses, the number of vehicles accessing the station (to ride BART or for one of the Joint Development uses) is larger than the number of vehicles shifted from the roadway network to transit modes, and the Project results in a net increase in traffic volumes. At other intersections, particularly for those movements either not leading to the station campuses or leading to freeways, the number of vehicles shifted from the roadway network to transit modes is greater than the number of vehicles using that movement to access the station, and the Project results in a net decrease in traffic volumes.

VTA and the Cities will work to maximize multimodal access to the BART stations and the Transit-Oriented Joint Development land uses. Through various efforts such as Access Plans for the station areas, Transportation Demand Management (TDM) Plans for the Joint Development, improving the bike and pedestrian facilities in the vicinity of the stations, adding bikesharing at the station campuses, and offering “unbundled” parking for the residential uses, the number of vehicle trips generated by the Project would be reduced. Therefore, the estimates of vehicle trips for the Project in this TIA should be regarded as conservative

## Project Impacts at Study Intersections

The intersection level of service analysis is summarized in Table ES-1 for the Alum Rock/28<sup>th</sup> Street Station and Table ES-2 for the Santa Clara Station. Both in the tables and in the discussion below, CMP intersections are marked with an asterisk (\*).

### Project Impacts under 2025 Background Plus Project Conditions

The results of the intersection level of service analysis indicate that the addition of Project traffic would result in significant impacts to the following three study intersections under 2025 Background Plus Project Conditions, according to applicable level of service standards and criteria for significant impacts:



**Coleman Avenue and Brokaw Road (#33)**

**Impact:** This intersection located in Santa Clara near the Santa Clara Station is expected to operate at an acceptable level of service (LOS D) during the PM peak hour under 2025 Background Conditions, but at an unacceptable level of service (LOS F) under 2025 Background Plus Project Conditions. This constitutes a significant impact to the intersection under the City of Santa Clara definition.

**Mitigation:** Change the signal control for Brokaw Road (the east and west legs of this intersection) from Protected Left-Turn phasing to Split Phase. Add a shared through/left-turn lane to the east and west approaches within the existing right-of-way. Change the existing shared through/right-turn lanes to right-turn only lanes on the east and west approaches, and change the eastbound right-turn coding from Include to Overlap, indicating that many eastbound right turns would be able to turn “right on red.” With implementation of this mitigation measure, or a comparable mitigation measure as determined upon coordination with the City of Santa Clara, the intersection would operate at LOS D under 2025 Background Plus Project Mitigated Conditions; therefore, the impact would be mitigated to a *less-than-significant level*.

**Coleman Avenue and I-880 Southbound Ramps (#36) \***

**Impact:** This CMP intersection located in San Jose near the Santa Clara Station is expected to operate at an unacceptable level of service (LOS F) during the AM peak hour under 2025 Background Conditions. The proposed Project would cause the intersection’s average critical delay to increase by more than 4 seconds and the critical volume-to-capacity ratio (V/C) to increase by more than 0.01 during the AM peak hour under 2025 Background Plus Project Conditions. This constitutes a significant impact to the intersection under both the City of San Jose and the CMP definitions.

**Mitigation:** Convert the second (center) left-turn lane on the I-880 off-ramp (the intersection’s westbound approach) to a shared left/right-turn lane. Replace the lane control signs and revise the pavement markings on the off-ramp to reflect the new lane usage. With implementation of this mitigation measure, the intersection would operate at LOS D under 2025 Background Plus Project Mitigated Conditions, and the impact would be mitigated to a *less-than-significant level*.

**Coleman Avenue and I-880 Northbound Ramps (#37) \***

**Impact:** This CMP intersection located in San Jose near the Santa Clara Station is expected to operate at an unacceptable level of service (LOS F) during the AM peak hour under 2025 Background Conditions. The proposed Project would cause the intersection’s average critical delay to increase by more than 4 seconds and the critical volume-to-capacity ratio (V/C) to increase by more than 0.01 during the AM peak hour under 2025 Background Plus Project Conditions. This constitutes a significant impact to the intersection under both the City of San Jose and the CMP definitions.

**Mitigation:** Currently, only right turns are permitted from McKendrie Street, which is the eastbound approach to this intersection. With the proposed mitigation, that right turn movement would still be permitted, but the signal controls would be modified so that all motorists would turn “right on red” and the pedestrian crosswalk across McKendrie would function in the same way that a crosswalk at a stop sign functions.

Convert the signal control for the eastbound approach (McKendrie Street) from a 3-section signal head to a single-section constant red beacon. Remove the pedestrian signals and push buttons on the eastbound leg (McKendrie Street). Reprogram the signal controller to eliminate the eastbound vehicle movement and existing pedestrian crossing.

Due to concerns expressed by City of San Jose staff, the proposed mitigation measure would cause additional impacts to other users of the roadway; therefore this mitigation measure will not be implemented, and VTA will work with the City of San Jose to provide other multi-modal access improvements in the area. The impact would remain *significant and unavoidable*.

State Congestion Management law requires a local jurisdiction to prepare a deficiency plan (now referred to as 'Multimodal Improvement Plan' in the Santa Clara County CMP maintained by VTA) when roadway level of service standards are not maintained on the designated CMP system [California Government Code Section 65098.4]. VTA maintains guidelines for the development of Multimodal Improvement Plans which were developed in consultation with Member Agencies (i.e., the 15 cities of Santa Clara County and the County of Santa Clara) and last adopted by the VTA Board in September 2010. According to these guidelines, Multimodal Improvement Plans are prepared by Member Agencies in response to the transportation impacts of land use plans and development projects. The impact to this intersection is a result of the TOJD component of the Project and not due to the BART extension; however, VTA's guidelines do not address a situation where a land use project that is led by VTA contributes to an impact on a CMP facility. With this in mind, VTA commits to work with the City of San Jose and Caltrans in the preparation of a Multimodal Improvement Plan for identified Project impacts to CMP intersections.

### **Project Impacts under 2035 Cumulative Plus Project Conditions**

The results of the intersection level of service analysis indicate that the addition of Project traffic would result in significant impacts to the following four study intersections under 2035 Cumulative Plus Project Conditions, according to applicable level of service standards and criteria for significant impacts. The mitigation measures for intersections #33 and #36 are the same as proposed above under Background Plus Project Conditions.

#### **De La Cruz Boulevard and Central Expressway (#30) \***

**Impact:** This CMP intersection located in Santa Clara near the Santa Clara Station is expected to operate at an unacceptable level of service (LOS F) during the PM peak hour under 2035 Cumulative No Project Conditions. The proposed Project would cause the intersection's average critical delay to increase by more than 4 seconds and the critical volume-to-capacity ratio (V/C) to increase by more than 0.01 during the PM peak hour under 2035 Cumulative Plus Project Conditions. This constitutes a significant impact to the intersection under both the City of Santa Clara and the CMP definitions.

**Mitigation:** The Santa Clara County Department of Roads and Airports plans to convert the existing eastbound High Occupancy Vehicle (HOV) lane to a mixed-use lane at this intersection. This modification was included as a change to the roadway network under both the 2025 Background Plus Project Conditions and 2035 Cumulative Plus Project Conditions. No other feasible mitigation measures have been identified for this intersection. Therefore, the impact at this intersection would be *significant and unavoidable*.

State Congestion Management law requires a local jurisdiction to prepare a deficiency plan (now referred to as 'Multimodal Improvement Plan' in the Santa Clara County CMP maintained by VTA) when roadway level of service standards are not maintained on the designated CMP system [California Government Code Section 65098.4]. VTA maintains guidelines for the development of Multimodal Improvement Plans which were developed in consultation with Member Agencies (i.e., the 15 cities of Santa Clara County and the County of Santa Clara) and last adopted by the VTA Board in September 2010. According to these guidelines, Multimodal Improvement Plans are prepared by Member Agencies in response to the transportation impacts of land use plans and development projects. The impact to this intersection is a result of the TOJD component of the Project and not due to the BART extension; however, VTA's guidelines do not address a situation where a land use project that is led by VTA contributes to an impact on a CMP facility. With this in mind, VTA commits to work with the City of Santa Clara and the County of Santa Clara in the preparation of a Multimodal Improvement Plan for identified Project impacts to CMP intersections.

#### **Coleman Avenue and Brokaw Road (#33)**

**Impact:** This intersection located in Santa Clara near the Santa Clara Station is expected to operate at an acceptable level of service (LOS D) during the PM peak hour under 2035 Cumulative No Project Conditions, but at an unacceptable level of service (LOS F) under 2035 Cumulative Plus Project



Conditions. This constitutes a significant impact to the intersection under the City of Santa Clara definition.

**Mitigation:** Change the signal control for Brokaw Road (the east and west legs of this intersection) from Protected Left-Turn phasing to Split Phase. Add a shared through/left-turn lane to the east and west approaches within the existing right-of-way. Change the existing shared through/right-turn lanes to right-turn only lanes on the east and west approaches, and change the eastbound right-turn coding from Include to Overlap, indicating that many eastbound right turns would be able to turn “right on red.” With implementation of this mitigation measure, or a comparable mitigation measure as determined upon coordination with the City of Santa Clara, the intersection would operate at LOS D under 2035 Cumulative Plus Project Mitigated Conditions; therefore, the impact would be mitigated to a *less-than-significant level*.

#### **Coleman Avenue and I-880 Southbound Ramps (#36) \***

**Impact:** This CMP intersection located in San Jose near the Santa Clara Station is expected to operate at an unacceptable level of service (LOS F) during the AM peak hour under 2035 Cumulative No Project Conditions. The proposed Project would cause the intersection’s average critical delay to increase by more than 4 seconds and the critical volume-to-capacity ratio (V/C) to increase by more than 0.01 during the AM peak hour under 2035 Cumulative Plus Project Conditions. This constitutes a significant impact to the intersection under the CMP definition. (There would not be a significant impact under the City of San Jose definition because the Project would contribute less than 25% of the total increase in traffic between 2025 Background and 2035 Cumulative Plus Project Conditions.)

**Mitigation:** Convert the second (center) left-turn lane on the I-880 off-ramp (the intersection’s westbound approach) to a shared left/right-turn lane. Replace the lane control signs and revise the pavement markings on the off-ramp to reflect the new lane usage. With implementation of this mitigation measure, the intersection would operate at LOS E under 2035 Cumulative Plus Project Mitigated Conditions, and the impact would be mitigated to a *less-than-significant level*.

#### **Lafayette Street and Lewis Street (#47)**

**Impact:** This intersection located in Santa Clara near the Santa Clara Station is expected to operate at an unacceptable level of service (LOS E) during the PM peak hour under 2035 Cumulative No Project Conditions. The proposed Project would cause the intersection’s average critical delay to increase by more than 4 seconds and the critical volume-to-capacity ratio (V/C) to increase by more than 0.01 during the PM peak hour under 2035 Cumulative Plus Project Conditions. This constitutes a significant impact to the intersection under the City of Santa Clara definition.

**Mitigation:** Shift the westbound approach lanes on Lewis Street to the south to allow for the current through/right-turn lane to operate as a separate right-turn lane and a separate through lane. A shift of approximately two feet would increase the current through/right-turn lane width to 20 feet, which would allow adequate room for right-turning vehicles to proceed past vehicles traveling straight through the intersection and make the right turn onto northbound Lafayette Street. The westbound approach and receiving lanes would be slightly offset as a result, which can be addressed with dashed pavement markings across the intersection. With implementation of this mitigation measure, or a comparable mitigation measure as determined upon coordination with the City of Santa Clara, the control delay at this intersection would be 9.5 seconds less than under 2035 Cumulative No Project Conditions. Thus, even though the intersection would continue to operate at an unacceptable LOS E under 2035 Cumulative Plus Project Mitigated Conditions, the impact would be mitigated to a *less-than-significant level*.

## Project Impacts on Study Freeway Segments

The results of the freeway segment analysis shows that, under 2025 Background Plus Project Conditions and under 2035 Cumulative Plus Project Conditions, the Project would not cause significant increases in traffic volumes (one percent or more of freeway capacity) on any of the study freeway segments currently operating at LOS F, and none of the study freeway segments currently operating at LOS E or better would worsen to LOS F as a result of the Project.

In fact, many freeway segments would experience a decrease in volume, because the reduced number of trips on the freeway (due to the mode shift from passenger vehicles to BART) more than offsets the station access trips (drivers heading to or from a station to use the PNR or KNR facilities) and the trips that would be generated by the Transit-Oriented Joint Development component of the Project. Therefore, based on CMP freeway impact criteria, none of the study freeway segments would be significantly impacted by the project under 2025 Background Plus Project Conditions or 2035 Cumulative Plus Project Conditions.

## Other Transportation Topics

### Intersection Operational Issues – Analysis of Left-Turn Queues

The analysis of intersection level of service was supplemented with an analysis of traffic operations for intersections where the Project would add left turns. Existing vehicle storage for projected 95<sup>th</sup> percentile left-turn queues under Existing Plus Project and/or Background Plus Project Conditions were found to be inadequate at the following intersections:

**North 28<sup>th</sup> Street and Julian Street:** Westbound left-turn queues (from Julian onto North 28<sup>th</sup> Street) would exceed the left-turn pocket capacity in the AM and PM peak hours under Existing Plus Project and Background Plus Project Conditions. The current configuration of this intersection is inefficient and problematic, partly due to the close proximity of the US 101 southbound off-ramp intersection. The North 28<sup>th</sup> Street and Julian Street intersection would require improvements to operate more efficiently with the addition of Project-generated traffic.

**North 28<sup>th</sup> Street and Santa Clara Street:** The maximum vehicle queues for the eastbound left-turn pocket (from Santa Clara Street onto North 28<sup>th</sup> Street) would exceed the existing vehicle storage capacity during the AM peak hour under 2015 Existing Plus Project and 2025 Background Plus Project Conditions. Extending the eastbound left-turn pocket is not feasible due to limited spacing between North 27<sup>th</sup> Street and North 28<sup>th</sup> Street. Adding a second eastbound left-turn pocket is not feasible without acquiring additional right-of-way. Therefore, there are no feasible improvements that could be implemented to increase the eastbound left-turn pocket vehicle storage.

**US 101 Northbound Ramps and McKee Road:** The queuing analysis indicates that the maximum vehicle queue for the northbound left-turn pocket (northbound off-ramp) at this intersection currently exceeds the existing vehicle storage capacity during the AM peak hour of traffic, and that this condition would continue to occur under 2015 Existing Plus Project, 2025 Background, and 2025 Background Plus Project Conditions. Converting the middle shared through/right-turn lane to a shared L-T-R lane would help provide additional vehicle storage to accommodate the estimated future left-turn volumes.

**Coleman Avenue and Brokaw Road:** The maximum vehicle queues for the eastbound left-turn pocket at this intersection would exceed the existing vehicle storage capacity during the PM peak hour under 2015 Existing Plus Project and 2025 Background Plus Project Conditions. This intersection was also evaluated under the Level of Service analysis, which indicated a significant impact would occur. The proposed mitigation includes adding a shared eastbound left-turn/through lane. With this improvement, the eastbound left-turn lane and shared left-turn/through lane together would provide adequate storage to accommodate the maximum vehicle queues that would occur under 2015 Existing Plus Project and 2025 Background Plus Project scenarios.

**Coleman Avenue and I-880 Northbound Ramp:** The maximum vehicle queues for the southbound dual left-turn pockets (left turns onto the northbound on-ramp) would exceed the existing vehicle storage capacity during the PM peak hour under 2025 Background and 2025 Background Plus Project Conditions. A maximum vehicle queue length of 625 feet per lane is estimated to occur during the PM peak hour under 2025 Background

Conditions, and a maximum vehicle queue length of 650 feet per lane is estimated to occur during the PM peak hour under 2025 Background Plus Project Conditions (one additional vehicle). Extending the southbound left-turn pocket is not feasible because the I-880 overpass is not sufficiently wide to accommodate this improvement (roadway narrows at this point). The existing bike lanes would need to be removed in order to extend this left-turn pocket, which is not consistent with VTA's policies to promote bicycling opportunities.

### Freeway On-Ramp Analysis

Three freeway on-ramps where the Project would add a substantial amount of traffic (more than 10 net peak hour trips per lane) were evaluated; each of these ramps is currently metered or is expected to be metered in the future. Potential queuing issues were identified at the following two on-ramps:

- US 101 southbound on-ramp from McKee Road – PM peak hour
- US 101 southbound loop on-ramp from WB Santa Clara Street/Alum Rock Avenue – PM peak hour

Because the metering lights are not currently operating at these on-ramps, there are no existing vehicle queues on these on-ramps. Therefore, future vehicle queuing estimates could not be calculated for these on-ramps, since there are no existing data available to calibrate the results. It can be assumed, however, that both US 101 southbound on-ramps would experience vehicle queuing issues in the future due to the high volume of traffic using these on-ramps. These on-ramps most likely would not provide adequate vehicle storage to accommodate the future vehicle queues that would occur. As a result, the vehicle queues would back up onto the roadways serving the on-ramps (e.g., McKee Road and Santa Clara Street/Alum Rock Avenue), which likely would result in significant operational issues.

### Site Access

A site access evaluation for the Alum Rock/28<sup>th</sup> Street Station was based on the current station plans. Project-generated traffic would access the site via 5 Wounds Lane and E. St. James Street, both of which would become signalized intersections. An estimate of traffic volumes using the two intersections was conducted, and a level of service evaluation showed the 5 Wounds Lane intersection would operate at LOS B in the AM and PM peak hours and the E. St. James Street intersection would operate at LOS C in the AM and PM peak hours under Background Plus Project Conditions. Left-turn vehicle queuing analysis was also conducted to estimate the recommended length of left-turn storage pockets at these intersections.

Site access at the Santa Clara Station would be provided via the intersection of Coleman Avenue and Brokaw Road, which was discussed in the section on intersection impacts and proposed mitigation measures and the section on vehicle queuing analysis.

### Transit, Bicycle, and Pedestrian Analysis

The Project is a transit project and represents a substantial improvement to the transit system in the study area. The Project is consistent with the goals and policies of the San Jose and Santa Clara General Plans, with regard to encouraging transit-oriented development and promoting greater usage of alternative modes.

An analysis was conducted of the potential for increased congestion due to Project traffic to cause delays in corridors where VTA buses operate. It was concluded that the additional Project traffic would have very little impact on transit travel times.

With the proposed Project, a pedestrian connection along the south side of the Alum Rock/28<sup>th</sup> Street Station area at N. 28<sup>th</sup> Street from E. Santa Clara Street would be provided. This pedestrian connection would link the station entrances with buses and Bus Rapid Transit (BRT) operating on E. Santa Clara Street/Alum Rock Avenue, enhancing connectivity of pedestrian facilities surrounding the station. The Project would add sidewalks along both sides of N. 28<sup>th</sup> Street and around the perimeter of the project site. The Project would also provide crosswalks at the signalized intersections of N. 28<sup>th</sup> Street /E. St James Street and N. 28<sup>th</sup> Street/5 Wounds Lane, including pedestrian push buttons and signal heads.

The Project would add sidewalks around the perimeter of the Santa Clara Station site and bicycle facilities along both sides of Brokaw Road. An approximately 240-foot-long pedestrian tunnel will be constructed between the future Santa Clara BART Station and the existing Santa Clara Caltrain Station plaza as a separate project. The Project will construct an approximately 175-foot-long pedestrian tunnel from the Santa Clara BART Station to a new BART plaza on Brokaw Road. This pedestrian connection would link the BART station with other pedestrian and transit facilities in the vicinity, enhancing connectivity of pedestrian facilities surrounding the station and transit services.

Thus, the Project would enhance pedestrian and bicycle facilities in the vicinity of both the Alum Rock/28<sup>th</sup> Street and Santa Clara Stations.

## Vehicle Miles Traveled

Vehicle Miles Traveled (VMT) is a metric that is used in noise, air quality, and greenhouse gas emissions analyses because it provides an indication of the usage level of the automobile and truck transportation network. VMT has also been proposed as a replacement metric for Level of Service by the Governor's Office of Planning and Research in its *Draft of Updates to the CEQA Guidelines*, prepared pursuant to Senate Bill 743. Further revisions to the *Draft of Updates* are expected, as a result of significant public input, and OPR has not yet adopted new CEQA Guidelines. However, it is anticipated that VMT and/or VMT Per Capita will become a basis for findings of significant impact under CEQA in the future.

Average daily Vehicle Miles Traveled (VMT) and Vehicle Miles Traveled Per Capita were analyzed under No Project and Plus Project conditions under the 2015 Existing, 2025 Background, and 2035 Cumulative scenarios. Average Daily VMT and VMT per Capita were projected to decrease under Plus Project conditions in all three forecast years. This result reflects the fact that many travelers who would be making trips in automobiles under No Project conditions would shift to BART under Plus Project conditions, reducing the number of vehicles on the road and the resulting number of vehicle miles traveled. The projected mode shift to BART stems both from the substantial expansion of the transit network that the Phase II BART extension represents and from the transit-oriented nature of the proposed Joint Development near the stations. The Project as a whole exemplifies the type of land use and transportation investments that are envisioned by state, regional and local agencies in an effort to promote more sustainable communities.

## Parking Analysis

Parking for kiss-and-ride BART patrons is addressed in the "BART Extension TIA." Parking for the TOJD portion of the Project is addressed in this TIA, based on the parking requirements of the appropriate city for the Alum Rock/28<sup>th</sup> Street Station and the Santa Clara Station.

At the Alum Rock/28<sup>th</sup> Street Station, a total of 2,135 parking spaces would be required by the City of San Jose for the amount of office, retail, and residential uses proposed, after taking reductions for shared parking and for the level of transit usage by office employees predicted by the travel demand forecasting model. This number is based on an assumption that half of the apartment units would be studio/1-bedroom units and half would be 2-bedroom units; the required number of spaces would change if the mix of apartments is different from this assumption. The Project would provide 2,150 parking spaces for all of the TOJD uses, which exceeds the City's requirement.

At the Santa Clara Station, a total of 2,195 parking spaces would be required by the City of Santa Clara for the amount of office, retail, and residential uses proposed, and based on an assumption of 10 studio apartments, 100 1-bedroom apartments, and 110 2-bedroom apartments. The required number of spaces is subject to change if the mix of apartments is different from this assumption. The Project would provide 2,200 spaces, which exceeds the City's requirements, even without taking any reductions for shared parking or greater transit usage.

**Table ES- 1  
Intersection Level of Service Summary – Alum Rock/28th Street Station**

| Study Number | Intersection                                 | Peak Hour | 2015 Existing     |     | 2015 Existing Plus Project |     | 2025 Background   |     | 2025 Background Plus Project |     |                             |                    | 2035 Cumulative No Project |          | 2035 Cumulative Plus Project |          |                             |                                 | SJ Impact <sup>1</sup><br>% Cumulative Trips from Project | CMP Impact<br>Cumulative Incr. in Crit. Delay (sec) |
|--------------|--|-----------|-------------------|-----|----------------------------|-----|-------------------|-----|------------------------------|-----|-----------------------------|--------------------|----------------------------|----------|------------------------------|----------|-----------------------------|---------------------------------|---|---|
|              |  |           | Avg. Delay (sec.) | LOS | Avg. Delay (sec.)          | LOS | Avg. Delay (sec.) | LOS | Avg. Delay (sec.)            | LOS | Incr. In Crit. Delay (sec.) | Incr. In Crit. V/C | Avg. Delay (sec.)          | LOS      | Avg. Delay (sec.)            | LOS      | Incr. In Crit. Delay (sec.) | Incr. In Crit. V/C <sup>2</sup> |   |   |
| 1            | 21st St & E. Julian St                       | AM        | 23.2              | C   | 23.7                       | C   | 23.8              | C   | 24.0                         | C   | 1.3                         | 0.005              | 25.6                       | C        | 23.7                         | C        | 1.2                         | 0.007                           | +64%  |   |
|              |  | PM        | 12.7              | B   | 13.0                       | B   | 12.7              | B   | 13.0                         | B   | 0.7                         | 0.039              | 13.4                       | B        | 14.0                         | B        | 2.3                         | 0.108                           | +36%  |   |
| 2            | 24th St & E. Julian St                       | AM        | 17.2              | B   | 16.7                       | B   | 17.5              | B   | 16.5                         | B   | -1.5                        | 0.053              | 29.2                       | C        | 30.3                         | C        | 15.8                        | 0.322                           | +12%  |   |
|              |  | PM        | 17.1              | B   | 17.3                       | B   | 17.4              | B   | 17.2                         | B   | 0.8                         | 0.011              | 17.7                       | B        | 17.6                         | B        | 2.4                         | 0.042                           | +36%  |   |
| 3            | N. 28th St & E. Julian St                    | AM        | 27.2              | C   | 28.7                       | C   | 27.2              | C   | 29.7                         | C   | 24.8                        | 0.140              | 27.9                       | C        | 33.9                         | C        | 27.5                        | 0.328                           | +57%  |   |
|              |  | PM        | 14.2              | B   | 27.8                       | C   | 14.2              | B   | 27.8                         | C   | 16.7                        | 0.174              | 16.2                       | B        | 29.7                         | C        | 19.2                        | 0.224                           | +71%  |   |
| 4            | US 101 SB ramps & E. Julian St               | AM        | 23.1              | C   | 27.2                       | C   | 26.9              | C   | 35.2                         | D   | 13.3                        | 0.105              | 32.2                       | C        | 50.1                         | D        | 39.8                        | 0.229                           | +50%  |   |
|              |  | PM        | 28.8              | C   | 30.9                       | C   | 30.8              | C   | 35.7                         | D   | 5.6                         | 0.070              | 30.0                       | C        | 37.1                         | D        | 13.4                        | 0.117                           | +44%  |   |
| 5            | US 101 NB ramps & McKee Rd                   | AM        | 22.1              | C   | 25.8                       | C   | 23.0              | C   | 24.2                         | C   | 2.7                         | 0.052              | 22.7                       | C        | 24.9                         | C        | 4.0                         | 0.168                           | +10%  |   |
|              |  | PM        | 26.9              | C   | 28.3                       | C   | 28.6              | C   | 29.7                         | C   | 2.2                         | 0.028              | 30.9                       | C        | 31.1                         | C        | 2.6                         | 0.051                           | +9%   |   |
| 6            | 33rd St & McKee Rd                           | AM        | 35.4              | D   | 35.7                       | D   | 34.0              | C   | 34.6                         | C   | 0.6                         | 0.016              | 47.6                       | D        | 50.0                         | D        | 20.4                        | 0.229                           | -3%   |   |
|              |  | PM        | 29.7              | C   | 29.5                       | C   | 28.7              | C   | 29.0                         | C   | 0.4                         | -0.005             | 42.1                       | D        | 42.3                         | D        | 15.4                        | 0.225                           | +2%   |   |
| 7            | King Rd & McKee Rd                           | AM        | 46.8              | D   | 47.5                       | D   | 52.6              | D   | 52.3                         | D   | -0.6                        | -0.007             | <b>91.3</b>                | <b>F</b> | <b>89.1</b>                  | <b>F</b> | 59.7                        | 0.242                           | -20%  |   |
|              |  | PM        | 47.2              | D   | 47.7                       | D   | 51.9              | D   | 51.7                         | D   | 1.5                         | 0.008              | <b>68.0</b>                | <b>E</b> | <b>62.8</b>                  | <b>E</b> | 16.0                        | 0.131                           | -20%  |   |
| 8            | Jackson Ave & McKee Rd                       | AM        | 39.3              | D   | 39.3                       | D   | 40.0              | D   | 40.0                         | D   | -0.1                        | -0.003             | 40.9                       | D        | 40.8                         | D        | 0.8                         | 0.122                           | +1%   |   |
|              |  | PM        | 39.9              | D   | 39.9                       | D   | 40.9              | D   | 40.8                         | D   | -0.2                        | 0.006              | 43.4                       | D        | 43.4                         | D        | 5.5                         | 0.129                           | +1%   |   |
| 9            | 17th St & E. Santa Clara St                  | AM        | 6.5               | A   | 6.4                        | A   | 17.1              | B   | 18.4                         | B   | 1.4                         | 0.024              | 25.9                       | C        | 27.6                         | C        | 10.3                        | 0.334                           | +10%  |   |
|              |  | PM        | 9.3               | A   | 9.4                        | A   | 19.8              | B   | 20.5                         | C   | 0.7                         | 0.020              | 33.5                       | C        | 35.3                         | D        | 16.2                        | 0.359                           | +7%   |   |
| 10           | 21st St & E. Santa Clara St                  | AM        | 5.7               | A   | 5.6                        | A   | 5.7               | A   | 5.7                          | A   | 0.1                         | -0.007             | 6.0                        | A        | 5.5                          | A        | -0.6                        | 0.056                           | +27%  |   |
|              |  | PM        | 4.6               | A   | 4.5                        | A   | 4.6               | A   | 4.5                          | A   | 0.0                         | 0.004              | 5.5                        | A        | 5.3                          | A        | 1.1                         | 0.026                           | +12%  |   |
| 11           | 24th St & E. Santa Clara St                  | AM        | 19.5              | B   | 19.6                       | B   | 19.7              | B   | 19.7                         | B   | -0.4                        | -0.014             | 22.4                       | C        | 22.1                         | C        | 2.6                         | 0.158                           | +18%  |   |
|              |  | PM        | 21.1              | C   | 22.2                       | C   | 21.4              | C   | 22.8                         | C   | 2.1                         | 0.044              | 26.5                       | C        | 28.1                         | C        | 11.1                        | 0.224                           | +14%  |   |
| 12           | 26th St & E. Santa Clara St                  | AM        | 16.5              | B   | 16.5                       | B   | 16.5              | B   | 16.5                         | B   | 0.0                         | 0.001              | 15.2                       | B        | 13.7                         | B        | -2.3                        | 0.136                           | +38%  |   |
|              |  | PM        | 14.4              | B   | 13.9                       | B   | 14.4              | B   | 13.8                         | B   | -0.3                        | 0.016              | 13.8                       | B        | 13.2                         | B        | -0.7                        | 0.003                           | +38%  |   |
| 13           | N. 28th St & E. Santa Clara St               | AM        | 20.9              | C   | 23.9                       | C   | 20.9              | C   | 24.6                         | C   | 7.3                         | 0.204              | 20.6                       | C        | 26.9                         | C        | 10.7                        | 0.288                           | +43%  |   |
|              |  | PM        | 18.4              | B   | 21.3                       | C   | 18.4              | B   | 22.3                         | C   | 5.0                         | 0.150              | 19.3                       | B        | 22.1                         | C        | 5.0                         | 0.149                           | +62%  |   |
| 14           | US 101 & E. Santa Clara St *                 | AM        | 11.5              | B   | 10.9                       | B   | 11.8              | B   | 11.0                         | B   | -0.3                        | 0.025              | 11.6                       | B        | 11.0                         | B        | -0.3                        | 0.025                           | +27%  | -0.3  |
|              |  | PM        | 16.2              | B   | 16.5                       | B   | 16.3              | B   | 16.0                         | B   | 1.1                         | 0.131              | 19.6                       | B        | 21.0                         | C        | 6.0                         | 0.121                           | +22%  | 6.0   |
| 15           | US 101 & Alum Rock Ave *                     | AM        | 11.0              | B   | 12.2                       | B   | 11.0              | B   | 12.2                         | B   | 1.1                         | 0.049              | 17.3                       | B        | 17.0                         | B        | -0.3                        | -0.004                          | +9%   | -0.3  |
|              |  | PM        | 15.9              | B   | 15.9                       | B   | 15.9              | B   | 16.1                         | B   | -0.1                        | -0.026             | 20.2                       | C        | 20.2                         | C        | -1.0                        | -0.036                          | +2%   | -1.0  |
| 16           | 33rd St & Alum Rock Rd                       | AM        | 21.4              | C   | 21.2                       | C   | 21.4              | C   | 21.5                         | C   | 0.2                         | 0.013              | 22.6                       | C        | 22.7                         | C        | 1.6                         | 0.124                           | +3%   |   |
|              |  | PM        | 18.5              | B   | 18.4                       | B   | 18.7              | B   | 18.7                         | B   | 0.0                         | 0.013              | 18.5                       | B        | 18.6                         | B        | 0.1                         | 0.211                           | -4%   |   |
| 17           | King Rd & Alum Rock Ave *                    | AM        | 30.1              | C   | 30.5                       | C   | 30.9              | C   | 31.9                         | C   | 4.5                         | 0.013              | 35.7                       | D        | 35.3                         | D        | -0.4                        | -0.005                          | -8%   | -0.4  |
|              |  | PM        | 34.4              | C   | 34.5                       | C   | 36.0              | D   | 35.5                         | D   | 0.1                         | -0.020             | 46.5                       | D        | 44.1                         | D        | -3.3                        | -0.037                          | -10%  | -3.3  |
| 18           | Jackson Ave & Alum Rock Ave *                | AM        | 37.8              | D   | 38.3                       | D   | 42.8              | D   | 42.7                         | D   | -0.2                        | -0.006             | <b>101.1</b>               | <b>F</b> | <b>99.9</b>                  | <b>F</b> | -1.8                        | -0.005                          | -0%   | -1.8  |
|              |  | PM        | 43.0              | D   | 43.2                       | D   | 46.7              | D   | 46.4                         | D   | -0.5                        | -0.008             | <b>55.6</b>                | <b>E</b> | <b>55.4</b>                  | <b>E</b> | -0.8                        | -0.005                          | -1%   | -0.8  |
| 19           | I-680 S & Alum Rock Ave (West) *             | AM        | 22.2              | C   | 22.1                       | C   | 21.7              | C   | 21.8                         | C   | 0.1                         | -0.001             | 31.6                       | C        | 31.5                         | C        | 0.0                         | -0.001                          | +1%   | 0.0   |
|              |  | PM        | 26.6              | C   | 26.2                       | C   | 26.5              | C   | 26.4                         | C   | -0.2                        | 0.001              | 30.2                       | C        | 30.2                         | C        | 0.0                         | 0.002                           | +2%   | 0.0   |
| 20           | I-680 N & Alum Rock Ave (East) *             | AM        | 20.9              | C   | 20.9                       | C   | 21.3              | C   | 21.1                         | C   | -0.2                        | -0.004             | 21.3                       | C        | 21.2                         | C        | -0.2                        | -0.001                          | -2%   | -0.2  |
|              |  | PM        | 26.3              | C   | 26.3                       | C   | 26.4              | C   | 26.3                         | C   | -0.1                        | -0.004             | 26.7                       | C        | 26.6                         | C        | -0.1                        | -0.003                          | -6%   | -0.1  |
| 21           | 24th St & San Antonio St                     | AM        | 16.0              | B   | 16.5                       | B   | 16.0              | B   | 16.4                         | B   | 0.4                         | 0.034              | 26.2                       | C        | 29.9                         | C        | 18.5                        | 0.312                           | +9%   |   |
|              |  | PM        | 12.6              | B   | 12.4                       | B   | 12.5              | B   | 12.3                         | B   | -0.3                        | 0.018              | 16.2                       | B        | 16.3                         | B        | 5.9                         | 0.269                           | +11%  |   |
| 22           | King Rd & E. San Antonio St.                 | AM        | 32.7              | C   | 32.9                       | C   | 32.7              | C   | 33.0                         | C   | 0.2                         | -0.008             | 33.7                       | C        | 34.3                         | C        | 1.6                         | 0.019                           | -5%   |   |
|              |  | PM        | 33.8              | C   | 33.6                       | C   | 33.8              | C   | 34.1                         | C   | 0.3                         | 0.013              | 42.7                       | D        | 42.8                         | D        | 9.7                         | 0.270                           | -4%   |   |
| 23           | Jackson Ave & E. San Antonio St/Capitol Expy | AM        | 35.7              | D   | 35.9                       | D   | 38.8              | D   | 38.8                         | D   | -0.3                        | -0.006             | <b>63.5</b>                | <b>E</b> | <b>63.1</b>                  | <b>E</b> | 47.5                        | 0.291                           | -1%   |   |
|              |  | PM        | 34.7              | C   | 34.8                       | C   | 35.2              | D   | 35.1                         | D   | -0.1                        | -0.007             | 40.2                       | D        | 40.0                         | D        | 10.3                        | 0.195                           | -2%   |   |
| 24           | 24th St & E. William St.                     | AM        | 15.8              | B   | 15.3                       | B   | 15.9              | B   | 15.4                         | B   | -0.3                        | 0.035              | 20.5                       | C        | 19.9                         | B        | 5.2                         | 0.136                           | +10%  |   |
|              |  | PM        | 19.4              | B   | 19.0                       | B   | 19.4              | B   | 19.0                         | B   | -0.4                        | 0.033              | 21.5                       | C        | 21.5                         | C        | 2.5                         | 0.098                           | +11%  |   |
| 25           | McLaughlin Ave & I-280 SB Ramp *             | AM        | 9.5               | A   | 10.1                       | B   | 9.9               | A   | 10.2                         | B   | 0.6                         | 0.015              | 9.8                        | A        | 10.2                         | B        | 0.6                         | 0.023                           | +66%  | 0.6   |
|              |  | PM        | 14.5              | B   | 14.5                       | B   | 15.1              | B   | 15.0                         | B   | 0.0                         | 0.002              | 15.0                       | B        | 14.9                         | B        | -0.1                        | 0.002                           | +25%  | -0.1  |
| 26           | McLaughlin Ave & Story Rd                    | AM        | 42.4              | D   | 42.8                       | D   | 43.2              | D   | 43.4                         | D   | 0.4                         | 0.004              | <b>58.3</b>                | <b>E</b> | <b>60.6</b>                  | <b>E</b> | 29.6                        | 0.252                           | +2%   |   |
|              |  | PM        | 48.5              | D   | 48.7                       | D   | 52.2              | D   | 52.5                         | D   | 0.3                         | 0.002              | 52.8                       | D        | 52.9                         | D        | 1.4                         | 0.048                           | +1%   |   |
| 27           | King Rd & Mabury Rd                          | AM        | 39.7              | D   | 39.7                       | D   | 43.2              | D   | 41.8                         | D   | -6.3                        | -0.016             | <b>65.0</b>                | <b>E</b> | 54.9                         | D        | 22.7                        | 0.331                           | -28%  |   |
|              |  | PM        | 38.9              | D   | 39.4                       | D   | 42.3              | D   | 40.5                         | D   | -3.4                        | -0.077             | <b>59.6</b>                | <b>E</b> | <b>58.3</b>                  | <b>E</b> | 28.4                        | 0.262                           | -27%  |   |

**Notes:**  
 \* Denotes a CMP intersection  
 (1) The Project would cause an impact in San Jose under 2035 Cumulative Plus Project Conditions if the intersection would operate at an unacceptable LOS and the Project would contribute more than 25% of the total increase in traffic volume between 2025 Background and 2035 Cumulative Plus Project Conditions.  
 (2) Increase in Critical Delay and Increase in Critical V/C are calculated as the difference between 2025 Background and 2035 Cumulative Plus Project for non-CMP San Jose intersections, and as the difference between 2035 Cumulative No Project and 2035 Cumulative Plus Project for CMP intersections.  
**Bold** indicates a substandard level of service (according to City of San Jose standards).  
**Bold** with a box indicates a significant impact (according to City of San Jose or CMP standards).

**Table ES- 2  
Intersection Level of Service Summary – Santa Clara Station**

| Study Number | Intersection   | Location    | Peak Hour  | 2015 Existing Plus Project |         |                            |       |                   |         |                              |       |                       |                    | 2035 Cumulative No Project |                   | 2035 Cumulative Plus Project |                   |     | SJ Impact <sup>1</sup> | SC and/or CMP Impact |
|--------------|--|-------------|------------|----------------------------|---------|----------------------------|-------|-------------------|---------|------------------------------|-------|-----------------------|--------------------|----------------------------|-------------------|------------------------------|-------------------|-----|------------------------|----------------------|
|              |  |             |            | 2015 Existing              |         | 2015 Existing Plus Project |       | 2025 Background   |         | 2025 Background Plus Project |       |                       |                    | 2035 Cumulative No Project |                   | 2035 Cumulative Plus Project |                   |     |                        |                      |
|              |  |             |            | Avg. Delay (sec.)          | LOS     | Avg. Delay (sec.)          | LOS   | Avg. Delay (sec.) | LOS     | Avg. Delay (sec.)            | LOS   | Incr. In Delay (sec.) | Crit. Delay (sec.) | Incr. In Crit. V/C         | Avg. Delay (sec.) | LOS                          | Avg. Delay (sec.) | LOS |                        |                      |
| 28           | Scott Blvd & Central Expy *  | Santa Clara | AM 43.8 D  | 43.8 D                     | 42.9 D  | 42.7 D                     | -0.2  | -0.002            | 43.4 D  | 43.3 D                       | 0.0   | 0.001                 | --                 | 0.0                        |                   |                              |                   |     |                        |                      |
| 29           | Lafayette St & Central Expy *  | Santa Clara | AM 53.7 D  | 53.9 D                     | 51.3 D  | 51.8 D                     | 0.7   | 0.009             | 91.3 F  | 91.7 F                       | 0.6   | 0.002                 | --                 | 0.8                        |                   |                              |                   |     |                        |                      |
| 30           | De La Cruz Blvd & Central Expy *   | Santa Clara | AM 270.6 F | 265.1 F                    | 310.3 F | 300.7 F                    | -4.6  | -0.011            | 368.1 F | 364.5 F                      | -0.8  | -0.002                | --                 | -0.8                       |                   |                              |                   |     |                        |                      |
| 31           | De La Cruz Blvd & Martin Ave   | Santa Clara | AM 95.8 F  | 96.4 F                     | 101.2 F | 102.8 F                    | 2.4   | 0.007             | 227.3 F | 243.1 F                      | 27.2  | 0.315                 | --                 | 27.2                       |                   |                              |                   |     |                        |                      |
| 32           | De La Cruz Blvd & Reed St  | Santa Clara | AM 11.1 B  | 11.2 B                     | 10.7 B  | 11.4 B                     | 1.1   | 0.010             | 13.7 B  | 14.3 B                       | 1.0   | 0.011                 | --                 | 1.0                        |                   |                              |                   |     |                        |                      |
| 33           | Coleman Ave & Brokaw Rd  | Santa Clara | AM 17.0 B  | 21.8 C                     | 17.2 B  | 23.0 C                     | 4.2   | 0.047             | 17.9 B  | 22.1 C                       | 5.4   | 0.044                 | --                 | 5.4                        |                   |                              |                   |     |                        |                      |
|              | With Mitigation (convert E-W signal operation to split phase, add LT-Thru lane to E and W legs, and overlap EB RT) |             |            |                            |         |                            |       |                   |         |                              |       |                       |                    |                            |                   |                              |                   |     |                        |                      |
| 34           | Coleman Ave & Aviation Ave   | San Jose    | AM 14.6 B  | 20.4 C                     | 31.3 C  | 40.3 D                     | 13.7  | 0.038             | 34.6 C  | 41.5 D                       | 17.6  | 0.048                 | +23%               | --                         |                   |                              |                   |     |                        |                      |
| 35           | Coleman Ave & Newhall Dr   | San Jose    | AM 13.6 B  | 13.5 B                     | 14.2 B  | 14.5 B                     | 0.6   | 0.023             | 16.4 B  | 16.5 B                       | 0.4   | 0.015                 | +9%                | --                         |                   |                              |                   |     |                        |                      |
| 36           | Coleman Ave & I-880 SB Ramps *   | San Jose    | AM 24.7 C  | 27.7 C                     | 40.9 F  | 41.8 F                     | 14.5  | 0.032             | 102.0 F | 108.7 F                      | 8.3   | 0.019                 | +7%                | CMP                        |                   |                              |                   |     |                        |                      |
|              | With Mitigation (convert WB middle LT lane to a shared L-R lane)   |             |            |                            |         |                            |       |                   |         |                              |       |                       |                    |                            |                   |                              |                   |     |                        |                      |
| 37           | Coleman Ave & I-880 NB Ramps *   | San Jose    | AM 11.6 B  | 12.4 B                     | 13.6 D  | 13.7 D                     | 0.035 | 52.3 D            | 56.0 E  | 9.5                          | 0.023 | +24%                  | 9.5                |                            |                   |                              |                   |     |                        |                      |
| 38           | Coleman Ave & W. Hedding St  | San Jose    | AM 26.2 C  | 26.6 C                     | 32.6 C  | 33.0 C                     | -0.3  | 0.000             | 35.8 D  | 36.1 D                       | -4.2  | -0.007                | +4%                | -3.8                       |                   |                              |                   |     |                        |                      |
| 39           | Coleman Ave & W. Taylor St   | San Jose    | AM 45.0 D  | 45.4 D                     | 60.0 E  | 60.2 E                     | 0.2   | 0.000             | 67.3 E  | 66.7 E                       | 7.9   | 0.034                 | -5%                | --                         |                   |                              |                   |     |                        |                      |
| 40           | SR 87 & W. Taylor St   | San Jose    | AM 24.2 C  | 24.4 C                     | 28.7 C  | 28.5 C                     | -0.6  | -0.004            | 34.6 C  | 34.0 C                       | 2.5   | 0.059                 | -8%                | --                         |                   |                              |                   |     |                        |                      |
| 41           | San Tomas Expy & El Camino Real *  | Santa Clara | AM 66.2 E  | 66.2 E                     | 83.8 F  | 82.8 F                     | -1.3  | -0.004            | 97.5 F  | 96.2 F                       | -2.1  | -0.005                | --                 | -2.1                       |                   |                              |                   |     |                        |                      |
| 42           | Scott Blvd & El Camino Real *  | Santa Clara | AM 33.8 C  | 33.6 C                     | 34.1 C  | 34.1 C                     | 0.1   | -0.001            | 37.1 D  | 37.0 D                       | 0.3   | 0.008                 | --                 | 0.3                        |                   |                              |                   |     |                        |                      |
| 43           | Lincoln St & El Camino Real *  | Santa Clara | AM 21.1 C  | 21.0 C                     | 20.9 C  | 20.8 C                     | -0.1  | 0.000             | 28.6 C  | 28.6 C                       | 0.0   | 0.001                 | --                 | 0.0                        |                   |                              |                   |     |                        |                      |
| 44           | Monroe St & El Camino Real *   | Santa Clara | AM 35.5 D  | 35.8 D                     | 35.8 D  | 36.2 D                     | 0.2   | 0.007             | 37.7 D  | 38.2 D                       | 0.3   | 0.008                 | --                 | 0.3                        |                   |                              |                   |     |                        |                      |
| 45           | Lafayette St & Reed St   | Santa Clara | AM 6.8 A   | 6.8 A                      | 7.3 A   | 7.3 A                      | 0.1   | 0.002             | 7.3 A   | 7.4 A                        | 0.1   | 0.007                 | --                 | 0.1                        |                   |                              |                   |     |                        |                      |
| 46           | Lafayette St & El Camino Real *  | Santa Clara | AM 40.8 D  | 40.2 D                     | 43.0 D  | 42.4 D                     | 0.0   | 0.000             | 56.8 E  | 56.9 E                       | 1.1   | 0.005                 | --                 | 1.1                        |                   |                              |                   |     |                        |                      |
| 47           | Lafayette St & Lewis St  | Santa Clara | AM 10.7 B  | 11.0 B                     | 10.0 B  | 10.4 B                     | 0.6   | 0.021             | 11.2 B  | 11.3 B                       | -0.1  | 0.001                 | --                 | -0.1                       |                   |                              |                   |     |                        |                      |
|              | With Mitigation (Shift WB leg lane geometries to change current RT-Thru lane to separate Thru and RT)              |             |            |                            |         |                            |       |                   |         |                              |       |                       |                    |                            |                   |                              |                   |     |                        |                      |
| 48           | Lafayette St & Hamilton St Unsignalized (3)  | Santa Clara | AM 48.9 E  | 54.5 F                     | 69.9 F  | 90.0 F                     | --    | --                | OVER F  | OVER F                       | --    | --                    | --                 | N/A                        |                   |                              |                   |     |                        |                      |
| 49           | Lafayette St & Benton St   | Santa Clara | AM 17.1 B  | 17.0 B                     | 17.2 B  | 17.2 B                     | -0.1  | 0.019             | 20.2 C  | 20.2 C                       | -0.1  | 0.018                 | --                 | -0.1                       |                   |                              |                   |     |                        |                      |
| 50           | Lafayette St & Homestead Rd  | Santa Clara | AM 15.7 B  | 15.6 B                     | 17.8 B  | 17.9 B                     | 0.1   | 0.025             | 18.1 B  | 18.2 B                       | -4.4  | 0.020                 | --                 | -4.4                       |                   |                              |                   |     |                        |                      |
| 51           | Lafayette St & Market St   | Santa Clara | AM 16.6 B  | 16.8 B                     | 17.3 B  | 17.8 B                     | 0.6   | 0.027             | 22.7 C  | 24.1 C                       | 1.6   | 0.026                 | --                 | 1.6                        |                   |                              |                   |     |                        |                      |
| 52           | El Camino Real & Benton St   | Santa Clara | AM 12.8 B  | 12.6 B                     | 12.6 B  | 12.5 B                     | -0.1  | 0.013             | 13.8 B  | 13.7 B                       | -0.1  | 0.014                 | --                 | -0.1                       |                   |                              |                   |     |                        |                      |
| 53           | El Camino Real & Railroad Ave  | Santa Clara | AM 15.4 B  | 15.3 B                     | 15.4 B  | 15.2 B                     | -0.3  | 0.004             | 16.7 B  | 16.6 B                       | -0.1  | 0.007                 | --                 | -0.1                       |                   |                              |                   |     |                        |                      |
| 54           | El Camino Real & The Alameda *   | Santa Clara | AM 10.5 B  | 10.4 B                     | 10.5 B  | 10.5 B                     | 0.0   | 0.011             | 11.1 B  | 11.2 B                       | 0.1   | 0.013                 | --                 | 0.1                        |                   |                              |                   |     |                        |                      |
| 55           | The Alameda & Newhall Dr   | San Jose    | AM 13.0 B  | 12.9 B                     | 13.0 B  | 13.0 B                     | 0.1   | 0.005             | 18.7 B  | 18.8 B                       | 0.3   | 0.008                 | --                 | 0.3                        |                   |                              |                   |     |                        |                      |
| 56           | The Alameda & I-880 (South) *  | San Jose    | AM 12.5 B  | 12.6 B                     | 12.4 B  | 12.4 B                     | -0.2  | -0.007            | 14.7 B  | 14.6 B                       | -3.3  | 0.068                 | -5%                | --                         |                   |                              |                   |     |                        |                      |
| 57           | The Alameda & I-880 (North) *  | San Jose    | AM 19.2 B  | 18.8 B                     | 20.5 C  | 19.3 B                     | -1.7  | -0.014            | 20.0 C  | 18.9 B                       | -1.3  | -0.009                | -9%                | --                         |                   |                              |                   |     |                        |                      |
| 58           | The Alameda & W. Hedding St *  | San Jose    | AM 14.6 B  | 14.6 B                     | 15.2 B  | 14.6 B                     | -1.0  | -0.017            | 26.1 C  | 25.1 C                       | -1.3  | -0.022                | -8%                | --                         |                   |                              |                   |     |                        |                      |
| 59           | The Alameda & W. Taylor St/Nagle Ave *   | San Jose    | AM 23.2 C  | 23.0 C                     | 24.4 C  | 24.3 C                     | -0.1  | -0.002            | 40.7 D  | 40.7 D                       | 0.1   | 0.001                 | -3%                | --                         |                   |                              |                   |     |                        |                      |
| 60           | Homestead Rd & Lincoln St/Winchester Blvd  | Santa Clara | AM 21.2 C  | 21.2 C                     | 21.1 C  | 21.2 C                     | 0.1   | 0.002             | 29.6 C  | 29.6 C                       | 0.0   | -0.001                | -7%                | --                         |                   |                              |                   |     |                        |                      |
| 61           | Homestead Rd & Monroe St   | Santa Clara | AM 37.2 D  | 37.7 D                     | 39.2 D  | 39.2 D                     | 0.1   | 0.000             | 72.7 E  | 72.9 E                       | 0.1   | 0.000                 | -1%                | 0.1                        |                   |                              |                   |     |                        |                      |
| 62           | US 101 & Trimble   | San Jose    | AM 38.0 D  | 37.9 D                     | 39.3 D  | 39.2 D                     | -0.3  | -0.004            | 93.4 F  | 92.1 F                       | -2.1  | -0.005                | -1%                | -2.1                       |                   |                              |                   |     |                        |                      |
|              |  |             | AM 42.3 D  | 42.3 D                     | 42.7 D  | 42.3 D                     | -0.8  | -0.010            | 92.5 F  | 89.5 F                       | -4.9  | -0.013                | -2%                | -4.9                       |                   |                              |                   |     |                        |                      |
|              |  |             | PM 40.5 D  | 43.4 D                     | 46.7 D  | 47.0 D                     | 0.6   | 0.008             | 70.0 E  | 71.4 E                       | 2.1   | 0.008                 | +0%                | 2.1                        |                   |                              |                   |     |                        |                      |
|              |  |             | AM 21.3 C  | 21.2 C                     | 21.5 C  | 21.4 C                     | -0.3  | 0.008             | 20.5 C  | 20.4 C                       | -0.2  | 0.008                 | --                 | -0.2                       |                   |                              |                   |     |                        |                      |
|              |  |             | PM 21.4 C  | 21.4 C                     | 21.5 C  | 21.4 C                     | 0.2   | 0.008             | 22.0 C  | 21.8 C                       | -1.3  | 0.010                 | -2%                | -1.3                       |                   |                              |                   |     |                        |                      |
|              |  |             | AM 9.8 A   | 9.8 A                      | 9.9 A   | 9.9 A                      | 0.0   | 0.004             | 10.5 B  | 10.6 B                       | 0.0   | 0.002                 | --                 | 0.0                        |                   |                              |                   |     |                        |                      |
|              |  |             | PM 10.5 B  | 10.5 B                     | 10.5 B  | 10.5 B                     | 0.0   | 0.001             | 11.1 B  | 11.1 B                       | 0.0   | 0.001                 | --                 | 0.0                        |                   |                              |                   |     |                        |                      |
|              |  |             | AM 21.8 C  | 22.6 C                     | 22.8 C  | 23.1 C                     | 0.1   | 0.002             | 26.5 C  | 27.6 C                       | 7.0   | 0.065                 | +5%                | --                         |                   |                              |                   |     |                        |                      |
|              |  |             | PM 13.6 B  | 13.6 B                     | 13.1 B  | 13.1 B                     | 0.0   | -0.003            | 15.6 B  | 15.6 B                       | 4.3   | 0.099                 | +0%                | --                         |                   |                              |                   |     |                        |                      |

Notes:  
 \* Denotes a CMP intersection  
 (1) The Project would cause an impact in San Jose under 2035 Cumulative Plus Project Conditions if the intersection would operate at an unacceptable LOS and the Project would contribute more than 25% of the total increase in traffic volume between 2025 Background and 2035 Cumulative Plus Project Conditions.  
 (2) Increase in Critical Delay and Increase in Critical V/C are calculated as the difference between 2025 Background and 2035 Cumulative Plus Project for non-CMP San Jose intersections, and as the difference between 2035 Cumulative No Project and 2035 Cumulative With Project for Santa Clara and CMP intersections.  
 (3) The reported delay and corresponding level of service for signalized intersections represent the average delay for all approaches at the intersection. The reported delay and corresponding level of service for unsignalized (two-way stop-controlled) intersections are based on the stop-controlled approach with the highest delay.  
**Bold** indicates a substandard level of service (according to City of San Jose or City of Santa Clara standards).  
**Bold** with a box indicates a significant impact (according to City of San Jose or City of Santa Clara Standards).



# 1. Introduction

---

This report presents the results of the Transportation Impact Analysis (TIA) prepared for the proposed Santa Clara Valley Transportation Authority's (VTA's) BART Silicon Valley Phase II Extension and Transit-Oriented Joint Development Project (the "Project"), including four proposed BART Stations along the extension and VTA's Transit-Oriented Joint Development sites near those stations. The proposed Project is the second phase of the BART Silicon Valley Program, which would provide for the extension of Bay Area Rapid Transit (BART) service to the Cities of Milpitas, San Jose, and Santa Clara. The Project includes four new BART stations proposed along the Silicon Valley Rapid Transit Corridor (SVRTC). The proposed BART stations are located in the Cities of San Jose and Santa Clara and include:

- Alum Rock/28<sup>th</sup> Street Station, which is in the City of San Jose and outside the City's Downtown Core Area;
- Downtown San Jose Station, which is within the City of San Jose's Downtown Core Area;
- Diridon Station, which is within the City of San Jose's Downtown Core Area and the Diridon Station Area Plan (DSAP) boundaries; and
- Santa Clara Station, which is in the City of Santa Clara.

The Transit-Oriented Joint Development (TOJD) portion of the Project proposed by VTA would include a combination of office space, retail space, and residential units at the Alum Rock/28<sup>th</sup> Street and Santa Clara BART Stations, and a mix of office and retail space at the Downtown and Diridon BART Stations. The Project also proposes small supporting retail developments at two locations along the alignment in San Jose where ventilation structures for the BART tunnel would be located.

## Project Description

Figure 1 presents the proposed Project corridor alignment and stations. Phase I of the BART Silicon Valley Program (also known as VTA's BART Silicon Valley – Phase I Extension Project, or Phase I Project) includes two new stations, located in the Cities of Milpitas (Milpitas Station) and San Jose (Berryessa Station). A traffic analysis of the Phase I Project was completed as part of previous environmental studies. The Phase I Project is under construction and will be completed in late 2017 or early 2018. Passenger service for the Phase II Project is planned to begin in 2025.

The Project includes an approximately 6-mile extension of the BART system beginning at the terminus of the Phase I Project, south of Mabury Road and east of US 101 in San Jose. The Phase II Project would descend into an approximately 5-mile-long subway tunnel, continue through downtown San Jose, and terminate at grade in the City of Santa Clara near the Caltrain Station. A TIA of the Phase II Extension Project *without* VTA's proposed Transit-Oriented Joint Development has also been prepared by Hexagon Transportation Consultants and includes trips to and from the four Phase II BART stations and the projected change in background traffic as BART users

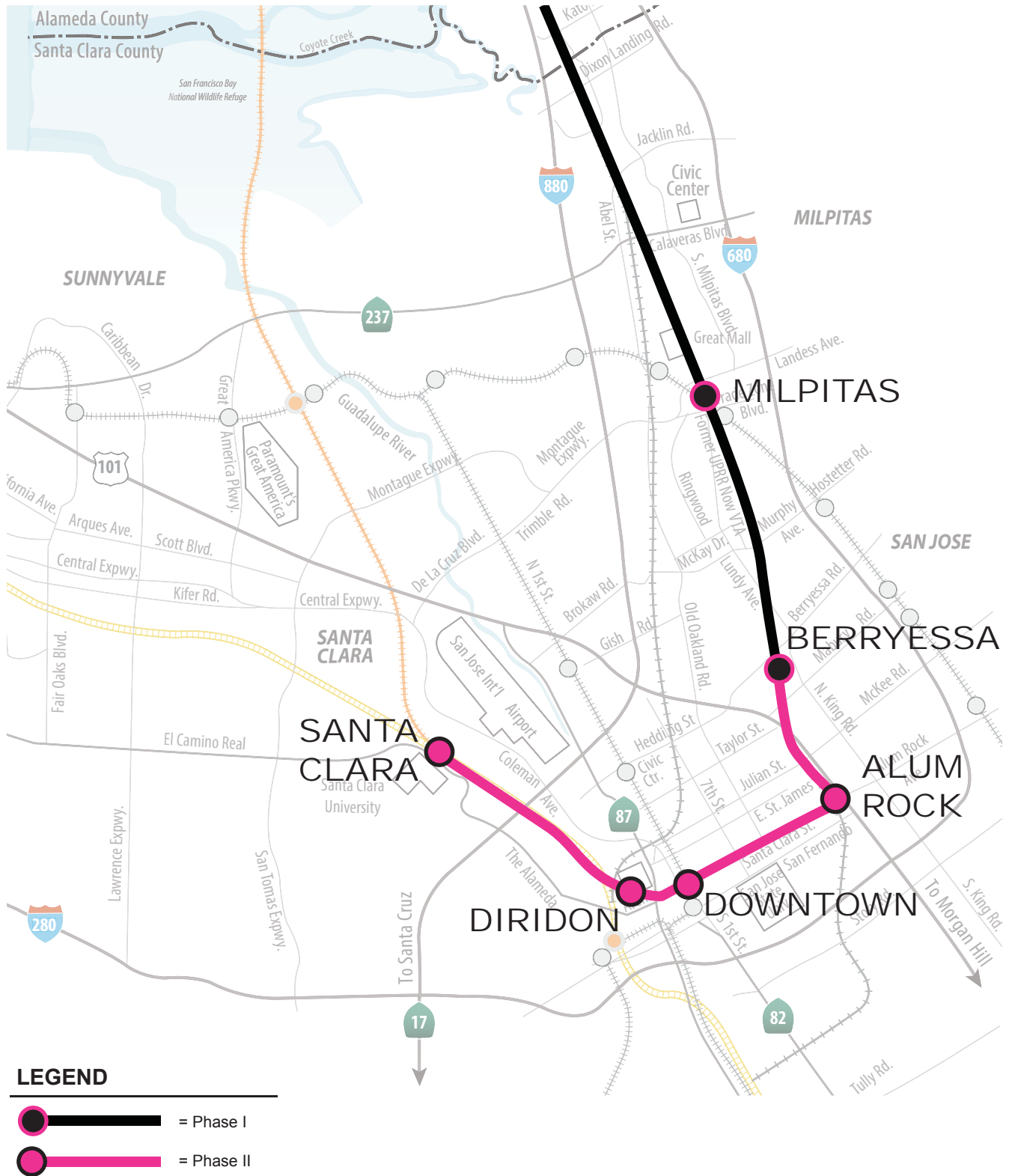

**Figure 1**  
Phase II Extension Project Alignment and Stations



switch from passenger vehicles to BART. This current BART Extension with TOJD TIA for the Project incorporates the results of that BART Extension Only analysis, which is included as Appendix G and referred to in this document as the “BART Extension TIA” or the “BART Extension Only TIA” for clarity. This TIA builds upon that earlier “BART Extension Only TIA” by adding trips related to VTA’s proposed TOJD sites at each of the four Phase II stations. The results of both TIAs have been incorporated into a Supplemental Environmental Impact Statement/Subsequent Environmental Report (SEIS/SEIR).

There are two construction methods proposed for the 5-mile-long tunnel portion of the Phase II BART extension: the Twin-Bore and Single-Bore Options. Under the Twin-Bore Option, two tunnels would be excavated with one track in each, and each tunnel bore would have an outer diameter of approximately 20 feet. Under the Single-Bore Option, one tunnel bore with an outer diameter of approximately 45 feet would be excavated and would contain both northbound and southbound tracks. All transportation-related impacts evaluated in this TIA would be the same for both options, so this report does not distinguish between the two tunnel options in its analysis and discussion of transportation impacts.

Two of the proposed stations would provide both park-and-ride (PNR) and kiss-and-ride (KNR) facilities for BART users: the Alum Rock/28<sup>th</sup> Street and Santa Clara Stations. Kiss-and-ride facilities would be provided at the Diridon Station. The Downtown San Jose Station would not provide kiss-and-ride or parking facilities and, therefore, this BART station (excluding the TOJD component) would not generate a significant amount of vehicular traffic on the surrounding roadway network. Because patrons would access the Downtown San Jose BART Station by walking, biking, or taking transit, it was not evaluated in the “BART Extension Only TIA.” Each of the BART stations and Transit-Oriented Joint Development sites are described in detail below.

### **Alum Rock/28<sup>th</sup> Street Station**

Alum Rock/28<sup>th</sup> Street Station would be bounded by McKee Road on the north, Santa Clara Street on the south, US 101 on the east, and North 28<sup>th</sup> Street on the west (see Figure 2). The station campus would include an underground station with street-level entrance portals with elevators, escalators and stairs. The station would include system facilities both above and below ground. A 1,200-space parking structure with up to seven levels for PNR BART commuters would also be constructed. Kiss-and-ride (KNR) facilities would be provided along North 28<sup>th</sup> Street and/or on the station campus. Additionally, bus and shuttle drop-off areas would be provided along North 28<sup>th</sup> Street.

Access to the station area (including the Transit-Oriented Joint Development) would be from North 28<sup>th</sup> Street, via McKee Road from the north and via East Santa Clara Street from the south. The Project would have two access points on North 28<sup>th</sup> Street, both of which would be signalized. A pedestrian connection along the south side of the station campus at North 28<sup>th</sup> Street from East Santa Clara Street would link the station entrances with buses and Bus Rapid Transit (BRT) operating on East Santa Clara Street/Alum Rock Avenue.

The Transit-Oriented Joint Development component of Alum Rock/28<sup>th</sup> Street Station includes replacing industrial uses currently operating on the site with up to 500,000 square feet (s.f.) of office space, 275 apartment units, and 20,000 s.f. of retail space. Surface and garage parking for the office, residential, and retail uses would be provided on site and would include 2,150 parking spaces or the number of spaces in accordance with City standards at the time that site planning is finalized.

### **Downtown San Jose Station**

There are two station location options for the Downtown San Jose Station (an East Option and a West Option), both of which would be located underground beneath Santa Clara Street. Three Transit-Oriented Joint Development sites are proposed as part of the Downtown Station East Option. The East Option TOJD sites would be located on the southeast corner of Sixth Street/Santa Clara Street, the northwest corner of Fourth Street/Santa Clara Street, and the northwest corner of Third Street/Santa Clara Street. The Downtown San Jose Station - East Option would replace existing commercial uses with up to 160,000 s.f. of retail space and up to 303,000 s.f. of office space. Under the Downtown San Jose Station – West Option, up to 10,000 s.f. of retail space and 35,000 s.f. of office space would be constructed.

Up to three levels of underground parking for the office and retail uses would be provided on each East Option site listed above and would include 1,030, 240, and 128 parking spaces, respectively, or the number of spaces in accordance with City standards at the time that site planning is finalized. Under the West Option, a total of 128

parking spaces would be provided. As noted above, the Downtown BART Station would not include PNR or KNR facilities.

As shown on Figure 3, the Transit-Oriented Joint Development sites that are associated with both the East and West Options of the Downtown BART Station are within the Downtown Core Area covered by the San Jose Downtown Strategy 2000. The office and retail uses proposed at these three sites are fully consistent with the City of San Jose's Downtown Strategy 2000, which is discussed further in the next section of this chapter.

### **TOJD at Ventilation Structures in San Jose**

The Project also proposes two small retail developments at the following San Jose locations, where ventilation structures for the BART subway tunnel will be placed:

- Santa Clara Street and 13<sup>th</sup> Street: 13,000 s.f. of retail space; and
- Stockton Avenue, between Schiele Avenue and W. Taylor Street: 15,000 s.f. of retail space.

These two sites are outside the area covered by the City of San Jose's Downtown 2000 Strategy. Both of these sites are expected to include local-serving retail establishments (e.g., coffee shops, dry cleaners, or neighborhood convenience stores) that would be expected to have significant numbers of pass-by trips by patrons who would stop at one of the uses on their way to or from another destination, and therefore would not be making new vehicle trips on the roadway. Thus, a pass-by reduction of 25% could be applied to these sites. Further, most of the vehicle trips generated by these retail uses that are *not* pass-by trips would likely be short-distance local trips, due to the neighborhood-serving nature of the shops. These factors, in combination with the small size of the sites, lead to the conclusion that, when ITE trip rates are used, they would generate fewer than 50 trips during both peak hours, and would therefore fall below the threshold for which VTA's *TIA Guidelines* and the City of San Jose require a TIA. Accordingly, the City has agreed that the two small joint development sites on the subway tunnel ventilation structures would be exempt from a TIA and therefore need not be included in this study.<sup>2</sup>

---

<sup>2</sup> Email from Mr. Alex Wong, San Jose Department of Public Works, Development Services Division, dated October 1, 2015, to Mr. Brian Jackson and Mr. At van den Hout of Hexagon Transportation Consultants. Also, meeting of Hexagon staff with Ms. Karen Mack and Mr. Alex Wong, San Jose Department of Public Works, on September 30, 2015.

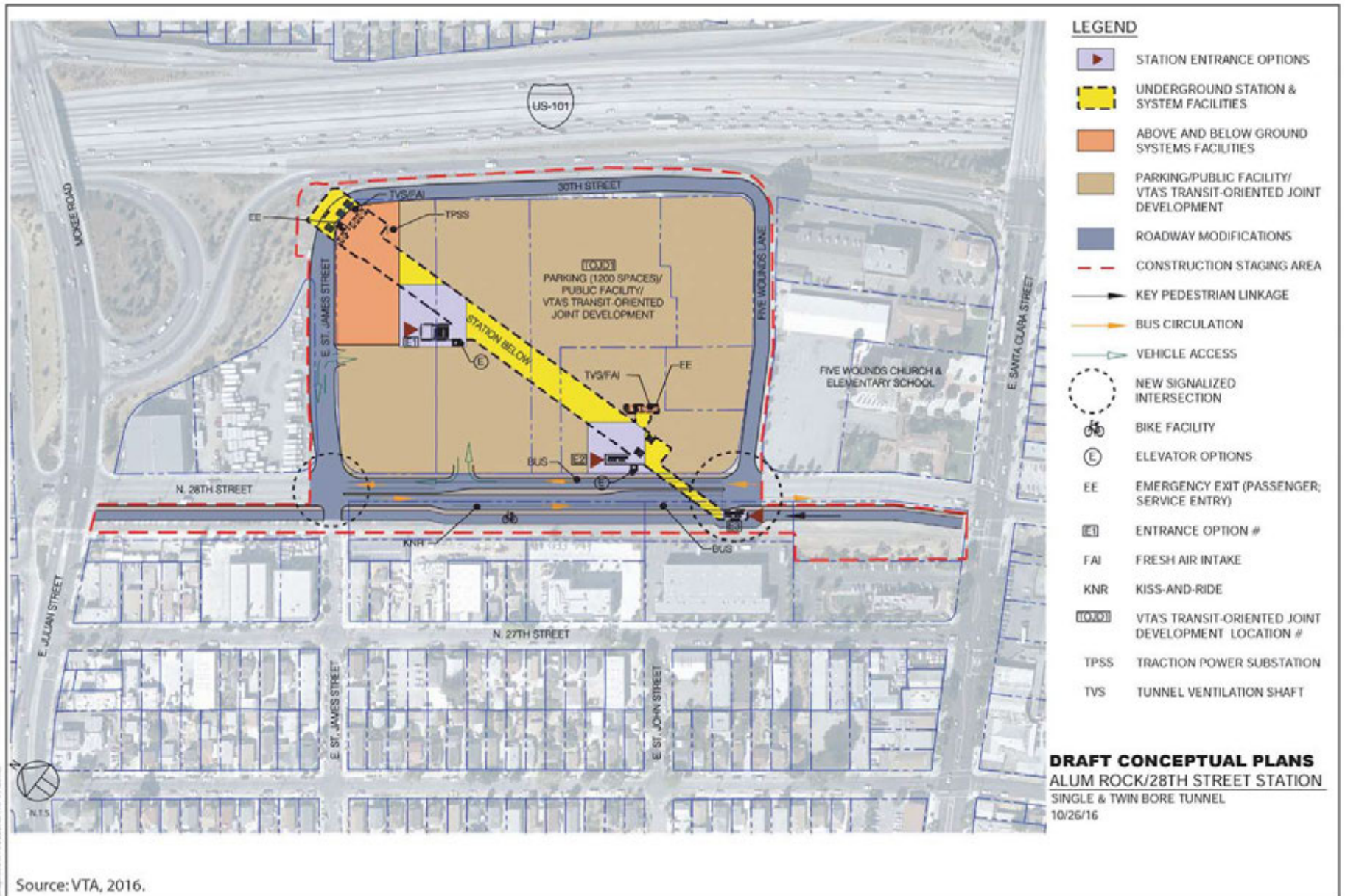

Figure 2 Alum Rock/28th Street Station and Transit-Oriented Joint Development

## Diridon Station

There are two station location options for the Diridon Station: the South Option and the North Option, both of which would be located in the general area of the Diridon Caltrain Station and both of which would consist of an underground boarding platform level, a mezzanine level, and entrances at street level portals. Under either the North or South option, Diridon Station would be generally located underground between Los Gatos Creek (to the east) and the Diridon Caltrain Station (to the west) and south of/parallel to West Santa Clara Street (see Figure 3). The South Option would be located midway between Santa Clara Street and Stover Street. The North Option would be located adjacent to, and just south of, Santa Clara Street. For purposes of analyzing traffic impacts, however, there would be no difference between the North and South options. The existing VTA bus transit center would be reconfigured for better access and circulation to accommodate projected bus and shuttle transfers to and from the BART station. A KNR facility would be located along Cahill Street. No PNR facilities would be provided.

Access to the station campus would be provided from West Santa Clara Street at Cahill and Autumn Streets from the north. Access from the south would be from West San Fernando Street. Street-level station entrance portals would provide pedestrian linkages to the Diridon Caltrain Station and SAP Center.

The Transit-Oriented Joint Development component of Diridon Station would be located adjacent to the station and would consist of replacing mostly parking lots with up to 640,000 s.f. of office space and 72,000 s.f. of retail space. Up to three levels of underground parking for the office component of the Project would be provided on-site and would include 400 parking spaces or the number of spaces in accordance with City standards at the time that site planning is finalized.

The Transit-Oriented Joint Development proposed for Diridon Station is within the Downtown Core Area covered by the San Jose Downtown Strategy 2000, as shown on Figure 3. The office and retail uses proposed at Diridon Station are fully consistent with the City of San Jose's Downtown Strategy 2000. The site is also within the area covered by the City of San Jose's Diridon Station Area Plan and is also fully consistent with that plan. Both the Downtown Strategy 2000 and the Diridon Station Area Plan are discussed further in the next section of this chapter.

## Santa Clara Station

Santa Clara Station would be located at grade just northeast of the Caltrain tracks and the Santa Clara Caltrain Station (between Coleman Avenue and El Camino Real), at the western end of Brokaw Road (see Figure 4). Kiss-and-ride facilities and bus/shuttle loading areas would be provided along Brokaw Road, which would be widened. An approximately 240-foot-long pedestrian tunnel would connect from the Santa Clara BART Station to the Santa Clara Caltrain Station plaza, and an approximately 175-foot-long pedestrian tunnel would connect from the BART station to a new BART plaza on Brokaw Road.

The PNR demand at the Santa Clara Station would be accommodated in an approximately 500-space parking structure located north of Brokaw Road and east of the Caltrain tracks. Vehicular access to the parking structure would be provided from Brokaw Road and Coleman Avenue. Pedestrian access from the parking structure to the Santa Clara BART Station would be provided through a pedestrian tunnel described above from Brokaw Road to the station.

The Transit-Oriented Joint Development component of the Santa Clara Station includes replacing industrial uses currently operating on the site with a maximum of 500,000 s.f. of office space, 220 dwelling units, and 30,000 s.f. of retail space. One level of underground parking along with surface and garage parking for the office, residential, and retail uses would be provided on site and would include 2,200 parking spaces or the number of spaces in accordance with City standards at the time that site planning is finalized.





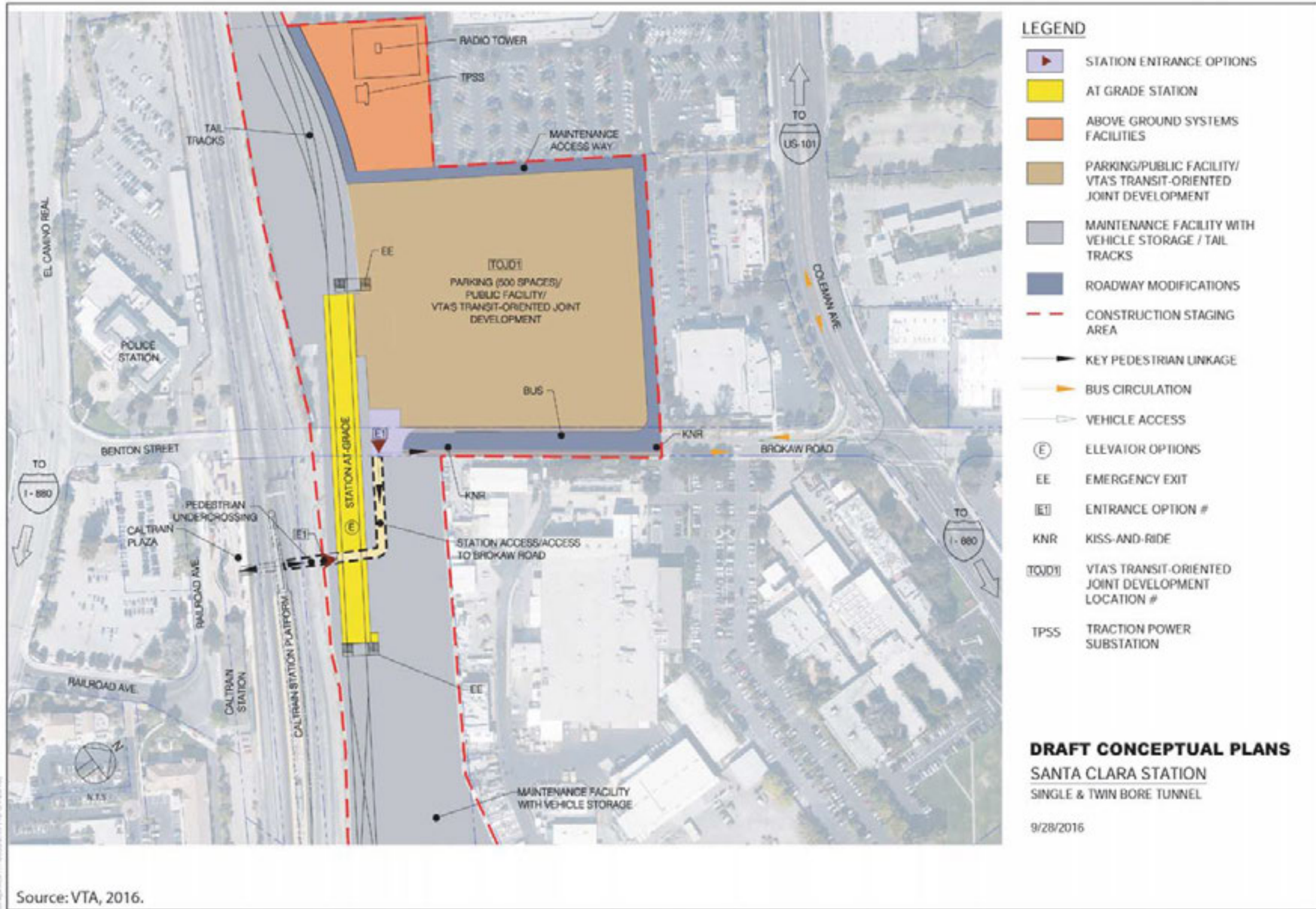

Figure 4  
 Santa Clara Station and Transit-Oriented Joint Development

## San Jose Downtown Strategy 2000 and Diridon Station Area Plan

As mentioned above, both the Downtown San Jose Station and the Diridon Station are located within the Downtown Core Area as defined by the San Jose Downtown Strategy 2000 Environmental Impact Report (City of San Jose, *Strategy 2000: San Jose Greater Downtown Strategy Plan for Development Program Environmental Impact Report*), and the office and retail uses proposed for the Transit-Oriented Joint Development at these stations are fully consistent with that EIR. The *Downtown Strategy Plan 2000* is a long-range conceptual program for revitalizing downtown San Jose by allowing high density infill development and replacement of underutilized uses (City of San Jose, 2001). That EIR included analysis of 164 intersections in the Downtown Core Area, the surrounding neighborhoods, and corridors leading to the Core Area. A total of 46 directional freeway segments, parking facilities, and transit, bicycle, and pedestrian facilities were also analyzed. Therefore, the potential for traffic impacts associated with these Transit-Oriented Joint Development sites has already been analyzed and appropriate mitigation strategies for any impacts have been identified as part of that EIR.

Because of the location of the proposed Transit-Oriented Joint Developments near the Downtown San Jose and Diridon Stations within the Downtown Core Area, City of San Jose staff have concluded that these developments are exempt from the City of San Jose Transportation Level of Service Policy (Council Policy 5-3) and will not require preparation of a comprehensive Transportation Impact Analysis (TIA). Based on guidance from City of San Jose staff<sup>3</sup>, analysis of the proposed Transit-Oriented Joint Development at these two stations was environmentally cleared at a project level in the San Jose Downtown Strategy 2000 EIR, and therefore is not included in this TIA.

The San Jose Public Works Department has requested that a traffic operations study be prepared at a future date prior to construction of the Project in order to identify potential operational issues that could occur as a result of the Transit-Oriented Joint Development at the Downtown San Jose and Diridon Stations.<sup>4</sup> Site planning and design for the Transit-Oriented Joint Developments at these stations are still in a very preliminary stage; therefore, a detailed traffic operations analysis of intersection queuing, site access, and on-site circulation at these locations will be prepared and submitted to the City of San Jose Public Works Department for their review at a future date when detailed site plans are available.

Diridon Station is also within the area covered by the Diridon Station Area Plan (DSAP). The DSAP is a 35-year land use plan developed by the City of San Jose that focuses on the intensification of land uses in the Diridon Station area and expansion of the Diridon Station to serve as a transit hub for existing and planned transit systems, including the BART service covered by this TIA. The office and retail uses proposed by VTA for the Diridon Station Transit-Oriented Joint Development exemplify the intensification of land uses envisioned by the DSAP.

The DSAP includes a shift in approved development growth from the traditional Downtown Core as identified by the approved Strategy 2000 to the Diridon Station Area, west of SR 87. Though the DSAP consists of the reallocation of land uses, the total planned development growth within the Downtown area remains as identified with the approved Strategy 2000 EIR. However, a small amount of retail space and over half of the residential units proposed by the DSAP are outside of the Downtown area. An EIR was prepared for the DSAP (City of San Jose, *Diridon Station Area Plan Integrated Final Program Environmental Impact Report*, August 2014) in order to identify any intersection or freeway impacts under “DSAP Buildout plus Strategy 2000” project conditions and to develop appropriate mitigation measures for any impacts. Because the office and retail Transit-Oriented Joint Development proposed for Diridon Station is consistent with the DSAP, it is also covered by that EIR.

---

<sup>3</sup> Email from Mr. Alex Wong, San Jose Department of Public Works, Development Services Division, dated October 1, 2015, to Mr. Brian Jackson and Mr. At van den Hout of Hexagon Transportation Consultants.

<sup>4</sup> See Appendix G, Signed Workslope for the Phase II Project from City of San Jose Department of Public Works, Development Services Division.



## Scope of Study

This study was conducted for the purpose of identifying the potential traffic impacts related to the proposed Project. However, as discussed above, the Transit-Oriented Joint Development portions of the Project proposed for the San Jose Downtown and Diridon BART Stations are covered by the EIR prepared by the City of San Jose for its Downtown Strategy 2000, and therefore need not be analyzed as part of this TIA. Also, based on guidance from San Jose staff and VTA's *TIA Guidelines*, the small retail uses at two ventilation structures, one on 13<sup>th</sup> Street and one on Stockton Avenue, fall below the trip generation threshold for which a TIA is required. This TIA will therefore analyze only the Alum Rock/28<sup>th</sup> Street and Santa Clara Stations.

The combined impacts of the BART transit service and the Transit-Oriented Joint Development at the Alum Rock and Santa Clara Stations were evaluated following the standards and methodologies set forth by the Cities of San Jose and Santa Clara, the Congestion Management Program (CMP), and the California Environmental Quality Act (CEQA). The traffic analysis is based on peak-hour levels of service for signalized intersections and freeway segments. The study also includes an evaluation of project impacts on pedestrian and bicycle facilities as well as transit services in the study areas. An evaluation of parking for the TOJD portion of the Project is also included.

The study area and study intersections for the Alum Rock/28<sup>th</sup> Street and Santa Clara BART Stations and associated Transit-Oriented Joint Development are shown on Figures 5 and 6.

All intersections near the Alum Rock/28<sup>th</sup> Street and Santa Clara stations that were included in the "BART Extension Only TIA" are also included in this TIA, although the number and order of those intersections has been changed. Additional intersections that may experience trips related to the Transit-Oriented Joint Development component of the project have been added to this TIA. Note that the numbering for the Santa Clara Station intersections begins at #28, because the numbering sequence from Alum Rock/28<sup>th</sup> Street Station has been continued.

Tables presenting the intersections that are included in the "BART Extension Only TIA," in this "BART Extension with TOJD TIA," and in the SEIS/SEIR are included in Appendix A. The study intersections for the Alum Rock/28<sup>th</sup> Street and Santa Clara BART Stations and TOJD sites are listed below.

### Alum Rock/28<sup>th</sup> Street Station

#### *Intersections*

- (1) 21<sup>st</sup> Street and East Julian Street
- (2) 24<sup>th</sup> Street and East Julian Street
- (3) North 28<sup>th</sup> Street and East Julian Street
- (4) US 101 and East Julian Street
- (5) US 101 and McKee Road
- (6) 33<sup>rd</sup> Street and McKee Road
- (7) King Road and McKee Road
- (8) Jackson Avenue and McKee Road
- (9) 17<sup>th</sup> Street and East Santa Clara Street
- (10) 21<sup>st</sup> Street and East Santa Clara Street
- (11) 24<sup>th</sup> Street and East Santa Clara Street (CSJ Protected)
- (12) 26<sup>th</sup> Street and East Santa Clara Street
- (13) North 28<sup>th</sup> Street and East Santa Clara Street
- (14) US 101 and East Santa Clara Street \*
- (15) US 101 and Alum Rock Avenue \*
- (16) 33<sup>rd</sup> Street and Alum Rock Avenue
- (17) King Road and Alum Rock Avenue \*
- (18) Jackson Avenue and Alum Rock Avenue \*
- (19) I-680 S and Alum Rock Avenue (West) \*
- (20) I-680 N and Alum Rock Avenue (East) \*
- (21) 24<sup>th</sup> Street and San Antonio Street
- (22) King Road and East San Antonio Street
- (23) Jackson Avenue and East San Antonio Street



- (24) 24<sup>th</sup> Street and East William Street
- (25) McLaughlin Avenue and I-280 SB Ramp \*
- (26) McLaughlin Avenue and Story Road
- (27) King Road and Mabury Road

Congestion Management Program (CMP) intersections are denoted with an asterisk (\*)

## Santa Clara Station

### *Intersections*



- (28) Scott Boulevard and Central Expressway \*
- (29) Lafayette Street and Central Expressway \*
- (30) De La Cruz Boulevard and Central Expressway \*
- (31) De La Cruz Boulevard and Martin Avenue
- (32) De La Cruz Boulevard and Reed Street
- (33) Coleman Avenue and Brokaw Road
- (34) Coleman Avenue and Aviation Avenue
- (35) Coleman Avenue and Newhall Drive
- (36) Coleman Avenue and I-880 S \*
- (37) Coleman Avenue and I-880 N \*
- (38) Coleman Avenue and Hedding Street
- (39) Coleman Avenue and Taylor Street
- (40) SR 87 and Taylor Street
- (41) San Tomas Expressway and El Camino Real \*
- (42) Scott Boulevard and El Camino Real \*
- (43) Lincoln Street and El Camino Real \*
- (44) Monroe Street and El Camino Real \*
- (45) Lafayette Street and Reed Street
- (46) Lafayette Street and El Camino Real \*
- (47) Lafayette Street and Lewis Street
- (48) Lafayette Street and Harrison Street (unsignalized)
- (49) Lafayette Street and Benton Street
- (50) Lafayette Street and Homestead Road
- (51) Lafayette Street and Market Street
- (52) El Camino Real and Benton Street
- (53) El Camino Real and Railroad Avenue
- (54) El Camino Real and The Alameda \*
- (55) The Alameda and Newhall Street
- (56) The Alameda and I-880 (North) \*
- (57) The Alameda and I-880 (South) \*
- (58) The Alameda and Hedding Street \*
- (59) The Alameda and Taylor Street-Naglee Avenue \*
- (60) Homestead Road and Lincoln Street-Winchester Boulevard
- (61) Homestead Road and Monroe Street
- (62) US 101 NB Off-ramp and Trimble Road

Congestion Management Program (CMP) intersections are denoted with an asterisk (\*)

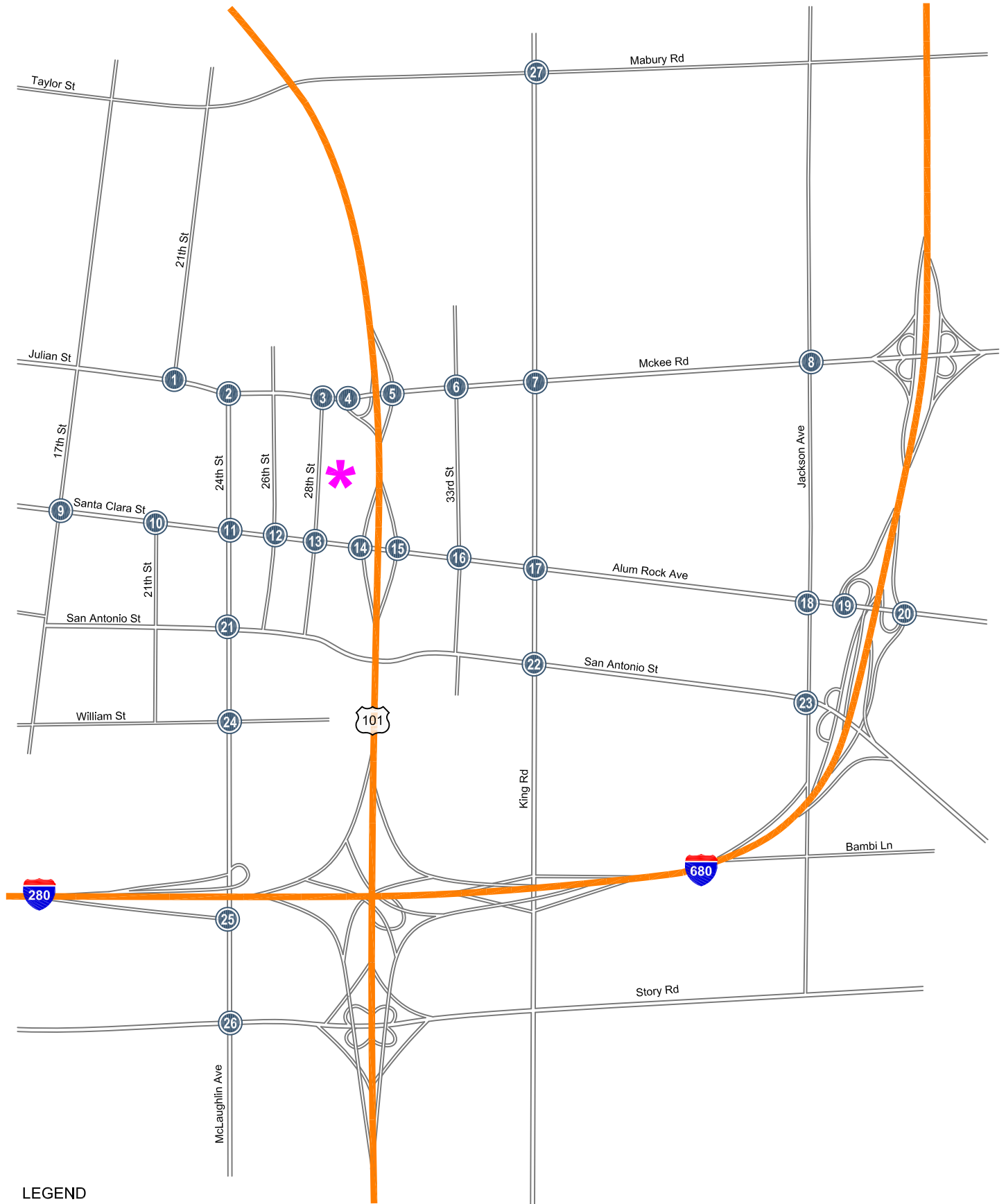
In summary, this study includes the analysis of a total of 62 intersections, of which 27 are in the vicinity of the Alum Rock/28<sup>th</sup> Street Station and 35 are in the vicinity of the Santa Clara Station. All study intersections are located within the Cities of San Jose and Santa Clara. One of the San Jose intersections (24<sup>th</sup> Street and E. Santa Clara Street, near the Alum Rock/28<sup>th</sup> Street Station) is designated as a protected intersection, under the City's Level of Service Policy, as discussed below in the section on level of service standards. A total of 22 of the study intersections have been designated as Congestion Management Program (CMP) intersections, 15 near the Alum Rock/28<sup>th</sup> Street Station and seven near the Santa Clara Station.





LEGEND

-  = Site Location
-  = Study Intersection

**Figure 5**  
**Alum Rock/28th Street BART Station Location and Study Intersections**



LEGEND

-  = Site Location
-  = Study Intersection

**Figure 6**  
**Santa Clara BART Station Location and Study Intersections**

## Freeway Segments

All freeway segments that were included in the “BART ExtensionTIA” are also included in this TIA. The 32 freeway segments (64 directional segments) included in this study are as follows:

- **US 101:** 10 segments (20 directional segments)
- **I-280:** 6 segments (12 directional segments)
- **I-680:** 4 segments (8 directional segments)
- **I-880:** 7 segments (14 directional segments)
- **SR 87:** 5 segments (10 directional segments)

## Study Time Periods

Traffic conditions at the study intersections and freeway segments were analyzed for the weekday AM and PM peak hours of traffic. The AM peak hour of traffic is typically one hour between 7:00 and 9:00 AM, and the PM peak hour is typically one hour between 4:00 and 6:00 PM. It is during these periods that the most congested traffic conditions occur on an average day.

## Study Scenarios

Traffic conditions were evaluated for the scenarios described below.

**2015 Existing Conditions.** Traffic conditions were evaluated for Existing Conditions. 2015 Existing Conditions were represented by existing peak-hour traffic volumes on the existing roadway network. Existing traffic volumes were obtained from manual turning movement traffic counts conducted in 2014 and 2015. The new counts within the City of San Jose have been reviewed and approved by the City of San Jose for use in this traffic study <sup>5</sup>. The new count data are included in Appendix B. For the freeway segments, 2015 Existing Conditions are based on data from the 2014 CMP Annual Monitoring Report.

**2025 Background Conditions.** 2025 Background traffic is defined as the conditions in the year 2025 just prior to completion of the proposed Project. 2025 Background traffic volumes at the study intersections were estimated by adding to existing peak hour volumes the projected volumes from approved but not yet completed developments. The added traffic from approved but not yet completed developments was provided by the City of San Jose in the form of the Approved Trips Inventory (ATI) dated July 22, 2015, and was provided by the City of Santa Clara in the *City of Santa Clara Approved and Pending Project List for Traffic Impact Analysis*, dated July 15, 2015. Both the San Jose ATI and Santa Clara Project List are included in Appendix C. For the freeway segments, 2025 Background Conditions were developed using VTA’s countywide Travel Demand Forecasting Model.

### **2015 and 2025 Project Conditions.**

**2015 Existing Plus Project Conditions.** At the study intersections, 2015 Existing Plus Project peak hour traffic volumes were estimated by adding to existing traffic volumes the additional traffic generated by the Project. For the study freeway segments, projected freeway volumes for the 2015 Existing Plus Project Conditions were developed by adding to existing freeway volumes the additional traffic generated by the Project. This scenario is presented for informational purposes only, in order to disclose the traffic conditions that could be expected to occur if the

---

<sup>5</sup> Email from Mr. Alex Wong, San Jose Department of Public Works, Development Services Division, dated October 1, 2015, to Mr. Brian Jackson and Mr. At van den Hout of Hexagon Transportation Consultants. See also: Signed workscope for the Phase II Project from City of San Jose Department of Public Works, Development Services Division (Appendix G).

Phase II Extension were completed and operating and all the proposed Transit-Oriented Joint Development sites were also completed and fully occupied today.

*2025 Background Plus Project Conditions.* At the study intersections, 2025 Background Plus Project Conditions peak hour traffic volumes were estimated by adding to 2025 Background traffic volumes the additional traffic generated by the Project. 2025 Background Plus Project Conditions were compared to 2025 Background Conditions in order to determine potential project impacts according to the Cities of San Jose and Santa Clara and Congestion Management Program Level of Service standards.

For the study freeway segments, 2025 Background Plus Project Conditions were developed using VTA's countywide Travel Demand Forecasting Model. The CMP criteria for significant impacts on freeways were used to determine potential project impacts on the freeway segments under Background Plus Project Conditions.

**2035 Cumulative Plus Project Conditions**<sup>6</sup>. Traffic conditions for the Year 2035 scenario were developed using VTA's countywide Travel Demand Forecasting Model, which estimates traffic volumes and transit ridership levels associated with long-term (Year 2035) cumulative conditions. This scenario evaluates traffic conditions in the year 2035 with the BART Phase I Project (Milpitas and Berryessa Stations), the addition of planned improvements identified in the Metropolitan Transportation Commission's *2040 Regional Transportation Plan*, VTA's *Valley Transportation Plan 2040*, and the list of planned roadway improvements provided by the Cities of San Jose and Santa Clara, plus the proposed Project. Model output was used to develop the projected volumes for both the study intersections and freeway segments under the Cumulative Plus Project scenario. Appropriate significant impact criteria were used from the Cities of San Jose and Santa Clara and the Congestion Management Program to determine if there would be any project impacts under this scenario,

## Methodology

This section presents the methods used to determine the traffic conditions for each scenario described above. It includes descriptions of the data requirements, the analysis methodologies, and the applicable level of service standards.

### Data Requirements

The data required for the analysis were obtained from new traffic counts, previous traffic studies, the Cities of San Jose and Santa Clara, the CMP Annual Monitoring Report, and field observations. The following data were collected from these sources:

- existing traffic volumes
- existing and planned lane configurations
- signal timing and phasing (for signalized intersections only)
- traffic volumes, average speed and density (for freeway segments under Existing Conditions)
- traffic from approved but not yet completed developments

### VTA Travel Demand Forecasting Model

This section describes the travel demand forecasting model used in this study to develop the following:

- The trip distribution and trip assignment for Project trips, for use in the 2015 Existing Plus Project, 2025 Background Plus Project, and 2035 Cumulative Plus Project scenarios,

---

<sup>6</sup> In the SEIS/SEIR that has been prepared for the Phase II Extension Project, the traffic scenarios for the year 2035 are called "2035 Forecast Year." In accordance with the City of San Jose's *TIA Handbook* and VTA's *TIA Guidelines*, however, the term "Cumulative" is used throughout this TIA and the "BART Extension TIA" when referring to 2035 conditions

- The freeway volumes used in the 2025 Background, 2025 Background Plus Project, and 2035 Cumulative Plus Project scenarios, and
- The traffic volumes at the study intersections in the 2035 Cumulative No Project and the 2035 Cumulative Plus Project scenarios.

The model chosen for use in the analysis is the VTA's 2012 PD Phase II, December 2014 Travel Demand Forecasting Model, hereafter referred to as the VTA Model. The VTA Model was developed as an extension and refinement of the Metropolitan Transportation Commission's Regional Model (MTC Model). The VTA Model relies extensively upon MTC Model structure, coding conventions, and calculation procedures. This was done to ensure consistency between the two modeling systems. The VTA Model expands on the MTC Model structure in order to provide significantly more detail and forecasting precision within and surrounding Santa Clara County.

The VTA Model also uses demographic projections that are consistent with those prepared by the Association of Bay Area Governments (ABAG). The travel forecasts developed for this project were based on ABAG *Projections 2013*. The ABAG land use and demographic projections include, among other variables, number of households, total population, employed residents and number of jobs. Table 1 shows these land use variables for Santa Clara County for the years 2015, 2025, and 2035.

**Table 1**  
**ABAG Projections for Santa Clara County**

|                    | Year      |           |           |
|--------------------|-----------|-----------|-----------|
|                    | 2015      | 2025      | 2035      |
| Households         | 640,400   | 711,200   | 781,800   |
| Population         | 1,852,700 | 2,061,100 | 2,269,700 |
| Employed Residents | 905,700   | 1,007,700 | 1,109,400 |
| Jobs               | 1,006,600 | 1,107,000 | 1,198,800 |

Source: ABAG Projections 2013

The VTA Model uses 2,654 traffic zones to represent 14 counties. These include all nine Bay Area Counties plus Santa Cruz, Monterey, San Benito, San Joaquin, and Merced Counties. Santa Clara County has been subdivided into 1,490 traffic zones in order to provide the best possible representation of travel demand for transportation planning purposes. Network features are coded "as they are or will be" based on the best available GIS mapping information.

The VTA Model represents all motorized modes of travel used within the Bay Area, including nearly 100 individual transit operators. The VTA Model also provides estimates of the change in non-motorized travel for user-defined analysis scenarios. The VTA Model's projections of roadway traffic demand include several modal stratifications, including: Single occupant autos, 2-person carpools, 3+ person carpools and trucks. Roadway traffic forecasts are available for AM and PM peak one-hour and four-hour periods, midday and night periods.

#### **Turn-Movement Adjustments for the 2035 Cumulative Scenario**

Adjustments were made to the forecasted volumes to account for the coarse turn-movements produced by the VTA Model. Although the VTA Model used for this analysis was updated to include all of the study intersections, the general regional roadway network used by the VTA Model does not represent all minor streets. The lack of coding of these minor facilities causes the VTA Model to over-assign traffic volumes to those facilities that are represented in the network. This results in inaccurate forecasted turn-movement volumes that require adjustments to calibrate them with actual travel patterns and use of proper facilities. The adjustment process begins by comparing and adjusting base model forecasts (year 2015 forecasts representing existing conditions) with existing traffic counts. By adjusting the base model forecasts with existing volumes, model projections are calibrated with actual travel patterns and use of proper facilities. Once the base model forecasts are calibrated,



future model forecasts are developed for the 2035 Cumulative study scenario. These are all considered “raw” model volume forecasts which on their own do not represent future volume conditions, but are simply used to forecast growth and travel pattern changes expected in the future.

To obtain the final traffic volume forecasts, raw model volume forecasts in conjunction with existing count data are used. Future traffic volume forecasts are developed by adding to the existing traffic count data the projected growth between the base (year 2015) and the future (year 2035) model volume forecasts. The adjustment process is outlined below:

$$\text{Existing Count} + (\text{2035 Future Forecast} - \text{2015 Forecast})$$

It should be noted that as a conservative approach, it was assumed in this analysis that, unless a major change in the roadway network or existing land use is projected for the future conditions scenario, all future model forecast volumes would be no less than the existing traffic counts.

## Traffic Volume Components for Study Intersections

Traffic volumes for the study intersections under all scenarios were derived based on existing turn-movement volumes, standard trip generation rates, project trip assignment from the VTA Model, traffic from approved but not yet completed developments provided by the Cities of San Jose and Santa Clara (for 2025 Background scenarios), and model forecasts obtained from the VTA Model (for the 2035 Cumulative scenarios). All traffic volume components utilized in the analysis of the proposed Project are summarized below (and described in more detail in the following chapters) and included in Appendix C.

**2015 Existing Conditions.** New turning-movement counts were conducted in the fall of 2014 and spring of 2015 at all of the study intersections. However, due to non-typical conditions at two of the study intersections in the fall of 2014, 2013 counts were utilized at two locations: 24<sup>th</sup> Street and East Santa Clara Street near the Alum Rock/28<sup>th</sup> Street Station and Lafayette Street and Reed Street near the Santa Clara Station <sup>7</sup>.

**2025 Background Conditions.** 2025 Background traffic volumes were estimated by adding to existing peak hour volumes the projected volumes from approved but not yet completed developments. The list of approved projects were provided by the Cities of San Jose and Santa Clara. These volumes represent traffic conditions in the year 2025 with the BART Phase I stations open, but without the proposed BART Phase II Project stations

**2015 Existing Plus Project Conditions.** Existing Plus Project conditions were estimated for informational purposes by adding the additional traffic generated by the Project to the existing traffic volumes. The Phase II net project trips include new BART Station trips, the projected change in traffic as BART users switch from passenger vehicles to BART, and trips associated with the Transit-Oriented Joint Development sites. The Phase II net project trips were assigned to the study intersections by the VTA Travel Demand Forecasting Model using the 2015 transportation network assumptions.

**2025 Background Plus Project Conditions.** 2025 Background Plus Project conditions traffic volumes were estimated by adding to background traffic volumes the additional traffic generated by the Project. These volumes represent traffic conditions in the year 2025 plus the addition of the proposed Phase II net project trips, including new Phase II BART Station trips, the projected change in background traffic as BART users switch from passenger vehicles to BART, and trips associated with the Transit-Oriented Joint Development sites. The Phase II net project trips were assigned to the study intersections by the VTA Travel Demand Forecasting Model using the 2025 transportation network assumptions.

**2035 Cumulative Conditions.** Traffic volumes for 2035 Cumulative No Project conditions and 2035 Cumulative Plus Project conditions were obtained from the VTA Model. 2035 Cumulative Plus Project volumes represent traffic conditions in the year 2035 plus the addition of the proposed Phase II net project trips, including new Phase II BART Station trips, the projected change in background traffic as BART users switch from passenger vehicles to BART, and trips associated with the Transit-Oriented Joint Development sites. The Phase II net project trips were assigned to the study intersections by the VTA Travel Demand Forecasting Model using the 2035 transportation network assumptions.

---

<sup>7</sup> At these two intersections, construction was underway at the time of the counts in Fall 2014, so the counts did not represent typical conditions. The Cities requested that earlier counts be used instead.

## Intersection Analysis Methodologies and Level of Service Standards

The Valley Transportation Authority (VTA), which is the Congestion Management Agency of Santa Clara County, requires new developments projected to generate 100 or more net peak hour trips to complete a Transportation Impact Analysis (TIA). The TIA includes an evaluation of traffic conditions with the proposed Project on the surrounding transportation network, and identifies potential impacts on the transportation network directly associated with the proposed Project. Traffic conditions are evaluated using level of service (LOS). *Level of Service* is a qualitative description of operating conditions ranging from LOS A, or free-flow conditions with little or no delay, to LOS F, or jammed conditions with excessive delays. The transportation facilities included in this analysis and the analysis methods are described below.

### Signalized Intersections

All of the signalized study intersections are located within the Cities of San Jose and Santa Clara and are therefore subject to their corresponding City's Level of Service standards. Both cities' level of service methodology is based on the *Highway Capacity Manual* (HCM) method for signalized intersections. Signalized intersection operations are evaluated using the 2000 HCM Operations Method and TRAFFIX software. The method evaluates intersection level of service (LOS) on the basis of average control delay time for all vehicles at the intersection. Since TRAFFIX is also the CMP-designated intersection level of service software, the City of San Jose and City of Santa Clara methodologies employ the CMP default values for the analysis parameters.

The City of San Jose level of service standard for signalized intersections is LOS D or better. The City of Santa Clara level of service standard is LOS D or better at all city-controlled intersections and LOS E or better at all expressway and CMP intersections. The only difference between the San Jose/Santa Clara and CMP intersection analyses is that project impacts are determined on the basis of different level of service standards – the CMP level of service standard for signalized intersections is LOS E or better. The correlation between average delay and level of service is shown in Table 2.

**Table 2**  
**Signalized Intersection Level of Service Definitions Based on Control Delay**

| Level of Service | Description   | Average Control Delay Per Vehicle (Sec.) |
|------------------|---|--|
| A                | Operations with very low delay occurring with favorable progression and/or short cycle lengths.   | Up to 10.0                               |
| B                | Operations with low delay occurring with good progression and/or short cycle lengths.   | 10.1 to 20.0                             |
| C                | Operations with average delays resulting from fair progression and/or longer cycle lengths. Individual cycle failures begin to appear.  | 20.1 to 35.0                             |
| D                | Operations with longer delays due to a combination of unfavorable progression, long cycle lengths, or high V/C ratios. Many vehicles stop and individual cycle failures are noticeable.                             | 35.1 to 55.0                             |
| E                | Operations with high delay values indicating poor progression, long cycle lengths, and high V/C ratios. Individual cycle failures are frequent occurrences. This is considered to be the limit of acceptable delay. | 55.1 to 80.0                             |
| F                | Operation with delays unacceptable to most drivers occurring due to over saturation, poor progression, or very long cycle lengths.  | Greater than 80.0                        |

Source: Transportation Research Board, 2000 Highway Capacity Manual. (Washington, D.C., 2000)



### **City of San Jose Protected Intersection Policy**

One of the intersections that is analyzed in this study, 24<sup>th</sup> Street and East Santa Clara Street near the Alum Rock/28<sup>th</sup> Street Station, is identified as a Protected Intersection in the City of San Jose's Transportation Level of Service (LOS) Policy, Council Policy 5-3. Protected Intersections consist of locations (there are a total of 25 in the City of San Jose) that have been built to their planned maximum capacity and where expansion of the intersection would have an adverse effect on other transportation facilities (such as pedestrian, bicycle, transit systems, etc.). Protected Intersections are, therefore, not required to maintain a Level of Service D, which is the City of San Jose standard. The deficiencies at all 25 Protected Intersections have been disclosed and overridden in previous EIRs.

### **Intersection Operations**

The analysis of intersection level of service is often supplemented with an analysis of intersection operations for selected intersections where the project would add a significant number of left-turning vehicles. The operations analysis is based on vehicle queuing for high-demand turning-movements at signalized intersections. Vehicle queues are estimated using a Poisson probability distribution, which estimates the probability of "n" vehicles for a vehicle movement using the following formula:

$$P(x=n) = \frac{\lambda^n e^{-\lambda}}{n!}$$

where:

P(x=n) = probability of "n" vehicles in queue per lane

n = number of vehicles in the queue per lane

$\lambda$  = Avg. # of vehicles in the queue per lane (vehicles per hr per lane/signal cycles per hr)

The basis of the analysis is as follows: (1) the Poisson probability distribution is used to estimate the 95<sup>th</sup> percentile maximum number of queued vehicles per signal cycle for a particular movement; (2) the estimated maximum number of vehicles in the queue is translated into a queue length, assuming 25 feet per vehicle; and (3) the estimated maximum queue length is compared to the existing or planned available storage capacity for the movement. This analysis thus provides a basis for estimating future left-turn storage requirements at signalized intersections.

The 95<sup>th</sup> percentile queue length value indicates that during the peak hour, a queue of this length or less would occur on 95 percent of the signal cycles. Or, a queue length larger than the 95<sup>th</sup> percentile queue would only occur on 5 percent of the signal cycles (about 3 cycles during the peak hour for a signal with a 60-second cycle length). Therefore, left-turn storage pocket designs based on the 95<sup>th</sup> percentile queue length would ensure that storage space would be exceeded only 5 percent of the time. The 95<sup>th</sup> percentile queue length is also known as the "design queue length."

### **Unsignalized Intersection**

One unsignalized intersection is being analyzed. The unsignalized study intersection, Lafayette Street and Harrison Street, is located in the City of Santa Clara and has two-way stop control. The City of Santa Clara does not have a level of service standard for unsignalized intersections. Therefore, the analysis of the unsignalized study intersection is presented for informational purposes only.

The unsignalized study intersection was analyzed using TRAFFIX software, which is based on the Highway Capacity Manual (HCM) 2000 method. This method is applicable for both two-way and all-way stop-controlled intersections. For the analysis of stop-controlled intersections, the 2000 HCM methodology evaluates intersection operations on the basis of average control delay time for all vehicles on the stop-controlled approaches. For the purpose of reporting level of service for one- and two-way stop-controlled intersections, the delay and corresponding level of service for the stop-controlled minor street approach with the highest delay is reported. The correlation between average control delay and level of service for unsignalized intersections is shown in Table 3.

### **Signal Warrant**

The level of service analysis at the unsignalized intersection is supplemented with an assessment of the need for signalization of the intersection. The need for signalization of unsignalized intersections is typically assessed based on the Peak Hour Volume Warrant (Warrant 3) described in the *California Manual on Uniform Traffic*

*Control Devices for Streets and Highways (CA MUTCD)*, Part 4, Highway Traffic Signals, 2014. This method makes no evaluation of intersection level of service, but simply provides an indication whether vehicular peak hour traffic volumes are, or would be, sufficient to justify installation of a traffic signal. The decision to install a traffic signal should not be based purely on the warrants alone. Instead, the installation of a signal should be considered and further analysis performed when one or more of the warrants are met. Additionally, engineering judgment is exercised on a case-by-case basis to evaluate the effect that a traffic signal will have on certain types of accidents and traffic conditions at the subject intersection as well as at adjacent intersections. Intersections that meet the peak hour warrant are subject to further analysis before determining that a traffic signal is necessary. Other options such as traffic control devices, signage, or geometric changes may be preferable based on existing field conditions.

**Table 3**  
**Unsignalized Intersection Level of Service Definitions Based on Control Delay**

| Level of Service | Description   | Average Control Delay Per Vehicle (sec.) |
|------------------|---|--|
| A                | Operations with very low delays occurring with favorable progression.   | Up to 10.0                               |
| B                | Operations with low delays occurring with good progression.   | 10.1 to 15.0                             |
| C                | Operations with average delays resulting from fair progression.   | 15.1 to 25.0                             |
| D                | Operation with longer delays due to a combination of unfavorable progression and high V/C ratios.   | 25.1 to 35.0                             |
| E                | Operation with high delay values indicating poor progression and high V/C ratios. This is considered to be the limited of acceptable delay. | 35.1 to 50.0                             |
| F                | Operation with delays unacceptable to most drivers occurring due to oversaturation and poor progression.                                    | Greater than 50.0                        |

Source: Transportation Research Board, *2000 Highway Capacity Manual*. (Washington, D.C., 2000)

### Freeway Segment Analysis Methodologies and Level of Service Standards

As prescribed in the CMP technical guidelines, the level of service for freeway segments is estimated based on vehicle density. Density is calculated by the following formula:

$$D = V / (N * S)$$

where:

D= density, in vehicles per mile per lane (vpml)

V= peak hour volume, in vehicles per hour (vph)

N= number of travel lanes

S= average travel speed, in miles per hour (mph)

The vehicle density on a segment is correlated to level of service as shown in Table 4.

The CMP requires that mixed-flow lanes and auxiliary lanes be analyzed separately from HOV (carpool) lanes. The CMP specifies that a capacity of 2,300 vehicles per hour per lane (vphpl) be used for segments six lanes or wider in both directions and a capacity of 2,200 vphpl be used for segments four lanes wide in both directions. The CMP defines an acceptable level of service for freeway segments as LOS E or better.

**Table 4**  
**Freeway Segment Level of Service Definitions Based on Density**

| Level of Service | Description   | Density (vehicles/mile/lane) |
|------------------|---|------------------------------|
| A                | Average operating speeds at the free-flow speed generally prevail. Vehicles are almost completely unimpeded in their ability to maneuver within the traffic stream.   | 0-11                         |
| B                | Speeds at the free-flow speed are generally maintained. The ability to maneuver within the traffic stream is only slightly restricted, and the general level of physical and psychological comfort provided to drivers is still high. | >11-18                       |
| C                | Speeds at or near the free-flow speed of the freeway prevail. Freedom to maneuver within the traffic stream is noticeably restricted, and lane changes require more vigilance on the part of the driver.                              | >18-26                       |
| D                | Speeds begin to decline slightly with increased flows at this level. Freedom to maneuver within the traffic stream is more noticeably limited, and the driver experiences reduced physical and psychological comfort levels.          | >26-46                       |
| E                | At this level, the freeway operates at or near capacity. Operations in this level are volatile, because there are virtually no usable gaps in the traffic stream, leaving little room to maneuver within the traffic stream.          | >46-58                       |
| F                | Vehicular flow breakdowns occur. Large queues form behind breakdown points.   | >58                          |

Source: Transportation Research Board, *Highway Capacity Manual (2000)*, Washington, D.C.

## San Jose General Plan Transportation Policies

The Circulation Element of the Envision San Jose 2040 General Plan includes a set of balanced, long-range, multi-modal transportation goals and policies that provide for a transportation network that is safe, efficient and sustainable (minimizes environmental, financial, and neighborhood impacts). These transportation goals and policies are intended to improve multi-modal accessibility to all land uses and create a city where people are less reliant on driving to meet their daily needs. San Jose's Transportation Goals, Policies and Actions aim to:

- Establish circulation policies that increase bicycle, pedestrian and transit travel while reducing motor vehicle trips to increase the City's share of travel by alternative transportation modes.
- Promote San Jose as a walking and bicycling-first city by providing and prioritizing funding for projects that enhance and improve bicycle and pedestrian facilities.

This TIA also provides a qualitative assessment regarding whether the Phase II BART Extension and Transit-Oriented Joint Development Project would contribute to achieving these goals.

## Santa Clara General Plan Transportation Policies

All new development projects in Santa Clara should encourage alternative modes of travel that reduce air pollution, consistent with the goals of the City's General Plan. It is the goal of the City's General Plan that all development projects accommodate and encourage the use of non-automobile transportation modes, including biking and walking, to achieve Santa Clara's mobility goals and reduce vehicle miles traveled and greenhouse gas emissions. The City of Santa Clara General Plan aims to support a coordinated regional transit system that includes BART, Amtrak, ACE, Caltrain, VTA LRT and bus services, and High Speed Rail facilities. Transit stops should be provided at safe and convenient locations to maximize ridership, including locations near employment centers and high density residential developments.

## Report Organization

The remainder of this report is divided into the following six chapters:

- Chapter 2, 2015 Existing Conditions, describes Existing Conditions in terms of the existing roadway network, transit service, and existing bicycle and pedestrian facilities. Existing lane configurations are provided for all study intersections, and the level of service for all intersections and freeway segments under Existing Conditions is presented.
- Chapter 3, 2025 Background Conditions, describes traffic operations under 2025 Background Conditions for both station areas.
- Chapter 4, 2015 and 2025 Project Conditions, describes the method used to estimate traffic associated with the proposed Project at the Alum Rock/28<sup>th</sup> Street and Santa Clara Stations. Intersection operations under both 2015 Existing Plus Project and 2025 Background Plus Project traffic conditions are presented and potential impacts are addressed. 2015 Existing Plus Project and 2025 Background Plus Project traffic conditions for all freeway segments are also analyzed.
- Chapter 5, Other Transportation Issues, discusses non-level of service issues associated with the Project, including vehicle queuing and storage at selected intersections and freeway off-ramps, freeway on-ramp meter analysis, signal warrant analysis for the unsignalized intersection, potential impacts on bicycle, pedestrian and transit facilities, site access, bus transit vehicle delay, vehicle miles traveled, and parking.
- Chapter 6, 2035 Cumulative Plus Project Conditions, presents traffic conditions and potential project impacts in the vicinity of the Alum Rock/28<sup>th</sup> Street Station and the Santa Clara Station under the Year 2035 Cumulative Plus Project Conditions.

## 2. 2015 Existing Conditions

---

This chapter describes the existing conditions for all of the major transportation facilities in the vicinity of the proposed Alum Rock/28<sup>th</sup> Street and Santa Clara BART Stations and associated Transit-Oriented Joint Development sites, including the roadway network, transit services, and bicycle and pedestrian facilities. Also included are the existing levels of service of the key intersections and freeway segments in the study area.

### Existing Roadway Network

Regional access to the Alum Rock/28<sup>th</sup> Street and Santa Clara BART Stations and associated Transit-Oriented Joint Development sites is provided by US 101, I-280, I-680, I-880 and SR 87. These facilities are described below.

**US 101** is a north-south freeway that extends northward through San Francisco and southward through Gilroy. Within the study area, US 101 is an eight-lane facility that includes two high-occupancy vehicle (HOV) lanes. During the peak commute hours, the mixed-flow lanes operate under stop-and-go conditions in the peak direction of travel—northbound in the AM and southbound in the PM. Within the HOV lane, traffic flows well, although volumes at certain locations are approaching capacity during the peak periods. US 101 would provide access to the Alum Rock/28<sup>th</sup> Street BART Station and Transit-Oriented Joint Development site via its full interchanges at East Santa Clara Street/Alum Rock Avenue and at McKee Road. US 101 would provide access to the Santa Clara BART Station and Transit-Oriented Joint Development site via its interchange at De La Cruz Boulevard.

**Interstate 280** (I-280) is generally a north-south freeway that extends from I-80 in San Francisco to US 101 in San Jose. However, in San Jose, it is oriented in an east-west direction, and transitions to I-680 at US 101. In San Jose it is an eight-lane freeway with auxiliary lanes between some interchanges. The section of I-280 just north (west) of the Bascom Avenue overcrossing has six mixed-flow lanes and two high-occupancy-vehicle (HOV) lanes. I-280 provides access to the Alum Rock/28<sup>th</sup> Street Station and associated Transit-Oriented Joint Development site via a partial interchange at McLaughlin Avenue, just west of US 101.

**Interstate 680** (I-680) is a north-south freeway that begins at US 101 in San Jose, where I-280 transitions to I-680, and ends at I-80 in Solano County. I-680 provides access to the Alum Rock/28<sup>th</sup> Street Station and associated Transit-Oriented Joint Development site via the Alum Rock Avenue and McKee Road interchanges. The section of I-680 near those interchanges is an eight-lane freeway, with four mixed-flow lanes in both directions.

**Interstate 880** (I-880) extends in a north-south direction from its junction with I-280 near Downtown San Jose northward to I-80 in Oakland. I-880 transitions to SR 17, which extends southward to Santa Cruz, at I-280. Within the study area, I-880 has six mixed-flow lanes. Near the Santa Clara Station site, the peak direction of travel is northbound during the morning commute and southbound during the afternoon commute. I-880 provides access

to the Santa Clara Station and Transit-Oriented Joint Development site via interchanges with The Alameda and Coleman Avenue.

**State Route 87** (SR 87) is primarily aligned in a north-south orientation and extends between SR 85 in south San Jose and US 101 near the San Jose International Airport. It is generally a six-lane freeway (two mixed-flow lanes plus one HOV lane in each direction) with auxiliary lanes near the I-280 interchange. A connection from SR 87 to the Santa Clara BART Station and associated Transit-Oriented Joint Development site is provided via a full interchange at Taylor Street.

Roadways providing local access to the Alum Rock/28<sup>th</sup> Street and Santa Clara BART Stations and Transit-Oriented Joint Development sites, as well as their configurations in the area of the sites, are described below:

### Alum Rock/28<sup>th</sup> Street Station

**North 28<sup>th</sup> Street** is a two-lane north-south roadway that extends from East Julian Street southward to San Antonio Street. North 28<sup>th</sup> Street provides direct access to the Alum Rock/28<sup>th</sup> Street Station site via both East Julian Street and East Santa Clara Street.

**24<sup>th</sup> Street** is a two-lane north-south roadway that extends from East Julian Street southward to E. William Street, where it changes designation to **McLaughlin Avenue**. It is called North 24<sup>th</sup> Street north of East Santa Clara Street and South 24<sup>th</sup> Street south of East Santa Clara Street. McLaughlin Avenue is a four-lane north-south roadway that begins at E. William Street and extends southward to Tuers Road, just south of Yerba Buena Road. McLaughlin Avenue provides a partial interchange with I-280.

**King Road** is a four-lane north-south roadway that extends southwards from Berryessa Road in the north (where it becomes Lundy Road) to Aborn Road (where it becomes Silver Creek Road). King Road provides an interchange with I-680.

**Jackson Avenue** is a four-lane north-south roadway that extends southwards from Berryessa Road, (where it changes designation to Flickinger Avenue) to Story Road. Jackson Avenue includes bike lanes between Alum Rock Avenue and San Antonio Street and between McKee Road and Mabury Road.

**McKee Road** is an east-west roadway with full freeway interchanges at I-680 and US 101. McKee Road extends from the foothills in East San Jose to North 28<sup>th</sup> Street (west of US 101). At North 28<sup>th</sup> Street, McKee Road becomes **East Julian Street**, which traverses westward through Downtown San Jose. McKee Road has four travel lanes between US 101 and King Road. East of King Road, McKee Road widens to six lanes. East of Jackson Avenue, it narrows back to two lanes in each direction.

**Alum Rock Avenue** is an east-west roadway with a partial cloverleaf interchange at I-680 and a diamond interchange at US 101. Alum Rock Avenue extends from Alum Rock Park near the foothills in East San Jose to US 101. At US 101, Alum Rock Avenue becomes **East Santa Clara Street**, which traverses westward through Downtown San Jose. Alum Rock Avenue consists of four travel lanes within the study area.

**San Antonio Street** is a two-lane east-west roadway that runs between San Jose State University and Capitol Expressway. It provides an overcrossing over US 101. At I-680, San Antonio Street merges into Capitol Expressway and traverses southward. San Antonio Street includes a bike lane between King Street and Jackson Street.

### Santa Clara Station

**El Camino Real** (State Route 82) is a six-lane major arterial that is oriented in an east-west direction in the vicinity of the project, extending westward from The Alameda towards the City of Sunnyvale, and then continuing northward through the peninsula to Daly City, at the northern edge of San Mateo County.

**Coleman Avenue** is four- to six-lane roadway that is oriented in a north-south direction. Coleman Avenue begins at De La Cruz Boulevard in Santa Clara and extends southward into Downtown San Jose where it becomes North Market Street at its intersection with West Julian Street. Coleman Avenue would provide access to the Santa Clara Station site via its intersection with Brokaw Road.



**Brokaw Road** is a two-lane east-west roadway that runs from Martin Avenue westward to its termination point at the railroad lines. Direct access to the proposed Santa Clara Station and Transit-Oriented Joint Development site is provided via Brokaw Road.

**De La Cruz Boulevard** is a six-lane arterial that extends from US 101 to El Camino Real. North of US 101, De La Cruz Boulevard becomes Trimble Road. The 3-way intersection of De La Cruz Boulevard and Coleman Avenue is composed entirely of ramps, after which De La Cruz extends west over the railroad tracks and El Camino Real and then transitions to Lewis Street.

**The Alameda** begins as a two-lane north-south roadway at Lewis Street near the intersection of El Camino Real and De La Cruz Boulevard and then terminates at the Santa Clara University campus. South of the campus, The Alameda re-emerges and continues to El Camino Real, where it becomes a four-lane arterial. The Alameda continues towards downtown San Jose, where it changes designation to W. Santa Clara Street.

**Lafayette Street** is a four-lane roadway that is oriented in a north-south direction. Lafayette Street extends from SR 237 southward through the City of Santa Clara to Poplar Street, where it merges with Washington Street.

**Benton Street** is a two to four-lane roadway that is oriented in an east-west direction. Benton Street extends between the Santa Clara Caltrain Station, near El Camino Real, and Lawrence Expressway. West of Lawrence Expressway, Benton Street becomes a two-lane residential street.

**Homestead Road** is an east-west two to four-lane arterial that extends between Lafayette Street in Santa Clara and Foothill Expressway in Los Altos. In the vicinity of the project, Homestead Road is a two-lane roadway, but it widens to four lanes west of San Tomas Expressway. Homestead Road includes bike lanes in both directions for its entire length.

**San Tomas Expressway** is a six to eight-lane major arterial that is oriented in a north-south direction. There is one high-occupancy-vehicle lane along San Tomas Expressway (restricted hours only) in each direction of travel. Access to the proposed Santa Clara Station site from San Tomas Expressway is provided via El Camino Real.

**Central Expressway** is a six-lane major arterial that is oriented in an east-west direction. Central Expressway begins at De La Cruz Boulevard in Santa Clara and extends to San Antonio Road in Mountain View, and then becomes Alma Street where it enters Palo Alto. In the vicinity of the project, there is one high-occupancy-vehicle lane along Central Expressway (restricted hours only) in each direction of travel.

**Hedding Street** is a four-lane, east-west street identified as an On-Street Primary Bicycle Facility in the City of San Jose's General Plan. It begins at Winchester Boulevard as a transition from Pruneridge Avenue. Hedding extends eastward to US 101, where it changes designation to Berryessa Road. Access to the Santa Clara Station site from Hedding Street is provided by Coleman Avenue.

**Taylor Street** is a two to four-lane roadway that begins at The Alameda as a transition from Naglee Avenue and extends eastward into east San Jose. Taylor Street changes designation to Mabury Road at the US 101 overcrossing. Taylor Street has four lanes in the vicinity of the Santa Clara Station site and provides full access to SR 87. Access to the project site from Taylor Street is provided by Coleman Avenue.

## Existing Pedestrian Facilities

Pedestrian facilities in the study areas consist primarily of sidewalks, crosswalks, pedestrian push buttons, and signal heads at intersections. With a few exceptions, sidewalks are found along virtually all previously described local roadways in the study areas and along the local residential streets and collectors near the station sites.

VTA is developing a Pedestrian Access to Transit Plan (anticipated adoption December 2016) to identify high-priority areas (Focus Areas) for pedestrian improvements. Several of the proposed BART stations fall within the Plan's Focus Areas. The Plan identifies specific infrastructure that could improve pedestrian comfort, safety, and convenience in these areas. Findings from field work conducted in the area are presented below.

## Alum Rock/28<sup>th</sup> Street Station

Overall, the existing network of sidewalks has good connectivity and provides pedestrians with adequate routes to the surrounding land uses and transit services near the Alum Rock/28<sup>th</sup> Street Station campus. With the exception of the west side and most of the east side of North 28<sup>th</sup> Street, between McKee Road and East Santa Clara Street, and along some of the industrial areas north of the station site, sidewalks are found along all previously described local roadways in the Alum Rock/28<sup>th</sup> Street Station study area and along the local residential streets and collectors near the station site. Additionally, all signalized intersections in the vicinity of the Alum Rock/28<sup>th</sup> Street Station have marked crosswalks on all or most of the legs of the intersection, combined with pedestrian push buttons and pedestrian signal heads.

For pedestrians who may walk between the residential neighborhood east of US 101 and the Alum Rock/28<sup>th</sup> Street BART station or between the TOJD site and VTA bus routes along King Street, there are continuous sidewalks and crosswalks along Alum Rock Avenue, including pedestrian push buttons and signal heads for the crosswalks on the US 101 on-and off-ramps, at 33<sup>rd</sup> Street, and at King Road. There are also continuous sidewalks and crosswalks along McKee Road between 28<sup>th</sup> Street and King Road, including pedestrian push buttons and signal heads for the crosswalks on the US 101 on- and off-ramps, at 33<sup>rd</sup> Street, and at King Road.

However, although the pedestrian facilities in the vicinity of the Alum Rock/28<sup>th</sup> Street Station are minimally adequate as described above, the area is not an especially pedestrian-friendly environment at present. There are locations, such as the crosswalks near the US 101 on- and off-ramps, where walking is not as comfortable as it could be. The City of San Jose plans to improve the pedestrian environment in this area through its ongoing efforts to promote greater usage of alternative modes.

## Santa Clara Station

Near the existing Santa Clara Transit Center (Caltrain Station), sidewalks are found along virtually all previously described local roadways in the study area and along the local residential streets and collectors, with the exception of the east side of Lafayette Street. Additionally, all signalized intersections in the vicinity of the Caltrain Station have marked crosswalks on all or most of the legs of the intersection, combined with pedestrian push buttons and pedestrian signal heads. However, there is less connectivity in the pedestrian facilities near the Santa Clara BART station campus, due to the Caltrain tracks, the nearby Mineta San Jose International Airport, and the fact that some of the nearby streets serving industrial land uses do not include sidewalks.

There is a continuous sidewalk along the east side of De La Cruz Boulevard that connects with the sidewalk along Coleman Avenue, leading to the intersection at Brokaw Road where the BART station would be located. However, the De La Cruz Boulevard overpass over El Camino Real and the Caltrain tracks and most portions of the interchange of De La Cruz Boulevard and Coleman Avenue do not include sidewalks. West of De La Cruz Boulevard, there is a bike and pedestrian bridge over the Caltrain tracks next to the Lafayette Street undercrossing. There is currently no convenient pedestrian access across the Caltrain tracks from the vicinity of the Santa Clara Caltrain Station to the site where the BART station and Transit-Oriented Joint Development project would be located. However, a pedestrian undercrossing from the Caltrain center platform to Brokaw Road is under construction and planned to be completed in mid-2017.

## Existing Bicycle Facilities

There are several bicycle facilities near each of the station campuses. As defined by the California Department of Transportation (Caltrans), bicycle facilities include Class I bikeways (defined as bike paths off street, which is shared with pedestrians and excludes general motor vehicle traffic), Class II bikeways (defined as striped bike lanes on street), Class III bike routes (defined as roads with bike route signage where bicyclists share the road with motor vehicles), and Class IV cycle tracks (bike lanes physically separated from vehicle traffic by a vertical element). Streets may be rated as high caution (heavy traffic volumes with high traffic speeds), alert (moderate traffic volumes and speeds), and moderate (low traffic volumes and moderate to low traffic speeds). With the exception of limited access highways, bicyclists are allowed to ride on any roadway, even if there is no bicycle facility present.



In Santa Clara County, bicycle facilities are typically constructed and maintained by local jurisdictions. Bikeways that serve the stations fall within City of San Jose, the City of Santa Clara, and Santa Clara County jurisdictions, and are maintained by the agencies. .

The *Santa Clara Countywide Bicycle Plan*, adopted by VTA in August 2008, identifies various existing and/or planned cross county bicycle corridors in the vicinity of the proposed BART Stations. The purpose of the Cross County Bicycle Corridors, as described in the above document, is to provide continuous connections between Santa Clara County jurisdictions and to adjacent counties, and to serve the major regional trip-attractors in the County. The cross county bicycle corridors serving the station areas are discussed below.

Bicycle facilities in the area of each of the stations are presented in Figures 7 and 8 and described below.

### **Alum Rock/28<sup>th</sup> Street Station**

The Alum Rock/28<sup>th</sup> Street Station site is moderately accessible by bicycle. The station site is surrounded by bicycle facilities, but none provide a direct connection to the site. Class II bike lanes are provided on Mabury Road, 21<sup>st</sup> Street, portions of San Antonio Street, and Jackson Avenue. There are no Class I bikeways that serve the station area. The streets near the station site, Santa Clara Street/Alum Rock Avenue and McKee Road, are identified as “high caution” roads in VTA’s Bikeways Map (May 2016).

Access to the station site from the east is constrained by U.S. Highway 101 (U.S. 101); the closest freeway crossings to the site are at McKee Road and Alum Rock interchanges. Neither are designed well for bicyclists. Access from the west is constrained by Coyote Creek; bicyclists may cross Coyote Creek on Julian Street (identified as “Alert” in VTA’s Bikeways Map), Santa Clara Street (“High Caution”), or San Antonio Street. None of these roads have bike lanes, and only San Antonio Street is designated as a Class III bike route. No nearby bicycle facilities connect from the north. From the south, there are bicycle lanes on 24<sup>th</sup> Street; however, these stop half a mile before the station, and bicyclists traveling on 24<sup>th</sup> Street must bike through an interchange with I-280.

VTA’s 2008 Santa Clara Countywide Bicycle Plan identifies San Antonio Street as a Cross County Bicycle Corridor (CCBC). This is the closest CCBC to the Alum Rock/28<sup>th</sup> Street Station Site.

The Countywide Bicycle Plan identifies the interchange of Julian Street/McKee Road and U.S. 101, and Santa Clara Street over U.S. 101 as “Across Barrier Connections” needing bicycle improvements.

There are no nearby Bay Area Bikeshare stations.

The City of San Jose’s planned Coyote Creek Trail will complete a Class I bikeway along Coyote Creek between Milpitas (Dixon Landing Road) and Coyote Lake in the South County. Currently, bicycle facilities along this corridor are missing between Montague Expressway and Tully Road and Anderson Lake County Park and Coyote Lake County Park. Coyote Creek runs west of the Alum Rock/28<sup>th</sup> Street Station.

### **Santa Clara Station**

The existing Santa Clara Transit Center (Caltrain Station) is difficult to access by bicycle, particularly from the north, east, and south, and the proposed Santa Clara BART Station would also be difficult to access under existing conditions. A Class III bicycle route on Benton Street provides direct access to the existing Santa Clara Transit Center (Caltrain station), from the west. No other bicycle facilities directly serve the station. Within two-thirds of a mile of the station, Class II bikeways are provided on Monroe Street, Homestead Road, and portions of Coleman Avenue, the Alameda, Poplar Street, Market Street, and Bellomy Street, and a Class III bike route is provided on Park Avenue. Santa Clara University, located adjacent to the existing Santa Clara Transit Center, includes some disconnected Class I bikeways.

De La Cruz Avenue and Coleman Avenue are identified on VTA’s Countywide Bicycle Map as “High Caution” streets. The section of El Camino Real adjacent to the Caltrain station is identified as an “Alert” street.

Bicycle access is constrained by the rail lines, the Mineta San Jose International Airport, I-880, U.S. 101, SR 87, and the Guadalupe River. Bicyclists wishing to access the station from these directions must travel through high-stress freeway interchanges and major roadway intersections. East of the station site is the Guadalupe River Trail system, extending between Alviso and South San Jose. Although the Guadalupe River Trail is a mile to the east, there are no low-stress connections to the trail from the Santa Clara Station. There is no wayfinding signage





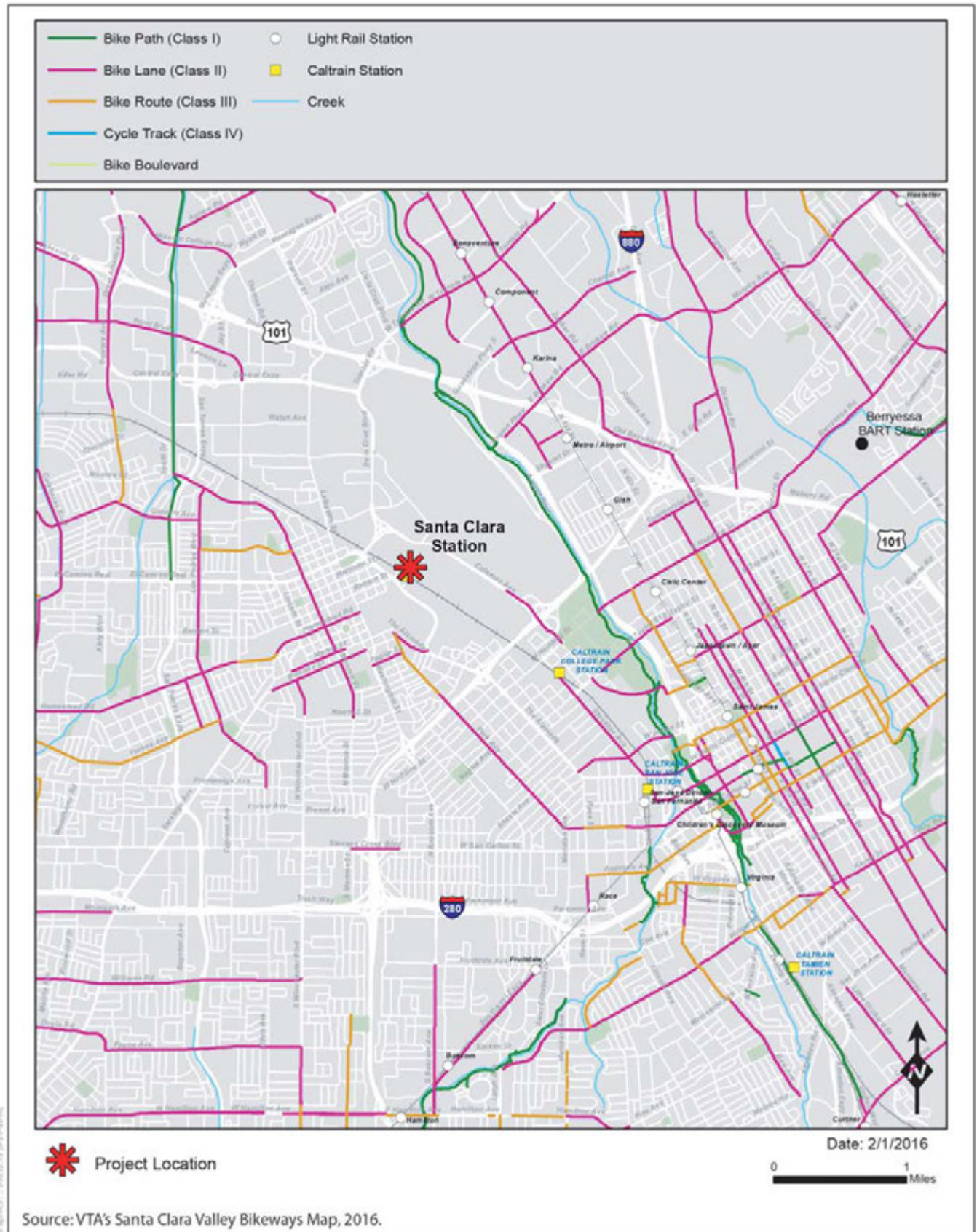

**Figure 8**  
Existing Bicycle Facilities - Santa Clara Station Area

directing bicyclists to the Guadalupe River Trail from the Santa Clara Station. Further from the Santa Clara Station site, the San Tomas Aquinas Creek Trail is a Class I bike trail that is west of the San Tomas Expressway and extends north to SR 237, near the San Francisco Bay.

Within the vicinity of the station site, VTA's 2008 Santa Clara Countywide Bicycle Plan identifies the following streets or trails as "Cross County Bicycle Corridors": Coleman Avenue, Brokaw Road, El Camino Real/The Alameda, Benton Street, Monroe Street, Park Avenue, Hedding Street, Airport Boulevard, and the Guadalupe River Trail. The Countywide Bicycle Plan identifies the following locations as places where bicycle crossing improvements need to be made: The Alameda/880 Interchange, and the railroad crossing of De La Cruz/El Camino Real/Lewis Street. The Countywide Bicycle Plan identifies the need for a new bicycle/pedestrian bridge or undercrossing of the Caltrain Union Pacific Railroad tracks between De La Cruz Boulevard and Hedding Street. VTA is currently working on the design and construction of a bicycle/pedestrian undercrossing of the tracks at the Santa Clara Caltrain Station.

Bike lockers are provided at the existing Santa Clara Transit Center. There are no Bay Area Bikeshare Stations in the vicinity.

## Existing Transit Services

Existing transit services in the station areas are provided by VTA, ACE, Amtrak, and Caltrain. The transit services are described below and shown on Figures 9 and 10.

### VTA Bus Service (Alum Rock/28<sup>th</sup> Street and Santa Clara Stations)

The station areas are served directly by several local bus routes. Table 5 presents the VTA bus lines, service terminus points, and headway times during commute hours for the Alum Rock/28<sup>th</sup> Street and Santa Clara BART Station/TOJD sites. The weekday hours of operation are approximate, and are based on the schedule point that is nearest to each project site.

**Table 5**  
**Existing Weekday VTA Bus Service**

| Bus Lines   | Route Description  | Commuter Hour<br>Headways<br>(min) | Weekday Hours of<br>Operation |
|---|--|------------------------------------|-------------------------------|
| <b><u>VTA Bus Routes Near Alum Rock Station</u></b>           |  |                                    |                               |
| Local Route 12  | San Jose Civic Center to Eastridge Transit Center          | n.a.                               | weekends only                 |
| Local Route 22  | Eastridge Transit Center to Palo Alto Transit Center       | 12                                 | 4:00am - 3:00am               |
| Local Route 23  | De Anza College to Alum Rock Transit Center                | 12                                 | 5:30am - 1:00am               |
| Local Route 64  | Almaden LRT Station to McKee & White                       | 15                                 | 5:30am - 11:00pm              |
| Local Route 77  | Eastridge Transit Center to Great Mall/Main Transit Center | 15                                 | 6:00am - 9:30pm               |
| Express Route 522   | Eastridge Transit Center to Palo Alto Transit Center       | 15                                 | 5:00am - 10:30pm              |
| <b><u>VTA Bus Routes Near Santa Clara Station</u></b>         |  |                                    |                               |
| Shuttle Route 10  | Santa Clara Transit Center to Metro Airport LRT Station    | 15                                 | 5:00am - 11:30pm              |
| Local Route 22  | Eastridge Transit Center to Palo Alto Transit Center       | 12                                 | 4:00am - 3:00am               |
| Local Route 32  | San Antonio Shopping Center to Santa Clara Transit Center  | 30                                 | 6:00am - 7:30pm               |
| Local Route 60  | Winchester Transit Center to Great America                 | 15                                 | 6:00am - 10:30pm              |
| Local Route 81  | San Jose State University to Vallco                        | 30                                 | 6:30am - 8:30pm               |
| Express Route 304   | South San Jose to Sunnyvale Transit Center                 | 30                                 | peak periods only             |
| Express Route 522   | Eastridge Transit Center to Palo Alto Transit Center       | 15                                 | 5:00am - 10:30pm              |
| Source: VTA Santa Clara Valley Bus and Rail Map, October 2015 |  |                                    |                               |



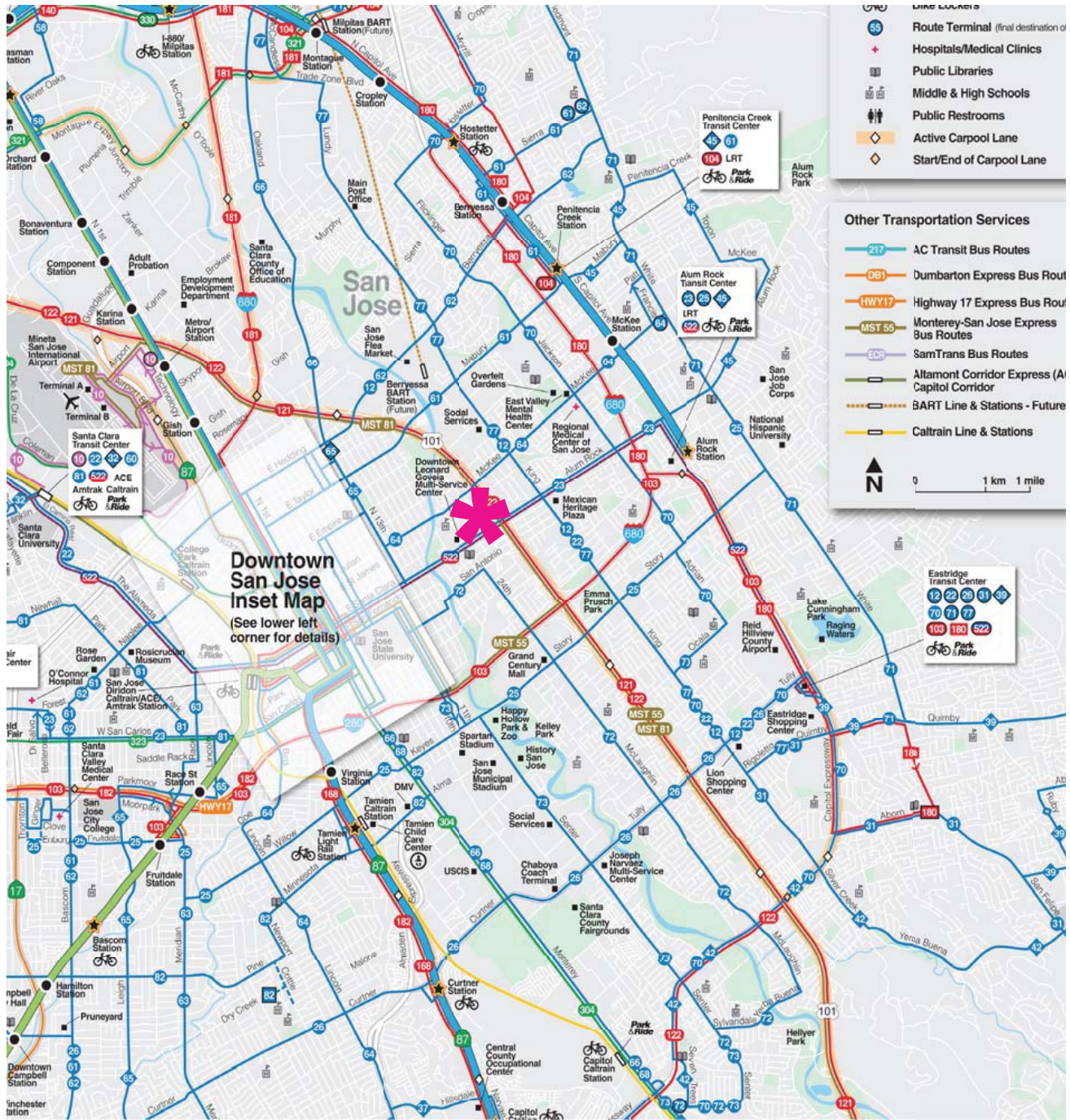
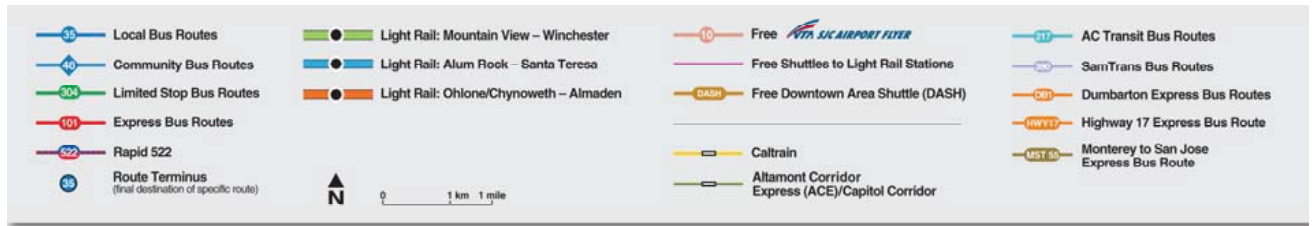

= Project Location

Effective January 2015

**Figure 9**  
**Existing Transit Services - Alum Rock Station Area**



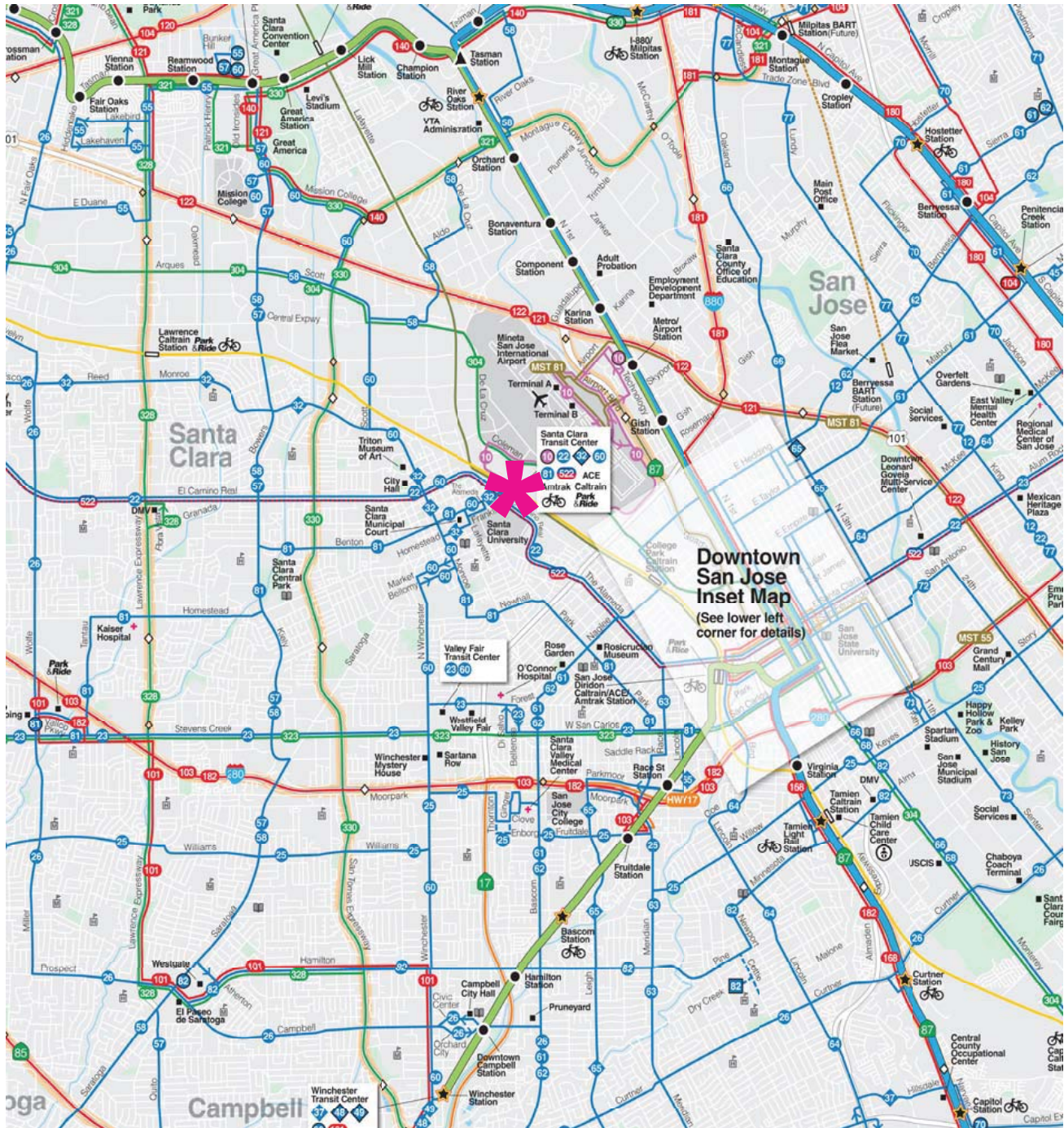

= Project Location

Effective January 2015

**Figure 10**  
**Existing Transit Services - Santa Clara Station Area**

Near the Alum Rock/28<sup>th</sup> Street Station/TOJD site, Routes 22, 23, and 522 run along Santa Clara Street and Alum Rock Avenue. Route 64 runs along Julian Street and McKee Road just north of the project site. Approximately 0.65 miles away from the project site, Routes 12 and 77 provide service on King Road. Route 12 operates only on weekends and holidays, with 30 minute headways all day.

Near the Santa Clara Station/TOJD site, the Free Airport Flyer (Route 10) provides shuttle service from the Santa Clara Transit Center to the Metro Airport LRT Station via the San Jose International Airport with approximately 15-minute headways during the commute hours. Local routes 22, 32, 60, and 81 and Express route 522 all serve the Santa Clara Transit Center. Express route 304 serves Coleman Avenue and De La Cruz Boulevard and only operates in the northbound direction during the AM peak period and in the southbound direction during the PM peak period.

### **Caltrain Service (Santa Clara Station)**

Caltrain operates a commuter rail service seven days a week between San Jose and San Francisco. During weekday commuting hours, Caltrain also serves the south county, including Gilroy, San Martin and Morgan Hill. In addition, there are numerous shuttle services between Caltrain stations and businesses in Silicon Valley and on the Peninsula.

The existing Santa Clara Caltrain/ACE Station (located at Railroad Avenue and El Camino Real) is located on the opposite side of the rail tracks near the proposed Santa Clara BART Station site. Caltrain provides limited stop and local service to the Santa Clara Station, with approximately 30-minute headways during commute hours. The Santa Clara Caltrain Station provides service to the Santa Clara area via connections with VTA bus lines 22, 32, 60, and 81, rapid bus route 522, shuttle bus route 10, and ACE/Amtrak connections.

### **ACE Service (Santa Clara Station)**

The Altamont Commuter Express (ACE) provides commuter rail service between the Central Valley and Silicon Valley. Four trains are in operation during weekday commuting hours with westbound trains heading to San Jose in the morning and eastbound trains heading to Stockton in the evening. ACE Stations are located at the Santa Clara Transit Center and the Diridon Transit Center. Shuttle service from the stations to employment centers are provided by various public transit agencies.

### **Amtrak Capital Corridor Rail Service (Santa Clara Station)**

Amtrak provides intercity passenger rail service between Auburn in Placer County and San Jose. There are seven round trips between Sacramento and San Jose on weekdays and weekends. An additional eight round trips operate only between Sacramento and Oakland. There is one round trip per day that serves Auburn. The trains share the Diridon Caltrain Station and the Santa Clara Caltrain Station facilities. The train stops at the Santa Clara Caltrain Station near the proposed BART Station/TOJD Development site. In addition, Amtrak provides a daily Coast Starlight line from Los Angeles to Seattle.

## **Existing Intersection Lane Configurations**

The existing lane configurations at the study intersections were determined by observations in the field. Figures 11 and 12 present existing lane configurations for the Alum Rock/28<sup>th</sup> Street and Santa Clara Stations study intersections.

## **Existing Traffic Volumes**

Existing AM and PM peak hour traffic volumes at most study intersections were obtained from manual turning-movement counts conducted in the fall of 2014 and the spring of 2015. In general, the fall 2014 counts were conducted for the intersections that were also included in the "BART Extension Only TIA". The spring 2015 counts were conducted for the intersections that were added to this TIA because they were expected to experience traffic related to the Transit-Oriented Joint Development portion of the project. However, at two intersections where counts were conducted in fall of 2014, 2013 counts were used because construction was underway at the time of the counts, and the 2014 volumes did not represent typical conditions. These two intersections are 24<sup>th</sup> Street and



E. Santa Clara Street (#3 near the Alum Rock/28th Street site) and Lafayette Street and Reed Street (#45 near the Santa Clara site).

VTA provides existing PM peak hour traffic volumes for CMP-designated intersections. For all CMP-designated intersections in this study, counts were conducted only during the AM peak hour and volumes for the PM peak hour were obtained from the CMP database.

All new traffic counts for intersections within the City of San Jose are compared against historical count data for consistency and accuracy and incorporated into the City of San Jose's traffic volume database, if approved by the City. The purpose of the database is to provide consistent traffic volumes within similar timeframes and areas for all projects requiring traffic analysis. This ensures the base traffic conditions are the same for all projects. All new count data for intersections within the City of San Jose have been reviewed and approved by the City.<sup>8</sup>

Existing peak-hour traffic volumes are shown on Figures 13 and 14. New count data conducted for this TIA (spring 2015 counts) are included in Appendix B.

---

<sup>8</sup> Email from Mr. Alex Wong, San Jose Department of Public Works, Development Services Division, dated October 1, 2015, to Mr. Brian Jackson and Mr. At van den Hout of Hexagon Transportation Consultants. See also: Signed workscope (dated October 10, 2015) for the Phase II Project from City of San Jose Department of Public Works, Development Services Division (included as Appendix G).



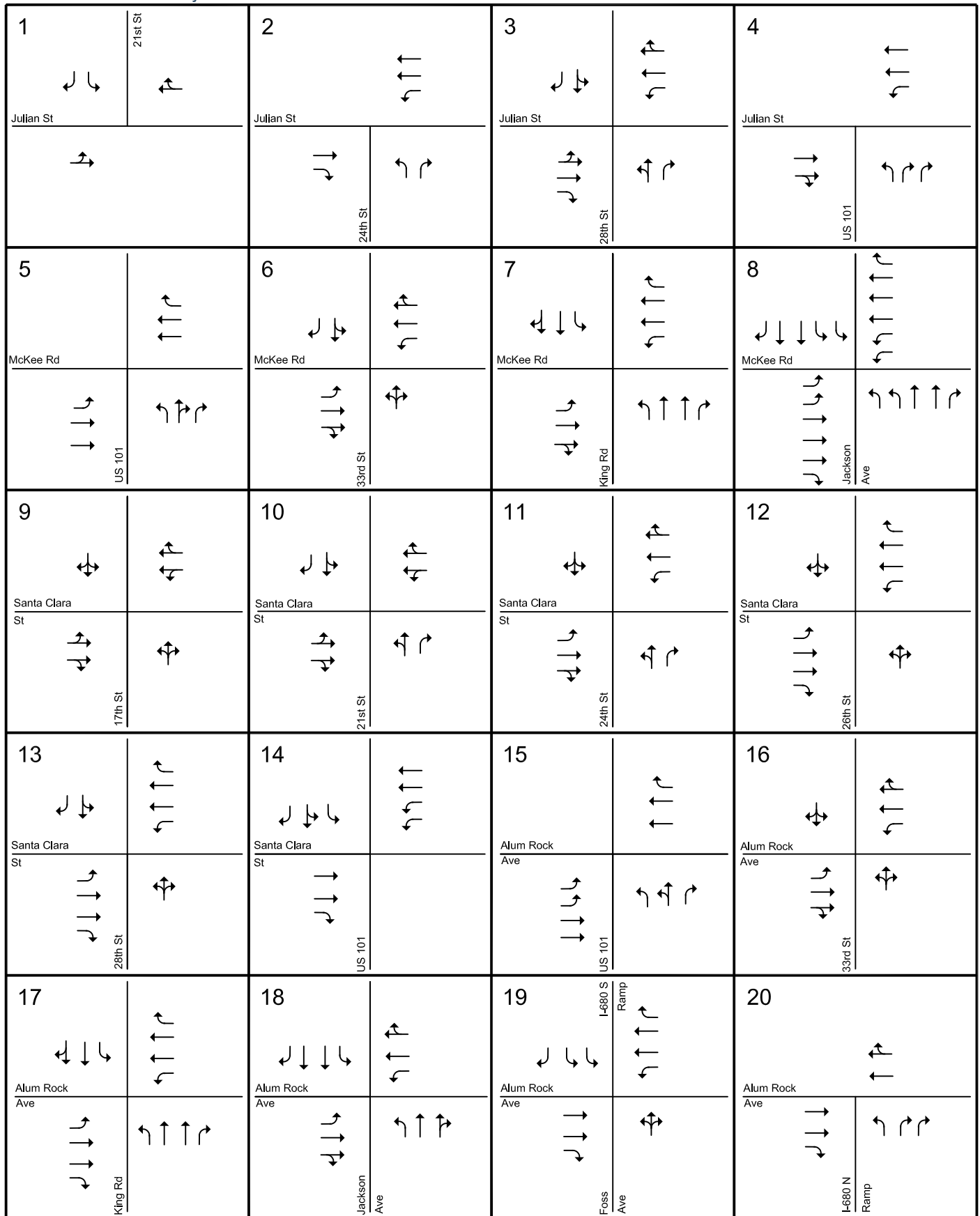

**Figure 11**  
**Existing Intersection Lane Configurations - Alum Rock/28th Street Station**

Phase II Extension Project TIA

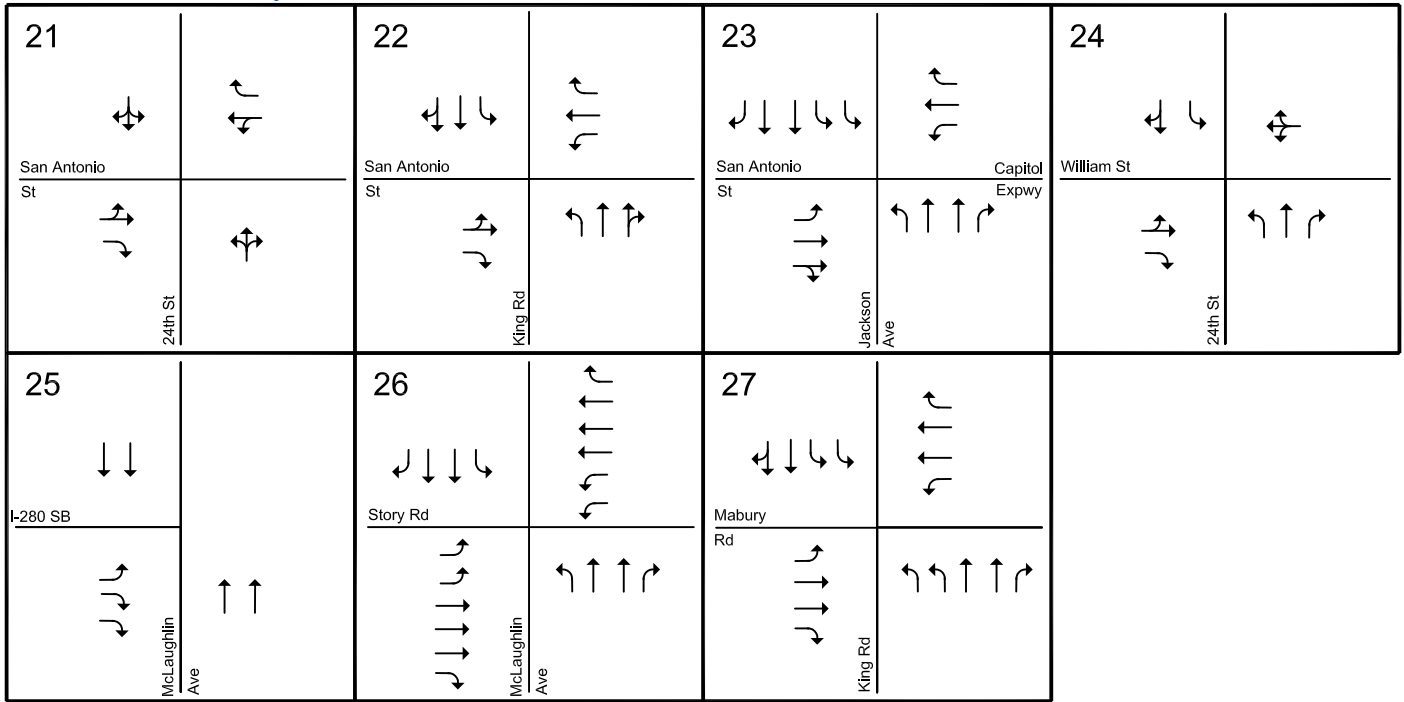

Figure 11  
Existing Intersection Lane Configurations - Alum Rock/28th Street Station

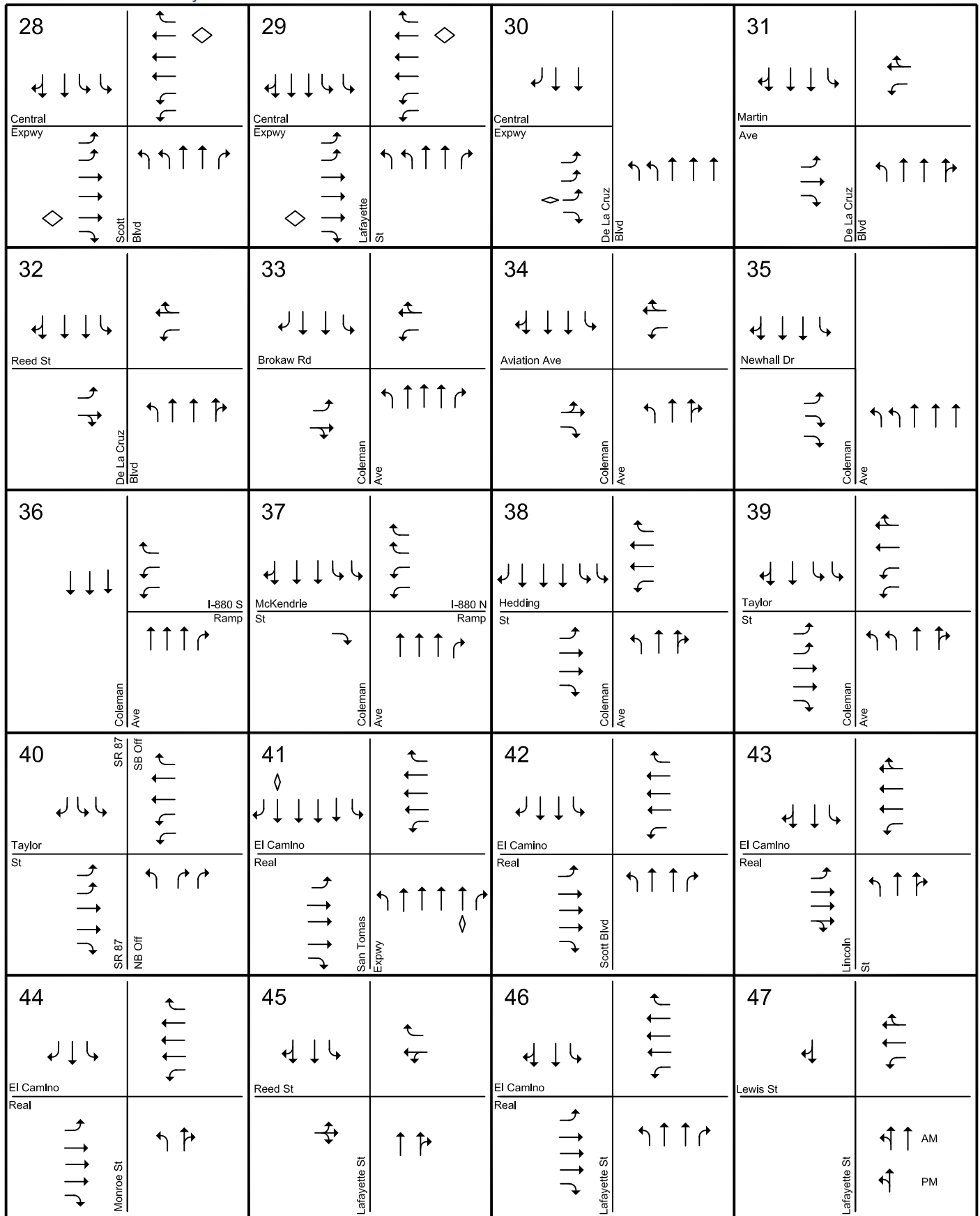

Figure 12  
Existing Intersection Lane Configurations - Santa Clara Station

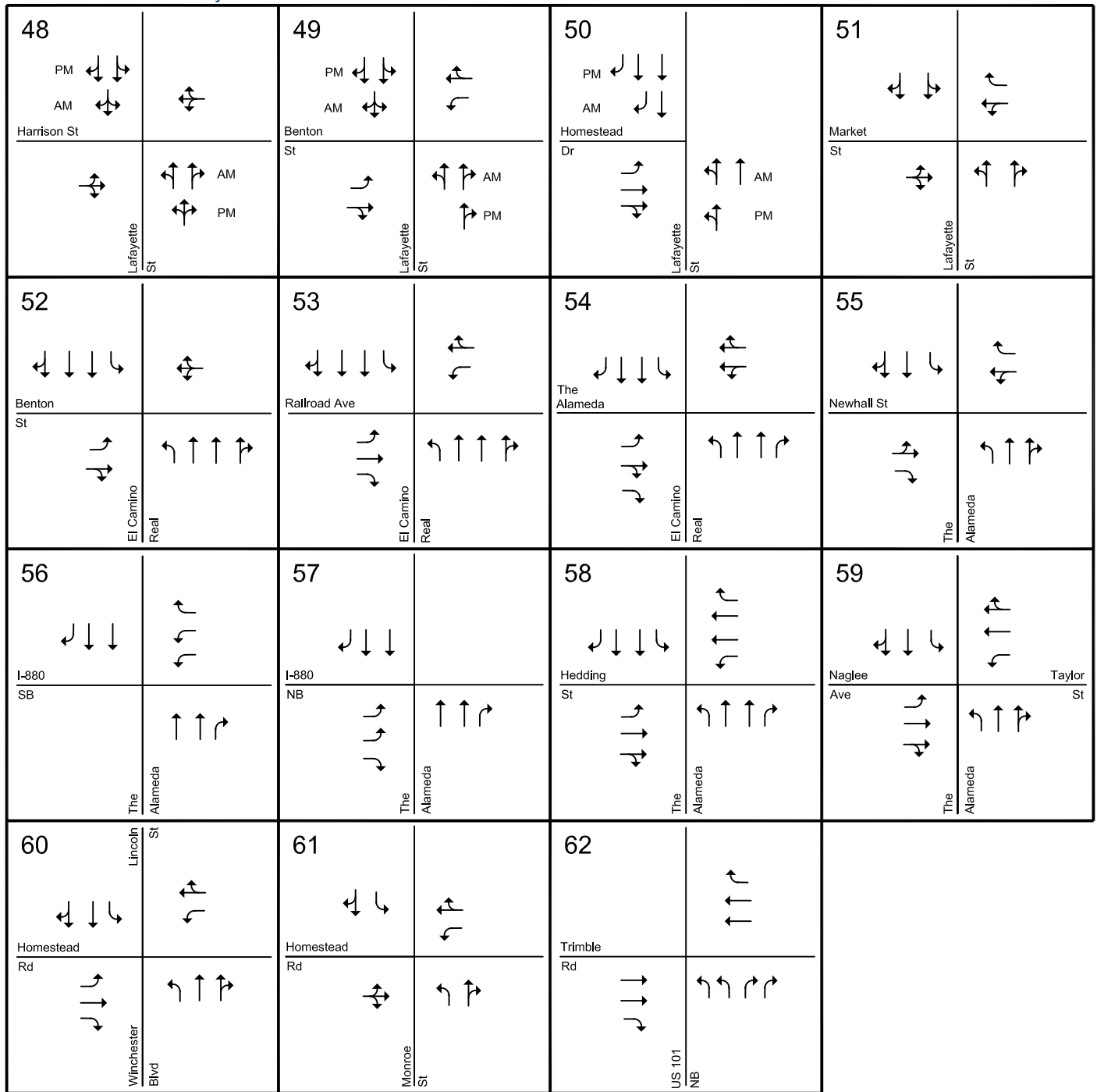
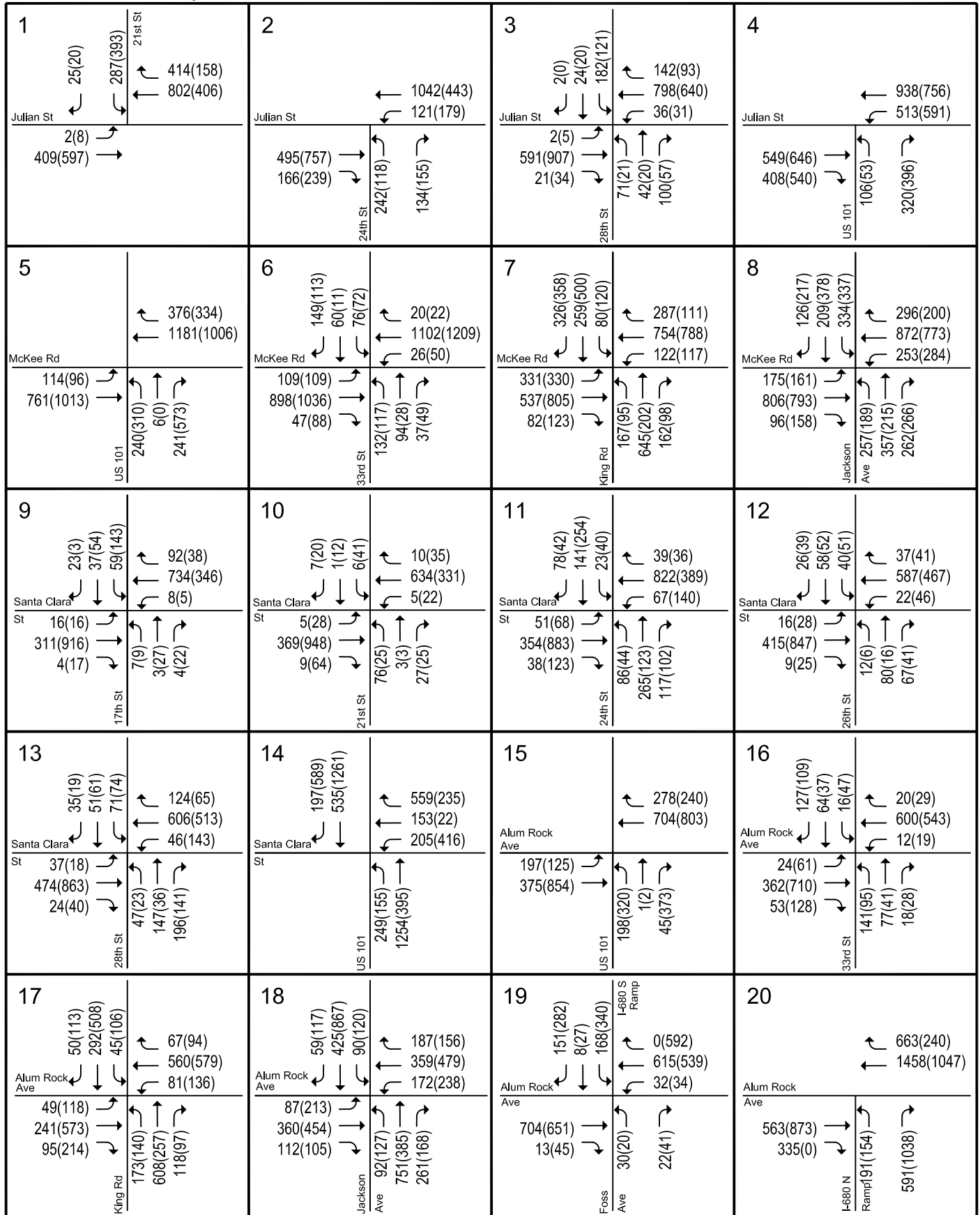

Figure 12  
Existing Intersection Lane Configurations - Santa Clara Station



LEGEND

XX(XX) = AM(PM) Peak-Hour Traffic Volumes

Figure 13  
Existing Traffic Volumes - Alum Rock/28th Street Station

Phase II Extension Project TIA

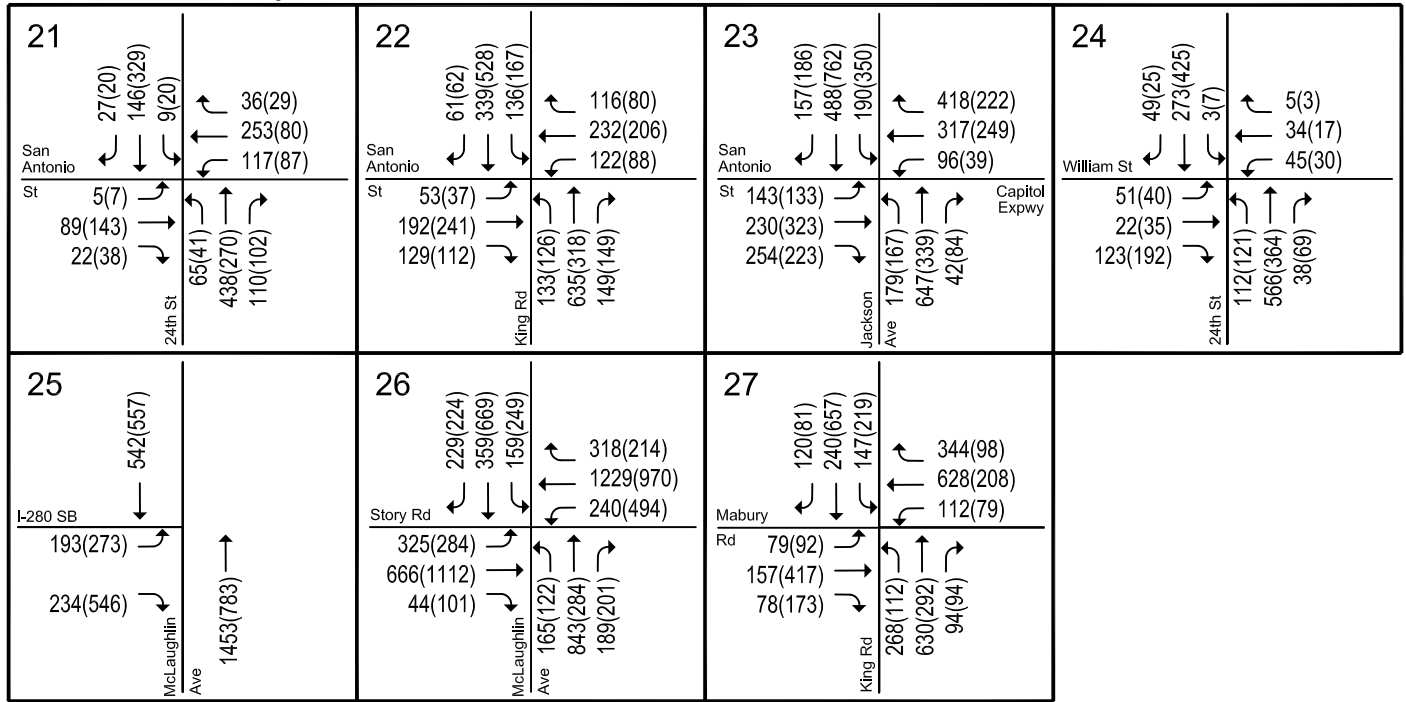

LEGEND

XX(XX) = AM(PM) Peak-Hour Traffic Volumes

Figure 13  
Existing Traffic Volumes - Alum Rock/28th Street Station

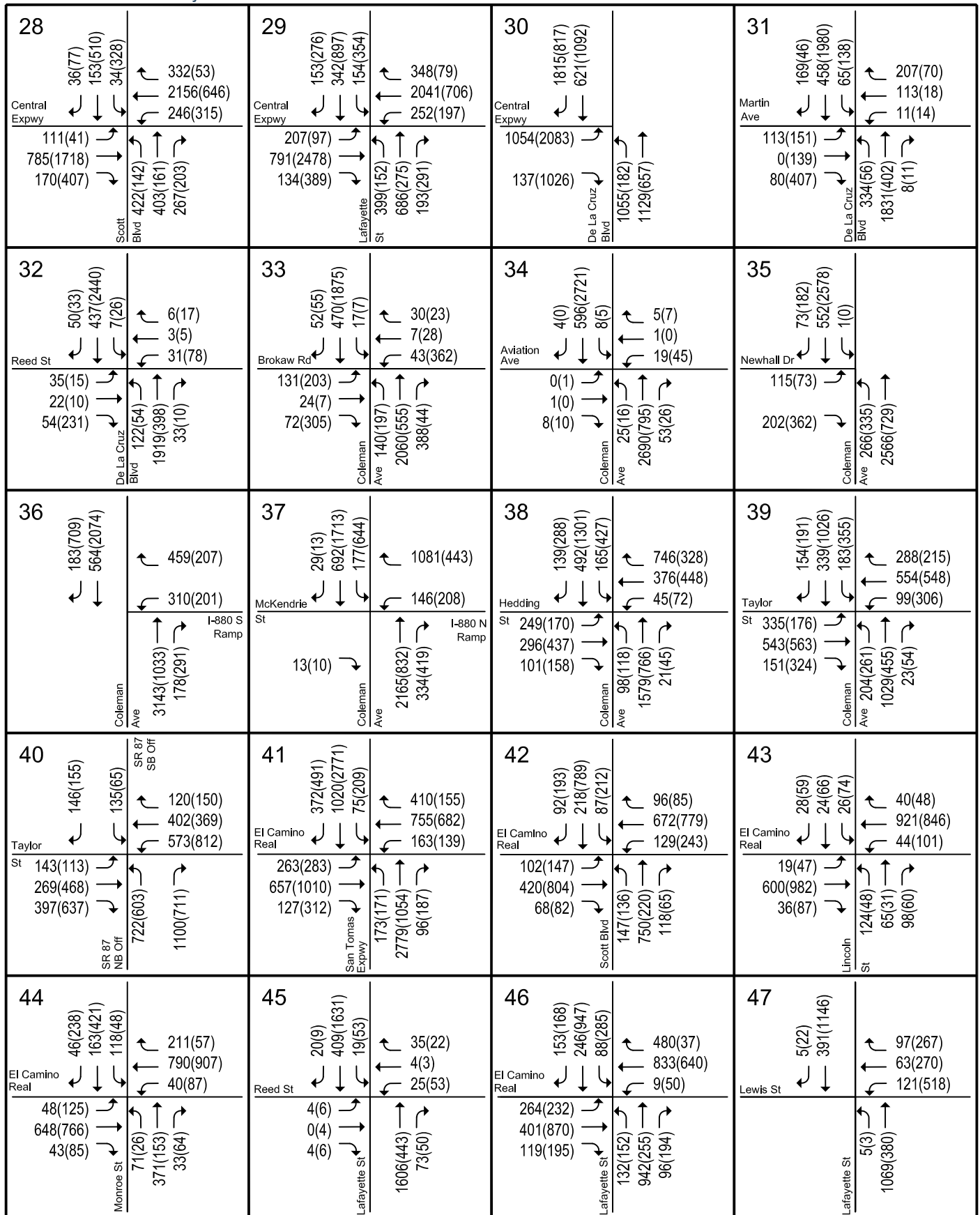

LEGEND

XX(XX) = AM(PM) Peak-Hour Traffic Volumes

Figure 14  
Existing Traffic Volumes - Santa Clara Station



Phase II Extension Project TIA

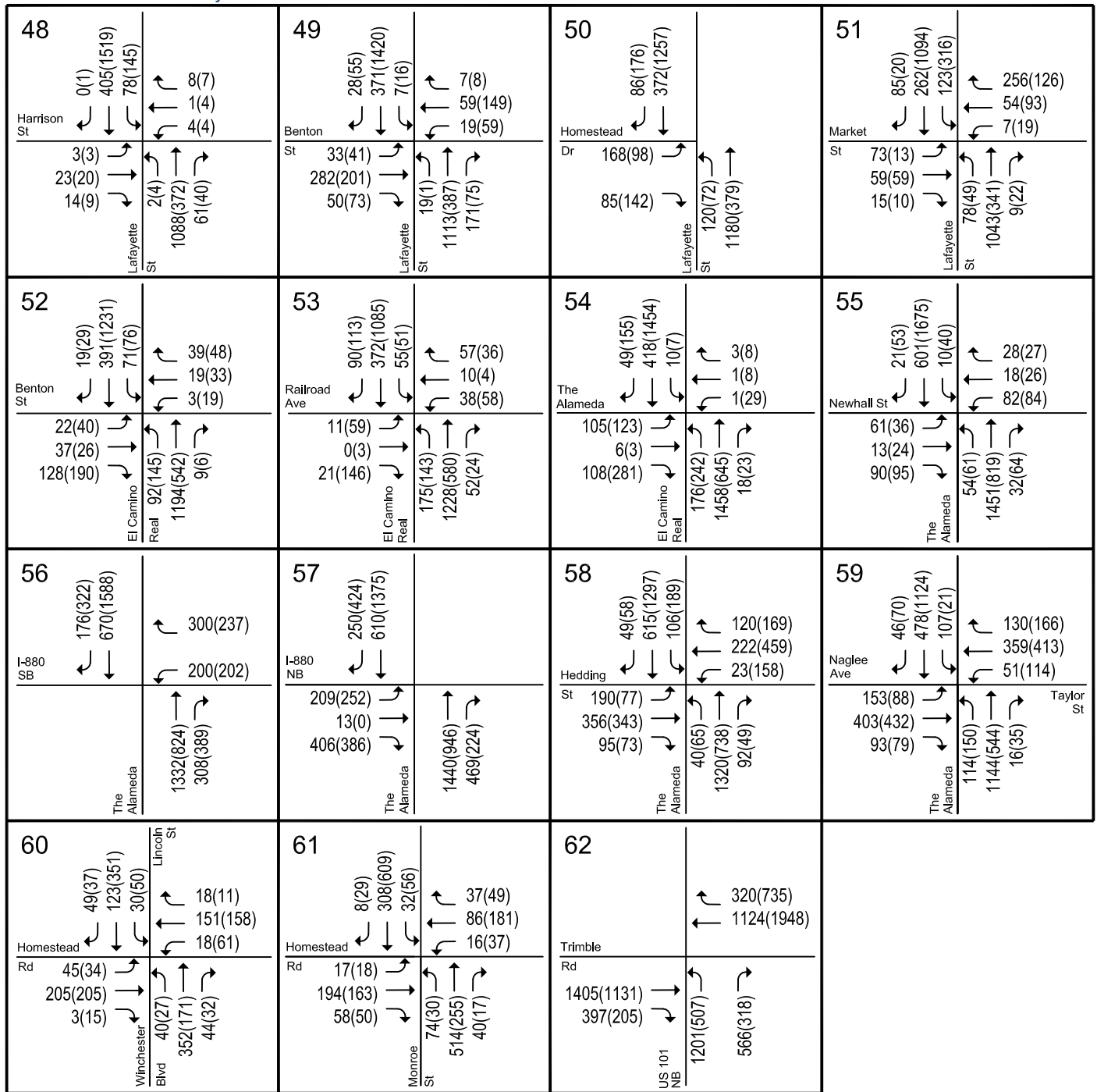

LEGEND

XX(XX) = AM(PM) Peak-Hour Traffic Volumes

Figure 14  
Existing Traffic Volumes - Santa Clara Station

## Intersection Levels of Service under 2015 Existing Conditions

Intersection levels of service under 2015 Existing Conditions were evaluated against City of San Jose, City of Santa Clara, and CMP standards. As described in Chapter 1, the traffic volumes analyzed for the 2015 Existing Conditions scenario do not include Project-generated trips. These level of service results are used as a basis of comparison with the 2015 Existing Plus Project scenario in Chapter 4. The intersection level of service calculation sheets are included in Appendix E.

### Alum Rock/28<sup>th</sup> Street Station

The results of the level of service analysis under 2015 Existing Conditions for the Alum Rock/28<sup>th</sup> Street Station are summarized in Table 6. All of the study intersections in the vicinity of the Alum Rock/28<sup>th</sup> Street Station are located in the City of San Jose.

#### City of San Jose Level of Service Analysis

The results of the level of service analysis show that, measured against the City of San Jose level of service policy, all of the study intersections in the vicinity of the Alum Rock/28<sup>th</sup> Street Station currently operate at an acceptable level of service (LOS D or better) during both the AM and PM peak hours of traffic.

#### CMP Level of Service Analysis

The results of the level of service analysis show that, measured against the CMP level of service standards, all of the CMP study intersections in the vicinity of the Alum Rock/28<sup>th</sup> Street Station currently operate at an acceptable level of service (LOS E or better) during both the AM and PM peak hours of traffic.

### Santa Clara Station

The results of the level of service analysis under 2015 Existing Conditions for the Santa Clara Station are summarized in Table 7. Of the 35 study intersections in the vicinity of the Santa Clara Station, 22 are located in the City of Santa Clara and 13 are located in the City of San Jose.

#### City of San Jose Level of Service Analysis

The results of the level of service analysis show that, measured against the City of San Jose level of service policy, all of the study intersections in the vicinity of the Santa Clara Station that are located within San Jose currently operate at an acceptable level of service (LOS D or better) during both the AM and PM peak hours of traffic.

#### City of Santa Clara Level of Service Analysis

The results of the level of service analysis show that, measured against the City of Santa Clara level of service standards, all except two of the study intersections in the vicinity of the Santa Clara Station that are located within Santa Clara currently operate at an acceptable level of service (LOS D or better at local intersections and LOS E or better at expressway and CMP intersections) during both the AM and PM peak hours of traffic. The following two intersections operate at unacceptable levels of service (LOS E or worse for local intersections and LOS F for expressways and CMP intersections) during at least one peak hour:

- (#30) De La Cruz Boulevard and Central Expressway \* (LOS F – AM and PM peak hours)
- (#33) Coleman Avenue and Brokaw Road (LOS F – PM peak hour)

The unsignalized intersection of Lafayette Street and Harrison Street (#48) has two-way stop control. The level of service shown for this intersection on Table 7, LOS E in the AM and LOS F in the PM peak hours, reflects the delay and the level of service for the stop-controlled approach with the highest delay, not the average of the entire intersection. Because the City of Santa Clara does not have a level of service standard for unsignalized intersections, this intersection cannot be said to operate at an unacceptable level of service. The level of service

**Table 6**  
**Existing Intersection Levels of Service – Alum Rock/28<sup>th</sup> Street Station Area**

| Study Number | Intersection                                 | Peak Hour | Count Date | Avg. Delay (sec.) | LOS      |
|--------------|--|-----------|------------|-------------------|----------|
| 1            | 21st St & E. Julian St                       | AM        | 10/09/14   | 23.2              | C        |
|              |  | PM        | 10/09/14   | 12.7              | B        |
| 2            | 24th St & E. Julian St                       | AM        | 10/09/14   | 17.2              | B        |
|              |  | PM        | 10/09/14   | 17.1              | B        |
| 3            | N. 28th St & E. Julian St                    | AM        | 04/09/15   | 27.2              | C        |
|              |  | PM        | 04/09/15   | 14.2              | B        |
| 4            | US 101 SB ramps & E. Julian St               | AM        | 10/09/14   | 23.1              | C        |
|              |  | PM        | 10/09/14   | 26.8              | C        |
| 5            | US 101 NB ramps & McKee Rd                   | AM        | 10/09/14   | 22.1              | C        |
|              |  | PM        | 10/09/14   | 26.9              | C        |
| 6            | 33rd St & McKee Rd                           | AM        | 05/21/15   | 35.4              | D        |
|              |  | PM        | 05/20/15   | 29.7              | C        |
| 7            | King Rd & McKee Rd                           | AM        | 10/09/14   | 46.8              | D        |
|              |  | PM        | 10/08/14   | 47.2              | D        |
| 8            | Jackson Ave & McKee Rd                       | AM        | 05/21/15   | 39.3              | D        |
|              |  | PM        | 05/20/15   | 39.9              | D        |
| 9            | 17th St & E. Santa Clara St                  | AM        | 10/09/14   | 6.5               | A        |
|              |  | PM        | 10/09/14   | 9.3               | A        |
| 10           | 21st St & E. Santa Clara St                  | AM        | 10/09/14   | 5.7               | A        |
|              |  | PM        | 10/09/14   | 4.6               | A        |
| 11           | 24th St & E. Santa Clara St                  | AM        | 11/05/13   | 19.5              | B        |
|              |  | PM        | 11/05/13   | 21.1              | C        |
| 12           | 26th St. & E. Santa Clara St                 | AM        | 10/09/14   | 16.5              | B        |
|              |  | PM        | 10/09/14   | 14.4              | B        |
| 13           | N. 28th St & E. Santa Clara St               | AM        | 10/09/14   | 20.9              | <b>C</b> |
|              |  | PM        | 10/09/14   | 18.4              | B        |
| 14           | US 101 & E. Santa Clara St *                 | AM        | 10/09/14   | 11.5              | B        |
|              |  | PM        | 09/09/14   | 16.2              | B        |
| 15           | US 101 & Alum Rock Ave *                     | AM        | 10/09/14   | 11.0              | B        |
|              |  | PM        | 09/09/14   | 15.9              | B        |
| 16           | 33rd St & Alum Rock Rd                       | AM        | 05/21/15   | 21.4              | C        |
|              |  | PM        | 05/20/15   | 18.5              | B        |
| 17           | King Rd & Alum Rock Ave *                    | AM        | 05/19/15   | 30.1              | C        |
|              |  | PM        | 09/16/14   | 34.4              | C        |
| 18           | Jackson Ave & Alum Rock Ave *                | AM        | 05/21/15   | 37.8              | D        |
|              |  | PM        | 09/30/14   | 43.0              | D        |
| 19           | I-680 S & Alum Rock Ave (West) *             | AM        | 05/21/15   | 22.2              | C        |
|              |  | PM        | 09/25/14   | 26.6              | C        |
| 20           | I-680 N & Alum Rock Ave (East) *             | AM        | 05/21/15   | 20.9              | C        |
|              |  | PM        | 09/25/14   | 26.3              | C        |
| 21           | 24th St & San Antonio St                     | AM        | 10/09/14   | 16.0              | B        |
|              |  | PM        | 10/09/14   | 12.6              | B        |
| 22           | King Rd & E. San Antonio St.                 | AM        | 05/21/15   | 32.7              | C        |
|              |  | PM        | 05/20/15   | 33.8              | C        |
| 23           | Jackson Ave & E. San Antonio St/Capitol Expy | AM        | 05/21/15   | 35.7              | D        |
|              |  | PM        | 05/20/15   | 34.7              | C        |
| 24           | 24th St & E. William St.                     | AM        | 10/09/14   | 15.8              | B        |
|              |  | PM        | 10/09/14   | 19.4              | B        |
| 25           | McLaughlin Ave & I-280 SB Ramp *             | AM        | 10/09/14   | 9.5               | A        |
|              |  | PM        | 09/24/14   | 14.5              | B        |
| 26           | McLaughlin Ave & Story Rd                    | AM        | 10/09/14   | 42.4              | D        |
|              |  | PM        | 10/09/14   | 48.5              | D        |
| 27           | King Rd & Mabury Rd                          | AM        | 10/08/14   | 39.7              | D        |
|              |  | PM        | 10/08/14   | 38.9              | D        |

**Notes:**  
\* Denotes a CMP intersection  
**Bold** indicates a substandard level of service (according to City of San Jose standards).

**Table 7  
Existing Intersection Levels of Service – Santa Clara Station Area**

| Study Number | Intersection  | Location    | Peak Hour | Count Date | Avg. Delay (sec.) | LOS      |
|--------------|---|-------------|-----------|------------|-------------------|----------|
| 28           | Scott Blvd & Central Expy *                           | Santa Clara | AM        | 05/21/15   | 43.8              | D        |
|              |   |             | PM        | 10/02/14   | 64.1              | E        |
| 29           | Lafayette St & Central Expy *                         | Santa Clara | AM        | 05/21/15   | 53.7              | D        |
|              |   |             | PM        | 09/24/14   | 71.1              | E        |
| 30           | De La Cruz Blvd & Central Expy *                      | Santa Clara | AM        | 10/08/14   | <b>270.6</b>      | <b>F</b> |
|              |   |             | PM        | 10/02/14   | <b>95.8</b>       | <b>F</b> |
| 31           | De La Cruz Blvd & Martin Ave                          | Santa Clara | AM        | 10/08/14   | 34.9              | C        |
|              |   |             | PM        | 10/08/14   | 30.7              | C        |
| 32           | De La Cruz Blvd & Reed St                             | Santa Clara | AM        | 10/08/14   | 11.1              | B        |
|              |   |             | PM        | 10/08/14   | 18.1              | B        |
| 33           | Coleman Ave & Brokaw Rd                               | Santa Clara | AM        | 10/08/14   | 17.0              | B        |
|              |   |             | PM        | 10/08/14   | <b>88.0</b>       | <b>F</b> |
| 34           | Coleman Ave & Aviation Ave                            | San Jose    | AM        | 10/08/14   | 14.6              | B        |
|              |   |             | PM        | 10/08/14   | 7.2               | A        |
| 35           | Coleman Ave & Newhall Dr                              | San Jose    | AM        | 10/08/14   | 13.6              | B        |
|              |   |             | PM        | 10/08/14   | 18.1              | B        |
| 36           | Coleman Ave & I-880 SB Ramps *                        | San Jose    | AM        | 05/12/15   | 24.7              | C        |
|              |   |             | PM        | 09/25/14   | 11.6              | B        |
| 37           | Coleman Ave & I-880 NB Ramps *                        | San Jose    | AM        | 05/12/15   | 37.3              | D        |
|              |   |             | PM        | 09/25/14   | 26.2              | C        |
| 38           | Coleman Ave & W. Hedding St                           | San Jose    | AM        | 05/12/15   | 41.0              | D        |
|              |   |             | PM        | 05/12/15   | 38.1              | D        |
| 39           | Coleman Ave & W. Taylor St                            | San Jose    | AM        | 05/12/15   | 45.0              | D        |
|              |   |             | PM        | 05/12/15   | 44.7              | D        |
| 40           | SR 87 & W. Taylor St                                  | San Jose    | AM        | 05/12/15   | 24.2              | C        |
|              |   |             | PM        | 05/12/15   | 32.6              | C        |
| 41           | San Tomas Expy & El Camino Real *                     | Santa Clara | AM        | 10/08/14   | 66.1              | E        |
|              |   |             | PM        | 09/23/14   | 79.7              | E        |
| 42           | Scott Blvd & El Camino Real *                         | Santa Clara | AM        | 10/08/14   | 33.8              | C        |
|              |   |             | PM        | 09/17/14   | 37.7              | D        |
| 43           | Lincoln St & El Camino Real *                         | Santa Clara | AM        | 05/21/15   | 21.1              | C        |
|              |   |             | PM        | 09/17/14   | 23.1              | C        |
| 44           | Monroe St & El Camino Real *                          | Santa Clara | AM        | 10/08/14   | 35.5              | D        |
|              |   |             | PM        | 09/17/14   | 32.9              | C        |
| 45           | Lafayette St & Reed St                                | Santa Clara | AM        | 01/01/13   | 6.8               | A        |
|              |   |             | PM        | 01/01/13   | 7.4               | A        |
| 46           | Lafayette St & El Camino Real *                       | Santa Clara | AM        | 10/08/14   | 40.8              | D        |
|              |   |             | PM        | 09/17/14   | 41.3              | D        |
| 47           | Lafayette St & Lewis St                               | Santa Clara | AM        | 10/08/14   | 10.7              | B        |
|              |   |             | PM        | 10/08/14   | 31.9              | C        |
| 48           | Lafayette St & Harrison St<br><i>Unsignalized (1)</i> | Santa Clara | AM        | 10/08/14   | 48.9              | E        |
|              |   |             | PM        | 10/08/14   | 176.9             | F        |
| 49           | Lafayette St & Benton St                              | Santa Clara | AM        | 10/08/14   | 17.1              | B        |
|              |   |             | PM        | 10/08/14   | 15.7              | B        |
| 50           | Lafayette St & Homestead Rd                           | Santa Clara | AM        | 05/21/15   | 19.1              | B        |
|              |   |             | PM        | 05/20/15   | 9.7               | A        |
| 51           | Lafayette St & Market St                              | Santa Clara | AM        | 05/21/15   | 16.6              | B        |
|              |   |             | PM        | 05/20/15   | 24.6              | C        |
| 52           | El Camino Real & Benton St                            | Santa Clara | AM        | 10/08/14   | 12.8              | B        |
|              |   |             | PM        | 10/08/14   | 15.4              | B        |
| 53           | El Camino Real & Railroad Ave                         | Santa Clara | AM        | 10/08/14   | 10.5              | B        |
|              |   |             | PM        | 10/08/14   | 12.4              | B        |
| 54           | El Camino Real & The Alameda *                        | Santa Clara | AM        | 10/08/14   | 13.0              | B        |
|              |   |             | PM        | 09/17/14   | 17.2              | B        |
| 55           | The Alameda & Newhall Dr                              | San Jose    | AM        | 05/21/15   | 12.5              | B        |
|              |   |             | PM        | 05/20/15   | 12.6              | B        |
| 56           | The Alameda & I-880 (South) *                         | San Jose    | AM        | 05/07/15   | 19.2              | B        |
|              |   |             | PM        | 09/25/14   | 14.6              | B        |
| 57           | The Alameda & I-880 (North) *                         | San Jose    | AM        | 05/07/15   | 23.2              | C        |
|              |   |             | PM        | 09/25/14   | 21.2              | C        |
| 58           | The Alameda & W. Hedding St *                         | San Jose    | AM        | 05/21/15   | 37.2              | D        |
|              |   |             | PM        | 09/30/14   | 38.0              | D        |
| 59           | The Alameda & W. Taylor St/Naglee Ave *               | San Jose    | AM        | 05/21/15   | 42.3              | D        |
|              |   |             | PM        | 09/30/14   | 40.5              | D        |
| 60           | Homestead Rd & Lincoln St/Winchester Blvd             | Santa Clara | AM        | 05/21/15   | 21.3              | C        |
|              |   |             | PM        | 05/20/15   | 21.4              | C        |
| 61           | Homestead Rd & Monroe St                              | Santa Clara | AM        | 05/21/15   | 9.8               | A        |
|              |   |             | PM        | 05/20/15   | 10.5              | B        |
| 62           | US 101 & Trimble                                      | San Jose    | AM        | 10/07/14   | 21.8              | C        |
|              |   |             | PM        | 10/07/14   | 13.6              | B        |

**Notes:**  
 \* Denotes a CMP intersection  
 (1) The reported delay and corresponding level of service for signalized intersections represent the average delay for all approaches at the intersection. The reported delay and corresponding level of service for unsignalized (two-way stop-controlled) intersections are based on the stop-controlled approach with the highest delay.  
**Bold** indicates a substandard level of service (according to City of San Jose or City of Santa Clara standards).

is presented for informational purposes only. The peak-hour traffic signal warrant checks for this intersection are included in Chapter 5.

### **CMP Level of Service Analysis**

The results of the level of service analysis show that, measured against the CMP level of service standards, all except one of the CMP study intersections in the vicinity of the Santa Clara Station currently operate at an acceptable level of service (LOS E or better) during both the AM and PM peak hours of traffic. The following CMP intersection operates at unacceptable levels of service (LOS F) during at least one peak hour:

(#30) De La Cruz Boulevard and Central Expressway \* (LOS F – AM and PM peak hours)

## **Existing Freeway Segment Levels of Service**

Traffic volumes for the study freeway segments were obtained from the 2014 CMP Annual Monitoring Report, which contains the most recent data collected for freeway segments located in Santa Clara County. The existing level of service for mixed-flow lanes and for High Occupancy Vehicle (HOV) lanes on all 64 directional freeway segments are summarized in Table 8.

The results show that:

- 16 of the 20 directional segments and 13 HOV segments on US 101 operate at an unacceptable LOS F during at least one peak hour.
- 10 of the 12 directional segments and 2 HOV segments on I-280 operate at an unacceptable LOS F during at least one peak hour.
- 7 of the 8 directional segments on I-680 operate at an unacceptable LOS F during at least one peak hour.
- 8 of the 10 directional segments and 3 HOV segments on SR 87 operate at an unacceptable LOS F during at least one peak hour.
- 12 of 14 directional segments on I-880 operate at an unacceptable LOS F during at least one peak hour.

In summary, of the 64 freeway segments that were analyzed, 53 directional mixed flow freeway segments and 18 directional HOV freeway segments operate at an unacceptable level of service based on the CMP's level of service standards.

**Table 8**  
**Existing Freeway Levels of Service**

| Freeway | Segment                   | Direction | Peak Hour | Mixed-Flow Lane |            |        |            |          | HOV Lane   |            |        |            |          |
|---------|---------------------------|-----------|-----------|-----------------|------------|--------|------------|----------|------------|------------|--------|------------|----------|
|         |                           |           |           | Avg. Speed      | # of Lanes | Volume | Density    | LOS      | Avg. Speed | # of Lanes | Volume | Density    | LOS      |
| US 101  | Tully to Story            | NB        | AM        | 25.0            | 3.0        | 5,400  | <b>72</b>  | <b>F</b> | 15.0       | 1.0        | 1430   | <b>95</b>  | <b>F</b> |
|         |                           |           | PM        | 66.0            | 3.0        | 4,950  | 25         | C        | 70.0       | 1.0        | 910    | 13         | B        |
| US 101  | Story to I-280            | NB        | AM        | 22.0            | 3.0        | 5,220  | <b>79</b>  | <b>F</b> | 19.0       | 1.0        | 1640   | <b>86</b>  | <b>F</b> |
|         |                           |           | PM        | 67.0            | 3.0        | 3,000  | 15         | B        | 70.0       | 1.0        | 350    | 5          | A        |
| US 101  | I-280 to Santa Clara      | NB        | AM        | 13.0            | 3.0        | 4,020  | <b>103</b> | <b>F</b> | 13.0       | 1.0        | 1330   | <b>102</b> | <b>F</b> |
|         |                           |           | PM        | 66.0            | 3.0        | 4,560  | 23         | C        | 70.0       | 1.0        | 700    | 10         | A        |
| US 101  | Santa Clara to McKee      | NB        | AM        | 11.0            | 3.0        | 3,700  | <b>112</b> | <b>F</b> | 16.0       | 1.0        | 1480   | <b>92</b>  | <b>F</b> |
|         |                           |           | PM        | 66.0            | 3.0        | 3,960  | 20         | C        | 70.0       | 1.0        | 1050   | 15         | B        |
| US 101  | I-880 to Old Bayshore     | NB        | AM        | 14.0            | 3.0        | 4,200  | <b>100</b> | <b>F</b> | 19.0       | 1.0        | 1,600  | <b>84</b>  | <b>F</b> |
|         |                           |           | PM        | 67.0            | 3.0        | 3,600  | 18         | B        | 70.0       | 1.0        | 420    | 6          | A        |
| US 101  | Old Bayshore to First     | NB        | AM        | 12.0            | 3.0        | 3,930  | <b>109</b> | <b>F</b> | 13.0       | 1.0        | 1,360  | <b>104</b> | <b>F</b> |
|         |                           |           | PM        | 66.0            | 3.0        | 3,960  | 20         | C        | 70.0       | 1.0        | 560    | 8          | A        |
| US 101  | First to SR 87            | NB        | AM        | 19.0            | 3.0        | 4,850  | <b>85</b>  | <b>F</b> | 19.0       | 1.0        | 1,600  | <b>84</b>  | <b>F</b> |
|         |                           |           | PM        | 67.0            | 3.0        | 3,400  | 17         | B        | 70.0       | 1.0        | 630    | 9          | A        |
| US 101  | SR 87 to De La Cruz       | NB        | AM        | 12.0            | 3.0        | 3,860  | <b>107</b> | <b>F</b> | 14.0       | 1.0        | 1,400  | <b>100</b> | <b>F</b> |
|         |                           |           | PM        | 66.0            | 3.0        | 4,160  | 21         | C        | 70.0       | 1.0        | 420    | 6          | A        |
| US 101  | De La Cruz to Montague    | NB        | AM        | 26.0            | 3.0        | 5,460  | <b>70</b>  | <b>F</b> | 39.0       | 1.0        | 2,070  | 53         | E        |
|         |                           |           | PM        | 65.0            | 3.0        | 6,050  | 31         | D        | 70.0       | 1.0        | 980    | 14         | B        |
| US 101  | Montague to Great America | NB        | AM        | 21.0            | 3.0        | 5,110  | <b>81</b>  | <b>F</b> | 41.0       | 1.0        | 2,100  | 51         | E        |
|         |                           |           | PM        | 58.0            | 3.0        | 6,620  | 38         | D        | 70.0       | 1.0        | 1,820  | 26         | C        |
| US 101  | Great America to Montague | SB        | AM        | 66.0            | 3.0        | 4,950  | 25         | C        | 67.0       | 1.0        | 1,080  | 16         | B        |
|         |                           |           | PM        | 14.0            | 3.0        | 4,160  | <b>99</b>  | <b>F</b> | 20.0       | 1.0        | 1,820  | <b>91</b>  | <b>F</b> |
| US 101  | Montague to De La Cruz    | SB        | AM        | 66.0            | 3.0        | 5,310  | 27         | D        | 67.0       | 1.0        | 940    | 14         | B        |
|         |                           |           | PM        | 13.0            | 3.0        | 4,060  | <b>104</b> | <b>F</b> | 40.0       | 1.0        | 2,520  | <b>63</b>  | <b>F</b> |
| US 101  | De La Cruz to SR 87       | SB        | AM        | 62.0            | 3.0        | 6,510  | 35         | D        | 67.0       | 1.0        | 610    | 9          | A        |
|         |                           |           | PM        | 18.0            | 3.0        | 4,700  | <b>87</b>  | <b>F</b> | 50.0       | 1.0        | 2,400  | 48         | E        |
| US 101  | SR 87 to First            | SB        | AM        | 67.0            | 3.0        | 2,600  | 13         | B        | 67.0       | 1.0        | 410    | 6          | A        |
|         |                           |           | PM        | 16.0            | 3.0        | 4,520  | <b>94</b>  | <b>F</b> | 30.0       | 1.0        | 2,340  | <b>78</b>  | <b>F</b> |
| US 101  | First to Old Bayshore     | SB        | AM        | 67.0            | 3.0        | 3,400  | 17         | B        | 67.0       | 1.0        | 410    | 6          | A        |
|         |                           |           | PM        | 6.0             | 3.0        | 2,650  | <b>147</b> | <b>F</b> | 20.0       | 1.0        | 1,820  | <b>91</b>  | <b>F</b> |
| US 101  | Old Bayshore to I-880     | SB        | AM        | 67.0            | 3.0        | 2,400  | 12         | B        | 67.0       | 1.0        | 540    | 8          | A        |
|         |                           |           | PM        | 8.0             | 3.0        | 3,030  | <b>126</b> | <b>F</b> | 30.0       | 1.0        | 2,160  | <b>72</b>  | <b>F</b> |
| US 101  | McKee to Santa Clara      | SB        | AM        | 67.0            | 3.0        | 2,800  | 14         | B        | 67.0       | 1.0        | 810    | 12         | B        |
|         |                           |           | PM        | 62.0            | 3.0        | 6,510  | 35         | D        | 70.0       | 1.0        | 1400   | 20         | C        |
| US 101  | Santa Clara to I-280      | SB        | AM        | 67.0            | 3.0        | 3,600  | 18         | B        | 67.0       | 1.0        | 270    | 4          | A        |
|         |                           |           | PM        | 63.0            | 3.0        | 6,430  | 34         | D        | 70.0       | 1.0        | 1960   | 28         | D        |
| US 101  | I-280 to Story            | SB        | AM        | 67.0            | 3.0        | 3,200  | 16         | B        | 67.0       | 1.0        | 470    | 7          | A        |
|         |                           |           | PM        | 54.0            | 3.0        | 6,650  | 41         | D        | 70.0       | 1.0        | 1470   | 21         | C        |
| US 101  | Story to Tully            | SB        | AM        | 66.0            | 3.0        | 3,960  | 20         | C        | 67.0       | 1.0        | 470    | 7          | A        |
|         |                           |           | PM        | 45.0            | 3.0        | 6,480  | 48         | E        | 70.0       | 1.0        | 1820   | 26         | C        |
| I-280   | I-880 to Meridian         | EB        | AM        | 66.0            | 3.0        | 5,150  | 26         | C        | 67.0       | 1.0        | 670    | 18         | B        |
|         |                           |           | PM        | 17.0            | 3.0        | 4,590  | <b>90</b>  | <b>F</b> | 20.0       | 1.0        | 1,740  | <b>30</b>  | <b>F</b> |
| I-280   | Meridian to Bird          | EB        | AM        | 61.0            | 4.0        | 8,790  | 36         | D        | ---        | ---        | ---    | ---        | ---      |
|         |                           |           | PM        | 21.0            | 4.0        | 6,810  | <b>81</b>  | <b>F</b> | ---        | ---        | ---    | ---        | ---      |
| I-280   | Bird to SR 87             | EB        | AM        | 66.0            | 4.0        | 5,280  | 20         | C        | ---        | ---        | ---    | ---        | ---      |
|         |                           |           | PM        | 25.0            | 4.0        | 7,200  | <b>72</b>  | <b>F</b> | ---        | ---        | ---    | ---        | ---      |
| I-280   | SR 87 to 10th             | EB        | AM        | 67.0            | 4.0        | 4,530  | 17         | B        | ---        | ---        | ---    | ---        | ---      |
|         |                           |           | PM        | 27.0            | 4.0        | 7,460  | <b>69</b>  | <b>F</b> | ---        | ---        | ---    | ---        | ---      |
| I-280   | 10th to McLaughlin        | EB        | AM        | 66.0            | 4.0        | 5,020  | 19         | C        | ---        | ---        | ---    | ---        | ---      |
|         |                           |           | PM        | 54.0            | 4.0        | 8,860  | 41         | D        | ---        | ---        | ---    | ---        | ---      |
| I-280   | McLaughlin to US 101      | EB        | AM        | 66.0            | 4.0        | 5,810  | 22         | C        | ---        | ---        | ---    | ---        | ---      |
|         |                           |           | PM        | 54.0            | 4.0        | 8,860  | 41         | D        | ---        | ---        | ---    | ---        | ---      |
| I-680   | US 101 to King            | NB        | AM        | 33.0            | 4.0        | 7,920  | <b>60</b>  | <b>F</b> | ---        | ---        | ---    | ---        | ---      |
|         |                           |           | PM        | 66.0            | 4.0        | 7,080  | 27         | D        | ---        | ---        | ---    | ---        | ---      |
| I-680   | King to Capitol           | NB        | AM        | 20.0            | 4.0        | 6,560  | <b>82</b>  | <b>F</b> | ---        | ---        | ---    | ---        | ---      |
|         |                           |           | PM        | 47.0            | 4.0        | 8,650  | 46         | D        | ---        | ---        | ---    | ---        | ---      |
| I-680   | Capitol to Alum Rock      | NB        | AM        | 18.0            | 4.0        | 6,270  | <b>87</b>  | <b>F</b> | ---        | ---        | ---    | ---        | ---      |
|         |                           |           | PM        | 65.0            | 4.0        | 7,800  | 30         | D        | ---        | ---        | ---    | ---        | ---      |
| I-680   | Alum Rock to McKee        | NB        | AM        | 27.0            | 4.0        | 7,350  | <b>68</b>  | <b>F</b> | ---        | ---        | ---    | ---        | ---      |
|         |                           |           | PM        | 66.0            | 4.0        | 5,810  | 22         | C        | ---        | ---        | ---    | ---        | ---      |

Source: Santa Clara Valley Transportation Authority Congestion Management Program Monitoring Study, 2014.

**Bold** indicates unacceptable LOS.



**Table 8, Continued**  
**Existing Freeway Levels of Service**

| Freeway | Segment                       | Direction | Peak Hour | Mixed-Flow Lane |            |        |         |     | HOV Lane   |            |        |         |     |
|---------|-------------------------------|-----------|-----------|-----------------|------------|--------|---------|-----|------------|------------|--------|---------|-----|
|         |                               |           |           | Avg. Speed      | # of Lanes | Volume | Density | LOS | Avg. Speed | # of Lanes | Volume | Density | LOS |
| I-680   | McKee to Alum Rock            | SB        | AM        | 63.0            | 4.0        | 8,570  | 34      | D   | ---        | ---        | ---    | ---     | --- |
|         |                               |           | PM        | 47.0            | 4.0        | 8,650  | 46      | D   | ---        | ---        | ---    | ---     | --- |
| I-680   | Alum Rock to Capitol          | SB        | AM        | 23.0            | 4.0        | 7,090  | 77      | F   | ---        | ---        | ---    | ---     | --- |
|         |                               |           | PM        | 65.0            | 4.0        | 7,540  | 29      | D   | ---        | ---        | ---    | ---     | --- |
| I-680   | Capitol to King               | SB        | AM        | 21.0            | 4.0        | 7,490  | 81      | F   | ---        | ---        | ---    | ---     | --- |
|         |                               |           | PM        | 66.0            | 4.0        | 7,790  | 27      | D   | ---        | ---        | ---    | ---     | --- |
| I-680   | King to US 101                | SB        | AM        | 12.0            | 4.0        | 5,140  | 107     | F   | ---        | ---        | ---    | ---     | --- |
|         |                               |           | PM        | 66.0            | 4.0        | 5,550  | 21      | C   | ---        | ---        | ---    | ---     | --- |
| I-280   | US 101 to McLaughlin          | WB        | AM        | 14.0            | 4.0        | 5,660  | 101     | F   | ---        | ---        | ---    | ---     | --- |
|         |                               |           | PM        | 66.0            | 4.0        | 6,340  | 24      | C   | ---        | ---        | ---    | ---     | --- |
| I-280   | McLaughlin to 10th            | WB        | AM        | 19.0            | 4.0        | 6,390  | 84      | F   | ---        | ---        | ---    | ---     | --- |
|         |                               |           | PM        | 65.0            | 4.0        | 7,540  | 29      | D   | ---        | ---        | ---    | ---     | --- |
| I-280   | 10th to SR 87                 | WB        | AM        | 21.0            | 4.0        | 6,720  | 80      | F   | ---        | ---        | ---    | ---     | --- |
|         |                               |           | PM        | 65.0            | 4.0        | 7,800  | 30      | D   | ---        | ---        | ---    | ---     | --- |
| I-280   | SR 87 to Bird                 | WB        | AM        | 20.0            | 4.0        | 6,640  | 83      | F   | ---        | ---        | ---    | ---     | --- |
|         |                               |           | PM        | 62.0            | 4.0        | 8,680  | 35      | D   | ---        | ---        | ---    | ---     | --- |
| I-280   | Bird to Meridian              | WB        | AM        | 18.0            | 4.0        | 6,410  | 89      | F   | ---        | ---        | ---    | ---     | --- |
|         |                               |           | PM        | 58.0            | 4.0        | 8,820  | 38      | D   | ---        | ---        | ---    | ---     | --- |
| I-280   | Meridian to I-880             | WB        | AM        | 14.0            | 3.0        | 4,760  | 100     | F   | 26.0       | 1.0        | 1,820  | 70      | F   |
|         |                               |           | PM        | 66.0            | 3.0        | 4,720  | 21      | C   | 70.0       | 1.0        | 1,330  | 19      | C   |
| SR 87   | Curtner to Almaden Expressway | NB        | AM        | 13.0            | 2.0        | 2,660  | 102     | F   | 22.0       | 1.0        | 1,720  | 78      | F   |
|         |                               |           | PM        | 65.0            | 2.0        | 3,900  | 30      | D   | 70.0       | 1.0        | 1,190  | 17      | B   |
| SR 87   | Almaden Expressway to Alma    | NB        | AM        | 29.0            | 2.0        | 3,770  | 65      | F   | 43.0       | 1.0        | 2,110  | 49      | E   |
|         |                               |           | PM        | 41.0            | 2.0        | 4,190  | 51      | E   | 70.0       | 1.0        | 1,540  | 22      | C   |
| SR 87   | Alma to I-280                 | NB        | AM        | 33.0            | 2.0        | 3,960  | 60      | F   | 61.0       | 1.0        | 2,200  | 36      | D   |
|         |                               |           | PM        | 66.0            | 2.0        | 3,440  | 26      | C   | 70.0       | 1.0        | 420    | 6       | A   |
| SR 87   | I-280 to Julian               | NB        | AM        | 16.0            | 2.0        | 2,980  | 93      | F   | 30.0       | 1.0        | 1,920  | 64      | F   |
|         |                               |           | PM        | 67.0            | 2.0        | 2,400  | 18      | B   | 70.0       | 1.0        | 630    | 9       | A   |
| SR 87   | Julian to Coleman             | NB        | AM        | 14.0            | 2.0        | 2,800  | 100     | F   | 32.0       | 1.0        | 1,960  | 61      | F   |
|         |                               |           | PM        | 67.0            | 2.0        | 2,130  | 16      | B   | 70.0       | 1.0        | 490    | 7       | A   |
| SR 87   | Coleman to Julian             | SB        | AM        | 66.0            | 2.0        | 3,540  | 27      | D   | 67.0       | 1.0        | 670    | 10      | A   |
|         |                               |           | PM        | 32.0            | 2.0        | 3,910  | 61      | F   | 50.0       | 1.0        | 2,200  | 44      | D   |
| SR 87   | Julian to I-280               | SB        | AM        | 67.0            | 2.0        | 1,870  | 14      | B   | 67.0       | 1.0        | 410    | 6       | A   |
|         |                               |           | PM        | 36.0            | 2.0        | 4,040  | 56      | E   | 70.0       | 1.0        | 2,030  | 29      | D   |
| SR 87   | I-280 to Alma                 | SB        | AM        | 67.0            | 2.0        | 1,870  | 14      | B   | 67.0       | 1.0        | 210    | 3       | A   |
|         |                               |           | PM        | 15.0            | 2.0        | 3,900  | 95      | F   | 60.0       | 1.0        | 1,190  | 41      | D   |
| SR 87   | Alma to Almaden Expressway    | SB        | AM        | 66.0            | 2.0        | 2,910  | 22      | C   | 67.0       | 1.0        | 610    | 9       | A   |
|         |                               |           | PM        | 27.0            | 2.0        | 3,040  | 69      | F   | 60.0       | 1.0        | 840    | 38      | D   |
| SR 87   | Almaden Expressway to Curtner | SB        | AM        | 66.0            | 2.0        | 2,640  | 20      | C   | 67.0       | 1.0        | 410    | 6       | A   |
|         |                               |           | PM        | 36.0            | 2.0        | 4,040  | 56      | E   | 70.0       | 1.0        | 1,960  | 28      | D   |
| I-880   | I-280 to Stevens Creek        | NB        | AM        | 15.0            | 3.0        | 4,370  | 97      | F   | ---        | ---        | ---    | ---     | --- |
|         |                               |           | PM        | 66.0            | 3.0        | 4,160  | 21      | C   | ---        | ---        | ---    | ---     | --- |
| I-880   | Stevens Creek to Bascom       | NB        | AM        | 20.0            | 3.0        | 4,920  | 82      | F   | ---        | ---        | ---    | ---     | --- |
|         |                               |           | PM        | 16.0            | 3.0        | 4,420  | 92      | F   | ---        | ---        | ---    | ---     | --- |
| I-880   | Bascom to The Alameda         | NB        | AM        | 27.0            | 3.0        | 5,590  | 69      | F   | ---        | ---        | ---    | ---     | --- |
|         |                               |           | PM        | 13.0            | 3.0        | 4,060  | 104     | F   | ---        | ---        | ---    | ---     | --- |
| I-880   | The Alameda to Coleman        | NB        | AM        | 31.0            | 3.0        | 5,860  | 63      | F   | ---        | ---        | ---    | ---     | --- |
|         |                               |           | PM        | 15.0            | 3.0        | 4,320  | 96      | F   | ---        | ---        | ---    | ---     | --- |
| I-880   | Coleman to SR 87              | NB        | AM        | 22.0            | 3.0        | 5,150  | 78      | F   | ---        | ---        | ---    | ---     | --- |
|         |                               |           | PM        | 24.0            | 3.0        | 5,330  | 74      | F   | ---        | ---        | ---    | ---     | --- |
| I-880   | SR 87 to First                | NB        | AM        | 48.0            | 3.0        | 6,480  | 45      | D   | ---        | ---        | ---    | ---     | --- |
|         |                               |           | PM        | 22.0            | 3.0        | 5,220  | 79      | F   | ---        | ---        | ---    | ---     | --- |
| I-880   | First to US 101               | NB        | AM        | 36.0            | 3.0        | 6,160  | 57      | E   | ---        | ---        | ---    | ---     | --- |
|         |                               |           | PM        | 51.0            | 3.0        | 6,580  | 43      | D   | ---        | ---        | ---    | ---     | --- |
| I-880   | US 101 to First               | SB        | AM        | 16.0            | 3.0        | 4,470  | 93      | F   | ---        | ---        | ---    | ---     | --- |
|         |                               |           | PM        | 14.0            | 3.0        | 4,250  | 101     | F   | ---        | ---        | ---    | ---     | --- |
| I-880   | First to SR 87                | SB        | AM        | 25.0            | 3.0        | 5,480  | 73      | F   | ---        | ---        | ---    | ---     | --- |
|         |                               |           | PM        | 14.0            | 3.0        | 4,160  | 99      | F   | ---        | ---        | ---    | ---     | --- |
| I-880   | SR 87 to Coleman              | SB        | AM        | 65.0            | 3.0        | 5,850  | 30      | D   | ---        | ---        | ---    | ---     | --- |
|         |                               |           | PM        | 23.0            | 3.0        | 5,250  | 76      | F   | ---        | ---        | ---    | ---     | --- |
| I-880   | Coleman to The Alameda        | SB        | AM        | 66.0            | 3.0        | 5,310  | 27      | D   | ---        | ---        | ---    | ---     | --- |
|         |                               |           | PM        | 23.0            | 3.0        | 5,250  | 76      | F   | ---        | ---        | ---    | ---     | --- |
| I-880   | The Alameda to Bascom         | SB        | AM        | 66.0            | 3.0        | 4,950  | 25      | C   | ---        | ---        | ---    | ---     | --- |
|         |                               |           | PM        | 25.0            | 3.0        | 5,480  | 73      | F   | ---        | ---        | ---    | ---     | --- |
| I-880   | Bascom to Stevens Creek       | SB        | AM        | 50.0            | 3.0        | 6,600  | 44      | D   | ---        | ---        | ---    | ---     | --- |
|         |                               |           | PM        | 30.0            | 3.0        | 5,760  | 64      | F   | ---        | ---        | ---    | ---     | --- |
| I-880   | Stevens Creek to I-280        | SB        | AM        | 66.0            | 3.0        | 3,960  | 20      | C   | ---        | ---        | ---    | ---     | --- |
|         |                               |           | PM        | 65.0            | 3.0        | 5,850  | 30      | D   | ---        | ---        | ---    | ---     | --- |

Source: Santa Clara Valley Transportation Authority Congestion Management Program Monitoring Study, 2014.  
**Bold** indicates unacceptable LOS.

## Observed 2015 Existing Traffic Conditions

Traffic conditions were observed in the field to identify existing operational deficiencies and to confirm the accuracy of calculated levels of service at the study intersections. The purpose of this effort was (1) to identify any existing traffic problems that may not be directly related to level of service, and (2) to identify any locations where the level of service analysis does not accurately reflect actual existing traffic conditions.

AM and PM field observations revealed that overall the study intersections operate well, and the level of service calculations accurately reflect existing conditions. However, field observations revealed that some minor operational problems currently occur that may not be reflected in the intersection level of service calculations, as indicated below.

### ***3. North 28<sup>th</sup> Street and East Julian Street/McKee Road***

The intersection of 28<sup>th</sup> Street and East Julian Street/McKee Road on the south side of the broad median strip on McKee Road is very close to two other intersections. One, which is less than 50 feet north, is 28<sup>th</sup> Street and E. Julian Street on the north side of the median strip, and the other is US 101 SB Ramps and McKee Road, which is approximately 150 feet east of the intersection. This close proximity creates issues with drivers knowing which lanes to be in, as well understanding which signals apply to which intersection.

During the AM peak hour, vehicles turning right onto the US 101 southbound ramp from eastbound McKee Road spilled into the intersection, preventing northbound through movements and northbound right-turn movements from proceeding.

During the PM peak hour, similar queues from the US 101 southbound ramps were observed on eastbound McKee Road. This queue at the on-ramp prevents vehicles in the eastbound through movement from passing through the intersection, creating queues that extend from this intersection to the intersection of 26<sup>th</sup> Street and Julian Street.

### ***7. King Road and McKee Road***

During the AM peak hour, pedestrians utilizing the midblock crossing along McKee Road between King Road and 33<sup>rd</sup> Street can create a vehicle queue in the westbound direction that spills into the intersection due to the relatively high westbound volume.

During the PM peak hour, the eastbound left-turn volumes exceed the storage capacity for the single left-turn pocket. These left-turn queues fill up the shared left-turn center lane for the east and west bound traffic with eastbound left-turning vehicles queuing within the westbound left-turn pocket at the intersection of 34<sup>th</sup> Street and McKee Road.

### ***8. Jackson Avenue and McKee Road***

During the AM peak hour, there is a relatively high volume of westbound left-turning vehicles. These left-turning vehicles exceed the capacity of the dual left-turn lanes. When vehicles spill out of the left-turn pocket, westbound through vehicles back up behind the queue and some vehicles attempt to move to the adjacent through lane to get around the queue. However, all westbound left turning vehicles clear the intersection during the green phase.

### ***13. North 28<sup>th</sup> Street and East Santa Clara Avenue***

Field observations showed that under existing conditions there are no issues with the intersection operationally. The northbound and southbound movements at this intersection currently have very low volumes, and as such, signal operation permits northbound and southbound traffic to enter the intersection simultaneously.

### ***18. Jackson Avenue and Alum Rock Avenue***

During the AM peak hour, westbound through queues spill back and block vehicles turning right off of the I-680 SB off-ramp. Eastbound queues at the intersection of I-680 southbound off-ramp and Alum Rock Avenue spill back into this intersection. Issues caused by the I-680 southbound off-ramp and Alum Rock Avenue appear to be caused when a northbound left-turning vehicle approaches the intersection on Foss Ave. The green time for this

northbound movement is much longer than it takes for the single car to make it through the intersection which causes the signal to operate inefficiently. This could be caused by a broken loop detector that results in maxing out the green time. This inefficient signal operation causes queues in the south, east, and west bound directions.

### ***28. Scott Boulevard and Central Expressway***

During the AM peak hour, westbound traffic merging from Central Expressway onto Lawson Lane (which acts as the interchange between westbound Central Expressway and northbound San Tomas Expressway) creates queues that spill into this intersection.

During the PM peak hour, the eastbound queues along Central Expressway extend past the weaving section for vehicles merging onto eastbound Central Expressway from northbound San Tomas Expressway. This prevents vehicles from merging and creates a queue along the interchange from San Tomas Expressway.

### ***29. Lafayette Street and Central Expressway***

During the AM peak hour, the northbound through queue at the intersection spills back into the signalized intersection of Lafayette Street and Walsh Avenue. This queue prevents vehicles from entering the left-turn and right-turn pockets if queued further south than the Hitachi site driveway.

During the PM peak hour, this intersection is significantly influenced by the queues from the eastbound left-turn lanes at Central Expressway and De La Cruz Boulevard. The eastbound queue spilling into this intersection prevents eastbound through vehicles and southbound left-turning vehicles at Central Expressway and Lafayette Street from crossing the intersection.

### ***30. De La Cruz Boulevard and Central Expressway***

This intersection experiences relatively high volumes during both the AM and PM peak hours.

During the AM peak hour, northbound through and left-turn queues spill back through the intersection of De La Cruz Boulevard and Airport Technology Park Driveway. Other issues at this intersection during the AM peak hour stem from the nearby 101 southbound off-ramp and the 101 northbound on-ramp. The weaving section along De La Cruz Boulevard creates a bottleneck in the southbound direction along De La Cruz Boulevard as vehicles exiting the freeway attempt to merge into the southbound through lane, while a relatively high number of vehicles merge into this off-ramp lane to make a right turn at the intersection. These conflicting movements create queues that back up past the US101 southbound off-ramp and prevent vehicles from merging into the through lanes, as well as into the right-turn only lane. A relatively high number of eastbound left-turning vehicles attempt to quickly merge to the rightmost lane on northbound Trimble Road to enter onto the US 101 northbound on-ramp. This high volume merging over during this phase creates queues from the US101 northbound on-ramp that spill back into the intersection and prevent the northbound through movements in the middle lane from proceeding.

During the PM peak hour, eastbound left-turning movements create queues that spill back all the way to Lafayette Street and Central Expressway. The ramp metering and high number of volumes turning onto the US 101 southbound on-ramp create long queues that spill back into this intersection, preventing the eastbound left-turn and northbound through movements from clearing in one cycle. Past this on-ramp there is very little traffic, and vehicles drive at free-flow speed.

### ***36. Coleman Avenue and I-880 Southbound Ramps***

During the AM peak hour, northbound volumes are relatively high. These volumes don't create any queuing issues at the intersection. A majority of the westbound vehicles are turning right off of the I-880 southbound ramp. The maximum number of turning vehicles observed in a queue in the right-turn lane was five vehicles.

During the PM peak hour, it was noted that a majority of the right-turning vehicles from the I-880 southbound ramp continued to turn right onto Airport Road. Beyond this, no operational issues were observed.

### ***37. Coleman Avenue/McKendrie Street and I-880 Northbound Ramps***

No AM or PM operational issues were observed at this intersection. The current configuration of this intersection allows for right-turn only movements in the eastbound direction. According to the City database, this right turn is

granted a green time for their maneuvers. However, after observing numerous right-turning vehicles at this leg, the signal never changed to a green phase for this movement.

### ***38. Coleman Avenue and Hedding Street***

During the PM peak hour, the southbound queues at the intersection spill back to the intersection of Coleman Avenue and I-880 southbound ramps. This queue typically clears when the southbound movements have green lights. There is a high volume of southbound left-turns which exceed the capacity of the dual-left turning lanes.

### ***39. Coleman Avenue and Taylor Street***

During the AM peak hour, westbound through movement queues extend past the left-turning pockets, preventing vehicles from entering the pocket.

During the PM peak hour, southbound queues extend past the unsignalized intersection of Coleman Avenue and Emory Street.

### ***40. SR 87 and Taylor Street***

During the AM peak hour, the westbound left-turn movement from Taylor Street onto southbound SR 87 occasionally spills out of the left-turn pocket. As a result, it occasionally requires two signal cycles for all westbound left-turning vehicles to clear the intersection. Eastbound through traffic on Taylor Street received heavy volume from the SR 87 northbound off-ramp, and vehicle queues occasionally extend back to the off-ramp.

During the PM peak hour, the on-ramp to southbound SR 87 is metered. As a result of vehicle stacking on the on-ramp, vehicles turning left onto southbound SR 87 from westbound Taylor Street consistently block eastbound through traffic on Taylor Street. However, this situation does not last long, and eastbound traffic on Taylor Street is able to clear the intersection in one signal cycle.

### ***41. San Tomas Expressway and El Camino Real***

During the AM peak hour this intersection experiences relatively high volumes in the north, east, and west bound directions. Northbound through queues on San Tomas Expressway spill back to the intersection of San Tomas Expressway and Benton Street and do not clear in one cycle. Additionally, this northbound queue prevents vehicles from entering the northbound left-turn pocket. The eastbound and westbound left-turning vehicles exceed the storage spaces of the single left-turn pockets along El Camino Real.

During the PM peak hour this intersection experiences relatively high volumes in the south and east bound directions. Eastbound through queues on El Camino Real spill back to the unsignalized intersection of Buchanan Drive and El Camino Real, preventing vehicles in the westbound turn pocket from making the turn. This left-turn pocket has room for approximately six vehicles before interfering with through movements at this intersection. The southbound through queues along El Camino Real spill back to the signalized intersection of San Tomas Expressway and Cabrillo Avenue.

### ***46. Lafayette Street and El Camino Real***

During the AM peak hour, northbound Lafayette Street experiences relatively heavy traffic volumes. The northbound through queues spill back into the intersection of Lafayette Street and Lewis Street, preventing right-turning vehicles from westbound Lewis Street from merging into the northbound through lane.

During the PM peak hour, southbound Lafayette Street experiences relatively heavy traffic volumes. The southbound through traffic does not clear in one cycle, and the southbound queues from Lafayette Street and Lewis Street prevent a majority of the vehicles from passing through the intersection during the designated green time.

El Camino Real experiences relatively heavy volumes in the eastbound direction during the AM peak hour, and in the westbound direction during the PM peak hour. The volumes at this intersection are primarily through movements, and all of the vehicles clear the intersection in one signal cycle.

#### ***47. Lafayette Street and Lewis Street***

During the AM peak hour, northbound queues from the intersection of Lafayette Street and El Camino Real spill into this intersection, preventing the northbound through vehicles on Lafayette from clearing in one cycle. In turn, the northbound queue at this intersection spills back into the intersection of Lafayette Street and Benton Street.

During the PM peak hour, southbound queues from the intersection of Lafayette Street and Benton Street spill back into this intersection. The queuing analysis for this intersection during the PM peak hour shows that the expected left-turn queue on westbound Lewis Street will queue a significant distance back, almost onto De La Cruz Boulevard. From numerous observations, however, this left-turn queue only ever extends as far as the interchange between De La Cruz Boulevard, Alviso Street, and Lewis Street (measured to be approximately 350 feet on Google Earth). It was observed that a high number of westbound vehicles on Lewis Street continue through the intersection and make a left-turn at the downstream intersection of Washington Street and Lewis Street.

#### ***59. The Alameda and Naglee Avenue/Taylor Street***

During the AM peak hour, the westbound left-turn movements exceed the storage of the left-turn pocket.

During the PM peak hour, the westbound through movement queue blocks the left-turn pocket. There is a relatively high number of eastbound right-turns at this intersection, which when southbound through movements have the green light, queue back past the unsignalized intersection of Morse Street and Naglee Avenue. The southbound left-turn movements overflow the storage of the left-turn pocket and block vehicles in the east most through lane from continuing through to the intersection.

The remaining study intersections and transportation system were not observed to have any operational problems.

### 3.

## 2025 Background Conditions

---

This chapter presents 2025 Background traffic conditions, which are defined as conditions just prior to completion of the proposed Project. For this analysis, background conditions are represented by the year 2025 (opening day of the Phase II BART stations), without the Phase II Project. Traffic volumes for 2025 Background Conditions comprise volumes from existing traffic counts plus traffic generated by other approved developments in the vicinity of the site. This chapter describes the procedure used to determine 2025 Background traffic volumes and the resulting traffic conditions at the study intersections and on the study freeway segments.

### 2025 Background Transportation Network

This scenario assumes that the Phase I Project (Milpitas and Berryessa BART Stations only) would be completed and in operation. It is also assumed that Bus Rapid Transit (BRT) service would be operating on the Santa Clara Street and Alum Rock Avenue corridor.

In addition, the following changes at eight study intersections would be constructed by the Year 2025, based on input from the Cities of Santa Clara and San Jose. These changes were incorporated into the lane geometry in the TRAFFIX software under the Background scenario:

#### Intersections Near Alum Rock/28<sup>th</sup> Street Station

- King Road and McKee Road (Study Intersection #7): Add a second eastbound left-turn lane on McKee Road.

#### Intersections Near Santa Clara Station

- Central Expressway and Scott Boulevard (#28): Convert existing through HOV lanes to mixed-flow lanes.
- Central Expressway and Lafayette Street (#29): Convert existing through HOV lanes to mixed-flow lanes.
- Central Expressway and De La Cruz Boulevard (#30): Convert existing eastbound HOV lane to mixed-flow lane.
- Coleman Avenue and Brokaw Road (#33): Widen Coleman Avenue to accommodate a third southbound through lane.
- Coleman Avenue and Hedding Street (#38): Add a second eastbound left-turn lane on Hedding Street.
- Coleman Avenue and Taylor Street (#39): Remove the free right-turn movement, add a westbound dedicated right-turn lane on Taylor Street.
- San Tomas Expressway and El Camino Real (#41): Add a second left-turn lane on both the eastbound and westbound approaches.



## 2025 Background Conditions Traffic Volumes at Study Intersections

2025 Background Conditions peak hour traffic volumes were estimated by adding to existing peak hour volumes the estimated traffic from approved but not yet constructed developments. The added traffic from approved but not yet constructed developments in the City of San Jose was obtained from the City's Approved Trips Inventory (ATI) dated July 22, 2015. The ATI lists each approved project and the trips associated with the approved project for each intersection. The San Jose ATI is contained in Appendix C.

The added traffic from approved but not-yet-constructed developments in the City of Santa Clara was obtained from the City of Santa Clara's TRAFFIX network, which was updated with the current list of approved projects provided by City staff and dated July 15, 2015. Traffic generated by Phase 1 of the North San Jose Development Policy and approved projects within the City of Sunnyvale also were included in the background traffic volumes. The list of approved but not yet constructed projects in Santa Clara is included in Appendix C.

2025 Background Conditions traffic volumes are shown graphically on Figures 15 and 16 for intersections near the Alum Rock/28<sup>th</sup> Street and Santa Clara Stations, respectively. Traffic volumes for all components of traffic are tabulated in Appendix D.

## Intersection Levels of Service under 2025 Background Conditions

Intersection levels of service under 2025 Background Conditions were evaluated against City of San Jose, City of Santa Clara, and CMP standards. As described in Chapter 1, the traffic volumes analyzed for the 2025 Background Conditions scenario do not include Project-generated trips. These level of service results are used as a basis of comparison with the 2025 Background Plus Project scenario in Chapter 4. The intersection level of service calculation sheets are included in Appendix E.

### Alum Rock/28<sup>th</sup> Street Station

The results of the level of service analysis under 2025 Background Conditions for the Alum Rock/28<sup>th</sup> Street Station are summarized in Table 9. All of the 27 study intersections in the vicinity of the Alum Rock/28<sup>th</sup> Street Station are located in the City of San Jose.

#### City of San Jose Level of Service Analysis

The results of the level of service analysis under 2025 Background Conditions show that, measured against the City of San Jose level of service policy, all of the study intersections in the vicinity of the Alum Rock/28<sup>th</sup> Street Station would operate at an acceptable level of service (LOS D or better) during both the AM and PM peak hours of traffic.

#### CMP Level of Service Analysis

The results of the level of service analysis under 2025 Background Conditions show that, measured against the CMP level of service standards, all of the CMP study intersections in the vicinity of the Alum Rock/28<sup>th</sup> Street Station would operate at an acceptable level of service (LOS E or better) during both the AM and PM peak hours of traffic.

Phase II Extension Project TIA

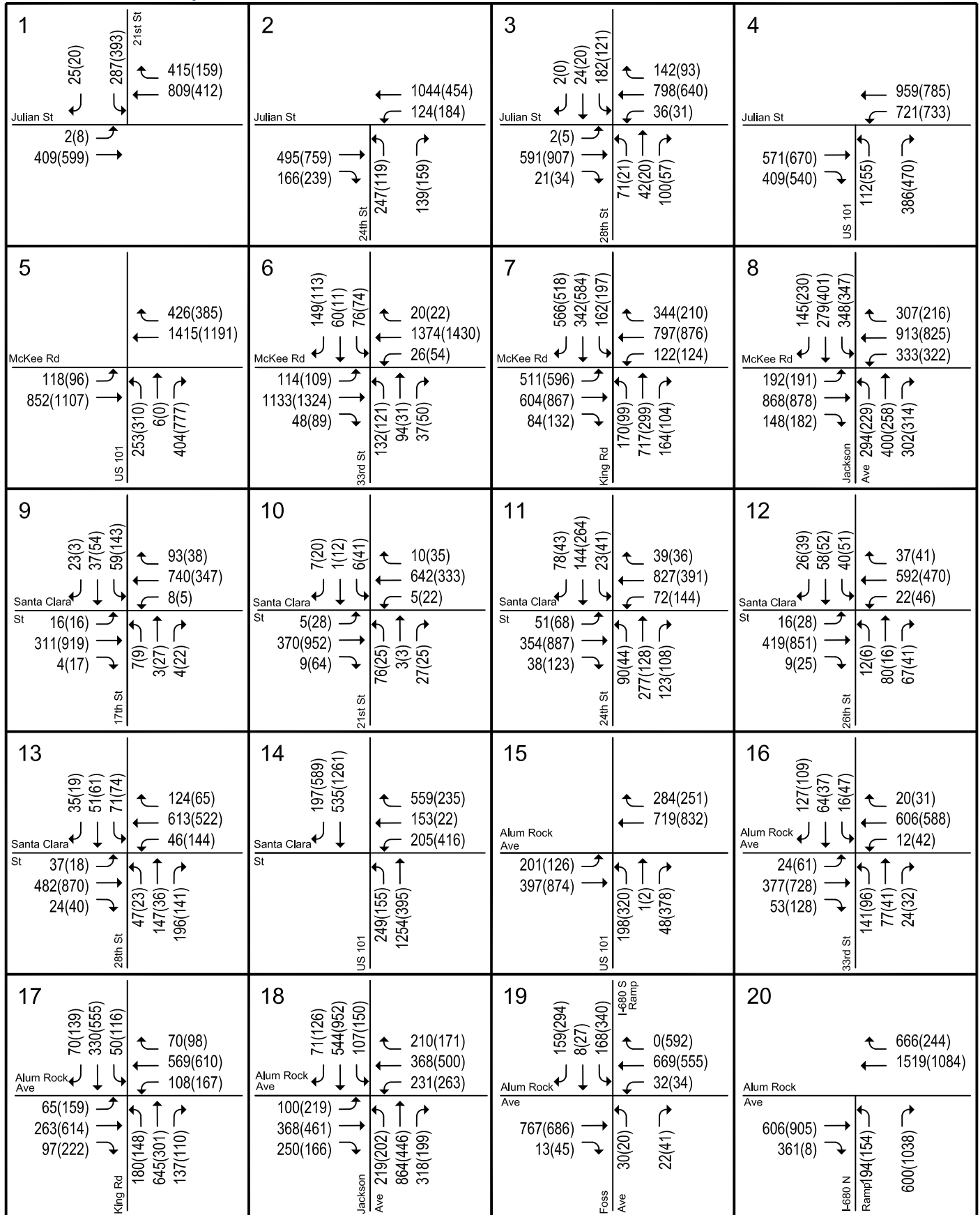

LEGEND

XX(XX) = AM(PM) Peak-Hour Traffic Volumes

**Figure 15**  
**2025 Background Conditions Traffic Volumes - Alum Rock/28th Street Station**



Phase II Extension Project TIA

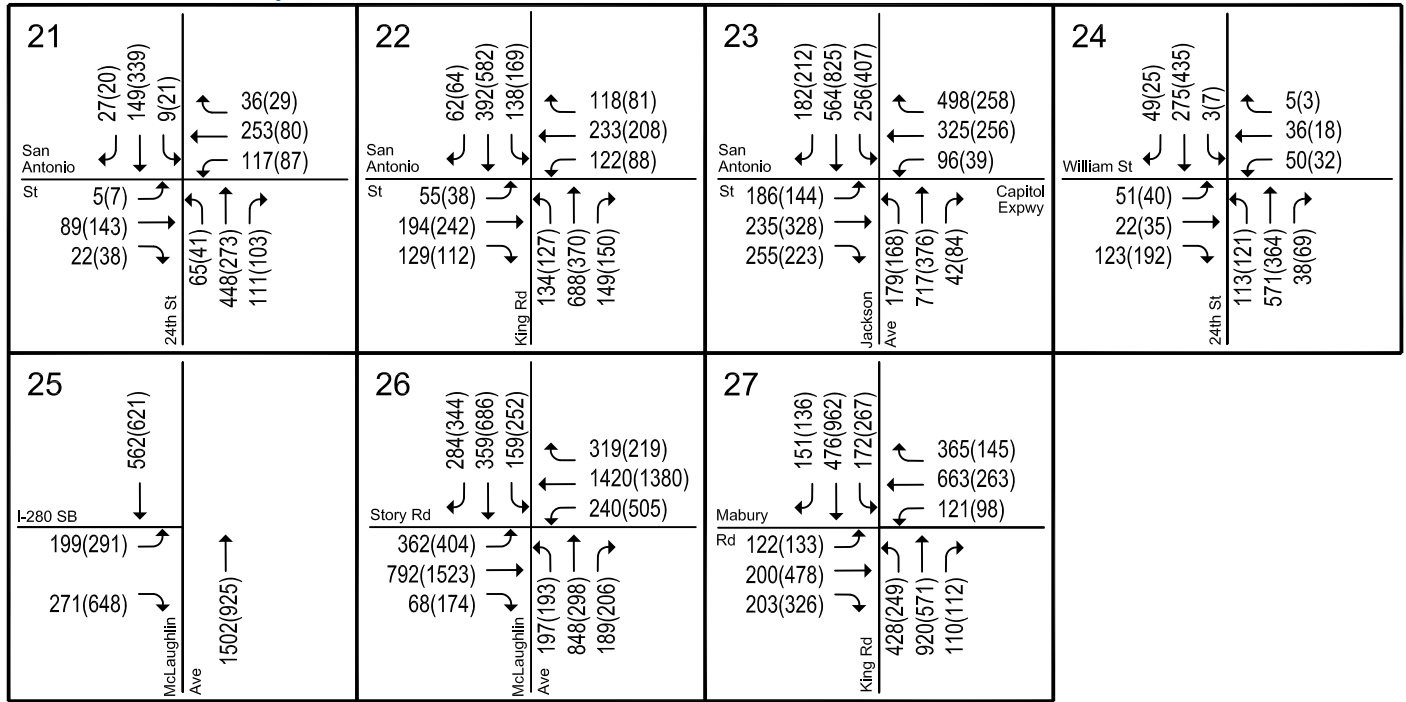

LEGEND

XX(XX) = AM(PM) Peak-Hour Traffic Volumes

Figure 15  
2025 Background Conditions Traffic Volumes - Alum Rock/28th Street Station

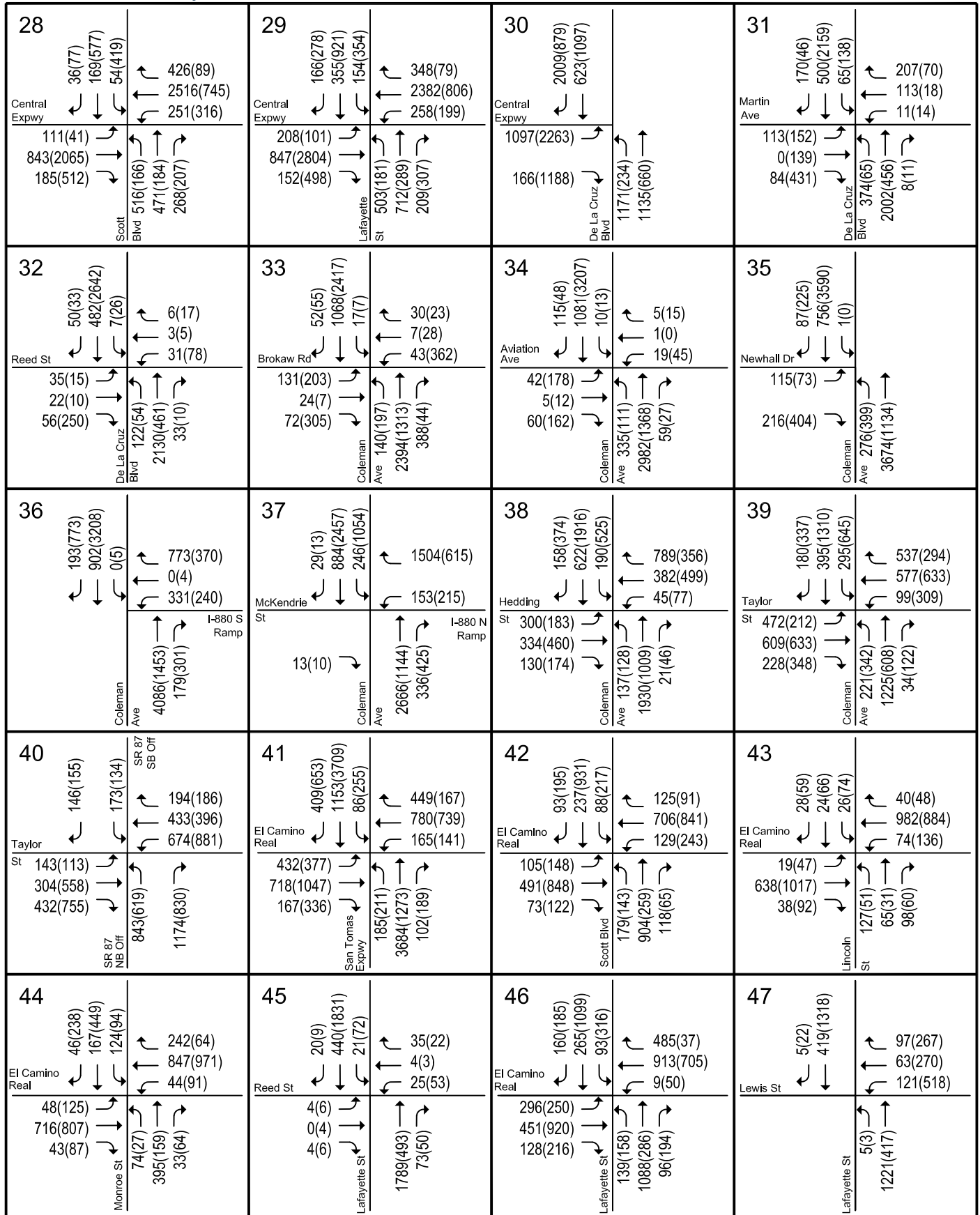

LEGEND

XX(XX) = AM(PM) Peak-Hour Traffic Volumes

**Figure 16**  
**2025 Background Conditions Traffic Volumes - Santa Clara Station**

Phase II Extension Project TIA

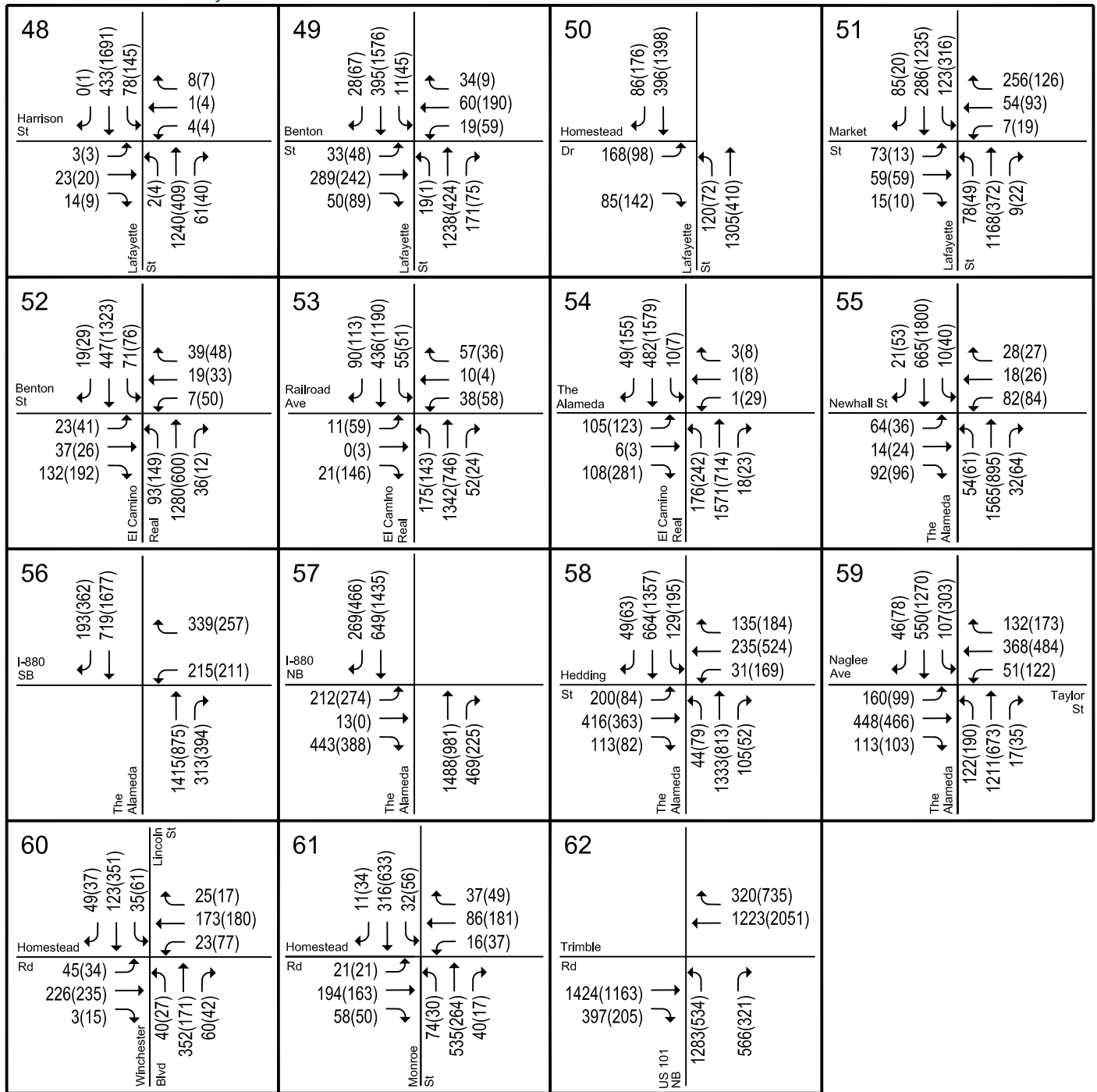

LEGEND

XX(X) = AM(PM) Peak-Hour Traffic Volumes

Figure 16  
2025 Background Conditions Traffic Volumes - Santa Clara Station

## Santa Clara Station

The results of the level of service analysis under 2025 Background Conditions for the Santa Clara Station are summarized in Table 10. Of the 35 study intersections in the vicinity of the Santa Clara Station, 22 are located in the City of Santa Clara and 13 are located in the City of San Jose.

### City of San Jose Level of Service Analysis

The results of the level of service analysis under 2025 Background Conditions show that, measured against the City of San Jose level of service policy, all but three of the Santa Clara Station study intersections located within San Jose would operate at an acceptable level of service (LOS D or better) during both the AM and PM peak hours of traffic. The following three intersections would operate at unacceptable levels of service (LOS E or worse) under 2025 Background Conditions during at least one peak hour:

- (#36) Coleman Avenue and I-880 Southbound Ramps \* (LOS F – AM peak hour)
- (#37) Coleman Avenue and I-880 Northbound Ramps \* (LOS F – AM peak hour)
- (#39) Coleman Avenue and Taylor Street (LOS E – AM and PM peak hours)

### City of Santa Clara Level of Service Analysis

The results of the level of service analysis under 2025 Background Conditions show that, measured against the City of Santa Clara level of service standards, all except three of the Santa Clara Station study intersections located within Santa Clara would operate at an acceptable level of service (LOS D or better at local intersections and LOS E or better at expressway and CMP intersections) during both the AM and PM peak hours of traffic. The following three intersections would operate at unacceptable levels of service (LOS E or worse for local intersections and LOS F for expressways and CMP intersections) under 2025 Background Conditions during at least one peak hour:

- (#30) De La Cruz Boulevard and Central Expressway \* (LOS F – AM and PM peak hours)
- (#33) Coleman Avenue and Brokaw Road (LOS E – PM peak hour)
- (#41) San Tomas Expressway and El Camino Real \* (LOS F – AM and PM peak hours)

The unsignalized intersection of Lafayette Street and Harrison Street (#48) has two-way stop control. The level of service shown for this intersection on Table 10, LOS F in both the AM and PM peak hours, reflects the delay and the level of service for the stop-controlled approach with the highest delay, not the average of the entire intersection. Because the City of Santa Clara does not have a level of service standard for unsignalized intersections, this intersection cannot be said to operate at an unacceptable level of service. The level of service is presented for informational purposes only. The peak-hour traffic signal warrant checks for this intersection are included in Chapter 5.

### CMP Level of Service Analysis

The results of the level of service analysis show that, measured against the CMP level of service standards, all except four of the CMP study intersections in the vicinity of Santa Clara Station would operate at an acceptable level of service (LOS E or better) during both the AM and PM peak hours of traffic. The following CMP intersections would operate at unacceptable levels of service (LOS F) under 2025 Background Conditions during at least one peak hour:

- (#30) De La Cruz Boulevard and Central Expressway \* (LOS F – AM and PM peak hours)
- (#36) Coleman Avenue and I-880 Southbound Ramps \* (LOS F – AM peak hour)
- (#37) Coleman Avenue and I-880 Northbound Ramps \* (LOS F – AM peak hour)
- (#41) San Tomas Expressway and El Camino Real \* (LOS F – AM and PM peak hours)



**Table 9**  
**2025 Background Conditions Intersection Levels of Service – Alum Rock/28<sup>th</sup> Street**

| Study Number | Intersection                                 | Peak Hour | Count Date | 2015 Existing     |     | 2025 Background   |     |
|--------------|--|-----------|------------|-------------------|-----|-------------------|-----|
|              |  |           |            | Avg. Delay (sec.) | LOS | Avg. Delay (sec.) | LOS |
| 1            | 21st St & E. Julian St                       | AM        | 10/09/14   | 23.2              | C   | 23.8              | C   |
|              |  | PM        | 10/09/14   | 12.7              | B   | 12.7              | B   |
| 2            | 24th St & E. Julian St                       | AM        | 10/09/14   | 17.2              | B   | 17.5              | B   |
|              |  | PM        | 10/09/14   | 17.1              | B   | 17.4              | B   |
| 3            | N. 28th St & E. Julian St                    | AM        | 04/09/15   | 27.2              | C   | 27.2              | C   |
|              |  | PM        | 04/09/15   | 14.2              | B   | 14.2              | B   |
| 4            | US 101 SB ramps & E. Julian St               | AM        | 10/09/14   | 23.1              | C   | 26.9              | C   |
|              |  | PM        | 10/09/14   | 26.8              | C   | 30.8              | C   |
| 5            | US 101 NB ramps & McKee Rd                   | AM        | 10/09/14   | 6.5               | A   | 23.0              | C   |
|              |  | PM        | 10/09/14   | 9.3               | A   | 28.6              | C   |
| 6            | 33rd St & McKee Rd                           | AM        | 05/21/15   | 5.7               | A   | 34.0              | C   |
|              |  | PM        | 05/20/15   | 4.6               | A   | 28.7              | C   |
| 7            | King Rd & McKee Rd                           | AM        | 10/09/14   | 19.5              | B   | 52.6              | D   |
|              |  | PM        | 10/08/14   | 21.1              | C   | 51.9              | D   |
| 8            | Jackson Ave & McKee Rd                       | AM        | 05/21/15   | 16.5              | B   | 40.0              | D   |
|              |  | PM        | 05/20/15   | 14.4              | B   | 40.9              | D   |
| 9            | 17th St & E. Santa Clara St                  | AM        | 10/09/14   | 6.5               | A   | 17.1              | B   |
|              |  | PM        | 10/09/14   | 9.3               | A   | 19.8              | B   |
| 10           | 21st St & E. Santa Clara St                  | AM        | 10/09/14   | 11.5              | A   | 5.7               | A   |
|              |  | PM        | 10/09/14   | 16.2              | A   | 4.6               | A   |
| 11           | 24th St & E. Santa Clara St                  | AM        | 11/05/13   | 11.0              | B   | 19.7              | B   |
|              |  | PM        | 11/05/13   | 15.9              | C   | 21.4              | C   |
| 12           | 26th St. & E. Santa Clara St                 | AM        | 10/09/14   | 21.4              | B   | 16.5              | B   |
|              |  | PM        | 10/09/14   | 18.5              | B   | 14.4              | B   |
| 13           | N. 28th St & E. Santa Clara St               | AM        | 10/09/14   | 20.9              | C   | 20.9              | C   |
|              |  | PM        | 10/09/14   | 18.4              | B   | 18.4              | B   |
| 14           | US 101 & E. Santa Clara St *                 | AM        | 10/09/14   | 11.5              | B   | 11.8              | B   |
|              |  | PM        | 09/09/14   | 16.2              | B   | 16.3              | B   |
| 15           | US 101 & Alum Rock Ave *                     | AM        | 10/09/14   | 11.0              | B   | 11.0              | B   |
|              |  | PM        | 09/09/14   | 15.9              | B   | 15.9              | B   |
| 16           | 33rd St & Alum Rock Rd                       | AM        | 05/21/15   | 21.4              | C   | 21.4              | C   |
|              |  | PM        | 05/20/15   | 18.5              | B   | 18.7              | B   |
| 17           | King Rd & Alum Rock Ave *                    | AM        | 05/19/15   | 30.1              | C   | 30.9              | C   |
|              |  | PM        | 09/16/14   | 34.4              | C   | 36.0              | D   |
| 18           | Jackson Ave & Alum Rock Ave *                | AM        | 05/21/15   | 37.8              | D   | 42.8              | D   |
|              |  | PM        | 09/30/14   | 43.0              | D   | 46.7              | D   |
| 19           | I-680 S & Alum Rock Ave (West) *             | AM        | 05/21/15   | 22.2              | C   | 21.7              | C   |
|              |  | PM        | 09/25/14   | 26.6              | C   | 26.5              | C   |
| 20           | I-680 N & Alum Rock Ave (East) *             | AM        | 05/21/15   | 20.9              | C   | 21.3              | C   |
|              |  | PM        | 09/25/14   | 26.3              | C   | 26.4              | C   |
| 21           | 24th St & San Antonio St                     | AM        | 10/09/14   | 16.0              | B   | 16.0              | B   |
|              |  | PM        | 10/09/14   | 12.6              | B   | 12.5              | B   |
| 22           | King Rd & E. San Antonio St.                 | AM        | 05/21/15   | 32.7              | C   | 32.7              | C   |
|              |  | PM        | 05/20/15   | 33.8              | C   | 33.8              | C   |
| 23           | Jackson Ave & E. San Antonio St/Capitol Expy | AM        | 05/21/15   | 35.7              | D   | 38.8              | D   |
|              |  | PM        | 05/20/15   | 34.7              | C   | 35.2              | D   |
| 24           | 24th St & E. William St.                     | AM        | 10/09/14   | 15.8              | B   | 15.9              | B   |
|              |  | PM        | 10/09/14   | 19.4              | B   | 19.4              | B   |
| 25           | McLaughlin Ave & I-280 SB Ramp *             | AM        | 10/09/14   | 9.5               | A   | 9.9               | A   |
|              |  | PM        | 09/24/14   | 14.5              | B   | 15.1              | B   |
| 26           | McLaughlin Ave & Story Rd                    | AM        | 10/09/14   | 42.4              | D   | 43.2              | D   |
|              |  | PM        | 10/09/14   | 48.5              | D   | 52.2              | D   |
| 27           | King Rd & Mabury Rd                          | AM        | 10/08/14   | 39.7              | D   | 43.2              | D   |
|              |  | PM        | 10/08/14   | 38.9              | D   | 42.3              | D   |

**Notes:**  
\* Denotes a CMP intersection  
**Bold** indicates a substandard level of service (according to City of San Jose standards).

**Table 10**  
**2025 Background Conditions Intersection Levels of Service – Santa Clara**

| Study Number | Intersection                                | Location    | Peak Hour | Count Date | 2015 Existing     |          | 2025 Background   |          |
|--------------|---|-------------|-----------|------------|-------------------|----------|-------------------|----------|
|              |   |             |           |            | Avg. Delay (sec.) | LOS      | Avg. Delay (sec.) | LOS      |
| 28           | Scott Blvd & Central Expy *                 | Santa Clara | AM        | 05/21/15   | 43.8              | D        | 42.9              | D        |
|              |   |             | PM        | 10/02/14   | 64.1              | E        | 75.5              | E        |
| 29           | Lafayette St & Central Expy *               | Santa Clara | AM        | 05/21/15   | 53.7              | D        | 51.3              | D        |
|              |   |             | PM        | 09/24/14   | 71.1              | E        | 68.7              | E        |
| 30           | De La Cruz Blvd & Central Expy *            | Santa Clara | AM        | 10/08/14   | <b>270.6</b>      | <b>F</b> | <b>310.3</b>      | <b>F</b> |
|              |   |             | PM        | 10/02/14   | <b>95.8</b>       | <b>F</b> | <b>101.2</b>      | <b>F</b> |
| 31           | De La Cruz Blvd & Martin Ave                | Santa Clara | AM        | 10/08/14   | 34.9              | C        | 34.8              | C        |
|              |   |             | PM        | 10/08/14   | 30.7              | C        | 31.8              | C        |
| 32           | De La Cruz Blvd & Reed St                   | Santa Clara | AM        | 10/08/14   | 11.1              | B        | 10.7              | B        |
|              |   |             | PM        | 10/08/14   | 18.1              | B        | 19.0              | B        |
| 33           | Coleman Ave & Brokaw Rd                     | Santa Clara | AM        | 10/08/14   | 17.0              | B        | 17.2              | B        |
|              |   |             | PM        | 10/08/14   | <b>88.0</b>       | <b>F</b> | <b>57.9</b>       | <b>E</b> |
| 34           | Coleman Ave & Aviation Ave                  | San Jose    | AM        | 10/08/14   | 14.6              | B        | 31.3              | C        |
|              |   |             | PM        | 10/08/14   | 7.2               | A        | 18.2              | B        |
| 35           | Coleman Ave & Newhall Dr                    | San Jose    | AM        | 10/08/14   | 13.6              | B        | 14.2              | B        |
|              |   |             | PM        | 10/08/14   | 18.1              | B        | 24.6              | C        |
| 36           | Coleman Ave & I-880 SB Ramps *              | San Jose    | AM        | 05/12/15   | 24.7              | C        | <b>107.9</b>      | <b>F</b> |
|              |   |             | PM        | 09/25/14   | 11.6              | B        | 43.6              | D        |
| 37           | Coleman Ave & I-880 NB Ramps *              | San Jose    | AM        | 05/12/15   | 37.3              | D        | <b>85.8</b>       | <b>F</b> |
|              |   |             | PM        | 09/25/14   | 26.2              | C        | 32.6              | C        |
| 38           | Coleman Ave & W. Hedding St                 | San Jose    | AM        | 05/12/15   | 41.0              | D        | 41.2              | D        |
|              |   |             | PM        | 05/12/15   | 38.1              | D        | 36.7              | D        |
| 39           | Coleman Ave & W. Taylor St                  | San Jose    | AM        | 05/12/15   | 45.0              | D        | <b>60.0</b>       | <b>E</b> |
|              |   |             | PM        | 05/12/15   | 44.7              | D        | <b>63.7</b>       | <b>E</b> |
| 40           | SR 87 & W. Taylor St                        | San Jose    | AM        | 05/12/15   | 24.2              | C        | 28.7              | C        |
|              |   |             | PM        | 05/12/15   | 32.6              | C        | 38.5              | D        |
| 41           | San Tomas Expy & El Camino Real *           | Santa Clara | AM        | 10/08/14   | 66.1              | E        | <b>83.8</b>       | <b>F</b> |
|              |   |             | PM        | 09/23/14   | 79.7              | E        | <b>129.5</b>      | <b>F</b> |
| 42           | Scott Blvd & El Camino Real *               | Santa Clara | AM        | 10/08/14   | 33.8              | C        | 34.1              | C        |
|              |   |             | PM        | 09/17/14   | 37.7              | D        | 38.4              | D        |
| 43           | Lincoln St & El Camino Real *               | Santa Clara | AM        | 05/21/15   | 21.1              | C        | 20.9              | C        |
|              |   |             | PM        | 09/17/14   | 23.1              | C        | 23.6              | C        |
| 44           | Monroe St & El Camino Real *                | Santa Clara | AM        | 10/08/14   | 35.5              | D        | 35.8              | D        |
|              |   |             | PM        | 09/17/14   | 32.9              | C        | 33.4              | C        |
| 45           | Lafayette St & Reed St                      | Santa Clara | AM        | 01/01/13   | 6.8               | A        | 7.3               | A        |
|              |   |             | PM        | 01/01/13   | 7.4               | A        | 7.5               | A        |
| 46           | Lafayette St & El Camino Real *             | Santa Clara | AM        | 10/08/14   | 40.8              | D        | 43.0              | D        |
|              |   |             | PM        | 09/17/14   | 41.3              | D        | 43.0              | D        |
| 47           | Lafayette St & Lewis St                     | Santa Clara | AM        | 10/08/14   | 10.7              | B        | 10.0              | B        |
|              |   |             | PM        | 10/08/14   | 31.9              | C        | 45.8              | D        |
| 48           | Lafayette St & Harrison St Unsignalized (3) | Santa Clara | AM        | 10/08/14   | 48.9              | E        | 69.9              | F        |
|              |   |             | PM        | 10/08/14   | 176.9             | F        | 304.2             | F        |
| 49           | Lafayette St & Benton St                    | Santa Clara | AM        | 10/08/14   | 17.1              | B        | 17.2              | B        |
|              |   |             | PM        | 10/08/14   | 15.7              | B        | 17.8              | B        |
| 50           | Lafayette St & Homestead Rd                 | Santa Clara | AM        | 05/21/15   | 19.1              | B        | 26.6              | C        |
|              |   |             | PM        | 05/20/15   | 9.7               | A        | 9.3               | A        |
| 51           | Lafayette St & Market St                    | Santa Clara | AM        | 05/21/15   | 16.6              | B        | 17.3              | B        |
|              |   |             | PM        | 05/20/15   | 24.6              | C        | 25.2              | C        |
| 52           | El Camino Real & Benton St                  | Santa Clara | AM        | 10/08/14   | 12.8              | B        | 12.6              | B        |
|              |   |             | PM        | 10/08/14   | 15.4              | B        | 15.4              | B        |
| 53           | El Camino Real & Railroad Ave               | Santa Clara | AM        | 10/08/14   | 10.5              | B        | 10.5              | B        |
|              |   |             | PM        | 10/08/14   | 12.4              | B        | 12.4              | B        |
| 54           | El Camino Real & The Alameda *              | Santa Clara | AM        | 10/08/14   | 13.0              | B        | 13.0              | B        |
|              |   |             | PM        | 09/17/14   | 17.2              | B        | 17.0              | B        |
| 55           | The Alameda & Newhall Dr                    | San Jose    | AM        | 05/21/15   | 12.5              | B        | 12.4              | B        |
|              |   |             | PM        | 05/20/15   | 12.6              | B        | 12.6              | B        |
| 56           | The Alameda & I-880 (South) *               | San Jose    | AM        | 05/07/15   | 19.2              | B        | 20.5              | C        |
|              |   |             | PM        | 09/25/14   | 14.6              | B        | 15.2              | B        |
| 57           | The Alameda & I-880 (North) *               | San Jose    | AM        | 05/07/15   | 23.2              | C        | 24.4              | C        |
|              |   |             | PM        | 09/25/14   | 21.2              | C        | 21.1              | C        |
| 58           | The Alameda & W. Hedding St *               | San Jose    | AM        | 05/21/15   | 37.2              | D        | 39.2              | D        |
|              |   |             | PM        | 09/30/14   | 38.0              | D        | 39.3              | D        |
| 59           | The Alameda & W. Taylor St/Naglee Ave *     | San Jose    | AM        | 05/21/15   | 42.3              | D        | 42.7              | D        |
|              |   |             | PM        | 09/30/14   | 40.5              | D        | 46.7              | D        |
| 60           | Homestead Rd & Lincoln St/Winchester Blvd   | Santa Clara | AM        | 05/21/15   | 21.3              | C        | 21.5              | C        |
|              |   |             | PM        | 05/20/15   | 21.4              | C        | 21.6              | C        |
| 61           | Homestead Rd & Monroe St                    | Santa Clara | AM        | 05/21/15   | 9.8               | A        | 9.9               | A        |
|              |   |             | PM        | 05/20/15   | 10.5              | B        | 10.5              | B        |
| 62           | US 101 & Trimble                            | San Jose    | AM        | 10/07/14   | 21.8              | C        | 22.8              | C        |
|              |   |             | PM        | 10/07/14   | 13.6              | B        | 13.1              | B        |

**Notes:**  
 \* Denotes a CMP intersection  
 (1) The reported delay and corresponding level of service for signalized intersections represent the average delay for all approaches at the intersection. The reported delay and corresponding level of service for unsignalized (two-way stop-controlled) intersections are based on the stop-controlled approach with the highest delay.  
**Bold** indicates a substandard level of service (according to City of San Jose or City of Santa Clara standards).

## Freeway Levels of Service under 2025 Background Conditions

Traffic volumes for the study freeway segments for 2025 Background Conditions were projected by the VTA Travel Demand Forecasting Model. The 2025 Background Conditions level of service for mixed-flow lanes and for High Occupancy Vehicle (HOV) lanes on all 64 directional freeway segments are summarized in Table 11.

The results show that:

- 16 of the 20 mixed-flow directional segments and 11 HOV directional segments on US 101 are projected to operate at an unacceptable LOS F during at least one peak hour.
- 10 of the 12 mixed-flow directional segments on I-280 are projected to operate at an unacceptable LOS F during at least one peak hour.
- 6 of the 8 mixed flow directional segments on I-680 are projected to operate at an unacceptable LOS F during at least one peak hour.
- 9 of the 10 mixed-flow directional segments and 1 HOV directional segment on SR 87 are projected to operate at an unacceptable LOS F during at least one peak hour.
- 12 of 14 mixed-flow directional segments on I-880 are projected to operate at an unacceptable LOS F during at least one peak hour.

**Table 11**  
**2025 Background Conditions Freeway Levels of Service**

| Freeway | Segment                   | Direction | Peak Hour | Mixed-Flow Lane |            |        |            |     | HOV Lane   |            |        |            |     |
|---------|---------------------------|-----------|-----------|-----------------|------------|--------|------------|-----|------------|------------|--------|------------|-----|
|         |                           |           |           | Avg. Speed      | # of Lanes | Volume | Density    | LOS | Avg. Speed | # of Lanes | Volume | Density    | LOS |
| US 101  | Tully to Story            | NB        | AM        | 25.0            | 3.0        | 8,782  | <b>117</b> | F   | 15.0       | 1.0        | 2031   | <b>135</b> | F   |
|         |                           |           | PM        | 66.0            | 3.0        | 7,569  | 38         | D   | 70.0       | 1.0        | 1180   | 17         | B   |
| US 101  | Story to I-280            | NB        | AM        | 22.0            | 3.0        | 5,098  | <b>77</b>  | F   | 19.0       | 1.0        | 1528   | <b>80</b>  | F   |
|         |                           |           | PM        | 67.0            | 3.0        | 3,751  | 19         | C   | 70.0       | 1.0        | 756    | 11         | A   |
| US 101  | I-280 to Santa Clara      | NB        | AM        | 13.0            | 3.0        | 7,614  | <b>195</b> | F   | 13.0       | 1.0        | 1761   | <b>135</b> | F   |
|         |                           |           | PM        | 66.0            | 3.0        | 5,428  | 27         | D   | 70.0       | 1.0        | 808    | 12         | B   |
| US 101  | Santa Clara to McKee      | NB        | AM        | 11.0            | 3.0        | 7,921  | <b>240</b> | F   | 16.0       | 1.0        | 1527   | <b>95</b>  | F   |
|         |                           |           | PM        | 66.0            | 3.0        | 5,340  | 27         | D   | 70.0       | 1.0        | 719    | 10         | A   |
| US 101  | I-880 to Old Bayshore     | NB        | AM        | 14.0            | 3.0        | 5,900  | <b>140</b> | F   | 19.0       | 1.0        | 1794   | <b>94</b>  | F   |
|         |                           |           | PM        | 67.0            | 3.0        | 3,747  | 19         | C   | 70.0       | 1.0        | 627    | 9          | A   |
| US 101  | Old Bayshore to First     | NB        | AM        | 12.0            | 3.0        | 6,255  | <b>174</b> | F   | 13.0       | 1.0        | 1715   | <b>132</b> | F   |
|         |                           |           | PM        | 66.0            | 3.0        | 4,226  | 21         | C   | 70.0       | 1.0        | 632    | 9          | A   |
| US 101  | First to SR 87            | NB        | AM        | 19.0            | 3.0        | 6,824  | <b>120</b> | F   | 19.0       | 1.0        | 1573   | <b>83</b>  | F   |
|         |                           |           | PM        | 67.0            | 3.0        | 5,178  | 26         | C   | 70.0       | 1.0        | 744    | 11         | A   |
| US 101  | SR 87 to De La Cruz       | NB        | AM        | 12.0            | 3.0        | 6,658  | <b>185</b> | F   | 14.0       | 1.0        | 1482   | <b>106</b> | F   |
|         |                           |           | PM        | 66.0            | 3.0        | 5,427  | 27         | D   | 70.0       | 1.0        | 744    | 11         | A   |
| US 101  | De La Cruz to Montague    | NB        | AM        | 26.0            | 3.0        | 6,349  | <b>81</b>  | F   | 39.0       | 1.0        | 2026   | 52         | E   |
|         |                           |           | PM        | 65.0            | 3.0        | 5,481  | 28         | D   | 70.0       | 1.0        | 1201   | 17         | B   |
| US 101  | Montague to Great America | NB        | AM        | 21.0            | 3.0        | 6,722  | <b>107</b> | F   | 41.0       | 1.0        | 1695   | 41         | D   |
|         |                           |           | PM        | 58.0            | 3.0        | 5,829  | 34         | D   | 70.0       | 1.0        | 1260   | 18         | B   |
| US 101  | Great America to Montague | SB        | AM        | 66.0            | 3.0        | 6,100  | 31         | D   | 67.0       | 1.0        | 1219   | 18         | B   |
|         |                           |           | PM        | 14.0            | 3.0        | 6,858  | <b>163</b> | F   | 20.0       | 1.0        | 1760   | <b>88</b>  | F   |
| US 101  | Montague to De La Cruz    | SB        | AM        | 66.0            | 3.0        | 5,528  | 28         | D   | 67.0       | 1.0        | 1133   | 17         | B   |
|         |                           |           | PM        | 13.0            | 3.0        | 6,306  | <b>162</b> | F   | 40.0       | 1.0        | 1949   | 49         | E   |
| US 101  | De La Cruz to SR 87       | SB        | AM        | 62.0            | 3.0        | 6,620  | 36         | D   | 67.0       | 1.0        | 1051   | 16         | B   |
|         |                           |           | PM        | 18.0            | 3.0        | 8,087  | <b>150</b> | F   | 50.0       | 1.0        | 2003   | 40         | D   |
| US 101  | SR 87 to First            | SB        | AM        | 67.0            | 3.0        | 4,708  | 23         | C   | 67.0       | 1.0        | 820    | 12         | B   |
|         |                           |           | PM        | 16.0            | 3.0        | 5,994  | <b>125</b> | F   | 30.0       | 1.0        | 1762   | <b>59</b>  | F   |
| US 101  | First to Old Bayshore     | SB        | AM        | 67.0            | 3.0        | 3,513  | 17         | B   | 67.0       | 1.0        | 588    | 9          | A   |
|         |                           |           | PM        | 6.0             | 3.0        | 4,844  | <b>269</b> | F   | 20.0       | 1.0        | 1507   | <b>75</b>  | F   |
| US 101  | Old Bayshore to I-880     | SB        | AM        | 67.0            | 3.0        | 4,420  | 22         | C   | 67.0       | 1.0        | 640    | 10         | A   |
|         |                           |           | PM        | 8.0             | 3.0        | 6,045  | <b>252</b> | F   | 30.0       | 1.0        | 1730   | 58         | E   |
| US 101  | McKee to Santa Clara      | SB        | AM        | 67.0            | 3.0        | 4,876  | 24         | C   | 67.0       | 1.0        | 585    | 9          | A   |
|         |                           |           | PM        | 62.0            | 3.0        | 6,883  | 37         | D   | 70.0       | 1.0        | 1557   | 22         | C   |
| US 101  | Santa Clara to I-280      | SB        | AM        | 67.0            | 3.0        | 5,496  | 27         | D   | 67.0       | 1.0        | 651    | 10         | A   |
|         |                           |           | PM        | 63.0            | 3.0        | 7,295  | 39         | D   | 70.0       | 1.0        | 1671   | 24         | C   |
| US 101  | I-280 to Story            | SB        | AM        | 67.0            | 3.0        | 3,586  | 18         | B   | 67.0       | 1.0        | 572    | 9          | A   |
|         |                           |           | PM        | 54.0            | 3.0        | 5,048  | 31         | D   | 70.0       | 1.0        | 1276   | 18         | B   |
| US 101  | Story to Tully            | SB        | AM        | 66.0            | 4.0        | 8,175  | 31         | D   | 67.0       | 1.0        | 851    | 13         | B   |
|         |                           |           | PM        | 45.0            | 4.0        | 10,019 | 56         | E   | 70.0       | 1.0        | 1611   | 23         | C   |
| I-280   | I-880 to Meridian         | EB        | AM        | 66.0            | 4.0        | 6,444  | 24         | C   | 67.0       | 1.0        | 547    | 8          | A   |
|         |                           |           | PM        | 17.0            | 4.0        | 6,886  | <b>101</b> | F   | 20.0       | 1.0        | 840    | 42         | D   |
| I-280   | Meridian to Bird          | EB        | AM        | 61.0            | 4.0        | 8,651  | 35         | D   | ---        | ---        | ---    | ---        | --- |
|         |                           |           | PM        | 21.0            | 4.0        | 9,367  | <b>112</b> | F   | ---        | ---        | ---    | ---        | --- |
| I-280   | Bird to SR 87             | EB        | AM        | 66.0            | 4.0        | 4,689  | 18         | B   | ---        | ---        | ---    | ---        | --- |
|         |                           |           | PM        | 25.0            | 4.0        | 5,974  | <b>60</b>  | F   | ---        | ---        | ---    | ---        | --- |
| I-280   | SR 87 to 10th             | EB        | AM        | 67.0            | 4.0        | 6,435  | 24         | C   | ---        | ---        | ---    | ---        | --- |
|         |                           |           | PM        | 27.0            | 4.0        | 8,504  | <b>79</b>  | F   | ---        | ---        | ---    | ---        | --- |
| I-280   | 10th to McLaughlin        | EB        | AM        | 66.0            | 4.0        | 7,635  | 29         | D   | ---        | ---        | ---    | ---        | --- |
|         |                           |           | PM        | 54.0            | 4.0        | 10,240 | 47         | E   | ---        | ---        | ---    | ---        | --- |
| I-280   | McLaughlin to US 101      | EB        | AM        | 66.0            | 4.0        | 5,653  | 21         | C   | ---        | ---        | ---    | ---        | --- |
|         |                           |           | PM        | 54.0            | 4.0        | 6,816  | 32         | D   | ---        | ---        | ---    | ---        | --- |
| I-680   | US 101 to King            | NB        | AM        | 33.0            | 4.0        | 5,583  | 42         | D   | ---        | ---        | ---    | ---        | --- |
|         |                           |           | PM        | 66.0            | 4.0        | 6,605  | 25         | C   | ---        | ---        | ---    | ---        | --- |
| I-680   | King to Capitol           | NB        | AM        | 20.0            | 5.0        | 7,726  | <b>77</b>  | F   | 55.0       | 1.0        | 423    | 8          | A   |
|         |                           |           | PM        | 47.0            | 5.0        | 9,745  | 41         | D   | 55.0       | 1.0        | 386    | 7          | A   |
| I-680   | Capitol to Alum Rock      | NB        | AM        | 18.0            | 4.0        | 6,243  | <b>87</b>  | F   | 55.0       | 1.0        | 423    | 8          | A   |
|         |                           |           | PM        | 65.0            | 4.0        | 6,450  | 25         | C   | 55.0       | 1.0        | 386    | 7          | A   |
| I-680   | Alum Rock to McKee        | NB        | AM        | 27.0            | 4.0        | 7,242  | <b>67</b>  | F   | 55.0       | 1.0        | 619    | 11         | A   |
|         |                           |           | PM        | 66.0            | 4.0        | 6,975  | 26         | C   | 55.0       | 1.0        | 495    | 9          | A   |

Source: Santa Clara Valley Transportation Authority Congestion Management Program Monitoring Study, 2014.  
The average speed for future HOV lanes are assumed to be 55 MPH.  
**Bold** indicates unacceptable LOS.

**Table 11, Continued**  
**2025 Background Conditions Freeway Levels of Service**

| Freeway | Segment                       | Direction | Peak Hour | Mixed-Flow Lane |            |        |            |     | HOV Lane   |            |        |           |     |
|---------|-------------------------------|-----------|-----------|-----------------|------------|--------|------------|-----|------------|------------|--------|-----------|-----|
|         |                               |           |           | Avg. Speed      | # of Lanes | Volume | Density    | LOS | Avg. Speed | # of Lanes | Volume | Density   | LOS |
| I-680   | McKee to Alum Rock            | SB        | AM        | 63.0            | 4.0        | 6,752  | 27         | D   | 55.0       | 1.0        | 493    | 9         | A   |
|         |                               |           | PM        | 47.0            | 4.0        | 7,420  | 39         | D   | 55.0       | 1.0        | 500    | 9         | A   |
| I-680   | Alum Rock to Capitol          | SB        | AM        | 23.0            | 4.0        | 6,513  | <b>71</b>  | F   | 55.0       | 1.0        | 493    | 9         | A   |
|         |                               |           | PM        | 65.0            | 4.0        | 5,683  | 22         | C   | 55.0       | 1.0        | 500    | 9         | A   |
| I-680   | Capitol to King               | SB        | AM        | 21.0            | 4.0        | 9,578  | <b>114</b> | F   | 55.0       | 1.0        | 356    | 6         | A   |
|         |                               |           | PM        | 66.0            | 4.0        | 7,710  | 29         | D   | 55.0       | 1.0        | 223    | 4         | A   |
| I-680   | King to US 101                | SB        | AM        | 12.0            | 4.0        | 6,605  | <b>138</b> | F   | ---        | ---        | ---    | ---       | --- |
|         |                               |           | PM        | 66.0            | 4.0        | 5,330  | 20         | C   | ---        | ---        | ---    | ---       | --- |
| I-280   | US 101 to McLaughlin          | WB        | AM        | 14.0            | 4.0        | 6,605  | <b>118</b> | F   | ---        | ---        | ---    | ---       | --- |
|         |                               |           | PM        | 66.0            | 4.0        | 5,330  | 20         | C   | ---        | ---        | ---    | ---       | --- |
| I-280   | McLaughlin to 10th            | WB        | AM        | 19.0            | 4.0        | 10,700 | <b>141</b> | F   | ---        | ---        | ---    | ---       | --- |
|         |                               |           | PM        | 65.0            | 4.0        | 8,012  | 31         | D   | ---        | ---        | ---    | ---       | --- |
| I-280   | 10th to SR 87                 | WB        | AM        | 21.0            | 4.0        | 10,147 | <b>121</b> | F   | ---        | ---        | ---    | ---       | --- |
|         |                               |           | PM        | 65.0            | 4.0        | 8,331  | 32         | D   | ---        | ---        | ---    | ---       | --- |
| I-280   | SR 87 to Bird                 | WB        | AM        | 20.0            | 4.0        | 6,191  | <b>77</b>  | F   | ---        | ---        | ---    | ---       | --- |
|         |                               |           | PM        | 62.0            | 4.0        | 5,318  | 21         | C   | ---        | ---        | ---    | ---       | --- |
| I-280   | Bird to Meridian              | WB        | AM        | 18.0            | 4.0        | 9,752  | <b>135</b> | F   | ---        | ---        | ---    | ---       | --- |
|         |                               |           | PM        | 58.0            | 4.0        | 8,914  | 38         | D   | ---        | ---        | ---    | ---       | --- |
| I-280   | Meridian to I-880             | WB        | AM        | 14.0            | 3.0        | 7,295  | <b>174</b> | F   | 26.0       | 1.0        | 776    | 30        | D   |
|         |                               |           | PM        | 66.0            | 3.0        | 6,445  | 33         | D   | 70.0       | 1.0        | 465    | 7         | A   |
| SR 87   | Curtner to Almaden Expressway | NB        | AM        | 13.0            | 2.0        | 3,772  | <b>145</b> | F   | 22.0       | 1.0        | 1736   | <b>79</b> | F   |
|         |                               |           | PM        | 65.0            | 2.0        | 3,161  | 24         | C   | 70.0       | 1.0        | 669    | 10        | A   |
| SR 87   | Almaden Expressway to Alma    | NB        | AM        | 29.0            | 2.0        | 4,700  | <b>81</b>  | F   | 43.0       | 1.0        | 1993   | 46        | D   |
|         |                               |           | PM        | 41.0            | 2.0        | 3,890  | 47         | E   | 70.0       | 1.0        | 731    | 10        | A   |
| SR 87   | Alma to I-280                 | NB        | AM        | 33.0            | 2.0        | 5,651  | <b>86</b>  | F   | 61.0       | 1.0        | 2015   | 33        | D   |
|         |                               |           | PM        | 66.0            | 2.0        | 4,362  | 33         | D   | 70.0       | 1.0        | 797    | 11        | A   |
| SR 87   | I-280 to Julian               | NB        | AM        | 16.0            | 2.0        | 3,320  | <b>104</b> | F   | 30.0       | 1.0        | 1314   | 44        | D   |
|         |                               |           | PM        | 67.0            | 2.0        | 1,800  | 13         | B   | 70.0       | 1.0        | 400    | 6         | A   |
| SR 87   | Julian to Coleman             | NB        | AM        | 14.0            | 2.0        | 4,595  | <b>164</b> | F   | 32.0       | 1.0        | 1547   | 48        | E   |
|         |                               |           | PM        | 67.0            | 2.0        | 2,767  | 21         | C   | 70.0       | 1.0        | 527    | 8         | A   |
| SR 87   | Coleman to Julian             | SB        | AM        | 66.0            | 2.0        | 2,284  | 17         | B   | 67.0       | 1.0        | 229    | 3         | A   |
|         |                               |           | PM        | 32.0            | 2.0        | 4,013  | <b>63</b>  | F   | 50.0       | 1.0        | 1114   | 22        | C   |
| SR 87   | Julian to I-280               | SB        | AM        | 67.0            | 2.0        | 2,675  | 20         | C   | 67.0       | 1.0        | 293    | 4         | A   |
|         |                               |           | PM        | 36.0            | 2.0        | 4,616  | <b>64</b>  | F   | 70.0       | 1.0        | 1231   | 18        | B   |
| SR 87   | I-280 to Alma                 | SB        | AM        | 67.0            | 2.0        | 3,744  | 28         | D   | 67.0       | 1.0        | 573    | 9         | A   |
|         |                               |           | PM        | 15.0            | 2.0        | 3,794  | <b>126</b> | F   | 60.0       | 1.0        | 1757   | 29        | D   |
| SR 87   | Alma to Almaden Expressway    | SB        | AM        | 66.0            | 2.0        | 3,736  | 28         | D   | 67.0       | 1.0        | 560    | 8         | A   |
|         |                               |           | PM        | 27.0            | 2.0        | 4,425  | <b>82</b>  | F   | 60.0       | 1.0        | 1720   | 29        | D   |
| SR 87   | Almaden Expressway to Curtner | SB        | AM        | 66.0            | 2.0        | 2,866  | 22         | C   | 67.0       | 1.0        | 499    | 7         | A   |
|         |                               |           | PM        | 36.0            | 2.0        | 3,480  | 48         | E   | 70.0       | 1.0        | 1520   | 22        | C   |
| I-880   | I-280 to Stevens Creek        | NB        | AM        | 15.0            | 3.0        | 5,213  | <b>116</b> | F   | 55.0       | 1.0        | 647    | 12        | B   |
|         |                               |           | PM        | 66.0            | 3.0        | 4,764  | 24         | C   | 55.0       | 1.0        | 815    | 15        | B   |
| I-880   | Stevens Creek to Bascom       | NB        | AM        | 20.0            | 3.0        | 6,683  | <b>111</b> | F   | 55.0       | 1.0        | 647    | 12        | B   |
|         |                               |           | PM        | 16.0            | 3.0        | 5,522  | <b>115</b> | F   | 55.0       | 1.0        | 815    | 15        | B   |
| I-880   | Bascom to The Alameda         | NB        | AM        | 27.0            | 3.0        | 6,124  | <b>76</b>  | F   | 55.0       | 1.0        | 695    | 13        | B   |
|         |                               |           | PM        | 13.0            | 3.0        | 6,092  | <b>156</b> | F   | 55.0       | 1.0        | 919    | 17        | B   |
| I-880   | The Alameda to Coleman        | NB        | AM        | 31.0            | 3.0        | 6,375  | <b>69</b>  | F   | 55.0       | 1.0        | 705    | 13        | B   |
|         |                               |           | PM        | 15.0            | 3.0        | 6,463  | <b>144</b> | F   | 55.0       | 1.0        | 1096   | 20        | C   |
| I-880   | Coleman to SR 87              | NB        | AM        | 22.0            | 3.0        | 6,116  | <b>93</b>  | F   | 55.0       | 1.0        | 813    | 15        | B   |
|         |                               |           | PM        | 24.0            | 3.0        | 6,350  | <b>88</b>  | F   | 55.0       | 1.0        | 1279   | 23        | C   |
| I-880   | SR 87 to First                | NB        | AM        | 48.0            | 3.0        | 6,116  | 42         | D   | 55.0       | 1.0        | 813    | 15        | B   |
|         |                               |           | PM        | 22.0            | 3.0        | 6,350  | <b>96</b>  | F   | 55.0       | 1.0        | 1279   | 23        | C   |
| I-880   | First to US 101               | NB        | AM        | 36.0            | 3.0        | 5,750  | 53         | E   | 55.0       | 1.0        | 641    | 12        | B   |
|         |                               |           | PM        | 51.0            | 3.0        | 6,921  | 45         | D   | 55.0       | 1.0        | 1075   | 20        | C   |
| I-880   | US 101 to First               | SB        | AM        | 16.0            | 3.0        | 6,211  | <b>129</b> | F   | 55.0       | 1.0        | 1093   | 20        | C   |
|         |                               |           | PM        | 14.0            | 3.0        | 5,685  | <b>135</b> | F   | 55.0       | 1.0        | 873    | 16        | B   |
| I-880   | First to SR 87                | SB        | AM        | 25.0            | 3.0        | 5,741  | <b>77</b>  | F   | 55.0       | 1.0        | 1140   | 21        | C   |
|         |                               |           | PM        | 14.0            | 3.0        | 5,705  | <b>136</b> | F   | 55.0       | 1.0        | 969    | 18        | B   |
| I-880   | SR 87 to Coleman              | SB        | AM        | 65.0            | 3.0        | 5,741  | 29         | D   | 55.0       | 1.0        | 1140   | 21        | C   |
|         |                               |           | PM        | 23.0            | 3.0        | 5,705  | <b>83</b>  | F   | 55.0       | 1.0        | 969    | 18        | B   |
| I-880   | Coleman to The Alameda        | SB        | AM        | 66.0            | 3.0        | 6,345  | 32         | D   | 55.0       | 1.0        | 912    | 17        | B   |
|         |                               |           | PM        | 23.0            | 3.0        | 6,731  | <b>98</b>  | F   | 55.0       | 1.0        | 869    | 16        | B   |
| I-880   | The Alameda to Bascom         | SB        | AM        | 66.0            | 3.0        | 6,009  | 30         | D   | 55.0       | 1.0        | 842    | 15        | B   |
|         |                               |           | PM        | 25.0            | 3.0        | 6,651  | <b>89</b>  | F   | 55.0       | 1.0        | 928    | 17        | B   |
| I-880   | Bascom to Stevens Creek       | SB        | AM        | 50.0            | 3.0        | 5,835  | 39         | D   | 55.0       | 1.0        | 842    | 15        | B   |
|         |                               |           | PM        | 30.0            | 3.0        | 6,638  | <b>74</b>  | F   | 55.0       | 1.0        | 944    | 17        | B   |
| I-880   | Stevens Creek to I-280        | SB        | AM        | 66.0            | 3.0        | 4,496  | 23         | C   | 55.0       | 1.0        | 734    | 13        | B   |
|         |                               |           | PM        | 65.0            | 3.0        | 4,825  | 25         | C   | 55.0       | 1.0        | 860    | 16        | B   |

Source: Santa Clara Valley Transportation Authority Congestion Management Program Monitoring Study, 2014.  
The average speed for future HOV lanes are assumed to be 55 MPH.  
**Bold** indicates unacceptable LOS.

## 4.

# 2015 and 2025 Project Conditions

---

This chapter describes traffic conditions with the inclusion of trips generated by the Project. This chapter includes the following:

- A discussion of the method by which Project traffic has been estimated;
- The Significant Impact Criteria used by the Cities of San Jose and Santa Clara and by the Congestion Management Program;
- For the study intersections, both 2015 Existing Plus Project and 2025 Background Plus Project scenarios are presented. For both the 2015 Existing Plus Project scenario and the 2025 Background Plus Project scenario, this analysis includes a determination regarding potential project impacts and identifies appropriate mitigation measures for impacted intersections.
- For the freeway segments, both 2015 Existing Plus Project and 2025 Background Plus Project freeway volumes from the VTA Travel Demand Forecasting Model are presented and potential project impacts are identified.

### Project Trip Estimates

The magnitude of traffic produced by a new development and the locations where that traffic would appear are estimated using a three-step process: (1) trip generation, (2) trip distribution, and (3) trip assignment. In determining project trip generation, the magnitude of traffic entering and exiting the site is estimated for the AM and PM peak hours. As part of the project trip distribution, an estimate is made of the directions to and from which the project trips would travel. In the project trip assignment, the project trips are assigned to specific streets. These procedures are described further in the following sections.

### Trip Generation

The trip generation for the Project includes three separate components:

1. The additional trips generated by the Transit-Oriented Joint Development at each station, which are discussed in detail below.
2. The additional trips generated by BART patrons who access the BART stations by vehicle and use the Kiss and Ride or the Park and Ride facilities. These trips are referred to as the *station drive access trips*.
3. The reduction in trips on the roadway network as motorists switch from passenger vehicles to BART. The extension of BART would result in a shift in travel patterns, and this mode shift would result in the removal of some auto trips from the roadways.

The “BART Extension Only TIA” developed trip generation estimates for the last two components of the Project (station drive access trips and mode shift trips), which are incorporated into this TIA. For further information about



how these trip estimates were developed, the reader should refer to the “BART Extension Only TIA”, included as Appendix G.

### **Trip Generation Rates**

Through empirical research, data have been collected that quantify the amount of traffic produced by common land uses. Thus, for the most common land uses there are standard trip generation rates that can be applied to help predict the future traffic increases that would result from a new development. The magnitude of traffic added to the roadway system by a particular development is estimated by multiplying the applicable trip generation rates by the size of the development. Trip generation resulting from new development proposed within the Cities of San Jose and Santa Clara typically is estimated using the trip rates published in the Institute of Transportation Engineers’ (ITE) manual entitled *Trip Generation, 9<sup>th</sup> Edition* (2012).

As shown in Table 12, the ITE rates for offices, apartments, and retail space have been used for the land uses proposed at the Alum Rock/28<sup>th</sup> Street and Santa Clara Station Transit-Oriented Joint Development sites.

### **Transit Trip Reductions**

The VTA *Congestion Management Program Transportation Impact Analysis Guidelines* (October 2014) allow a trip reduction for projects that are located within a 2,000 foot walk of a transit station. Since the TOJD sites examined in this TIA would be literally on top of or right next to a BART station, these sites clearly qualify for the transit trip reduction. The Santa Clara TOJD would not only be on top of the proposed BART station, it would also be just across the tracks from the Santa Clara Transit Center, which is served by Caltrain and numerous bus routes.

The *TIA Guidelines* allow the transit trip reduction for housing and employment near a BART station to be determined on a case-by-case basis, provided that source data and justification for the reduction is provided. However, in order to make this traffic analysis as conservative as possible, we have used the same trip reduction percentages as allowed for housing and employment near light rail transit, bus rapid transit, and Caltrain stations. As shown on Table 12, a 9% trip reduction was taken for the apartment units and a 6% trip reduction was taken for the office space at the Alum Rock/28<sup>th</sup> Street and Santa Clara Stations.

### **Mixed-Use Development Trip Reductions**

A mixed-use development with complementary land uses such as residential and retail will generate and attract trips internally between the uses. Thus, the number of vehicle trips generated for each use may be reduced, since a portion of the trips would not require entering or exiting the site. The *TIA Guidelines* indicates a trip reduction of up to 15% is allowed for residential and retail mixed-use developments. The reduction is applied to the smaller of the two complimentary trip generators (retail use), and the same number of trips is then subtracted from the larger trip generator (residential use) to account for both trip ends. In addition, a 3% reduction from the office space trips was taken, because the Project includes both employment and employee-serving retail uses.

### **Pass-By Trip Reductions**

A retail pass-by trip reduction of 25% (typical for Santa Clara County) also can be applied to the PM peak hour trip generation estimates for the proposed retail space. Pass-by-trips are trips that would already be on the adjacent roadways (and so are already counted in the background traffic) but would turn into the site while passing by. Justification for applying the pass-by-trip reduction is founded on the observation that such retail traffic is not actually generated by the retail development, but is already part of the ambient traffic levels.

### **Total Transit-Oriented Joint Development Project Trips**

Table 12 shows the project trip generation estimates for both the Alum Rock/28<sup>th</sup> Street and Santa Clara Station Transit-Oriented Joint Development sites. It is likely that the transit usage at these TOJD sites would be substantially greater than 9% for the housing residents and 6% for the office space employees (per the transit trip reductions used), and, therefore, these trip generation estimates should be viewed as conservative.

After applying the standard ITE trip generation rates and appropriate trip reductions, the proposed Alum Rock/28<sup>th</sup> Street Station TOJD site would generate 7,105 new daily vehicle trips, with 768 new trips occurring during the AM peak hour and 771 new trips occurring during the PM peak hour. Using the inbound/outbound splits recommended by ITE, the Alum Rock/28<sup>th</sup> Street Station TOJD site would produce 589 additional inbound trips

and 179 additional outbound trips during the AM peak hour, and 216 additional inbound trips and 555 additional outbound trips during the PM peak hour.

**Table 12**  
**Trip Generation Estimates for Alum Rock/28<sup>th</sup> Street and Santa Clara Station Joint Development Sites**

| Land Use  | ITE Code | Size         | Daily Trip Rates | Daily Trips | AM Peak Hour |        |     |       |      |            | PM Peak Hour |     |       |      |       |       |
|---|----------|--------------|------------------|-------------|--------------|--------|-----|-------|------|------------|--------------|-----|-------|------|-------|-------|
|   |          |              |                  |             | Pk-Hr Rate   | Splits |     | Trips |      | Pk-Hr Rate | Splits       |     | Trips |      |       |       |
|   |          |              |                  |             |              | In     | Out | In    | Out  |            | Total        | In  | Out   | In   | Out   | Total |
| <b>Alum Rock BART Station Transit-Oriented Joint Development Site</b>   |          |              |                  |             |              |        |     |       |      |            |              |     |       |      |       |       |
| Office Building <sup>1</sup>  | 710      | 500,000 s.f. | 8.92             | 4,461       | 1.39         | 88%    | 12% | 610   | 83   | 693        | 1.28         | 17% | 83%   | 109  | 529   | 638   |
| 6% Transit Trip Reduction for Office <sup>2</sup>   |          |              |                  |             |              |        |     | (37)  | (5)  | (42)       |              |     |       | (7)  | (31)  | (38)  |
| 3% Reduction for Employment and Employee-serving Retail <sup>3</sup>  |          |              |                  |             |              |        |     | (18)  | (3)  | (21)       |              |     |       | (3)  | (16)  | (19)  |
| Apartments <sup>6</sup>   | 220      | 275 units    | 6.51             | 1,790       | 0.50         | 20%    | 80% | 28    | 110  | 138        | 0.61         | 65% | 35%   | 110  | 59    | 169   |
| 9% Transit Trip Reduction for Residential <sup>7</sup>  |          |              |                  |             |              |        |     | (3)   | (10) | (13)       |              |     |       | (10) | (5)   | (15)  |
| 15% Housing and Retail Internal Reduction <sup>8</sup>  |          |              |                  |             |              |        |     | (1)   | (2)  | (3)        |              |     |       | (6)  | (5)   | (11)  |
| Retail Space <sup>4</sup>   | 820      | 20,000 s.f.  | 42.70            | 854         | 0.96         | 62%    | 38% | 12    | 7    | 19         | 3.71         | 48% | 52%   | 36   | 38    | 74    |
| 15% Housing and Retail Internal Reduction <sup>8</sup>  |          |              |                  |             |              |        |     | (2)   | (1)  | (3)        |              |     |       | (5)  | (6)   | (11)  |
| 25% Retail PM Pass-By Reduction <sup>5</sup>  |          |              |                  |             |              |        |     |       |      |            |              |     |       | (8)  | (8)   | (16)  |
| <b>Net Alum Rock Station TOJD Site Trips:</b>   |          |              |                  | 7,105       |              |        |     | 589   | 179  | 768        |              |     |       | 216  | 555   | 771   |
| <b>Santa Clara BART Station Transit-Oriented Joint Development Site</b>   |          |              |                  |             |              |        |     |       |      |            |              |     |       |      |       |       |
| Office Building <sup>1</sup>  | 710      | 500,000 s.f. | 8.92             | 4,461       | 1.39         | 88%    | 12% | 610   | 83   | 693        | 1.28         | 17% | 83%   | 109  | 529   | 638   |
| 6% Transit Trip Reduction for Office <sup>2</sup>   |          |              |                  |             |              |        |     | (37)  | (5)  | (42)       |              |     |       | (6)  | (32)  | (38)  |
| 3% Reduction for Employment and Employee-Serving Retail <sup>3</sup>  |          |              |                  |             |              |        |     | (18)  | (3)  | (21)       |              |     |       | (3)  | (16)  | (19)  |
| Apartments <sup>4</sup>   | 220      | 225 units    | 6.61             | 1,487       | 0.51         | 20%    | 80% | 23    | 91   | 114        | 0.63         | 65% | 35%   | 92   | 49    | 141   |
| 9% Transit Trip Reduction for Residential <sup>5</sup>  |          |              |                  |             |              |        |     | (2)   | (8)  | (10)       |              |     |       | (8)  | (5)   | (13)  |
| 15% Housing and Retail Internal Reduction <sup>6</sup>  |          |              |                  |             |              |        |     | (2)   | (2)  | (4)        |              |     |       | (9)  | (8)   | (17)  |
| Retail Space <sup>7</sup>   | 820      | 30,000 s.f.  | 42.70            | 1,281       | 0.96         | 62%    | 38% | 18    | 11   | 29         | 3.71         | 48% | 52%   | 53   | 58    | 111   |
| 15% Housing and Retail Internal Reduction <sup>6</sup>  |          |              |                  |             |              |        |     | (2)   | (2)  | (4)        |              |     |       | (8)  | (9)   | (17)  |
| 25% Retail PM Pass-By Reduction <sup>8</sup>  |          |              |                  |             |              |        |     |       |      |            |              |     |       | (11) | (12)  | (23)  |
| <b>Net Santa Clara Station TOJD Site Trips:</b>   |          |              |                  | 7,229       |              |        |     | 590   | 165  | 755        |              |     |       | 209  | 554   | 763   |
| <b>Total Transit-Oriented Joint Development Project Trips:</b>  |          |              |                  | 14,334      |              |        |     | 1,179 | 344  | 1,523      |              |     |       | 425  | 1,109 | 1,534 |
| <b>Notes:</b>   |          |              |                  |             |              |        |     |       |      |            |              |     |       |      |       |       |
| <sup>1</sup> Rate based on ITE Land Use Code 710 (General Office), fitted curve equation used.  |          |              |                  |             |              |        |     |       |      |            |              |     |       |      |       |       |
| <sup>2</sup> Transit trip reduction of 6% for office trips, based on VTA's October 2014 TIA Guidelines.   |          |              |                  |             |              |        |     |       |      |            |              |     |       |      |       |       |
| <sup>3</sup> Mixed-Use reduction of 3% for mix of employment and employment-serving retail, based on VTA's October 2014 TIA Guidelines.   |          |              |                  |             |              |        |     |       |      |            |              |     |       |      |       |       |
| <sup>4</sup> Rates based on ITE Land Use Code 220 (Apartment), fitted curve equation used.  |          |              |                  |             |              |        |     |       |      |            |              |     |       |      |       |       |
| <sup>5</sup> Transit trip reduction of 9% for residential trips, based on VTA's October 2014 TIA Guidelines.  |          |              |                  |             |              |        |     |       |      |            |              |     |       |      |       |       |
| <sup>6</sup> Internal capture reduction of 15% for mix of residential and retail uses (15% of smaller trip generator = retail use), based on VTA's October 2014 TIA Guidelines. |          |              |                  |             |              |        |     |       |      |            |              |     |       |      |       |       |
| <sup>7</sup> Rates based on ITE Land Use Code 820 (Shopping Center), average rates used.  |          |              |                  |             |              |        |     |       |      |            |              |     |       |      |       |       |
| <sup>8</sup> A typical 25% pass-by trip reduction was applied to the retail component of the project during the PM peak hour.   |          |              |                  |             |              |        |     |       |      |            |              |     |       |      |       |       |
| Source for all trip generation rates: ITE Trip Generation Manual, 9th Edition, 2012.  |          |              |                  |             |              |        |     |       |      |            |              |     |       |      |       |       |

The proposed Santa Clara Station Transit-Oriented Joint Development site would generate 7,229 new daily vehicle trips, with 755 new trips occurring during the AM peak hour and 763 new trips occurring during the PM peak hour. Using the inbound/outbound splits recommended by ITE, the Santa Clara Station TOJD site would produce 590 additional inbound trips and 165 additional outbound trips during the AM peak hour, and 209 additional inbound trips and 554 additional outbound trips during the PM peak hour.

**BART Station Drive Access Trips and Transit-Oriented Joint Development Trips**

In order to determine the total number of trips that would be generated by the Alum Rock/28<sup>th</sup> Street and Santa Clara Station sites, the trips projected to be generated by the Transit-Oriented Joint Development were added to the station drive access trips (people driving to or from the stations to park or to drop off or pick up someone). This sum includes all the trips that would be generated by the Alum Rock/28<sup>th</sup> Street and Santa Clara BART Stations (i.e., by their KNR and PNR facilities and by their TOJD uses), as shown in Table 13. However, the total site-generated trips shown in Table 13 do *not* include the reduction in trips on the roadway network due to the mode shift resulting from the Phase II BART Extension.

**Table 13**  
**Total Site-Generated Trips – Alum Rock/28<sup>th</sup> Street and Santa Clara Stations**

| Station   | Daily Trips   | AM Peak Hour Trips |            |              | PM Peak Hour Trips |            |              |
|---|---------------|--------------------|------------|--------------|--------------------|------------|--------------|
|   |               | In                 | Out        | Total        | In                 | Out        | Total        |
| <b>Alum Rock Station</b>  |               |                    |            |              |                    |            |              |
| Kiss and Ride Trips <sup>1</sup>  | 407           | 40                 | 40         | 80           | 47                 | 47         | 94           |
| Park and Ride Trips <sup>1</sup>  | 2,632         | 354                | 12         | 366          | 32                 | 276        | 308          |
| Joint Development Trips   | 7,105         | 589                | 179        | 768          | 216                | 255        | 771          |
| <b>Total Site-Generated Trips</b>   | <b>10,144</b> | <b>983</b>         | <b>231</b> | <b>1,214</b> | <b>295</b>         | <b>578</b> | <b>1,173</b> |
| <b>Santa Clara Station</b>  |               |                    |            |              |                    |            |              |
| Kiss and Ride Trips <sup>1</sup>  | 110           | 11                 | 11         | 22           | 13                 | 13         | 26           |
| Park and Ride Trips <sup>1</sup>  | 455           | 61                 | 2          | 63           | 6                  | 48         | 54           |
| Joint Development Trips   | 7,229         | 590                | 165        | 755          | 209                | 554        | 763          |
| <b>Total Site-Generated Trips</b>   | <b>7,794</b>  | <b>662</b>         | <b>178</b> | <b>840</b>   | <b>228</b>         | <b>615</b> | <b>843</b>   |
| Notes:  |               |                    |            |              |                    |            |              |
| <sup>1</sup> The number of Kiss and Ride and Park and Ride trips is taken from Year 2025 Conditions in the "Phase II BART Extension Only Transportation Impact Analysis" (Hexagon Transportation Consultants, Inc). |               |                    |            |              |                    |            |              |

The total of the Station Drive Access trips and the Transit-Oriented Joint Development trips at the Alum Rock/28<sup>th</sup> Street Station would be 1,214 trips in the AM peak hour and 1,173 trips in the PM peak hour. The total of the Station Drive Access trips and the Transit-Oriented Joint Development trips at the Santa Clara Station would be 840 trips in the AM peak hour and 843 trips in the PM peak hour.

VTA and the Cities will work to maximize multimodal access to the BART stations and the Transit-Oriented Joint Development land uses. Through various efforts such as Access Plans for the station areas, Transportation Demand Management (TDM) Plans for the Joint Development, improving the bike and pedestrian facilities in the vicinity of the stations, and offering "unbundled" parking for the residential uses, the number of vehicle trips generated by the Project would be reduced. Therefore, the estimates of vehicle trips for the Project in this TIA should be regarded as conservative.

### Trip Distribution and Assignment

Distribution patterns and assignment of all three components of the Phase II Extension and Transit-Oriented Joint Development Project were obtained from the VTA Model for both 2015 and 2025. That is, the VTA Model has estimated volumes for each turning movement at all study intersections related to the following:

1. The trips going to and from the station campuses for the Transit-Oriented Joint Development land uses (this is a positive number, representing additional trips at a given intersection),
2. The trips going to and from the station campuses for the PNR and KNR Facilities (this is a positive number, representing additional trips at a given intersection);
3. The trips that would be removed from the roadway network due to the mode shift from passenger vehicles to BART (this is a negative number, representing fewer trips at a given intersection).

At some locations, particularly for those movements leading directly to the station campuses, the number of vehicles accessing the station is larger than the number of vehicles shifted from the roadway network to transit modes, and the Project results in a net increase in traffic volumes. At other locations, particularly for those movements either not leading to the station campuses or leading to freeways, the number of vehicles shifted from the roadway network to transit modes is greater than the number of vehicles using that movement to access the station, and the Project results in a net decrease in traffic volumes.

The distribution and assignment calculated by the VTA Model for Project trips is slightly different under Existing (2015) and Background (2025) conditions. This is because the model incorporates changes to the following areas in its forecasts for 2025:

- The number of households and employment, based on ABAG projections;
- The roadway network as of 2025, based on improvements identified by the Cities of San Jose and Santa Clara, in MTC's Regional Transportation Plan for the Bay Area, and VTA's *Valley Transportation Plan 2040*.
- Transit service improvements planned to be in effect by 2025, including bus rapid transit projects, light rail transit (LRT) extensions, and Caltrain service upgrades.

For details on the 2025 model assumptions regarding improvements to the roadway network, bicycle and pedestrian facilities and transit services, please refer to the "BART Extension Only TIA" (Appendix G).

Because of these differences in 2015 and 2025 model assumptions, the trip assignment of the Project trips at the study intersections can be different in 2015 and 2025. Figures 17 and 18 show the trip assignment for only the Transit-Oriented Joint Development component of the Project at the Alum Rock/28<sup>th</sup> Street and Santa Clara Stations in 2015. Figures 19 and 20 show total project trip assignment for all three components of the Phase II Extension and Transit-Oriented Joint Development Project at the Alum Rock/28<sup>th</sup> Street and Santa Clara Stations in 2015.

Figures 21 and 22 show the trip assignment for only the Transit-Oriented Joint Development component of the project at the Alum Rock/28<sup>th</sup> Street and Santa Clara Stations in 2025. Figures 23 and 24 show the total project trip assignment for all three components of the Project at the Alum Rock/28<sup>th</sup> Street and Santa Clara Stations in 2025.

In the table of all traffic volume components included as Appendix D, trips related to the Transit-Oriented Joint Development component of the Project are shown separately for each turning movement at all the study intersections, and correspond to the volumes shown on Figures 17-18 (for 2015) and Figures 21-22 (for 2025). The volumes related to the station drive access trips and the mode shift trips are combined and shown as "BART" trips for each turning movement at all the study intersections. The sum of all three project components is also shown in Appendix C and corresponds to the volumes shown on Figures 19-20 (for 2015) and Figures 23-24 (for 2025).

## Significant Impact Criteria

Significance criteria are used to establish what constitutes an impact. Impacts of the Project are based on 2025 Background traffic conditions with the proposed Project compared to 2025 Background traffic conditions without the proposed Project. For this analysis, the criteria used to determine significant impacts on signalized intersections are based on City of San Jose, City of Santa Clara, and VTA's Congestion Management Program (CMP) Level of Service standards. The LOS Policies of these cities and the CMP are the adopted thresholds for CEQA purposes. Project impacts on CMP study intersections and freeway segments were analyzed according to the CMP methodology.

As described in Chapter 1, the City of San Jose level of service standard for signalized intersections is LOS D or better. The City of Santa Clara level of service standard is LOS D or better at all city-controlled intersections and LOS E or better at all expressway and CMP intersections. The CMP level of service standard for CMP signalized intersections is LOS E or better.

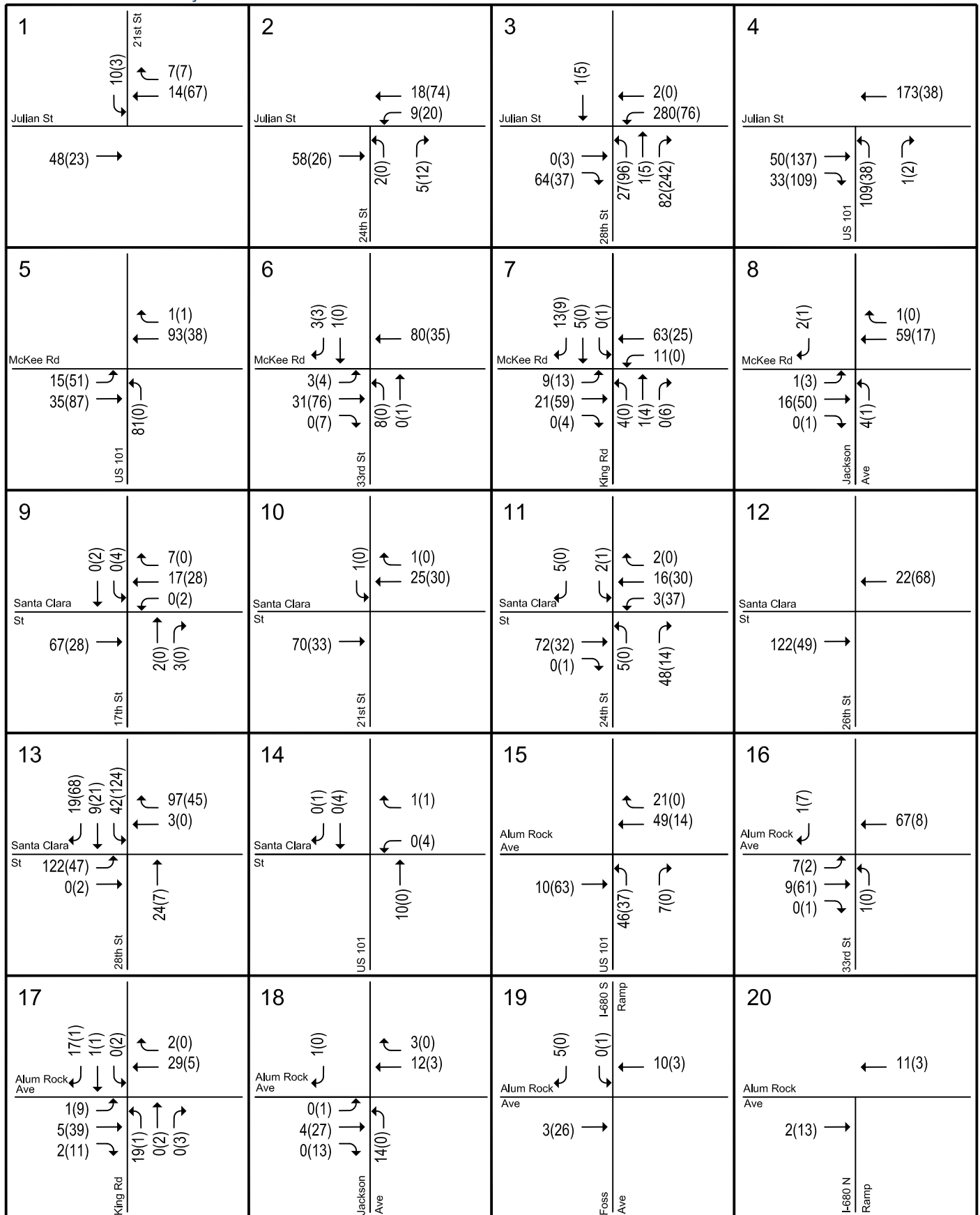

LEGEND

XX(XX) = AM(PM) Peak-Hour Trips

**Figure 17**  
**Transit-Oriented Joint Development Trips in 2015 - Alum Rock/28th Street Station**

Phase II Extension Project TIA

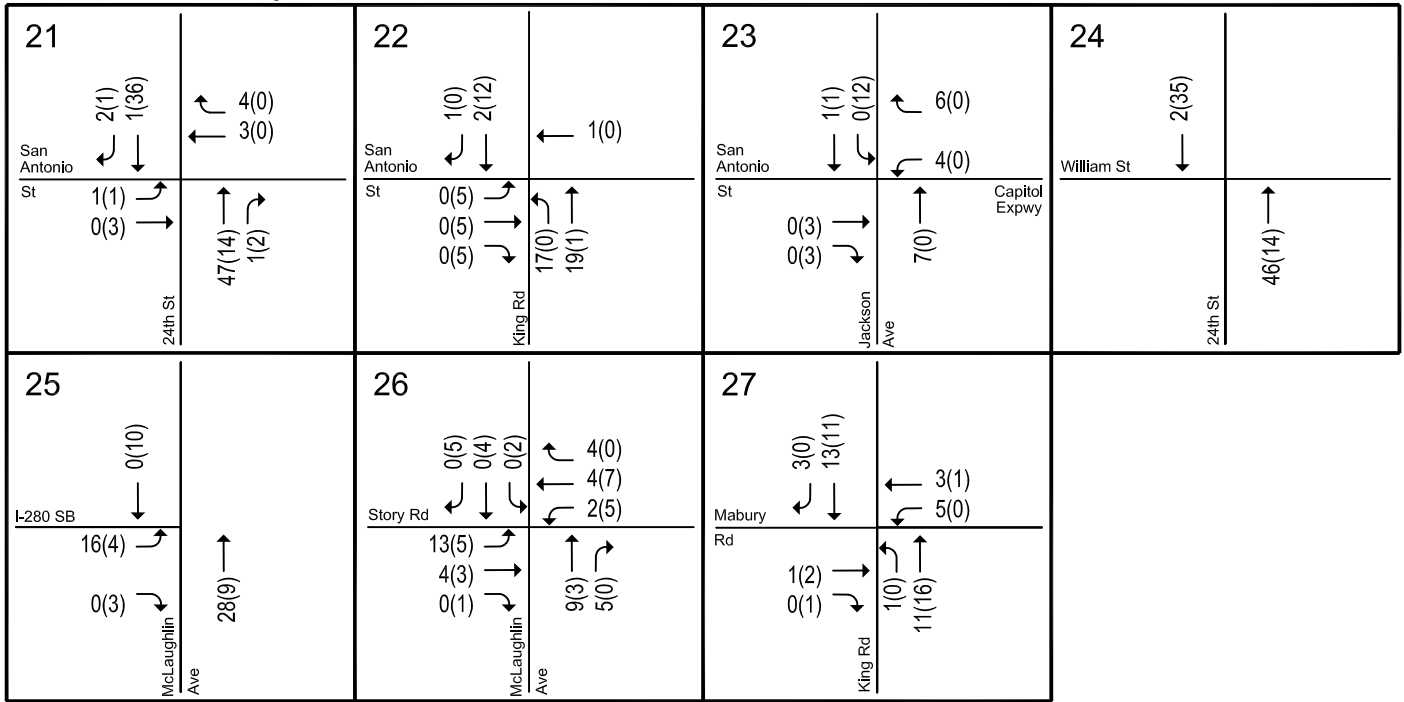

LEGEND

XX(XX) = AM(PM) Peak-Hour Trips

**Figure 17**  
**Transit-Oriented Joint Development Trips in 2015 - Alum Rock/28th Street Station**



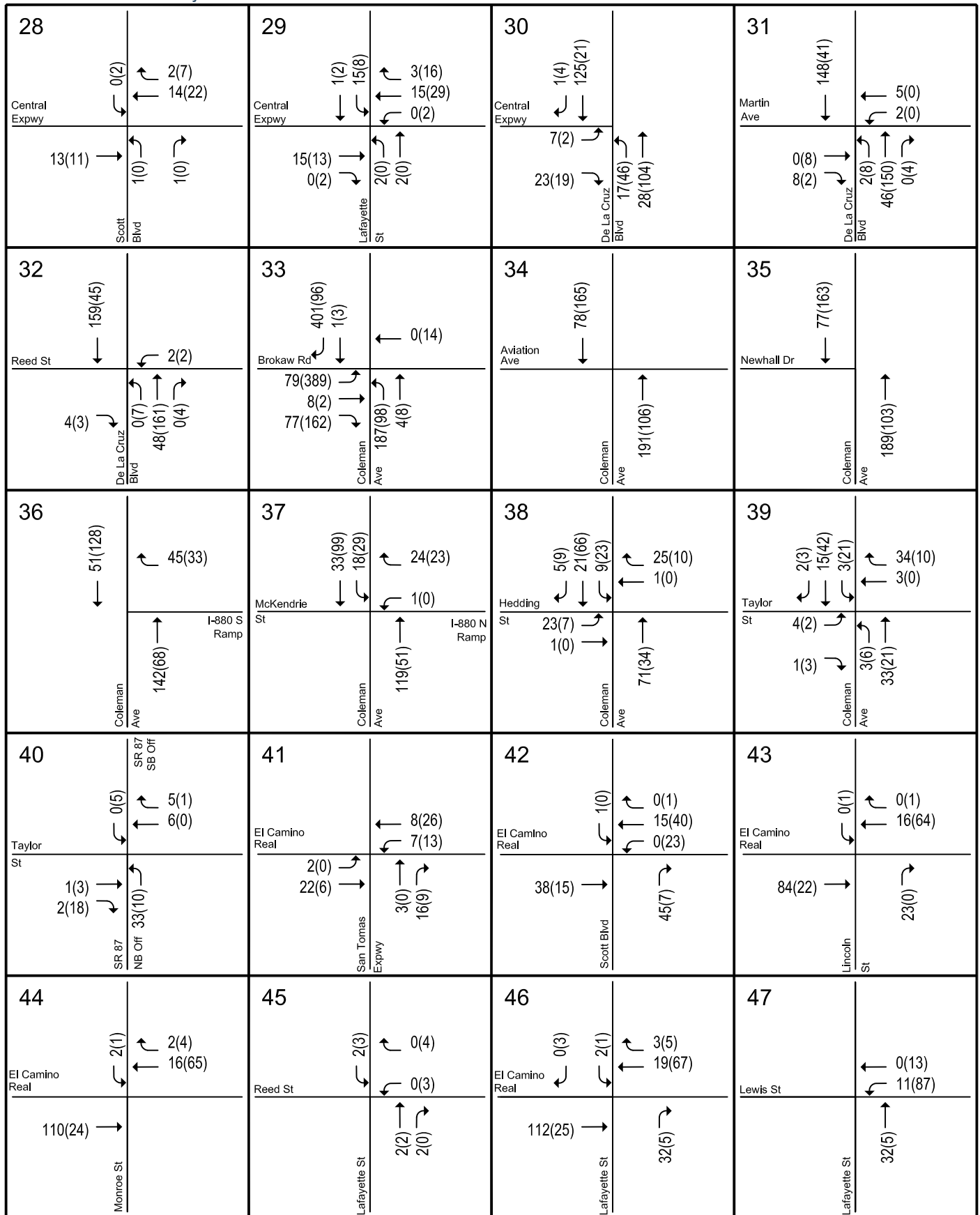

LEGEND

XX(X) = AM(PM) Peak-Hour Trips

**Figure 18**  
**Transit-Oriented Joint Development Trips in 2015 - Santa Clara Station**

Phase II Extension Project TIA

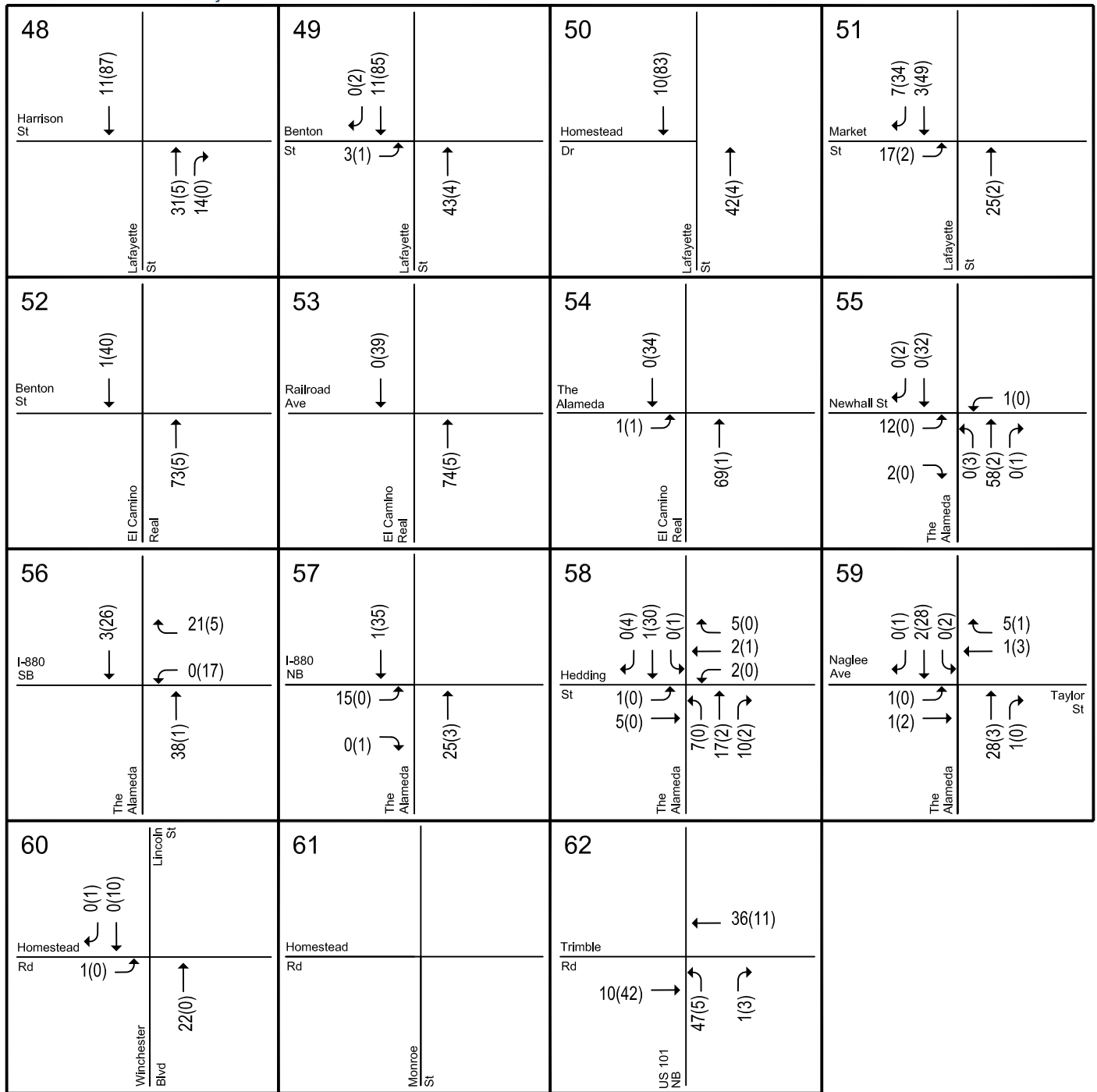

LEGEND

XX(XX) = AM(PM) Peak-Hour Trips

**Figure 18**  
**Transit-Oriented Joint Development Trips in 2015 - Santa Clara Station**

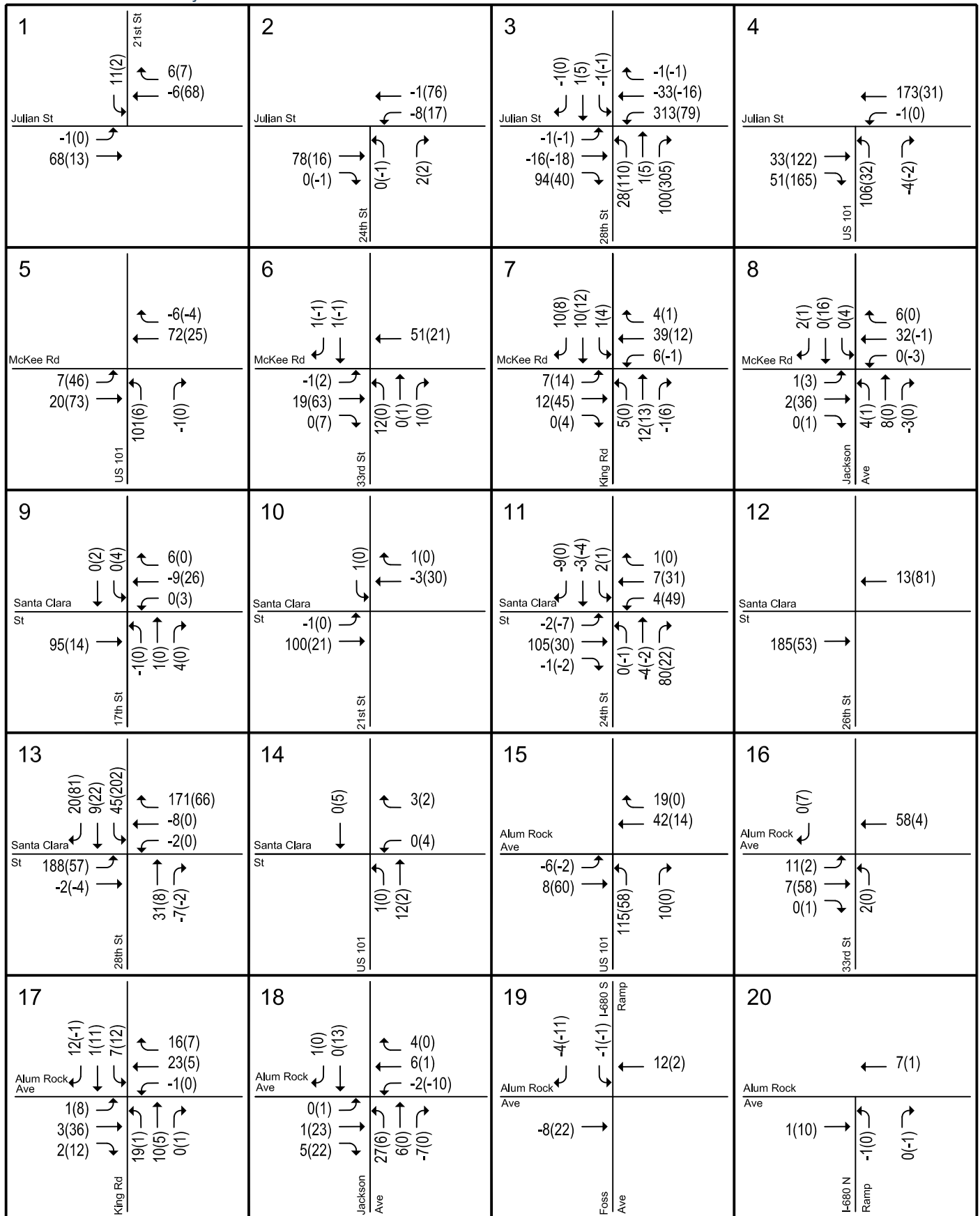

LEGEND

XX(XX) = AM(PM) Peak-Hour Trips

**Figure 19**  
**Total BART and Transit-Oriented Joint Development Trips in 2015 - Alum Rock/28th Street Station**

Phase II Extension Project TIA

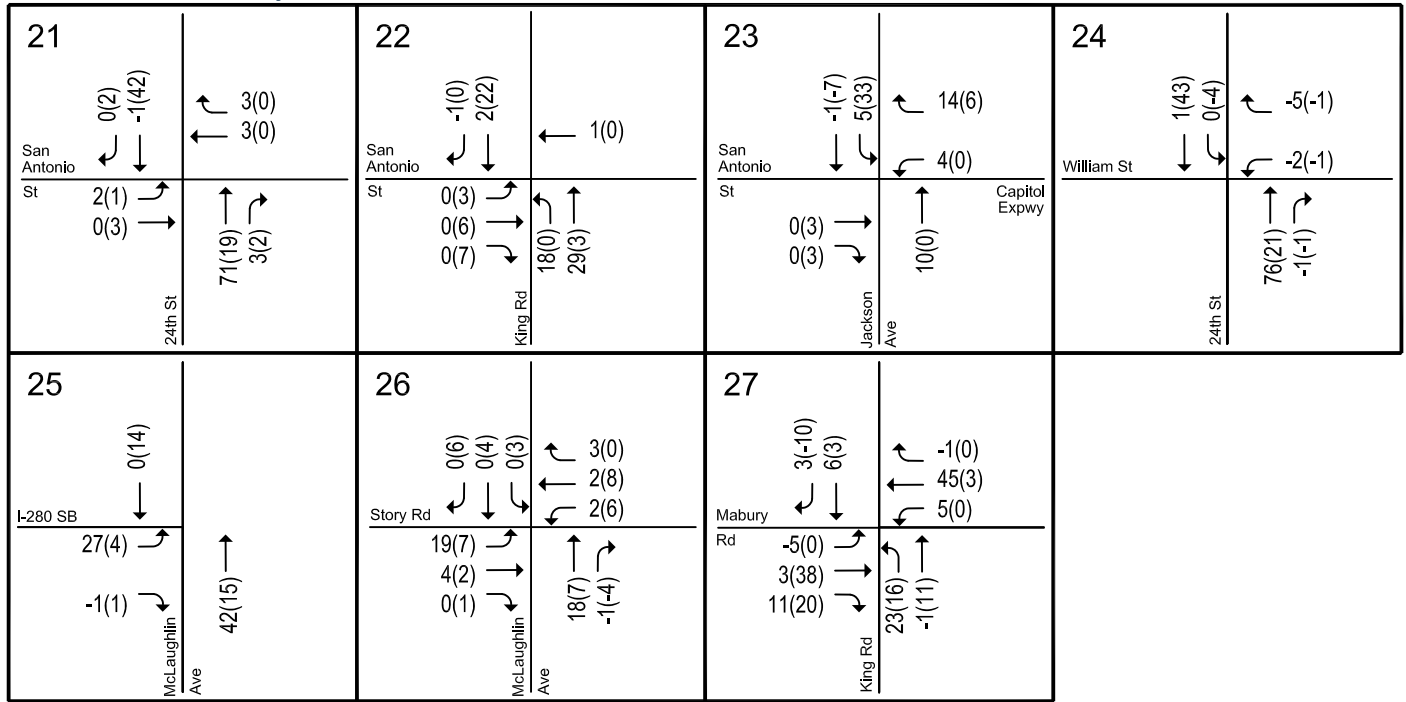

LEGEND

XX(XX) = AM(PM) Peak-Hour Trips

**Figure 19**  
**Total BART and Transit-Oriented Joint Development Trips in 2015 - Alum Rock/28th Street Station**

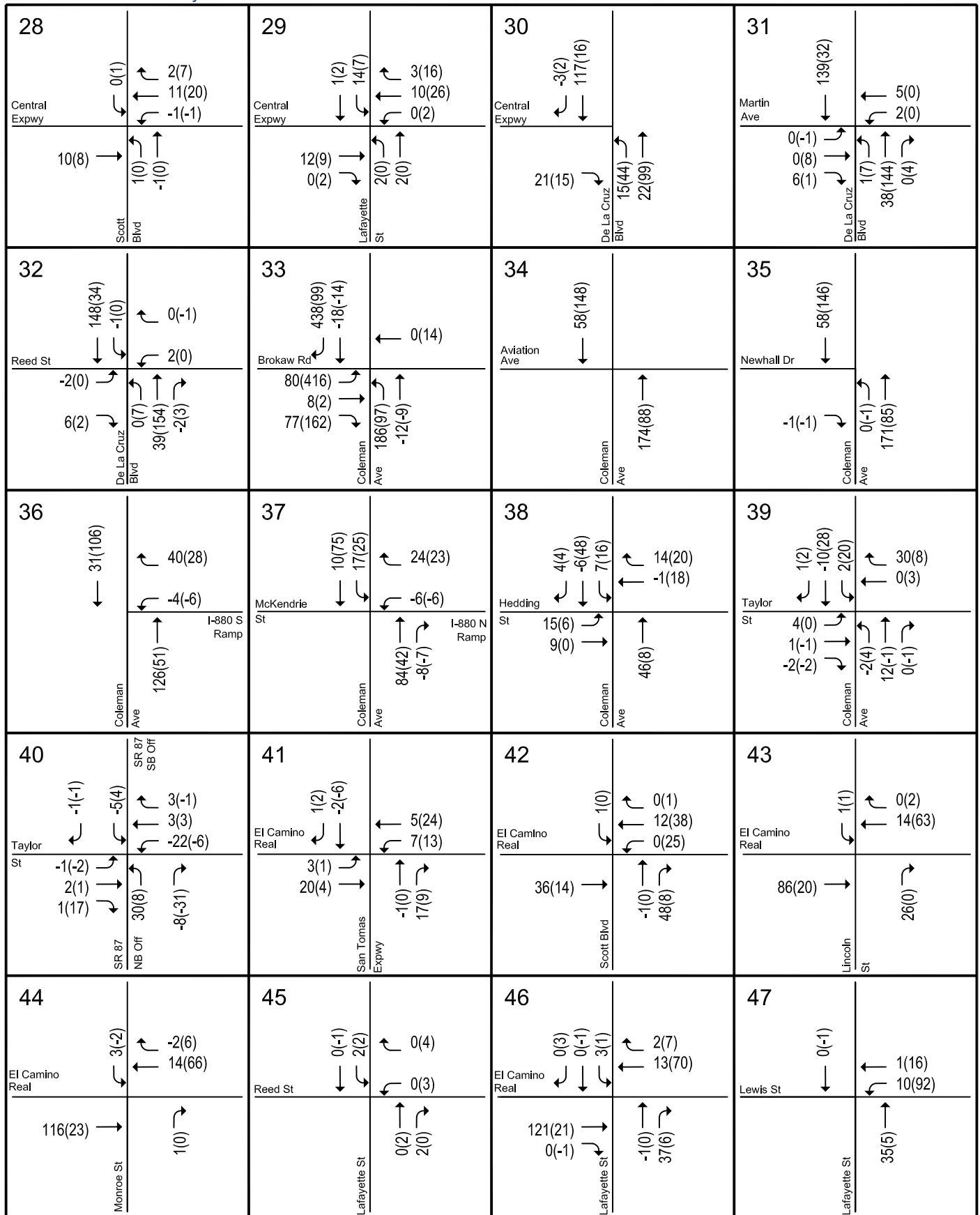

LEGEND

XX(XX) = AM(PM) Peak-Hour Trips

**Figure 20**  
**Total BART and Transit-Oriented Joint Development Trips in 2015 - Santa Clara Station**



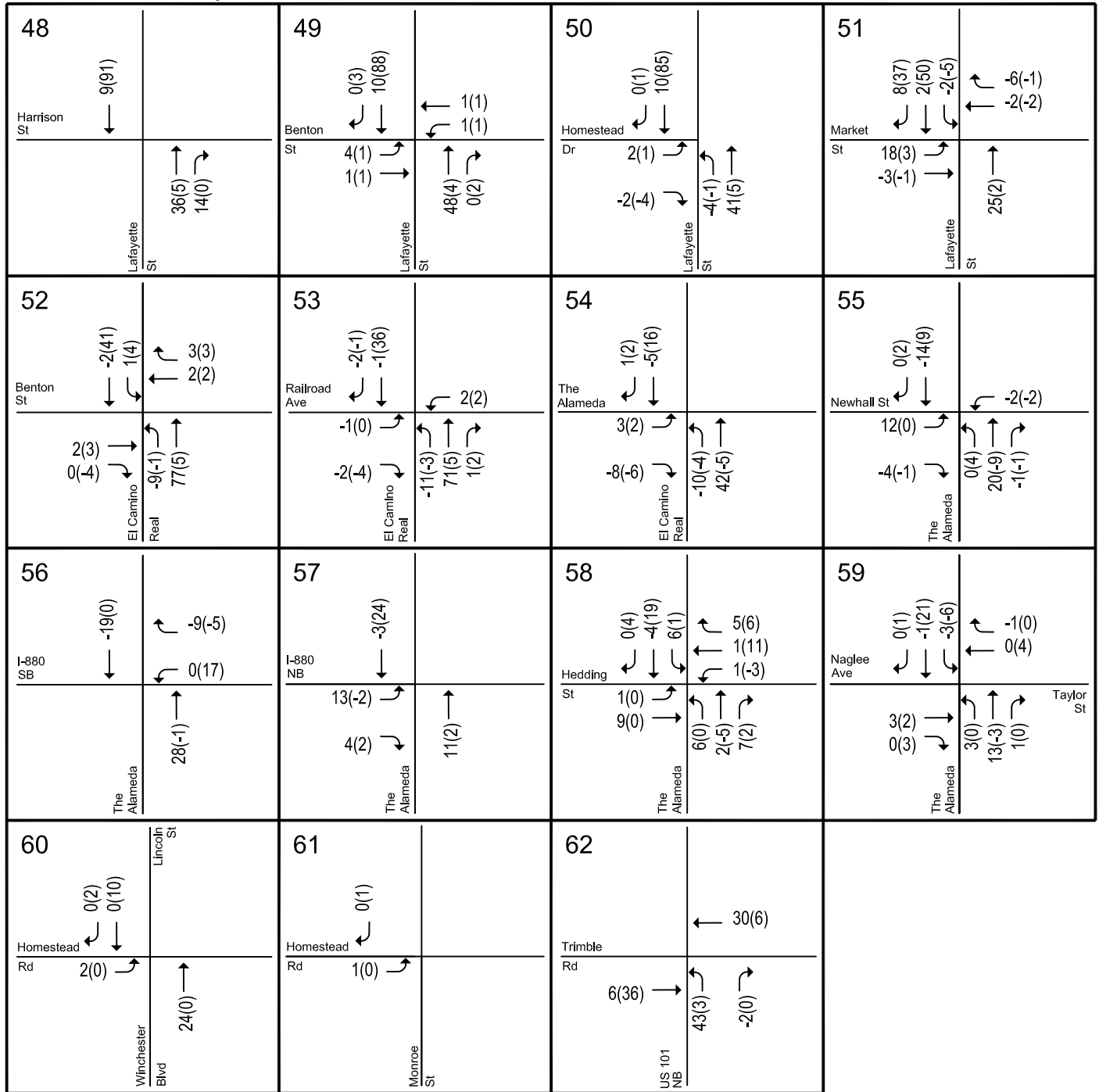

LEGEND

XX(XX) = AM(PM) Peak-Hour Trips

Figure 20  
Total BART and Transit-Oriented Joint Development Trips in 2015 - Santa Clara Station



Phase II Extension Project TIA

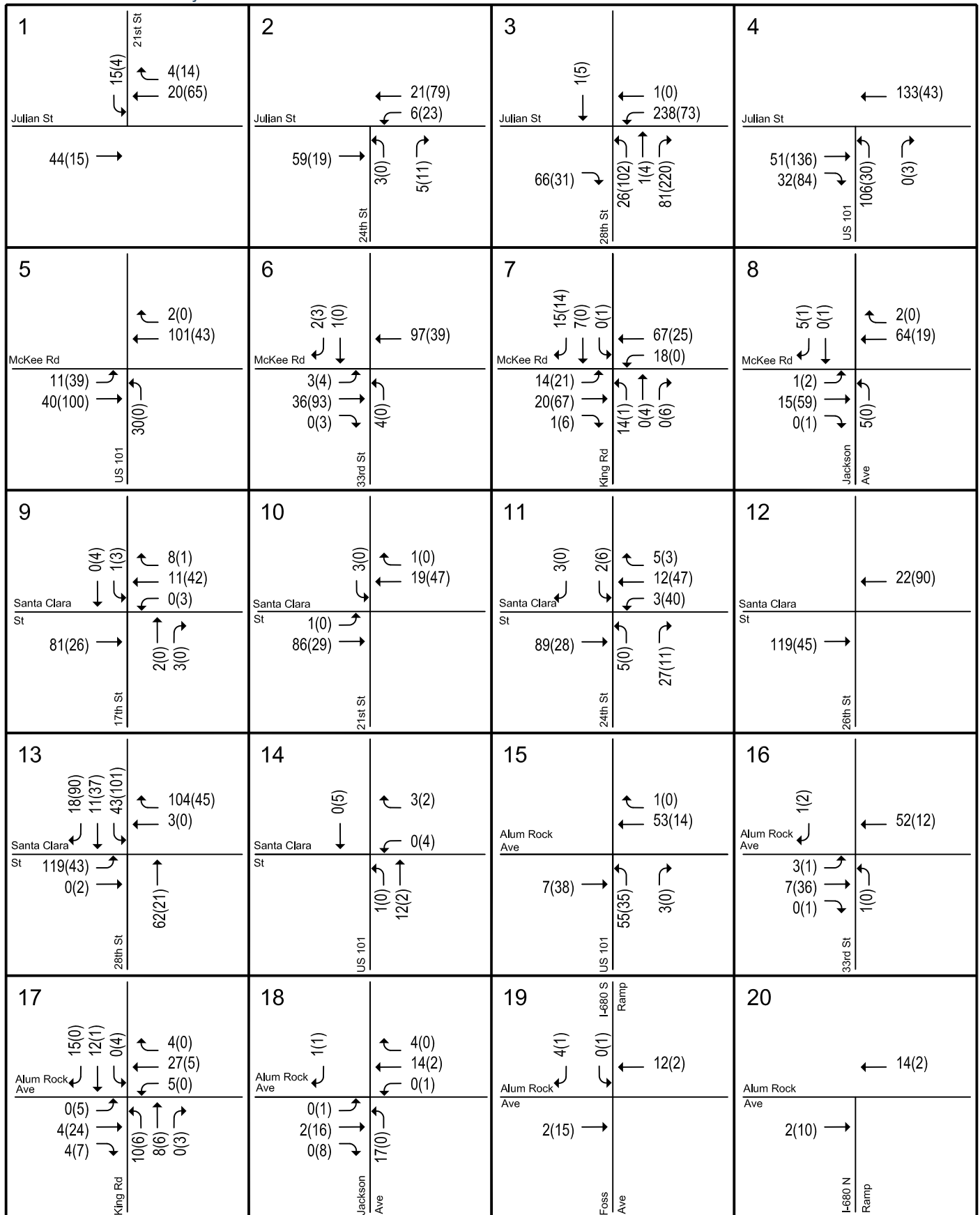

LEGEND

XX(XX) = AM(PM) Peak-Hour Trips

**Figure 21**  
**Transit-Oriented Joint Development Trips in 2025 - Alum Rock/28th Street Station**



Phase II Extension Project TIA

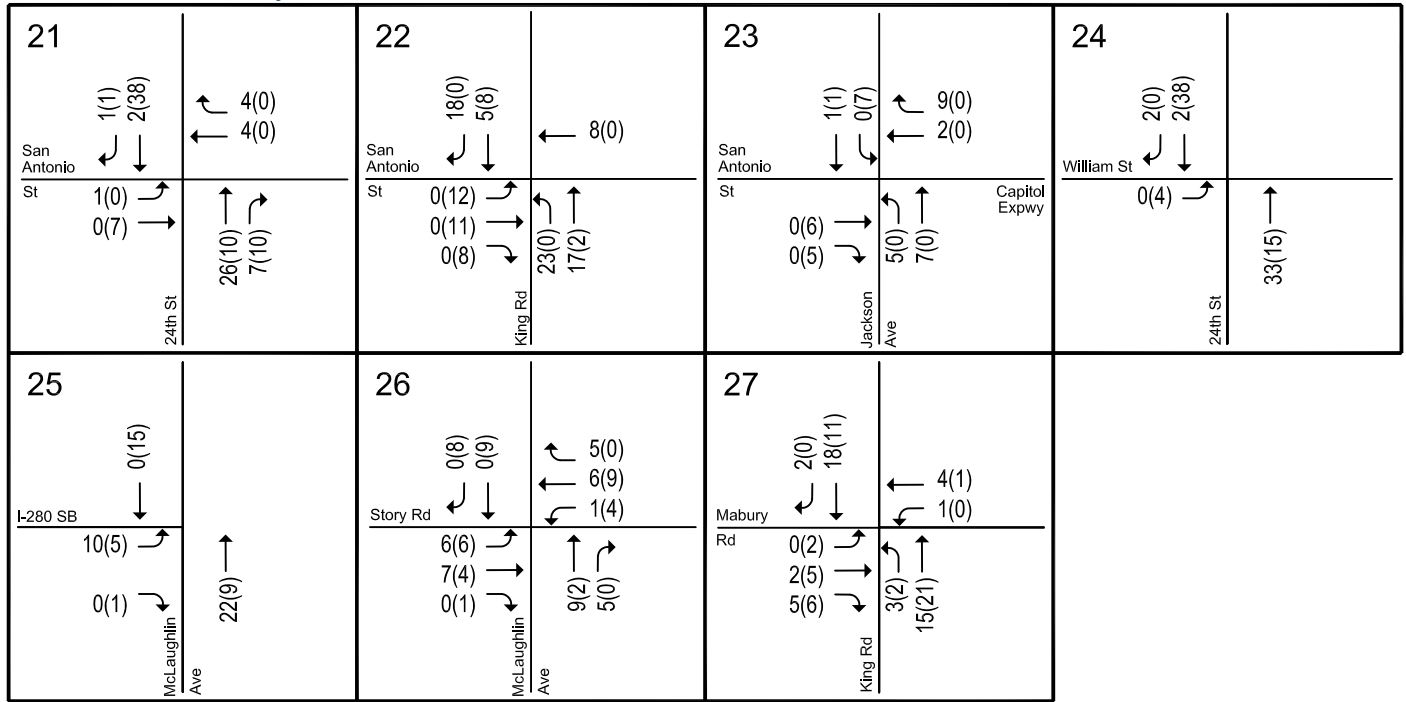

LEGEND

XX(X) = AM(PM) Peak-Hour Trips

Figure 21  
Transit-Oriented Joint Development Trips in 2025 - Alum Rock/28th Street Station

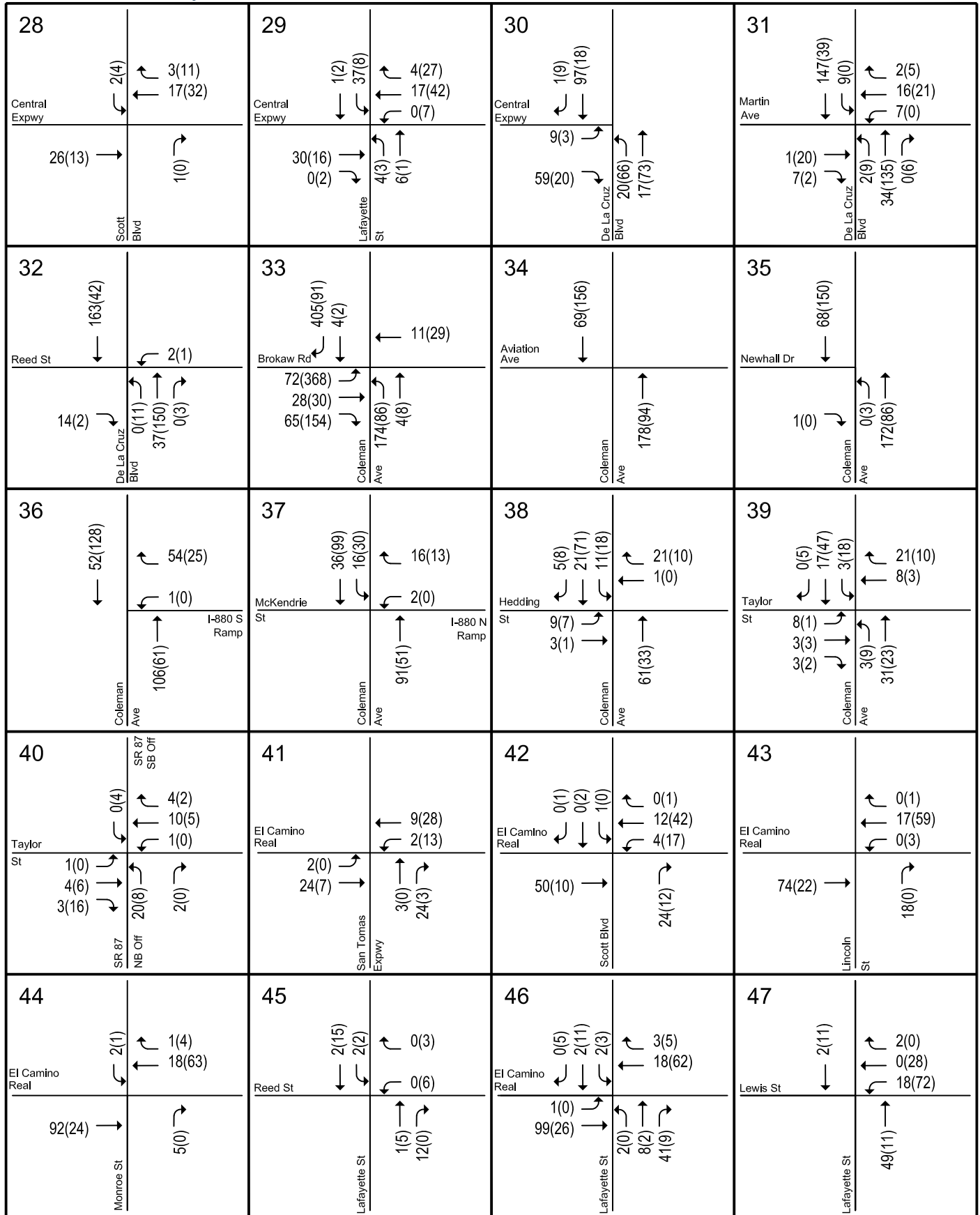

LEGEND  
 XX(XX) = AM(PM) Peak-Hour Trips

**Figure 22**  
**Transit-Oriented Joint Development Trips in 2025 - Santa Clara Station**

Phase II Extension Project TIA

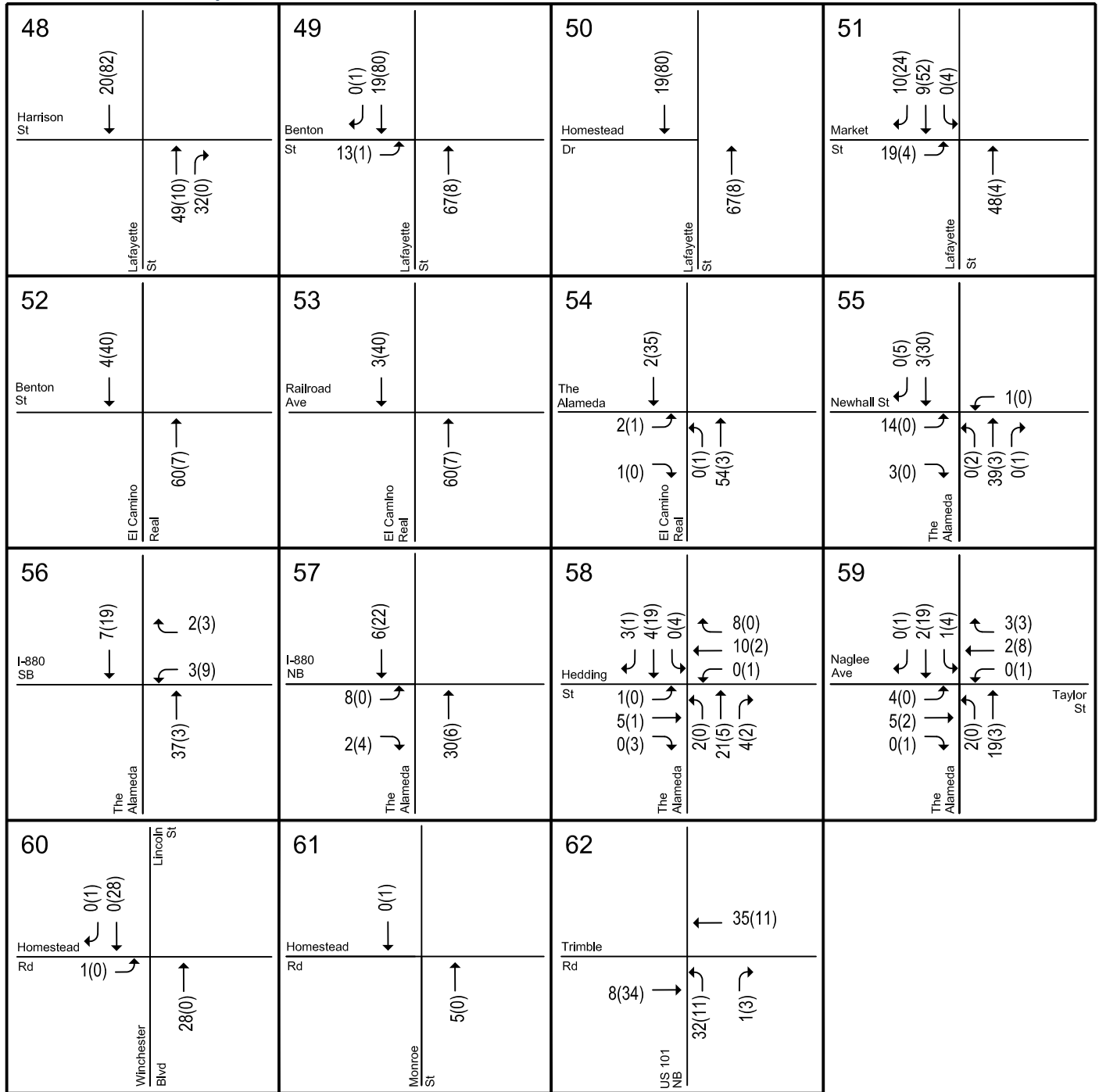

LEGEND

XX(XX) = AM(PM) Peak-Hour Trips

**Figure 22**  
**Transit-Oriented Joint Development Trips in 2025 - Santa Clara Station**

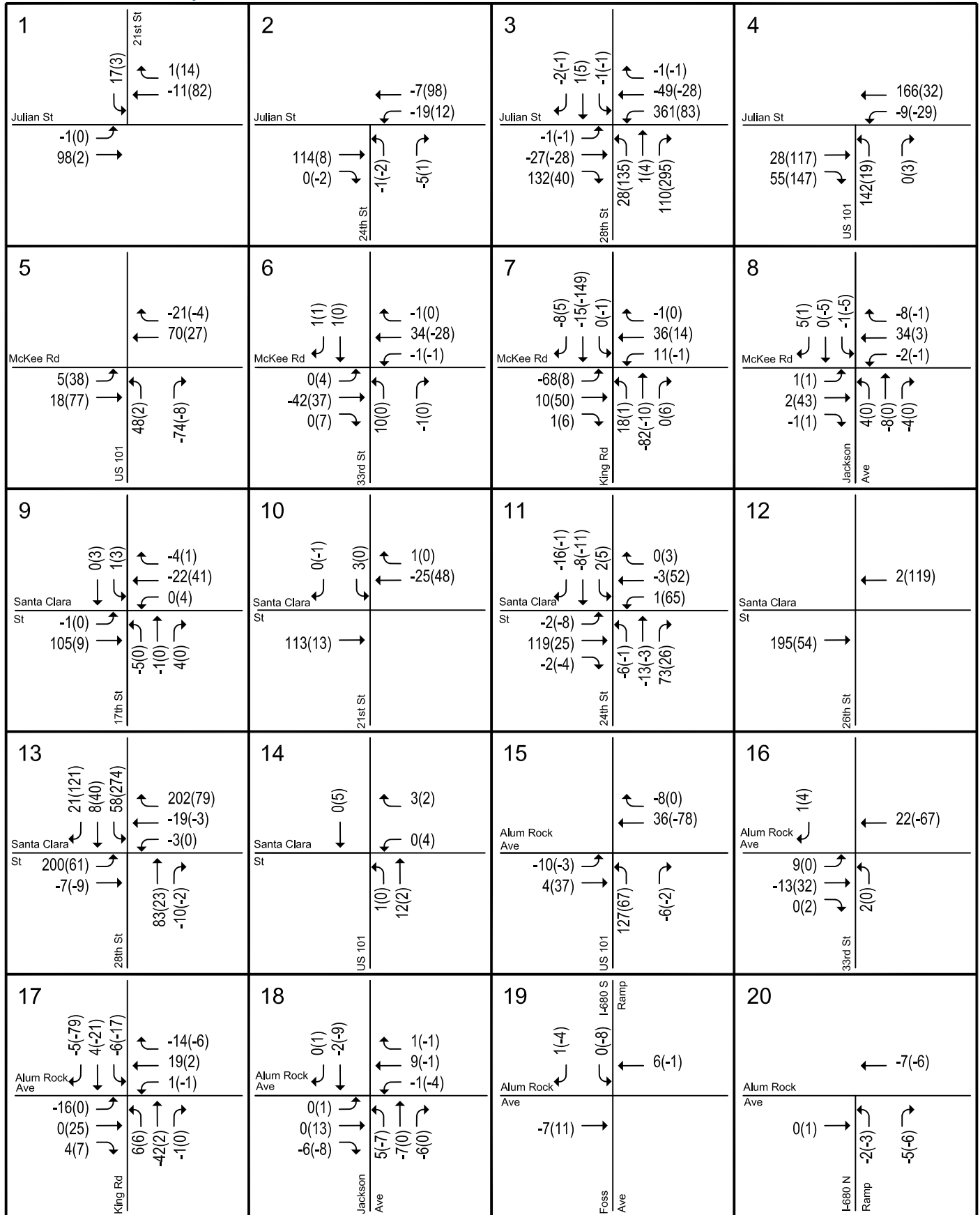

LEGEND

XX(XX) = AM(PM) Peak-Hour Trips

**Figure 23**  
**Total BART and Transit-Oriented Joint Development Trips in 2025 - Alum Rock/28th Street Station**

Phase II Extension Project TIA

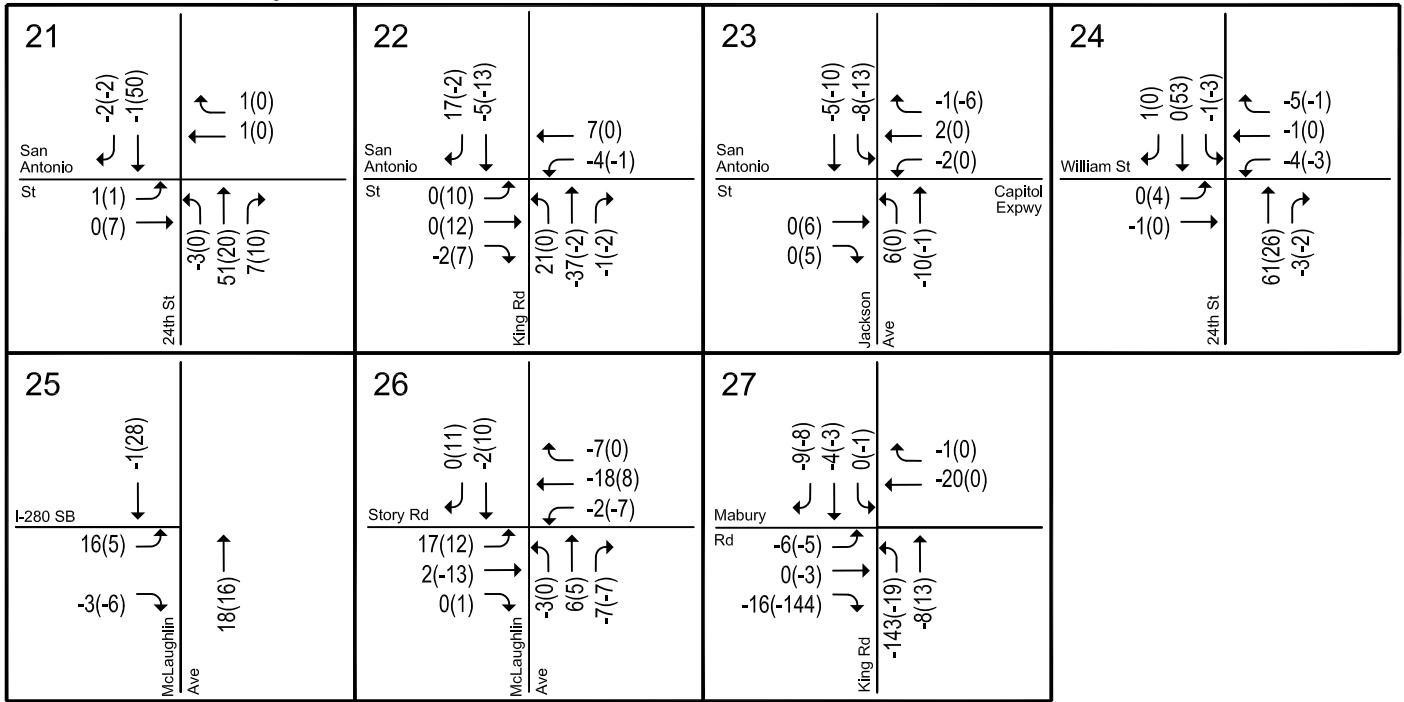

LEGEND

XX(XY) = AM(PM) Peak-Hour Trips

**Figure 23**  
**Total BART and Transit-Oriented Joint Development Trips in 2025 -**  
**Alum Rock/28th Street Station**



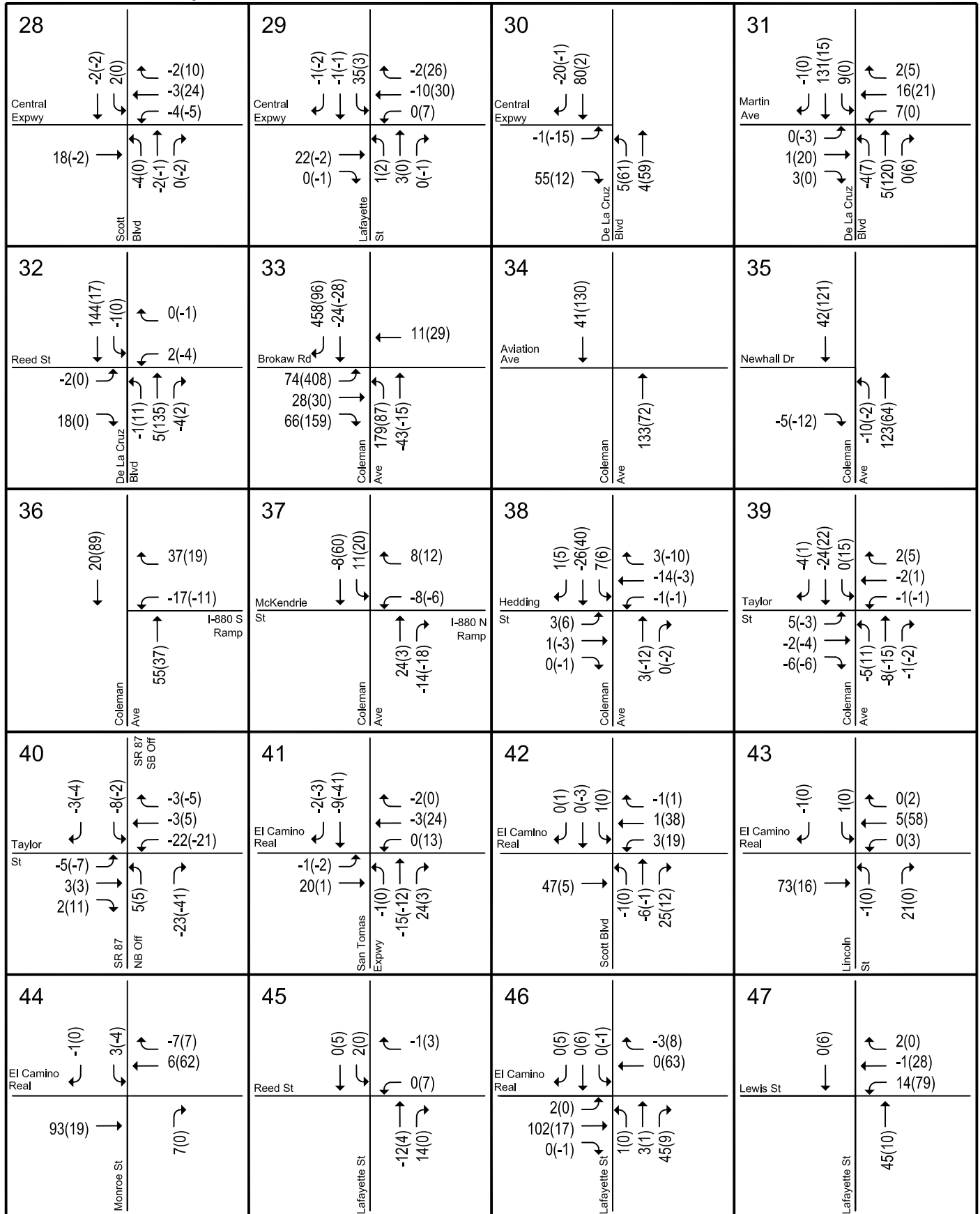

LEGEND

XX(XX) = AM(PM) Peak-Hour Trips

**Figure 24**  
**Total BART and Transit-Oriented Joint Development Trips in 2025 - Santa Clara Station**



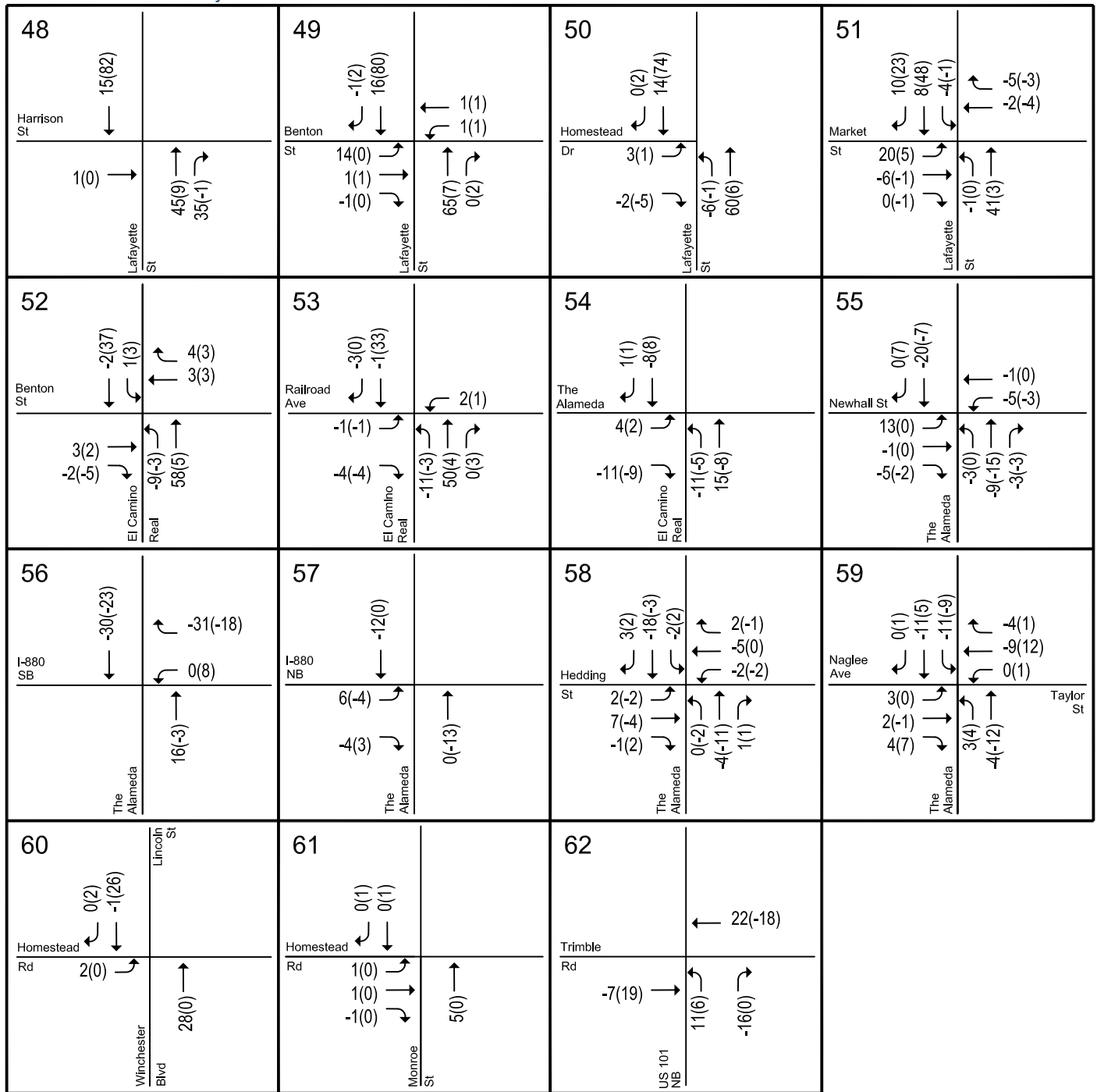

LEGEND

XX(XX) = AM(PM) Peak-Hour Trips

Figure 24  
Total BART and Transit-Oriented Joint Development Trips in 2025 - Santa Clara Station

## City of San Jose Definition of Significant Intersection Impacts

The project is said to create a significant impact on traffic conditions at a signalized intersection in the City of San Jose if, for either peak hour,

1. The level of service at the intersection degrades from an acceptable LOS D or better under 2025 Background Conditions to an unacceptable LOS E or F under 2025 Background Plus Project Conditions. **or**
2. The level of service at the intersection is an unacceptable LOS E or F under 2025 Background Conditions and the addition of project trips causes both the critical-movement delay at the intersection to increase by four (4) or more seconds **and** the critical volume-to-capacity ratio (V/C) to increase by one percent (.01) or more under 2025 Background Plus Project Conditions, **or**
3. The level of service at a designated City of San Jose Protected Intersection is an unacceptable LOS E or F under 2025 Background Conditions and the addition of project trips causes the volume-to-capacity ratio (V/C) to increase by one-half percent (.005) or more under 2025 Background Plus Project Conditions.

An exception to rule #2 above applies when the addition of project-generated traffic reduces the amount of average control delay for critical movements (i.e. the change in average control delay for critical movements is negative). In this case, the threshold of significance is an increase in the critical V/C value by one percent (0.01) or more.

## City of Santa Clara Definition of Significant Intersection Impacts

The project is said to create a significant impact on traffic conditions at a signalized intersection in the City of Santa Clara if, for either peak hour:

1. The level of service at the intersection degrades from an acceptable level (LOS D or better at all city-controlled intersections and LOS E or better at all expressway and CMP intersections) under 2025 Background Conditions to an unacceptable level (LOS E or F at city-controlled intersections and LOS F at expressway and CMP intersections) under 2025 Background Plus Project Conditions, **or**.
2. The level of service at the intersection is an unacceptable level (LOS E or F at city-controlled intersections and LOS F at expressway and CMP intersections) under 2025 Background Conditions and the addition of project traffic causes both the average critical delay at the intersection to increase by four or more seconds **and** the volume-to-capacity ratio (V/C) to increase by one percent (0.01) or more under 2025 Background Plus Project Conditions.

An exception to rule #2 above applies when the addition of project-generated traffic reduces the amount of average control delay for critical movements (i.e., the change in average control delay for critical movements is negative). In this case, the threshold of significance is an increase in the critical V/C value by one percent (0.01) or more.

## CMP Definition of Significant Intersection Impacts

The Project is said to create a significant impact on traffic conditions at a CMP intersection if, for either peak hour

1. The level of service at a CMP-designated intersection degrades from an acceptable LOS E or better under 2025 Background Conditions to an unacceptable LOS F under 2025 Background Plus Project Conditions, **or**.
2. The level of service at a CMP-designated intersection is an unacceptable LOS F under 2025 Background Conditions and the addition of project traffic causes both the critical-movement delay at the intersection to increase by four or more seconds **and** the critical volume-to-capacity ratio (V/C) to increase by 0.01 or more under 2025 Background Plus Project Conditions.

An exception to rule #2 above applies when the addition of project-generated traffic reduces the amount of average control delay for critical movements (i.e. the change in average control delay for critical movements is

negative). In this case, the threshold of significance is an increase in the critical V/C value by one percent (0.01) or more.

### **CMP Definition of Significant Freeway Segment Impacts**

The CMP defines an acceptable level of service for freeway segments as LOS E or better. A project is said to create a significant impact on traffic conditions on a freeway segment if for either peak hour:

1. The level of service on a freeway segment degrades from an acceptable LOS E or better under 2025 Background Conditions to an unacceptable LOS F under 2025 Background Plus Project Conditions, **or**.
2. The level of service on a freeway segment is operating at an unacceptable LOS F under 2025 Background Conditions **and** the amount of project traffic added to that segment under the 2025 Background Plus Project Conditions constitutes at least one percent of capacity on that segment.

For all significant impact criteria listed above (City of San Jose, City of Santa Clara, and CMP), a significant impact is considered mitigated when 2025 Background Plus Project Mitigated Conditions intersection operations are compared against 2025 Background Conditions and no significant adverse impact criteria are triggered.

### **2015 Existing Plus Project Conditions Intersection Levels of Service**

This section evaluates the level of service of the study intersections under the 2015 Existing Plus Project scenario. In the following section, the 2015 Existing Plus Project Conditions are evaluated relative to 2015 Existing Conditions in order to determine potential project impacts on the future transportation network.

The extension of BART to the Alum Rock/28<sup>th</sup> Street and Santa Clara Stations is not expected to open until 2025 and the Transit-Oriented Joint Development at those two stations would not be completed until 2025 or later. Therefore, it is extremely unlikely that the 2015 Existing Plus Project Conditions would occur, since other approved projects expected to add traffic to the study area would likely be built and occupied between now and the year 2025. Additionally, numerous improvements to the transportation network (such as lane geometry changes at the study intersections) are projected to occur by 2025. The Existing (2015) Plus Project scenario is included in this TIA for informational purposes only, in accordance with VTA's *TIA Guidelines* and CEQA requirements.

### **Transportation Network Under Existing Plus Project Conditions**

It is assumed in this analysis that the transportation network under Existing Plus Project Conditions would be the same as the existing transportation network.

### **2015 Existing Plus Project Conditions Traffic Volumes**

The Project trips were added to existing traffic volumes to obtain Existing Plus Project Conditions traffic volumes. These Project trips include trips related to the Transit-Oriented Joint Development land uses, station drive access trips, and the shift in travel patterns as people switch from passenger vehicles to BART. 2015 Existing Plus Project Conditions traffic volumes are presented graphically in Figures 25 and 26 for the Alum Rock/28<sup>th</sup> Street and Santa Clara Stations, respectively. Traffic volumes for all components of traffic are tabulated in Appendix D.

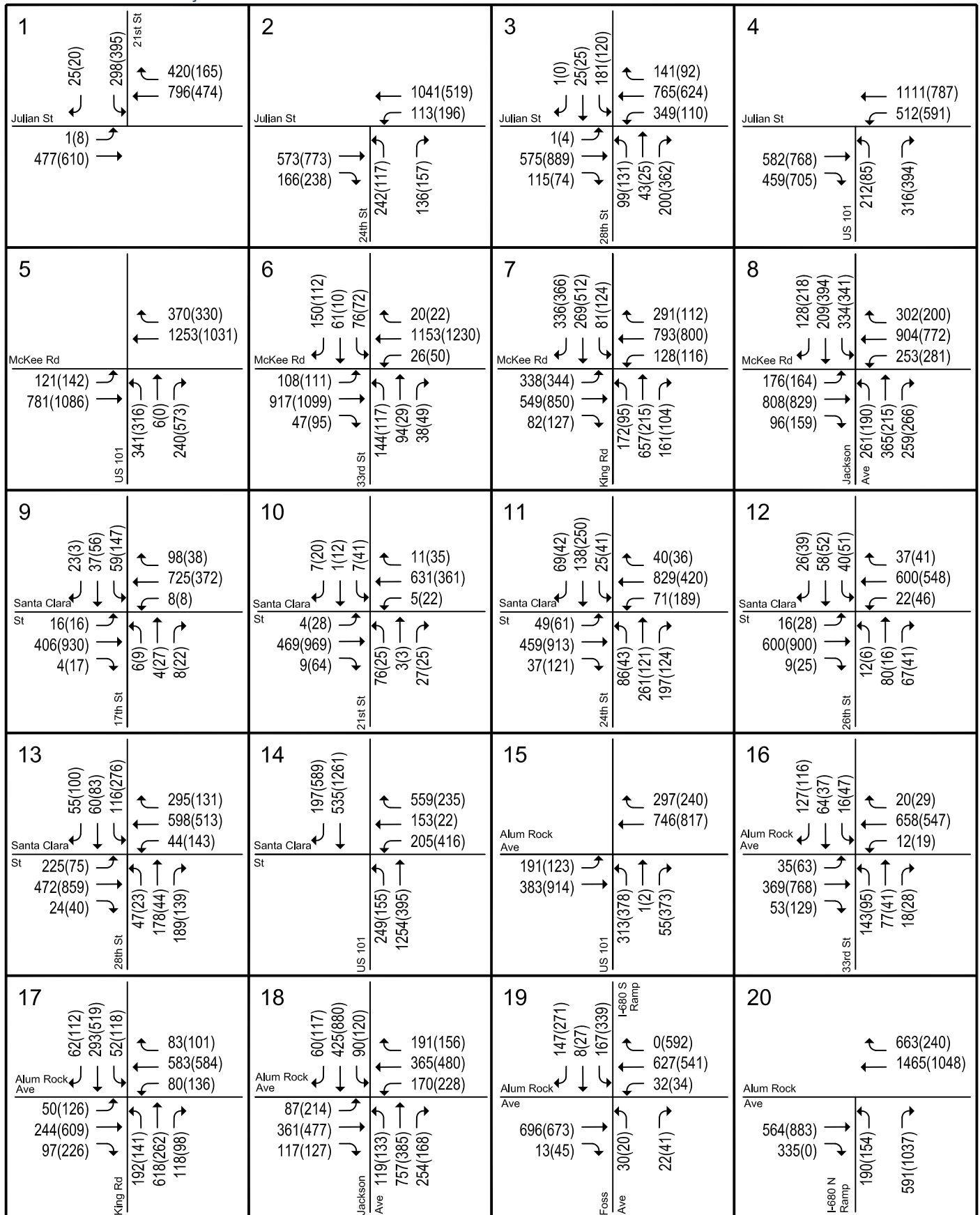

LEGEND

XX(XX) = AM(PM) Peak-Hour Traffic Volumes

**2015 Existing Plus Project Conditions Traffic Volumes - Alum Rock/28th Street Station**

**Figure 25**

Phase II Extension Project TIA

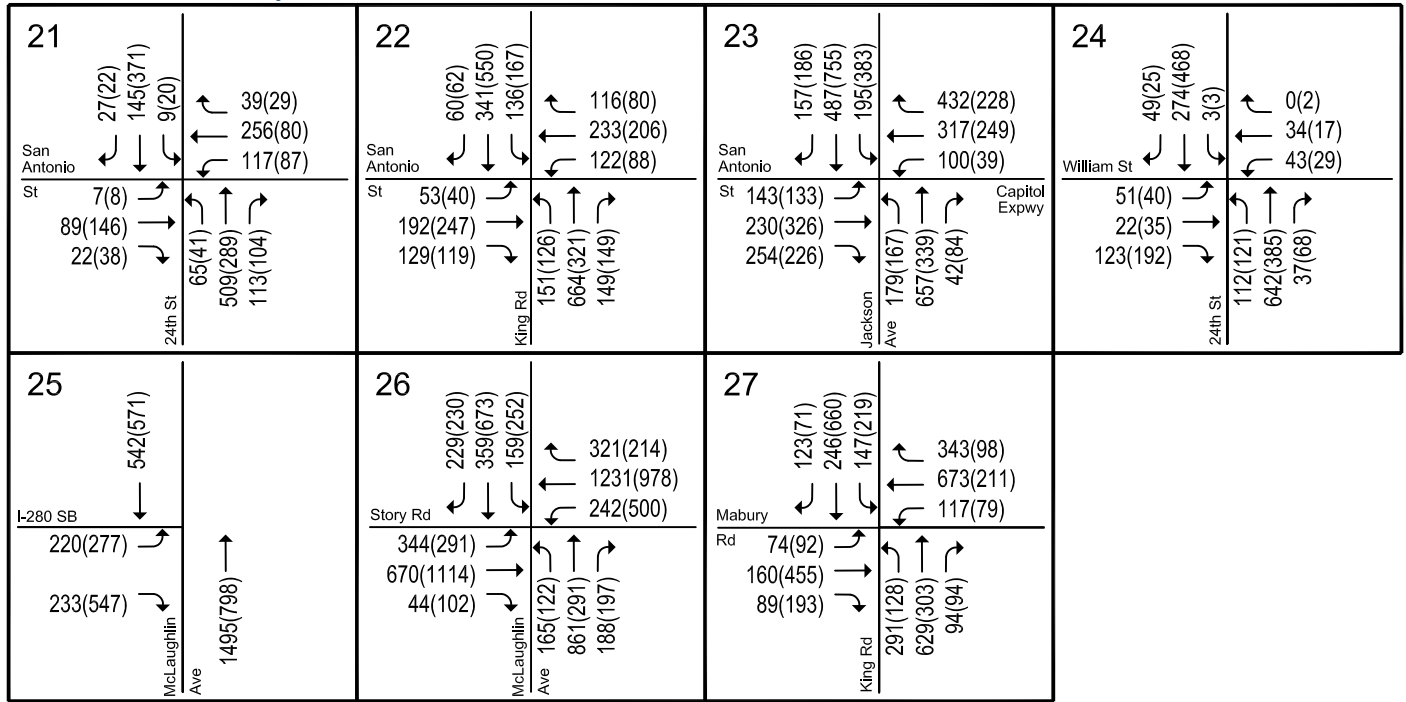

LEGEND

XX(XX) = AM(PM) Peak-Hour Traffic Volumes

Figure 25  
2015 Existing Plus Project Conditions Traffic Volumes - Alum Rock/28th Street Station



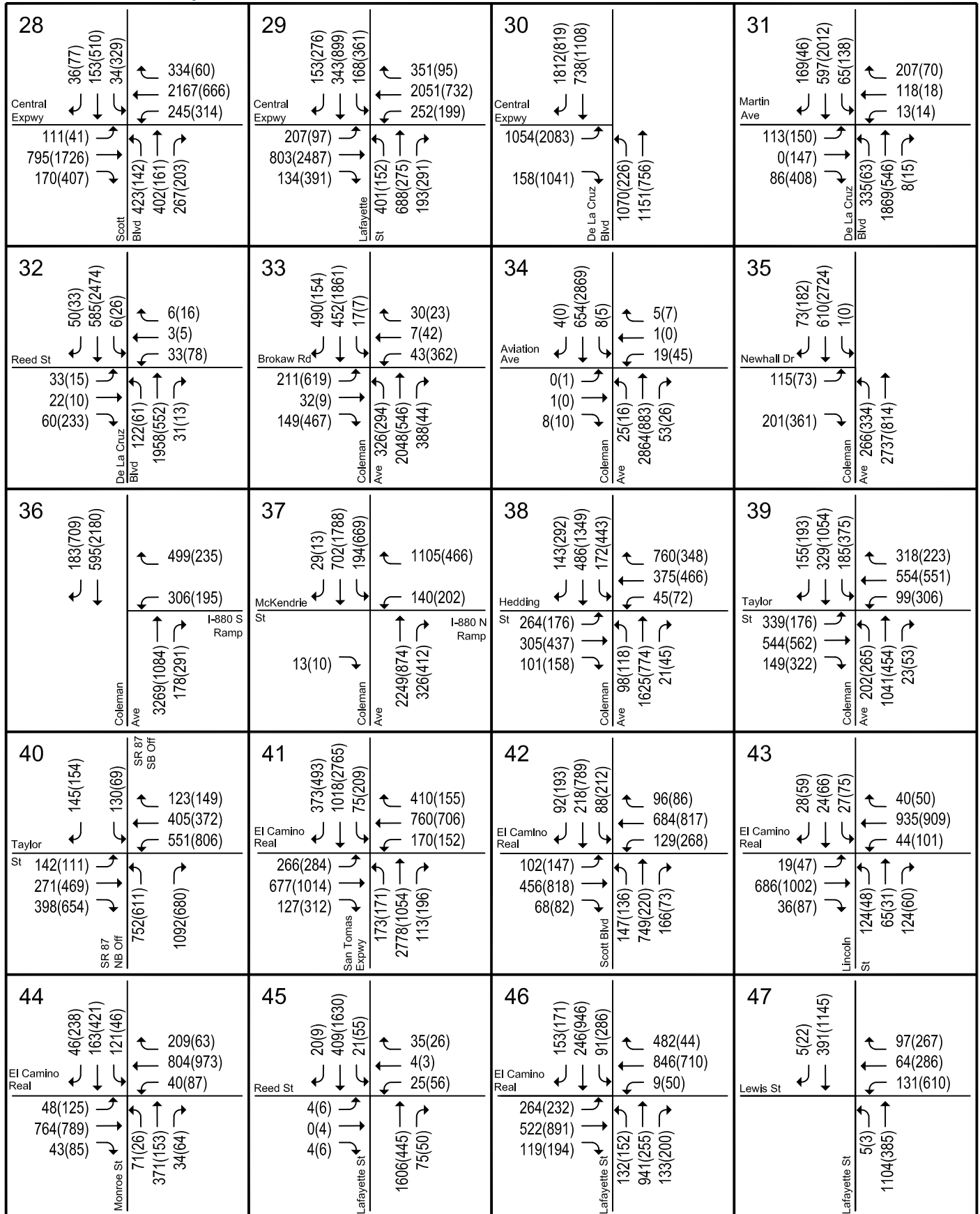

LEGEND

XX(X) = AM(PM) Peak-Hour Traffic Volumes

**Figure 26**  
**2015 Existing Plus Project Conditions Traffic Volumes - Santa Clara Station**

Phase II Extension Project TIA

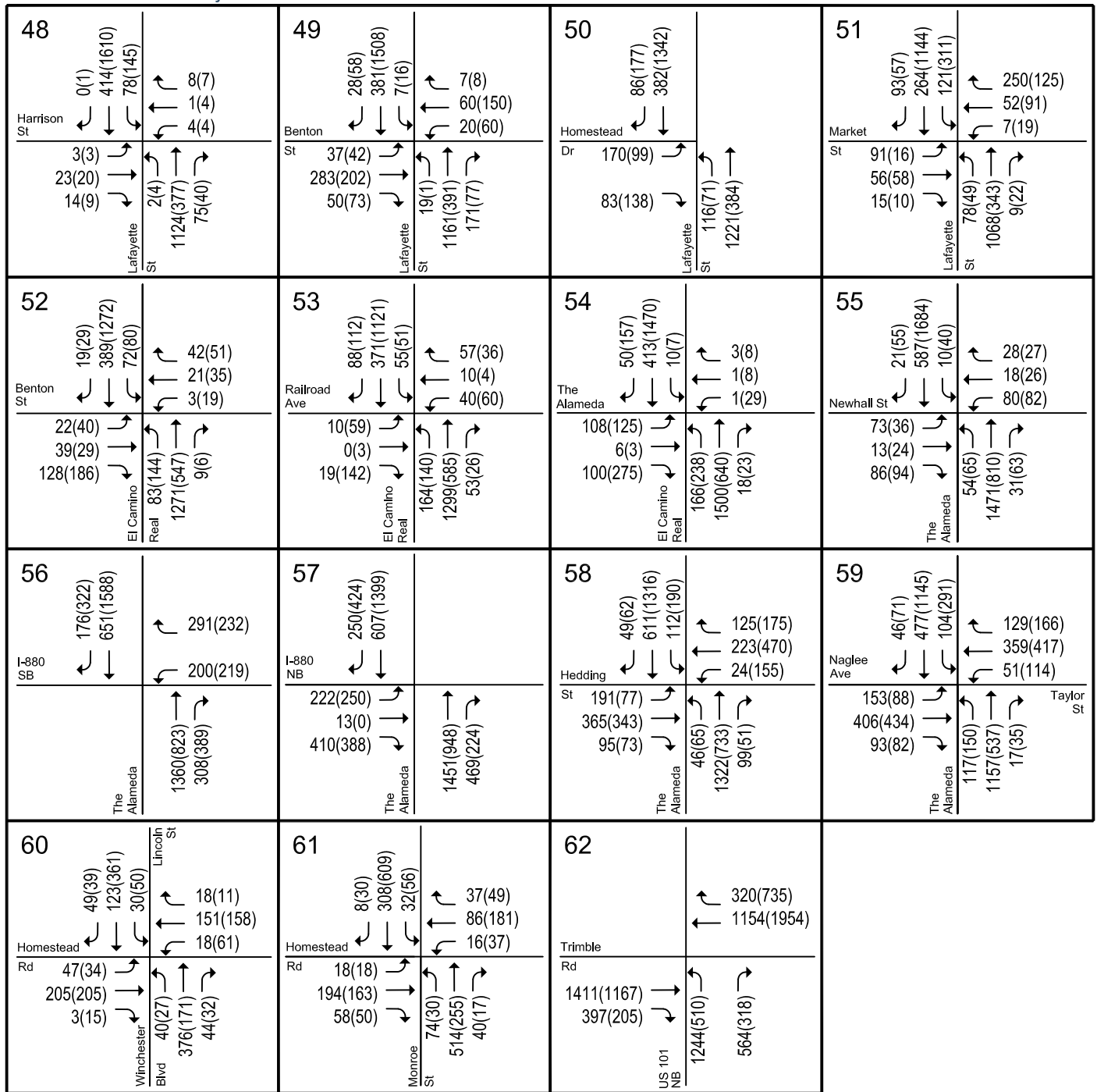

LEGEND

XX(XX) = AM(PM) Peak-Hour Traffic Volumes

Figure 26  
2015 Existing Plus Project Conditions Traffic Volumes - Santa Clara Station

## Intersection Levels of Service Under 2015 Existing Plus Project Conditions

Intersection levels of service under 2015 Existing Plus Project Conditions were evaluated against City of San Jose, City of Santa Clara, and CMP level of service standards. The results of the intersection level of service analysis under 2015 Existing Plus Project Conditions are summarized in Tables 14 and 15. The intersection level of service calculation sheets are included in Appendix E.

The determination of whether an intersection operates at an acceptable or unacceptable level of service (in accordance with the appropriate level of service standard) is a first step in determining whether or not a project would have a significant impact. For intersections that would operate at an unacceptable level of service under 2015 Existing Plus Project Conditions, the next step is to evaluate those intersections in relation to the 2015 Existing Conditions and apply the appropriate significant impact criteria (see the next section of this chapter).

### Alum Rock/28<sup>th</sup> Street Station

#### **City of San Jose Level of Service Analysis**

The results of the level of service analysis under 2015 Existing Plus Project Conditions show that, measured against the City of San Jose level of service standards, all 27 of the study intersections in the vicinity of the Alum Rock/28<sup>th</sup> Street Station would operate at an acceptable level of service (LOS D or better) during both the AM and PM peak hours of traffic.

#### **CMP Level of Service Analysis**

The results of the level of service analysis under 2015 Existing Plus Project Conditions show that, measured against the CMP standards, all of the study CMP intersections in the vicinity of the Alum Rock/28<sup>th</sup> Street Station would operate at an acceptable level of service (LOS E or better) during both the AM and PM peak hours of traffic.

### Santa Clara Station

#### **City of San Jose Level of Service Analysis**

The results of the level of service analysis under 2015 Existing Plus Project Conditions show that, measured against the City of San Jose level of service policy, all of the 13 Santa Clara Station study intersections located within San Jose would operate at an acceptable level of service (LOS D or better) during both the AM and PM peak hours of traffic.

#### **City of Santa Clara Level of Service Analysis**

The results of the level of service analysis under 2015 Existing Plus Project Conditions show that, measured against the City of Santa Clara level of service standards, all except two of the 22 Santa Clara Station study intersections located within Santa Clara would operate at an acceptable level of service (LOS D or better at local intersections and LOS E or better at expressway and CMP intersections) during both the AM and PM peak hours of traffic. The following two intersections would operate at unacceptable levels of service (LOS E or worse for local intersections and LOS F for expressways and CMP intersections) during at least one peak hour:

(#30) De La Cruz Boulevard and Central Expressway \* (LOS F – AM and PM peak hours)

(#33) Coleman Avenue and Brokaw Road (LOS F – PM peak hour)

The unsignalized intersection of Lafayette Street and Harrison Street (#48) has two-way stop control. The level of service shown for this intersection on Table 15, LOS F in the AM and PM peak hours, reflects the delay and the level of service for the stop-controlled approach with the highest delay, not the average of the entire intersection. Because the City of Santa Clara does not have a level of service standard for unsignalized intersections, this intersection cannot be said to operate at an unacceptable level of service. The level of service is presented for informational purposes only. The peak-hour traffic signal warrant checks for this intersection are included in Chapter 5.

### **CMP Level of Service Analysis**

The results of the level of service analysis under 2015 Existing Plus Project Conditions show that, measured against the CMP level of service standards, all except one of the CMP study intersections in the vicinity of the Santa Clara Station would operate at an acceptable level of service (LOS E or better during both the AM and PM peak hours of traffic). The following CMP intersection would operate at unacceptable levels of service (LOS F) during at least one peak hour:

(#30) De La Cruz Boulevard and Central Expressway \* (LOS F – AM and PM peak hours)

## **Intersection Impacts under 2015 Existing Plus Project Conditions**

This section evaluates whether the Project would result in a significant impact on the study intersections under the 2015 Existing Plus Project scenario, based on the significant impact criteria of the City of San Jose, the City of Santa Clara, and the CMP. To determine whether the Project would have an impact under 2015 Existing Plus Project Conditions, a comparison is made between 2015 Existing Conditions and 2015 Existing Plus Project Conditions, and the appropriate significant impact criteria are applied. Even though the significant impact criteria for the City of San Jose, the City of Santa Clara, and the CMP, as presented above, specify the comparison of 2025 Background and 2025 Background Plus Project Conditions, the same methodology and criteria can be applied to a comparison of 2015 Existing and 2015 Existing Plus Project Conditions. This comparison has been made, significant impacts identified, and mitigation measures presented for the 2015 Existing Plus Project scenario for informational purposes only.

### **Alum Rock/28<sup>th</sup> Street Station**

#### **City of San Jose Impact Analysis**

Based on the significant impact criteria of the City of San Jose, the Project would not result in any significant impacts to the intersections in the vicinity of the Alum Rock/28<sup>th</sup> Street Station under the 2015 Existing Plus Project scenario.

#### **CMP Impact Analysis**

Based on the significant impact criteria of the Congestion Management Program, the Project would not result in any significant impacts to the CMP intersections in the vicinity of the Alum Rock/28<sup>th</sup> Street Station under the 2015 Existing Plus Project scenario.

### **Santa Clara Station**

#### **City of San Jose Impact Analysis**

Based on the significant impact criteria of the City of San Jose, the Project would not result in any significant impacts to the San Jose intersections in the vicinity of the Santa Clara Station under the 2015 Existing Plus Project scenario.

#### **City of Santa Clara Impact Analysis**

When measured against the City of Santa Clara significant impact criteria, the Project would potentially cause a significant impact at the following Santa Clara intersection near Santa Clara Station under 2015 Existing Plus Project Conditions:

(#33) Coleman Avenue and Brokaw Road

Mitigation measures for this intersection have been proposed as follows:

**Coleman Avenue and Brokaw Road:** Change the signal control for Brokaw Road (the east and west legs of this intersection) from Protected Left-Turn phasing to Split Phase. Add a shared through/left-turn lane to the east and west approaches within the existing right-of-way. Change the existing shared through/right-turn lanes to right-turn only lanes on the east and west approaches, and change the

eastbound right-turn coding from Include to Overlap, indicating that many eastbound right turns would be able to turn “right on red.” With implementation of this mitigation measure, or a comparable mitigation measure as determined upon coordination with the City of Santa Clara, the impact would be mitigated to a *less than significant level*.

This mitigation measure is presented in Figure 30, in the section below concerning 2025 Background Plus Project intersection impacts and mitigation measures.

When measured against the City of Santa Clara significant impact criteria, the Project is not projected to cause an impact at the intersection of De La Cruz Boulevard and Central Expressway because the average delay under 2015 Existing Plus Project Conditions, when compared to 2015 Existing Conditions, would decrease by 5.5 seconds in the AM peak hour and increase by only 0.6 seconds in the PM peak hour.

### **CMP Impact Analysis**

Based on the significant impact criteria of the Congestion Management Program, the Project would not result in any significant impacts to the CMP intersections in the vicinity of the Santa Clara Station under the 2015 Existing Plus Project scenario.

**Table 14**  
**2015 and 2025 Project Conditions Intersection Levels of Service – Alum Rock/28<sup>th</sup> Street Station**

| Study Number | Intersection                                | Peak Hour | Count Date | Existing          |     | Existing Plus Project |     | Background        |     | Background Plus Project |     |                             |                    |
|--------------|---|-----------|------------|-------------------|-----|-----------------------|-----|-------------------|-----|-------------------------|-----|-----------------------------|--------------------|
|              |   |           |            | Avg. Delay (sec.) | LOS | Avg. Delay (sec.)     | LOS | Avg. Delay (sec.) | LOS | Avg. Delay (sec.)       | LOS | Incr. In Crit. Delay (sec.) | Incr. In Crit. V/C |
| 1            | 21st St & E. Julian St                      | AM        | 10/09/14   | 23.2              | C   | 23.7                  | C   | 23.8              | C   | 24.0                    | C   | 1.3                         | 0.005              |
|              |   | PM        | 10/09/14   | 12.7              | B   | 13                    | B   | 12.7              | B   | 13.0                    | B   | 0.7                         | 0.039              |
| 2            | 24th St & E. Julian St                      | AM        | 10/09/14   | 17.2              | B   | 16.7                  | B   | 17.5              | B   | 16.5                    | B   | -1.5                        | 0.053              |
|              |   | PM        | 10/09/14   | 17.1              | B   | 17.3                  | B   | 17.4              | B   | 17.2                    | B   | 0.8                         | 0.011              |
| 3            | N. 28th St & E. Julian St                   | AM        | 04/09/15   | 27.2              | C   | 28.7                  | C   | 27.2              | C   | 29.7                    | C   | 24.8                        | 0.140              |
|              |   | PM        | 04/08/15   | 14.2              | B   | 27.8                  | C   | 14.2              | B   | 27.8                    | C   | 16.7                        | 0.174              |
| 4            | US 101 SB ramps & E. Julian St              | AM        | 10/09/14   | 23.1              | C   | 27.2                  | C   | 26.9              | C   | 35.2                    | D   | 13.3                        | 0.105              |
|              |   | PM        | 10/09/14   | 26.8              | C   | 30.9                  | C   | 30.8              | C   | 35.7                    | D   | 5.6                         | 0.070              |
| 5            | US 101 NB ramps & McKee Rd                  | AM        | 10/09/14   | 22.1              | C   | 25.8                  | C   | 23.0              | C   | 24.2                    | C   | 2.7                         | 0.052              |
|              |   | PM        | 10/09/14   | 26.9              | C   | 28.3                  | C   | 28.6              | C   | 29.7                    | C   | 2.2                         | 0.028              |
| 6            | 33rd St & McKee Rd                          | AM        | 05/21/15   | 35.4              | D   | 35.7                  | D   | 34.0              | C   | 34.6                    | C   | 0.6                         | 0.016              |
|              |   | PM        | 05/20/15   | 29.7              | C   | 29.5                  | C   | 28.7              | C   | 29.0                    | C   | 0.4                         | -0.005             |
| 7            | King Rd & McKee Rd                          | AM        | 10/09/14   | 46.8              | D   | 47.5                  | D   | 52.6              | D   | 52.3                    | D   | -0.6                        | -0.007             |
|              |   | PM        | 10/08/14   | 47.2              | D   | 47.7                  | D   | 51.9              | D   | 51.7                    | D   | 1.5                         | 0.008              |
| 8            | Jackson Ave & McKee Rd                      | AM        | 05/21/15   | 39.3              | D   | 39.3                  | D   | 40.0              | D   | 40.0                    | D   | -0.1                        | -0.003             |
|              |   | PM        | 05/20/15   | 39.9              | D   | 39.9                  | D   | 40.9              | D   | 40.8                    | D   | -0.2                        | 0.006              |
| 9            | 17th St & E. Santa Clara St                 | AM        | 10/09/14   | 6.5               | A   | 6.4                   | A   | 17.1              | B   | 18.4                    | B   | 1.4                         | 0.024              |
|              |   | PM        | 10/09/14   | 9.3               | A   | 9.4                   | A   | 19.8              | B   | 20.5                    | C   | 0.7                         | 0.020              |
| 10           | 21st St & E. Santa Clara St                 | AM        | 10/09/14   | 5.7               | A   | 5.6                   | A   | 5.7               | A   | 5.7                     | A   | 0.1                         | -0.007             |
|              |   | PM        | 10/09/14   | 4.6               | A   | 4.5                   | A   | 4.6               | A   | 4.5                     | A   | 0.0                         | 0.004              |
| 11           | 24th St & E. Santa Clara St                 | AM        | 11/05/13   | 19.5              | B   | 19.6                  | B   | 19.7              | B   | 19.7                    | B   | -0.4                        | -0.014             |
|              |   | PM        | 11/05/13   | 21.1              | C   | 22.2                  | C   | 21.4              | C   | 22.8                    | C   | 2.1                         | 0.044              |
| 12           | 26th St. & E. Santa Clara St                | AM        | 10/09/14   | 16.5              | B   | 16.5                  | B   | 16.5              | B   | 16.5                    | B   | 0.0                         | 0.001              |
|              |   | PM        | 10/09/14   | 14.4              | B   | 13.9                  | B   | 14.4              | B   | 13.8                    | B   | -0.3                        | 0.016              |
| 13           | N. 28th St & E. Santa Clara St              | AM        | 10/09/14   | 20.9              | C   | 23.9                  | C   | 20.9              | C   | 24.6                    | C   | 7.3                         | 0.204              |
|              |   | PM        | 10/09/14   | 18.4              | B   | 21.3                  | C   | 18.4              | B   | 22.3                    | C   | 5.0                         | 0.150              |
| 14           | US 101 & E. Santa Clara St *                | AM        | 10/09/14   | 11.5              | B   | 10.9                  | B   | 11.8              | B   | 11.0                    | B   | -0.3                        | 0.025              |
|              |   | PM        | 09/09/14   | 16.2              | B   | 16.5                  | B   | 16.3              | B   | 16.0                    | B   | 1.1                         | 0.131              |
| 15           | US 101 & Alum Rock Ave *                    | AM        | 10/09/14   | 11                | B   | 12.2                  | B   | 11.0              | B   | 12.2                    | B   | 1.1                         | 0.049              |
|              |   | PM        | 09/09/14   | 15.9              | B   | 15.9                  | B   | 15.9              | B   | 16.1                    | B   | -0.1                        | -0.026             |
| 16           | 33rd St & Alum Rock Rd                      | AM        | 05/21/15   | 21.4              | C   | 21.2                  | C   | 21.4              | C   | 21.5                    | C   | 0.2                         | 0.013              |
|              |   | PM        | 05/20/15   | 18.5              | B   | 18.4                  | B   | 18.7              | B   | 18.7                    | B   | 0.0                         | 0.013              |
| 17           | King Rd & Alum Rock Ave *                   | AM        | 05/19/15   | 30.1              | C   | 30.5                  | C   | 30.9              | C   | 31.9                    | C   | 4.5                         | 0.013              |
|              |   | PM        | 09/16/14   | 34.4              | C   | 34.5                  | C   | 36.0              | D   | 35.5                    | D   | 0.1                         | -0.020             |
| 18           | Jackson Ave & Alum Rock Ave *               | AM        | 05/21/15   | 37.8              | D   | 38.3                  | D   | 42.8              | D   | 42.7                    | D   | -0.2                        | -0.006             |
|              |   | PM        | 09/30/14   | 43                | D   | 43.2                  | D   | 46.7              | D   | 46.4                    | D   | -0.5                        | -0.008             |
| 19           | I-680 S & Alum Rock Ave (West) *            | AM        | 05/21/15   | 22.2              | C   | 22.1                  | C   | 21.7              | C   | 21.8                    | C   | 0.1                         | -0.001             |
|              |   | PM        | 09/25/14   | 26.6              | C   | 26.2                  | C   | 26.5              | C   | 26.4                    | C   | -0.2                        | 0.001              |
| 20           | I-680 N & Alum Rock Ave (East) *            | AM        | 05/21/15   | 20.9              | C   | 20.9                  | C   | 21.3              | C   | 21.1                    | C   | -0.2                        | -0.004             |
|              |   | PM        | 09/25/14   | 26.3              | C   | 26.3                  | C   | 26.4              | C   | 26.3                    | C   | -0.1                        | -0.004             |
| 21           | 24th St & San Antonio St                    | AM        | 10/09/14   | 16                | B   | 16.5                  | B   | 16.0              | B   | 16.4                    | B   | 0.4                         | 0.034              |
|              |   | PM        | 10/09/14   | 12.6              | B   | 12.4                  | B   | 12.5              | B   | 12.3                    | B   | -0.3                        | 0.018              |
| 22           | King Rd & E. San Antonio St.                | AM        | 05/21/15   | 32.7              | C   | 32.9                  | C   | 32.7              | C   | 33.0                    | C   | 0.2                         | -0.008             |
|              |   | PM        | 05/20/15   | 33.8              | C   | 33.6                  | C   | 33.8              | C   | 34.1                    | C   | 0.3                         | 0.013              |
| 23           | Jackson Ave & E. San Antonio St/Capitol Exj | AM        | 05/21/15   | 35.7              | D   | 35.9                  | D   | 38.8              | D   | 38.8                    | D   | -0.3                        | -0.006             |
|              |   | PM        | 05/20/15   | 34.7              | C   | 34.8                  | C   | 35.2              | D   | 35.1                    | D   | -0.1                        | -0.007             |
| 24           | 24th St & E. William St.                    | AM        | 10/09/14   | 15.8              | B   | 15.3                  | B   | 15.9              | B   | 15.4                    | B   | -0.3                        | 0.035              |
|              |   | PM        | 10/09/14   | 19.4              | B   | 19                    | B   | 19.4              | B   | 19.0                    | B   | -0.4                        | 0.033              |
| 25           | McLaughlin Ave & I-280 SB Ramp *            | AM        | 10/09/14   | 9.5               | A   | 10.1                  | B   | 9.9               | A   | 10.2                    | B   | 0.6                         | 0.015              |
|              |   | PM        | 09/24/14   | 14.5              | B   | 14.5                  | B   | 15.1              | B   | 15.0                    | B   | 0.0                         | 0.002              |
| 26           | McLaughlin Ave & Story Rd                   | AM        | 10/09/14   | 42.4              | D   | 42.8                  | D   | 43.2              | D   | 43.4                    | D   | 0.4                         | 0.004              |
|              |   | PM        | 10/09/14   | 48.5              | D   | 48.7                  | D   | 52.2              | D   | 52.5                    | D   | 0.3                         | 0.002              |
| 27           | King Rd & Mabury Rd                         | AM        | 10/08/14   | 39.7              | D   | 39.7                  | D   | 43.2              | D   | 41.8                    | D   | -6.3                        | -0.016             |
|              |   | PM        | 10/08/14   | 38.9              | D   | 39.4                  | D   | 42.3              | D   | 40.5                    | D   | -3.4                        | -0.077             |

**Notes:**  
 \* Denotes a CMP intersection  
**Bold** indicates a substandard level of service (according to City of San Jose standards)



**Table 15**  
**2015 and 2025 Project Conditions Intersection Levels of Service –Santa Clara Station**

| Study Number | Intersection  | Location    | Peak Hour | Count Date | Existing          |          | Existing Plus Project |          | Background        |          | Background Plus Project |          |                             |                    |
|--------------|---|-------------|-----------|------------|-------------------|----------|-----------------------|----------|-------------------|----------|-------------------------|----------|-----------------------------|--------------------|
|              |   |             |           |            | Avg. Delay (sec.) | LOS      | Avg. Delay (sec.)     | LOS      | Avg. Delay (sec.) | LOS      | Avg. Delay (sec.)       | LOS      | Incr. In Crit. Delay (sec.) | Incr. In Crit. V/C |
| 28           | Scott Blvd & Central Expy *                           | Santa Clara | AM        | 05/21/15   | 43.8              | D        | 43.8                  | D        | 42.9              | D        | 42.7                    | D        | -0.2                        | -0.002             |
|              |   |             | PM        | 10/02/14   | <b>64.1</b>       | <b>E</b> | <b>64.9</b>           | <b>E</b> | <b>75.5</b>       | <b>E</b> | <b>72.9</b>             | <b>E</b> | <b>-4.6</b>                 | <b>-0.098</b>      |
| 29           | Lafayette St & Central Expy *                         | Santa Clara | AM        | 05/21/15   | 53.7              | D        | 53.9                  | D        | 51.3              | D        | 51.6                    | D        | 0.7                         | 0.009              |
|              |   |             | PM        | 09/24/14   | <b>71.1</b>       | <b>E</b> | <b>71.4</b>           | <b>E</b> | <b>68.7</b>       | <b>E</b> | <b>68.4</b>             | <b>E</b> | <b>-0.3</b>                 | <b>0.002</b>       |
| 30           | De La Cruz Blvd & Central Expy *                      | Santa Clara | AM        | 10/08/14   | <b>270.6</b>      | <b>F</b> | <b>265.1</b>          | <b>F</b> | <b>310.3</b>      | <b>F</b> | <b>300.7</b>            | <b>F</b> | <b>-4.6</b>                 | <b>-0.011</b>      |
|              |   |             | PM        | 10/02/14   | <b>95.8</b>       | <b>F</b> | <b>96.4</b>           | <b>F</b> | <b>101.2</b>      | <b>F</b> | <b>102.8</b>            | <b>F</b> | <b>2.4</b>                  | <b>0.007</b>       |
| 31           | De La Cruz Blvd & Martin Ave                          | Santa Clara | AM        | 10/08/14   | 34.9              | C        | 35.5                  | D        | 34.8              | C        | 36.2                    | D        | 1.4                         | 0.018              |
|              |   |             | PM        | 10/08/14   | 30.7              | C        | 30.8                  | C        | 31.8              | C        | 32.1                    | C        | 0.4                         | 0.003              |
| 32           | De La Cruz Blvd & Reed St                             | Santa Clara | AM        | 10/08/14   | 11.1              | B        | 11.2                  | B        | 10.7              | B        | 11.4                    | B        | 1.1                         | 0.010              |
|              |   |             | PM        | 10/08/14   | 18.1              | B        | 18.2                  | B        | 19.0              | B        | 18.9                    | B        | 0.3                         | 0.010              |
| 33           | Coleman Ave & Brokaw Rd                               | Santa Clara | AM        | 10/08/14   | 17                | B        | 21.8                  | C        | 17.2              | B        | 23.0                    | C        | 4.2                         | 0.047              |
|              |   |             | PM        | 10/08/14   | <b>88</b>         | <b>F</b> | <b>157.9</b>          | <b>F</b> | <b>57.9</b>       | <b>E</b> | <b>113.7</b>            | <b>F</b> | <b>72.0</b>                 | <b>0.173</b>       |
|              | <i>With Mitigation</i>                                |             |           |            |                   |          |                       |          |                   |          | 48.3                    | D        |                             |                    |
| 34           | Coleman Ave & Aviation Ave                            | San Jose    | AM        | 10/08/14   | 14.6              | B        | 20.4                  | C        | 31.3              | C        | 40.3                    | D        | 13.7                        | 0.038              |
|              |   |             | PM        | 10/08/14   | 7.2               | A        | 7.3                   | A        | 18.2              | B        | 18.6                    | B        | 0.6                         | 0.025              |
| 35           | Coleman Ave & Newhall Dr                              | San Jose    | AM        | 10/08/14   | 13.6              | B        | 13.5                  | B        | 14.2              | B        | 14.5                    | B        | 0.6                         | 0.023              |
|              |   |             | PM        | 10/08/14   | 18.1              | B        | 18.0                  | B        | 24.6              | C        | 26.5                    | C        | 2.8                         | 0.022              |
| 36           | Coleman Ave & I-880 SB Ramps *                        | San Jose    | AM        | 05/12/15   | 24.7              | C        | 27.7                  | C        | <b>107.9</b>      | <b>F</b> | <b>119.8</b>            | <b>F</b> | <b>14.5</b>                 | <b>0.032</b>       |
|              | <i>With Mitigation</i>                                |             |           |            |                   |          |                       |          |                   |          | 44.8                    | D        |                             |                    |
|              |   |             | PM        | 09/25/14   | 11.6              | B        | 12.4                  | B        | 43.6              | D        | 48.6                    | D        | 13.7                        | 0.035              |
| 37           | Coleman Ave & I-880 NB Ramps *                        | San Jose    | AM        | 05/12/15   | 37.3              | D        | 39.2                  | D        | <b>85.8</b>       | <b>F</b> | <b>89.8</b>             | <b>F</b> | <b>4.7</b>                  | <b>0.011</b>       |
|              |   |             | PM        | 09/25/14   | 26.2              | C        | 26.6                  | C        | 32.6              | C        | 33.0                    | C        | -0.3                        | 0.000              |
| 38           | Coleman Ave & W. Hedding St                           | San Jose    | AM        | 05/12/15   | 41                | D        | 42.2                  | D        | 41.2              | D        | 41.4                    | D        | 0.0                         | 0.000              |
|              |   |             | PM        | 05/12/15   | 38.1              | D        | 38.5                  | D        | 36.7              | D        | 36.7                    | D        | 0.2                         | 0.011              |
| 39           | Coleman Ave & W. Taylor St                            | San Jose    | AM        | 05/12/15   | 45                | D        | 45.4                  | D        | <b>60.0</b>       | <b>E</b> | <b>60.2</b>             | <b>E</b> | <b>0.2</b>                  | <b>0.000</b>       |
|              |   |             | PM        | 05/12/15   | 44.7              | D        | 45.1                  | D        | <b>63.7</b>       | <b>E</b> | <b>64.8</b>             | <b>E</b> | <b>1.9</b>                  | <b>0.007</b>       |
| 40           | SR 87 & W. Taylor St                                  | San Jose    | AM        | 05/12/15   | 24.2              | C        | 24.4                  | C        | 28.7              | C        | 28.5                    | C        | -0.6                        | -0.004             |
|              |   |             | PM        | 05/12/15   | 32.6              | C        | 32.6                  | C        | 38.5              | D        | 37.8                    | D        | -0.6                        | -0.004             |
| 41           | San Tomas Expy & El Camino Real *                     | Santa Clara | AM        | 10/08/14   | <b>66.1</b>       | <b>E</b> | <b>66.2</b>           | <b>E</b> | <b>83.8</b>       | <b>F</b> | <b>82.8</b>             | <b>F</b> | <b>-1.3</b>                 | <b>-0.004</b>      |
|              |   |             | PM        | 09/23/14   | <b>79.7</b>       | <b>E</b> | <b>79.5</b>           | <b>E</b> | <b>129.5</b>      | <b>F</b> | <b>126.8</b>            | <b>F</b> | <b>-4.9</b>                 | <b>-0.003</b>      |
| 42           | Scott Blvd & El Camino Real *                         | Santa Clara | AM        | 10/08/14   | 33.8              | C        | 33.6                  | C        | 34.1              | C        | 34.1                    | C        | 0.1                         | -0.001             |
|              |   |             | PM        | 09/17/14   | 37.7              | D        | 37.9                  | D        | 38.4              | D        | 38.6                    | D        | 0.7                         | 0.012              |
| 43           | Lincoln St & El Camino Real *                         | Santa Clara | AM        | 05/21/15   | 21.1              | C        | 21.0                  | C        | 20.9              | C        | 20.8                    | C        | -0.1                        | 0.000              |
|              |   |             | PM        | 09/17/14   | 23.1              | C        | 22.7                  | C        | 23.6              | C        | 23.3                    | C        | 0.0                         | 0.005              |
| 44           | Monroe St & El Camino Real *                          | Santa Clara | AM        | 10/08/14   | 35.5              | D        | 35.8                  | D        | 35.8              | D        | 36.2                    | D        | 0.2                         | 0.007              |
|              |   |             | PM        | 09/17/14   | 32.9              | C        | 32.8                  | C        | 33.4              | C        | 33.2                    | C        | -0.1                        | 0.012              |
| 45           | Lafayette St & Reed St                                | Santa Clara | AM        | 01/01/13   | 6.8               | A        | 6.8                   | A        | 7.3               | A        | 7.3                     | A        | 0.1                         | 0.002              |
|              |   |             | PM        | 01/01/13   | 7.4               | A        | 7.5                   | A        | 7.5               | A        | 7.7                     | A        | 0.2                         | 0.006              |
| 46           | Lafayette St & El Camino Real *                       | Santa Clara | AM        | 10/08/14   | 40.8              | D        | 40.2                  | D        | 43.0              | D        | 42.4                    | D        | 0.0                         | 0.000              |
|              |   |             | PM        | 09/17/14   | 41.3              | D        | 41.6                  | D        | 43.0              | D        | 43.4                    | D        | 1.0                         | 0.015              |
| 47           | Lafayette St & Lewis St                               | Santa Clara | AM        | 10/08/14   | 10.7              | B        | 11.0                  | B        | 10.0              | B        | 10.4                    | B        | 0.6                         | 0.021              |
|              |   |             | PM        | 10/08/14   | 31.9              | C        | 34.6                  | C        | 45.8              | D        | 52.0                    | D        | 7.0                         | 0.025              |
| 48           | Lafayette St & Harrison St<br><i>Unsignalized (3)</i> | Santa Clara | AM        | 10/08/14   | 48.9              | E        | 54.5                  | F        | 69.9              | F        | 90.0                    | F        | --                          | --                 |
|              |   |             | PM        | 10/08/14   | 176.9             | F        | 226.3                 | F        | 304.2             | F        | 382.4                   | F        | --                          | --                 |
| 49           | Lafayette St & Benton St                              | Santa Clara | AM        | 10/08/14   | 17.1              | B        | 17.0                  | B        | 17.2              | B        | 17.2                    | B        | -0.1                        | 0.019              |
|              |   |             | PM        | 10/08/14   | 15.7              | B        | 15.6                  | B        | 17.8              | B        | 17.9                    | B        | 0.1                         | 0.025              |
| 50           | Lafayette St & Homestead Rd                           | Santa Clara | AM        | 05/21/15   | 19.1              | B        | 20.8                  | C        | 26.6              | C        | 32.8                    | C        | 8.4                         | 0.034              |
|              |   |             | PM        | 05/20/15   | 9.7               | A        | 9.3                   | A        | 9.3               | A        | 9.0                     | A        | -0.3                        | 0.022              |
| 51           | Lafayette St & Market St                              | Santa Clara | AM        | 05/21/15   | 16.6              | B        | 16.8                  | B        | 17.3              | B        | 17.8                    | B        | 0.6                         | 0.027              |
|              |   |             | PM        | 05/20/15   | 24.6              | C        | 24.5                  | C        | 25.2              | C        | 25.2                    | C        | -0.2                        | 0.019              |
| 52           | El Camino Real & Benton St                            | Santa Clara | AM        | 10/08/14   | 12.8              | B        | 12.6                  | B        | 12.6              | B        | 12.5                    | B        | -0.1                        | 0.013              |
|              |   |             | PM        | 10/08/14   | 15.4              | B        | 15.3                  | B        | 15.4              | B        | 15.2                    | B        | -0.3                        | 0.004              |
| 53           | El Camino Real & Railroad Ave                         | Santa Clara | AM        | 10/08/14   | 10.5              | B        | 10.4                  | B        | 10.5              | B        | 10.5                    | B        | 0.0                         | 0.011              |
|              |   |             | PM        | 10/08/14   | 12.4              | B        | 12.3                  | B        | 12.4              | B        | 12.3                    | B        | -0.2                        | 0.005              |
| 54           | El Camino Real & The Alameda *                        | Santa Clara | AM        | 10/08/14   | 13                | B        | 12.9                  | B        | 13.0              | B        | 13.0                    | B        | 0.1                         | 0.005              |
|              |   |             | PM        | 09/17/14   | 17.2              | B        | 17.2                  | B        | 17.0              | B        | 17.0                    | B        | -0.1                        | 0.000              |
| 55           | The Alameda & Newhall Dr                              | San Jose    | AM        | 05/21/15   | 12.5              | B        | 12.6                  | B        | 12.4              | B        | 12.4                    | B        | -0.2                        | -0.007             |
|              |   |             | PM        | 05/20/15   | 12.6              | B        | 12.6                  | B        | 12.6              | B        | 12.5                    | B        | -0.1                        | -0.002             |
| 56           | The Alameda & I-880 (South) *                         | San Jose    | AM        | 05/07/15   | 19.2              | B        | 18.8                  | B        | 20.5              | C        | 19.3                    | B        | -1.7                        | -0.014             |
|              |   |             | PM        | 09/25/14   | 14.6              | B        | 14.6                  | B        | 15.2              | B        | 14.6                    | B        | -1.0                        | -0.017             |
| 57           | The Alameda & I-880 (North) *                         | San Jose    | AM        | 05/07/15   | 23.2              | C        | 23.0                  | C        | 24.4              | C        | 24.3                    | C        | -0.1                        | -0.002             |
|              |   |             | PM        | 09/25/14   | 21.2              | C        | 21.2                  | C        | 21.1              | C        | 21.2                    | C        | 0.1                         | 0.002              |
| 58           | The Alameda & W. Hedding St *                         | San Jose    | AM        | 05/21/15   | 37.2              | D        | 37.7                  | D        | 39.2              | D        | 39.2                    | D        | 0.1                         | 0.000              |
|              |   |             | PM        | 09/30/14   | 38                | D        | 37.9                  | D        | 39.3              | D        | 39.2                    | D        | -0.3                        | -0.004             |
| 59           | The Alameda & W. Taylor St/Naglee Ave *               | San Jose    | AM        | 05/21/15   | 42.3              | D        | 42.3                  | D        | 42.7              | D        | 42.3                    | D        | -0.8                        | -0.010             |
|              |   |             | PM        | 09/30/14   | 40.5              | D        | 43.4                  | D        | 46.7              | D        | 47.0                    | D        | 0.6                         | 0.008              |
| 60           | Homestead Rd & Lincoln St/Winchester Blvd             | Santa Clara | AM        | 05/21/15   | 21.3              | C        | 21.2                  | C        | 21.5              | C        | 21.4                    | C        | -0.3                        | 0.008              |
|              |   |             | PM        | 05/20/15   | 21.4              | C        | 21.4                  | C        | 21.6              | C        | 21.6                    | C        | -0.2                        | 0.008              |
| 61           | Homestead Rd & Monroe St                              | Santa Clara | AM        | 05/21/15   | 9.8               | A        | 9.8                   | A        | 9.9               | A        | 9.9                     | A        | 0.0                         | 0.004              |
|              |   |             | PM        | 05/20/15   | 10.5              | B        | 10.5                  | B        | 10.5              | B        | 10.5                    | B        | 0.0                         | 0.001              |
| 62           | US 101 & Trimble                                      | San Jose    | AM        | 10/07/14   | 21.8              | C        | 22.6                  | C        | 22.8              | C        | 23.1                    | C        | 0.1                         | 0.002              |
|              |   |             | PM        | 10/07/14   | 13.6              | B        | 13.6                  | B        | 13.1              | B        | 13.1                    | B        | 0.0                         | -0.003             |

Notes:  
 \* Denotes a CMP intersection  
 (1) The reported delay and corresponding level of service for signalized intersections represent the average delay for all approaches at the intersection. The reported delay and corresponding level of service for unsignalized (two-way stop-controlled) intersections are based on the stop-controlled approach with the highest delay.  
**Bold** indicates a substandard level of service (according to City of San Jose or City of Santa Clara standards).  
**Bold** indicates a significant impact (according to the City of San Jose or City of Santa Clara standards)

## 2025 Background Plus Project Conditions Intersection Levels of Service

This section evaluates the level of service of the study intersections under the 2025 Background Plus Project scenario. In the following section, the 2025 Background Plus Project Conditions are evaluated relative to 2025 Background Conditions in order to determine potential project impacts on the future transportation network.

### Transportation Network Under 2025 Background Plus Project Conditions

It is assumed in this analysis that the transportation network under 2025 Background Plus Project Conditions would be the same as the background transportation network.

### 2025 Background Plus Project Conditions Traffic Volumes

The Project trips were added to background traffic volumes to obtain 2025 Background Plus Project Conditions traffic volumes. These Project trips include trips related to the Transit-Oriented Joint Development land uses, BART station drive access trips, and the shift in travel patterns as people switch from passenger vehicles to BART. 2025 Background Plus Project Conditions traffic volumes are presented graphically in Figures 27 and 28 for the Alum Rock/28<sup>th</sup> Street and Santa Clara Stations, respectively. Traffic volumes for all components of traffic are tabulated in Appendix D.

### Intersection Levels of Service Under 2025 Background Plus Project Conditions

Intersection levels of service were evaluated against City of San Jose, City of Santa Clara, and CMP level of service standards and significant impact criteria. The results of the intersection level of service analysis under 2025 Background Plus Project Conditions are summarized in Tables 14 and 15 above. The intersection level of service calculation sheets are included in Appendix E.

The determination of whether an intersection operates at an acceptable or unacceptable level of service (in accordance with the appropriate level of service standard) is a first step in determining whether or not a project would have a significant impact. For intersections that would operate at an unacceptable level of service under 2025 Background Plus Project Conditions, the next step is to evaluate those intersections in relation to the 2025 Background Conditions and apply the appropriate significant impact criteria (see the next section of this chapter).

#### Alum Rock/28<sup>th</sup> Street Station

##### **City of San Jose Level of Service Analysis**

The results of the level of service analysis under 2025 Background Plus Project Conditions show that, measured against the City of San Jose level of service standards, all 27 of the study intersections in the vicinity of the Alum Rock/28<sup>th</sup> Street Station would operate at an acceptable level of service (LOS D or better) during both the AM and PM peak hours of traffic.

##### **CMP Level of Service Analysis**

The results of the level of service analysis under 2025 Background Plus Project Conditions show that, measured against the CMP standards, all of the study CMP intersections in the vicinity of the Alum Rock/28<sup>th</sup> Street Station would operate at an acceptable level of service (LOS E or better) during both the AM and PM peak hours of traffic.

#### Santa Clara Station

##### **City of San Jose Level of Service Analysis**

The results of the level of service analysis under 2025 Background Plus Project Conditions show that, measured against the City of San Jose level of service policy, all but three of the Santa Clara Station study intersections that are located within San Jose would operate at an acceptable level of service (LOS D or better) during both the AM and PM peak hours of traffic. The following three intersections would operate at unacceptable levels of service (LOS E or F) under 2025 Background Plus Project Conditions during at least one peak hour:

Phase II Extension Project TIA

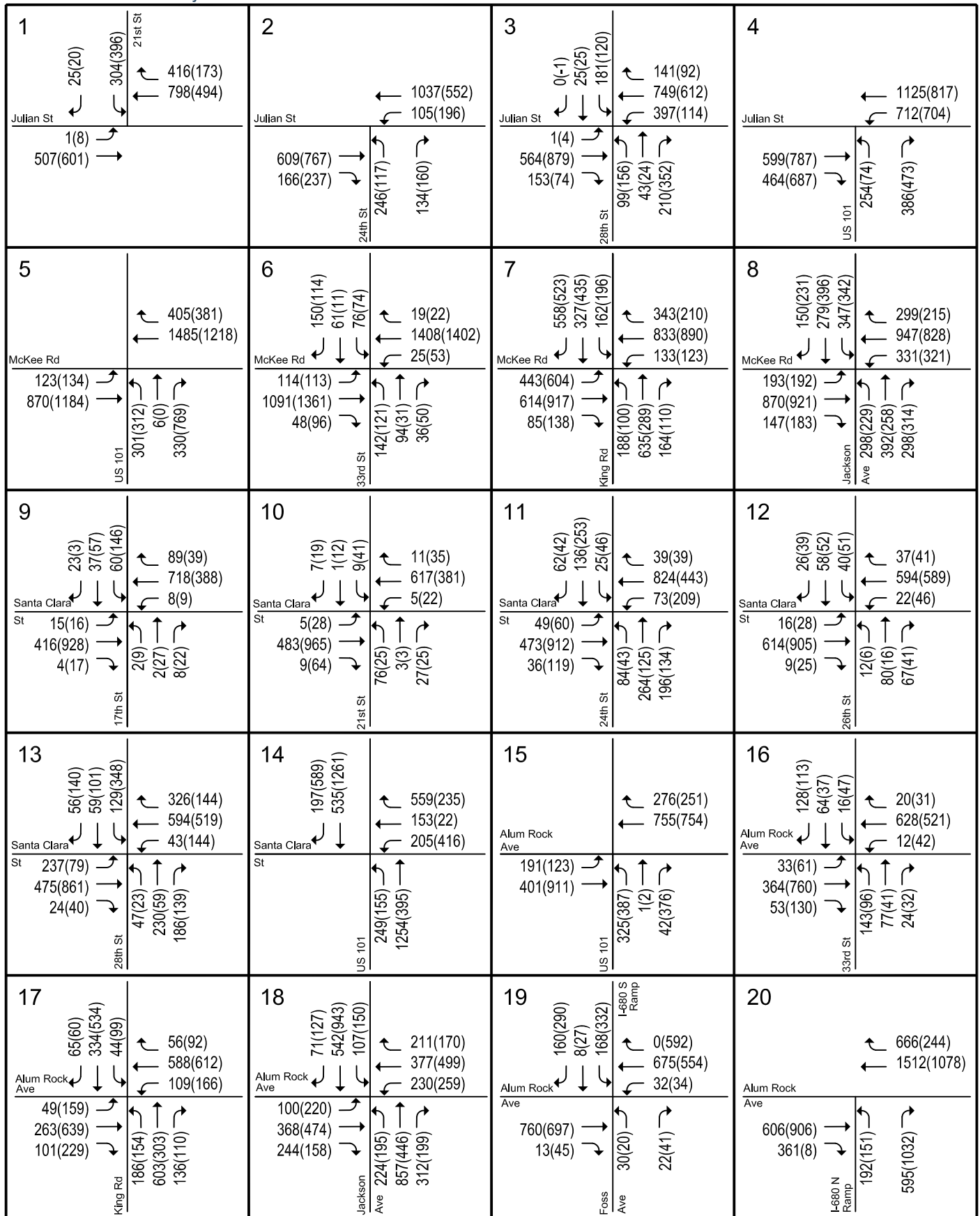

LEGEND

XX(XX) = AM(PM) Peak-Hour Traffic Volumes

**2025 Background Plus Project Conditions Traffic Volumes - Alum Rock/28th Street Station**

**Figure 27**



Phase II Extension Project TIA

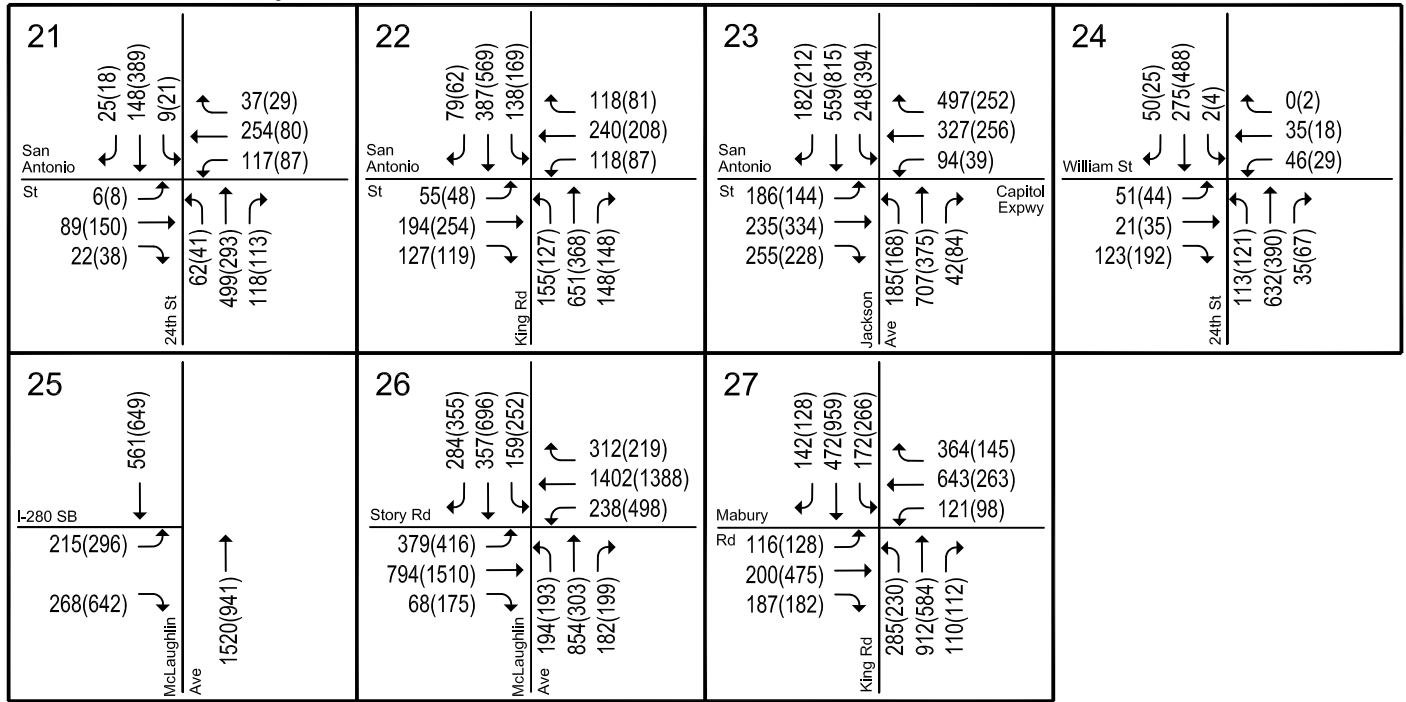

LEGEND

XX(XX) = AM(PM) Peak-Hour Traffic Volumes

Figure 27  
2025 Background Plus Project Conditions Traffic Volumes - Alum Rock/28th Street Station

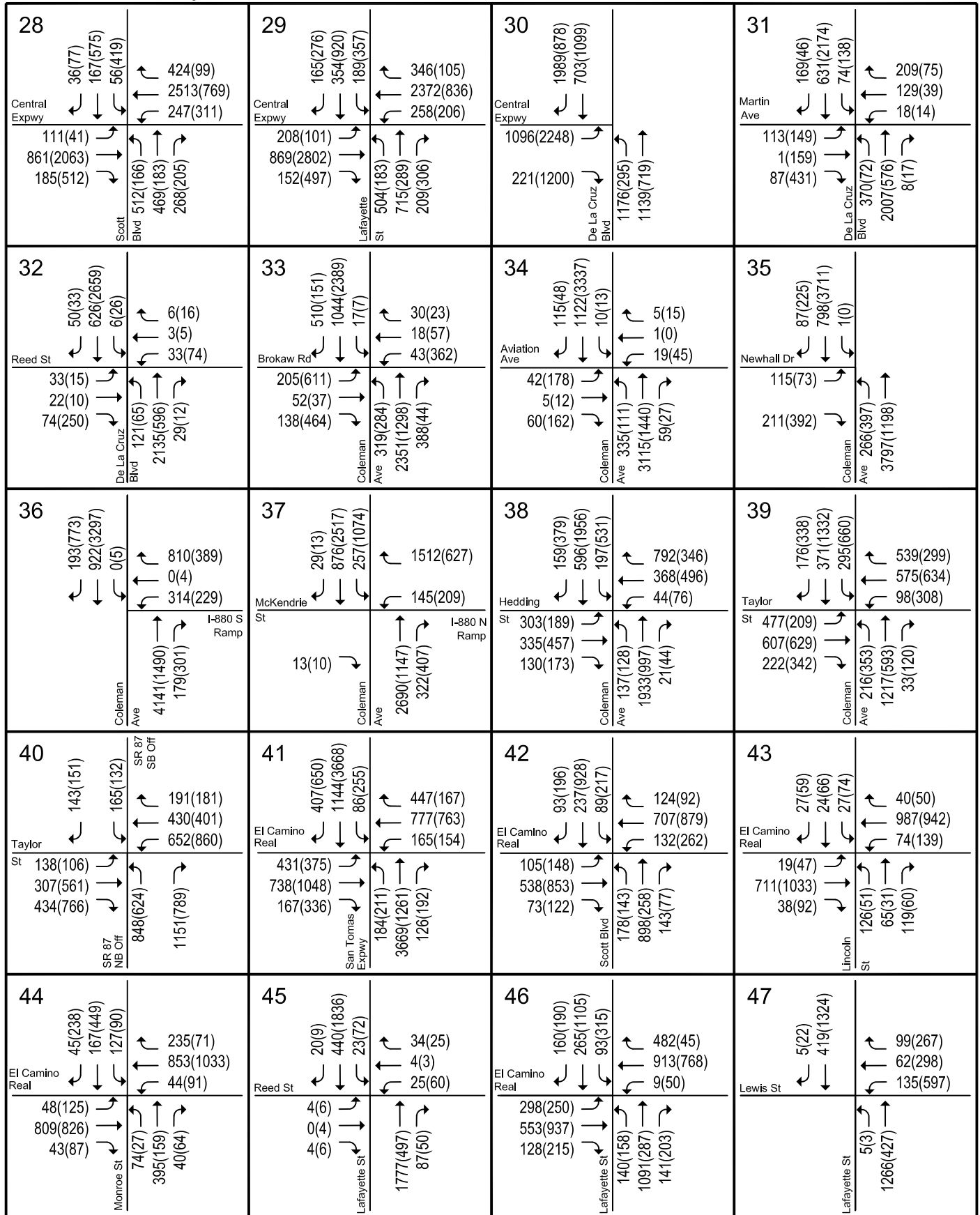

LEGEND

XX(XX) = AM(PM) Peak-Hour Traffic Volumes

**Figure 28**  
**2025 Background Plus Project Conditions Traffic Volumes - Santa Clara Station**



Phase II Extension Project TIA

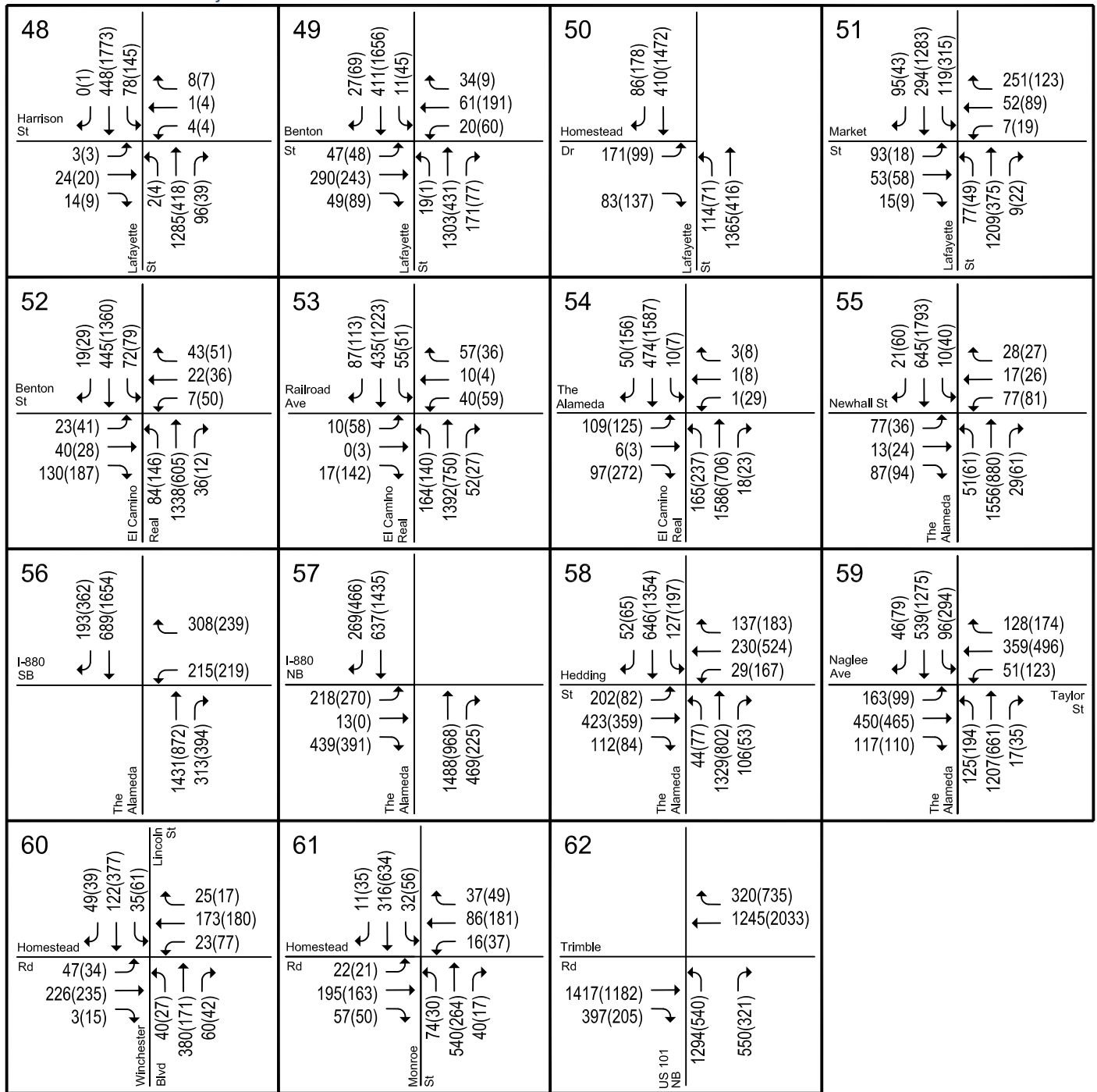

LEGEND

XX(XY) = AM(PM) Peak-Hour Traffic Volumes

Figure 28  
2025 Background Plus Project Conditions Traffic Volumes - Santa Clara Station



- (#36) Coleman Avenue and I-880 Southbound Ramps \* (LOS F – AM peak hour)
- (#37) Coleman Avenue and I-880 Northbound Ramps \* (LOS F – AM peak hour)
- (#39) Coleman Avenue and Taylor Street (LOS E – AM and PM peak hours)

### City of Santa Clara Level of Service Analysis

The results of the level of service analysis under 2025 Background Plus Project Conditions show that, measured against the City of Santa Clara level of service standards, all except three of the Santa Clara Station study intersections located within Santa Clara would operate at an acceptable level of service (LOS D or better at local intersections and LOS E or better at expressway and CMP intersections) during both the AM and PM peak hours of traffic. The following three intersections would operate at unacceptable levels of service (LOS E or worse for local intersections and LOS F for expressways and CMP intersections) under 2025 Background Plus Conditions during at least one peak hour:

- (#30) De La Cruz Boulevard and Central Expressway \* (LOS F – AM and PM peak hours)
- (#33) Coleman Avenue and Brokaw Road (LOS F – PM peak hour)
- (#41) San Tomas Expressway and El Camino Real \* (LOS F – AM and PM peak hours)

The unsignalized intersection of Lafayette Street and Harrison Street (#48) has two-way stop control. The level of service shown for this intersection on Table 14, LOS F in both the AM and PM peak hours, reflects the delay and the level of service for the stop-controlled approach with the highest delay, not the average of the entire intersection. Because the City of Santa Clara does not have a level of service standard for unsignalized intersections, this intersection cannot be said to operate at an unacceptable level of service. The level of service is presented for informational purposes only. The peak-hour traffic signal warrant checks for this intersection are included in Chapter 5.

### CMP Level of Service Analysis

The results of the level of service analysis under 2025 Background Plus Project Conditions show that, measured against the CMP level of service standards, all except four of the CMP study intersections in the vicinity of the Santa Clara Station would operate at an acceptable level of service (LOS E or better) during both the AM and PM peak hours of traffic. The following CMP intersections would operate at unacceptable levels of service (LOS F) under background conditions during at least one peak hour:

- (#30) De La Cruz Boulevard and Central Expressway \* (LOS F – AM and PM peak hours)
- (#36) Coleman Avenue and I-880 Southbound Ramps \* (LOS F – AM peak hour)
- (#37) Coleman Avenue and I-880 Northbound Ramps \* (LOS F – AM peak hour)
- (#41) San Tomas Expressway and El Camino Real \* (LOS F – AM and PM peak hours)

## Intersection Impacts and Proposed Mitigation Measures

### Alum Rock/28<sup>th</sup> Street Station

#### City of San Jose Impact Analysis

Based on the significant impact criteria of the City of San Jose, the Project would not result in any significant impacts to the intersections in the vicinity of the Alum Rock/28<sup>th</sup> Street Station under the 2025 Background Plus Project scenario.

#### CMP Impact Analysis

Based on the significant impact criteria of the Congestion Management Program, the Project would not result in any significant impacts to the CMP intersections in the vicinity of the Alum Rock/28<sup>th</sup> Street Station under the 2025 Background Plus Project scenario.

## Santa Clara Station

### City of San Jose Impact Analysis

When measured against the City of San Jose significant impact criteria, the Project would potentially cause a significant impact at the following two San Jose intersections near Santa Clara Station:

- (#36) Coleman Avenue and I-880 Southbound Ramps \*
- (#37) Coleman Avenue and I-880 Northbound Ramps \*

Mitigation measures for this intersection have been proposed as follows:

**Coleman Avenue and I-880 Southbound Ramps** \*: Convert the second (center) left-turn lane on the I-880 off-ramp (the intersection's westbound approach) to a shared left/right-turn lane. Replace the lane control signs and revise the pavement markings on the off-ramp to reflect the new lane usage.

This mitigation measure is presented in Figure 29. With implementation of this mitigation measure, the intersection would operate at LOS D under 2025 Background Plus Project Mitigated Conditions, and the impact would be mitigated to a *less-than-significant level*.

**Coleman Avenue and I-880 Northbound Ramps** \*: Currently, only right turns are permitted from McKendrie Street, which is the eastbound approach to this intersection. With the proposed mitigation, that right turn movement would still be permitted, but the signal controls would be modified so that all motorists would turn "right on red" and the pedestrian crosswalk across McKendrie would function in the same way that a crosswalk at a stop sign functions.

Convert the signal control for the eastbound approach (McKendrie Street) from a 3-section signal head to a single-section constant red beacon. Remove the pedestrian signals and push buttons on the eastbound leg (McKendrie Street). Reprogram the signal controller to eliminate the eastbound vehicle movement and existing pedestrian crossing.

Due to concerns expressed by City of San Jose staff, the proposed mitigation measure would cause additional impacts to other users of the roadway; therefore this mitigation measure will not be implemented, and VTA will work with the City of San Jose to provide other multi-modal access improvements in the area. The impact would remain *significant and unavoidable*.

State Congestion Management law requires a local jurisdiction to prepare a deficiency plan (now referred to as 'Multimodal Improvement Plan' in the Santa Clara County CMP maintained by VTA) when roadway level of service standards are not maintained on the designated CMP system [California Government Code Section 65098.4]. VTA maintains guidelines for the development of Multimodal Improvement Plans which were developed in consultation with Member Agencies (i.e., the 15 cities of Santa Clara County and the County of Santa Clara) and last adopted by the VTA Board in September 2010. According to these guidelines, Multimodal Improvement Plans are prepared by Member Agencies in response to the transportation impacts of land use plans and development projects. The impact to this intersection is a result of the TOJD component of the Project and not due to the BART extension; however, VTA's guidelines do not address a situation where a land use project that is led by VTA contributes to an impact on a CMP facility. With this in mind, VTA commits to work with the City of San Jose and Caltrans in the preparation of a Multimodal Improvement Plan for identified Project impacts to CMP intersections

### City of Santa Clara Impact Analysis

When measured against the City of Santa Clara significant impact criteria, the Project would potentially cause a significant impact at the following Santa Clara intersection near Santa Clara Station:

- (#33) Coleman Avenue and Brokaw Road

Mitigation measures for this intersection has been proposed as follows:

**Coleman Avenue and Brokaw Road:** Change the signal control for Brokaw Road (the east and west legs of this intersection) from Protected Left-Turn phasing to Split Phase. Add a shared through/left-turn lane to the east and west approaches within the existing right-of-way. Change the existing shared through/right-turn lanes to right-turn only lanes on the east and west approaches, and change the eastbound right-turn coding from Include to Overlap, indicating that many eastbound right turns would be able to turn “right on red.”

This mitigation measure is presented in Figure 30. With implementation of this mitigation measure, or a comparable mitigation measure as determined upon coordination with the City of Santa Clara, the intersection would operate at LOS D under 2025 Background Plus Project Mitigated Conditions; therefore, the impact would be mitigated to a *less-than-significant level*.

### **CMP Impact Analysis**

When measured against the CMP significant impact criteria, the Project would potentially cause a significant impact at the following two CMP intersections near Santa Clara Station:

- (#36) Coleman Avenue and I-880 Southbound Ramps \*
- (#37) Coleman Avenue and I-880 Northbound Ramps \*

The same mitigation strategy discussed above under the City of San Jose would also mitigate the impact at Coleman Avenue and I-880 Southbound Ramps to a *less-than-significant level* under CMP standards. The impact at Coleman Avenue and I-880 Northbound Ramps would be *significant and unavoidable*. As noted above, VTA will work with the City of San Jose to provide other multi-modal access improvements in the area.

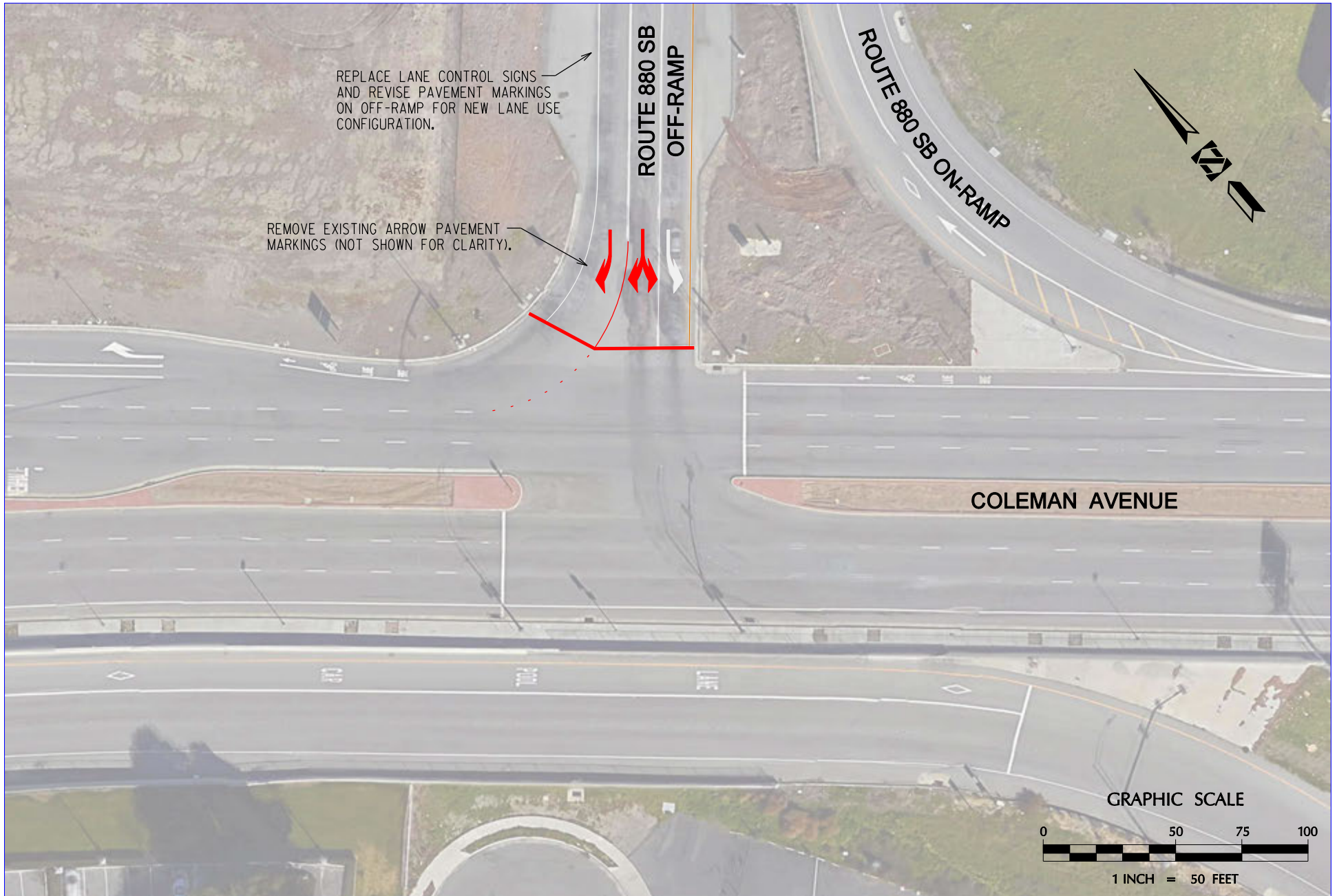

REPLACE LANE CONTROL SIGNS  
AND REVISE PAVEMENT MARKINGS  
ON OFF-RAMP FOR NEW LANE USE  
CONFIGURATION.

REMOVE EXISTING ARROW PAVEMENT  
MARKINGS (NOT SHOWN FOR CLARITY).

ROUTE 880 SB  
OFF-RAMP

ROUTE 880 SB ON-RAMP

COLEMAN AVENUE

GRAPHIC SCALE



1 INCH = 50 FEET



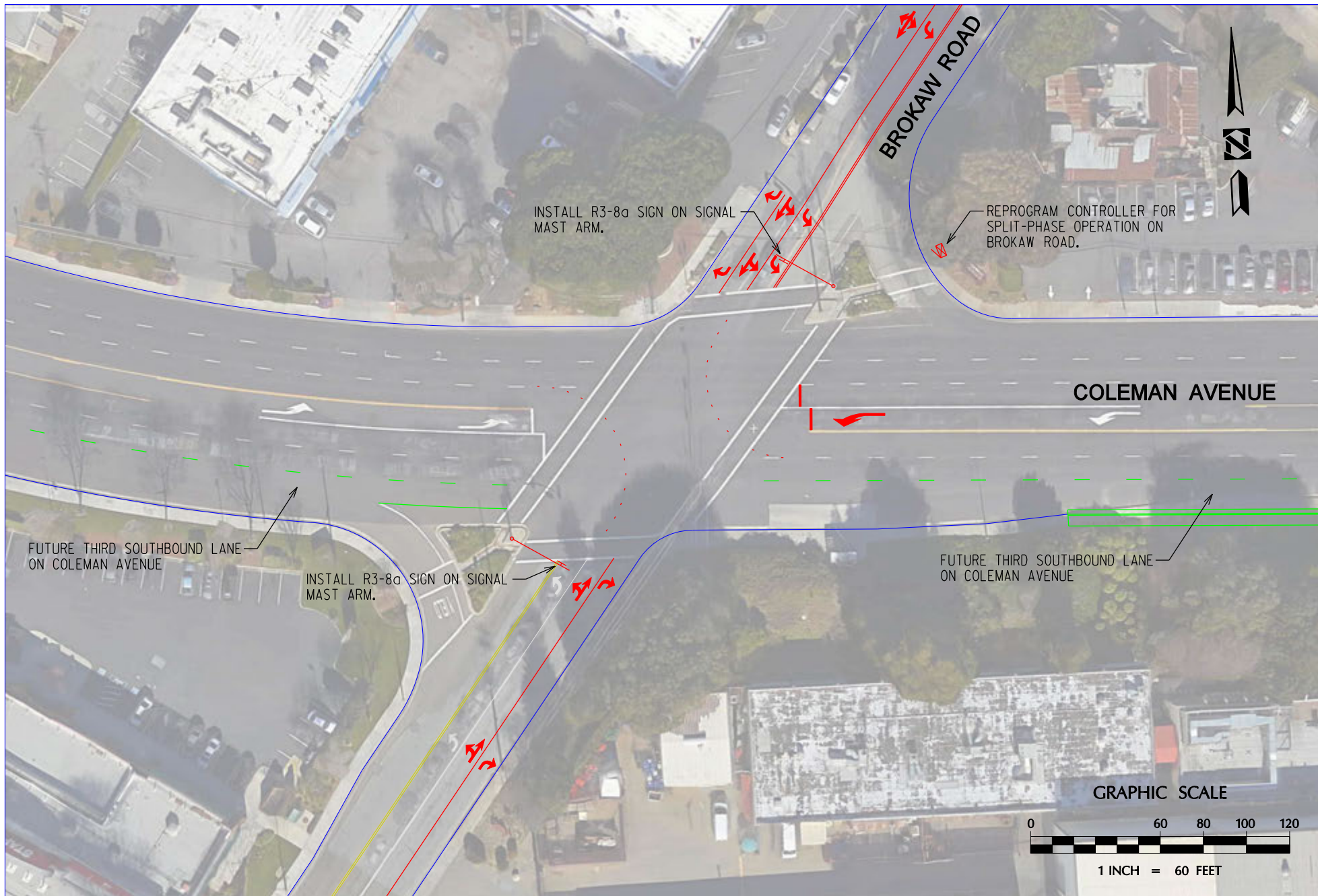

## Freeway Segment Level of Service Analysis

### 2015 Existing Plus Project Freeway Segment Analysis

Traffic volumes on the study freeway segments for the 2015 Existing Plus Project scenario were estimated by adding project trips to the Existing (Year 2015) freeway segment volumes obtained from the 2014 CMP Annual Monitoring Report. Table 16 presents the results of the freeway segment analysis for 2015 Existing Plus Project Conditions.

The results of this freeway segment analysis show that there are four freeway segments that were operating at LOS F under 2015 Existing Conditions which would continue to operate at LOS F under 2015 Existing Plus Project Conditions and on which the Project would cause significant increases in traffic volumes (one percent or more of freeway capacity). Based on the CMP definition of significant freeway impacts, the Project would therefore result in a significant impact on the following four segments under 2015 Existing Plus Project Conditions:

- US 101, Northbound, Tully Road to Story Road: AM peak hour for mixed-flow lanes
- US 101, Northbound, Story Road to I-280: AM peak hour for mixed-flow and HOV lanes
- US 101, Northbound, I-280 to Santa Clara Street: AM peak hour for mixed-flow and HOV lanes
- US 101, Northbound, Santa Clara Street to McKee Road: AM peak hour for mixed-flow lanes

These freeway segments are located in the vicinity of the Alum Rock/28<sup>th</sup> Street Station. Caltrans has no plans to widen these freeway segments beyond what is already assumed in the table (three mixed-flow lanes and one HOV lane), so no mitigation measures are feasible. The Project would result in an impact on these segments under 2015 Existing Plus Project Conditions that would be *significant and unavoidable*. However, under 2025 Background Plus Project Conditions and 2035 Cumulative Plus Project conditions, these segments would not be significantly impacted because by that time a sufficient mode shift from passenger cars to BART is expected to more than offset the station access trips and TOJD trips. Because the impact only occurs under 2015 Existing conditions and the BART Extension with TOJD would not be built until 2025, no mitigation is proposed.

### 2025 Background Plus Project Freeway Segment Analysis

Traffic volumes on the study freeway segments with the Project were estimated by adding project trips to the Year 2025 freeway segment volumes obtained from the VTA Travel Demand Forecasting Model.

The results of the freeway segment analysis show that the Project would not cause significant increases in traffic volumes (one percent or more of freeway capacity) on any of the study freeway segments under the 2025 Background Plus Project Conditions that were operating at LOS F under the 2025 Background Conditions, and none of the study freeway segments currently operating at LOS E or better under the 2025 Background Conditions would worsen to LOS F under 2025 Background Plus Project Conditions (see Table 17). In fact, many freeway segments would experience a decrease in volume because the reduced number of trips on the freeway (due to the mode shift from passenger vehicles to BART) more than offsets the trips that would be generated by the Transit-Oriented Joint Development component of the Project. Therefore, based on CMP freeway impact criteria, the Project would not cause a significant impact to any of the study freeway segments under the 2025 Background Plus Project Conditions.



**Table 16**  
**2015 Existing Plus Project Conditions Freeway Segment Levels of Service**

| Freeway | Segment                   | Direction | Peak Hour | 2015 Existing Plus Project |            |          |        |          |     |            |            |                 |        |         |     | Net Project Trips |           |              |               |             |           |              |               |
|---------|---------------------------|-----------|-----------|----------------------------|------------|----------|--------|----------|-----|------------|------------|-----------------|--------|---------|-----|-------------------|-----------|--------------|---------------|-------------|-----------|--------------|---------------|
|         |                           |           |           | Mixed-Flow Lane            |            |          |        | HOV Lane |     |            |            | Mixed-Flow Lane |        |         |     | HOV Lane          |           |              |               |             |           |              |               |
|         |                           |           |           | Avg. Speed                 | # of Lanes | Capacity | Volume | Density  | LOS | Avg. Speed | # of Lanes | Capacity        | Volume | Density | LOS | BART Volume       | JD Volume | Total Volume | % of Capacity | BART Volume | JD Volume | Total Volume | % of Capacity |
| US 101  | Tully to Story            | NB        | AM        | 25.0                       | 3.0        | 6,900    | 5,419  | 72       | F   | 15.0       | 1.0        | 1,650           | 1,425  | 95      | F   | 19                | 86        | 105          | 1.52          | -5          | 21        | 16           | 0.97          |
|         |                           |           | PM        | 66.0                       | 3.0        | 6,900    | 4,959  | 25       | C   | 70.0       | 1.0        | 1,650           | 910    | 13      | B   | 9                 | 23        | 32           | 0.46          | 0           | 6         | 6            | 0.36          |
| US 101  | Story to I-280            | NB        | AM        | 22.0                       | 3.0        | 6,900    | 5,277  | 80       | F   | 19.0       | 1.0        | 1,650           | 1,637  | 86      | F   | 57                | 82        | 139          | 2.01          | -3          | 21        | 18           | 1.09          |
|         |                           |           | PM        | 67.0                       | 3.0        | 6,900    | 3,018  | 15       | B   | 70.0       | 1.0        | 1,650           | 350    | 5       | A   | 18                | 23        | 41           | 0.59          | 0           | 6         | 6            | 0.36          |
| US 101  | I-280 to Santa Clara      | NB        | AM        | 13.0                       | 3.0        | 6,900    | 4,086  | 105      | F   | 13.0       | 1.0        | 1,650           | 1,324  | 102     | F   | 66                | 120       | 186          | 2.70          | -6          | 30        | 24           | 1.45          |
|         |                           |           | PM        | 66.0                       | 3.0        | 6,900    | 4,575  | 23       | C   | 70.0       | 1.0        | 1,650           | 700    | 10      | A   | 15                | 37        | 52           | 0.75          | 0           | 9         | 9            | 0.55          |
| US 101  | Santa Clara to McKee      | NB        | AM        | 11.0                       | 3.0        | 6,900    | 3,697  | 112      | F   | 16.0       | 1.0        | 1,650           | 1,465  | 92      | F   | -3                | 95        | 92           | 1.33          | -15         | 24        | 9            | 0.55          |
|         |                           |           | PM        | 66.0                       | 3.0        | 6,900    | 3,958  | 20       | C   | 70.0       | 1.0        | 1,650           | 1,047  | 15      | B   | -2                | 9         | 7            | 0.10          | -3          | 2         | -1           | -0.06         |
| US 101  | I-880 to Old Bayshore     | NB        | AM        | 14.0                       | 3.0        | 6,900    | 4,193  | 100      | F   | 19.0       | 1.0        | 1,650           | 1,591  | 84      | F   | -7                | 10        | 3            | 0.04          | -9          | 2         | -7           | -0.42         |
|         |                           |           | PM        | 67.0                       | 3.0        | 6,900    | 3,598  | 18       | B   | 70.0       | 1.0        | 1,650           | 417    | 6       | A   | -2                | 1         | -1           | -0.01         | -3          | 0         | -3           | -0.18         |
| US 101  | Old Bayshore to First     | NB        | AM        | 12.0                       | 3.0        | 6,900    | 3,921  | 109      | F   | 13.0       | 1.0        | 1,650           | 1,351  | 104     | F   | -9                | 24        | 15           | 0.22          | -9          | 6         | -3           | -0.18         |
|         |                           |           | PM        | 66.0                       | 3.0        | 6,900    | 3,954  | 20       | C   | 70.0       | 1.0        | 1,650           | 557    | 8       | A   | -6                | 29        | 23           | 0.33          | -3          | 7         | 4            | 0.24          |
| US 101  | First to SR 87            | NB        | AM        | 19.0                       | 3.0        | 6,900    | 4,837  | 85       | F   | 19.0       | 1.0        | 1,650           | 1,591  | 84      | F   | -13               | 32        | 19           | 0.28          | -9          | 8         | -1           | -0.06         |
|         |                           |           | PM        | 67.0                       | 3.0        | 6,900    | 3,392  | 17       | B   | 70.0       | 1.0        | 1,650           | 627    | 9       | A   | -8                | 26        | 18           | 0.26          | -3          | 7         | 4            | 0.24          |
| US 101  | SR 87 to De La Cruz       | NB        | AM        | 12.0                       | 3.0        | 6,900    | 3,842  | 107      | F   | 14.0       | 1.0        | 1,650           | 1,392  | 99      | F   | -18               | 6         | -12          | -0.17         | -8          | 1         | -7           | -0.42         |
|         |                           |           | PM        | 66.0                       | 3.0        | 6,900    | 4,147  | 21       | C   | 70.0       | 1.0        | 1,650           | 417    | 6       | A   | -13               | 22        | 9            | 0.13          | -3          | 5         | 2            | 0.12          |
| US 101  | De La Cruz to Montague    | NB        | AM        | 26.0                       | 3.0        | 6,900    | 5,448  | 70       | F   | 39.0       | 1.0        | 1,650           | 2,054  | 53      | E   | -12               | 10        | -2           | -0.03         | -16         | 3         | -13          | -0.79         |
|         |                           |           | PM        | 65.0                       | 3.0        | 6,900    | 6,042  | 31       | D   | 70.0       | 1.0        | 1,650           | 971    | 14      | B   | -8                | 42        | 34           | 0.49          | -9          | 10        | 1            | 0.06          |
| US 101  | Montague to Great America | NB        | AM        | 21.0                       | 3.0        | 6,900    | 5,099  | 81       | F   | 41.0       | 1.0        | 1,650           | 2,086  | 51      | E   | -11               | 9         | -2           | -0.03         | -14         | 2         | -12          | -0.73         |
|         |                           |           | PM        | 58.0                       | 3.0        | 6,900    | 6,618  | 38       | D   | 70.0       | 1.0        | 1,650           | 1,811  | 26      | C   | -2                | 42        | 40           | 0.58          | -9          | 10        | 1            | 0.06          |
| US 101  | Great America to Montague | SB        | AM        | 66.0                       | 3.0        | 6,900    | 4,941  | 25       | C   | 67.0       | 1.0        | 1,650           | 1,063  | 16      | B   | -9                | 66        | 57           | 0.83          | -17         | 16        | -1           | -0.06         |
|         |                           |           | PM        | 14.0                       | 3.0        | 6,900    | 4,153  | 99       | F   | 20.0       | 1.0        | 1,650           | 1,813  | 91      | F   | -7                | 14        | 7            | 0.10          | -7          | 4         | -3           | -0.18         |
| US 101  | Montague to De La Cruz    | SB        | AM        | 66.0                       | 3.0        | 6,900    | 5,295  | 27       | D   | 67.0       | 1.0        | 1,650           | 923    | 14      | B   | -15               | 74        | 59           | 0.86          | -17         | 19        | 2            | 0.12          |
|         |                           |           | PM        | 13.0                       | 3.0        | 6,900    | 4,052  | 104      | F   | 40.0       | 1.0        | 1,650           | 2,511  | 63      | F   | -8                | 17        | 9            | 0.13          | -9          | 4         | -5           | -0.30         |
| US 101  | De La Cruz to SR 87       | SB        | AM        | 62.0                       | 3.0        | 6,900    | 6,483  | 35       | D   | 67.0       | 1.0        | 1,650           | 599    | 9       | A   | -27               | 56        | 29           | 0.42          | -11         | 14        | 3            | 0.18          |
|         |                           |           | PM        | 18.0                       | 3.0        | 6,900    | 4,689  | 87       | F   | 50.0       | 1.0        | 1,650           | 2,392  | 48      | E   | -11               | 40        | 29           | 0.42          | -8          | 10        | 2            | 0.12          |
| US 101  | SR 87 to First            | SB        | AM        | 67.0                       | 3.0        | 6,900    | 2,589  | 13       | B   | 67.0       | 1.0        | 1,650           | 399    | 6       | A   | -11               | 56        | 45           | 0.65          | -11         | 14        | 3            | 0.18          |
|         |                           |           | PM        | 16.0                       | 3.0        | 6,900    | 4,511  | 94       | F   | 30.0       | 1.0        | 1,650           | 2,334  | 78      | F   | -9                | 34        | 25           | 0.36          | -6          | 9         | 3            | 0.18          |
| US 101  | First to Old Bayshore     | SB        | AM        | 67.0                       | 3.0        | 6,900    | 3,392  | 17       | B   | 67.0       | 1.0        | 1,650           | 399    | 6       | A   | -8                | 56        | 48           | 0.70          | -11         | 14        | 3            | 0.18          |
|         |                           |           | PM        | 6.0                        | 3.0        | 6,900    | 2,643  | 147      | F   | 20.0       | 1.0        | 1,650           | 1,815  | 91      | F   | -7                | 28        | 21           | 0.30          | -5          | 7         | 2            | 0.12          |
| US 101  | Old Bayshore to I-880     | SB        | AM        | 67.0                       | 3.0        | 6,900    | 2,389  | 12       | B   | 67.0       | 1.0        | 1,650           | 529    | 8       | A   | -11               | 65        | 54           | 0.78          | -11         | 16        | 5            | 0.30          |
|         |                           |           | PM        | 8.0                        | 3.0        | 6,900    | 3,021  | 126      | F   | 30.0       | 1.0        | 1,650           | 2,154  | 72      | F   | -9                | 35        | 26           | 0.38          | -6          | 9         | 3            | 0.18          |
| US 101  | McKee to Santa Clara      | SB        | AM        | 67.0                       | 3.0        | 6,900    | 2,808  | 14       | B   | 67.0       | 1.0        | 1,650           | 807    | 12      | B   | 8                 | 35        | 43           | 0.62          | -3          | 9         | 6            | 0.36          |
|         |                           |           | PM        | 62.0                       | 3.0        | 6,900    | 6,557  | 35       | D   | 70.0       | 1.0        | 1,650           | 1,393  | 20      | C   | 47                | 95        | 142          | 2.06          | -7          | 24        | 17           | 1.03          |
| US 101  | Santa Clara to I-280      | SB        | AM        | 67.0                       | 3.0        | 6,900    | 3,608  | 18       | B   | 67.0       | 1.0        | 1,650           | 267    | 4       | A   | 8                 | 55        | 63           | 0.91          | -3          | 14        | 11           | 0.67          |
|         |                           |           | PM        | 63.0                       | 3.0        | 6,900    | 6,539  | 35       | D   | 70.0       | 1.0        | 1,650           | 1,964  | 28      | D   | 109               | 149       | 257          | 3.72          | 4           | 37        | 41           | 2.48          |
| US 101  | I-280 to Story            | SB        | AM        | 67.0                       | 3.0        | 6,900    | 3,213  | 16       | B   | 67.0       | 1.0        | 1,650           | 467    | 7       | A   | 13                | 22        | 35           | 0.51          | -3          | 6         | 3            | 0.18          |
|         |                           |           | PM        | 54.0                       | 3.0        | 6,900    | 6,706  | 41       | D   | 70.0       | 1.0        | 1,650           | 1,477  | 21      | C   | 56                | 73        | 129          | 1.87          | 7           | 18        | 25           | 1.52          |
| US 101  | Story to Tully            | SB        | AM        | 66.0                       | 3.0        | 6,900    | 3,958  | 20       | C   | 67.0       | 1.0        | 1,650           | 467    | 7       | A   | -2                | 22        | 20           | 0.29          | -3          | 5         | 2            | 0.12          |
|         |                           |           | PM        | 45.0                       | 3.0        | 6,900    | 6,497  | 48       | E   | 70.0       | 1.0        | 1,650           | 1,824  | 26      | C   | 17                | 83        | 100          | 1.45          | 4           | 21        | 25           | 1.52          |

**Table 16, Continued**  
**2015 Existing Plus Project Conditions Freeway Segment Levels of Service**

| Freeway | Segment                       | Direction | Peak Hour | 2015 Existing Plus Project |            |          |        |         |          |            |            |          |        | Net Project Trips |     |             |           |              |               |             |           |              |               |
|---------|-------------------------------|-----------|-----------|----------------------------|------------|----------|--------|---------|----------|------------|------------|----------|--------|-------------------|-----|-------------|-----------|--------------|---------------|-------------|-----------|--------------|---------------|
|         |                               |           |           | Mixed-Flow Lane            |            |          |        |         | HOV Lane |            |            |          |        | Mixed-Flow Lane   |     |             |           | HOV Lane     |               |             |           |              |               |
|         |                               |           |           | Avg. Speed                 | # of Lanes | Capacity | Volume | Density | LOS      | Avg. Speed | # of Lanes | Capacity | Volume | Density           | LOS | BART Volume | JD Volume | Total Volume | % of Capacity | BART Volume | JD Volume | Total Volume | % of Capacity |
| I-280   | I-880 to Meridian             | EB        | AM        | 66.0                       | 3.0        | 6,900    | 5,135  | 26      | C        | 67.0       | 1.0        | 1,650    | 669    | 18                | B   | -15         | 18        | 3            | 0.04          | -1          | 4         | 3            | 0.18          |
|         |                               |           | PM        | 17.0                       | 3.0        | 6,900    | 4,579  | 90      | F        | 20.0       | 1.0        | 1,650    | 1,739  | 30                | F   | -11         | 12        | 1            | 0.01          | -1          | 3         | 2            | 0.12          |
| I-280   | Meridian to Bird              | EB        | AM        | 61.0                       | 4.0        | 9,200    | 8,785  | 36      | D        | ---        | ---        | ---      | ---    | ---               | --- | -5          | 40        | 35           | 0.38          | ---         | ---       | ---          | ---           |
|         |                               |           | PM        | 21.0                       | 4.0        | 9,200    | 6,795  | 81      | F        | ---        | ---        | ---      | ---    | ---               | --- | -15         | 17        | 2            | 0.02          | ---         | ---       | ---          | ---           |
| I-280   | Bird to SR 87                 | EB        | AM        | 66.0                       | 4.0        | 9,200    | 5,275  | 20      | C        | ---        | ---        | ---      | ---    | ---               | --- | -5          | 22        | 17           | 0.18          | ---         | ---       | ---          | ---           |
|         |                               |           | PM        | 25.0                       | 4.0        | 9,200    | 7,188  | 72      | F        | ---        | ---        | ---      | ---    | ---               | --- | -12         | 14        | 2            | 0.02          | ---         | ---       | ---          | ---           |
| I-280   | SR 87 to 10th                 | EB        | AM        | 67.0                       | 4.0        | 9,200    | 4,520  | 17      | B        | ---        | ---        | ---      | ---    | ---               | --- | -10         | 30        | 20           | 0.22          | ---         | ---       | ---          | ---           |
|         |                               |           | PM        | 27.0                       | 4.0        | 9,200    | 7,439  | 69      | F        | ---        | ---        | ---      | ---    | ---               | --- | -21         | 29        | 8            | 0.09          | ---         | ---       | ---          | ---           |
| I-280   | 10th to McLaughlin            | EB        | AM        | 66.0                       | 4.0        | 9,200    | 4,978  | 19      | C        | ---        | ---        | ---      | ---    | ---               | --- | -42         | 23        | -19          | -0.21         | ---         | ---       | ---          | ---           |
|         |                               |           | PM        | 54.0                       | 4.0        | 9,200    | 8,804  | 41      | D        | ---        | ---        | ---      | ---    | ---               | --- | -56         | 24        | -32          | -0.35         | ---         | ---       | ---          | ---           |
| I-280   | McLaughlin to US 101          | EB        | AM        | 66.0                       | 4.0        | 9,200    | 5,758  | 22      | C        | ---        | ---        | ---      | ---    | ---               | --- | -52         | 8         | -44          | -0.48         | ---         | ---       | ---          | ---           |
|         |                               |           | PM        | 54.0                       | 4.0        | 9,200    | 8,809  | 41      | D        | ---        | ---        | ---      | ---    | ---               | --- | -51         | 9         | -42          | -0.46         | ---         | ---       | ---          | ---           |
| I-680   | US 101 to King                | NB        | AM        | 33.0                       | 4.0        | 9,200    | 7,866  | 60      | F        | ---        | ---        | ---      | ---    | ---               | --- | -54         | 6         | -48          | -0.52         | ---         | ---       | ---          | ---           |
|         |                               |           | PM        | 66.0                       | 4.0        | 9,200    | 7,030  | 27      | D        | ---        | ---        | ---      | ---    | ---               | --- | -50         | 6         | -44          | -0.48         | ---         | ---       | ---          | ---           |
| I-680   | King to Capitol               | NB        | AM        | 20.0                       | 4.0        | 9,200    | 6,450  | 81      | F        | ---        | ---        | ---      | ---    | ---               | --- | -110        | 4         | -106         | -1.15         | ---         | ---       | ---          | ---           |
|         |                               |           | PM        | 47.0                       | 4.0        | 9,200    | 8,592  | 46      | D        | ---        | ---        | ---      | ---    | ---               | --- | -58         | 13        | -45          | -0.49         | ---         | ---       | ---          | ---           |
| I-680   | Capitol to Alum Rock          | NB        | AM        | 18.0                       | 4.0        | 9,200    | 6,133  | 85      | F        | ---        | ---        | ---      | ---    | ---               | --- | -137        | 6         | -131         | -1.42         | ---         | ---       | ---          | ---           |
|         |                               |           | PM        | 65.0                       | 4.0        | 9,200    | 7,726  | 30      | D        | ---        | ---        | ---      | ---    | ---               | --- | -74         | 0         | -74          | -0.80         | ---         | ---       | ---          | ---           |
| I-680   | Alum Rock to McKee            | NB        | AM        | 27.0                       | 4.0        | 9,200    | 7,190  | 67      | F        | ---        | ---        | ---      | ---    | ---               | --- | -160        | 6         | -154         | -1.67         | ---         | ---       | ---          | ---           |
|         |                               |           | PM        | 66.0                       | 4.0        | 9,200    | 5,730  | 22      | C        | ---        | ---        | ---      | ---    | ---               | --- | -80         | 13        | -67          | -0.73         | ---         | ---       | ---          | ---           |
| I-680   | McKee to Alum Rock            | SB        | AM        | 63.0                       | 4.0        | 9,200    | 8,477  | 34      | D        | ---        | ---        | ---      | ---    | ---               | --- | -93         | 13        | -80          | -0.87         | ---         | ---       | ---          | ---           |
|         |                               |           | PM        | 47.0                       | 4.0        | 9,200    | 8,492  | 45      | D        | ---        | ---        | ---      | ---    | ---               | --- | -158        | 0         | -158         | -1.72         | ---         | ---       | ---          | ---           |
| I-680   | Alum Rock to Capitol          | SB        | AM        | 23.0                       | 4.0        | 9,200    | 7,016  | 76      | F        | ---        | ---        | ---      | ---    | ---               | --- | -74         | 10        | -64          | -0.70         | ---         | ---       | ---          | ---           |
|         |                               |           | PM        | 65.0                       | 4.0        | 9,200    | 7,431  | 29      | D        | ---        | ---        | ---      | ---    | ---               | --- | -109        | 0         | -109         | -1.18         | ---         | ---       | ---          | ---           |
| I-680   | Capitol to King               | SB        | AM        | 21.0                       | 4.0        | 9,200    | 7,415  | 89      | F        | ---        | ---        | ---      | ---    | ---               | --- | -75         | 31        | -44          | -0.48         | ---         | ---       | ---          | ---           |
|         |                               |           | PM        | 66.0                       | 4.0        | 9,200    | 7,680  | 30      | D        | ---        | ---        | ---      | ---    | ---               | --- | -110        | 2         | -108         | -1.17         | ---         | ---       | ---          | ---           |
| I-680   | King to US 101                | SB        | AM        | 12.0                       | 4.0        | 9,200    | 5,077  | 106     | F        | ---        | ---        | ---      | ---    | ---               | --- | -63         | 5         | -58          | -0.63         | ---         | ---       | ---          | ---           |
|         |                               |           | PM        | 66.0                       | 4.0        | 9,200    | 5,500  | 21      | C        | ---        | ---        | ---      | ---    | ---               | --- | -50         | 0         | -50          | -0.54         | ---         | ---       | ---          | ---           |
| I-280   | US 101 to McLaughlin          | WB        | AM        | 14.0                       | 4.0        | 9,200    | 5,597  | 100     | F        | ---        | ---        | ---      | ---    | ---               | --- | -63         | 5         | -58          | -0.63         | ---         | ---       | ---          | ---           |
|         |                               |           | PM        | 66.0                       | 4.0        | 9,200    | 6,290  | 24      | C        | ---        | ---        | ---      | ---    | ---               | --- | -50         | 0         | -50          | -0.54         | ---         | ---       | ---          | ---           |
| I-280   | McLaughlin to 10th            | WB        | AM        | 19.0                       | 4.0        | 9,200    | 6,315  | 83      | F        | ---        | ---        | ---      | ---    | ---               | --- | -75         | 34        | -41          | -0.45         | ---         | ---       | ---          | ---           |
|         |                               |           | PM        | 65.0                       | 4.0        | 9,200    | 7,530  | 29      | D        | ---        | ---        | ---      | ---    | ---               | --- | -10         | 90        | 80           | 0.87          | ---         | ---       | ---          | ---           |
| I-280   | 10th to SR 87                 | WB        | AM        | 21.0                       | 4.0        | 9,200    | 6,669  | 79      | F        | ---        | ---        | ---      | ---    | ---               | --- | -51         | 32        | -19          | -0.21         | ---         | ---       | ---          | ---           |
|         |                               |           | PM        | 65.0                       | 4.0        | 9,200    | 7,782  | 30      | D        | ---        | ---        | ---      | ---    | ---               | --- | -18         | 75        | 57           | 0.62          | ---         | ---       | ---          | ---           |
| I-280   | SR 87 to Bird                 | WB        | AM        | 20.0                       | 4.0        | 9,200    | 6,621  | 83      | F        | ---        | ---        | ---      | ---    | ---               | --- | -19         | 15        | -4           | -0.04         | ---         | ---       | ---          | ---           |
|         |                               |           | PM        | 62.0                       | 4.0        | 9,200    | 8,670  | 35      | D        | ---        | ---        | ---      | ---    | ---               | --- | -10         | 59        | 49           | 0.53          | ---         | ---       | ---          | ---           |
| I-280   | Bird to Meridian              | WB        | AM        | 18.0                       | 4.0        | 9,200    | 6,391  | 89      | F        | ---        | ---        | ---      | ---    | ---               | --- | -19         | 16        | -3           | -0.03         | ---         | ---       | ---          | ---           |
|         |                               |           | PM        | 58.0                       | 4.0        | 9,200    | 8,820  | 38      | D        | ---        | ---        | ---      | ---    | ---               | --- | 0           | 60        | 60           | 0.65          | ---         | ---       | ---          | ---           |
| I-280   | Meridian to I-880             | WB        | AM        | 14.0                       | 3.0        | 6,900    | 4,748  | 100     | F        | 26.0       | 1.0        | 1,650    | 1,816  | 70                | F   | -12         | 10        | -2           | -0.03         | -4          | 3         | -1           | -0.06         |
|         |                               |           | PM        | 66.0                       | 3.0        | 6,900    | 4,710  | 21      | C        | 70.0       | 1.0        | 1,650    | 1,331  | 19                | C   | -10         | 32        | 22           | 0.32          | 1           | 8         | 9            | 0.55          |
| SR 87   | Curtner to Almaden Expressway | NB        | AM        | 13.0                       | 2.0        | 4,400    | 2,657  | 102     | F        | 22.0       | 1.0        | 1,650    | 1,719  | 78                | F   | -3          | 26        | 23           | 0.52          | -1          | 7         | 6            | 0.36          |
|         |                               |           | PM        | 65.0                       | 2.0        | 4,400    | 3,902  | 30      | D        | 70.0       | 1.0        | 1,650    | 1,190  | 17                | B   | 2           | 4         | 6            | 0.14          | 0           | 1         | 1            | 0.06          |
| SR 87   | Almaden Expressway to Alma    | NB        | AM        | 29.0                       | 2.0        | 4,400    | 3,767  | 65      | F        | 43.0       | 1.0        | 1,650    | 2,109  | 49                | E   | -3          | 30        | 27           | 0.61          | -1          | 8         | 7            | 0.42          |
|         |                               |           | PM        | 41.0                       | 2.0        | 4,400    | 4,193  | 51      | E        | 70.0       | 1.0        | 1,650    | 1,540  | 22                | C   | 3           | 6         | 9            | 0.20          | 0           | 2         | 2            | 0.12          |
| SR 87   | Alma to I-280                 | NB        | AM        | 33.0                       | 2.0        | 4,400    | 3,957  | 60      | F        | 61.0       | 1.0        | 1,650    | 2,198  | 36                | D   | -3          | 30        | 27           | 0.61          | -2          | 8         | 6            | 0.36          |
|         |                               |           | PM        | 66.0                       | 2.0        | 4,400    | 3,443  | 26      | C        | 70.0       | 1.0        | 1,650    | 420    | 6                 | A   | 3           | 6         | 9            | 0.20          | 0           | 2         | 2            | 0.12          |
| SR 87   | I-280 to Julian               | NB        | AM        | 16.0                       | 2.0        | 4,400    | 2,976  | 93      | F        | 30.0       | 1.0        | 1,650    | 1,913  | 64                | F   | -4          | 9         | 5            | 0.11          | -7          | 2         | -5           | -0.30         |
|         |                               |           | PM        | 67.0                       | 2.0        | 4,400    | 2,397  | 18      | B        | 70.0       | 1.0        | 1,650    | 628    | 9                 | A   | -3          | 0         | -3           | -0.07         | -2          | 0         | -2           | -0.12         |
| SR 87   | Julian to Coleman             | NB        | AM        | 14.0                       | 2.0        | 4,400    | 2,786  | 100     | F        | 32.0       | 1.0        | 1,650    | 1,942  | 61                | F   | -14         | 34        | 20           | 0.45          | -18         | 8         | -10          | -0.61         |
|         |                               |           | PM        | 67.0                       | 2.0        | 4,400    | 2,097  | 16      | B        | 70.0       | 1.0        | 1,650    | 466    | 7                 | A   | -33         | 6         | -27          | -0.61         | -24         | 2         | -22          | -1.33         |

**Table 16, Continued**  
**2015 Existing Plus Project Conditions Freeway Segment Levels of Service**

| Freeway | Segment                       | Direction | Peak Hour | 2015 Existing Plus Project |            |          |        |            |     |            |            |          |        |         |     | Net Project Trips |           |              |               |             |           |              |               |
|---------|-------------------------------|-----------|-----------|----------------------------|------------|----------|--------|------------|-----|------------|------------|----------|--------|---------|-----|-------------------|-----------|--------------|---------------|-------------|-----------|--------------|---------------|
|         |                               |           |           | Mixed-Flow Lane            |            |          |        |            |     | HOV Lane   |            |          |        |         |     | Mixed-Flow Lane   |           |              |               | HOV Lane    |           |              |               |
|         |                               |           |           | Avg. Speed                 | # of Lanes | Capacity | Volume | Density    | LOS | Avg. Speed | # of Lanes | Capacity | Volume | Density | LOS | BART Volume       | JD Volume | Total Volume | % of Capacity | BART Volume | JD Volume | Total Volume | % of Capacity |
| SR 87   | Coleman to Julian             | SB        | AM        | 66.0                       | 2.0        | 4,400    | 3,514  | 27         | D   | 67.0       | 1.0        | 1,650    | 654    | 10      | A   | -26               | 1         | -25          | -0.57         | -16         | 0         | -16          | -0.97         |
|         |                               |           | PM        | 32.0                       | 2.0        | 4,400    | 3,901  | <b>61</b>  | F   | 50.0       | 1.0        | 1,650    | 2,189  | 44      | D   | -9                | 16        | 7            | 0.16          | -11         | 4         | -7           | -0.42         |
| SR 87   | Julian to I-280               | SB        | AM        | 67.0                       | 2.0        | 4,400    | 1,863  | 14         | B   | 67.0       | 1.0        | 1,650    | 403    | 6       | A   | -7                | 6         | -1           | -0.02         | -7          | 2         | -5           | -0.30         |
|         |                               |           | PM        | 36.0                       | 2.0        | 4,400    | 4,035  | 56         | E   | 70.0       | 1.0        | 1,650    | 2,022  | 29      | D   | -5                | 22        | 17           | 0.39          | -8          | 6         | -2           | -0.12         |
| SR 87   | I-280 to Alma                 | SB        | AM        | 67.0                       | 2.0        | 4,400    | 1,877  | 14         | B   | 67.0       | 1.0        | 1,650    | 207    | 3       | A   | 7                 | 6         | 13           | 0.30          | -3          | 1         | -2           | -0.12         |
|         |                               |           | PM        | 15.0                       | 2.0        | 4,400    | 3,899  | <b>95</b>  | F   | 60.0       | 1.0        | 1,650    | 1,194  | 41      | D   | -1                | 14        | 13           | 0.30          | 4           | 3         | 7            | 0.42          |
| SR 87   | Alma to Almaden Expressway    | SB        | AM        | 66.0                       | 2.0        | 4,400    | 2,915  | 22         | C   | 67.0       | 1.0        | 1,650    | 606    | 9       | A   | 5                 | 7         | 12           | 0.27          | -4          | 2         | -2           | -0.12         |
|         |                               |           | PM        | 27.0                       | 2.0        | 4,400    | 3,037  | <b>69</b>  | F   | 60.0       | 1.0        | 1,650    | 844    | 38      | D   | -3                | 19        | 16           | 0.36          | 4           | 5         | 9            | 0.55          |
| SR 87   | Almaden Expressway to Curtner | SB        | AM        | 66.0                       | 2.0        | 4,400    | 2,643  | 20         | C   | 67.0       | 1.0        | 1,650    | 407    | 6       | A   | 3                 | 6         | 9            | 0.20          | -3          | 1         | -2           | -0.12         |
|         |                               |           | PM        | 36.0                       | 2.0        | 4,400    | 4,040  | 56         | E   | 70.0       | 1.0        | 1,650    | 1,965  | 28      | D   | 0                 | 17        | 17           | 0.39          | 5           | 4         | 9            | 0.55          |
| I-880   | I-280 to Stevens Creek        | NB        | AM        | 15.0                       | 3.0        | 6,900    | 4,364  | <b>97</b>  | F   | ---        | ---        | ---      | ---    | ---     | --- | -6                | 59        | 53           | 0.77          | ---         | ---       | ---          | ---           |
|         |                               |           | PM        | 66.0                       | 3.0        | 6,900    | 4,152  | 21         | C   | ---        | ---        | ---      | ---    | ---     | --- | -8                | 15        | 7            | 0.10          | ---         | ---       | ---          | ---           |
| I-880   | Stevens Creek to Bascom       | NB        | AM        | 20.0                       | 3.0        | 6,900    | 4,907  | <b>82</b>  | F   | ---        | ---        | ---      | ---    | ---     | --- | -13               | 71        | 58           | 0.84          | ---         | ---       | ---          | ---           |
|         |                               |           | PM        | 16.0                       | 3.0        | 6,900    | 4,408  | <b>92</b>  | F   | ---        | ---        | ---      | ---    | ---     | --- | -12               | 17        | 5            | 0.07          | ---         | ---       | ---          | ---           |
| I-880   | Bascom to The Alameda         | NB        | AM        | 27.0                       | 3.0        | 6,900    | 5,571  | <b>69</b>  | F   | ---        | ---        | ---      | ---    | ---     | --- | -19               | 57        | 38           | 0.55          | ---         | ---       | ---          | ---           |
|         |                               |           | PM        | 13.0                       | 3.0        | 6,900    | 4,045  | <b>104</b> | F   | ---        | ---        | ---      | ---    | ---     | --- | -15               | 22        | 7            | 0.10          | ---         | ---       | ---          | ---           |
| I-880   | The Alameda to Coleman        | NB        | AM        | 31.0                       | 3.0        | 6,900    | 5,816  | <b>63</b>  | F   | ---        | ---        | ---      | ---    | ---     | --- | -44               | 45        | 1            | 0.01          | ---         | ---       | ---          | ---           |
|         |                               |           | PM        | 15.0                       | 3.0        | 6,900    | 4,287  | <b>95</b>  | F   | ---        | ---        | ---      | ---    | ---     | --- | -33               | 29        | -4           | -0.06         | ---         | ---       | ---          | ---           |
| I-880   | Coleman to SR 87              | NB        | AM        | 22.0                       | 3.0        | 6,900    | 5,105  | <b>77</b>  | F   | ---        | ---        | ---      | ---    | ---     | --- | -45               | 40        | -5           | -0.07         | ---         | ---       | ---          | ---           |
|         |                               |           | PM        | 24.0                       | 3.0        | 6,900    | 5,289  | <b>73</b>  | F   | ---        | ---        | ---      | ---    | ---     | --- | -41               | 38        | -3           | -0.04         | ---         | ---       | ---          | ---           |
| I-880   | SR 87 to First                | NB        | AM        | 48.0                       | 3.0        | 6,900    | 6,435  | 45         | D   | ---        | ---        | ---      | ---    | ---     | --- | -45               | 40        | -5           | -0.07         | ---         | ---       | ---          | ---           |
|         |                               |           | PM        | 22.0                       | 3.0        | 6,900    | 5,179  | <b>78</b>  | F   | ---        | ---        | ---      | ---    | ---     | --- | -41               | 38        | -3           | -0.04         | ---         | ---       | ---          | ---           |
| I-880   | First to US 101               | NB        | AM        | 36.0                       | 3.0        | 6,900    | 6,106  | 57         | E   | ---        | ---        | ---      | ---    | ---     | --- | -54               | 37        | -17          | -0.25         | ---         | ---       | ---          | ---           |
|         |                               |           | PM        | 51.0                       | 3.0        | 6,900    | 6,519  | 43         | D   | ---        | ---        | ---      | ---    | ---     | --- | -61               | 30        | -31          | -0.45         | ---         | ---       | ---          | ---           |
| I-880   | US 101 to First               | SB        | AM        | 16.0                       | 3.0        | 6,900    | 4,405  | <b>92</b>  | F   | ---        | ---        | ---      | ---    | ---     | --- | -65               | 56        | -9           | -0.13         | ---         | ---       | ---          | ---           |
|         |                               |           | PM        | 14.0                       | 3.0        | 6,900    | 4,171  | <b>99</b>  | F   | ---        | ---        | ---      | ---    | ---     | --- | -79               | 26        | -53          | -0.77         | ---         | ---       | ---          | ---           |
| I-880   | First to SR 87                | SB        | AM        | 25.0                       | 3.0        | 6,900    | 5,439  | <b>73</b>  | F   | ---        | ---        | ---      | ---    | ---     | --- | -41               | 61        | 20           | 0.29          | ---         | ---       | ---          | ---           |
|         |                               |           | PM        | 14.0                       | 3.0        | 6,900    | 4,096  | <b>98</b>  | F   | ---        | ---        | ---      | ---    | ---     | --- | -64               | 33        | -31          | -0.45         | ---         | ---       | ---          | ---           |
| I-880   | SR 87 to Coleman              | SB        | AM        | 65.0                       | 3.0        | 6,900    | 5,809  | 30         | D   | ---        | ---        | ---      | ---    | ---     | --- | -41               | 61        | 20           | 0.29          | ---         | ---       | ---          | ---           |
|         |                               |           | PM        | 23.0                       | 3.0        | 6,900    | 5,186  | <b>75</b>  | F   | ---        | ---        | ---      | ---    | ---     | --- | -64               | 33        | -31          | -0.45         | ---         | ---       | ---          | ---           |
| I-880   | Coleman to The Alameda        | SB        | AM        | 66.0                       | 3.0        | 6,900    | 5,261  | 27         | D   | ---        | ---        | ---      | ---    | ---     | --- | -49               | 38        | -11          | -0.16         | ---         | ---       | ---          | ---           |
|         |                               |           | PM        | 23.0                       | 3.0        | 6,900    | 5,219  | <b>76</b>  | F   | ---        | ---        | ---      | ---    | ---     | --- | -31               | 33        | 2            | 0.03          | ---         | ---       | ---          | ---           |
| I-880   | The Alameda to Bascom         | SB        | AM        | 66.0                       | 3.0        | 6,900    | 4,927  | 25         | C   | ---        | ---        | ---      | ---    | ---     | --- | -23               | 18        | -5           | -0.07         | ---         | ---       | ---          | ---           |
|         |                               |           | PM        | 25.0                       | 3.0        | 6,900    | 5,459  | <b>73</b>  | F   | ---        | ---        | ---      | ---    | ---     | --- | -21               | 20        | -1           | -0.01         | ---         | ---       | ---          | ---           |
| I-880   | Bascom to Stevens Creek       | SB        | AM        | 50.0                       | 3.0        | 6,900    | 6,583  | 44         | D   | ---        | ---        | ---      | ---    | ---     | --- | -17               | 17        | 0            | 0.00          | ---         | ---       | ---          | ---           |
|         |                               |           | PM        | 30.0                       | 3.0        | 6,900    | 5,745  | <b>64</b>  | F   | ---        | ---        | ---      | ---    | ---     | --- | -15               | 58        | 43           | 0.62          | ---         | ---       | ---          | ---           |
| I-880   | Stevens Creek to I-280        | SB        | AM        | 66.0                       | 3.0        | 6,900    | 3,946  | 20         | C   | ---        | ---        | ---      | ---    | ---     | --- | -14               | 14        | 0            | 0.00          | ---         | ---       | ---          | ---           |
|         |                               |           | PM        | 65.0                       | 3.0        | 6,900    | 5,841  | 30         | D   | ---        | ---        | ---      | ---    | ---     | --- | -9                | 48        | 39           | 0.57          | ---         | ---       | ---          | ---           |

Source: Santa Clara Valley Transportation Authority Congestion Management Program Monitoring Study, 2014.  
**Bold** indicates unacceptable LOS.  
**Boxed** indicates significant impact.

**Table 17**  
**2025 Background Plus Project Conditions Freeway Segment Levels of Service**

| Freeway Segment |                           | 2025 Phase II Project Conditions |           |            |            |                  |                |                    |     |            |            |                  |                | Net Project Trips |     |             |           |                    |               |             |           |              |               |
|-----------------|---------------------------|----------------------------------|-----------|------------|------------|------------------|----------------|--------------------|-----|------------|------------|------------------|----------------|-------------------|-----|-------------|-----------|--------------------|---------------|-------------|-----------|--------------|---------------|
|                 |                           | Mixed-Flow Lane                  |           |            |            |                  |                | HOV / Express Lane |     |            |            |                  |                | Mixed-Flow Lane   |     |             |           | HOV / Express Lane |               |             |           |              |               |
|                 |                           | Direction                        | Peak Hour | Avg. Speed | # of Lanes | Project Capacity | Project Volume | Density            | LOS | Avg. Speed | # of Lanes | Project Capacity | Project Volume | Density           | LOS | BART Volume | JD Volume | Total Volume       | % of Capacity | BART Volume | JD Volume | Total Volume | % of Capacity |
| US 101          | Tully to Story            | NB                               | AM        | 25.0       | 3.0        | 6,900            | 8,759          | 117                | F   | 15.0       | 1.0        | 1,650            | 1,993          | 133               | F   | -100        | 77        | -23                | -0.33         | -52         | 14        | -38          | -2.30         |
|                 |                           |                                  | PM        | 66.0       | 3.0        | 6,900            | 7,568          | 38                 | D   | 70.0       | 1.0        | 1,650            | 1,163          | 17                | B   | -22         | 21        | -1                 | -0.01         | -21         | 4         | -17          | -1.03         |
| US 101          | Story to I-280            | NB                               | AM        | 22.0       | 3.0        | 6,900            | 5,147          | 78                 | F   | 19.0       | 1.0        | 1,650            | 1,497          | 79                | F   | -28         | 77        | 49                 | 0.71          | -45         | 14        | -31          | -1.88         |
|                 |                           |                                  | PM        | 67.0       | 3.0        | 6,900            | 3,763          | 19                 | C   | 70.0       | 1.0        | 1,650            | 752            | 11                | A   | -11         | 23        | 12                 | 0.17          | -8          | 4         | -4           | -0.24         |
| US 101          | I-280 to Santa Clara      | NB                               | AM        | 13.0       | 3.0        | 6,900            | 7,650          | 196                | F   | 13.0       | 1.0        | 1,650            | 1,730          | 133               | F   | -70         | 106       | 36                 | 0.52          | -50         | 19        | -31          | -1.88         |
|                 |                           |                                  | PM        | 66.0       | 3.0        | 6,900            | 5,436          | 27                 | D   | 70.0       | 1.0        | 1,650            | 805            | 12                | B   | -27         | 35        | 8                  | 0.12          | -9          | 6         | -3           | -0.18         |
| US 101          | Santa Clara to McKee      | NB                               | AM        | 11.0       | 3.0        | 6,900            | 7,824          | 237                | F   | 16.0       | 1.0        | 1,650            | 1,493          | 93                | F   | -156        | 59        | -97                | -1.41         | -44         | 10        | -34          | -2.06         |
|                 |                           |                                  | PM        | 66.0       | 3.0        | 6,900            | 5,291          | 27                 | D   | 70.0       | 1.0        | 1,650            | 711            | 10                | A   | -58         | 9         | -49                | -0.71         | -9          | 1         | -8           | -0.48         |
| US 101          | I-880 to Old Bayshore     | NB                               | AM        | 14.0       | 3.0        | 6,900            | 5,870          | 140                | F   | 19.0       | 1.0        | 1,650            | 1,742          | 92                | F   | -45         | 15        | -30                | -0.43         | -55         | 3         | -52          | -3.15         |
|                 |                           |                                  | PM        | 67.0       | 3.0        | 6,900            | 3,738          | 19                 | C   | 70.0       | 1.0        | 1,650            | 621            | 9                 | A   | -11         | 2         | -9                 | -0.13         | -6          | 0         | -6           | -0.36         |
| US 101          | Old Bayshore to First     | NB                               | AM        | 12.0       | 3.0        | 6,900            | 6,224          | 173                | F   | 13.0       | 1.0        | 1,650            | 1,666          | 128               | F   | -55         | 24        | -31                | -0.45         | -53         | 4         | -49          | -2.97         |
|                 |                           |                                  | PM        | 66.0       | 3.0        | 6,900            | 4,237          | 21                 | C   | 70.0       | 1.0        | 1,650            | 631            | 9                 | A   | -16         | 27        | 11                 | 0.16          | -6          | 5         | -1           | -0.06         |
| US 101          | First to SR 87            | NB                               | AM        | 19.0       | 3.0        | 6,900            | 6,784          | 119                | F   | 19.0       | 1.0        | 1,650            | 1,530          | 81                | F   | -72         | 32        | -40                | -0.58         | -49         | 6         | -43          | -2.61         |
|                 |                           |                                  | PM        | 67.0       | 3.0        | 6,900            | 5,186          | 26                 | C   | 70.0       | 1.0        | 1,650            | 739            | 11                | A   | -23         | 31        | 8                  | 0.12          | -10         | 5         | -5           | -0.30         |
| US 101          | SR 87 to De La Cruz       | NB                               | AM        | 12.0       | 3.0        | 6,900            | 6,597          | 183                | F   | 14.0       | 1.0        | 1,650            | 1,438          | 103               | F   | -70         | 9         | -61                | -0.88         | -45         | 1         | -44          | -2.67         |
|                 |                           |                                  | PM        | 66.0       | 3.0        | 6,900            | 5,418          | 27                 | D   | 70.0       | 1.0        | 1,650            | 738            | 11                | A   | -31         | 22        | -9                 | -0.13         | -10         | 4         | -6           | -0.36         |
| US 101          | De La Cruz to Montague    | NB                               | AM        | 26.0       | 3.0        | 6,900            | 6,303          | 81                 | F   | 39.0       | 1.0        | 1,650            | 1,966          | 50                | E   | -57         | 11        | -46                | -0.67         | -62         | 2         | -60          | -3.64         |
|                 |                           |                                  | PM        | 65.0       | 3.0        | 6,900            | 5,488          | 28                 | D   | 70.0       | 1.0        | 1,650            | 1,183          | 17                | B   | -24         | 31        | 7                  | 0.10          | -23         | 5         | -18          | -1.09         |
| US 101          | Montague to Great America | NB                               | AM        | 21.0       | 3.0        | 6,900            | 6,673          | 106                | F   | 41.0       | 1.0        | 1,650            | 1,641          | 40                | D   | -56         | 7         | -49                | -0.71         | -55         | 1         | -54          | -3.27         |
|                 |                           |                                  | PM        | 58.0       | 3.0        | 6,900            | 5,835          | 34                 | D   | 70.0       | 1.0        | 1,650            | 1,239          | 18                | B   | -26         | 32        | 6                  | 0.09          | -27         | 6         | -21          | -1.27         |
| US 101          | Great America to Montague | SB                               | AM        | 66.0       | 3.0        | 6,900            | 6,134          | 31                 | D   | 67.0       | 1.0        | 1,650            | 1,206          | 18                | B   | -28         | 62        | 34                 | 0.49          | -24         | 11        | -13          | -0.79         |
|                 |                           |                                  | PM        | 14.0       | 3.0        | 6,900            | 6,836          | 163                | F   | 20.0       | 1.0        | 1,650            | 1,740          | 87                | F   | -35         | 13        | -22                | -0.32         | -22         | 2         | -20          | -1.21         |
| US 101          | Montague to De La Cruz    | SB                               | AM        | 66.0       | 3.0        | 6,900            | 5,573          | 28                 | D   | 67.0       | 1.0        | 1,650            | 1,123          | 17                | B   | -26         | 71        | 45                 | 0.65          | -23         | 13        | -10          | -0.61         |
|                 |                           |                                  | PM        | 13.0       | 3.0        | 6,900            | 6,292          | 161                | F   | 40.0       | 1.0        | 1,650            | 1,928          | 48                | E   | -30         | 16        | -14                | -0.20         | -24         | 3         | -21          | -1.27         |
| US 101          | De La Cruz to SR 87       | SB                               | AM        | 62.0       | 3.0        | 6,900            | 6,644          | 36                 | D   | 67.0       | 1.0        | 1,650            | 1,042          | 16                | B   | -31         | 55        | 24                 | 0.35          | -19         | 10        | -9           | -0.55         |
|                 |                           |                                  | PM        | 18.0       | 3.0        | 6,900            | 8,077          | 150                | F   | 50.0       | 1.0        | 1,650            | 1,983          | 40                | D   | -47         | 37        | -10                | -0.14         | -26         | 6         | -20          | -1.21         |
| US 101          | SR 87 to First            | SB                               | AM        | 67.0       | 3.0        | 6,900            | 4,741          | 24                 | C   | 67.0       | 1.0        | 1,650            | 817            | 12                | B   | -22         | 55        | 33                 | 0.48          | -13         | 10        | -3           | -0.18         |
|                 |                           |                                  | PM        | 16.0       | 3.0        | 6,900            | 5,998          | 125                | F   | 30.0       | 1.0        | 1,650            | 1,745          | 58                | E   | -28         | 32        | 4                  | 0.06          | -23         | 6         | -17          | -1.03         |
| US 101          | First to Old Bayshore     | SB                               | AM        | 67.0       | 3.0        | 6,900            | 3,549          | 18                 | B   | 67.0       | 1.0        | 1,650            | 587            | 9                 | A   | -18         | 54        | 36                 | 0.52          | -10         | 9         | -1           | -0.06         |
|                 |                           |                                  | PM        | 6.0        | 3.0        | 6,900            | 4,852          | 270                | F   | 20.0       | 1.0        | 1,650            | 1,492          | 75                | F   | -21         | 29        | 8                  | 0.12          | -20         | 5         | -15          | -0.91         |
| US 101          | Old Bayshore to I-880     | SB                               | AM        | 67.0       | 3.0        | 6,900            | 4,470          | 22                 | C   | 67.0       | 1.0        | 1,650            | 642            | 10                | A   | -20         | 70        | 50                 | 0.72          | -10         | 12        | 2            | 0.12          |
|                 |                           |                                  | PM        | 8.0        | 3.0        | 6,900            | 6,042          | 252                | F   | 30.0       | 1.0        | 1,650            | 1,712          | 57                | E   | -38         | 35        | -3                 | -0.04         | -24         | 6         | -18          | -1.09         |
| US 101          | McKee to Santa Clara      | SB                               | AM        | 67.0       | 3.0        | 6,900            | 4,883          | 24                 | C   | 67.0       | 1.0        | 1,650            | 581            | 9                 | A   | -20         | 27        | 7                  | 0.10          | -9          | 5         | -4           | -0.24         |
|                 |                           |                                  | PM        | 62.0       | 3.0        | 6,900            | 6,952          | 37                 | D   | 70.0       | 1.0        | 1,650            | 1,550          | 22                | C   | -9          | 78        | 69                 | 1.00          | -21         | 14        | -7           | -0.42         |
| US 101          | Santa Clara to I-280      | SB                               | AM        | 67.0       | 3.0        | 6,900            | 5,528          | 28                 | D   | 67.0       | 1.0        | 1,650            | 652            | 10                | A   | -26         | 58        | 32                 | 0.46          | -9          | 10        | 1            | 0.06          |
|                 |                           |                                  | PM        | 63.0       | 3.0        | 6,900            | 7,502          | 40                 | D   | 70.0       | 1.0        | 1,650            | 1,669          | 24                | C   | 71          | 136       | 207                | 3.00          | -26         | 24        | -2           | -0.12         |
| US 101          | I-280 to Story            | SB                               | AM        | 67.0       | 3.0        | 6,900            | 3,599          | 18                 | B   | 67.0       | 1.0        | 1,650            | 569            | 8                 | A   | -9          | 22        | 13                 | 0.19          | -7          | 4         | -3           | -0.18         |
|                 |                           |                                  | PM        | 54.0       | 3.0        | 6,900            | 5,106          | 32                 | D   | 70.0       | 1.0        | 1,650            | 1,266          | 18                | B   | -5          | 63        | 58                 | 0.84          | -21         | 11        | -10          | -0.61         |
| US 101          | Story to Tully            | SB                               | AM        | 66.0       | 4.0        | 9,200            | 8,164          | 31                 | D   | 67.0       | 1.0        | 1,650            | 845            | 13                | B   | -33         | 22        | -11                | -0.12         | -10         | 4         | -6           | -0.36         |
|                 |                           |                                  | PM        | 45.0       | 4.0        | 9,200            | 10,053         | 56                 | E   | 70.0       | 1.0        | 1,650            | 1,596          | 23                | C   | -37         | 71        | 34                 | 0.37          | -28         | 13        | -15          | -0.91         |
| I-280           | I-880 to Meridian         | EB                               | AM        | 66.0       | 4.0        | 9,200            | 6,420          | 24                 | C   | 67.0       | 1.0        | 1,650            | 517            | 8                 | A   | -42         | 18        | -24                | -0.26         | -33         | 3         | -30          | -1.82         |
|                 |                           |                                  | PM        | 17.0       | 4.0        | 9,200            | 6,856          | 101                | F   | 20.0       | 1.0        | 1,650            | 826            | 41                | D   | -40         | 10        | -30                | -0.33         | -16         | 2         | -14          | -0.85         |

**Table 17, Continued**  
**2025 Background Plus Project Conditions Freeway Segment Levels of Service**

| Freeway Segment |                               | 2025 Phase II Project Conditions |           |                 |            |          |                |         |     |                    |            |          |                |         |     | Net Project Trips |           |              |               |                    |           |              |               |
|-----------------|-------------------------------|----------------------------------|-----------|-----------------|------------|----------|----------------|---------|-----|--------------------|------------|----------|----------------|---------|-----|-------------------|-----------|--------------|---------------|--------------------|-----------|--------------|---------------|
|                 |                               | Direction                        | Peak Hour | Mixed-Flow Lane |            |          |                |         |     | HOV / Express Lane |            |          |                |         |     | Mixed-Flow Lane   |           |              |               | HOV / Express Lane |           |              |               |
|                 |                               |                                  |           | Avg. Speed      | # of Lanes | Capacity | Project Volume | Density | LOS | Avg. Speed         | # of Lanes | Capacity | Project Volume | Density | LOS | BART Volume       | JD Volume | Total Volume | % of Capacity | BART Volume        | JD Volume | Total Volume | % of Capacity |
| I-280           | Meridian to Bird              | EB                               | AM        | 61.0            | 4.0        | 9,200    | 8,609          | 35      | D   | ---                | ---        | ---      | ---            | ---     | --- | -76               | 34        | -42          | -0.46         | ---                | ---       | ---          | ---           |
| I-280           | Bird to SR 87                 | EB                               | PM        | 21.0            | 4.0        | 9,200    | 9,326          | 111     | F   | ---                | ---        | ---      | ---            | ---     | --- | -56               | 15        | -41          | -0.45         | ---                | ---       | ---          | ---           |
| I-280           | SR 87 to 10th                 | EB                               | AM        | 66.0            | 4.0        | 9,200    | 4,656          | 18      | B   | ---                | ---        | ---      | ---            | ---     | --- | -53               | 20        | -33          | -0.36         | ---                | ---       | ---          | ---           |
| I-280           | 10th to McLaughlin            | EB                               | PM        | 25.0            | 4.0        | 9,200    | 5,945          | 59      | F   | ---                | ---        | ---      | ---            | ---     | --- | -42               | 13        | -29          | -0.32         | ---                | ---       | ---          | ---           |
| I-280           | McLaughlin to US 101          | EB                               | AM        | 67.0            | 4.0        | 9,200    | 6,382          | 24      | C   | ---                | ---        | ---      | ---            | ---     | --- | -87               | 34        | -53          | -0.58         | ---                | ---       | ---          | ---           |
| I-280           | US 101 to King                | EB                               | PM        | 27.0            | 4.0        | 9,200    | 8,458          | 78      | F   | ---                | ---        | ---      | ---            | ---     | --- | -72               | 26        | -46          | -0.50         | ---                | ---       | ---          | ---           |
| I-280           | King to Capitol               | EB                               | AM        | 66.0            | 4.0        | 9,200    | 7,529          | 29      | D   | ---                | ---        | ---      | ---            | ---     | --- | -133              | 27        | -106         | -1.15         | ---                | ---       | ---          | ---           |
| I-280           | Capitol to Alum Rock          | EB                               | PM        | 54.0            | 4.0        | 9,200    | 10,130         | 47      | E   | ---                | ---        | ---      | ---            | ---     | --- | -134              | 24        | -110         | -1.20         | ---                | ---       | ---          | ---           |
| I-280           | Alum Rock to McKee            | EB                               | AM        | 66.0            | 4.0        | 9,200    | 5,542          | 21      | C   | ---                | ---        | ---      | ---            | ---     | --- | -129              | 18        | -111         | -1.21         | ---                | ---       | ---          | ---           |
| I-280           | McKee to Alum Rock            | EB                               | PM        | 54.0            | 4.0        | 9,200    | 6,724          | 31      | D   | ---                | ---        | ---      | ---            | ---     | --- | -103              | 11        | -92          | -1.00         | ---                | ---       | ---          | ---           |
| I-680           | US 101 to King                | NB                               | AM        | 33.0            | 4.0        | 9,200    | 5,470          | 41      | D   | ---                | ---        | ---      | ---            | ---     | --- | -124              | 11        | -113         | -1.23         | ---                | ---       | ---          | ---           |
| I-680           | King to Capitol               | NB                               | PM        | 66.0            | 4.0        | 9,200    | 6,515          | 25      | C   | ---                | ---        | ---      | ---            | ---     | --- | -96               | 6         | -90          | -0.98         | ---                | ---       | ---          | ---           |
| I-680           | Capitol to Alum Rock          | NB                               | AM        | 20.0            | 5.0        | 11,500   | 7,623          | 76      | F   | 55.0               | 1.0        | 1,650    | 415            | 8       | A   | -106              | 3         | -103         | -0.90         | -8                 | 0         | -8           | -0.48         |
| I-680           | Alum Rock to McKee            | NB                               | PM        | 47.0            | 5.0        | 11,500   | 9,666          | 41      | D   | 55.0               | 1.0        | 1,650    | 365            | 7       | A   | -89               | 10        | -79          | -0.69         | -21                | 2         | -19          | -1.15         |
| I-680           | McKee to Alum Rock            | NB                               | AM        | 18.0            | 4.0        | 9,200    | 6,137          | 85      | F   | 55.0               | 1.0        | 1,650    | 415            | 8       | A   | -108              | 2         | -106         | -1.15         | -8                 | 0         | -8           | -0.48         |
| I-680           | Alum Rock to McKee            | NB                               | PM        | 65.0            | 4.0        | 9,200    | 6,391          | 25      | C   | 55.0               | 1.0        | 1,650    | 365            | 7       | A   | -59               | 0         | -59          | -0.64         | -21                | 0         | -21          | -1.27         |
| I-680           | McKee to Alum Rock            | NB                               | AM        | 27.0            | 4.0        | 9,200    | 7,121          | 66      | F   | 55.0               | 1.0        | 1,650    | 609            | 11      | A   | -123              | 2         | -121         | -1.32         | -10                | 0         | -10          | -0.61         |
| I-680           | Alum Rock to Capitol          | NB                               | PM        | 66.0            | 4.0        | 9,200    | 6,921          | 26      | C   | 55.0               | 1.0        | 1,650    | 472            | 9       | A   | -59               | 5         | -54          | -0.59         | -24                | 1         | -23          | -1.39         |
| I-680           | Capitol to King               | NB                               | AM        | 63.0            | 4.0        | 9,200    | 6,679          | 27      | D   | 55.0               | 1.0        | 1,650    | 462            | 8       | A   | -77               | 4         | -73          | -0.79         | -32                | 1         | -31          | -1.88         |
| I-680           | King to US 101                | NB                               | PM        | 47.0            | 4.0        | 9,200    | 7,321          | 39      | D   | 55.0               | 1.0        | 1,650    | 493            | 9       | A   | -100              | 1         | -99          | -1.08         | -7                 | 0         | -7           | -0.42         |
| I-680           | US 101 to King                | NB                               | AM        | 23.0            | 4.0        | 9,200    | 6,430          | 70      | F   | 55.0               | 1.0        | 1,650    | 461            | 8       | A   | -86               | 3         | -83          | -0.90         | -32                | 0         | -32          | -1.94         |
| I-680           | King to US 101                | NB                               | PM        | 65.0            | 4.0        | 9,200    | 5,600          | 22      | C   | 55.0               | 1.0        | 1,650    | 493            | 9       | A   | -83               | 0         | -83          | -0.90         | -7                 | 0         | -7           | -0.42         |
| I-680           | US 101 to McLaughlin          | NB                               | AM        | 21.0            | 4.0        | 9,200    | 9,458          | 113     | F   | 55.0               | 1.0        | 1,650    | 327            | 6       | A   | -134              | 14        | -120         | -1.30         | -31                | 2         | -29          | -1.76         |
| I-680           | McLaughlin to 10th            | NB                               | PM        | 66.0            | 4.0        | 9,200    | 7,622          | 29      | D   | 55.0               | 1.0        | 1,650    | 219            | 4       | A   | -91               | 3         | -88          | -0.96         | -4                 | 0         | -4           | -0.24         |
| I-680           | 10th to SR 87                 | NB                               | AM        | 12.0            | 4.0        | 9,200    | 6,445          | 134     | F   | ---                | ---        | ---      | ---            | ---     | --- | -166              | 6         | -160         | -1.74         | ---                | ---       | ---          | ---           |
| I-680           | SR 87 to Bird                 | NB                               | PM        | 66.0            | 4.0        | 9,200    | 5,224          | 20      | C   | ---                | ---        | ---      | ---            | ---     | --- | -106              | 0         | -106         | -1.15         | ---                | ---       | ---          | ---           |
| I-280           | Bird to Meridian              | WB                               | AM        | 14.0            | 4.0        | 9,200    | 6,445          | 115     | F   | ---                | ---        | ---      | ---            | ---     | --- | -166              | 6         | -160         | -1.74         | ---                | ---       | ---          | ---           |
| I-280           | Meridian to I-880             | WB                               | PM        | 66.0            | 4.0        | 9,200    | 5,224          | 20      | C   | ---                | ---        | ---      | ---            | ---     | --- | -106              | 0         | -106         | -1.15         | ---                | ---       | ---          | ---           |
| I-280           | I-880 to Meridian             | WB                               | AM        | 19.0            | 4.0        | 9,200    | 10,475         | 138     | F   | ---                | ---        | ---      | ---            | ---     | --- | -257              | 32        | -225         | -2.45         | ---                | ---       | ---          | ---           |
| I-280           | Meridian to I-880             | WB                               | PM        | 65.0            | 4.0        | 9,200    | 8,046          | 31      | D   | ---                | ---        | ---      | ---            | ---     | --- | -43               | 77        | 34           | 0.37          | ---                | ---       | ---          | ---           |
| I-280           | I-880 to Meridian             | WB                               | AM        | 21.0            | 4.0        | 9,200    | 9,988          | 119     | F   | ---                | ---        | ---      | ---            | ---     | --- | -191              | 32        | -159         | -1.73         | ---                | ---       | ---          | ---           |
| I-280           | Meridian to I-880             | WB                               | PM        | 65.0            | 4.0        | 9,200    | 8,368          | 32      | D   | ---                | ---        | ---      | ---            | ---     | --- | -32               | 69        | 37           | 0.40          | ---                | ---       | ---          | ---           |
| I-280           | I-880 to Meridian             | WB                               | AM        | 20.0            | 4.0        | 9,200    | 6,109          | 76      | F   | ---                | ---        | ---      | ---            | ---     | --- | -96               | 14        | -82          | -0.89         | ---                | ---       | ---          | ---           |
| I-280           | Meridian to I-880             | WB                               | PM        | 62.0            | 4.0        | 9,200    | 5,371          | 22      | C   | ---                | ---        | ---      | ---            | ---     | --- | 0                 | 53        | 53           | 0.58          | ---                | ---       | ---          | ---           |
| I-280           | I-880 to Meridian             | WB                               | AM        | 18.0            | 4.0        | 9,200    | 9,649          | 134     | F   | ---                | ---        | ---      | ---            | ---     | --- | -121              | 18        | -103         | -1.12         | ---                | ---       | ---          | ---           |
| I-280           | Meridian to I-880             | WB                               | PM        | 58.0            | 4.0        | 9,200    | 8,959          | 39      | D   | ---                | ---        | ---      | ---            | ---     | --- | -10               | 55        | 45           | 0.49          | ---                | ---       | ---          | ---           |
| I-280           | I-880 to Meridian             | WB                               | AM        | 14.0            | 3.0        | 6,900    | 7,219          | 172     | F   | 26.0               | 1.0        | 1,650    | 756            | 29      | D   | -90               | 14        | -76          | -1.10         | -23                | 3         | -20          | -1.21         |
| I-280           | Meridian to I-880             | WB                               | PM        | 66.0            | 3.0        | 6,900    | 6,499          | 33      | D   | 70.0               | 1.0        | 1,650    | 445            | 6       | A   | 20                | 34        | 54           | 0.78          | -26                | 6         | -20          | -1.21         |
| SR 87           | Curtner to Almaden Expressway | NB                               | AM        | 13.0            | 2.0        | 4,400    | 3,766          | 145     | F   | 22.0               | 1.0        | 1,650    | 1,713          | 78      | F   | -26               | 20        | -6           | -0.14         | -27                | 4         | -23          | -1.39         |
| SR 87           | Almaden Expressway to Alma    | NB                               | PM        | 65.0            | 2.0        | 4,400    | 3,161          | 24      | C   | 70.0               | 1.0        | 1,650    | 665            | 10      | A   | -4                | 4         | 0            | 0.00          | -5                 | 1         | -4           | -0.24         |
| SR 87           | Alma to I-280                 | NB                               | AM        | 29.0            | 2.0        | 4,400    | 4,693          | 81      | F   | 43.0               | 1.0        | 1,650    | 1,962          | 46      | D   | -30               | 23        | -7           | -0.16         | -35                | 4         | -31          | -1.88         |
| SR 87           | I-280 to Julian               | NB                               | PM        | 41.0            | 2.0        | 4,400    | 3,889          | 47      | E   | 70.0               | 1.0        | 1,650    | 727            | 10      | A   | -6                | 5         | -1           | -0.02         | -5                 | 1         | -4           | -0.24         |
| SR 87           | Julian to Coleman             | NB                               | AM        | 33.0            | 2.0        | 4,400    | 5,636          | 85      | F   | 61.0               | 1.0        | 1,650    | 1,986          | 33      | D   | -38               | 23        | -15          | -0.34         | -33                | 4         | -29          | -1.76         |
| SR 87           | Coleman to Julian             | NB                               | PM        | 66.0            | 2.0        | 4,400    | 4,360          | 33      | D   | 70.0               | 1.0        | 1,650    | 791            | 11      | A   | -7                | 5         | -2           | -0.05         | -7                 | 1         | -6           | -0.36         |
| SR 87           | Julian to Coleman             | NB                               | AM        | 16.0            | 2.0        | 4,400    | 3,309          | 103     | F   | 30.0               | 1.0        | 1,650    | 1,295          | 43      | D   | -19               | 8         | -11          | -0.25         | -20                | 1         | -19          | -1.15         |
| SR 87           | Coleman to Julian             | NB                               | PM        | 67.0            | 2.0        | 4,400    | 1,794          | 13      | B   | 70.0               | 1.0        | 1,650    | 396            | 6       | A   | -6                | 0         | -6           | -0.14         | -4                 | 0         | -4           | -0.24         |
| SR 87           | Julian to Coleman             | NB                               | AM        | 14.0            | 2.0        | 4,400    | 4,570          | 163     | F   | 32.0               | 1.0        | 1,650    | 1,521          | 48      | E   | -51               | 26        | -25          | -0.57         | -30                | 4         | -26          | -1.58         |
| SR 87           | Coleman to Julian             | NB                               | PM        | 67.0            | 2.0        | 4,400    | 2,725          | 20      | C   | 70.0               | 1.0        | 1,650    | 521            | 7       | A   | -47               | 5         | -42          | -0.95         | -7                 | 1         | -6           | -0.36         |
| SR 87           | Julian to Coleman             | NB                               | AM        | 66.0            | 2.0        | 4,400    | 2,256          | 17      | B   | 67.0               | 1.0        | 1,650    | 225            | 3       | A   | -31               | 3         | -28          | -0.64         | -4                 | 0         | -4           | -0.24         |
| SR 87           | Coleman to Julian             | NB                               | PM        | 32.0            | 2.0        | 4,400    | 4,001          | 63      | F   | 50.0               | 1.0        | 1,650    | 1,089          | 22      | C   | -26               | 14        | -12          | -0.27         | -27                | 2         | -25          | -1.52         |

**Table 17, Continued**  
**2025 Background Plus Project Conditions Freeway Segment Levels of Service**

| Freeway Segment                     | Direction | Peak Hour | 2025 Phase II Project Conditions |            |          |                |            |     |                    |            |          |                |         |     | Net Project Trips |           |              |               |                    |           |              |               |
|-------------------------------------|-----------|-----------|----------------------------------|------------|----------|----------------|------------|-----|--------------------|------------|----------|----------------|---------|-----|-------------------|-----------|--------------|---------------|--------------------|-----------|--------------|---------------|
|                                     |           |           | Mixed-Flow Lane                  |            |          |                |            |     | HOV / Express Lane |            |          |                |         |     | Mixed-Flow Lane   |           |              |               | HOV / Express Lane |           |              |               |
|                                     |           |           | Avg. Speed                       | # of Lanes | Capacity | Project Volume | Density    | LOS | Avg. Speed         | # of Lanes | Capacity | Project Volume | Density | LOS | BART Volume       | JD Volume | Total Volume | % of Capacity | BART Volume        | JD Volume | Total Volume | % of Capacity |
| SR 87 Julian to I-280               | SB        | AM        | 67.0                             | 2.0        | 4,400    | 2,669          | 20         | C   | 67.0               | 1.0        | 1,650    | 290            | 4       | A   | -15               | 9         | -6           | -0.14         | -5                 | 2         | -3           | -0.18         |
|                                     |           | PM        | 36.0                             | 2.0        | 4,400    | 4,611          | <b>64</b>  | F   | 70.0               | 1.0        | 1,650    | 1,212          | 17      | B   | -23               | 18        | -5           | -0.11         | -22                | 3         | -19          | -1.15         |
| SR 87 I-280 to Alma                 | SB        | AM        | 67.0                             | 2.0        | 4,400    | 3,748          | 28         | D   | 67.0               | 1.0        | 1,650    | 556            | 8       | A   | -2                | 6         | 4            | 0.09          | -18                | 1         | -17          | -1.03         |
|                                     |           | PM        | 15.0                             | 2.0        | 4,400    | 3,793          | <b>126</b> | F   | 60.0               | 1.0        | 1,650    | 1,735          | 29      | D   | -8                | 7         | -1           | -0.02         | -23                | 1         | -22          | -1.33         |
| SR 87 Alma to Almaden Expressway    | SB        | AM        | 66.0                             | 2.0        | 4,400    | 3,740          | 28         | D   | 67.0               | 1.0        | 1,650    | 543            | 8       | A   | -3                | 7         | 4            | 0.09          | -18                | 1         | -17          | -1.03         |
|                                     |           | PM        | 27.0                             | 2.0        | 4,400    | 4,427          | <b>82</b>  | F   | 60.0               | 1.0        | 1,650    | 1,700          | 28      | D   | -12               | 14        | 2            | 0.05          | -23                | 3         | -20          | -1.21         |
| SR 87 Almaden Expressway to Curtner | SB        | AM        | 66.0                             | 2.0        | 4,400    | 2,869          | 22         | C   | 67.0               | 1.0        | 1,650    | 483            | 7       | A   | -1                | 4         | 3            | 0.07          | -17                | 1         | -16          | -0.97         |
|                                     |           | PM        | 36.0                             | 2.0        | 4,400    | 3,484          | 48         | E   | 70.0               | 1.0        | 1,650    | 1,503          | 21      | C   | -9                | 13        | 4            | 0.09          | -19                | 2         | -17          | -1.03         |
| I-880 I-280 to Stevens Creek        | NB        | AM        | 15.0                             | 3.0        | 6,900    | 5,207          | <b>116</b> | F   | 55.0               | 1.0        | 1,650    | 620            | 11      | A   | -54               | 48        | -6           | -0.09         | -36                | 9         | -27          | -1.64         |
|                                     |           | PM        | 66.0                             | 3.0        | 6,900    | 4,739          | 24         | C   | 55.0               | 1.0        | 1,650    | 798            | 15      | B   | -34               | 9         | -25          | -0.36         | -19                | 2         | -17          | -1.03         |
| I-880 Stevens Creek to Bascom       | NB        | AM        | 20.0                             | 3.0        | 6,900    | 6,663          | <b>111</b> | F   | 55.0               | 1.0        | 1,650    | 621            | 11      | A   | -77               | 57        | -20          | -0.29         | -36                | 10        | -26          | -1.58         |
|                                     |           | PM        | 16.0                             | 3.0        | 6,900    | 5,488          | <b>114</b> | F   | 55.0               | 1.0        | 1,650    | 798            | 15      | B   | -44               | 10        | -34          | -0.49         | -19                | 2         | -17          | -1.03         |
| I-880 Bascom to The Alameda         | NB        | AM        | 27.0                             | 3.0        | 6,900    | 6,085          | <b>75</b>  | F   | 55.0               | 1.0        | 1,650    | 665            | 12      | B   | -75               | 36        | -39          | -0.57         | -36                | 6         | -30          | -1.82         |
|                                     |           | PM        | 13.0                             | 3.0        | 6,900    | 6,051          | <b>155</b> | F   | 55.0               | 1.0        | 1,650    | 900            | 16      | B   | -54               | 13        | -41          | -0.59         | -21                | 2         | -19          | -1.15         |
| I-880 The Alameda to Coleman        | NB        | AM        | 31.0                             | 3.0        | 6,900    | 6,312          | <b>68</b>  | F   | 55.0               | 1.0        | 1,650    | 678            | 12      | B   | -95               | 32        | -63          | -0.91         | -33                | 6         | -27          | -1.64         |
|                                     |           | PM        | 15.0                             | 3.0        | 6,900    | 6,405          | <b>142</b> | F   | 55.0               | 1.0        | 1,650    | 1,073          | 20      | C   | -73               | 15        | -58          | -0.84         | -26                | 3         | -23          | -1.39         |
| I-880 Coleman to SR 87              | NB        | AM        | 22.0                             | 3.0        | 6,900    | 6,052          | <b>92</b>  | F   | 55.0               | 1.0        | 1,650    | 781            | 14      | B   | -95               | 31        | -64          | -0.93         | -38                | 6         | -32          | -1.94         |
|                                     |           | PM        | 24.0                             | 3.0        | 6,900    | 6,297          | <b>87</b>  | F   | 55.0               | 1.0        | 1,650    | 1,249          | 23      | C   | -84               | 31        | -53          | -0.77         | -36                | 6         | -30          | -1.82         |
| I-880 SR 87 to First                | NB        | AM        | 48.0                             | 3.0        | 6,900    | 6,052          | 42         | D   | 55.0               | 1.0        | 1,650    | 781            | 14      | B   | -95               | 31        | -64          | -0.93         | -38                | 6         | -32          | -1.94         |
|                                     |           | PM        | 22.0                             | 3.0        | 6,900    | 6,297          | <b>95</b>  | F   | 55.0               | 1.0        | 1,650    | 1,249          | 23      | C   | -84               | 31        | -53          | -0.77         | -36                | 6         | -30          | -1.82         |
| I-880 First to US 101               | NB        | AM        | 36.0                             | 3.0        | 6,900    | 5,678          | 53         | E   | 55.0               | 1.0        | 1,650    | 622            | 11      | A   | -101              | 29        | -72          | -1.04         | -24                | 5         | -19          | -1.15         |
|                                     |           | PM        | 51.0                             | 3.0        | 6,900    | 6,837          | 45         | D   | 55.0               | 1.0        | 1,650    | 1,047          | 19      | C   | -109              | 25        | -84          | -1.22         | -32                | 4         | -28          | -1.70         |
| I-880 US 101 to First               | SB        | AM        | 16.0                             | 3.0        | 6,900    | 6,155          | <b>128</b> | F   | 55.0               | 1.0        | 1,650    | 1,034          | 19      | C   | -93               | 37        | -56          | -0.81         | -66                | 7         | -59          | -3.58         |
|                                     |           | PM        | 14.0                             | 3.0        | 6,900    | 5,573          | <b>133</b> | F   | 55.0               | 1.0        | 1,650    | 715            | 13      | B   | -131              | 19        | -112         | -1.62         | -161               | 3         | -158         | -9.58         |
| I-880 First to SR 87                | SB        | AM        | 25.0                             | 3.0        | 6,900    | 5,710          | <b>76</b>  | F   | 55.0               | 1.0        | 1,650    | 1,080          | 20      | C   | -79               | 48        | -31          | -0.45         | -68                | 8         | -60          | -3.64         |
|                                     |           | PM        | 14.0                             | 3.0        | 6,900    | 5,602          | <b>133</b> | F   | 55.0               | 1.0        | 1,650    | 772            | 14      | B   | -124              | 21        | -103         | -1.49         | -201               | 4         | -197         | -11.94        |
| I-880 SR 87 to Coleman              | SB        | AM        | 65.0                             | 3.0        | 6,900    | 5,710          | 29         | D   | 55.0               | 1.0        | 1,650    | 1,080          | 20      | C   | -79               | 48        | -31          | -0.45         | -68                | 8         | -60          | -3.64         |
|                                     |           | PM        | 23.0                             | 3.0        | 6,900    | 5,602          | <b>81</b>  | F   | 55.0               | 1.0        | 1,650    | 772            | 14      | B   | -124              | 21        | -103         | -1.49         | -201               | 4         | -197         | -11.94        |
| I-880 Coleman to The Alameda        | SB        | AM        | 66.0                             | 3.0        | 6,900    | 6,267          | 32         | D   | 55.0               | 1.0        | 1,650    | 862            | 16      | B   | -89               | 11        | -78          | -1.13         | -52                | 2         | -50          | -3.03         |
|                                     |           | PM        | 23.0                             | 3.0        | 6,900    | 6,595          | <b>96</b>  | F   | 55.0               | 1.0        | 1,650    | 675            | 12      | B   | -151              | 15        | -136         | -1.97         | -197               | 3         | -194         | -11.76        |
| I-880 The Alameda to Bascom         | SB        | AM        | 66.0                             | 3.0        | 6,900    | 5,956          | 30         | D   | 55.0               | 1.0        | 1,650    | 795            | 14      | B   | -60               | 7         | -53          | -0.77         | -48                | 1         | -47          | -2.85         |
|                                     |           | PM        | 25.0                             | 3.0        | 6,900    | 6,554          | <b>87</b>  | F   | 55.0               | 1.0        | 1,650    | 710            | 13      | B   | -115              | 18        | -97          | -1.41         | -221               | 3         | -218         | -13.21        |
| I-880 Bascom to Stevens Creek       | SB        | AM        | 50.0                             | 3.0        | 6,900    | 5,802          | 39         | D   | 55.0               | 1.0        | 1,650    | 796            | 14      | B   | -45               | 12        | -33          | -0.48         | -48                | 2         | -46          | -2.79         |
|                                     |           | PM        | 30.0                             | 3.0        | 6,900    | 6,579          | <b>73</b>  | F   | 55.0               | 1.0        | 1,650    | 728            | 13      | B   | -107              | 48        | -59          | -0.86         | -224               | 8         | -216         | -13.09        |
| I-880 Stevens Creek to I-280        | SB        | AM        | 66.0                             | 3.0        | 6,900    | 4,470          | 23         | C   | 55.0               | 1.0        | 1,650    | 692            | 13      | B   | -36               | 10        | -26          | -0.38         | -44                | 2         | -42          | -2.55         |
|                                     |           | PM        | 65.0                             | 3.0        | 6,900    | 4,778          | 25         | C   | 55.0               | 1.0        | 1,650    | 648            | 12      | B   | -84               | 37        | -47          | -0.68         | -218               | 6         | -212         | -12.85        |

Source: Santa Clara Valley Transportation Authority Congestion Management Program Monitoring Study, 2014.

3.00%

0.12%

The average speed for future HOV lanes are assumed to be 55 MPH.

**Bold** indicates unacceptable LOS.



## 5. Other Transportation Topics

---

This chapter presents an analysis of other transportation topics associated with the Project, including:

- Intersection operations analysis – vehicle queuing and storage at selected intersections
- Freeway off-ramp operations analysis – vehicle queuing and storage at selected freeway ramps
- Freeway on-ramp meter analysis
- Unsignalized intersection analysis – Lafayette Street and Harrison Street
- Site access
- Bus transit vehicle delay
- Potential project impacts to bicycle and pedestrian facilities
- Vehicle Miles Traveled (VMT)
- Parking

Unlike the level of service impact methodology, which is adopted by the City Councils of San Jose and Santa Clara, the analyses in this chapter are based on professional judgment in accordance with the standards and methods employed by the traffic engineering community.

### Intersection Operations Analysis

The analysis of intersection level of service was supplemented with an analysis of traffic operations for intersections where the Project would add left turns. The operations analysis is based on vehicle queuing for high demand left-turn movements at intersections. Vehicle queues were estimated using a Poisson probability distribution, which estimates the probability of “n” vehicles for a vehicle movement using the following formula:

$$P(x=n) = \frac{\lambda^n e^{-\lambda}}{n!}$$

Where:

P(x=n) = probability of “n” vehicles in queue per lane

n = number of vehicles in the queue per lane

$\lambda$  = Average # of vehicles in the queue per lane (vehicles per hr per lane/signal cycles per hr)

The basis of the analysis is as follows: (1) the Poisson probability distribution is used to estimate the 95<sup>th</sup> percentile maximum number of queued vehicles per signal cycle for a particular movement; (2) the estimated maximum number of vehicles in the queue is translated into a queue length, assuming 25 feet per vehicle; and (3) the estimated maximum queue length is compared to the existing or planned storage capacity for the movement. This analysis thus provides a basis for estimating future left-turn storage requirements at signalized intersections. The 95<sup>th</sup> percentile queue length value indicates that during the peak hour, a queue of this length or less would occur on 95 percent of the signal cycles. Or, a queue length larger than the 95<sup>th</sup> percentile queue would only occur on 5 percent of the signal cycles (about 3 cycles during the peak hour for a signal with a 60-second cycle length). Thus, left-turn storage pocket designs based on the 95<sup>th</sup> percentile queue length would ensure that storage space would be exceeded only 5 percent of the time. The 95<sup>th</sup> percentile queue length is also known as

the “design queue length.” The vehicle queue estimates and a tabulated summary of the findings are provided in Tables 18 and 19.

**Table 18**  
**Vehicle Queuing and Left-Turn Pocket Storage Analysis – AM Peak Hour**

| Measurement  | N 28th St & E Julian St |      | US 101 SB              | US 101 NB        | N 28th St & E Santa Clara St |     | US 101 NB            | King Rd & E San Antonio St | McLaughlin Av & I-280 SB |  |
|--|-------------------------|------|------------------------|------------------|------------------------------|-----|----------------------|----------------------------|--------------------------|--|
|  | NBL-T                   | WBL  | Off-Ramp & E Julian St | Ramps & McKee Rd | SBL-T <sup>3</sup>           | EBL | Ramps & Alum Rock Av | E San Antonio St           | Off-Ramp                 |  |
|  | AM                      | AM   | NBL                    | NBL              | AM                           | AM  | NBL-T                | NBL                        | EBL                      |  |
| <b>2015 Existing</b>   |                         |      |                        |                  |                              |     |                      |                            |                          |  |
| Cycle/Delay <sup>1</sup> (sec)   | 140                     | 140  | 140                    | 140              | 80                           | 80  | 60                   | 98                         | 85                       |  |
| Volume (vphpl)   | 113                     | 36   | 106                    | 240              | 122                          | 37  | 100                  | 133                        | 193                      |  |
| Avg. Queue (veh./ln.)  | 4.4                     | 1.4  | 4.1                    | 9.3              | 2.7                          | 0.8 | 1.7                  | 3.6                        | 4.6                      |  |
| Avg. Queue <sup>2</sup> (ft./ln.)  | 110                     | 35   | 103                    | 233              | 68                           | 21  | 42                   | 91                         | 114                      |  |
| 95th % Queue (veh./ln.)  | 8                       | 4    | 8                      | 15               | 6                            | 3   | 4                    | 7                          | 8                        |  |
| 95th % Queue (ft./ln.)   | 200                     | 100  | 200                    | 375              | 150                          | 75  | 100                  | 175                        | 200                      |  |
| Storage (ft./ln.)  | 250                     | 125  | 550                    | 300              | 400                          | 150 | 250                  | 250                        | 600                      |  |
| Adequate (Y/N)   | Y                       | Y    | Y                      | N                | Y                            | Y   | Y                    | Y                          | Y                        |  |
| <b>2015 Existing Plus Project</b>  |                         |      |                        |                  |                              |     |                      |                            |                          |  |
| Cycle/Delay <sup>1</sup> (sec)   | 140                     | 140  | 140                    | 140              | 80                           | 80  | 60                   | 98                         | 85                       |  |
| Volume (vphpl)   | 142                     | 349  | 212                    | 341              | 176                          | 225 | 157                  | 151                        | 220                      |  |
| Avg. Queue (veh./ln.)  | 5.5                     | 13.6 | 8.2                    | 13.3             | 3.9                          | 5.0 | 2.6                  | 4.1                        | 5.2                      |  |
| Avg. Queue <sup>2</sup> (ft./ln.)  | 138                     | 339  | 206                    | 332              | 98                           | 125 | 65                   | 103                        | 130                      |  |
| 95th % Queue (veh./ln.)  | 10                      | 20   | 13                     | 20               | 7                            | 9   | 6                    | 8                          | 9                        |  |
| 95th % Queue (ft./ln.)   | 250                     | 500  | 325                    | 500              | 175                          | 225 | 150                  | 200                        | 225                      |  |
| Storage (ft./ln.)  | 250                     | 125  | 550                    | 300              | 400                          | 150 | 250                  | 250                        | 600                      |  |
| Adequate (Y/N)   | Y                       | N    | Y                      | N                | Y                            | N   | Y                    | Y                          | Y                        |  |
| <b>2025 Background</b>   |                         |      |                        |                  |                              |     |                      |                            |                          |  |
| Cycle/Delay <sup>1</sup> (sec)   | 140                     | 140  | 140                    | 140              | 80                           | 80  | 60                   | 98                         | 85                       |  |
| Volume (vphpl)   | 113                     | 36   | 112                    | 253              | 122                          | 37  | 100                  | 134                        | 199                      |  |
| Avg. Queue (veh./ln.)  | 4.4                     | 1.4  | 4.4                    | 9.8              | 2.7                          | 0.8 | 1.7                  | 3.6                        | 4.7                      |  |
| Avg. Queue <sup>2</sup> (ft./ln.)  | 110                     | 35   | 109                    | 246              | 68                           | 21  | 42                   | 91                         | 117                      |  |
| 95th % Queue (veh./ln.)  | 8                       | 4    | 8                      | 15               | 6                            | 3   | 4                    | 7                          | 9                        |  |
| 95th % Queue (ft./ln.)   | 200                     | 100  | 200                    | 375              | 150                          | 75  | 100                  | 175                        | 225                      |  |
| Storage (ft./ln.)  | 250                     | 125  | 550                    | 300              | 400                          | 150 | 250                  | 250                        | 600                      |  |
| Adequate (Y/N)   | Y                       | Y    | Y                      | N                | Y                            | Y   | Y                    | Y                          | Y                        |  |
| <b>2025 Background Plus Project</b>  |                         |      |                        |                  |                              |     |                      |                            |                          |  |
| Cycle/Delay <sup>1</sup> (sec)   | 140                     | 140  | 140                    | 140              | 80                           | 80  | 60                   | 98                         | 85                       |  |
| Volume (vphpl)   | 142                     | 397  | 254                    | 301              | 188                          | 237 | 163                  | 155                        | 215                      |  |
| Avg. Queue (veh./ln.)  | 5.5                     | 15.4 | 9.9                    | 11.7             | 4.2                          | 5.3 | 2.7                  | 4.2                        | 5.1                      |  |
| Avg. Queue <sup>2</sup> (ft./ln.)  | 138                     | 386  | 247                    | 293              | 104                          | 132 | 68                   | 105                        | 127                      |  |
| 95th % Queue (veh./ln.)  | 10                      | 22   | 15                     | 18               | 8                            | 9   | 6                    | 8                          | 9                        |  |
| 95th % Queue (ft./ln.)   | 250                     | 550  | 375                    | 450              | 200                          | 225 | 150                  | 200                        | 225                      |  |
| Storage (ft./ln.)  | 250                     | 125  | 550                    | 300              | 400                          | 150 | 250                  | 250                        | 600                      |  |
| Adequate (Y/N)   | Y                       | N    | Y                      | N                | Y                            | N   | Y                    | Y                          | Y                        |  |
| <b>Notes:</b>  |                         |      |                        |                  |                              |     |                      |                            |                          |  |
| <sup>1</sup> Vehicle queue calculations based on cycle length for signalized intersections.  |                         |      |                        |                  |                              |     |                      |                            |                          |  |
| <sup>2</sup> Assumes 25 Feet Per Vehicle Queued  |                         |      |                        |                  |                              |     |                      |                            |                          |  |
| <sup>3</sup> The SB approach at this intersection has a shared LT-Thru lane with 150 feet of striping. However, N 28th Street provides 400 feet of vehicle storage space for the SB LT-Thru movement between Santa Clara Street and 5 Wounds Lane. |                         |      |                        |                  |                              |     |                      |                            |                          |  |

**Table 18, Continued**  
**Vehicle Queuing and Left-Turn Pocket Storage Analysis – AM Peak Hour**

| Measurement   | Lafayette St & Central Expwy |                        | Coleman Av & Brokaw Rd |           |
|---|------------------------------|------------------------|------------------------|-----------|
|   | SBL<br>AM                    | NBL <sup>3</sup><br>AM | EBL<br>AM              | EBL<br>AM |
| <b>2015 Existing</b>  |                              |                        |                        |           |
| Cycle/Delay <sup>1</sup> (sec)  | 180                          | 90                     | 90                     | 90        |
| Volume (vphpl)  | 77                           | 140                    | 131                    | 131       |
| Avg. Queue (veh./ln.)   | 3.9                          | 3.5                    | 3.3                    | 3.3       |
| Avg. Queue <sup>2</sup> (ft./ln)  | 96                           | 88                     | 82                     | 82        |
| 95th % Queue (veh./ln.)   | 7                            | 7                      | 6                      | 6         |
| 95th % Queue (ft./ln)   | 175                          | 175                    | 150                    | 150       |
| Storage (ft./ ln.)  | 225                          | 200+                   | 250                    | 250       |
| Adequate (Y/N)  | Y                            | Y                      | Y                      | Y         |
| <b>2015 Existing Plus Project</b>   |                              |                        |                        |           |
| Cycle/Delay <sup>1</sup> (sec)  | 180                          | 90                     | 90                     | 90        |
| Volume (vphpl)  | 84                           | 326                    | 211                    | 211       |
| Avg. Queue (veh./ln.)   | 4.2                          | 8.2                    | 5.3                    | 5.3       |
| Avg. Queue <sup>2</sup> (ft./ln)  | 105                          | 204                    | 132                    | 132       |
| 95th % Queue (veh./ln.)   | 8                            | 13                     | 9                      | 9         |
| 95th % Queue (ft./ln)   | 200                          | 325                    | 225                    | 225       |
| Storage (ft./ ln.)  | 225                          | 200+                   | 250                    | 250       |
| Adequate (Y/N)  | Y                            | Y <sup>3</sup>         | Y                      | Y         |
| <b>2025 Background</b>  |                              |                        |                        |           |
| Cycle/Delay <sup>1</sup> (sec)  | 180                          | 90                     | 90                     | 90        |
| Volume (vphpl)  | 77                           | 140                    | 131                    | 131       |
| Avg. Queue (veh./ln.)   | 3.9                          | 3.5                    | 3.3                    | 3.3       |
| Avg. Queue <sup>2</sup> (ft./ln)  | 96                           | 88                     | 82                     | 82        |
| 95th % Queue (veh./ln.)   | 7                            | 7                      | 6                      | 6         |
| 95th % Queue (ft./ln)   | 175                          | 175                    | 150                    | 150       |
| Storage (ft./ ln.)  | 225                          | 200+                   | 250                    | 250       |
| Adequate (Y/N)  | Y                            | Y                      | Y                      | Y         |
| <b>2025 Background Plus Project</b>   |                              |                        |                        |           |
| Cycle/Delay <sup>1</sup> (sec)  | 180                          | 90                     | 90                     | 90        |
| Volume (vphpl)  | 95                           | 319                    | 205                    | 205       |
| Avg. Queue (veh./ln.)   | 4.8                          | 8.0                    | 5.1                    | 5.1       |
| Avg. Queue <sup>2</sup> (ft./ln)  | 119                          | 199                    | 128                    | 128       |
| 95th % Queue (veh./ln.)   | 9                            | 13                     | 9                      | 9         |
| 95th % Queue (ft./ln)   | 225                          | 325                    | 225                    | 225       |
| Storage (ft./ ln.)  | 225                          | 200+                   | 250                    | 250       |
| Adequate (Y/N)  | Y                            | Y <sup>3</sup>         | Y                      | Y         |
| <b>Notes:</b>   |                              |                        |                        |           |
| <sup>1</sup> Vehicle queue calculations based on cycle length for signalized intersections.   |                              |                        |                        |           |
| <sup>2</sup> Assumes 25 Feet Per Vehicle Queued   |                              |                        |                        |           |
| <sup>3</sup> Although there is only about 200 feet of striping for the NB left-turn pocket, the two-way center left-turn lane provides additional overflow storage. |                              |                        |                        |           |

**Table 19**  
**Vehicle Queuing and Left-Turn Pocket Storage Analysis – PM Peak Hour**

| Measurement                         | N 28th St & E Julian St |     | US 101 SB Off-Ramp & E Julian St | US 101 NB Ramps & McKee Rd | 24th St & E Santa Clara St | N 28th St & E Santa Clara St |     | US 101 NB Ramps & Alum Rock Av |
|-------------------------------------|-------------------------|-----|----------------------------------|----------------------------|----------------------------|------------------------------|-----|--------------------------------|
|                                     | NBL-T                   | WBL | NBL                              | EBL                        | WBL                        | SBL-T <sup>3</sup>           | EBL | NBL-T                          |
|                                     | PM                      | PM  | PM                               | PM                         | PM                         | PM                           | PM  | PM                             |
| <b>2015 Existing</b>                |                         |     |                                  |                            |                            |                              |     |                                |
| Cycle/Delay <sup>1</sup> (sec)      | 140                     | 140 | 146                              | 146                        | 80                         | 80                           | 80  | 70                             |
| Volume (vphpl)                      | 41                      | 31  | 53                               | 96                         | 140                        | 135                          | 18  | 161                            |
| Avg. Queue (veh./ln.)               | 1.6                     | 1.2 | 2.1                              | 3.9                        | 3.1                        | 3.0                          | 0.4 | 3.1                            |
| Avg. Queue <sup>2</sup> (ft./ln.)   | 40                      | 30  | 54                               | 97                         | 78                         | 75                           | 10  | 78                             |
| 95th % Queue (veh./ln.)             | 4                       | 3   | 5                                | 7                          | 6                          | 6                            | 2   | 6                              |
| 95th % Queue (ft./ln.)              | 100                     | 75  | 125                              | 175                        | 150                        | 150                          | 50  | 150                            |
| Storage (ft./ln.)                   | 250                     | 125 | 550                              | 175                        | 250                        | 400                          | 150 | 250                            |
| Adequate (Y/N)                      | Y                       | Y   | Y                                | Y                          | Y                          | Y                            | Y   | Y                              |
| <b>2015 Existing Plus Project</b>   |                         |     |                                  |                            |                            |                              |     |                                |
| Cycle/Delay <sup>1</sup> (sec)      | 140                     | 140 | 146                              | 146                        | 80                         | 80                           | 80  | 70                             |
| Volume (vphpl)                      | 156                     | 110 | 85                               | 142                        | 189                        | 359                          | 75  | 190                            |
| Avg. Queue (veh./ln.)               | 6.1                     | 4.3 | 3.4                              | 5.8                        | 4.2                        | 8.0                          | 1.7 | 3.7                            |
| Avg. Queue <sup>2</sup> (ft./ln.)   | 152                     | 107 | 86                               | 144                        | 105                        | 199                          | 42  | 92                             |
| 95th % Queue (veh./ln.)             | 10                      | 8   | 7                                | 10                         | 8                          | 13                           | 4   | 7                              |
| 95th % Queue (ft./ln.)              | 250                     | 200 | 175                              | 250                        | 200                        | 325                          | 100 | 175                            |
| Storage (ft./ln.)                   | 250                     | 125 | 550                              | 175                        | 250                        | 400                          | 150 | 250                            |
| Adequate (Y/N)                      | Y                       | N   | Y                                | N                          | Y                          | Y                            | Y   | Y                              |
| <b>2025 Background</b>              |                         |     |                                  |                            |                            |                              |     |                                |
| Cycle/Delay <sup>1</sup> (sec)      | 140                     | 140 | 146                              | 146                        | 80                         | 80                           | 80  | 70                             |
| Volume (vphpl)                      | 41                      | 31  | 55                               | 96                         | 144                        | 135                          | 18  | 161                            |
| Avg. Queue (veh./ln.)               | 1.6                     | 1.2 | 2.2                              | 3.9                        | 3.2                        | 3.0                          | 0.4 | 3.1                            |
| Avg. Queue <sup>2</sup> (ft./ln.)   | 40                      | 30  | 56                               | 97                         | 80                         | 75                           | 10  | 78                             |
| 95th % Queue (veh./ln.)             | 4                       | 3   | 5                                | 7                          | 6                          | 6                            | 2   | 6                              |
| 95th % Queue (ft./ln.)              | 100                     | 75  | 125                              | 175                        | 150                        | 150                          | 50  | 150                            |
| Storage (ft./ln.)                   | 250                     | 125 | 550                              | 175                        | 250                        | 400                          | 150 | 250                            |
| Adequate (Y/N)                      | Y                       | Y   | Y                                | Y                          | Y                          | Y                            | Y   | Y                              |
| <b>2025 Background Plus Project</b> |                         |     |                                  |                            |                            |                              |     |                                |
| Cycle/Delay <sup>1</sup> (sec)      | 140                     | 140 | 146                              | 146                        | 80                         | 80                           | 80  | 70                             |
| Volume (vphpl)                      | 181                     | 119 | 74                               | 134                        | 209                        | 449                          | 79  | 195                            |
| Avg. Queue (veh./ln.)               | 7.0                     | 4.6 | 3.0                              | 5.4                        | 4.6                        | 10.0                         | 1.8 | 3.8                            |
| Avg. Queue <sup>2</sup> (ft./ln.)   | 176                     | 116 | 75                               | 136                        | 116                        | 249                          | 44  | 95                             |
| 95th % Queue (veh./ln.)             | 12                      | 8   | 6                                | 10                         | 8                          | 15                           | 4   | 7                              |
| 95th % Queue (ft./ln.)              | 300                     | 200 | 150                              | 250                        | 200                        | 375                          | 100 | 175                            |
| Storage (ft./ln.)                   | 250                     | 125 | 550                              | 175                        | 250                        | 400                          | 150 | 250                            |
| Adequate (Y/N)                      | N                       | N   | Y                                | N                          | Y                          | Y                            | Y   | Y                              |

**Notes:**

<sup>1</sup> Vehicle queue calculations based on cycle length for signalized intersections.

<sup>2</sup> Assumes 25 Feet Per Vehicle Queued

<sup>3</sup> The SB approach at this intersection has a shared LT-Thru lane with 150 feet of striping. However, N 28th Street provides 400 feet of vehicle storage space for the SB LT-Thru movement between Santa Clara Street and 5 Wounds Lane.

**Table 19, Continued**  
**Vehicle Queuing and Left-Turn Pocket Storage Analysis – PM Peak Hour**

| Measurement   | De La Cruz BI &<br>Central Expwy | Coleman Av &<br>Brokaw Rd |           | Coleman Av &<br>I-880 NB<br>Ramps | San Tomas<br>Expwy & El<br>Camino Real | Scott BI &<br>El Camino Real |
|---|----------------------------------|---------------------------|-----------|-----------------------------------|--|------------------------------|
|   | NBL<br>PM                        | NBL <sup>3</sup><br>PM    | EBL<br>PM | SBL<br>PM                         | WBL<br>PM                              | WBL<br>PM                    |
| <b>2015 Existing</b>  |                                  |                           |           |                                   |  |                              |
| Cycle/Delay <sup>1</sup> (sec)  | 190                              | 90                        | 90        | 130                               | 185                                    | 120                          |
| Volume (vphpl )   | 91                               | 197                       | 203       | 322                               | 139                                    | 243                          |
| Avg. Queue (veh./ln.)   | 4.8                              | 4.9                       | 5.1       | 11.6                              | 7.1                                    | 8.1                          |
| Avg. Queue <sup>2</sup> (ft./ln)  | 120                              | 123                       | 127       | 291                               | 179                                    | 203                          |
| 95th % . Queue (veh./ln.)   | 9                                | 9                         | 9         | 17                                | 12                                     | 13                           |
| 95th % . Queue (ft./ln)   | 225                              | 225                       | 225       | 425                               | 300                                    | 325                          |
| Storage (ft./ ln.)  | 350                              | 200+                      | 250       | 450                               | 325                                    | 375                          |
| Adequate (Y/N)  | Y                                | Y <sup>3</sup>            | Y         | Y                                 | Y                                      | Y                            |
| <b>2015 Existing Plus Project</b>   |                                  |                           |           |                                   |  |                              |
| Cycle/Delay <sup>1</sup> (sec)  | 190                              | 90                        | 90        | 130                               | 185                                    | 120                          |
| Volume (vphpl )   | 113                              | 294                       | 619       | 335                               | 152                                    | 268                          |
| Avg. Queue (veh./ln.)   | 6.0                              | 7.4                       | 15.5      | 12.1                              | 7.8                                    | 8.9                          |
| Avg. Queue <sup>2</sup> (ft./ln)  | 149                              | 184                       | 387       | 302                               | 195                                    | 223                          |
| 95th % . Queue (veh./ln.)   | 10                               | 12                        | 22        | 18                                | 13                                     | 14                           |
| 95th % . Queue (ft./ln)   | 250                              | 300                       | 550       | 450                               | 325                                    | 350                          |
| Storage (ft./ ln.)  | 350                              | 200+                      | 250       | 450                               | 325                                    | 375                          |
| Adequate (Y/N)  | Y                                | Y <sup>3</sup>            | <b>N</b>  | Y                                 | Y                                      | Y                            |
| <b>2025 Background</b>  |                                  |                           |           |                                   |  |                              |
| Cycle/Delay <sup>1</sup> (sec)  | 190                              | 90                        | 90        | 130                               | 185                                    | 120                          |
| Volume (vphpl )   | 117                              | 197                       | 203       | 500                               | 141                                    | 243                          |
| Avg. Queue (veh./ln.)   | 6.2                              | 4.9                       | 5.1       | 18.1                              | 7.2                                    | 8.1                          |
| Avg. Queue <sup>2</sup> (ft./ln)  | 154                              | 123                       | 127       | 451                               | 181                                    | 203                          |
| 95th % . Queue (veh./ln.)   | 11                               | 9                         | 9         | 25                                | 12                                     | 13                           |
| 95th % . Queue (ft./ln)   | 275                              | 225                       | 225       | 625                               | 300                                    | 325                          |
| Storage (ft./ ln.)  | 350                              | 200+                      | 250       | 450                               | 325                                    | 375                          |
| Adequate (Y/N)  | Y                                | Y <sup>3</sup>            | Y         | <b>N</b>                          | Y                                      | Y                            |
| <b>2025 Background Plus Project</b>   |                                  |                           |           |                                   |  |                              |
| Cycle/Delay <sup>1</sup> (sec)  | 190                              | 90                        | 90        | 130                               | 185                                    | 120                          |
| Volume (vphpl )   | 148                              | 284                       | 611       | 510                               | 154                                    | 262                          |
| Avg. Queue (veh./ln.)   | 7.8                              | 7.1                       | 15.3      | 18.4                              | 7.9                                    | 8.7                          |
| Avg. Queue <sup>2</sup> (ft./ln)  | 195                              | 178                       | 382       | 460                               | 198                                    | 218                          |
| 95th % . Queue (veh./ln.)   | 13                               | 12                        | 22        | 26                                | 13                                     | 14                           |
| 95th % . Queue (ft./ln)   | 325                              | 300                       | 550       | 650                               | 325                                    | 350                          |
| Storage (ft./ ln.)  | 350                              | 200+                      | 250       | 450                               | 325                                    | 375                          |
| Adequate (Y/N)  | Y                                | Y <sup>3</sup>            | <b>N</b>  | <b>N</b>                          | Y                                      | Y                            |
| <b>Notes:</b>   |                                  |                           |           |                                   |  |                              |
| <sup>1</sup> Vehicle queue calculations based on cycle length for signalized intersections.   |                                  |                           |           |                                   |  |                              |
| <sup>2</sup> Assumes 25 Feet Per Vehicle Queued   |                                  |                           |           |                                   |  |                              |
| <sup>3</sup> Although there is only about 200 feet of striping for the NB left-turn pocket, the two-way center left-turn lane provides additional overflow storage. |                                  |                           |           |                                   |  |                              |

## North 28<sup>th</sup> Street and Julian Street

The queuing analysis indicates that the existing storage capacity of the westbound left-turn pocket at the intersection of North 28<sup>th</sup> Street/Julian Street is adequate to serve the maximum vehicle queues that currently occur under 2015 Existing Conditions and would continue to occur under 2025 Background Conditions during the AM and PM peak hours of traffic. However, the maximum vehicle queues for this westbound left-turn pocket would exceed the existing vehicle storage capacity during both the AM and PM peak hours under 2015 Existing Plus Project and 2025 Background Plus Project Conditions. The westbound left-turn pocket provides approximately 125 feet of storage, for a capacity of only about 5 vehicles. Maximum vehicle queue lengths of 500 feet and 550 feet would occur during the AM peak hour under 2015 Existing Plus Project and 2025 Background Plus Project Conditions, respectively. A maximum vehicle queue length of 200 feet would occur during the PM peak hour under both 2015 Existing Plus Project and 2025 Background Plus Project Conditions. Extending the westbound left-turn pocket is not feasible, due to limited spacing between the US 101 southbound off-ramp and North 28<sup>th</sup> Street. There are no feasible improvements that could be implemented to increase the westbound left-turn pocket vehicle storage.

The queuing analysis also indicates that the maximum (95<sup>th</sup> percentile) vehicle queues for the northbound shared left-turn/through movement would exceed the existing vehicle storage capacity by two vehicles during the PM peak hour under 2025 Background Plus Project Conditions. However, a storage inadequacy of just two vehicles, based on the 95<sup>th</sup> percentile vehicle queue length, is not likely to cause any significant operational issues.

### Overall Intersection Operations

The current configuration of the North 28<sup>th</sup> Street/Julian Street intersection is currently inefficient and problematic. There are multiple intersections within close proximity, most notably the US 101 southbound off-ramp/McKee Road intersection, which contribute to its poor operation. While this intersection would operate at an acceptable level of service C during the AM peak hours under 2025 Background Plus Project Conditions, and the Project does not cause a significant impact based on the City of San Jose significance criteria, as mentioned above, the high westbound left turn volumes would result in long queues that would extend far into the westbound through lanes of the upstream intersection of McKee Road and the US 101 southbound ramps. The North 28<sup>th</sup> Street/Julian Street intersection would require improvements to operate more efficiently with the addition of project-generated traffic.

## US 101 Northbound Ramps and McKee Road

The queuing analysis indicates that the maximum vehicle queue for the northbound left-turn pocket (northbound off-ramp) at the US 101 Northbound Off-ramp/McKee Road intersection currently exceeds the existing vehicle storage capacity during the AM peak hour of traffic, and that this condition would continue to occur under 2015 Existing Plus Project, 2025 Background, and 2025 Background Plus Project Conditions. The northbound left-turn pocket provides about 300 feet of vehicle storage for a capacity of up to 12 vehicles. A maximum vehicle queue length of 450 feet would occur during the AM peak hour under 2025 Background Plus Project Conditions as a result of the Project. Converting the middle shared through/right-turn lane to a shared L-T-R lane would help provide additional vehicle storage to accommodate the estimated future left-turn volumes.

The queuing analysis indicates that the existing storage capacity of the eastbound left-turn pocket (left-turn onto the US 101 northbound on-ramp) is adequate to serve the maximum vehicle queues that currently occur and would continue to occur under 2025 Background Conditions during both the AM and PM peak hours of traffic. However, the maximum vehicle queues for this eastbound left-turn pocket would exceed the existing vehicle storage capacity during the PM peak hour under 2015 Existing Plus Project and 2025 Background Plus Project Conditions. The eastbound left-turn pocket provides approximately 175 feet of storage for a capacity of about 7 vehicles. A maximum vehicle queue length of 250 feet would occur during the PM peak hour under both 2015 Existing Plus Project and 2025 Background Plus Project Conditions. Extending this left-turn pocket is not feasible due to the presence of back-to-back left-turn pockets.

## North 28<sup>th</sup> Street and Santa Clara Street

The queuing analysis indicates that the existing storage capacity of the eastbound left-turn pocket is adequate to serve the maximum vehicle queues that currently occur under 2015 Existing Conditions and would continue to



occur under 2025 Background Conditions during the AM and PM peak hours of traffic. The eastbound left-turn pocket provides approximately 150 feet of storage for a capacity of about 6 vehicles. A maximum vehicle queue length of 225 feet would occur during the AM peak hour under both 2015 Existing Plus Project and 2025 Background Plus Project Conditions. Extending the eastbound left-turn pocket is not feasible due to limited spacing between North 27<sup>th</sup> Street and North 28<sup>th</sup> Street. Adding a second eastbound left-turn pocket is not feasible without acquiring additional right-of-way. Therefore, there are no feasible improvements that could be implemented to increase the eastbound left-turn pocket vehicle storage.

### **Coleman Avenue and Brokaw Road**

The queuing analysis indicates that the existing storage capacity of the eastbound left-turn pocket is adequate to serve the maximum vehicle queues that currently occur under 2015 Existing Conditions and would continue to occur under 2025 Background Conditions during the AM and PM peak hours of traffic. However, the maximum vehicle queues for this eastbound left-turn pocket would exceed the existing vehicle storage capacity during the PM peak hour under 2015 Existing Plus Project and 2025 Background Plus Project Conditions. The eastbound left-turn pocket provides approximately 250 feet of storage for a capacity of about 10 vehicles. A maximum vehicle queue length of 550 feet would occur during the PM peak hour under both 2015 Existing Plus Project and 2025 Background Plus Project Conditions. Based on the intersection level of service analysis, the Project would result in a significant impact at this intersection. The proposed mitigation includes adding a shared eastbound left-turn/through lane. With this improvement, the eastbound left-turn lane and shared left-turn/through lane together would provide adequate storage to accommodate the maximum vehicle queues that would occur under 2015 Existing Plus Project and 2025 Background Plus Project scenarios.

### **Coleman Avenue and I-880 Northbound Ramps**

The queuing analysis indicates that the existing storage capacity of the southbound dual left-turn pocket (left-turn onto the I-880 northbound on-ramp) is adequate to serve the maximum vehicle queues that currently occur under 2015 Existing Conditions and that would occur under 2015 Existing Plus Project Conditions during both the AM and PM peak hours of traffic. However, the maximum vehicle queues for this southbound left-turn pocket would exceed the existing vehicle storage capacity during the PM peak hour under 2025 Background and 2025 Background Plus Project Conditions. The southbound left-turn pocket provides approximately 450 feet of storage per lane for a capacity of about 18 vehicles per lane. A maximum vehicle queue length of 625 feet per lane is estimated to occur during the PM peak hour under 2025 Background Conditions, and a maximum vehicle queue length of 650 feet per lane is estimated to occur during the PM peak hour under 2025 Background Plus Project Conditions. Extending the southbound left-turn pocket is not feasible because the I-880 overpass is not sufficiently wide to accommodate this improvement (narrows at this point). The existing bike lanes would need to be removed in order to extend this left-turn pocket, which is not consistent with VTA's policies to promote bicycling opportunities.

## **Freeway On-Ramp Meter Analysis**

An analysis of metered freeway on-ramps that would experience increases in traffic as a result of the Transit-Oriented Joint Development at Alum Rock/28<sup>th</sup> Street and Santa Clara Stations was conducted to identify the effect the additional project traffic would have on the vehicle queues at the on-ramps during the AM and PM peak commute periods. In general, only the freeway on-ramps that would experience more than 10 additional trips per lane from the Project during one of the peak hours were analyzed. Those freeway on-ramps where the Project would add a substantial amount of traffic (more than 10 net peak hour trips per lane) were evaluated; each of these ramps is currently metered or is expected to be metered in the future. The freeway on-ramps that were evaluated are listed below:

- US 101 southbound on-ramp from McKee Road – PM peak hour
- US 101 southbound loop on-ramp from WB Santa Clara Street/Alum Rock Avenue – PM peak hour
- I-880 southbound diagonal on-ramp from southbound Coleman Avenue – PM peak hour

The I-880 southbound diagonal on-ramp from southbound Coleman Avenue is currently metered. The existing maximum vehicle queue that occurs at this metered on-ramp during the PM peak hour was measured in the field. The metering lights at both US 101 freeway on-ramps listed above – the US 101 southbound on-ramp from

McKee Road and the US 101 southbound loop on-ramp from westbound Santa Clara Street/Alum Rock Avenue – are not currently operating. Therefore, no measurable queues are currently experienced at these ramp locations. However, since the metering lights on these on-ramps likely will be operational in the future, and because the Project would add more than 10 net trips per lane to these on-ramps, the vehicle queues were estimated at these on-ramps for 2025 Background and 2025 Background Plus Project Conditions.

### **US 101 Southbound On-Ramp from McKee Road**

The US 101 southbound on-ramp from McKee Road currently serves a high volume of PM peak hour traffic. Approved projects in the study area would increase the PM peak hour traffic volume by approximately 13 percent. Compared to 2025 Background Conditions, the Project would increase the traffic volume on the US 101 southbound on-ramp from McKee Road by just 9 percent under 2025 Background Plus Project Conditions.

### **US 101 Southbound Loop On-Ramp from Santa Clara Street/Alum Rock Avenue**

The US 101 southbound on-ramp from Santa Clara Street currently serves a high volume of PM peak hour traffic. Approved projects in the study area would add almost zero traffic to this on-ramp. Compared to 2025 Background Conditions, the Project would increase the traffic volume on the US 101 southbound on-ramp from McKee Road by approximately 16 percent under 2025 Background Plus Project Conditions.

Table 20 shows the maximum vehicle queues at the metered on-ramps under 2015 Existing, 2015 Existing Plus Project, 2025 Background, and 2025 Background Plus Project Conditions for the PM peak hour of traffic. Note that none of the metered on-ramps in the vicinity of the Alum Rock/28<sup>th</sup> Street or Santa Clara Stations would experience substantial increases in trips as a result of the Project during the AM peak hour of traffic under Existing Plus Project or Background Plus Project Conditions. As shown in the table, both US 101 on-ramps that were evaluated are expected to experience overflow conditions in the future. Because the metering lights are not currently operating, there are no existing vehicle queues on these on-ramps. Therefore, future vehicle queuing estimates could not be calculated for these on-ramps, since there are no existing data available to calibrate the results. It can be assumed, however, that both US 101 southbound on-ramps would experience vehicle queuing issues in the future due to the high volume of traffic using these on-ramps. These on-ramps most likely would not provide adequate vehicle storage to accommodate the future vehicle queues that would occur. As a result, the vehicle queues would back up onto the roadways serving the on-ramps (e.g., McKee Road and Santa Clara Street/Alum Rock Avenue), which likely would result in significant operational issues.

### **I-880 Southbound Diagonal On-Ramp from Southbound Coleman Avenue**

The I-880 southbound on-ramp from southbound Coleman Avenue currently has adequate storage space for the number of vehicles observed on that ramp during the PM peak hour. It is projected to have adequate storage space for the number of vehicles projected to use that ramp under 2015 Existing Plus Project Conditions and 2025 Background Plus Project Conditions.

**Table 20**  
**Vehicle Queuing and Storage at Metered Freeway On-Ramps**

| Freeway Ramp   | Total Storage (vehicles) <sup>1</sup> | Total Storage (feet) | Volume and Queue Projections |         |        |                              |          |        |
|--|---------------------------------------|----------------------|------------------------------|---------|--------|------------------------------|----------|--------|
|  |                                       |                      | 2015 Existing Plus Project   |         |        | 2025 Background Plus Project |          |        |
|  |                                       |                      | 2015 Existing                | Project | Change | 2025 Background              | Project  | Change |
| <b><i>US 101</i></b>   |                                       |                      |                              |         |        |                              |          |        |
| US 101 SB On-Ramp from McKee Rd  | 32                                    | 800                  |                              |         |        |                              |          |        |
| PM Peak Hour Volume <sup>2</sup>   |                                       |                      | 1131                         | 1296    | 165    | 1273                         | 1391     | 118    |
| Projected Queue Length (in feet) <sup>3</sup>  |                                       |                      | ---                          | ---     |        | overflow                     | overflow |        |
| US 101 SB On-Ramp from WB Santa Clara St/Alum Rock Av  | 34                                    | 850                  |                              |         |        |                              |          |        |
| PM Peak Hour Volume <sup>2</sup>   |                                       |                      | 949                          | 1113    | 164    | 955                          | 1110     | 155    |
| Projected Queue Length (in feet) <sup>3</sup>  |                                       |                      | ---                          | ---     |        | overflow                     | overflow |        |
| <b><i>I-880</i></b>  |                                       |                      |                              |         |        |                              |          |        |
| I-880 SB Diagonal On-Ramp from SB Coleman Av   | 72                                    | 1800                 |                              |         |        |                              |          |        |
| PM Peak Hour Volume <sup>2</sup>   |                                       |                      | 709                          | 738     | 29     | 773                          | 790      | 17     |
| Observed Queue / Projected Queue Length (in feet) <sup>3</sup>   |                                       |                      | 200                          | 208     |        | 218                          | 223      |        |
| <b>Notes:</b>  |                                       |                      |                              |         |        |                              |          |        |
| <sup>1</sup> Total number of vehicles that can be stored within the ramp, assuming 25 feet per vehicle.  |                                       |                      |                              |         |        |                              |          |        |
| <sup>2</sup> Peak-hour ramp volume projections.  |                                       |                      |                              |         |        |                              |          |        |
| <sup>3</sup> Total length of queue (in feet), as calculated based on the ramp meter rate and projected traffic volumes.  |                                       |                      |                              |         |        |                              |          |        |
| <sup>4</sup> Currently, the ramp meter at these on-ramps is not operational during the PM peak hour, therefore, no measurable queues are currently experienced at these locations. |                                       |                      |                              |         |        |                              |          |        |

## Site Access

Since the site plans are at a conceptual level of design, a comprehensive analysis of site access, including truck loading activities, pedestrian access, and on-site circulation, will be prepared during final design. However, a general evaluation of site access and traffic operations was completed for the roadways that would provide access to the Transit-Oriented Joint Development at Alum Rock/28<sup>th</sup> Street Station based on the conceptual design. The details of the evaluation are described below.

### Alum Rock/28<sup>th</sup> Street Station

The site access evaluation for Alum Rock/28<sup>th</sup> Street Station is based on the station plans. Project-generated traffic would access the site via 5 Wounds Lane and E. St. James Street. Approximately one-half of project traffic would access the site via 5 Wounds Lane, and one-half would utilize E. St. James Street. 5 Wounds Lane would provide direct access to the residential parking structure and E. St. James Street would provide direct access to the BART Station parking structure. The office component of the Project would be accessible via either street. The traffic volumes that are estimated to occur at the N. 28<sup>th</sup> Street/5 Wounds Lane and N. 28<sup>th</sup> Street/E. St. James Street intersections under 2025 Background Plus Project Conditions are shown on the site plan (see Figure 31). Based on these traffic volumes, the intersection of N. 28<sup>th</sup> Street/5 Wounds Lane would operate at level of service B with 17.0 seconds of delay during the AM peak hour and level of service B with 19.0 seconds of delay during the PM peak hour. The intersection of N. 28<sup>th</sup> Street/E. St. James Street would operate at level of service C with 27.0 seconds of delays in the AM Peak hour and level of service C with 27.1 seconds of delay during the PM peak hour.

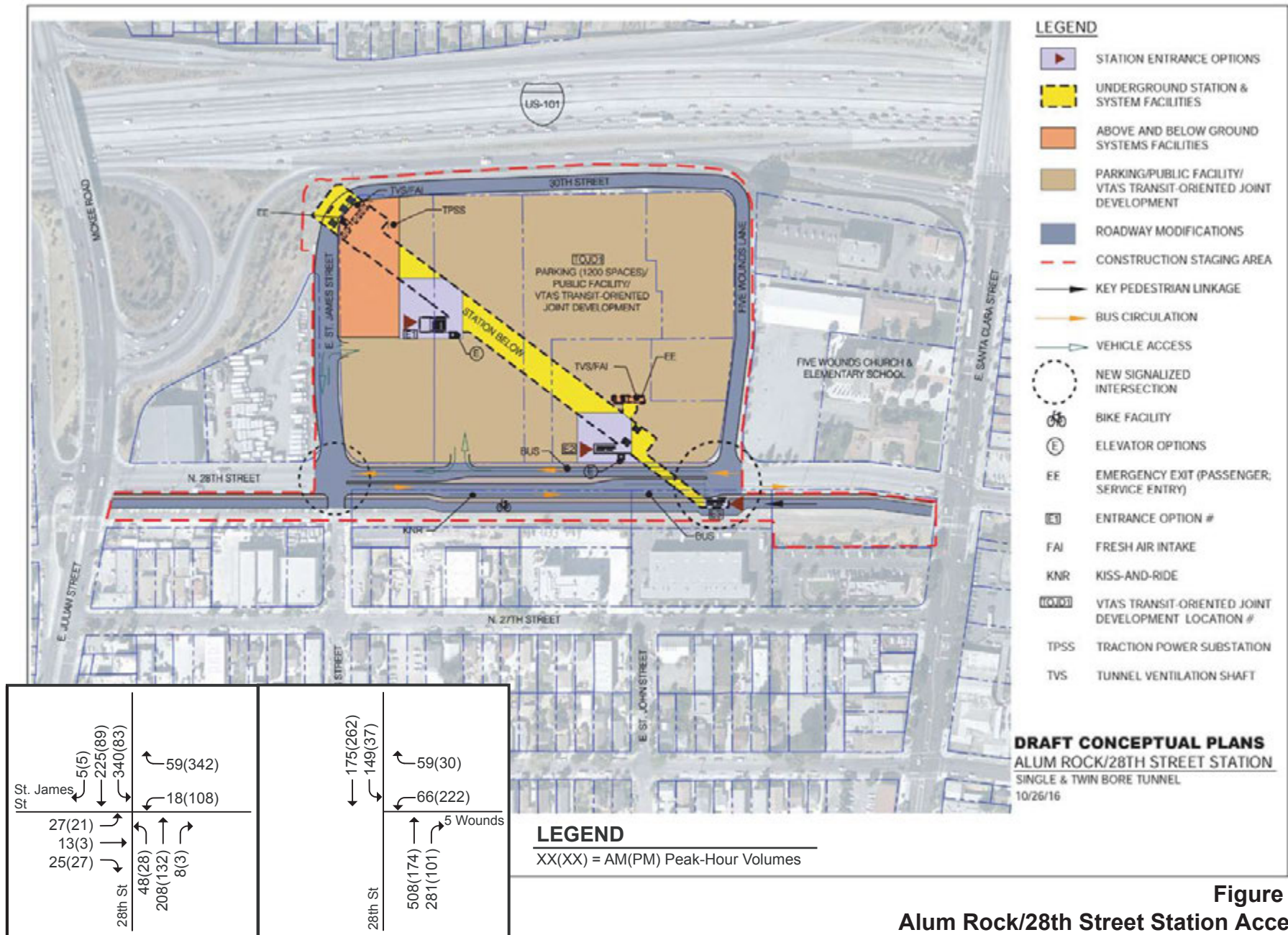

Figure 31  
 Alum Rock/28th Street Station Access



### **Queuing Analysis at the Alum Rock/28<sup>th</sup> Street Station Driveways**

Left-turn vehicle queuing at the future signalized intersections of N 28<sup>th</sup> Street/E St. James Street and N 28<sup>th</sup> Street/5 Wounds Lane was evaluated based on projected traffic volumes under 2015 Existing Plus Project and 2025 Background Plus Project Conditions. These intersections will provide direct access to the Alum Rock/28<sup>th</sup> Street BART Station and Transit-Oriented Joint Development in the future.

The left-turn pocket storage shown in the table for these future intersections is based on the results of the queuing analysis. Specifically, the recommended left-turn pocket storage shown in the table is based on the maximum (95<sup>th</sup> percentile) queue that was calculated.

The vehicle queue estimates, and a tabulated summary of the findings are provided in Table 21.

**Table 21**  
**Vehicle Queuing and Left-Turn-Pocket Storage Analysis at the Future N. 28<sup>th</sup> Street Intersections**

| Measurement   | N 28th St & St. James St |     |     |     | N 28th St & 5 Wounds Ln |     |     |     |
|---|--------------------------|-----|-----|-----|-------------------------|-----|-----|-----|
|   | SBL                      |     | WBL |     | SBL                     |     | WBL |     |
|   | AM                       | PM  | AM  | PM  | AM                      | PM  | AM  | PM  |
| <b>2015 Existing Plus Project</b>   |                          |     |     |     |                         |     |     |     |
| Cycle/Delay <sup>1</sup> (sec)  | 70                       | 70  | 70  | 70  | 80                      | 80  | 80  | 80  |
| Volume (vphpl )   | 243                      | 80  | 5   | 94  | 161                     | 41  | 69  | 210 |
| Avg. Queue (veh/ln.)  | 4.7                      | 1.6 | 0.1 | 1.8 | 3.6                     | 0.9 | 1.5 | 4.7 |
| Avg. Queue <sup>2</sup> (ft./ln)  | 118                      | 39  | 2   | 46  | 89                      | 23  | 38  | 117 |
| 95th % . Queue (veh/ln.)  | 9                        | 4   | 1   | 4   | 7                       | 3   | 4   | 8   |
| 95th % . Queue (ft./ln)   | 225                      | 100 | 25  | 100 | 175                     | 75  | 100 | 200 |
| Storage <sup>3</sup> (ft./ ln.)   | 275                      | 275 | 175 | 175 | 200                     | 200 | 250 | 250 |
| Adequate (Y/N)  | Y                        | Y   | Y   | Y   | Y                       | Y   | Y   | Y   |
| <b>2025 Background Plus Project</b>   |                          |     |     |     |                         |     |     |     |
| Cycle/Delay <sup>1</sup> (sec)  | 70                       | 70  | 70  | 70  | 80                      | 80  | 80  | 80  |
| Volume (vphpl )   | 340                      | 83  | 18  | 108 | 149                     | 37  | 66  | 222 |
| Avg. Queue (veh/ln.)  | 6.6                      | 1.6 | 0.4 | 2.1 | 3.3                     | 0.8 | 1.5 | 4.9 |
| Avg. Queue <sup>2</sup> (ft./ln)  | 165                      | 40  | 9   | 53  | 83                      | 21  | 37  | 123 |
| 95th % . Queue (veh/ln.)  | 11                       | 4   | 1   | 5   | 7                       | 3   | 4   | 9   |
| 95th % . Queue (ft./ln)   | 275                      | 100 | 25  | 125 | 175                     | 75  | 100 | 225 |
| Storage <sup>3</sup> (ft./ ln.)   | 275                      | 275 | 175 | 175 | 200                     | 200 | 250 | 250 |
| Adequate (Y/N)  | Y                        | Y   | Y   | Y   | Y                       | Y   | Y   | Y   |
| <b>2035 Cumulative Plus Project</b>   |                          |     |     |     |                         |     |     |     |
| Cycle/Delay <sup>1</sup> (sec)  | 70                       | 70  | 70  | 70  | 80                      | 80  | 80  | 80  |
| Volume (vphpl )   | 361                      | 89  | 22  | 194 | 127                     | 55  | 29  | 254 |
| Avg. Queue (veh/ln.)  | 7.0                      | 1.7 | 0.4 | 3.8 | 2.8                     | 1.2 | 0.6 | 5.6 |
| Avg. Queue (ft./ln)   | 175                      | 43  | 11  | 94  | 71                      | 31  | 16  | 141 |
| 95th % . Queue (veh/ln.)  | 12                       | 4   | 2   | 7   | 6                       | 3   | 2   | 10  |
| 95th % . Queue (ft./ln)   | 300                      | 100 | 50  | 175 | 150                     | 75  | 50  | 250 |
| Storage (ft./ ln.)  | 275                      | 275 | 175 | 175 | 200                     | 200 | 250 | 250 |
| Adequate (Y/N)  | Y                        | Y   | Y   | Y   | Y                       | Y   | Y   | Y   |
| <b>Notes:</b>   |                          |     |     |     |                         |     |     |     |
| <sup>1</sup> Vehicle queue calculations based on recommended cycle lengths for the future signalized intersections. |                          |     |     |     |                         |     |     |     |
| <sup>2</sup> Assumes 25 Feet Per Vehicle Queued   |                          |     |     |     |                         |     |     |     |
| <sup>3</sup> Recommended lengths for future single left-turn pockets are shown.                                     |                          |     |     |     |                         |     |     |     |

## Santa Clara Station

Vehicular access at Santa Clara Station would be provided via the intersection of Coleman Avenue and Brokaw Road. Intersection level of service, potential impacts, and proposed mitigation measures for this intersection were discussed in Chapter 4, in the sections on “2025 Background Plus Project Conditions Intersection Level of Service” and “Intersection Impacts and Proposed Mitigation Measures.” In addition, the queuing analysis in an earlier section of this Chapter (“Intersection Operations Analysis”) provides an analysis of the left-turn pocket storage at this intersection.

## Transit Services

The Project consists of the 6-mile-long extension of the BART system from the Berryessa neighborhood in San Jose through downtown San Jose and west into Santa Clara and includes four new BART stations. Therefore, the Project is a transit project and represents a substantial improvement to the transit system in the study area. Additionally, the Project is being integrated with VTA’s light rail and bus systems and would not adversely affect transit facilities or services within the Cities of San Jose or Santa Clara in the vicinity of the BART rail alignment, the proposed BART stations, or the Transit-Oriented Joint Development sites at the stations.

## Alum Rock/28<sup>th</sup> Street Station

The City of San Jose’s General Plan identifies the transit commute mode split target as “at least 20 percent” for the year 2040. Since the Project includes providing BART service to the neighborhood surrounding the Alum Rock/28<sup>th</sup> Street Station and constructing Transit-Oriented Joint Development on top of or next to the Alum Rock/28<sup>th</sup> Street Station, the Project would be expected to contribute to the attainment of that mode split target.

## Santa Clara Station

The City of Santa Clara’s General Plan identifies a Santa Clara Station Focus Area, which is based on the Santa Clara Station Area Plan. The Santa Clara Station Area Plan has been cooperatively developed by the City Of Santa Clara, City of San Jose, and VTA, and covers 432 acres of land surrounding the existing Santa Clara Transit Center and the Phase II BART station. The Santa Clara BART Station would be situated at the center of the Santa Clara Station Focus Area. Within the Santa Clara Station Focus Area, pedestrian and bicycle circulation have priority. High-density development, including a mix of office and residential uses, in close proximity to transit services is a goal for this planning area. Another goal of the Santa Clara Station Focus Area is to provide a link between the Santa Clara Caltrain Station and other transit options throughout the City of Santa Clara and beyond.

The City of Santa Clara General Plan aims to support a coordinated regional transit system that includes BART, Amtrak, ACE, Caltrain, VTA LRT and bus services, and High Speed Rail facilities. Transit stops should be provided at safe and convenient locations to maximize ridership, including locations near employment centers and high-density residential developments.

The proposed Project is consistent with the goals and policies of the San Jose and Santa Clara General Plans.

## Pedestrian and Bicycle Facilities

Pedestrian facilities consist mostly of sidewalks along the streets in the vicinity of the rail alignment and proposed Alum Rock/28<sup>th</sup> Street and Santa Clara BART station areas. Crosswalks with pedestrian signal heads are located at all of the signalized intersections in the study areas. The overall network of sidewalks and crosswalks within the vicinity of the Project sites would provide good connectivity and provide pedestrians with safe routes between the Alum Rock/28<sup>th</sup> Street and Santa Clara Stations/TOJD sites and the surrounding land uses and transit services in the station areas.

## Alum Rock/28<sup>th</sup> Street Station

All new development projects in San Jose should encourage multi-modal travel, consistent with the goals of the City’s General Plan. It is the goal of the General Plan that all development projects accommodate and encourage the use of non-automobile transportation modes to achieve San Jose’s mobility goals and reduce vehicle trip generation and vehicle miles traveled. In addition, the adopted City Bike Master Plan establishes goals, policies



and actions to make bicycling a daily part of life in San Jose. The Master Plan includes designated bike lanes along all City streets, as well as on designated bike corridors. In order to further the goals of the City, pedestrian and bicycle facilities should be encouraged with new projects.

The City of San Jose's General Plan identifies the bicycle commute mode split target as 15 percent or more for the year 2040. This level of bicycle mode share is a reasonable goal for the Project, particularly if BART and LRT services are utilized in combination with bicycle commuting. As part of the reconstruction of N. 28<sup>th</sup> Street, the Project would accommodate the 5 Wounds Trail between East Santa Clara and Julian Streets.

With the exception of the west side and most of the east side of N, 28<sup>th</sup> Street, between McKee Road and East Santa Clara Street, and along some of the industrial areas north of the station site, sidewalks are currently found along all previously described local roadways in the Alum Rock/28<sup>th</sup> Street Station study area and along the local residential streets and collectors near the station site. Additionally, all signalized intersections in the vicinity of the Alum Rock/28<sup>th</sup> Street Station have marked crosswalks on all or most of the legs of the intersection, combined with pedestrian push buttons and pedestrian signal heads.

For pedestrians who may walk between the residential neighborhood east of US 101 and the BART station or between the TOJD sites at the Alum Rock/28<sup>th</sup> Street Station and the VTA bus routes along King Road, there are continuous sidewalks and crosswalks along Alum Rock Avenue, including pedestrian push buttons and signal heads for the crosswalks on the US 101 on- and off-ramps, at 33<sup>rd</sup> Street, and at King Road. There are also continuous sidewalks and crosswalks along McKee Road between 28<sup>th</sup> Street and King Road, including pedestrian push buttons and signal heads for the crosswalks on the US 101 on- and off-ramps, at 33<sup>rd</sup> Street, and at King Road.

However, although the pedestrian facilities in the vicinity of the Alum Rock/28<sup>th</sup> Street Station are adequate as described above, the area is not an especially pedestrian-friendly environment at present. There are locations, such as the crosswalks near the US 101 on- and off-ramps, where walking is not as comfortable as it could be. The City of San Jose plans to improve the pedestrian environment in this area through its ongoing efforts to promote greater usage of alternative modes. With the proposed Project, a pedestrian connection along the south side of the Alum Rock/28<sup>th</sup> Street Station area at N. 28<sup>th</sup> Street from E. Santa Clara Street would be provided. This pedestrian connection, which would include amenities such as street trees, wide sidewalks, bicycle facilities, and pedestrian-scaled lighting, would link the station entrances with buses and BRT operating on E. Santa Clara Street/Alum Rock Avenue, enhancing connectivity of pedestrian facilities surrounding the station. Additionally, the Project would add sidewalks along both sides of N. 28<sup>th</sup> Street and around the perimeter of the project site. The Project would also provide crosswalks at the signalized intersections of N. 28<sup>th</sup> Street/E. St James Street and N. 28<sup>th</sup> Street/5 Wounds Lane, including pedestrian push buttons and signal heads.

In combination with planned pedestrian/bicycle improvements in the study area, the Project pedestrian/bicycle improvements would help enhance pedestrian/bicycle facilities in the area. Therefore, the Project would improve connectivity and would not have a negative effect on bicycle or pedestrian facilities in the vicinity of Alum Rock/28<sup>th</sup> Street Station, and no additional improvements are necessary.

### **Schools Near Alum Rock/28<sup>th</sup> Street Station**

There are four schools located within an approximately one-half mile walk of Alum Rock/28<sup>th</sup> Street Station: 1) Cristo Rey San Jose Jesuit High School, located on the south side of 5 Wounds Lane adjacent to Five Wounds Portuguese National Church; 2) San Jose High School, located to the west on Julian Street and accessible via St. James Street; 3) Rocketship Discovery Prep (Grades K-5) located on Wooster Avenue north of Julian Street; and 4) Anne Darling Elementary School, just east of US 101 on the corner of McKee Avenue and 33<sup>rd</sup> Street.

VTA will work closely with these schools to implement a Safe Routes to Schools Program. Safe Routes to Schools is designed to decrease traffic and pollution and increase the health of children and the community as a whole. The program promotes walking and biking to school through education and incentives. The program also addresses the safety concerns of parents by encouraging greater enforcement of traffic laws, educating the public, and exploring ways to create safer streets. A comprehensive Safe Routes to Schools program will identify a focused area surrounding the schools, provide a map with the routes that children can take to school, and recommend improvements to routes if necessary.

## Santa Clara Station

All new development projects in Santa Clara should encourage alternative modes of travel that reduce air pollution, consistent with the goals of the City's General Plan. It is the goal of the City's General Plan that all development projects accommodate and encourage the use of non-automobile transportation modes, including biking and walking, to achieve Santa Clara's mobility goals and reduce vehicle miles traveled and greenhouse gas emissions.

Near Santa Clara Station, sidewalks are found along virtually all previously described local roadways in the study area, including both sides of Brokaw Road, and along the local residential streets and collectors, with the exception of portions of the east side of Lafayette Street between Reed Avenue and Central Expressway. Additionally, all signalized intersections in the vicinity of Santa Clara Station have marked crosswalks on all or most of the legs of the intersection, combined with pedestrian push buttons and pedestrian signal heads. However, there is less connectivity in the pedestrian facilities near the Santa Clara BART Station, due to the Caltrain tracks, the nearby Mineta San Jose International Airport, and the fact that some of the nearby streets serving industrial land uses do not include sidewalks.

There is a continuous sidewalk along the east side of De La Cruz Boulevard that connects with the sidewalk along Coleman Avenue, leading to the intersection at Brokaw Road where the Santa Clara BART Station would be located. However, the De La Cruz Boulevard overpass over El Camino Real and the Caltrain tracks and most portions of the interchange of De La Cruz Boulevard and Coleman Avenue do not include sidewalks. West of De La Cruz Boulevard, there is a bike and pedestrian bridge over the Caltrain tracks next to the Lafayette Street undercrossing. There is currently no convenient pedestrian access across the Caltrain tracks from the vicinity of the Santa Clara Caltrain Station on the west to the future Santa Clara BART Station on the east.

The Project would add sidewalks around the perimeter of the project site and bicycle facilities along both sides of Brokaw Road. An approximately 240-foot-long pedestrian tunnel will be constructed between the mezzanine level of the proposed Santa Clara BART Station and the existing Santa Clara Caltrain Station center platform. This pedestrian connection would link the BART station with other pedestrian and transit facilities to the west of the railroad tracks, enhancing connectivity of pedestrian facilities surrounding the station and transit services. Additionally, The Phase II Project will construct an approximately 175-foot-long pedestrian tunnel from the Santa Clara BART Station to a new BART plaza on Brokaw Road.

In combination with planned pedestrian/bicycle improvements in the study area, the Project's pedestrian/bicycle improvements would enhance pedestrian/bicycle facilities along Brokaw Road. Therefore, the project would improve connectivity and would not have a negative effect on bicycle or pedestrian facilities in the vicinity of the Santa Clara Station, and no additional improvements are necessary.

## Unsignalized Intersection Analysis

One of the study intersections is unsignalized: Lafayette Street and Harrison Street. Unlike signalized intersections, which typically represent constraint points for the roadway network, unsignalized intersections rarely limit the potential capacity of a roadway. The Cities of San Jose and Santa Clara have not established significance thresholds for unsignalized intersections.

The need for signalization of unsignalized intersections is assessed based on the Peak Hour Volume Warrant (Warrant 3) described in the *Manual on Uniform Traffic Control Devices (MUTCD 2014 Edition, Part 4)*. This method makes no evaluation of intersection level of service, but simply provides an indication whether vehicular peak hour traffic volumes are, or would be, sufficient to justify installation of a traffic signal. Intersections that meet the peak hour warrant are subject to further analysis before determining that a traffic signal is necessary. Additional analysis may include unsignalized level of service analysis and/or operational analysis such as evaluating vehicle queuing and intersection safety. For this reason, the determination of appropriate improvements to unsignalized intersections is frequently based on professional judgment. Other types of traffic control devices, signage, or geometric changes may be preferable based on existing field conditions and intersection location/spacing.

## Signal Warrant

A peak hour signal warrant check (*MUTCD 2014 Edition*, Part 4, Warrant 3) was performed for the unsignalized study intersection of Lafayette Street and Harrison Street to determine whether signalization would be justified on the basis of Project peak hour traffic volumes. The analysis revealed that the peak hour volume warrant would not be satisfied at the unsignalized intersection during either the AM or PM peak hour of traffic under any of the traffic scenarios. The signal warrant worksheets are included in Appendix F.

## Bus Transit Vehicle Delay

The increase in Project traffic on roadways where bus transit service is provided could result in increased congestion and affect transit operations. The increase in congestion delay could have a negative effect on ridership and may result in requiring additional buses to maintain the frequency of service of these routes. There are four transit corridors where the increase in Project traffic could affect bus travel times:

1. Julian Street / McKee Road Corridor (Alum Rock/28<sup>th</sup> Street Site)
2. Alum Rock Avenue / Santa Clara Street Corridor (Alum Rock/28<sup>th</sup> Street Site)
3. Coleman Avenue / Central Expressway Corridor (Santa Clara Site)
4. Alameda / El Camino Corridor (Santa Clara Site)

These transit corridors and the study intersections along these corridors are shown on Figure 32. The Julian / McKee corridor is served by VTA Route 64. In the Alum Rock / Santa Clara corridor, VTA operates Routes 22, 522, and future Route 523. Near the Santa Clara Station, Route 304 provides service along the Coleman / Central Expressway corridor only during peak periods and only in the peak direction: northbound in the morning peak and southbound during the afternoon peak. VTA bus routes 22 and 522 also serve the Alameda / El Camino Corridor.

In order to determine the potential Project impacts on the bus travel times on these routes, the intersection delay for the approaches in which the buses are traveling were obtained from the level of service calculation sheets at each study intersection that is part of the route. The sum of intersection delay that the buses would experience at each of the study intersections was calculated under 2025 Background and 2025 Background Plus Project Conditions for both the AM and PM peak hours. Table 22 below presents the delay that the buses would experience in each corridor under 2025 Background and 2025 Background Plus Project conditions.

The approximate one-way travel time estimated by the VTA travel demand forecasting model for the year 2025, from the beginning to the end of the route for the aforementioned bus lines that serve these corridors is as follows:

|            |  |
|------------|--|
| Route 64:  | 70 minutes (Julian / McKee Corridor)                                   |
| Route 22:  | 135 minutes (Alum Rock / Santa Clara and Alameda / El Camino Corridor) |
| Route 522: | 100 minutes (Alum Rock / Santa Clara and Alameda / El Camino Corridor) |
| Route 304: | 85 minutes (Coleman / Central Corridor)                                |
| Route 523: | 63 minutes (Alum Rock / Santa Clara Corridor)                          |

As shown in Table 22, the additional Project traffic would have very little impact on transit travel time in corridors 1, 2, and 4. Bus travel time in these corridors would slightly increase or decrease with the Project. Travel time for buses would increase by a larger amount in the Coleman / Central Expressway corridor, where the Project would add a large amount of traffic. Mitigation measures have been proposed at the Coleman intersections, so the change in travel time for this corridor is presented both with and without the mitigation measures. Without the mitigation measures, the increased travel time for Route 304 would be about 35 seconds during the AM peak hour and 87 seconds during the PM peak hour. With the proposed mitigations at the Coleman intersections at Brokaw Road and at the I-880 southbound ramp, the bus travel time under 2025 Background Plus Project Mitigated Conditions would be shorter by 81 seconds in the morning peak hour and by 10 seconds in the afternoon peak hour compared to the intersection delay the buses would experience under 2025 Background Conditions.

Although there is no threshold of significance to determine if the Project would create a significant impact on transit operations, based on the travel time analysis presented above, the Project would not have an adverse

effect on transit operations or ridership of the bus routes that serve the corridors near the Alum Rock/28<sup>th</sup> Street and Santa Clara Stations.

**Table 22**  
**Bus Delay at Corridor Study Intersections**

| Transit Corridor   | Intersection Delay in seconds<br>(NB/EB) |                                    |                                     | Intersection Delay in seconds<br>(SB/WB) |                                    |                                     |
|--|--|------------------------------------|-------------------------------------|--|------------------------------------|-------------------------------------|
|  | 2025<br>Background                       | 2025<br>Background<br>Plus Project | Increase in<br>Travel Time<br>(sec) | 2025<br>Background                       | 2025<br>Background<br>Plus Project | Increase in<br>Travel Time<br>(sec) |
| <b>AM Peak Hour</b>  |  |                                    |                                     |  |                                    |                                     |
| 1. Julian / McKee  | 225                                      | 234                                | 9                                   | 179                                      | 184                                | 5                                   |
| 2. Alum Rock / Santa Clara   | 220                                      | 218                                | -2                                  | 182                                      | 187                                | 5                                   |
| 3. Coleman / Central <sup>1</sup>  | 968                                      | 1003/887                           | 35/-81                              | N.A.                                     | N.A.                               | N.A.                                |
| 4. Alameda / El Camino   | 323                                      | 321                                | -2                                  | 338                                      | 335                                | -3                                  |
| <b>PM Peak Hour</b>  |  |                                    |                                     |  |                                    |                                     |
| 1. Julian / McKee  | 198                                      | 215                                | 18                                  | 161                                      | 173                                | 12                                  |
| 2. Alum Rock / Santa Clara   | 223                                      | 226                                | 3                                   | 236                                      | 237                                | 1                                   |
| 3. Coleman / Central <sup>1</sup>  | N.A.                                     | N.A.                               | N.A.                                | 751                                      | 838/741                            | 87/-10                              |
| 4. Alameda / El Camino   | 362                                      | 360                                | -2                                  | 347                                      | 339                                | -8                                  |
| <sup>1</sup> VTA Route 304 (Coleman / Central corridor) operates only in the peak direction. There is no southbound service in the AM Peak Hour or northbound service in the PM Peak Hour. For the "Plus Project" scenarios in this corridor, mitigation measures have been proposed. XX/YY: XX is the bus delay without the mitigation measures and YY is the bus delay with the mitigation measures. |  |                                    |                                     |  |                                    |                                     |

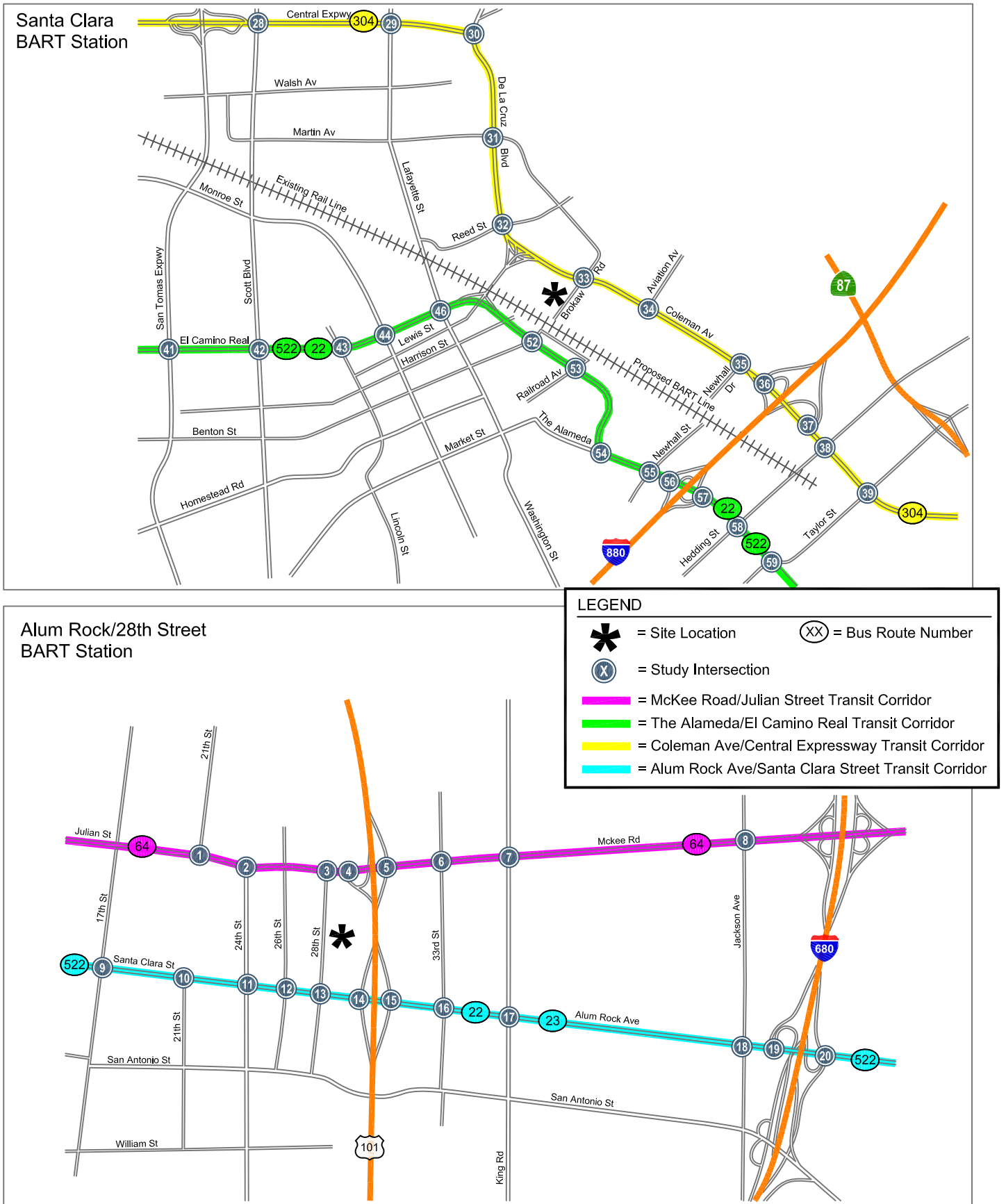

**Figure 32**  
**Transit Corridors Near the Transit-Oriented Joint Development Sites**



## Vehicle Miles Traveled

The preparation of Transportation Impact Analyses in the past has relied to a great extent on evaluation of Level of Service (LOS) at intersections and on freeways to determine whether a proposed project would have any significant traffic impacts. However, recent trends in the transportation planning field have expanded the range of metrics to be evaluated beyond Level of Service, in order to better capture the potential impacts of a project on other modes of transportation and on the greenhouse gases associated with vehicular travel.

Pursuant to Senate Bill 743, the Governor's Office of Planning and Research (OPR) released a *Draft of Updates to the CEQA Guidelines* in August 2014, which proposes Vehicle Miles Traveled (VMT) as the replacement metric for LOS in the context of CEQA. While OPR emphasizes that a lead agency has the discretionary authority to establish thresholds of significance, the *Draft of Updates* suggests criteria that indicate when a project may have a significant, or less than significant, transportation impact on the environment. For instance, a project that results in VMTs greater than the regional average for the land use type (e.g. residential, employment, commercial) may indicate a significant impact. Alternatively, a project may have a less than significant impact if it is located within 0.5 mile of an existing major transit stop, or results in a net decrease in VMTs compared to existing conditions.

The public comment period on OPR's *Draft of Updates* ended in November 2014, and on May 1, 2015 OPR released the *Summary of Feedback*. It is anticipated that further revisions to the *Draft of Updates* will be forthcoming prior to adoption of amendments to the CEQA Guidelines. The revised CEQA guidelines are still in draft form and it is anticipated that they will undergo further changes as a result of significant public input. Since OPR has not yet adopted new CEQA Guidelines for the alternative criteria to LOS, the adopted significance criteria for study intersections in the City of San Jose, the City of Santa Clara, and VTA's CMP still remain applicable to the scenarios in this TIA. However, examination of VMT and VMT Per Capita is consistent with the anticipated changes to the CEQA Guidelines.

For purposes of looking at the effect of the Project on travel associated with land use activities in Santa Clara County, Average Daily Vehicle Miles Traveled and Vehicle Miles Traveled Per Capita were analyzed under No Project and Plus Project conditions in 2015, 2025 and 2035.

Vehicle miles traveled (VMT) refers to the number of Santa Clara County-based vehicle trips multiplied by their trip distances. Santa Clara County trips are defined as trips with one or both "trip ends" in the County. The average daily weekday VMT's were calculated for 2015 Existing, 2025 Background, and 2035 Cumulative conditions, with and without the Project. VMT Per Capita is a common metric to analyze and compare travel characteristics between alternatives. The VMT Per Capita metric is represented by VMT as described above, divided by "day population". The day population is defined as the sum of the number of residents of the County plus the working population, or jobs, in the County. Mathematically,  $VMT\ Per\ Capita = \frac{Daily\ Trips \times Distance}{Population + Jobs}$ . The average daily VMT and VMT Per Capita are presented in Table 23.

**Table 23**  
**Average Daily VMT and VMT Per Capita for Santa Clara County-Based Trips**

|  | <u>2015 Existing</u> |              | <u>2025 Background</u> |              | <u>2035 Cumulative</u> |              |
|--|----------------------|--------------|------------------------|--------------|------------------------|--------------|
|  | No Project           | Plus Project | No Project             | Plus Project | No Project             | Plus Project |
| Daily VMT  | 51,893,183           | 51,795,427   | 54,981,379             | 54,905,065   | 59,777,409             | 59,703,751   |
| Households   | 640,435              | 640,935      | 711,241                | 711,741      | 781,011                | 781,511      |
| Total Population   | 1,852,676            | 1,854,247    | 2,061,059              | 2,062,630    | 2,267,232              | 2,268,803    |
| Total Jobs   | 1,010,252            | 1,013,652    | 1,110,668              | 1,114,068    | 1,231,164              | 1,234,564    |
| <b>VMT per Capita</b>  | <b>18.13</b>         | <b>18.06</b> | <b>17.33</b>           | <b>17.28</b> | <b>17.09</b>           | <b>17.04</b> |
| <b>Notes:</b>  |                      |              |                        |              |                        |              |
| <b>VMT Per Capita = Daily Trips x Distance / (Population + Jobs)</b> |                      |              |                        |              |                        |              |



As shown in the table, Average Daily VMT and VMT Per Capita are projected to decrease under Plus Project conditions in all three forecast years. This result makes sense, since many travelers that would be making trips in automobiles under No Project conditions would shift to BART under Plus Project conditions, reducing the number of vehicles on the road and the resulting number of miles traveled. The shift to BART would result both from the general mode shift due to the Phase II extension (as described in the “BART Extension Only TIA”) and from the Transit-Oriented Joint Development component of the Project. Since the TOJD sites would be literally on top of or next to the proposed BART stations, a larger percentage of the residents and employees who live and work there would likely use transit regularly than the average transit usage for these land uses in Santa Clara County. In addition, the average trip length would slightly decrease over time, which could be the result of a more balanced relationship between jobs and housing (or workers) in the region, and also possibly because the ABAG Projections are focused on developing growth areas near rail stations and along major transit corridors in an effort to increase transit use -- which would therefore reduce automobile travel. The Transit-Oriented Joint Development component of the Project is an example of the type of transit-oriented development envisioned by the ABAG Projections.

## Parking Analysis

Revisions to the significance thresholds for CEQA that became effective on January 1, 2010, eliminated effects on parking. The revisions to the CEQA thresholds were based on the decision in *San Franciscans Upholding the Downtown Plan v. City & County of SF*, 102 Cal.App.4th 65 (Sept. 30, 2002), in which the court ruled that parking deficits are an inconvenience to drivers but not a significant physical impact on the environment. As a result of this change to the State CEQA Guidelines, VTA adopted new significance thresholds that did not include the effects of parking on November 4, 2010.

Parking conditions evolve over time as people alter their modes and patterns of travel in response to changing land uses and transportation options. The availability of parking spaces is not part of the permanent physical environment subject to environmental review. Therefore, the loss of parking spaces by itself or the generation of parking demand by itself are not considered a direct significant impact on the physical environment in this TIA. However, parking losses caused by a project or parking demand generated by a project in excess of the parking provided could result in a significant indirect impact on the environment if drivers circling for parking cause significant secondary effects on traffic operations or air quality. The following discussion of parking is for information purposes only for CEQA and as background to the evaluation of any secondary effects on traffic operations and air quality.

### Alum Rock/28<sup>th</sup> Street Station

The amount of BART parking demand and supply associated with park-and-ride facilities for BART patrons at the Alum Rock/28<sup>th</sup> Street Station are addressed in the “BART Extension TIA.” The Alum Rock/28<sup>th</sup> Street Station plans accommodate 1,200 parking spaces in an up to seven-story parking structure next to the station. Parking demand from PNR patrons would be monitored and, if parking demand exceeds supply, VTA would evaluate measures to promote non-vehicular access

For the TOJD component of the Project, a total of 2,150 parking spaces would be provided at the Alum Rock/28<sup>th</sup> Street Station: 1,650 spaces for the office use, 100 spaces for the retail use, and 400 spaces for the residential use. TOJD at the Alum Rock/28<sup>th</sup> Street Station would be subject to the parking requirements of the City of San Jose, as follows.

- Office: 4 spaces per 1,000 square feet.
- Retail: 5 spaces per 1,000 square feet.
- Apartments: 1.25 spaces per studio or 1-bedroom unit and 1.7 spaces per 2-bedroom unit.

Because the number of studio, 1-bedroom, and 2-bedroom apartments among the maximum of 275 units proposed for this station is still a preliminary estimate, the actual number of spaces required may change if the mix of different types of units is different from the estimate used in Table 24. This analysis assumes that half of the units will be studio or 1-bedroom units and half will be 2-bedroom units.

**Table 24**  
**Parking for Transit-Oriented Joint Development**

| TOJD Site   | Size               | Required Parking Rate <sup>a</sup> | Required Parking Spaces | Parking Spaces Proposed |
|---|--------------------|------------------------------------|-------------------------|-------------------------|
| <b>Alum Rock/28th Street Station <sup>b</sup></b>   |                    |                                    |                         |                         |
| Office  | 500,000 s.f.       | 4.0                                | 2000                    | 1650                    |
| Retail  | 20,000 s.f.        | 5.0                                | 100                     | 100                     |
| Residential   | 138 Studio/1-Bedrm | 1.25                               | 173                     |                         |
|   | 137 2-Bedrm        | 1.7                                | 233                     |                         |
| Total Residential   | 275                |                                    | 406                     | 400                     |
| <b>Total TOJD</b>   |                    |                                    | <b>2506</b>             |                         |
| Reduction due to Shared Parking <sup>c</sup>  |                    |                                    | <b>-51</b>              |                         |
| Reduction due to 16% transit mode share for office <sup>d</sup>   |                    |                                    | <b>-320</b>             |                         |
| <b>Total after Reductions</b>   |                    |                                    | <b>2135</b>             | <b>2150</b>             |
| <b>Santa Clara Station</b>  |                    |                                    |                         |                         |
| Office  | 500,000 s.f.       | 3.33                               | 1665                    | 1650                    |
| Retail  | 30,000 s.f.        | 5.0                                | 150                     | 150                     |
| Residential   | 10 Studio          | 1                                  | 10                      |                         |
|   | 100 1-Bedrm        | 1.5                                | 150                     |                         |
|   | 110 2-Bedrm        | 2                                  | 220                     |                         |
| Total Residential   |                    |                                    | 380                     | 400                     |
| <b>Total TOJD</b>   |                    |                                    | <b>2195</b>             | <b>2200</b>             |
| <b>Notes:</b>   |                    |                                    |                         |                         |
| <sup>a</sup> Parking rates for Alum Rock/28th Street Station are based on City of San Jose Zoning Code, Chapter 20.90, Parking and Loading.<br>Parking rates for Santa Clara Station are based on City of Santa Clara Zoning Code, Chapters 18.22 and 18.74.<br>Parking rates are given per 1,000 s.f. for office and retail uses, and per unit for apartments. |                    |                                    |                         |                         |
| <sup>b</sup> For mixed-use projects in the City of San Jose, the Planning Director may reduce the required parking spaces by up to 50 percent, if certain conditions are met.   |                    |                                    |                         |                         |
| <sup>c</sup> Reduction for shared parking in a mixed-use project based on Urban Land Institute (ULI), <i>Shared Parking</i> , 2005.   |                    |                                    |                         |                         |
| <sup>d</sup> A 16% transit mode share was projected for the office use at Alum Rock/28th Street Station by the model. Applying a 16% reduction to San Jose's parking rate, would result in a rate of 3.36 spaces per 1,000 s.f. instead of 4 spaces per 1,000 s.f.  |                    |                                    |                         |                         |

For mixed-use projects in the City of San Jose, the Planning Director may reduce the required parking spaces by up to 50 percent, including any other allowed exceptions or reductions, so long as: (1) the reduction in parking will not adversely affect surrounding projects, (2) the reduction in parking will not rely upon or reduce the public

parking supply, and (3) the project provides a detailed Transportation Demand Management (TDM) program and demonstrates that the TDM program can be maintained indefinitely. The TOJD at the Alum Rock/28<sup>th</sup> Street Station would meet all three of these requirements, and so would be eligible to request a reduction from the standard parking requirements.

It is common for mixed-use projects to request a reduction in parking requirements based on an analysis of how many parking spaces could be shared among the different land uses. The shared parking analysis for the TOJD is based on the Urban Land Institute's publication *Shared Parking*, 2<sup>nd</sup> Edition (Smith, 2005), which provides parking occupancy rates for many land uses according to the time of day. These parking occupancy rates can be applied to the parking demand for each proposed land use. Comparing the parking requirement for each land use separately with the cumulative parking demand for all land uses combined shows whether parking demand can be reduced with a shared parking plan. For example, because office space has peak parking demand during the day and residential uses have peak parking demand at night, office and residential uses have complementary parking needs and are frequently good candidates for shared parking. The analysis for the Alum Rock/28<sup>th</sup> Street Station indicates that a reduction of 51 spaces would be justified due to shared parking among uses.

The travel demand forecasting model used for the traffic analysis of the 2035 Cumulative Plus Project conditions, as presented in the following chapter, projected a 16 percent transit mode share for the office use at the Alum Rock/28<sup>th</sup> Street Station. A 16 percent transit mode share indicates that at least 16 percent of the workers in the TOJD offices would not need to park their car there. Because the TOJD uses would develop a TDM program that encourages bicycling, walking, and ridesharing in addition to transit use, the number of employees who do not need a parking space is likely to be much higher than 16 percent. Given that the TOJD would literally be on top of a BART station and would likely need fewer parking spaces than office developments in other parts of San Jose, a 16 percent reduction in San Jose's parking requirement for office uses would be a very conservative reduction for this location. Reducing San Jose's parking requirement by 16 percent results in a rate of 3.36 spaces per 1,000 square feet and a reduction of 320 parking spaces.

The TOJD would prepare a TDM program for all land uses and would implement unbundled parking for the apartments, which would likely reduce parking demand even further. However, based only on the reductions for shared parking and for the transit mode share for the office use, a total of 2,135 spaces would be required (see Table 24). The 2,150 parking spaces proposed would meet the requirements of the City of San Jose and would meet the parking demand generated by the TOJD. Therefore, there is not projected to be a significant indirect impact on the environment caused by drivers circling for parking, resulting in significant secondary effects on traffic operations or air quality.

## Santa Clara Station

The amount of BART parking demand and supply associated with park-and-ride facilities for BART patrons at the Santa Clara Station are addressed in the "BART Extension TIA." Near the Santa Clara Station, there are three surface parking lots west of the railroad tracks serving the Santa Clara Caltrain Station. The west lot is jointly owned by the City of Santa Clara and VTA and is designated for Caltrain patrons. The Santa Clara Station projected BART PNR demand is approximately 400 spaces. This demand would be accommodated by providing 500 parking spaces in an up to five-story parking structure.

For the TOJD component of the Project, a total of 2,200 parking spaces would be provided for the TOJD at the Santa Clara Station: 1,650 spaces for the office use, 150 spaces for the retail use, and 400 spaces for the residential use. TOJD at the Santa Clara Station would be subject to the parking requirements of the City of Santa Clara, as follows.

- Office: 3.33 spaces per 1,000 square feet.
- Retail: 5 spaces per 1,000 square feet.
- Apartments: 1 space per studio unit, 1.5 spaces per 1-bedroom unit, and 2 spaces per 2-bedroom unit.

Based on these rates, the TOJD would be required to provide a total of 2,195 parking spaces for all the TOJD land uses. Because the number of studio, 1-bedroom, and 2-bedroom apartments among the maximum of 220 units proposed for this station is still a preliminary estimate, the actual number of spaces required may change if the mix of different types of units is different from the estimate used in Table 24. In order to make this analysis of

parking requirements conservative, this estimate assumes that there will be 10 studio units, 100 1-bedroom units, and 110 2-bedroom units.

The TOJD at the Santa Clara station would also implement a TDM program for all land uses and would implement unbundled parking for the apartments. Also, the Santa Clara Station TOJD could utilize a shared parking approach, as at the Alum Rock/28<sup>th</sup> Street Station. The transit share for the TOJD office use projected by the model for the Santa Clara Station is 24 percent, even higher than at the Alum Rock/28<sup>th</sup> Street Station, and could also justify reductions in the number of parking spaces provided.

However, even without any reductions, the 2,200 spaces provided would meet the Santa Clara parking requirement and would meet the parking demand generated by the TOJD. Therefore, there is not projected to be a significant indirect impact on the environment caused by drivers circling for parking, resulting in significant secondary effects on traffic operations or air quality.

## 6.

# 2035 Cumulative Plus Project Conditions

---

This chapter presents a summary of the traffic conditions that would occur under 2035 Cumulative No Project Conditions and 2035 Cumulative Plus Project Conditions, including the trips generated by the Project. All cumulative traffic volumes for this analysis were obtained from the VTA Travel Demand Forecasting Model for the Year 2035. This cumulative traffic scenario is evaluated in order to fulfill CMP and California Environmental Quality Act (CEQA) requirements. We note that in the SEIS/SEIR that has been prepared for the Phase II Extension Project, the scenarios for the year 2035 are called “2035 Forecast Year.” In accordance with the City of San Jose’s *TIA Handbook* and VTA’s *TIA Guidelines*, however, the term “Cumulative” is used throughout this TIA.

### Year 2035 Land Use and Transportation Network

The VTA Model used for this analysis includes the following assumptions in its forecasts for 2035 Cumulative Conditions:

- The number of households and employment as of 2035, based on ABAG projections. In addition, as requested by City of Santa Clara staff, the land uses associated with the City Place Project were included in the 2035 land use data base. The City Place Project would develop approximately 8 million square feet (s.f.) of mixed-use development on a 230-acre golf course and include office buildings, retail and entertainment facilities, residential units, hotels, new open spaces, new roads, and new upgraded and expanded infrastructure. The City Place Project is located south of State Route (SR) 237, near the Great America Parkway.
- The roadway network as of 2035, based on improvements identified in MTC’s Regional Transportation Plan for the Bay Area and VTA’s Valley Transportation Plan 2040. Information on local intersection improvements also were obtained from both the Cities of San Jose and Santa Clara.
- Transit capital improvement projects and service enhancements planned to be in effect by 2035, including bus rapid transit projects, light rail transit (LRT) extensions, and Caltrain service upgrades.

For details on the 2035 model assumptions regarding improvements to the roadway network, bicycle and pedestrian facilities and transit services, please refer to the “BART Extension Only TIA” (Appendix G).

### 2035 Cumulative Conditions Traffic Volumes

Peak hour traffic volumes for the year 2035 were produced with the VTA Model with the Project included in its land use and transportation network assumptions. In the 2015 Existing Plus Project and 2025 Background Plus Project Conditions scenarios, peak-hour trip generation for the Transit-Oriented Joint Development land uses are based on ITE rates, and trip reductions are applied to account for transit use. As discussed in Chapter 4 and

consistent with VTA's *TIA Guidelines*, a transit reduction of 9% for residential use and 6% for office use was applied. For the 2035 Cumulative Plus Project scenario, in addition to using the model to forecast future (year 2035) traffic volumes in the study area, the model was also applied to estimate the percent of Transit-Oriented Joint Development project trips that would use transit. Based on year 2035 land use data, the level of congestion on the roadway system, and the high quality and frequent transit rail and bus service serving the workers and residents of the Project, the model estimated a transit share for residential and office use at the Alum Rock/28<sup>th</sup> Street Station of 18% and 16%, respectively. Project trips at the Santa Clara Station would have even higher transit mode shares, because this station would be served by BART, ACE, Caltrain, and numerous bus routes. The transit shares for residential and office use at the Santa Clara Station would be 19% and 24%, respectively.

These trip reductions were then applied to the ITE trip generation rates presented in Table 12 of Chapter 4, resulting in 81 fewer vehicle trips during the morning peak hour and 79 fewer vehicle trips during the evening peak hour at the Alum Rock/28<sup>th</sup> Street Station. An additional reduction of 137 AM peak hour vehicle trips and 129 PM peak hour vehicle trips were taken from the rates in Table 12 for the Santa Clara Station to account for the larger share of transit use. 2035 Cumulative No Project and 2035 Cumulative Plus Project peak-hour traffic volumes for the Alum Rock/28<sup>th</sup> Street Station intersections are shown on Figures 33 and 34. Figures 35 and 36 present the volumes for these scenarios at the intersections around the Santa Clara Station.

### **A Note on Terminology**

In the City of San Jose, the term "Cumulative" traffic volumes typically includes trips related to the project being analyzed (i.e, Cumulative Plus Project Conditions). However, in the City of Santa Clara, the term "Cumulative" traffic volumes typically does *not* include trips related to the project being analyzed (i.e, Cumulative No Project Conditions), and the term "Cumulative Plus Project" is used to denote future volumes that include project trips, following the same convention used for "Existing Plus Project" and "Background Plus Project" scenarios. This is because the City of Santa Clara's definition of significant impacts (described below) requires comparison of "Cumulative No Project" and "Cumulative Plus Project" conditions. For this report, the following terms will be used to describe Year 2035 Conditions: 2035 Cumulative No Project Conditions and 2035 Cumulative Plus Project Conditions.



Phase II Extension Project TIA

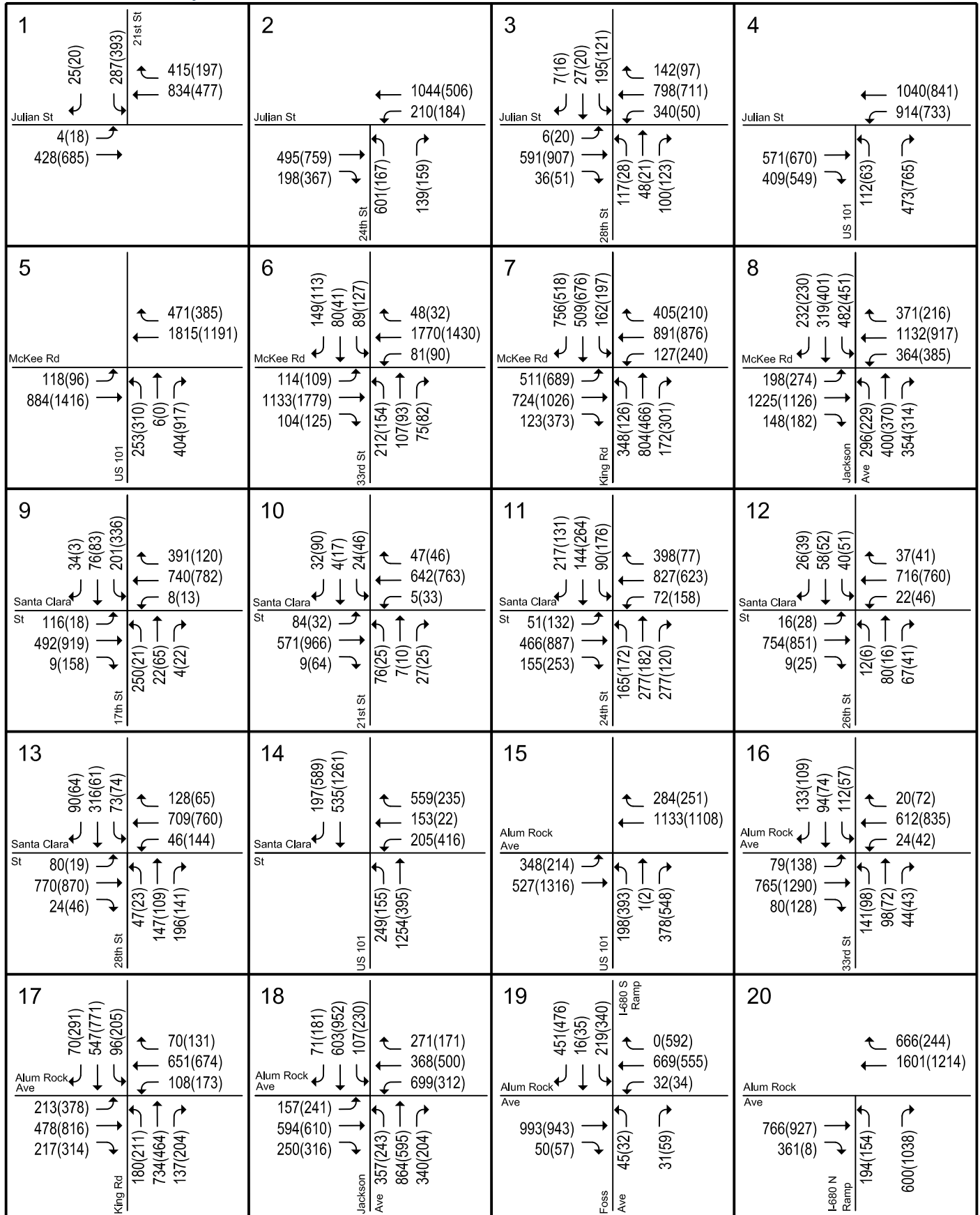

LEGEND

XX(XX) = AM(PM) Peak-Hour Traffic Volumes

**Figure 33**  
**2035 Cumulative No Project Conditions Traffic Volumes - Alum Rock/28th Street Station**



Phase II Extension Project TIA

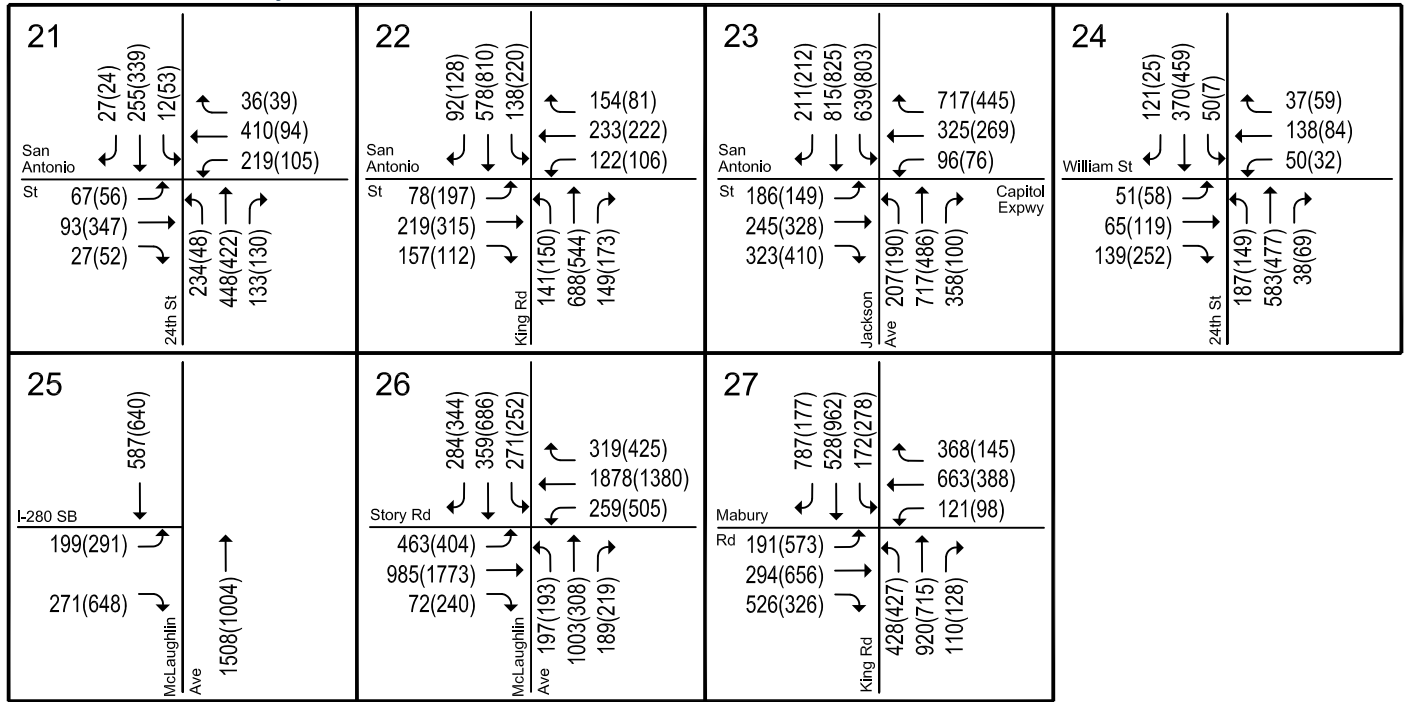

LEGEND

XX(XX) = AM(PM) Peak-Hour Traffic Volumes

**Figure 33**  
**2035 Cumulative No Project Conditions Traffic Volumes -**  
**Alum Rock/28th Street Station**

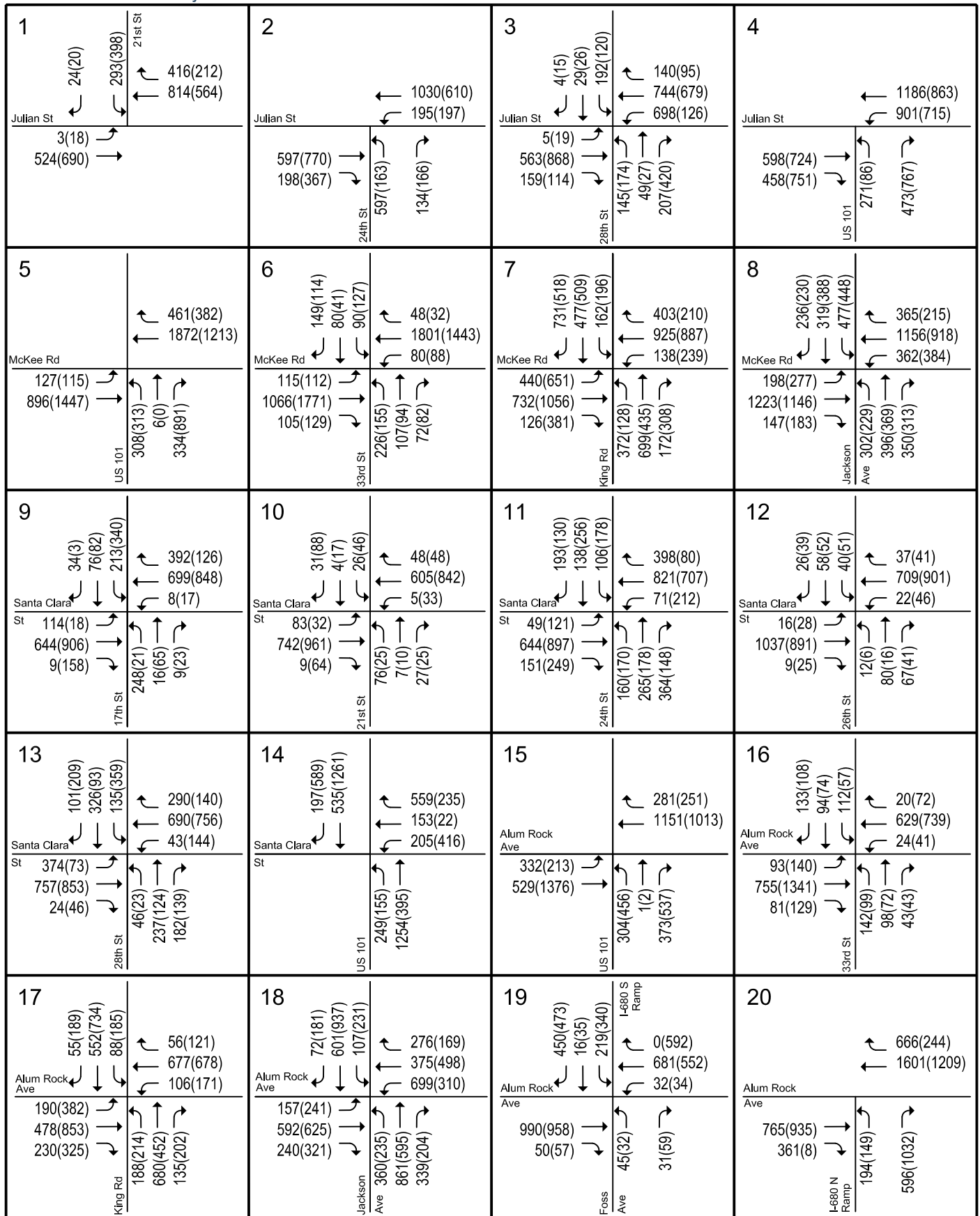

LEGEND

XX(XX) = AM(PM) Peak-Hour Traffic Volumes

**Figure 34**  
**2035 Cumulative Plus Project Conditions Traffic Volumes - Alum Rock/28th Street Station**

Phase II Extension Project TIA

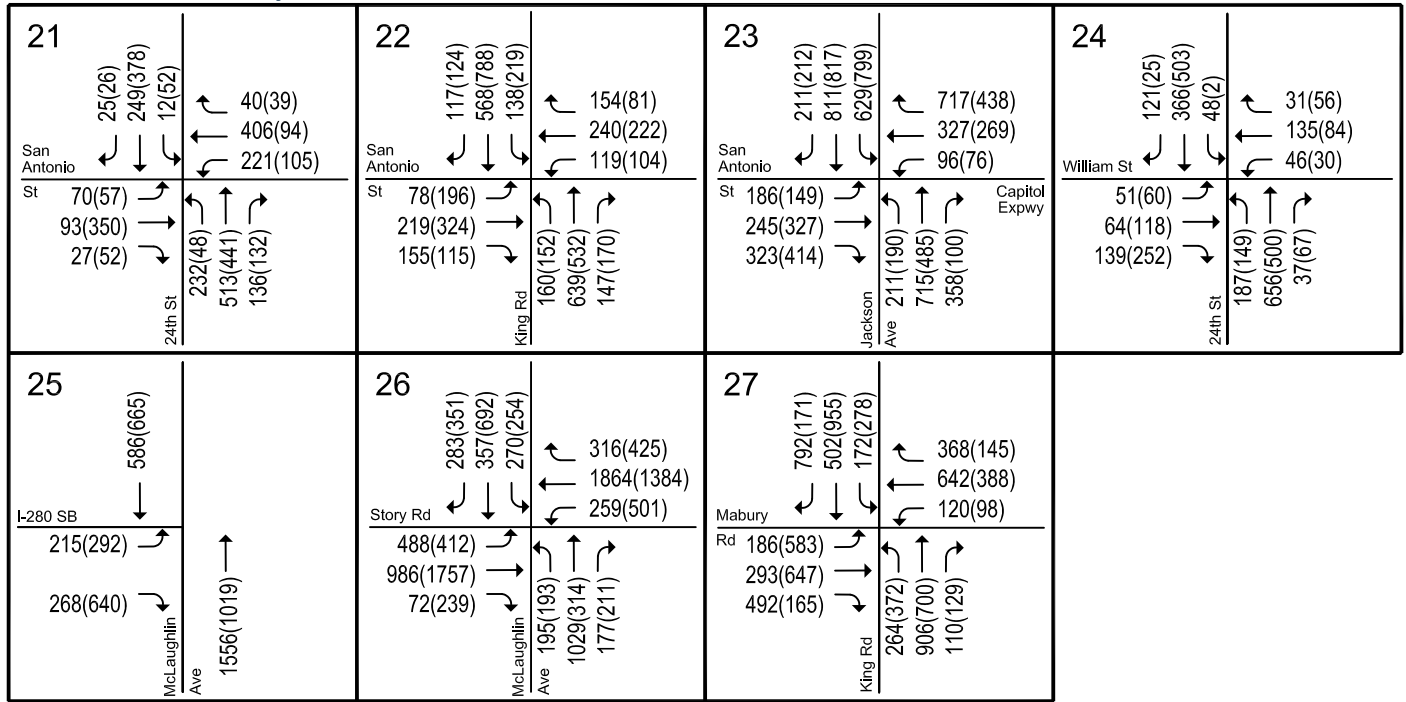

LEGEND

XX(XX) = AM(PM) Peak-Hour Traffic Volumes

Figure 34  
2035 Cumulative Plus Project Conditions Traffic Volumes - Alum Rock/28th Street Station

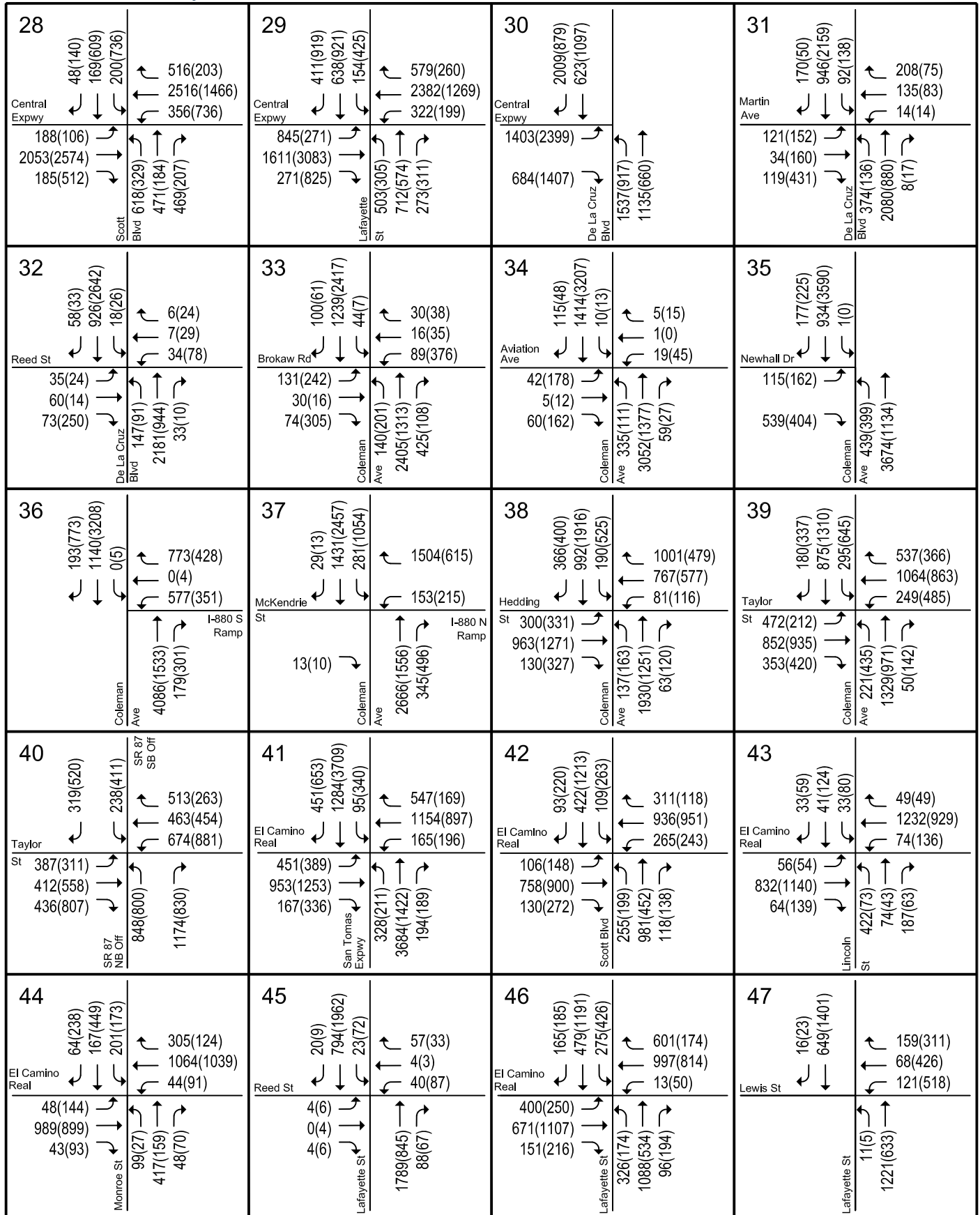

LEGEND

XX(XX) = AM(PM) Peak-Hour Traffic Volumes

**Figure 35**  
**2035 Cumulative No Project Conditions Traffic Volumes - Santa Clara Station**

Phase II Extension Project TIA

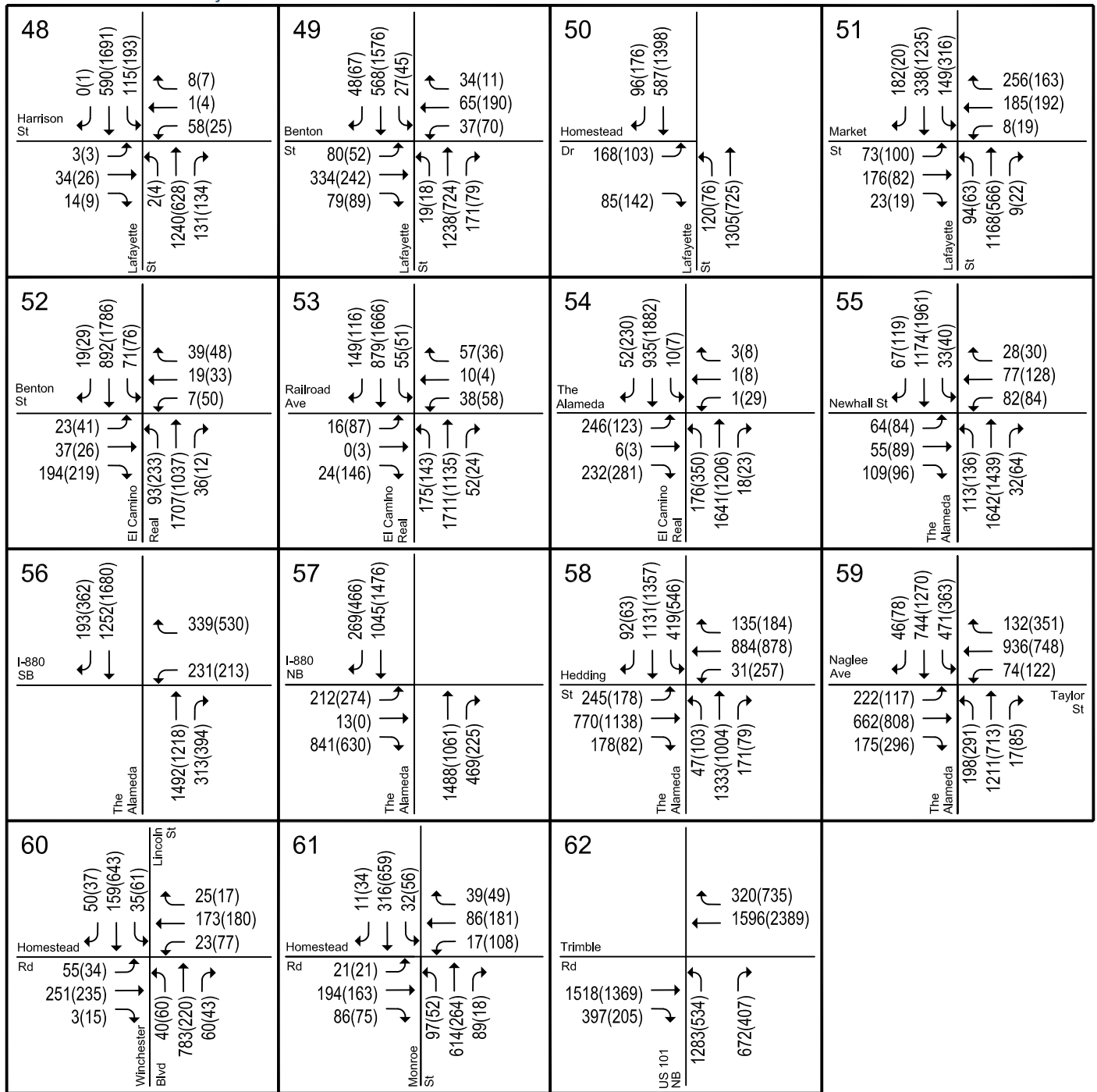

LEGEND

XX(X) = AM(PM) Peak-Hour Traffic Volumes

Figure 35  
2035 Cumulative No Project Conditions Traffic Volumes - Santa Clara Station



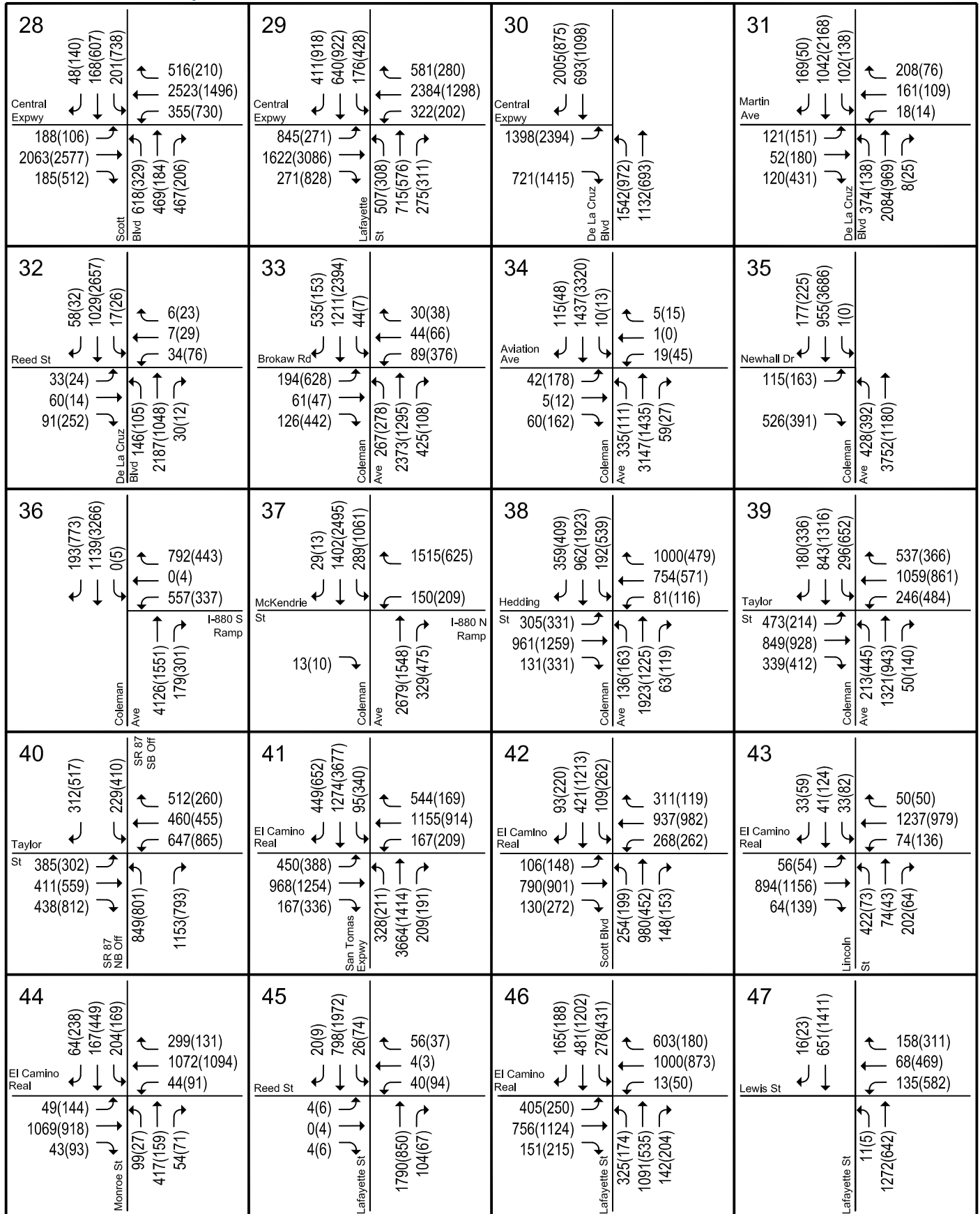

LEGEND

XX(XX) = AM(PM) Peak-Hour Traffic Volumes

**Figure 36**  
**2035 Cumulative Plus Project Conditions Traffic Volumes - Santa Clara Station**

Phase II Extension Project TIA

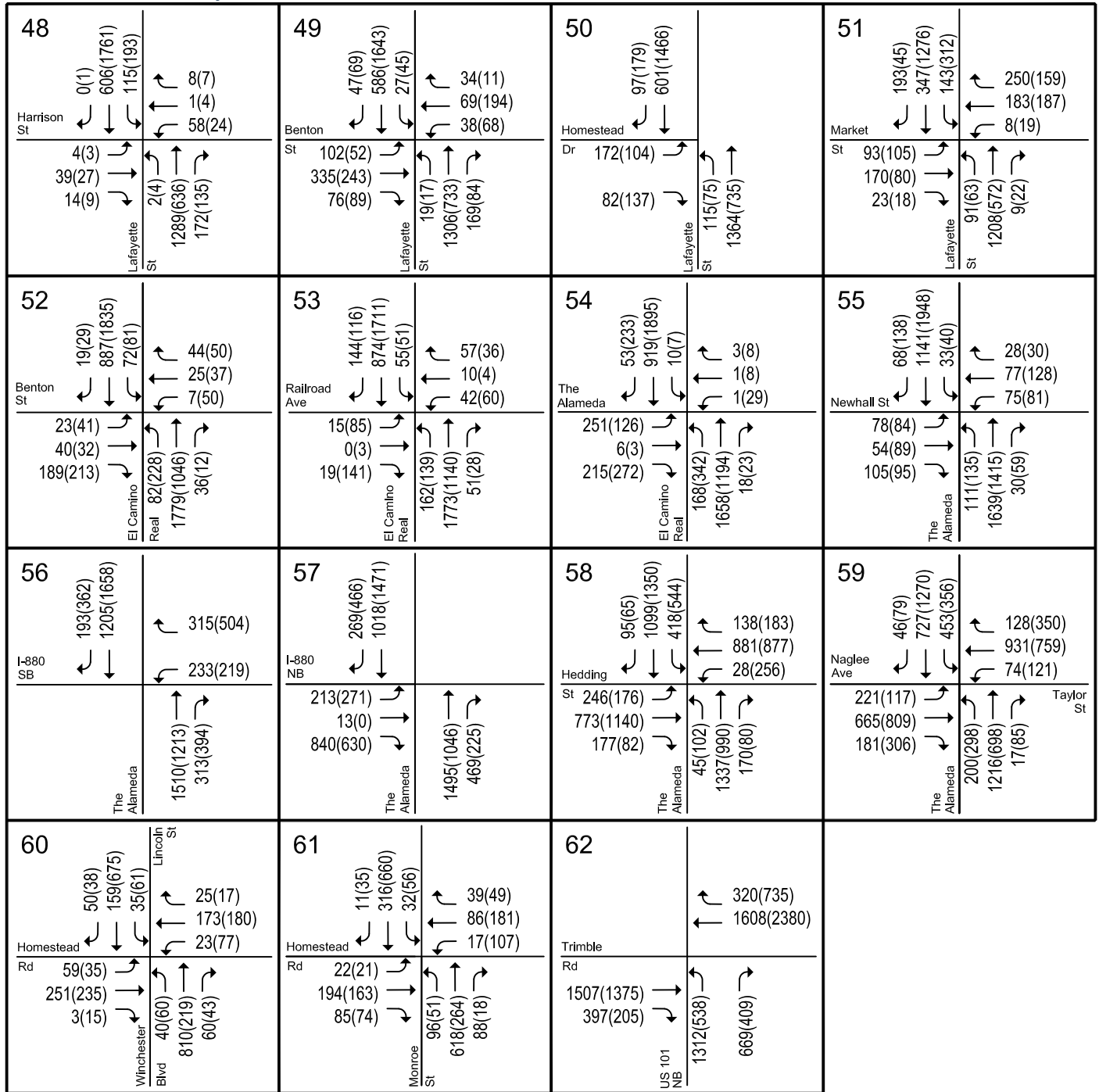

LEGEND

XX(XX) = AM(PM) Peak-Hour Traffic Volumes

Figure 36  
2035 Cumulative Plus Project Conditions Traffic Volumes - Santa Clara Station

## Definitions of Significant Cumulative Impacts

### City of San Jose Definition of Significant Cumulative Impact

In the City of San Jose, the evaluation of whether a project would cause a significant impact under the Cumulative Plus Project scenario is different from the evaluation process used for Existing Plus Project and Background Plus Project scenarios. The City of San Jose's Cumulative Plus Project evaluation methodology requires comparison of the Cumulative Plus Project scenario to the Background (No Project) scenario, and then determining if the proposed Project would contribute more than 25% of the total increase in traffic between the Background scenario and the Cumulative Plus Project scenario. Note that the term "cumulative project trips" in San Jose's definition of significant impact below refers to all of the trips generated by **all** of the projects or land uses that are included in the Cumulative Plus Project scenario (including the proposed Project) that were not included in the Background scenario.

In the City of San Jose, a significant cumulative traffic impact at an intersection is identified by comparing 2035 Cumulative Plus Project Conditions against 2025 Background Conditions. The future projects included in the Year 2035 Cumulative Plus Project scenario **collectively** would create a significant impact on traffic conditions at a signalized intersection in the City of San Jose if during either the AM or PM peak hour:

1. The level of service at the intersection degrades from an acceptable LOS D or better under 2025 Background Conditions to an unacceptable LOS E or F under 2035 Cumulative Plus Project Conditions, or
2. The level of service at the intersection is an unacceptable LOS E or F under 2025 Background Conditions and the addition of cumulative project trips causes both the critical-movement delay at the intersection to increase by four (4) or more seconds and the volume-to-capacity ratio (V/C) to increase by 0.01 or more under 2035 Cumulative Plus Project Conditions, or
3. The level of service at a designated Protected Intersection is an unacceptable LOS E or F under 2025 Background Conditions and the addition of cumulative project trips causes the volume-to-capacity ratio (V/C) to increase by one-half percent (.005) or more under 2035 Cumulative Plus Project Conditions.

An exception to rule #2 above applies when the addition of project traffic reduces the amount of average delay for critical movements (i.e., change in average delay for critical movements is negative). In this case, the threshold of significance is an increase in the critical V/C value by 0.01 or more.

**A single project's** contribution to a Cumulative Plus Project intersection impact is deemed considerable in the City of San Jose if the proportion of project traffic represents 25 percent or more of the increase in total volume from Background traffic conditions to Cumulative Plus Project traffic conditions.

### City of Santa Clara Definition of Significant Cumulative Impact

In the City of Santa Clara, a significant cumulative traffic impact at an intersection is identified by comparing 2035 Cumulative Plus Project Conditions against 2035 Cumulative No Project Conditions. The project is said to create a significant impact on traffic conditions under cumulative conditions at a signalized intersection in the City of Santa Clara if for either peak hour:

1. The level of service at the intersection degrades from an acceptable level (LOS D or better at all city-controlled intersections and LOS E or better at all expressway and CMP intersections) under 2035 Cumulative No Project Conditions to an unacceptable level (LOS E or F at city-controlled intersections and LOS F at expressway and CMP intersections) under 2035 Cumulative Plus Project Conditions, or.
2. The level of service at the intersection is an unacceptable level (LOS E or F at city-controlled intersections and LOS F at expressway and CMP intersections) under 2035 Cumulative No Project Conditions and the addition of project traffic causes both the average critical delay at the intersection to increase by four or more seconds and the volume-to-capacity ratio (V/C) to increase by one percent (0.01) or more under 2035 Cumulative Plus Project Conditions.

An exception to rule #2 above applies when the addition of project-generated traffic reduces the amount of average control delay for critical movements (i.e., the change in average control delay for critical movements is negative). In this case, the threshold of significance is an increase in the critical V/C value by one percent (0.01) or more.

### **CMP Definition of Significant Cumulative Impacts**

For CMP intersections, a significant cumulative traffic impact at an intersection is identified by comparing 2035 Cumulative Plus Project Conditions against 2035 Cumulative No Project Conditions. The project is said to create a significant impact on traffic conditions under cumulative conditions at a CMP intersection if for either peak hour:

1. The level of service at a CMP-designated intersection degrades from an acceptable LOS E or better under 2035 Cumulative No Project Conditions to an unacceptable LOS F under 2035 Cumulative Plus Project Conditions, **or**.
2. The level of service at a CMP-designated intersection is an unacceptable LOS F under 2035 Cumulative No Project Conditions and the addition of project traffic causes both the critical-movement delay at the intersection to increase by four or more seconds **and** the critical volume-to-capacity ratio (V/C) to increase by .01 or more under 2035 Cumulative Plus Project Conditions.

An exception to rule #2 above applies when the addition of project-generated traffic reduces the amount of average control delay for critical movements (i.e. the change in average control delay for critical movements is negative). In this case, the threshold of significance is an increase in the critical V/C value by one percent (0.01) or more.

### **2035 Cumulative Plus Project Intersection Level of Service Analysis**

Intersection levels of service were evaluated against City of San Jose, City of Santa Clara, and CMP standards. The results of the intersection level of service analysis under 2035 Cumulative No Project Conditions and 2035 Cumulative Plus Project Conditions are summarized in Tables 25 and 26, for the Alum Rock/28<sup>th</sup> Street and Santa Clara Stations. Note that in both tables the increase in critical delay and the increase in critical V/C (under 2035 Cumulative Plus Project Conditions) is based on a comparison of 2025 Background Conditions and 2035 Cumulative Plus Project Conditions for San Jose intersections. For Santa Clara intersections and all CMP intersections, these increases are based on a comparison of 2035 Cumulative No Project Conditions and 2035 Cumulative Plus Project Conditions. These comparisons are in accordance with their respective definitions of significant impact.

#### **Alum Rock/28<sup>th</sup> Street Station**

##### **City of San Jose Level of Service Analysis**

The results of the level of service analysis under 2035 Cumulative Plus Project Conditions show that, measured against the City of San Jose level of service standards, all except five of the study intersections in the vicinity of Alum Rock/28<sup>th</sup> Street Station would operate at an acceptable level of service (LOS D or better) during both the AM and PM peak hours of traffic. The following five intersections would operate at unacceptable levels of service (LOS E or F) under 2035 Cumulative Plus Project Conditions during at least one peak hour:

- (#7) King Road and McKee Road: (LOS F – AM peak hour and LOS E – PM peak hour)
- (#18) Jackson Avenue and Alum Rock Avenue \*: (LOS F – AM peak hour and LOS E PM peak hour)
- (#23) Jackson Avenue and San Antonio St/Capitol Expressway: (LOS E – AM peak hour)
- (#26) McLaughlin Avenue and Story Road: (LOS E – AM peak hour)
- (#27) King Road and Mabury Road: (LOS E – PM peak hour)

**Table 25**  
**2035 Cumulative Plus Project Conditions Intersection Level of Service – Alum Rock/28<sup>th</sup> Street**

| Study Number | Intersection                                 | Peak Hour | 2025 Background   |     | 2035 Cumulative No Project |          | 2035 Cumulative Plus Project |          |  |                                 | SJ Impact <sup>2</sup><br>% Cumulative Trips from Project |
|--------------|--|-----------|-------------------|-----|----------------------------|----------|------------------------------|----------|--|---------------------------------|---|
|              |  |           | Avg. Delay (sec.) | LOS | Avg. Delay (sec.)          | LOS      | Avg. Delay (sec.)            | LOS      | Incr. In Crit. Delay (sec.) <sup>1</sup> | Incr. In Crit. V/C <sup>1</sup> |   |
| 1            | 21st St & E. Julian St                       | AM        | 23.8              | C   | 25.6                       | C        | 23.7                         | C        | 1.2                                      | 0.007                           | +64%  |
|              |  | PM        | 12.7              | B   | 13.4                       | B        | 14.0                         | B        | 2.3                                      | 0.108                           | +36%  |
| 2            | 24th St & E. Julian St                       | AM        | 17.5              | B   | 29.2                       | C        | 30.3                         | C        | 15.8                                     | 0.322                           | +12%  |
|              |  | PM        | 17.4              | B   | 17.7                       | B        | 17.6                         | B        | 2.4                                      | 0.042                           | +36%  |
| 3            | N. 28th St & E. Julian St                    | AM        | 27.2              | C   | 27.9                       | C        | 33.9                         | C        | 27.5                                     | 0.328                           | +57%  |
|              |  | PM        | 14.2              | B   | 16.2                       | B        | 29.7                         | C        | 19.2                                     | 0.224                           | +71%  |
| 4            | US 101 SB ramps & E. Julian St               | AM        | 26.9              | C   | 32.2                       | C        | 50.1                         | D        | 39.8                                     | 0.229                           | +50%  |
|              |  | PM        | 30.8              | C   | 30.0                       | C        | 37.1                         | D        | 13.4                                     | 0.117                           | +44%  |
| 5            | US 101 NB ramps & McKee Rd                   | AM        | 23.0              | C   | 22.7                       | C        | 24.9                         | C        | 4.0                                      | 0.168                           | +10%  |
|              |  | PM        | 28.6              | C   | 30.9                       | C        | 31.1                         | C        | 2.6                                      | 0.051                           | +9%   |
| 6            | 33rd St & McKee Rd                           | AM        | 34.0              | C   | 47.6                       | D        | 50.0                         | D        | 20.4                                     | 0.229                           | -3%   |
|              |  | PM        | 28.7              | C   | 42.1                       | D        | 42.3                         | D        | 15.4                                     | 0.225                           | +2%   |
| 7            | King Rd & McKee Rd                           | AM        | 52.6              | D   | <b>91.3</b>                | <b>F</b> | <b>89.1</b>                  | <b>F</b> | <b>59.7</b>                              | <b>0.242</b>                    | -20%  |
|              |  | PM        | 51.9              | D   | <b>68.0</b>                | <b>E</b> | <b>62.8</b>                  | <b>E</b> | <b>16.0</b>                              | <b>0.131</b>                    | -20%  |
| 8            | Jackson Ave & McKee Rd                       | AM        | 40.0              | D   | 40.9                       | D        | 40.8                         | D        | 0.8                                      | 0.122                           | +1%   |
|              |  | PM        | 40.9              | D   | 43.4                       | D        | 43.4                         | D        | 5.5                                      | 0.129                           | +1%   |
| 9            | 17th St & E. Santa Clara St                  | AM        | 17.1              | B   | 25.9                       | C        | 27.6                         | C        | 10.3                                     | 0.334                           | +10%  |
|              |  | PM        | 19.8              | B   | 33.5                       | C        | 35.3                         | D        | 16.2                                     | 0.359                           | +7%   |
| 10           | 21st St & E. Santa Clara St                  | AM        | 5.7               | A   | 6.0                        | A        | 5.5                          | A        | -0.6                                     | 0.056                           | +27%  |
|              |  | PM        | 4.6               | A   | 5.5                        | A        | 5.3                          | A        | 1.1                                      | 0.026                           | +12%  |
| 11           | 24th St & E. Santa Clara St                  | AM        | 19.7              | B   | 22.4                       | C        | 22.1                         | C        | 2.6                                      | 0.158                           | +18%  |
|              |  | PM        | 21.4              | C   | 26.5                       | C        | 28.1                         | C        | 11.1                                     | 0.224                           | +14%  |
| 12           | 26th St. & E. Santa Clara St                 | AM        | 16.5              | B   | 15.2                       | B        | 13.7                         | B        | -2.3                                     | 0.136                           | +38%  |
|              |  | PM        | 14.4              | B   | 13.8                       | B        | 13.2                         | B        | -0.7                                     | 0.003                           | +38%  |
| 13           | N. 28th St & E. Santa Clara St               | AM        | 20.9              | C   | 20.6                       | C        | 26.9                         | C        | 10.7                                     | 0.288                           | +43%  |
|              |  | PM        | 18.4              | B   | 19.3                       | B        | 22.1                         | C        | 5.0                                      | 0.149                           | +62%  |
| 14           | US 101 & E. Santa Clara St *                 | AM        | 11.8              | B   | 11.6                       | B        | 11.0                         | B        | -0.3                                     | 0.025                           | +27%  |
|              |  | PM        | 16.3              | B   | 19.6                       | B        | 21.0                         | C        | 6.0                                      | 0.121                           | +22%  |
| 15           | US 101 & Alum Rock Ave *                     | AM        | 11.0              | B   | 17.3                       | B        | 17.0                         | B        | -0.3                                     | -0.004                          | +9%   |
|              |  | PM        | 15.9              | B   | 20.2                       | C        | 20.2                         | C        | -1.0                                     | -0.036                          | +2%   |
| 16           | 33rd St & Alum Rock Rd                       | AM        | 21.4              | C   | 22.6                       | C        | 22.7                         | C        | 1.6                                      | 0.124                           | +3%   |
|              |  | PM        | 18.7              | B   | 18.5                       | B        | 18.6                         | B        | 0.1                                      | 0.211                           | -4%   |
| 17           | King Rd & Alum Rock Ave *                    | AM        | 30.9              | C   | 35.7                       | D        | 35.3                         | D        | -0.4                                     | -0.005                          | -8%   |
|              |  | PM        | 36.0              | D   | 46.5                       | D        | 44.1                         | D        | -3.3                                     | -0.037                          | -10%  |
| 18           | Jackson Ave & Alum Rock Ave *                | AM        | 42.8              | D   | <b>101.1</b>               | <b>F</b> | <b>99.9</b>                  | <b>F</b> | <b>-1.8</b>                              | <b>-0.005</b>                   | -0%   |
|              |  | PM        | 46.7              | D   | <b>55.6</b>                | <b>E</b> | <b>55.4</b>                  | <b>E</b> | <b>-0.8</b>                              | <b>-0.005</b>                   | -1%   |
| 19           | I-680 S & Alum Rock Ave (West) *             | AM        | 21.7              | C   | 31.6                       | C        | 31.5                         | C        | 0.0                                      | -0.001                          | +1%   |
|              |  | PM        | 26.5              | C   | 30.2                       | C        | 30.2                         | C        | 0.0                                      | 0.002                           | +2%   |
| 20           | I-680 N & Alum Rock Ave (East) *             | AM        | 21.3              | C   | 21.3                       | C        | 21.2                         | C        | -0.2                                     | -0.001                          | -2%   |
|              |  | PM        | 26.4              | C   | 26.7                       | C        | 26.6                         | C        | -0.1                                     | -0.003                          | -6%   |
| 21           | 24th St & San Antonio St                     | AM        | 16.0              | B   | 26.2                       | C        | 29.9                         | C        | 18.5                                     | 0.312                           | +9%   |
|              |  | PM        | 12.5              | B   | 16.2                       | B        | 16.3                         | B        | 5.9                                      | 0.269                           | +11%  |
| 22           | King Rd & E. San Antonio St.                 | AM        | 32.7              | C   | 33.7                       | C        | 34.3                         | C        | 1.6                                      | 0.019                           | -5%   |
|              |  | PM        | 33.8              | C   | 42.7                       | D        | 42.8                         | D        | 9.7                                      | 0.270                           | -4%   |
| 23           | Jackson Ave & E. San Antonio St/Capitol Expy | AM        | 38.8              | D   | <b>63.5</b>                | <b>E</b> | <b>63.1</b>                  | <b>E</b> | <b>47.5</b>                              | <b>0.291</b>                    | -1%   |
|              |  | PM        | 35.2              | D   | 40.2                       | D        | 40.0                         | D        | 10.3                                     | 0.195                           | -2%   |
| 24           | 24th St & E. William St.                     | AM        | 15.9              | B   | 20.5                       | C        | 19.9                         | B        | 5.2                                      | 0.136                           | +10%  |
|              |  | PM        | 19.4              | B   | 21.5                       | C        | 21.5                         | C        | 2.5                                      | 0.098                           | +11%  |
| 25           | McLaughlin Ave & I-280 SB Ramp *             | AM        | 9.9               | A   | 9.8                        | A        | 10.2                         | B        | 0.6                                      | 0.023                           | +66%  |
|              |  | PM        | 15.1              | B   | 15.0                       | B        | 14.9                         | B        | -0.1                                     | 0.002                           | +25%  |
| 26           | McLaughlin Ave & Story Rd                    | AM        | 43.2              | D   | <b>58.3</b>                | <b>E</b> | <b>60.6</b>                  | <b>E</b> | <b>29.6</b>                              | <b>0.252</b>                    | +2%   |
|              |  | PM        | 52.2              | D   | 52.8                       | D        | 52.9                         | D        | 1.4                                      | 0.048                           | +1%   |
| 27           | King Rd & Mabury Rd                          | AM        | 43.2              | D   | <b>65.0</b>                | <b>E</b> | 54.9                         | D        | 22.7                                     | 0.331                           | -28%  |
|              |  | PM        | 42.3              | D   | <b>59.6</b>                | <b>E</b> | <b>58.3</b>                  | <b>E</b> | <b>28.4</b>                              | <b>0.262</b>                    | -27%  |

**Notes:**

\* Denotes a CMP intersection

(1) Increase in Critical Delay and Increase in Critical V/C are calculated as the difference between 2025 Background and 2035 Cumulative Plus Project for non-CMP San Jose intersections, and as the difference between 2035 Cumulative No Project and 2035 Cumulative Plus Project for CMP intersections.

(2) The Project would cause an impact in San Jose under 2035 Cumulative Plus Project Conditions if the intersection would operate at an unacceptable LOS and the Project would contribute more than 25% of the total increase in traffic volume between 2025 Background and 2035 Cumulative Plus Project Conditions.

**Bold** indicates a substandard level of service (according to City of San Jose standards).

**Bold** indicates a significant impact.

**Table 26**  
**2035 Cumulative Plus Project Conditions Intersection Level of Service – Santa Clara**

| Study Number           | Intersection  | Location    | Peak Hour | 2025 Background   |     | 2035 Cumulative No Project |     | 2035 Cumulative + Project |     |  |                                 | SJ Impact <sup>2</sup> | SC and/or CMP Impact |
|------------------------|---|-------------|-----------|-------------------|-----|----------------------------|-----|---------------------------|-----|--|---------------------------------|------------------------|----------------------|
|                        |   |             |           | Avg. Delay (sec.) | LOS | Avg. Delay (sec.)          | LOS | Avg. Delay (sec.)         | LOS | Incr. In Crit. Delay (sec.) <sup>1</sup> | Incr. In Crit. V/C <sup>1</sup> |                        |                      |
| 28                     | Scott Blvd & Central Expy *                           | Santa Clara | AM        | 42.9              | D   | 43.4                       | D   | 43.3                      | D   | 0.0                                      | 0.001                           | --                     | 0.0                  |
|                        |   |             | PM        | 75.5              | E   | 171.9                      | F   | 176.7                     | F   | 12.3                                     | -0.063                          | --                     | 12.3                 |
| 29                     | Lafayette St & Central Expy *                         | Santa Clara | AM        | 51.3              | D   | 91.3                       | F   | 91.7                      | F   | 0.6                                      | 0.002                           | --                     | 0.6                  |
|                        |   |             | PM        | 68.7              | E   | 118.7                      | F   | 120.1                     | F   | -1.4                                     | 0.077                           | --                     | -1.4                 |
| 30                     | De La Cruz Blvd & Central Expy *                      | Santa Clara | AM        | <b>310.3</b>      | F   | <b>368.1</b>               | F   | <b>364.5</b>              | F   | <b>-0.8</b>                              | <b>-0.002</b>                   | --                     | <b>-0.8</b>          |
|                        |   |             | PM        | <b>101.2</b>      | F   | <b>227.3</b>               | F   | <b>243.1</b>              | F   | <b>27.2</b>                              | <b>0.015</b>                    | --                     | <b>27.2</b>          |
| 31                     | De La Cruz Blvd & Martin Ave                          | Santa Clara | AM        | 34.8              | C   | 38.2                       | D   | 40.2                      | D   | 14.7                                     | 0.021                           | --                     | 14.7                 |
|                        |   |             | PM        | 31.8              | C   | 32.6                       | C   | 32.8                      | C   | 0.0                                      | 0.002                           | --                     | 0.0                  |
| 32                     | De La Cruz Blvd & Reed St                             | Santa Clara | AM        | 10.7              | B   | 13.7                       | B   | 14.3                      | B   | 1.0                                      | 0.011                           | --                     | 1.0                  |
|                        |   |             | PM        | 19.0              | B   | 19.6                       | B   | 20.0                      | B   | 1.0                                      | 0.013                           | --                     | 1.0                  |
| 33                     | Coleman Ave & Brokaw Rd                               | Santa Clara | AM        | 17.2              | B   | 17.9                       | B   | 22.1                      | C   | 5.4                                      | 0.044                           | --                     | 5.4                  |
|                        |   |             | PM        | <b>57.9</b>       | E   | <b>61.5</b>                | E   | <b>113.3</b>              | F   | <b>64.7</b>                              | <b>0.154</b>                    | --                     | <b>64.7</b>          |
| <i>With Mitigation</i> |   |             |           |                   |     |                            |     |                           |     |  |                                 |                        |                      |
| 34                     | Coleman Ave & Aviation Ave                            | San Jose    | AM        | 31.3              | C   | 34.6                       | C   | 41.5                      | D   | 17.6                                     | 0.048                           | +23%                   | --                   |
|                        |   |             | PM        | 18.2              | B   | 18.2                       | B   | 18.5                      | B   | 0.5                                      | 0.022                           | +95%                   | --                   |
| 35                     | Coleman Ave & Newhall Dr                              | San Jose    | AM        | 14.2              | B   | 16.4                       | B   | 16.5                      | B   | 0.4                                      | 0.015                           | +9%                    | --                   |
|                        |   |             | PM        | 24.6              | C   | 30.5                       | C   | 32.3                      | C   | 10.7                                     | 0.071                           | +58%                   | --                   |
| 36                     | Coleman Ave & I-880 SB Ramps *                        | San Jose    | AM        | <b>107.9</b>      | F   | <b>102.0</b>               | F   | <b>108.7</b>              | F   | <b>8.3</b>                               | <b>0.019</b>                    | +7%                    | <b>CMP</b>           |
|                        |   |             | PM        | 43.6              | D   | 52.3                       | D   | 50.1                      | D   | 56.0                                     | 9.5                             | 0.023                  | +24%                 |
| 37                     | Coleman Ave & I-880 NB Ramps *                        | San Jose    | AM        | <b>85.8</b>       | F   | <b>84.8</b>                | F   | <b>88.0</b>               | F   | <b>3.8</b>                               | <b>0.009</b>                    | -3%                    | --                   |
|                        |   |             | PM        | 32.6              | C   | 35.8                       | D   | 36.1                      | D   | -4.2                                     | -0.007                          | +4%                    | --                   |
| 38                     | Coleman Ave & W. Hedding St                           | San Jose    | AM        | 41.2              | D   | 59.4                       | E   | 59.2                      | E   | 22.0                                     | 0.120                           | -3%                    | --                   |
|                        |   |             | PM        | 36.7              | D   | 65.0                       | E   | 64.2                      | E   | 47.9                                     | 0.293                           | -1%                    | --                   |
| 39                     | Coleman Ave & W. Taylor St                            | San Jose    | AM        | <b>60.0</b>       | E   | <b>67.3</b>                | E   | <b>66.7</b>               | E   | <b>7.9</b>                               | <b>0.034</b>                    | -5%                    | --                   |
|                        |   |             | PM        | <b>63.7</b>       | E   | <b>117.1</b>               | F   | <b>115.9</b>              | F   | <b>78.1</b>                              | <b>0.206</b>                    | -2%                    | --                   |
| 40                     | SR 87 & W. Taylor St                                  | San Jose    | AM        | 28.7              | C   | 34.6                       | C   | 34.0                      | C   | 2.5                                      | 0.059                           | -8%                    | --                   |
|                        |   |             | PM        | 38.5              | D   | 54.4                       | D   | 52.4                      | D   | 30.5                                     | 0.119                           | -5%                    | --                   |
| 41                     | San Tomas Expy & El Camino Real *                     | Santa Clara | AM        | <b>83.8</b>       | F   | <b>97.5</b>                | F   | <b>96.2</b>               | F   | <b>-2.1</b>                              | <b>-0.005</b>                   | --                     | <b>-2.1</b>          |
|                        |   |             | PM        | <b>129.5</b>      | F   | <b>130.2</b>               | F   | <b>128.3</b>              | F   | <b>-3.6</b>                              | <b>-0.003</b>                   | --                     | <b>-3.6</b>          |
| 42                     | Scott Blvd & El Camino Real *                         | Santa Clara | AM        | 34.1              | C   | 37.1                       | D   | 37.0                      | D   | 0.3                                      | 0.008                           | --                     | 0.3                  |
|                        |   |             | PM        | 38.4              | D   | 41.4                       | D   | 41.9                      | D   | 1.1                                      | 0.012                           | --                     | 1.1                  |
| 43                     | Lincoln St & El Camino Real *                         | Santa Clara | AM        | 20.9              | C   | 28.6                       | C   | 28.6                      | C   | 0.0                                      | 0.001                           | --                     | 0.0                  |
|                        |   |             | PM        | 23.6              | C   | 23.8                       | C   | 23.6                      | C   | 0.0                                      | 0.005                           | --                     | 0.0                  |
| 44                     | Monroe St & El Camino Real *                          | Santa Clara | AM        | 35.8              | D   | 37.7                       | D   | 38.2                      | D   | 0.3                                      | 0.008                           | --                     | 0.3                  |
|                        |   |             | PM        | 33.4              | C   | 33.7                       | C   | 33.5                      | C   | -0.1                                     | 0.011                           | --                     | -0.1                 |
| 45                     | Lafayette St & Reed St                                | Santa Clara | AM        | 7.3               | A   | 7.3                        | A   | 7.4                       | A   | 0.1                                      | 0.007                           | --                     | 0.1                  |
|                        |   |             | PM        | 7.5               | A   | 8.1                        | A   | 8.3                       | A   | 0.3                                      | 0.007                           | --                     | 0.3                  |
| 46                     | Lafayette St & El Camino Real *                       | Santa Clara | AM        | 43.0              | D   | 56.8                       | E   | 56.9                      | E   | 1.1                                      | 0.005                           | --                     | 1.1                  |
|                        |   |             | PM        | 43.0              | D   | 45.2                       | D   | 45.8                      | D   | 1.2                                      | 0.016                           | --                     | 1.2                  |
| 47                     | Lafayette St & Lewis St                               | Santa Clara | AM        | 10.0              | B   | 11.2                       | B   | 11.3                      | B   | -0.1                                     | 0.001                           | --                     | -0.1                 |
|                        |   |             | PM        | 45.8              | D   | 66.3                       | E   | <b>75.3</b>               | E   | <b>10.5</b>                              | <b>0.027</b>                    | --                     | <b>10.5</b>          |
| <i>With Mitigation</i> |   |             |           |                   |     |                            |     |                           |     |  |                                 |                        |                      |
| 48                     | Lafayette St & Harrison St<br><i>Unsignalized (2)</i> | Santa Clara | AM        | 69.9              | F   | OVER                       | F   | OVER                      | F   | --                                       | --                              | --                     | N/A                  |
|                        |   |             | PM        | 304.2             | F   | OVER                       | F   | OVER                      | F   | --                                       | --                              | --                     | N/A                  |
| 49                     | Lafayette St & Benton St                              | Santa Clara | AM        | 17.2              | B   | 20.2                       | C   | 20.2                      | C   | -0.1                                     | 0.018                           | --                     | -0.1                 |
|                        |   |             | PM        | 17.8              | B   | 18.1                       | B   | 18.2                      | B   | -4.4                                     | 0.020                           | --                     | -4.4                 |
| 50                     | Lafayette St & Homestead Rd                           | Santa Clara | AM        | 26.6              | C   | 24.6                       | C   | 30.4                      | C   | 8.6                                      | 0.035                           | --                     | 8.6                  |
|                        |   |             | PM        | 9.3               | A   | 8.9                        | A   | 8.6                       | A   | -0.1                                     | 0.006                           | --                     | -0.1                 |
| 51                     | Lafayette St & Market St                              | Santa Clara | AM        | 17.3              | B   | 22.7                       | C   | 24.1                      | C   | 1.6                                      | 0.026                           | --                     | 1.6                  |
|                        |   |             | PM        | 25.2              | C   | 36.6                       | D   | 37.3                      | D   | 0.4                                      | 0.019                           | --                     | 0.4                  |
| 52                     | El Camino Real & Benton St                            | Santa Clara | AM        | 12.6              | B   | 13.8                       | B   | 13.7                      | B   | -0.1                                     | 0.014                           | --                     | -0.1                 |
|                        |   |             | PM        | 15.4              | B   | 16.7                       | B   | 16.6                      | B   | -0.1                                     | 0.007                           | --                     | -0.1                 |
| 53                     | El Camino Real & Railroad Ave                         | Santa Clara | AM        | 10.5              | B   | 11.1                       | B   | 11.2                      | B   | 0.1                                      | 0.013                           | --                     | 0.1                  |
|                        |   |             | PM        | 12.4              | B   | 12.2                       | B   | 12.1                      | B   | -0.1                                     | 0.005                           | --                     | -0.1                 |
| 54                     | El Camino Real & The Alameda *                        | Santa Clara | AM        | 13.0              | B   | 18.7                       | B   | 18.8                      | B   | 0.3                                      | 0.008                           | --                     | 0.3                  |
|                        |   |             | PM        | 17.0              | B   | 20.8                       | C   | 20.6                      | C   | -0.3                                     | 0.001                           | --                     | -0.3                 |
| 55                     | The Alameda & Newhall Dr                              | San Jose    | AM        | 12.4              | B   | 14.7                       | B   | 14.6                      | B   | 3.3                                      | 0.068                           | -5%                    | --                   |
|                        |   |             | PM        | 12.6              | B   | 19.7                       | B   | 19.6                      | B   | 10.9                                     | 0.176                           | -3%                    | --                   |
| 56                     | The Alameda & I-880 (South) *                         | San Jose    | AM        | 20.5              | C   | 20.0                       | C   | 18.9                      | B   | -1.3                                     | -0.009                          | -9%                    | --                   |
|                        |   |             | PM        | 15.2              | B   | 26.1                       | C   | 25.1                      | C   | -1.3                                     | -0.022                          | -8%                    | --                   |
| 57                     | The Alameda & I-880 (North) *                         | San Jose    | AM        | 24.4              | C   | 40.7                       | D   | 40.7                      | D   | 0.1                                      | 0.001                           | -3%                    | --                   |
|                        |   |             | PM        | 21.1              | C   | 29.6                       | C   | 29.6                      | C   | 0.0                                      | -0.001                          | -7%                    | --                   |
| 58                     | The Alameda & W. Hedding St *                         | San Jose    | AM        | 39.2              | D   | <b>72.7</b>                | E   | <b>72.9</b>               | E   | <b>0.1</b>                               | <b>0.000</b>                    | -1%                    | --                   |
|                        |   |             | PM        | 39.3              | D   | <b>93.4</b>                | F   | <b>92.1</b>               | F   | <b>-2.1</b>                              | <b>-0.005</b>                   | -1%                    | --                   |
| 59                     | The Alameda & W. Taylor St/Naglee Ave *               | San Jose    | AM        | 42.7              | D   | <b>92.5</b>                | F   | <b>89.5</b>               | F   | <b>-4.9</b>                              | <b>-0.013</b>                   | -2%                    | --                   |
|                        |   |             | PM        | 46.7              | D   | <b>70.0</b>                | E   | <b>71.4</b>               | E   | <b>2.1</b>                               | <b>0.008</b>                    | +0%                    | --                   |
| 60                     | Homestead Rd & Lincoln St/Winchester Blvd             | Santa Clara | AM        | 21.5              | C   | 20.5                       | C   | 20.4                      | C   | -0.2                                     | 0.008                           | --                     | -0.2                 |
|                        |   |             | PM        | 21.6              | C   | 22.0                       | C   | 21.8                      | C   | -0.3                                     | 0.010                           | --                     | -0.3                 |
| 61                     | Homestead Rd & Monroe St                              | Santa Clara | AM        | 9.9               | A   | 10.5                       | B   | 10.6                      | B   | 0.0                                      | 0.002                           | --                     | 0.0                  |
|                        |   |             | PM        | 10.5              | B   | 11.1                       | B   | 11.1                      | B   | 0.0                                      | 0.001                           | --                     | 0.0                  |
| 62                     | US 101 & Trimble                                      | San Jose    | AM        | 22.8              | C   | 26.5                       | C   | 27.6                      | C   | 7.0                                      | 0.065                           | +5%                    | --                   |
|                        |   |             | PM        | 13.1              | B   | 15.6                       | B   | 15.6                      | B   | 4.3                                      | 0.099                           | +0%                    | --                   |

Notes:  
 \* Denotes a CMP intersection  
 (1) Increase in Critical Delay and Increase in Critical V/C are calculated as the difference between 2025 Background and 2035 Cumulative Plus Project for non-CMP San Jose intersections, and as the difference between 2035 Cumulative No Project and 2035 Cumulative Plus Project for Santa Clara and CMP intersections.  
 (2) The Project would cause an impact in San Jose under 2035 Cumulative Plus Project Conditions if the intersection would operate at an unacceptable LOS and the Project would contribute more than 25% of the total increase in traffic volume between 2025 Background and 2035 Cumulative Plus Project Conditions.  
 (3) The reported delay and corresponding level of service for signalized intersections represent the average delay for all approaches at the intersection. The reported delay and corresponding level of service for unsignalized (two-way stop-controlled) intersections are based on the stop-controlled approach with the highest delay.

**Bold** indicates a substandard level of service (according to City of San Jose or City of Santa Clara standards).  
**Bold** with a box indicates a significant impact (according to City of San Jose, or City of Santa Clara Standards)



### **CMP Level of Service Analysis**

The results of the level of service analysis under 2035 Cumulative Plus Project Conditions show that, measured against the CMP standards, all except one of the CMP study intersections in the vicinity of Alum Rock/28<sup>th</sup> Street Station would operate at an acceptable level of service (LOS E or better) during both the AM and PM peak hours of traffic. The following CMP intersection would operate at an unacceptable level of service (LOS F) under 2035 Cumulative Plus Project Conditions during at least one peak hour:

(#18) Jackson Avenue and Alum Rock Avenue \*: (LOS F – AM peak hour)

## **Santa Clara Station**

### **City of San Jose Level of Service Analysis**

The results of the level of service analysis under 2035 Cumulative Plus Project Conditions show that, measured against the City of San Jose level of service policy, all but six of the Santa Clara Station study intersections located within San Jose would operate at an acceptable level of service (LOS D or better) during both the AM and PM peak hours of traffic. The following six intersections would operate at unacceptable levels of service (LOS E or F) under 2035 Cumulative Plus Project Conditions during at least one peak hour:

- (#36) Coleman Avenue and I-880 Southbound Ramps \* (LOS F – AM peak hour and LOS E – PM peak)
- (#37) Coleman Avenue and I-880 Northbound Ramps \* (LOS F – AM peak hour)
- (#38) Coleman Avenue and W. Hedding Street (LOS E – AM and PM peak hours)
- (#39) Coleman Avenue and W. Taylor Street (LOS E – AM peak hour and LOS F - PM peak hour)
- (#58) The Alameda and W. Hedding St \*: (LOS E – AM peak hour and LOS F – PM peak hour)
- (#59) The Alameda and W. Taylor St/Naglee Ave \*: (LOS F – AM peak hour and LOS E PM peak hour)

### **City of Santa Clara Level of Service Analysis**

The results of the level of service analysis under 2035 Cumulative Plus Project Conditions show that, measured against the City of Santa Clara level of service standards, all except six of the Santa Clara Station study intersections located within Santa Clara would operate at an acceptable level of service (LOS D or better at local intersections and LOS E or better at expressway and CMP intersections) during both the AM and PM peak hours of traffic. The following six intersections would operate at unacceptable levels of service (LOS E or worse for local intersections and LOS F for expressways and CMP intersections) under 2035 Cumulative Plus Project Conditions during at least one peak hour:

- (#28) Scott Boulevard and Central Expressway \*: (LOS F – PM peak hour)
- (#29) Lafayette Street and Central Expressway \*: (LOS F – AM and PM peak hours)
- (#30) De La Cruz Boulevard and Central Expressway \* (LOS F – AM and PM peak hours)
- (#33) Coleman Avenue and Brokaw Road (LOS F – PM peak hour)
- (#41) San Tomas Expressway and El Camino Real \* (LOS F – AM and PM peak hours)
- (#47) Lafayette Street and Lewis Street: (LOS E – PM peak hour)

The unsignalized intersection of Lafayette Street and Harrison Street (#48) has two-way stop control. The level of service shown for this intersection on Table 25, LOS F in both the AM and PM peak hours, reflects the delay and the level of service for the stop-controlled approach with the highest delay, not the average of the entire intersection. Because the City of Santa Clara does not have a level of service standard for unsignalized intersections, this intersection cannot be said to operate at an unacceptable level of service. The level of service is presented for informational purposes only. The peak-hour traffic signal warrant checks for this intersection are included in Chapter 5.

### **CMP Level of Service Analysis**

The results of the level of service analysis under 2035 Cumulative Plus Project Conditions show that, measured against the CMP level of service standards, all except eight of the CMP study intersections in the vicinity of Santa Clara Station would operate at an acceptable level of service (LOS E or better) during both the AM and PM peak

hours of traffic. The following eight CMP intersections would operate at unacceptable levels of service (LOS F) under 2035 Cumulative Plus Project Conditions during at least one peak hour:

- (#28) Scott Boulevard and Central Expressway \*: (LOS F – PM peak hour)
- (#29) Lafayette Street and Central Expressway \*: (LOS F – AM and PM peak hours)
- (#30) De La Cruz Boulevard and Central Expressway \* (LOS F – AM and PM peak hours)
- (#36) Coleman Avenue and I-880 Southbound Ramps \* (LOS F – AM peak hour)
- (#37) Coleman Avenue and I-880 Northbound Ramps \* (LOS F – AM peak hour)
- (#41) San Tomas Expressway and El Camino Real \* (LOS F – AM and PM peak hours)
- (#58) The Alameda and W. Hedding Street \*: (LOS F – PM peak hour)
- (#59) The Alameda and W. Taylor St/Naglee Ave \*: (LOS F – AM peak hour)

## 2035 Cumulative Plus Project Conditions Intersection Impacts and Proposed Mitigation Measures

### City of San Jose Impact Analysis

When measured against the City of San Jose significant impact criteria for cumulative conditions, none of the study intersections near the Alum Rock/28<sup>th</sup> Street or Santa Clara Stations in San Jose would be significantly impacted by the project under 2035 Cumulative Plus Project Conditions.

Tables 24 and 25 present the percentage of cumulative trips that would be contributed by the Project. For intersections that operate at an acceptable level of service under 2025 Background Conditions but at an unacceptable level of service under 2035 Cumulative Plus Project Conditions, the determination of whether the Project would cause a significant impact is based on whether the Project would contribute a considerable amount of traffic (more than 25 percent) to any of those intersections. As shown in Tables 25 and 26, for the San Jose intersections that are projected to have an unacceptable level of service under 2035 Cumulative Plus Project Conditions, the Project's contribution to the increase in total volume from 2025 Background Conditions to 2035 Cumulative Plus Project Conditions would be less than 25 percent. Therefore, the Project would not have a significant impact on these intersections under 2035 Cumulative Plus Project Conditions, based on the City of San Jose significant impact criteria.

Specifically, at the five intersections near Alum Rock/28<sup>th</sup> Street Station that would fall to unacceptable levels of service from 2025 Background Conditions to 2035 Cumulative Plus Project Conditions during at least one peak hour, the Project would actually reduce the traffic volumes at four of these intersections, and increase traffic volumes at one intersection by only 2 percent, as shown below.

- (#7) King Road and McKee Road: AM peak hour LOS F (-20%), PM peak hour LOS E (-20%)
- (#18) Jackson Avenue and Alum Rock Ave\*: AM peak hour LOS F (0%); PM peak hour LOS E (-1%)
- (#23) Jackson Avenue and San Antonio St/Capitol Expressway: AM peak hour LOS E (-1%)
- (#26) McLaughlin Avenue and Story Road: AM peak hour LOS E (+2%)
- (#27) King Road and Mabury Road: PM peak hour LOS E (-27%)

The mode shift component of the Project would reduce the number of vehicles on the roadway network as people switch from passenger vehicles to BART. In addition, drive access trips under 2025 Background (No Project) Conditions would concentrate at the end-of-the-line Berryessa Station and impact the nearby intersections of King/McKee Roads and King/Mabury Roads. However, under 2035 Cumulative Plus Project Conditions, many of those drive access trips would shift to the closer Alum Rock/28<sup>th</sup> Street Station and, to a lesser degree, to the other stations of the Project (Diridon and Santa Clara), which would reduce traffic at the two King Road intersections.

Of the six City of San Jose intersections near the Santa Clara Station that would operate at unacceptable levels of service under 2035 Cumulative Plus Project Conditions during at least one peak hour, the Project would either reduce the traffic volumes or contribute less than 25 percent of the increase in traffic volumes, when 2025 Background and 2035 Cumulative Plus Project conditions are compared, as follows.

- (#36) Coleman Avenue and I-880 Southbound Ramps \*: AM peak hour LOS F (+7%)
- (#37) Coleman Avenue and I-880 Northbound Ramps \*: AM peak hour LOS F (-3%)
- (#38) Coleman Avenue and W. Hedding Street: AM and PM peak hours LOS E (-3%, -1%)
- (#39) Coleman and Taylor Street: AM peak hour LOS E (-5%) and PM peak hour LOS F (-2%)
- (#58) The Alameda and Hedding \*: AM peak hour LOS E (-1%) and PM peak hour LOS F (-1%)
- (#59) The Alameda and Taylor/Naglee Ave \*: AM peak hour LOS F (-2%) and PM peak hour LOS E (0%)

### City of Santa Clara Impact Analysis

When measured against the City of Santa Clara significant impact criteria for cumulative conditions, the following three Santa Clara intersections would be significantly impacted by the Project under 2035 Cumulative Plus Project Conditions.

- (#30) De La Cruz Boulevard and Central Expressway \*: PM peak hour
- (#33) Coleman Avenue and Brokaw Road: PM peak hour
- (#47) Lafayette Street and Lewis Street: PM peak hour

Mitigation measures for these intersections have been proposed as follows. The mitigation measure for #33 Coleman Avenue and Brokaw Road is the same as the measure discussed under 2025 Background Plus Project Mitigated Conditions:

**30. De La Cruz Boulevard and Central Expressway \***: The Santa Clara County Department of Roads and Airports plans to convert the existing eastbound High Occupancy Vehicle (HOV) lane to a mixed-use lane at this intersection. This modification was included as a change to the roadway network under both the 2025 Background Plus Project Conditions and 2035 Cumulative Plus Project Conditions. No other feasible mitigation measures have been identified for this intersection. Therefore, the impact at this intersection would be *significant and unavoidable*.

State Congestion Management law requires a local jurisdiction to prepare a deficiency plan (now referred to as 'Multimodal Improvement Plan' in the Santa Clara County CMP maintained by VTA) when roadway level of service standards are not maintained on the designated CMP system [California Government Code Section 65098.4]. VTA maintains guidelines for the development of Multimodal Improvement Plans which were developed in consultation with Member Agencies (i.e., the 15 cities of Santa Clara County and the County of Santa Clara) and last adopted by the VTA Board in September 2010. According to these guidelines, Multimodal Improvement Plans are prepared by Member Agencies in response to the transportation impacts of land use plans and development projects. The impact to this intersection is a result of the TOJD component of the Project and not due to the BART extension; however, VTA's guidelines do not address a situation where a land use project that is led by VTA contributes to an impact on a CMP facility. With this in mind, VTA commits to work with the City of Santa Clara and the County of Santa Clara in the preparation of a Multimodal Improvement Plan for identified Project impacts to CMP intersections.

**33. Coleman Avenue and Brokaw Road:** Change the signal control for Brokaw Road (the east and west legs of this intersection) from Protected Left-Turn phasing to Split Phase. Add a shared through/left-turn lane to the east and west approaches within the existing right-of-way. Change the existing shared through/right-turn lanes to right-turn only lanes on the east and west approaches, and change the eastbound right-turn coding from Include to Overlap, indicating that many eastbound right turns would be able to turn "right on red."

This mitigation measure is presented in Figure 30 in Chapter 4. With implementation of this mitigation measure, or a comparable mitigation measure as determined upon coordination with the City of Santa Clara, the intersection would operate at LOS D under 2035 Cumulative Plus Project Mitigated Conditions, and the impact would be reduced to a *less-than-significant* level.

**47. Lafayette Street and Lewis Street:** Shift the westbound approach lanes on Lewis Street to the south to allow for the current through/right-turn lane to operate as a separate right-turn lane and a separate through lane. A shift of approximately two feet would increase the current through/right-turn lane width to

20 feet, which would allow adequate room for right-turning vehicles to proceed past vehicles traveling straight through the intersection and make the right turn onto northbound Lafayette Street. The westbound approach and receiving lanes would be slightly offset as a result, which can be addressed with dashed pavement markings across the intersection.

With implementation of this mitigation, even though the intersection would continue to operate at LOS E in the PM peak hour under 2035 Cumulative Plus Project Mitigated Conditions, the control delay would be reduced from 66.3 seconds under 2035 Cumulative No Project Conditions to 56.8 seconds under 2035 Cumulative Plus Project Mitigated Conditions. With implementation of this mitigation measure, or a comparable mitigation measure as determined upon coordination with the City of Santa Clara, there would be a *less-than-significant* impact. This mitigation measure is presented in Figure 37.

### CMP Impact Analysis

When measured against the CMP significant impact criteria, the following two CMP intersections would be significantly impacted by the Project under 2035 Cumulative Plus Project Conditions:

- (#30) De La Cruz Boulevard and Central Expressway \*: PM peak hour
- (#36) Coleman Avenue and I-880 Southbound Ramps \*: AM peak hour

Of the nine CMP intersections (one near the Alum Rock/28<sup>th</sup> Street Station and eight near the Santa Clara Station) that would operate at an unacceptable level of service (LOS F) under 2035 Cumulative Plus Project Conditions, five are located in San Jose and four are located in Santa Clara. For the four Santa Clara CMP intersections, the CMP definition of significant impacts under 2035 Cumulative Plus Project Conditions is the same as the City of Santa Clara's definition of significant impacts for CMP intersections. Thus, the CMP impact criteria for these four CMP intersections located in Santa Clara are the same as applied for the City of Santa Clara impact discussion.

The first impacted intersection shown above (#30, De La Cruz Boulevard and Central Expressway) is in the City of Santa Clara. No feasible mitigation measures have been identified for this intersection, so the impact at this intersection under 2035 Cumulative Plus Project Conditions would be *significant and unavoidable*. As noted above, VTA commits to work with the City of Santa Clara and the County of Santa Clara in the preparation of a Multimodal Improvement Plan for identified Project impacts to CMP intersections.

For the CMP intersections that are located in San Jose, the CMP criteria are different than those used by the City of San Jose under cumulative conditions. For CMP intersections in San Jose where at least one peak hour would operate at LOS F, it is necessary to compare 2035 Cumulative No Project Conditions to 2035 Cumulative Plus Project Conditions.

For example, at the CMP intersection of Jackson Avenue and Alum Rock Avenue (#18) in the vicinity of Alum Rock/28<sup>th</sup> Street Station, the level of service under 2035 Cumulative Plus Project Conditions in the AM peak hour would be LOS F. However, the critical delay would decrease by -1.8 seconds when 2035 Cumulative Plus Project Conditions are compared to 2035 Cumulative No Project Conditions; therefore, under CMP criteria the Project would not have a significant impact at this intersection.

The Project would have a significant impact to the intersection of Coleman Avenue and I-880 Southbound ramps (#36) according to the CMP criteria (but not according to the City of San Jose criteria):

**36. Coleman Avenue and I-880 Southbound Ramps \***: Convert the second (center) left-turn lane on the I-880 off-ramp (the intersection's westbound approach) to a shared left/right-turn lane. Replace the lane control signs and revise the pavement markings on the off-ramp to reflect the new lane usage.

This mitigation measure is presented in Figure 29 in Chapter 4. With implementation of this mitigation measure, the intersection would operate at LOS E under 2035 Cumulative Plus Project Mitigated Conditions, and the average control delay in the AM peak hour would be reduced from 102 seconds under 2035 Cumulative No Project Conditions to 50.1 seconds under 2035 Cumulative Plus Project Mitigated Conditions. Thus, the impact would be reduced to a *less than significant* level under CMP criteria.





## 2035 Cumulative Conditions Freeway Segment Levels of Service

### CMP Definition of Significant Cumulative Freeway Segment Impacts

The CMP defines an acceptable level of service for freeway segments as LOS E or better. The CMP criteria for an impact under 2035 Cumulative Plus Project Conditions is the same as the criteria for 2025 Background Plus Project Conditions. A project is said to create a significant impact on traffic conditions on a freeway segment if for either peak hour:

1. The level of service on a freeway segment degrades from an acceptable LOS E or better under cumulative conditions to an unacceptable LOS F under cumulative plus project conditions, **or**.
2. The level of service on a freeway segment is operating at an unacceptable LOS F under cumulative conditions **and** the amount of project traffic on that segment constitutes at least one percent of capacity on that segment.

### 2035 Cumulative Conditions Freeway Segment Level of Service Analysis

Traffic volumes on the study freeway segments with the Project were estimated by adding project trips to the Year 2035 freeway segment volumes obtained from the VTA Travel Demand Forecasting Model. The results of the freeway segment analysis are shown in Table 27. The table shows that the Project would not cause significant increases in traffic volumes (one percent or more of freeway capacity) on any of the study freeway segments currently operating at LOS F, and none of the study freeway segments currently operating at LOS E or better would worsen to LOS F as a result of the project (see Table 27). In fact, many freeway segments would experience a decrease in volume, because the reduced number of trips on the freeway (due to the mode shift from passenger vehicles to BART) more than offsets the trips that would be generated by the TOJD portion of the Project. Therefore, based on CMP freeway impact criteria, none of the study freeway segments would be significantly impacted by the project under 2025 Cumulative Plus Project Conditions.



**Table 27**  
**Freeway Segment Levels of Service under 2035 Cumulative Plus Project Conditions**

| Freeway | Segment                   | Direction | Peak Hour | 2035 Phase II Cumulative Conditions |            |          |                   |         |                    |            |            |          |                   |         | Net Project Trips |             |           |              |                    |             |           |              |               |
|---------|---------------------------|-----------|-----------|-------------------------------------|------------|----------|-------------------|---------|--------------------|------------|------------|----------|-------------------|---------|-------------------|-------------|-----------|--------------|--------------------|-------------|-----------|--------------|---------------|
|         |                           |           |           | Mixed-Flow Lane                     |            |          |                   |         | HOV / Express Lane |            |            |          |                   |         | Mixed-Flow Lane   |             |           |              | HOV / Express Lane |             |           |              |               |
|         |                           |           |           | Avg. Speed                          | # of Lanes | Capacity | Cumulative Volume | Density | LOS                | Avg. Speed | # of Lanes | Capacity | Cumulative Volume | Density | LOS               | BART Volume | JD Volume | Total Volume | % of Capacity      | BART Volume | JD Volume | Total Volume | % of Capacity |
| US 101  | Tully to Story            | NB        | AM        | 25.0                                | 3.0        | 6,900    | 8,482             | 113     | F                  | 15.0       | 1.0        | 1,650    | 2,077             | 138     | F                 | -40         | 65        | 25           | 0.36               | -7          | 12        | 5            | 0.30          |
|         |                           |           | PM        | 66.0                                | 3.0        | 6,900    | 7,215             | 36      | D                  | 70.0       | 1.0        | 1,650    | 1,324             | 19      | C                 | -16         | 18        | 2            | 0.03               | -2          | 3         | 1            | 0.06          |
| US 101  | Story to I-280            | NB        | AM        | 22.0                                | 3.0        | 6,900    | 5,360             | 81      | F                  | 19.0       | 1.0        | 1,650    | 1,686             | 89      | F                 | -19         | 64        | 45           | 0.65               | -4          | 11        | 7            | 0.42          |
|         |                           |           | PM        | 67.0                                | 3.0        | 6,900    | 4,010             | 20      | C                  | 70.0       | 1.0        | 1,650    | 978               | 14      | B                 | -7          | 18        | 11           | 0.16               | -1          | 3         | 2            | 0.12          |
| US 101  | I-280 to Santa Clara      | NB        | AM        | 13.0                                | 3.0        | 6,900    | 7,790             | 200     | F                  | 13.0       | 1.0        | 1,650    | 1,932             | 149     | F                 | -40         | 87        | 47           | 0.68               | -5          | 15        | 10           | 0.61          |
|         |                           |           | PM        | 66.0                                | 3.0        | 6,900    | 5,714             | 29      | D                  | 70.0       | 1.0        | 1,650    | 1,034             | 15      | B                 | -23         | 26        | 3            | 0.04               | -1          | 5         | 4            | 0.24          |
| US 101  | Santa Clara to McKee      | NB        | AM        | 11.0                                | 3.0        | 6,900    | 7,813             | 237     | F                  | 16.0       | 1.0        | 1,650    | 1,739             | 109     | F                 | -115        | 49        | -66          | -0.96              | -4          | 9         | 5            | 0.30          |
|         |                           |           | PM        | 66.0                                | 3.0        | 6,900    | 5,523             | 28      | D                  | 70.0       | 1.0        | 1,650    | 881               | 13      | B                 | -59         | 14        | -45          | -0.65              | -1          | 3         | 2            | 0.12          |
| US 101  | I-880 to Old Bayshore     | NB        | AM        | 14.0                                | 3.0        | 6,900    | 5,972             | 142     | F                  | 19.0       | 1.0        | 1,650    | 1,882             | 99      | F                 | -11         | 16        | 5            | 0.07               | -7          | 3         | -4           | -0.24         |
|         |                           |           | PM        | 67.0                                | 3.0        | 6,900    | 3,752             | 19      | C                  | 70.0       | 1.0        | 1,650    | 657               | 9       | A                 | -5          | 1         | -4           | -0.06              | -1          | 0         | -1           | -0.06         |
| US 101  | Old Bayshore to First     | NB        | AM        | 12.0                                | 3.0        | 6,900    | 6,368             | 177     | F                  | 13.0       | 1.0        | 1,650    | 1,838             | 141     | F                 | -23         | 24        | 1            | 0.01               | -7          | 4         | -3           | -0.18         |
|         |                           |           | PM        | 66.0                                | 3.0        | 6,900    | 4,277             | 22      | C                  | 70.0       | 1.0        | 1,650    | 709               | 10      | A                 | -14         | 20        | 6            | 0.09               | -1          | 4         | 3            | 0.18          |
| US 101  | First to SR 87            | NB        | AM        | 19.0                                | 3.0        | 6,900    | 6,566             | 115     | F                  | 19.0       | 1.0        | 1,650    | 1,706             | 90      | F                 | -34         | 30        | -4           | -0.06              | -6          | 5         | -1           | -0.06         |
|         |                           |           | PM        | 67.0                                | 3.0        | 6,900    | 5,239             | 26      | C                  | 70.0       | 1.0        | 1,650    | 863               | 12      | B                 | -19         | 21        | 2            | 0.03               | -1          | 4         | 3            | 0.18          |
| US 101  | SR 87 to De La Cruz       | NB        | AM        | 12.0                                | 3.0        | 6,900    | 6,616             | 184     | F                  | 14.0       | 1.0        | 1,650    | 1,794             | 128     | F                 | -30         | 5         | -25          | -0.36              | -6          | 1         | -5           | -0.30         |
|         |                           |           | PM        | 66.0                                | 3.0        | 6,900    | 5,863             | 30      | D                  | 70.0       | 1.0        | 1,650    | 880               | 13      | B                 | -21         | 17        | -4           | -0.06              | -1          | 3         | 2            | 0.12          |
| US 101  | De La Cruz to Montague    | NB        | AM        | 26.0                                | 3.0        | 6,900    | 6,794             | 87      | F                  | 39.0       | 1.0        | 1,650    | 2,219             | 57      | E                 | -31         | 5         | -26          | -0.38              | -9          | 1         | -8           | -0.48         |
|         |                           |           | PM        | 65.0                                | 3.0        | 6,900    | 5,773             | 30      | D                  | 70.0       | 1.0        | 1,650    | 1,369             | 20      | C                 | -20         | 20        | 0            | 0.00               | -4          | 4         | 0            | 0.00          |
| US 101  | Montague to Great America | NB        | AM        | 21.0                                | 3.0        | 6,900    | 6,762             | 107     | F                  | 41.0       | 1.0        | 1,650    | 1,670             | 41      | D                 | -30         | 5         | -25          | -0.36              | -7          | 1         | -6           | -0.36         |
|         |                           |           | PM        | 58.0                                | 3.0        | 6,900    | 5,840             | 34      | D                  | 70.0       | 1.0        | 1,650    | 1,366             | 20      | C                 | -18         | 20        | 2            | 0.03               | -4          | 4         | 0            | 0.00          |
| US 101  | Great America to Montague | SB        | AM        | 66.0                                | 3.0        | 6,900    | 6,088             | 31      | D                  | 67.0       | 1.0        | 1,650    | 1,314             | 20      | C                 | -34         | 51        | 17           | 0.25               | -5          | 9         | 4            | 0.24          |
|         |                           |           | PM        | 14.0                                | 3.0        | 6,900    | 6,636             | 158     | F                  | 20.0       | 1.0        | 1,650    | 1,747             | 87      | F                 | -21         | 10        | -11          | -0.16              | -6          | 2         | -4           | -0.24         |
| US 101  | Montague to De La Cruz    | SB        | AM        | 66.0                                | 3.0        | 6,900    | 5,932             | 30      | D                  | 67.0       | 1.0        | 1,650    | 1,392             | 21      | C                 | -35         | 58        | 23           | 0.33               | -5          | 10        | 5            | 0.30          |
|         |                           |           | PM        | 13.0                                | 3.0        | 6,900    | 6,512             | 167     | F                  | 40.0       | 1.0        | 1,650    | 2,075             | 52      | E                 | -21         | 13        | -8           | -0.12              | -7          | 2         | -5           | -0.30         |
| US 101  | De La Cruz to SR 87       | SB        | AM        | 62.0                                | 3.0        | 6,900    | 6,744             | 36      | D                  | 67.0       | 1.0        | 1,650    | 1,113             | 17      | B                 | -41         | 44        | 3            | 0.04               | -5          | 8         | 3            | 0.18          |
|         |                           |           | PM        | 18.0                                | 3.0        | 6,900    | 8,270             | 153     | F                  | 50.0       | 1.0        | 1,650    | 2,236             | 45      | D                 | -26         | 26        | 0            | 0.00               | -7          | 5         | -2           | -0.12         |
| US 101  | SR 87 to First            | SB        | AM        | 67.0                                | 3.0        | 6,900    | 4,759             | 24      | C                  | 67.0       | 1.0        | 1,650    | 919               | 14      | B                 | -31         | 43        | 12           | 0.17               | -3          | 7         | 4            | 0.24          |
|         |                           |           | PM        | 16.0                                | 3.0        | 6,900    | 6,226             | 130     | F                  | 30.0       | 1.0        | 1,650    | 1,852             | 62      | F                 | -21         | 24        | 3            | 0.04               | -6          | 4         | -2           | -0.12         |
| US 101  | First to Old Bayshore     | SB        | AM        | 67.0                                | 3.0        | 6,900    | 3,467             | 17      | B                  | 67.0       | 1.0        | 1,650    | 756               | 11      | A                 | -27         | 43        | 16           | 0.23               | -3          | 7         | 4            | 0.24          |
|         |                           |           | PM        | 6.0                                 | 3.0        | 6,900    | 5,048             | 280     | F                  | 20.0       | 1.0        | 1,650    | 1,690             | 85      | F                 | -17         | 20        | 3            | 0.04               | -6          | 4         | -2           | -0.12         |
| US 101  | Old Bayshore to I-880     | SB        | AM        | 67.0                                | 3.0        | 6,900    | 4,566             | 23      | C                  | 67.0       | 1.0        | 1,650    | 758               | 11      | A                 | -27         | 50        | 23           | 0.33               | -3          | 9         | 6            | 0.36          |
|         |                           |           | PM        | 8.0                                 | 3.0        | 6,900    | 6,436             | 268     | F                  | 30.0       | 1.0        | 1,650    | 1,817             | 61      | F                 | -20         | 25        | 5            | 0.07               | -6          | 4         | -2           | -0.12         |
| US 101  | McKee to Santa Clara      | SB        | AM        | 67.0                                | 3.0        | 6,900    | 5,088             | 25      | C                  | 67.0       | 1.0        | 1,650    | 619               | 9       | A                 | -26         | 22        | -4           | -0.06              | -1          | 4         | 3            | 0.18          |
|         |                           |           | PM        | 62.0                                | 3.0        | 6,900    | 6,720             | 36      | D                  | 70.0       | 1.0        | 1,650    | 1,613             | 23      | C                 | 25          | 94        | 119          | 1.72               | -3          | 16        | 13           | 0.79          |
| US 101  | Santa Clara to I-280      | SB        | AM        | 67.0                                | 3.0        | 6,900    | 5,546             | 28      | D                  | 67.0       | 1.0        | 1,650    | 685               | 10      | A                 | -27         | 54        | 27           | 0.39               | -2          | 9         | 7            | 0.42          |
|         |                           |           | PM        | 63.0                                | 3.0        | 6,900    | 6,868             | 36      | D                  | 70.0       | 1.0        | 1,650    | 1,697             | 24      | C                 | 81          | 133       | 214          | 3.10               | -3          | 24        | 21           | 1.27          |
| US 101  | I-280 to Story            | SB        | AM        | 67.0                                | 3.0        | 6,900    | 3,680             | 18      | B                  | 67.0       | 1.0        | 1,650    | 614               | 9       | A                 | -7          | 20        | 13           | 0.19               | -1          | 3         | 2            | 0.12          |
|         |                           |           | PM        | 54.0                                | 3.0        | 6,900    | 4,830             | 30      | D                  | 70.0       | 1.0        | 1,650    | 1,391             | 20      | C                 | 5           | 64        | 69           | 1.00               | -2          | 11        | 9            | 0.55          |
| US 101  | Story to Tully            | SB        | AM        | 66.0                                | 4.0        | 9,200    | 8,173             | 31      | D                  | 67.0       | 1.0        | 1,650    | 961               | 14      | B                 | -24         | 19        | -5           | -0.05              | -2          | 3         | 1            | 0.06          |
|         |                           |           | PM        | 45.0                                | 4.0        | 9,200    | 9,416             | 52      | E                  | 70.0       | 1.0        | 1,650    | 1,736             | 25      | C                 | -17         | 72        | 55           | 0.60               | -3          | 13        | 10           | 0.61          |
| I-280   | I-880 to Meridian         | EB        | AM        | 66.0                                | 4.0        | 9,200    | 6,389             | 24      | C                  | 67.0       | 1.0        | 1,650    | 822               | 12      | B                 | -45         | 15        | -30          | -0.33              | -4          | 3         | -1           | -0.06         |
|         |                           |           | PM        | 17.0                                | 4.0        | 9,200    | 7,305             | 107     | F                  | 20.0       | 1.0        | 1,650    | 1,615             | 81      | F                 | -38         | 13        | -25          | -0.27              | -7          | 2         | -5           | -0.30         |

**Table 27 (Continued)**  
**Freeway Segment Levels of Service under 2035 Cumulative Plus Project Conditions**

| Freeway | Segment                       | Direction | Peak Hour | 2035 Phase II Cumulative Conditions |            |          |                   |         |     |                    |            |          |                   |         |     | Net Project Trips |           |              |               |                    |           |              |               |
|---------|-------------------------------|-----------|-----------|-------------------------------------|------------|----------|-------------------|---------|-----|--------------------|------------|----------|-------------------|---------|-----|-------------------|-----------|--------------|---------------|--------------------|-----------|--------------|---------------|
|         |                               |           |           | Mixed-Flow Lane                     |            |          |                   |         |     | HOV / Express Lane |            |          |                   |         |     | Mixed-Flow Lane   |           |              |               | HOV / Express Lane |           |              |               |
|         |                               |           |           | Avg. Speed                          | # of Lanes | Capacity | Cumulative Volume | Density | LOS | Avg. Speed         | # of Lanes | Capacity | Cumulative Volume | Density | LOS | BART Volume       | JD Volume | Total Volume | % of Capacity | BART Volume        | JD Volume | Total Volume | % of Capacity |
|         |                               |           |           | Speed                               | Lanes      | Capacity | Volume            | Density | LOS | Speed              | Lanes      | Capacity | Volume            | Density | LOS | Volume            | Volume    | Volume       | % of          | Volume             | Volume    | Volume       | % of          |
| I-280   | Meridian to Bird              | EB        | AM        | 61.0                                | 4.0        | 9,200    | 8,294             | 34      | D   | 55.0               | 1.0        | 1,650    | 534               | 10      | A   | -52               | 22        | -30          | -0.33         | -4                 | 4         | 0            | 0.00          |
|         |                               |           | PM        | 21.0                                | 4.0        | 9,200    | 9,012             | 107     | F   | 55.0               | 1.0        | 1,650    | 1,398             | 25      | C   | -46               | 12        | -34          | -0.37         | -7                 | 2         | -5           | -0.30         |
| I-280   | Bird to SR 87                 | EB        | AM        | 66.0                                | 4.0        | 9,200    | 4,362             | 17      | B   | 55.0               | 1.0        | 1,650    | 534               | 10      | A   | -44               | 13        | -31          | -0.34         | -4                 | 2         | -2           | -0.12         |
|         |                               |           | PM        | 25.0                                | 4.0        | 9,200    | 5,986             | 60      | F   | 55.0               | 1.0        | 1,650    | 1,398             | 25      | C   | -39               | 9         | -30          | -0.33         | -7                 | 2         | -5           | -0.30         |
| I-280   | SR 87 to 10th                 | EB        | AM        | 67.0                                | 4.0        | 9,200    | 6,480             | 24      | C   | 55.0               | 1.0        | 1,650    | 534               | 10      | A   | -79               | 22        | -57          | -0.62         | -4                 | 4         | 0            | 0.00          |
|         |                               |           | PM        | 27.0                                | 4.0        | 9,200    | 8,719             | 81      | F   | 55.0               | 1.0        | 1,650    | 1,398             | 25      | C   | -87               | 20        | -67          | -0.73         | -7                 | 4         | -3           | -0.18         |
| I-280   | 10th to McLaughlin            | EB        | AM        | 66.0                                | 4.0        | 9,200    | 7,564             | 29      | D   | 55.0               | 1.0        | 1,650    | 526               | 10      | A   | -142              | 13        | -129         | -1.40         | -7                 | 2         | -5           | -0.30         |
|         |                               |           | PM        | 54.0                                | 4.0        | 9,200    | 10,023            | 46      | D   | 55.0               | 1.0        | 1,650    | 1,363             | 25      | C   | -143              | 16        | -127         | -1.38         | -19                | 3         | -16          | -0.97         |
| I-280   | McLaughlin to US 101          | EB        | AM        | 66.0                                | 4.0        | 9,200    | 5,715             | 22      | C   | 55.0               | 1.0        | 1,650    | 526               | 10      | A   | -140              | 3         | -137         | -1.49         | -7                 | 1         | -6           | -0.36         |
|         |                               |           | PM        | 54.0                                | 4.0        | 9,200    | 7,126             | 33      | D   | 55.0               | 1.0        | 1,650    | 1,363             | 25      | C   | -118              | 9         | -109         | -1.18         | -19                | 1         | -18          | -1.09         |
| I-680   | US 101 to King                | NB        | AM        | 33.0                                | 4.0        | 9,200    | 5,525             | 42      | D   | 55.0               | 1.0        | 1,650    | 526               | 10      | A   | -135              | 3         | -132         | -1.43         | -7                 | 0         | -7           | -0.42         |
|         |                               |           | PM        | 66.0                                | 4.0        | 9,200    | 6,821             | 26      | C   | 55.0               | 1.0        | 1,650    | 1,363             | 25      | C   | -108              | 5         | -103         | -1.12         | -19                | 1         | -18          | -1.09         |
| I-680   | King to Capitol               | NB        | AM        | 20.0                                | 5.0        | 11,500   | 6,955             | 70      | F   | 55.0               | 1.0        | 1,650    | 526               | 10      | A   | -86               | 3         | -83          | -0.72         | -7                 | 0         | -7           | -0.42         |
|         |                               |           | PM        | 47.0                                | 5.0        | 11,500   | 8,896             | 38      | D   | 55.0               | 1.0        | 1,650    | 1,363             | 25      | C   | -80               | 10        | -70          | -0.61         | -19                | 2         | -17          | -1.03         |
| I-680   | Capitol to Alum Rock          | NB        | AM        | 18.0                                | 4.0        | 9,200    | 6,276             | 87      | F   | 55.0               | 1.0        | 1,650    | 593               | 11      | A   | -83               | 0         | -83          | -0.90         | -9                 | 0         | -9           | -0.55         |
|         |                               |           | PM        | 65.0                                | 4.0        | 9,200    | 6,783             | 26      | C   | 55.0               | 1.0        | 1,650    | 1,028             | 19      | C   | -73               | 1         | -72          | -0.78         | -16                | 0         | -16          | -0.97         |
| I-680   | Alum Rock to McKee            | NB        | AM        | 27.0                                | 4.0        | 9,200    | 7,133             | 66      | F   | 55.0               | 1.0        | 1,650    | 715               | 13      | B   | -88               | 0         | -88          | -0.96         | -10                | 0         | -10          | -0.61         |
|         |                               |           | PM        | 66.0                                | 4.0        | 9,200    | 7,421             | 28      | D   | 55.0               | 1.0        | 1,650    | 988               | 18      | B   | -76               | 9         | -67          | -0.73         | -16                | 1         | -15          | -0.91         |
| I-680   | McKee to Alum Rock            | SB        | AM        | 63.0                                | 4.0        | 9,200    | 7,592             | 30      | D   | 55.0               | 1.0        | 1,650    | 1,322             | 24      | C   | -103              | 9         | -94          | -1.02         | -26                | 1         | -25          | -1.52         |
|         |                               |           | PM        | 47.0                                | 4.0        | 9,200    | 7,345             | 39      | D   | 55.0               | 1.0        | 1,650    | 760               | 14      | B   | -84               | 2         | -82          | -0.89         | -9                 | 0         | -9           | -0.55         |
| I-680   | Alum Rock to Capitol          | SB        | AM        | 23.0                                | 4.0        | 9,200    | 6,858             | 75      | F   | 55.0               | 1.0        | 1,650    | 1,322             | 24      | C   | -110              | 7         | -103         | -1.12         | -26                | 1         | -25          | -1.52         |
|         |                               |           | PM        | 65.0                                | 4.0        | 9,200    | 6,079             | 23      | C   | 55.0               | 1.0        | 1,650    | 760               | 14      | B   | -77               | 0         | -77          | -0.84         | -9                 | 0         | -9           | -0.55         |
| I-680   | Capitol to King               | SB        | AM        | 21.0                                | 4.0        | 9,200    | 9,776             | 116     | F   | 55.0               | 1.0        | 1,650    | 1,488             | 27      | D   | -130              | 19        | -111         | -1.21         | -29                | 3         | -26          | -1.58         |
|         |                               |           | PM        | 66.0                                | 4.0        | 9,200    | 7,728             | 29      | D   | 55.0               | 1.0        | 1,650    | 598               | 11      | A   | -81               | 1         | -80          | -0.87         | -8                 | 0         | -8           | -0.48         |
| I-680   | King to US 101                | SB        | AM        | 12.0                                | 4.0        | 9,200    | 6,612             | 138     | F   | 55.0               | 1.0        | 1,650    | 1,488             | 27      | D   | -145              | 11        | -134         | -1.46         | -29                | 2         | -27          | -1.64         |
|         |                               |           | PM        | 66.0                                | 4.0        | 9,200    | 5,268             | 20      | C   | 55.0               | 1.0        | 1,650    | 598               | 11      | A   | -108              | 0         | -108         | -1.17         | -8                 | 0         | -8           | -0.48         |
| I-280   | US 101 to McLaughlin          | WB        | AM        | 14.0                                | 4.0        | 9,200    | 6,612             | 118     | F   | 55.0               | 1.0        | 1,650    | 1,488             | 27      | D   | -145              | 11        | -134         | -1.46         | -29                | 2         | -27          | -1.64         |
|         |                               |           | PM        | 66.0                                | 4.0        | 9,200    | 5,268             | 20      | C   | 55.0               | 1.0        | 1,650    | 598               | 11      | A   | -108              | 0         | -108         | -1.17         | -8                 | 0         | -8           | -0.48         |
| I-280   | McLaughlin to 10th            | WB        | AM        | 19.0                                | 4.0        | 9,200    | 10,425            | 137     | F   | 55.0               | 1.0        | 1,650    | 1,488             | 27      | D   | -186              | 37        | -149         | -1.62         | -29                | 7         | -22          | -1.33         |
|         |                               |           | PM        | 65.0                                | 4.0        | 9,200    | 7,867             | 30      | D   | 55.0               | 1.0        | 1,650    | 598               | 11      | A   | -46               | 57        | 11           | 0.12          | -8                 | 10        | 2            | 0.12          |
| I-280   | 10th to SR 87                 | WB        | AM        | 21.0                                | 4.0        | 9,200    | 10,153            | 121     | F   | 55.0               | 1.0        | 1,650    | 1,417             | 26      | C   | -151              | 29        | -122         | -1.33         | -13                | 5         | -8           | -0.48         |
|         |                               |           | PM        | 65.0                                | 4.0        | 9,200    | 8,368             | 32      | D   | 55.0               | 1.0        | 1,650    | 536               | 10      | A   | -30               | 56        | 26           | 0.28          | -3                 | 10        | 7            | 0.42          |
| I-280   | SR 87 to Bird                 | WB        | AM        | 20.0                                | 4.0        | 9,200    | 6,100             | 76      | F   | 55.0               | 1.0        | 1,650    | 1,417             | 26      | C   | -65               | 13        | -52          | -0.57         | -13                | 2         | -11          | -0.67         |
|         |                               |           | PM        | 62.0                                | 4.0        | 9,200    | 5,303             | 21      | C   | 55.0               | 1.0        | 1,650    | 536               | 10      | A   | 10                | 40        | 50           | 0.54          | -3                 | 7         | 4            | 0.24          |
| I-280   | Bird to Meridian              | WB        | AM        | 18.0                                | 4.0        | 9,200    | 9,535             | 132     | F   | 55.0               | 1.0        | 1,650    | 1,417             | 26      | C   | -77               | 15        | -62          | -0.67         | -13                | 3         | -10          | -0.61         |
|         |                               |           | PM        | 58.0                                | 4.0        | 9,200    | 8,744             | 38      | D   | 55.0               | 1.0        | 1,650    | 536               | 10      | A   | 6                 | 43        | 49           | 0.53          | -3                 | 7         | 4            | 0.24          |
| I-280   | Meridian to I-880             | WB        | AM        | 14.0                                | 3.0        | 6,900    | 7,771             | 185     | F   | 26.0               | 1.0        | 1,650    | 1,701             | 65      | F   | -62               | 14        | -48          | -0.70         | -14                | 3         | -11          | -0.67         |
|         |                               |           | PM        | 66.0                                | 3.0        | 6,900    | 6,590             | 33      | D   | 70.0               | 1.0        | 1,650    | 804               | 11      | A   | 16                | 32        | 48           | 0.70          | -4                 | 6         | 2            | 0.12          |
| SR 87   | Curtner to Almaden Expressway | NB        | AM        | 13.0                                | 2.0        | 4,400    | 3,885             | 149     | F   | 22.0               | 1.0        | 1,650    | 1,763             | 80      | F   | -9                | 15        | 6            | 0.14          | -5                 | 3         | -2           | -0.12         |
|         |                               |           | PM        | 65.0                                | 2.0        | 4,400    | 3,220             | 25      | C   | 70.0               | 1.0        | 1,650    | 921               | 13      | B   | 3                 | 3         | 6            | 0.14          | -1                 | 0         | -1           | -0.06         |
| SR 87   | Almaden Expressway to Alma    | NB        | AM        | 29.0                                | 2.0        | 4,400    | 4,896             | 84      | F   | 43.0               | 1.0        | 1,650    | 2,190             | 51      | E   | -11               | 18        | 7            | 0.16          | -6                 | 3         | -3           | -0.18         |
|         |                               |           | PM        | 41.0                                | 2.0        | 4,400    | 3,937             | 48      | E   | 70.0               | 1.0        | 1,650    | 1,037             | 15      | B   | 2                 | 4         | 6            | 0.14          | -1                 | 1         | 0            | 0.00          |
| SR 87   | Alma to I-280                 | NB        | AM        | 33.0                                | 2.0        | 4,400    | 6,061             | 92      | F   | 61.0               | 1.0        | 1,650    | 2,235             | 37      | D   | -12               | 18        | 6            | 0.14          | -6                 | 3         | -3           | -0.18         |
|         |                               |           | PM        | 66.0                                | 2.0        | 4,400    | 4,561             | 35      | D   | 70.0               | 1.0        | 1,650    | 1,124             | 16      | B   | 2                 | 4         | 6            | 0.14          | -2                 | 1         | -1           | -0.06         |
| SR 87   | I-280 to Julian               | NB        | AM        | 16.0                                | 2.0        | 4,400    | 2,881             | 90      | F   | 30.0               | 1.0        | 1,650    | 1,468             | 49      | E   | -3                | 3         | 0            | 0.00          | -3                 | 0         | -3           | -0.18         |
|         |                               |           | PM        | 67.0                                | 2.0        | 4,400    | 1,750             | 13      | B   | 70.0               | 1.0        | 1,650    | 460               | 7       | A   | -3                | 0         | -3           | -0.07         | -1                 | 0         | -1           | -0.06         |
| SR 87   | Julian to Coleman             | NB        | AM        | 14.0                                | 2.0        | 4,400    | 4,576             | 163     | F   | 32.0               | 1.0        | 1,650    | 1,508             | 47      | E   | -34               | 12        | -22          | -0.50         | -6                 | 2         | -4           | -0.24         |
|         |                               |           | PM        | 67.0                                | 2.0        | 4,400    | 2,549             | 19      | C   | 70.0               | 1.0        | 1,650    | 744               | 11      | A   | -45               | 4         | -41          | -0.93         | -2                 | 1         | -1           | -0.06         |
| SR 87   | Coleman to Julian             | SB        | AM        | 66.0                                | 2.0        | 4,400    | 2,116             | 16      | B   | 67.0               | 1.0        | 1,650    | 624               | 9       | A   | -35               | 2         | -33          | -0.75         | 0                  | 0         | 0            | 0.00          |
|         |                               |           | PM        | 32.0                                | 2.0        | 4,400    | 3,816             | 60      | F   | 50.0               | 1.0        | 1,650    | 1,324             | 26      | C   | -18               | 6         | -12          | -0.27         | -3                 | 1         | -2           | -0.12         |

**Table 27 (Continued)**  
**Freeway Segment Levels of Service under 2035 Cumulative Plus Project Conditions**

| Freeway | Segment                       | Direction | Peak Hour | 2035 Phase II Cumulative Conditions |            |          |                   |            |                    |            |            |          |                   |         | Net Project Trips |             |           |              |                    |             |           |              |               |
|---------|-------------------------------|-----------|-----------|-------------------------------------|------------|----------|-------------------|------------|--------------------|------------|------------|----------|-------------------|---------|-------------------|-------------|-----------|--------------|--------------------|-------------|-----------|--------------|---------------|
|         |                               |           |           | Mixed-Flow Lane                     |            |          |                   |            | HOV / Express Lane |            |            |          |                   |         | Mixed-Flow Lane   |             |           |              | HOV / Express Lane |             |           |              |               |
|         |                               |           |           | Avg. Speed                          | # of Lanes | Capacity | Cumulative Volume | Density    | LOS                | Avg. Speed | # of Lanes | Capacity | Cumulative Volume | Density | LOS               | BART Volume | JD Volume | Total Volume | % of Capacity      | BART Volume | JD Volume | Total Volume | % of Capacity |
| SR 87   | Julian to I-280               | SB        | AM        | 67.0                                | 2.0        | 4,400    | 2,631             | 20         | C                  | 67.0       | 1.0        | 1,650    | 497               | 7       | A                 | -12         | 6         | -6           | -0.14              | 0           | 1         | 1            | 0.06          |
|         |                               |           | PM        | 36.0                                | 2.0        | 4,400    | 4,383             | <b>61</b>  | F                  | 70.0       | 1.0        | 1,650    | 1,509             | 22      | C                 | -11         | 15        | 4            | 0.09               | -2          | 3         | 1            | 0.06          |
| SR 87   | I-280 to Alma                 | SB        | AM        | 67.0                                | 2.0        | 4,400    | 3,215             | 24         | C                  | 67.0       | 1.0        | 1,650    | 631               | 9       | A                 | 4           | 4         | 8            | 0.18               | -1          | 1         | 0            | 0.00          |
|         |                               |           | PM        | 15.0                                | 2.0        | 4,400    | 4,046             | <b>135</b> | F                  | 60.0       | 1.0        | 1,650    | 1,641             | 27      | D                 | 3           | 9         | 12           | 0.27               | -4          | 2         | -2           | -0.12         |
| SR 87   | Alma to Almaden Expressway    | SB        | AM        | 66.0                                | 2.0        | 4,400    | 3,889             | 29         | D                  | 67.0       | 1.0        | 1,650    | 720               | 11      | A                 | 3           | 4         | 7            | 0.16               | -1          | 1         | 0            | 0.00          |
|         |                               |           | PM        | 27.0                                | 2.0        | 4,400    | 4,529             | <b>84</b>  | F                  | 60.0       | 1.0        | 1,650    | 1,921             | 32      | D                 | -2          | 17        | 15           | 0.34               | -4          | 3         | -1           | -0.06         |
| SR 87   | Almaden Expressway to Curtner | SB        | AM        | 66.0                                | 2.0        | 4,400    | 2,881             | 22         | C                  | 67.0       | 1.0        | 1,650    | 639               | 10      | A                 | 3           | 3         | 6            | 0.14               | -1          | 1         | 0            | 0.00          |
|         |                               |           | PM        | 36.0                                | 2.0        | 4,400    | 3,508             | 49         | E                  | 70.0       | 1.0        | 1,650    | 1,621             | 23      | C                 | -1          | 12        | 11           | 0.25               | -4          | 2         | -2           | -0.12         |
| I-880   | I-280 to Stevens Creek        | NB        | AM        | 15.0                                | 3.0        | 6,900    | 5,066             | <b>113</b> | F                  | 55.0       | 1.0        | 1,650    | 640               | 12      | B                 | -42         | 45        | 3            | 0.04               | -2          | 8         | 6            | 0.36          |
|         |                               |           | PM        | 66.0                                | 3.0        | 6,900    | 4,722             | 24         | C                  | 55.0       | 1.0        | 1,650    | 731               | 13      | B                 | -29         | 7         | -22          | -0.32              | -3          | 1         | -2           | -0.12         |
| I-880   | Stevens Creek to Bascom       | NB        | AM        | 20.0                                | 3.0        | 6,900    | 6,789             | <b>113</b> | F                  | 55.0       | 1.0        | 1,650    | 571               | 10      | A                 | -73         | 50        | -23          | -0.33              | -2          | 9         | 7            | 0.42          |
|         |                               |           | PM        | 16.0                                | 3.0        | 6,900    | 5,925             | <b>123</b> | F                  | 55.0       | 1.0        | 1,650    | 683               | 12      | B                 | -39         | 8         | -31          | -0.45              | -3          | 1         | -2           | -0.12         |
| I-880   | Bascom to The Alameda         | NB        | AM        | 27.0                                | 3.0        | 6,900    | 6,216             | <b>77</b>  | F                  | 55.0       | 1.0        | 1,650    | 677               | 12      | B                 | -81         | 31        | -50          | -0.72              | -3          | 6         | 3            | 0.18          |
|         |                               |           | PM        | 13.0                                | 3.0        | 6,900    | 6,174             | <b>158</b> | F                  | 55.0       | 1.0        | 1,650    | 790               | 14      | B                 | -53         | 12        | -41          | -0.59              | -4          | 2         | -2           | -0.12         |
| I-880   | The Alameda to Coleman        | NB        | AM        | 31.0                                | 3.0        | 6,900    | 6,388             | <b>69</b>  | F                  | 55.0       | 1.0        | 1,650    | 677               | 12      | B                 | -104        | 32        | -72          | -1.04              | -4          | 6         | 2            | 0.12          |
|         |                               |           | PM        | 15.0                                | 3.0        | 6,900    | 6,397             | <b>142</b> | F                  | 55.0       | 1.0        | 1,650    | 1,034             | 19      | C                 | -73         | 20        | -53          | -0.77              | -8          | 3         | -5           | -0.30         |
| I-880   | Coleman to SR 87              | NB        | AM        | 22.0                                | 3.0        | 6,900    | 6,047             | <b>92</b>  | F                  | 55.0       | 1.0        | 1,650    | 785               | 14      | B                 | -118        | 35        | -83          | -1.20              | -8          | 6         | -2           | -0.12         |
|         |                               |           | PM        | 24.0                                | 3.0        | 6,900    | 6,474             | <b>90</b>  | F                  | 55.0       | 1.0        | 1,650    | 1,174             | 21      | C                 | -91         | 26        | -65          | -0.94              | -15         | 4         | -11          | -0.67         |
| I-880   | SR 87 to First                | NB        | AM        | 48.0                                | 3.0        | 6,900    | 6,047             | 42         | D                  | 55.0       | 1.0        | 1,650    | 785               | 14      | B                 | -118        | 35        | -83          | -1.20              | -8          | 6         | -2           | -0.12         |
|         |                               |           | PM        | 22.0                                | 3.0        | 6,900    | 6,474             | <b>98</b>  | F                  | 55.0       | 1.0        | 1,650    | 1,174             | 21      | C                 | -91         | 26        | -65          | -0.94              | -15         | 4         | -11          | -0.67         |
| I-880   | First to US 101               | NB        | AM        | 36.0                                | 3.0        | 6,900    | 5,719             | 53         | E                  | 55.0       | 1.0        | 1,650    | 669               | 12      | B                 | -122        | 32        | -90          | -1.30              | -7          | 6         | -1           | -0.06         |
|         |                               |           | PM        | 51.0                                | 3.0        | 6,900    | 6,613             | 43         | D                  | 55.0       | 1.0        | 1,650    | 1,027             | 19      | C                 | -104        | 22        | -82          | -1.19              | -14         | 4         | -10          | -0.61         |
| I-880   | US 101 to First               | SB        | AM        | 16.0                                | 3.0        | 6,900    | 6,278             | <b>131</b> | F                  | 55.0       | 1.0        | 1,650    | 1,082             | 20      | C                 | -89         | 23        | -66          | -0.96              | -17         | 4         | -13          | -0.79         |
|         |                               |           | PM        | 14.0                                | 3.0        | 6,900    | 5,911             | <b>141</b> | F                  | 55.0       | 1.0        | 1,650    | 973               | 18      | B                 | -135        | 16        | -119         | -1.72              | -7          | 3         | -4           | -0.24         |
| I-880   | First to SR 87                | SB        | AM        | 25.0                                | 3.0        | 6,900    | 5,729             | <b>76</b>  | F                  | 55.0       | 1.0        | 1,650    | 1,228             | 22      | C                 | -77         | 34        | -43          | -0.62              | -17         | 6         | -11          | -0.67         |
|         |                               |           | PM        | 14.0                                | 3.0        | 6,900    | 5,726             | <b>136</b> | F                  | 55.0       | 1.0        | 1,650    | 1,123             | 20      | C                 | -121        | 20        | -101         | -1.46              | -7          | 4         | -3           | -0.18         |
| I-880   | SR 87 to Coleman              | SB        | AM        | 65.0                                | 3.0        | 6,900    | 5,729             | 29         | D                  | 55.0       | 1.0        | 1,650    | 1,228             | 22      | C                 | -77         | 34        | -43          | -0.62              | -17         | 6         | -11          | -0.67         |
|         |                               |           | PM        | 23.0                                | 3.0        | 6,900    | 5,726             | <b>83</b>  | F                  | 55.0       | 1.0        | 1,650    | 1,123             | 20      | C                 | -121        | 20        | -101         | -1.46              | -7          | 4         | -3           | -0.18         |
| I-880   | Coleman to The Alameda        | SB        | AM        | 66.0                                | 3.0        | 6,900    | 6,364             | 32         | D                  | 55.0       | 1.0        | 1,650    | 912               | 17      | B                 | -82         | 10        | -72          | -1.04              | -5          | 2         | -3           | -0.18         |
|         |                               |           | PM        | 23.0                                | 3.0        | 6,900    | 6,511             | <b>94</b>  | F                  | 55.0       | 1.0        | 1,650    | 934               | 17      | B                 | -121        | 15        | -106         | -1.54              | -3          | 3         | 0            | 0.00          |
| I-880   | The Alameda to Bascom         | SB        | AM        | 66.0                                | 3.0        | 6,900    | 5,867             | 30         | D                  | 55.0       | 1.0        | 1,650    | 778               | 14      | B                 | -51         | 3         | -48          | -0.70              | -4          | 1         | -3           | -0.18         |
|         |                               |           | PM        | 25.0                                | 3.0        | 6,900    | 6,326             | <b>84</b>  | F                  | 55.0       | 1.0        | 1,650    | 1,018             | 19      | C                 | -105        | 13        | -92          | -1.33              | -3          | 2         | -1           | -0.06         |
| I-880   | Bascom to Stevens Creek       | SB        | AM        | 50.0                                | 3.0        | 6,900    | 6,003             | 40         | D                  | 55.0       | 1.0        | 1,650    | 830               | 15      | B                 | -43         | 9         | -34          | -0.49              | -4          | 1         | -3           | -0.18         |
|         |                               |           | PM        | 30.0                                | 3.0        | 6,900    | 6,639             | <b>74</b>  | F                  | 55.0       | 1.0        | 1,650    | 1,120             | 20      | C                 | -92         | 39        | -53          | -0.77              | -3          | 7         | 4            | 0.24          |
| I-880   | Stevens Creek to I-280        | SB        | AM        | 66.0                                | 3.0        | 6,900    | 4,964             | 25         | C                  | 55.0       | 1.0        | 1,650    | 662               | 12      | B                 | -32         | 8         | -24          | -0.35              | -3          | 1         | -2           | -0.12         |
|         |                               |           | PM        | 65.0                                | 3.0        | 6,900    | 4,985             | 26         | C                  | 55.0       | 1.0        | 1,650    | 952               | 17      | B                 | -69         | 32        | -37          | -0.54              | -3          | 6         | 3            | 0.18          |

Source: Santa Clara Valley Transportation Authority Congestion Management Program Monitoring Study, 2014.  
 The average speed for future HOV lanes are assumed to be 55 MPH.

3.10%

1.27%

**Bold** indicates unacceptable LOS.  
**Boxed** indicate significant impact.

**VTA's BART Silicon Valley -  
Phase II Extension Project**

Transportation Impact Analysis of the  
BART Extension and VTA's  
Transit-Oriented Joint Development  
**Technical Appendices**

## **Appendix A**

**Study Intersections in the “BART Extension TIA,”  
the “BART Extension with TOJD TIA,”  
and the SEIS/SEIR**

## Appendix A

### Study Intersections in the “BART Extension TIA,” the “BART Extension with TOJD TIA,” and the SEIS/SEIR

Two separate Transportation Impact Analyses (TIAs) have been prepared by Hexagon Transportation Consultants, Inc. for VTA’s BART Silicon Valley – Phase II Extension Project:

- *Transportation Impact Analysis of the BART Extension Only* (“BART Extension TIA”)
- *Transportation Impact Analysis of the BART Extension and VTA’s Transit-Oriented Joint Development* (“BART Extension with TOJD TIA”)

The results of these TIAs have been incorporated into a single Supplemental Environmental Impact Statement/Subsequent Environmental Impact Report (SEIS/SEIR). The SEIS/SEIR identifies three alternatives for analysis:

1. The “No Build” Alternative (for NEPA and CEQA purposes) – which is referred to as the “No Project/Phase I” scenario in the BART Extension TIA and the “No Project” scenario in the BART Extension with TOJD TIA;
2. The BART Extension Alternative (for NEPA and CEQA purposes), which includes the results of the BART Extension TIA;
3. The BART Extension with TOJD Alternative (for CEQA purposes only), which includes the results of the BART Extension with TOJD TIA.

The two TIAs discuss a different number of intersections at different stations. Because the TOJD would generate additional trips, there are more intersections with the potential for 10 additional vehicles per lane per hour under the BART Extension with TOJD Alternative. The following table summarizes the total number of intersections (including CMP intersections) and the number of CMP intersections discussed at each station under each alternative.

**Table A-1  
Summary of Intersections under Each Alternative**

| Phase II BART Station         | No Build Alternative Intersections |     | BART Extension Alternative Intersections |     | BART Extension with TOJD Alternative Intersections |     |
|-------------------------------|------------------------------------|-----|--|-----|--|-----|
|                               | Total                              | CMP | Total                                    | CMP | Total  | CMP |
| Alum Rock/28th Street Station | 27                                 | 7   | 17                                       | 3   | 27   | 7   |
| Diridon Station <sup>a</sup>  | 29                                 | 10  | 29                                       | 10  | 0  | 0   |
| Santa Clara Station           | 35                                 | 15  | 17                                       | 6   | 35   | 15  |
| <b>TOTAL Intersections</b>    | 91                                 | 32  | 63                                       | 19  | 62   | 22  |

Note:  
(a) The Diridon Station was not included in the BART Extension with TOJD Alternative because the station is within the Downtown Core Area defined by the "San Jose Downtown Strategy 2000 EIR" and the proposed TOJD is fully consistent with that EIR.



The following three tables present the names of all intersections included in any of the alternatives at the three stations discussed in the SEIS/SEIR. Note that a different numbering system is used for the study intersections in the two TIAs. The intersection numbers used in the BART Extension TIA and in the BART Extension with TOJD TIA are shown for reference. Intersections were referred to only by name – and not by number – in the SEIS/SEIR.

**Table A-2**  
**Study Intersections Near the Alum Rock/28<sup>th</sup> Street Station**

| Intersection <sup>1</sup>   | City     | No Build Alternative in SEIS/SEIR | BART Extension Alternative/ Intersection # in BART Extension TIA | BART Ext. with TOJD Alternative/ Intersection # in BART Extension with TOJD TIA |
|---|----------|-----------------------------------|--|---|
| <b>Alum Rock/28th Street Station</b>  |          |                                   |  |   |
| 21st Street and E. Julian Street  | San Jose | Yes                               | 1  | 1   |
| 24th Street and E. Julian Street  | San Jose | Yes                               | 2  | 2   |
| N. 28th Street and E. Julian Street   | San Jose | Yes                               | 3  | 3   |
| US 101 SB ramps and E. Julian Street  | San Jose | Yes                               | 4  | 4   |
| US 101 NB ramps and McKee Road  | San Jose | Yes                               | 5  | 5   |
| 33rd Street and McKee Road  | San Jose | Yes                               |  | 6   |
| King Road and McKee Road  | San Jose | Yes                               | 6  | 7   |
| Jackson Ave and McKee Road  | San Jose | Yes                               |  | 8   |
| 17th Street and E Santa Clara Street  | San Jose | Yes                               | 7  | 9   |
| 21st Street and E. Santa Clara Street   | San Jose | Yes                               | 16   | 10  |
| 24th Street and E. Santa Clara Street   | San Jose | Yes                               | 8  | 11  |
| 26th Street and E. Santa Clara Street   | San Jose | Yes                               | 17   | 12  |
| N. 28th Street and E. Santa Clara Street  | San Jose | Yes                               | 9  | 13  |
| US 101 and E. Santa Clara Street *  | San Jose | Yes                               | 10   | 14  |
| US 101 and Alum Rock Avenue *   | San Jose | Yes                               | 11   | 15  |
| 33rd Street and Alum Rock Avenue  | San Jose | Yes                               |  | 16  |
| King Road and Alum Rock Avenue*   | San Jose | Yes                               |  | 17  |
| Jackson Ave and Alum Rock Avenue*   | San Jose | Yes                               |  | 18  |
| I-680 South and Alum Rock Ave (West)*   | San Jose | Yes                               |  | 19  |
| I-680 North and Alum Rock Ave (East)*   | San Jose | Yes                               |  | 20  |
| 24th Street and San Antonio Street  | San Jose | Yes                               | 12   | 21  |
| King Road and E. San Antonio Street   | San Jose | Yes                               |  | 22  |
| Jackson Ave and San Antonio/Capitol Expwy   | San Jose | Yes                               |  | 23  |
| 24th Street and East William Street   | San Jose | Yes                               | 13   | 24  |
| McLaughlin Ave and I-280 SB Ramp *  | San Jose | Yes                               | 14   | 25  |
| McLaughlin Ave and Story Road   | San Jose | Yes                               | 15   | 26  |
| King Road and Mabury Road   | San Jose | Yes                               |  | 27  |
| <b>Notes:</b>   |          |                                   |  |   |
| * Denotes a CMP intersection  |          |                                   |  |   |
| <sup>1</sup> There are 27 study intersections for the "No Build" Alternative and the "BART Extension with TOJD" Alternative. There are 17 study intersections for the "BART Extension" Alternative. |          |                                   |  |   |

**Table A-3  
Study Intersections Near the Diridon Station**

| Intersection <sup>1</sup>  | City     | No Build Alternative in SEIS/SEIR | BART Extension Alternative/ Intersection # in BART Extension TIA | BART Ext. with TOJD Alternative/ Intersection # in BART Extension with TOJD TIA |
|--|----------|-----------------------------------|--|---|
| <b>Diridon Station</b>   |          |                                   |  |   |
| The Alameda and Taylor St/Naglee Ave*  | San Jose | Yes                               | 1  | No  |
| Stockton Ave and W. Julian Street  | San Jose | Yes                               | 2  | No  |
| N. Montgomery St and W. Julian Street  | San Jose | Yes                               | 3  | No  |
| N. Autumn St. and W. Julian Street   | San Jose | Yes                               | 4  | No  |
| SR 87 (W) and W. Julian Street*  | San Jose | Yes                               | 5  | No  |
| SR 87 (E) and W. Julian Street*  | San Jose | Yes                               | 6  | No  |
| The Alameda and W. Julian Street   | San Jose | Yes                               | 7  | No  |
| Race Street/Martin Ave and The Alameda*  | San Jose | Yes                               | 8  | No  |
| Stockton Avenue and The Alameda  | San Jose | Yes                               | 9  | No  |
| Cahill Street and W. Santa Clara Street  | San Jose | Yes                               | 10   | No  |
| S. Montgomery St and W Santa Clara St*   | San Jose | Yes                               | 11   | No  |
| S. Autumn St and W Santa Clara St*   | San Jose | Yes                               | 12   | No  |
| SR 87 and W Santa Clara St*  | San Jose | Yes                               | 13   | No  |
| S. Montgomery St and San Fernando St.  | San Jose | Yes                               | 14   | No  |
| S. Autumn St. and San Fernando St.   | San Jose | Yes                               | 15   | No  |
| Delmas Ave. and San Fernando St.   | San Jose | Yes                               | 16   | No  |
| S. Montgomery/Autumn St and Park Ave.  | San Jose | Yes                               | 17   | No  |
| Delmas Ave. and Park Ave.  | San Jose | Yes                               | 18   | No  |
| Meridian Ave. and San Carlos Street  | San Jose | Yes                               | 19   | No  |
| Race Street and San Carlos Street  | San Jose | Yes                               | 20   | No  |
| Lincoln Ave. and San Carlos Street   | San Jose | Yes                               | 21   | No  |
| Bird Avenue and San Carlos Street*   | San Jose | Yes                               | 22   | No  |
| Bird Avenue and Auzerais Avenue  | San Jose | Yes                               | 23   | No  |
| Meridian Ave. and Parkmoor Ave.  | San Jose | Yes                               | 24   | No  |
| Lincoln Ave. and Parkmoor Ave.   | San Jose | Yes                               | 25   | No  |
| Bird Avenue and I-280 (N)*   | San Jose | Yes                               | 26   | No  |
| Bird Avenue and I-280 (S)*   | San Jose | Yes                               | 27   | No  |
| Southwest Expressway and Fruitdale Ave   | San Jose | Yes                               | 28   | No  |
| Meridian Ave and Fruitdale Ave   | San Jose | Yes                               | 29   | No  |
| <b>Notes:</b>  |          |                                   |  |   |
| * Denotes a CMP intersection   |          |                                   |  |   |
| <sup>1</sup> There are 29 study intersections for the "No Build" Alternative and the "BART Extension" Alternative.<br>The Diridon Station was not analyzed under the "BART Extension with TOJD" Alternative because the station is within the Downtown Core Area defined by the "San Jose Downtown Strategy 2000 EIR" and the proposed TOJD is fully consistent with that EIR. |          |                                   |  |   |

**Table A-4  
Study Intersections Near the Santa Clara Station**

| Intersection <sup>1</sup>  | City        | No Build<br>Alternative<br>in SEIS/SEIR | BART Extension<br>Alternative/<br>Intersection # in<br>BART Extension TIA | BART Ext. with TOJD<br>Alternative/<br>Intersection # in<br>BART Extension<br>with TOJD TIA |
|--|-------------|---|---|---|
| <b>Santa Clara Station</b>   |             |   |   |   |
| Scott Blvd and Central Expwy*  | Santa Clara | Yes                                     |   | 28  |
| Lafayette and Central Expwy *  | Santa Clara | Yes                                     |   | 29  |
| De La Cruz Blvd and Central Expwy *  | Santa Clara | Yes                                     | 16  | 30  |
| De La Cruz Blvd and Martin Avenue  | Santa Clara | Yes                                     | 17  | 31  |
| De La Cruz Blvd and Reed Street  | Santa Clara | Yes                                     | 2   | 32  |
| Coleman Avenue and Brokaw Road   | Santa Clara | Yes                                     | 11  | 33  |
| Coleman Avenue and Aviation Avenue   | San Jose    | Yes                                     | 12  | 34  |
| Coleman Avenue and Newhall Drive   | San Jose    | Yes                                     | 13  | 35  |
| Coleman Avenue and I-880 SB Ramps*   | San Jose    | Yes                                     |   | 36  |
| Coleman Avenue and I-880 NB Ramps*   | San Jose    | Yes                                     |   | 37  |
| Coleman Avenue and W. Hedding St.  | San Jose    | Yes                                     |   | 38  |
| Coleman Avenue and W. Taylor St  | San Jose    | Yes                                     |   | 39  |
| SR 87 and W. Taylor Street   | San Jose    | Yes                                     |   | 40  |
| San Tomas Expwy and El Camino Real*  | Santa Clara | Yes                                     | 3   | 41  |
| Scott Blvd and El Camino Real*   | Santa Clara | Yes                                     | 4   | 42  |
| Lincoln Street and El Camino Real*   | Santa Clara | Yes                                     |   | 43  |
| Monroe Street and El Camino Real*  | Santa Clara | Yes                                     | 5   | 44  |
| Lafayette St. and Reed Street  | Santa Clara | Yes                                     | 1   | 45  |
| Lafayette St. and El Camino Real*  | Santa Clara | Yes                                     | 6   | 46  |
| Lafayette Street and Lewis Street  | Santa Clara | Yes                                     | 14  | 47  |
| Lafayette St and Harrison St (unsignalized)  | Santa Clara | Yes                                     | 15  | 48  |
| Lafayette St. and Benton Street  | Santa Clara | Yes                                     | 10  | 49  |
| Lafayette St. and Homestead Road   | Santa Clara | Yes                                     |   | 50  |
| Lafayette St. and Market Street  | Santa Clara | Yes                                     |   | 51  |
| El Camino Real and Benton Street   | Santa Clara | Yes                                     | 7   | 52  |
| El Camino Real and Railroad Ave.   | Santa Clara | Yes                                     | 8   | 53  |
| El Camino Real and The Alameda*  | Santa Clara | Yes                                     | 9   | 54  |
| The Alameda and Newhall Dr   | San Jose    | Yes                                     |   | 55  |
| The Alameda and I-880 (South)*   | San Jose    | Yes                                     |   | 56  |
| The Alameda and I-880 (North)*   | San Jose    | Yes                                     |   | 57  |
| The Alameda and W. Hedding Street*   | San Jose    | Yes                                     |   | 58  |
| The Alameda and W. Taylor St/Naglee Ave*   | San Jose    | Yes                                     |   | 59  |
| Homestead Rd and Lincoln St/Winchester Blvd  | Santa Clara | Yes                                     |   | 60  |
| Homestead Rd and Monroe Street   | Santa Clara | Yes                                     |   | 61  |
| U.S. 101 and Trimble Road  | San Jose    | Yes                                     |   | 62  |
| <b>Notes:</b>  |             |   |   |   |
| * Denotes a CMP intersection   |             |   |   |   |
| <sup>1</sup> There are 35 study intersections for the "No Build" Alternative and the "BART Extension with TOJD" Alternative.<br>There are 17 study intersections for the "BART Extension" Alternative. |             |   |   |   |

**Appendix B**  
**New Traffic Counts**

Groups Printed- Class 1

| Start Time  | 33RD ST Southbound |      |      |      | MCKEE RD Westbound |      |      |      | 33RD ST Northbound |      |      |      | MCKEE RD Eastbound |      |      |      | Int. Total |
|-------------|--------------------|------|------|------|--------------------|------|------|------|--------------------|------|------|------|--------------------|------|------|------|------------|
|             | Right              | Thru | Left | Peds | Right              | Thru | Left | Peds | Right              | Thru | Left | Peds | Right              | Thru | Left | Peds |            |
| 07:00 AM    | 32                 | 5    | 6    | 5    | 5                  | 276  | 6    | 4    | 6                  | 8    | 35   | 0    | 7                  | 155  | 10   | 0    | 560        |
| 07:15 AM    | 31                 | 5    | 12   | 0    | 8                  | 231  | 3    | 9    | 6                  | 26   | 40   | 0    | 7                  | 166  | 21   | 0    | 565        |
| 07:30 AM    | 36                 | 10   | 20   | 9    | 3                  | 274  | 8    | 22   | 10                 | 40   | 29   | 2    | 14                 | 253  | 36   | 0    | 766        |
| 07:45 AM    | 45                 | 30   | 21   | 5    | 7                  | 257  | 4    | 30   | 9                  | 45   | 33   | 0    | 15                 | 235  | 35   | 0    | 771        |
| Total       | 144                | 50   | 59   | 19   | 23                 | 1038 | 21   | 65   | 31                 | 119  | 137  | 2    | 43                 | 809  | 102  | 0    | 2662       |
| 08:00 AM    | 40                 | 14   | 24   | 51   | 8                  | 278  | 8    | 2    | 4                  | 5    | 31   | 0    | 10                 | 213  | 21   | 0    | 709        |
| 08:15 AM    | 28                 | 6    | 11   | 40   | 2                  | 293  | 6    | 4    | 14                 | 4    | 39   | 0    | 8                  | 197  | 17   | 0    | 669        |
| 08:30 AM    | 20                 | 1    | 13   | 31   | 4                  | 257  | 8    | 8    | 7                  | 2    | 37   | 0    | 7                  | 173  | 8    | 0    | 576        |
| 08:45 AM    | 15                 | 2    | 11   | 8    | 5                  | 262  | 11   | 0    | 7                  | 1    | 22   | 0    | 8                  | 188  | 9    | 0    | 549        |
| Total       | 103                | 23   | 59   | 130  | 19                 | 1090 | 33   | 14   | 32                 | 12   | 129  | 0    | 33                 | 771  | 55   | 0    | 2503       |
| Grand Total | 247                | 73   | 118  | 149  | 42                 | 2128 | 54   | 79   | 63                 | 131  | 266  | 2    | 76                 | 1580 | 157  | 0    | 5165       |
| Apprch %    | 42.1               | 12.4 | 20.1 | 25.4 | 1.8                | 92.4 | 2.3  | 3.4  | 13.6               | 28.4 | 57.6 | 0.4  | 4.2                | 87.1 | 8.7  | 0    |            |
| Total %     | 4.8                | 1.4  | 2.3  | 2.9  | 0.8                | 41.2 | 1    | 1.5  | 1.2                | 2.5  | 5.2  | 0    | 1.5                | 30.6 | 3    | 0    |            |

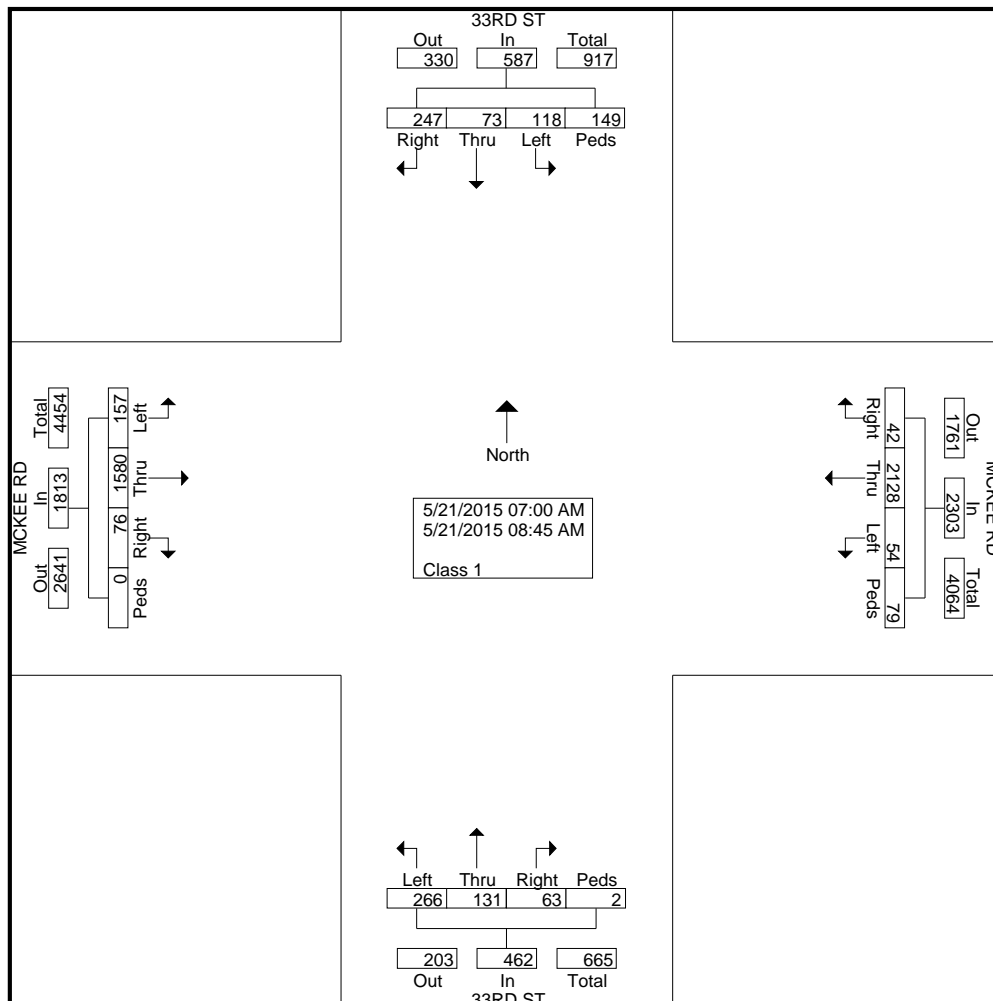

| Start Time  | 33RD ST Southbound |      |      |      |            | MCKEE RD Westbound |      |      |      |            | 33RD ST Northbound |      |      |      |            | MCKEE RD Eastbound |      |      |      |            | Int. Total |
|---|--------------------|------|------|------|------------|--------------------|------|------|------|------------|--------------------|------|------|------|------------|--------------------|------|------|------|------------|------------|
|   | Right              | Thru | Left | Peds | App. Total | Right              | Thru | Left | Peds | App. Total | Right              | Thru | Left | Peds | App. Total | Right              | Thru | Left | Peds | App. Total |            |
| <b>Peak Hour Analysis From 07:00 AM to 08:45 AM - Peak 1 of 1</b> |                    |      |      |      |            |                    |      |      |      |            |                    |      |      |      |            |                    |      |      |      |            |            |
| Peak Hour for Entire Intersection Begins at 07:30 AM              |                    |      |      |      |            |                    |      |      |      |            |                    |      |      |      |            |                    |      |      |      |            |            |
| 07:30 AM  | 36                 | 10   | 20   | 9    | 75         | 3                  | 274  | 8    | 22   | 307        | 10                 | 40   | 29   | 2    | 81         | 14                 | 253  | 36   | 0    | 303        | 766        |
| 07:45 AM  | 45                 | 30   | 21   | 5    | 101        | 7                  | 257  | 4    | 30   | 298        | 9                  | 45   | 33   | 0    | 87         | 15                 | 235  | 35   | 0    | 285        | 771        |
| 08:00 AM  | 40                 | 14   | 24   | 51   | 129        | 8                  | 278  | 8    | 2    | 296        | 4                  | 5    | 31   | 0    | 40         | 10                 | 213  | 21   | 0    | 244        | 709        |
| 08:15 AM  | 28                 | 6    | 11   | 40   | 85         | 2                  | 293  | 6    | 4    | 305        | 14                 | 4    | 39   | 0    | 57         | 8                  | 197  | 17   | 0    | 222        | 669        |
| Total Volume  | 149                | 60   | 76   | 105  | 390        | 20                 | 1102 | 26   | 58   | 1206       | 37                 | 94   | 132  | 2    | 265        | 47                 | 898  | 109  | 0    | 1054       | 2915       |
| % App. Total  | 38.2               | 15.4 | 19.5 | 26.9 |            | 1.7                | 91.4 | 2.2  | 4.8  |            | 14                 | 35.5 | 49.8 | 0.8  |            | 4.5                | 85.2 | 10.3 | 0    |            |            |
| PHF   | .828               | .500 | .792 | .515 | .756       | .625               | .940 | .813 | .483 | .982       | .661               | .522 | .846 | .250 | .761       | .783               | .887 | .757 | .000 | .870       | .945       |

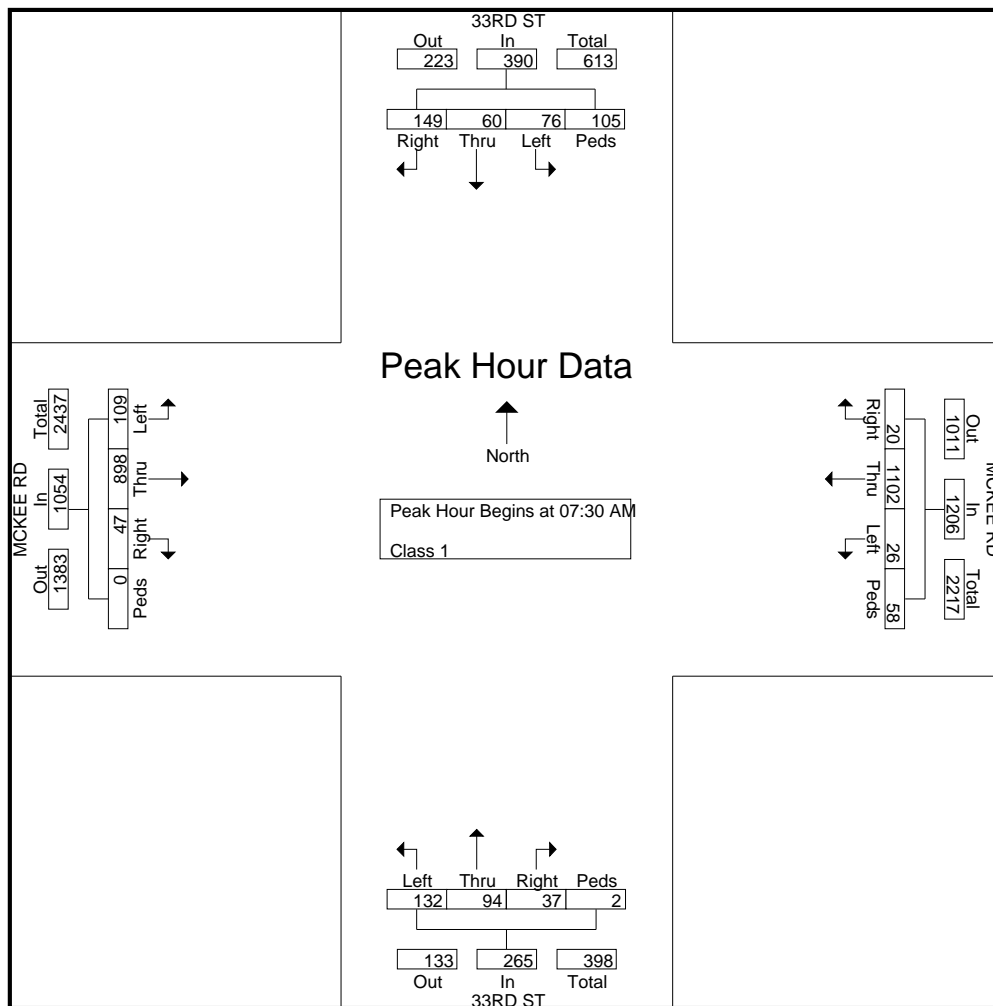



Groups Printed- Class 1

| Start Time  | 33RD ST Southbound |      |      |      | MCKEE RD Westbound |      |      |      | 33RD ST Northbound |      |      |      | MCKEE RD Eastbound |      |      |      | Int. Total |
|-------------|--------------------|------|------|------|--------------------|------|------|------|--------------------|------|------|------|--------------------|------|------|------|------------|
|             | Right              | Thru | Left | Peds | Right              | Thru | Left | Peds | Right              | Thru | Left | Peds | Right              | Thru | Left | Peds |            |
| 04:00 PM    | 28                 | 11   | 22   | 2    | 12                 | 280  | 17   | 2    | 16                 | 7    | 20   | 1    | 27                 | 232  | 27   | 0    | 704        |
| 04:15 PM    | 27                 | 4    | 24   | 2    | 3                  | 321  | 13   | 2    | 14                 | 5    | 27   | 1    | 27                 | 273  | 25   | 0    | 768        |
| 04:30 PM    | 27                 | 1    | 13   | 3    | 9                  | 313  | 20   | 2    | 12                 | 5    | 31   | 0    | 19                 | 254  | 35   | 0    | 744        |
| 04:45 PM    | 26                 | 4    | 17   | 1    | 3                  | 272  | 11   | 2    | 14                 | 11   | 28   | 1    | 23                 | 254  | 25   | 0    | 692        |
| Total       | 108                | 20   | 76   | 8    | 27                 | 1186 | 61   | 8    | 56                 | 28   | 106  | 3    | 96                 | 1013 | 112  | 0    | 2908       |
| 05:00 PM    | 33                 | 2    | 18   | 2    | 7                  | 303  | 6    | 2    | 9                  | 7    | 31   | 1    | 19                 | 255  | 24   | 0    | 719        |
| 05:15 PM    | 30                 | 4    | 20   | 3    | 7                  | 255  | 14   | 3    | 9                  | 9    | 18   | 0    | 17                 | 283  | 30   | 0    | 702        |
| 05:30 PM    | 26                 | 9    | 29   | 3    | 3                  | 285  | 11   | 0    | 10                 | 11   | 32   | 1    | 14                 | 261  | 30   | 0    | 725        |
| 05:45 PM    | 36                 | 9    | 16   | 1    | 6                  | 283  | 13   | 1    | 14                 | 7    | 18   | 0    | 27                 | 253  | 36   | 0    | 720        |
| Total       | 125                | 24   | 83   | 9    | 23                 | 1126 | 44   | 6    | 42                 | 34   | 99   | 2    | 77                 | 1052 | 120  | 0    | 2866       |
| Grand Total | 233                | 44   | 159  | 17   | 50                 | 2312 | 105  | 14   | 98                 | 62   | 205  | 5    | 173                | 2065 | 232  | 0    | 5774       |
| Apprch %    | 51.4               | 9.7  | 35.1 | 3.8  | 2                  | 93.2 | 4.2  | 0.6  | 26.5               | 16.8 | 55.4 | 1.4  | 7                  | 83.6 | 9.4  | 0    |            |
| Total %     | 4                  | 0.8  | 2.8  | 0.3  | 0.9                | 40   | 1.8  | 0.2  | 1.7                | 1.1  | 3.6  | 0.1  | 3                  | 35.8 | 4    | 0    |            |

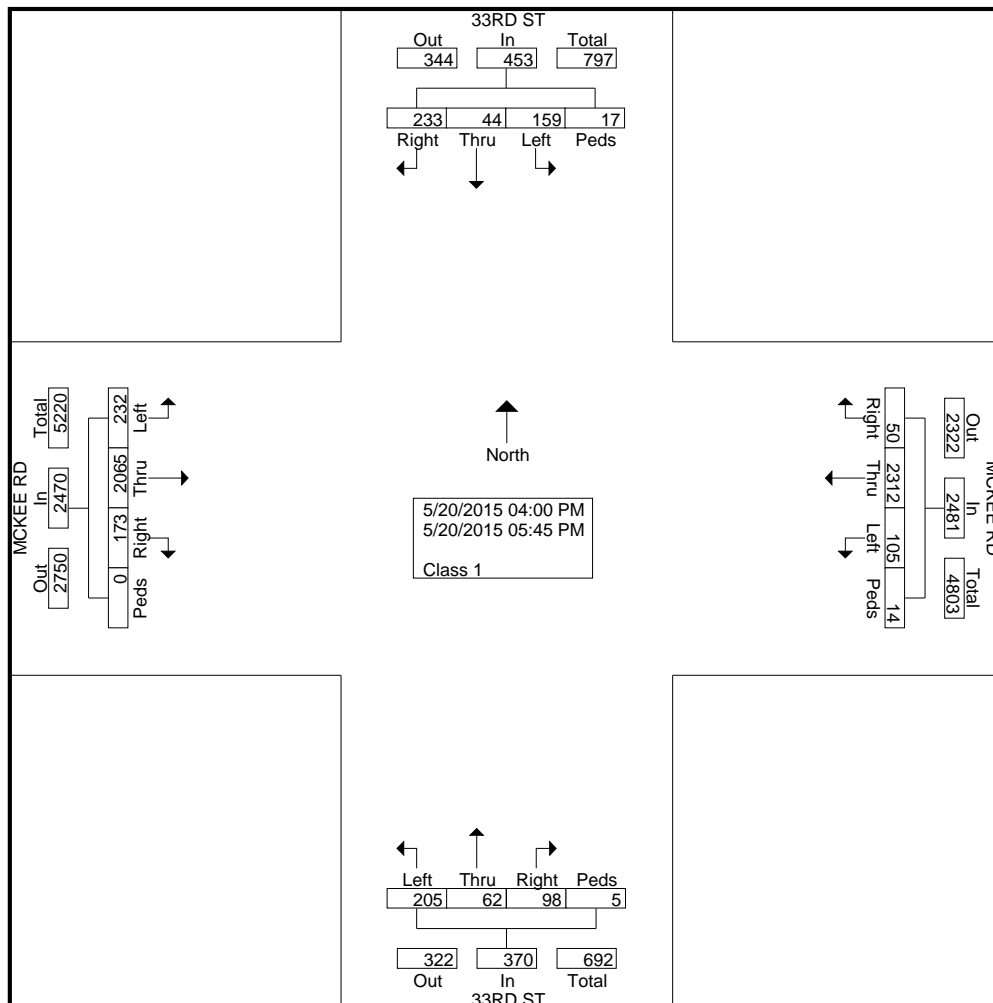

| Start Time  | 33RD ST Southbound |      |      |      |            | MCKEE RD Westbound |      |      |      |            | 33RD ST Northbound |      |      |      |            | MCKEE RD Eastbound |      |      |      |            | Int. Total |
|---|--------------------|------|------|------|------------|--------------------|------|------|------|------------|--------------------|------|------|------|------------|--------------------|------|------|------|------------|------------|
|   | Right              | Thru | Left | Peds | App. Total | Right              | Thru | Left | Peds | App. Total | Right              | Thru | Left | Peds | App. Total | Right              | Thru | Left | Peds | App. Total |            |
| <b>Peak Hour Analysis From 04:00 PM to 05:45 PM - Peak 1 of 1</b> |                    |      |      |      |            |                    |      |      |      |            |                    |      |      |      |            |                    |      |      |      |            |            |
| Peak Hour for Entire Intersection Begins at 04:15 PM              |                    |      |      |      |            |                    |      |      |      |            |                    |      |      |      |            |                    |      |      |      |            |            |
| 04:15 PM  | 27                 | 4    | 24   | 2    | 57         | 3                  | 321  | 13   | 2    | 339        | 14                 | 5    | 27   | 1    | 47         | 27                 | 273  | 25   | 0    | 325        | 768        |
| 04:30 PM  | 27                 | 1    | 13   | 3    | 44         | 9                  | 313  | 20   | 2    | 344        | 12                 | 5    | 31   | 0    | 48         | 19                 | 254  | 35   | 0    | 308        | 744        |
| 04:45 PM  | 26                 | 4    | 17   | 1    | 48         | 3                  | 272  | 11   | 2    | 288        | 14                 | 11   | 28   | 1    | 54         | 23                 | 254  | 25   | 0    | 302        | 692        |
| 05:00 PM  | 33                 | 2    | 18   | 2    | 55         | 7                  | 303  | 6    | 2    | 318        | 9                  | 7    | 31   | 1    | 48         | 19                 | 255  | 24   | 0    | 298        | 719        |
| Total Volume  | 113                | 11   | 72   | 8    | 204        | 22                 | 1209 | 50   | 8    | 1289       | 49                 | 28   | 117  | 3    | 197        | 88                 | 1036 | 109  | 0    | 1233       | 2923       |
| % App. Total  | 55.4               | 5.4  | 35.3 | 3.9  |            | 1.7                | 93.8 | 3.9  | 0.6  |            | 24.9               | 14.2 | 59.4 | 1.5  |            | 7.1                | 84   | 8.8  | 0    |            |            |
| PHF   | .856               | .688 | .750 | .667 | .895       | .611               | .942 | .625 | 1.00 | .937       | .875               | .636 | .944 | .750 | .912       | .815               | .949 | .779 | .000 | .948       | .951       |

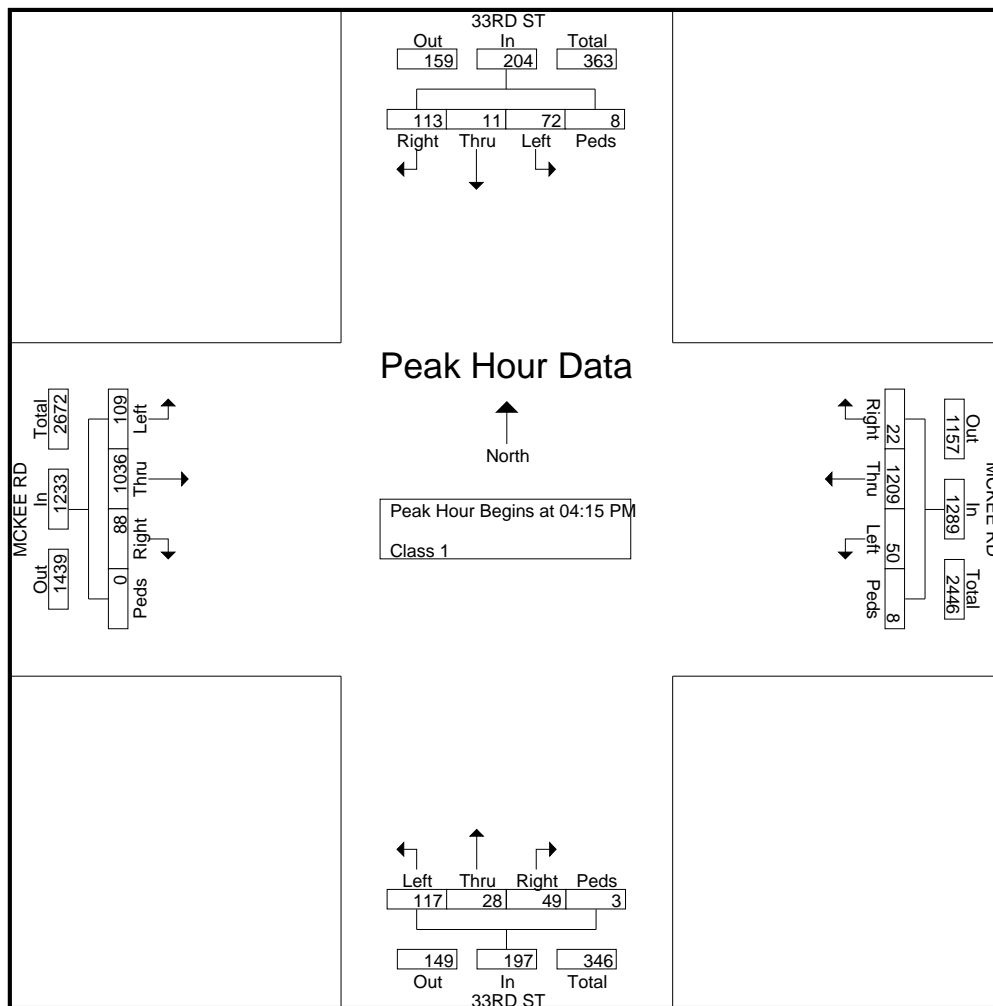

File Name : #2 33RD&ALUMROCKAM  
 Site Code :  
 Start Date : 5/21/2015  
 Page No : 1

Groups Printed- Class 1

| Start Time  | 33RD ST Southbound |      |      |      | ALUM ROCK AVE Westbound |      |      |      | 33RD ST Northbound |      |      |      | ALUM ROCK AVE Eastbound |      |      |      | Int. Total |
|-------------|--------------------|------|------|------|-------------------------|------|------|------|--------------------|------|------|------|-------------------------|------|------|------|------------|
|             | Right              | Thru | Left | Peds | Right                   | Thru | Left | Peds | Right              | Thru | Left | Peds | Right                   | Thru | Left | Peds |            |
| 07:00 AM    | 16                 | 5    | 5    | 9    | 6                       | 161  | 4    | 0    | 5                  | 17   | 42   | 0    | 9                       | 60   | 6    | 1    | 346        |
| 07:15 AM    | 36                 | 3    | 6    | 1    | 8                       | 157  | 2    | 3    | 1                  | 11   | 44   | 3    | 9                       | 61   | 5    | 0    | 350        |
| 07:30 AM    | 36                 | 13   | 7    | 1    | 7                       | 163  | 3    | 2    | 3                  | 43   | 35   | 3    | 11                      | 95   | 6    | 0    | 428        |
| 07:45 AM    | 45                 | 24   | 3    | 4    | 5                       | 143  | 1    | 1    | 3                  | 15   | 43   | 0    | 14                      | 94   | 5    | 0    | 400        |
| Total       | 133                | 45   | 21   | 15   | 26                      | 624  | 10   | 6    | 12                 | 86   | 164  | 6    | 43                      | 310  | 22   | 1    | 1524       |
| 08:00 AM    | 29                 | 14   | 1    | 2    | 3                       | 138  | 3    | 5    | 7                  | 11   | 40   | 6    | 14                      | 87   | 9    | 0    | 369        |
| 08:15 AM    | 17                 | 13   | 5    | 5    | 5                       | 156  | 5    | 5    | 5                  | 8    | 23   | 2    | 14                      | 86   | 4    | 0    | 353        |
| 08:30 AM    | 18                 | 10   | 3    | 3    | 3                       | 153  | 5    | 4    | 3                  | 10   | 39   | 0    | 16                      | 79   | 5    | 1    | 352        |
| 08:45 AM    | 23                 | 8    | 5    | 2    | 5                       | 144  | 3    | 5    | 8                  | 5    | 30   | 3    | 12                      | 72   | 7    | 0    | 332        |
| Total       | 87                 | 45   | 14   | 12   | 16                      | 591  | 16   | 19   | 23                 | 34   | 132  | 11   | 56                      | 324  | 25   | 1    | 1406       |
| Grand Total | 220                | 90   | 35   | 27   | 42                      | 1215 | 26   | 25   | 35                 | 120  | 296  | 17   | 99                      | 634  | 47   | 2    | 2930       |
| Apprch %    | 59.1               | 24.2 | 9.4  | 7.3  | 3.2                     | 92.9 | 2    | 1.9  | 7.5                | 25.6 | 63.2 | 3.6  | 12.7                    | 81.1 | 6    | 0.3  |            |
| Total %     | 7.5                | 3.1  | 1.2  | 0.9  | 1.4                     | 41.5 | 0.9  | 0.9  | 1.2                | 4.1  | 10.1 | 0.6  | 3.4                     | 21.6 | 1.6  | 0.1  |            |

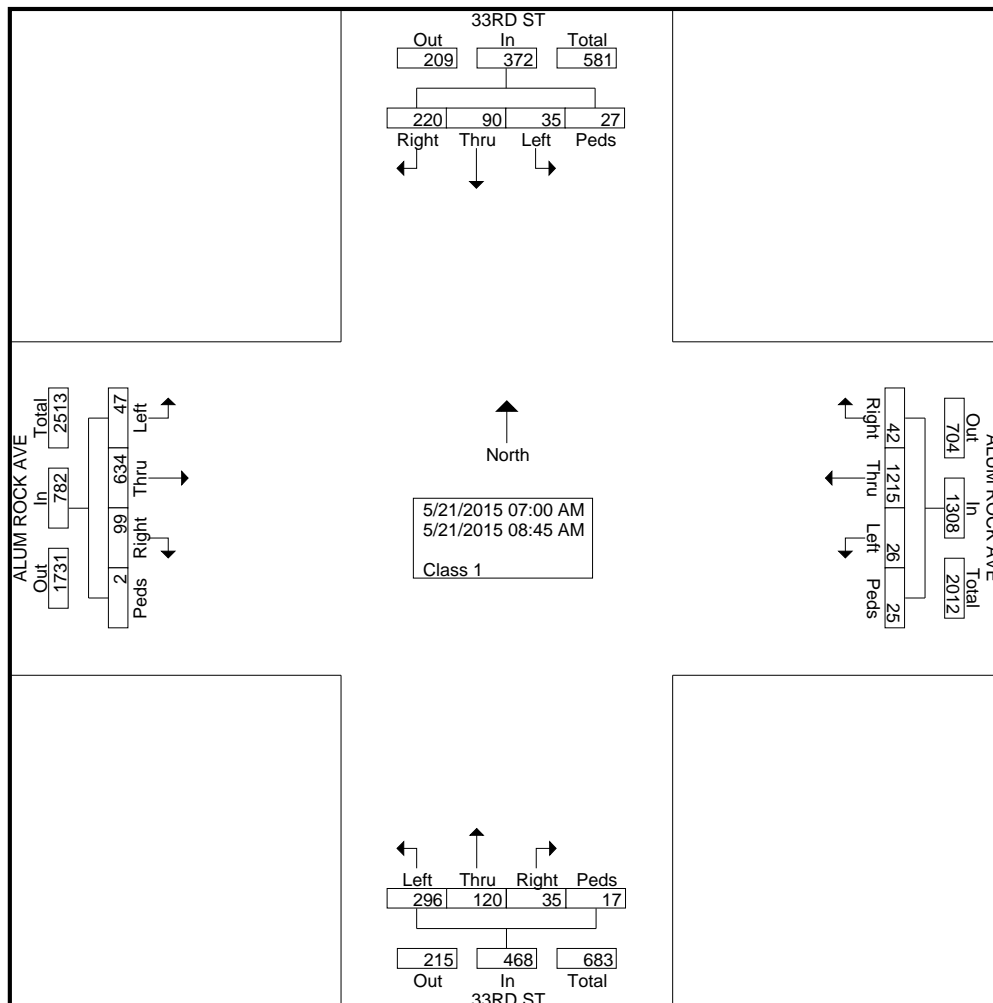

| Start Time  | 33RD ST Southbound |      |      |      |            | ALUM ROCK AVE Westbound |      |      |      |            | 33RD ST Northbound |      |      |      |            | ALUM ROCK AVE Eastbound |      |      |      |            | Int. Total |
|---|--------------------|------|------|------|------------|-------------------------|------|------|------|------------|--------------------|------|------|------|------------|-------------------------|------|------|------|------------|------------|
|   | Right              | Thru | Left | Peds | App. Total | Right                   | Thru | Left | Peds | App. Total | Right              | Thru | Left | Peds | App. Total | Right                   | Thru | Left | Peds | App. Total |            |
| <b>Peak Hour Analysis From 07:00 AM to 08:45 AM - Peak 1 of 1</b> |                    |      |      |      |            |                         |      |      |      |            |                    |      |      |      |            |                         |      |      |      |            |            |
| Peak Hour for Entire Intersection Begins at 07:30 AM              |                    |      |      |      |            |                         |      |      |      |            |                    |      |      |      |            |                         |      |      |      |            |            |
| 07:30 AM  | 36                 | 13   | 7    | 1    | 57         | 7                       | 163  | 3    | 2    | 175        | 3                  | 43   | 35   | 3    | 84         | 11                      | 95   | 6    | 0    | 112        | 428        |
| 07:45 AM  | 45                 | 24   | 3    | 4    | 76         | 5                       | 143  | 1    | 1    | 150        | 3                  | 15   | 43   | 0    | 61         | 14                      | 94   | 5    | 0    | 113        | 400        |
| 08:00 AM  | 29                 | 14   | 1    | 2    | 46         | 3                       | 138  | 3    | 5    | 149        | 7                  | 11   | 40   | 6    | 64         | 14                      | 87   | 9    | 0    | 110        | 369        |
| 08:15 AM  | 17                 | 13   | 5    | 5    | 40         | 5                       | 156  | 5    | 5    | 171        | 5                  | 8    | 23   | 2    | 38         | 14                      | 86   | 4    | 0    | 104        | 353        |
| Total Volume  | 127                | 64   | 16   | 12   | 219        | 20                      | 600  | 12   | 13   | 645        | 18                 | 77   | 141  | 11   | 247        | 53                      | 362  | 24   | 0    | 439        | 1550       |
| % App. Total  | 58                 | 29.2 | 7.3  | 5.5  |            | 3.1                     | 93   | 1.9  | 2    |            | 7.3                | 31.2 | 57.1 | 4.5  |            | 12.1                    | 82.5 | 5.5  | 0    |            |            |
| PHF   | .706               | .667 | .571 | .600 | .720       | .714                    | .920 | .600 | .650 | .921       | .643               | .448 | .820 | .458 | .735       | .946                    | .953 | .667 | .000 | .971       | .905       |

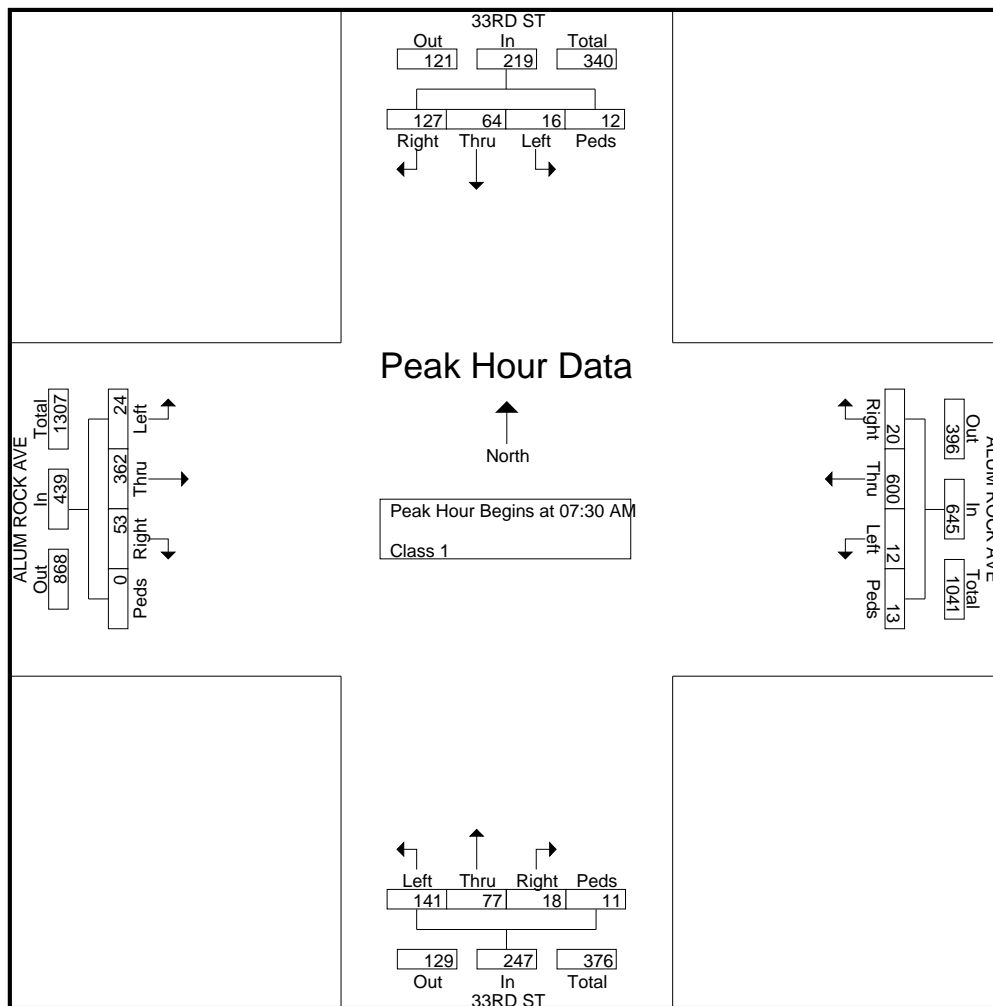

File Name : #2 33RD&ALUMROCKPM  
 Site Code :  
 Start Date : 5/20/2015  
 Page No : 1

Groups Printed- Class 1

| Start Time  | 33RD ST Southbound |      |      |      | ALUM ROCK AVE Westbound |      |      |      | 33RD ST Northbound |      |      |      | ALUM ROCK AVE Eastbound |      |      |      | Int. Total |
|-------------|--------------------|------|------|------|-------------------------|------|------|------|--------------------|------|------|------|-------------------------|------|------|------|------------|
|             | Right              | Thru | Left | Peds | Right                   | Thru | Left | Peds | Right              | Thru | Left | Peds | Right                   | Thru | Left | Peds |            |
| 04:00 PM    | 23                 | 10   | 8    | 0    | 5                       | 132  | 4    | 8    | 9                  | 11   | 22   | 1    | 33                      | 160  | 16   | 0    | 442        |
| 04:15 PM    | 16                 | 18   | 6    | 3    | 7                       | 119  | 4    | 2    | 5                  | 9    | 29   | 3    | 32                      | 190  | 11   | 1    | 455        |
| 04:30 PM    | 24                 | 13   | 4    | 6    | 9                       | 143  | 2    | 6    | 2                  | 9    | 19   | 4    | 30                      | 148  | 13   | 0    | 432        |
| 04:45 PM    | 18                 | 10   | 4    | 1    | 11                      | 136  | 1    | 5    | 4                  | 17   | 17   | 3    | 38                      | 154  | 18   | 3    | 440        |
| Total       | 81                 | 51   | 22   | 10   | 32                      | 530  | 11   | 21   | 20                 | 46   | 87   | 11   | 133                     | 652  | 58   | 4    | 1769       |
| 05:00 PM    | 23                 | 5    | 7    | 2    | 6                       | 126  | 3    | 8    | 5                  | 15   | 25   | 1    | 43                      | 171  | 22   | 0    | 462        |
| 05:15 PM    | 36                 | 8    | 14   | 3    | 11                      | 136  | 5    | 7    | 6                  | 6    | 23   | 2    | 26                      | 203  | 10   | 4    | 500        |
| 05:30 PM    | 25                 | 10   | 12   | 9    | 8                       | 134  | 7    | 1    | 11                 | 12   | 30   | 2    | 33                      | 162  | 17   | 5    | 478        |
| 05:45 PM    | 25                 | 14   | 14   | 7    | 4                       | 147  | 4    | 3    | 6                  | 8    | 17   | 2    | 26                      | 174  | 12   | 2    | 465        |
| Total       | 109                | 37   | 47   | 21   | 29                      | 543  | 19   | 19   | 28                 | 41   | 95   | 7    | 128                     | 710  | 61   | 11   | 1905       |
| Grand Total | 190                | 88   | 69   | 31   | 61                      | 1073 | 30   | 40   | 48                 | 87   | 182  | 18   | 261                     | 1362 | 119  | 15   | 3674       |
| Apprch %    | 50.3               | 23.3 | 18.3 | 8.2  | 5.1                     | 89.1 | 2.5  | 3.3  | 14.3               | 26   | 54.3 | 5.4  | 14.9                    | 77.5 | 6.8  | 0.9  |            |
| Total %     | 5.2                | 2.4  | 1.9  | 0.8  | 1.7                     | 29.2 | 0.8  | 1.1  | 1.3                | 2.4  | 5    | 0.5  | 7.1                     | 37.1 | 3.2  | 0.4  |            |

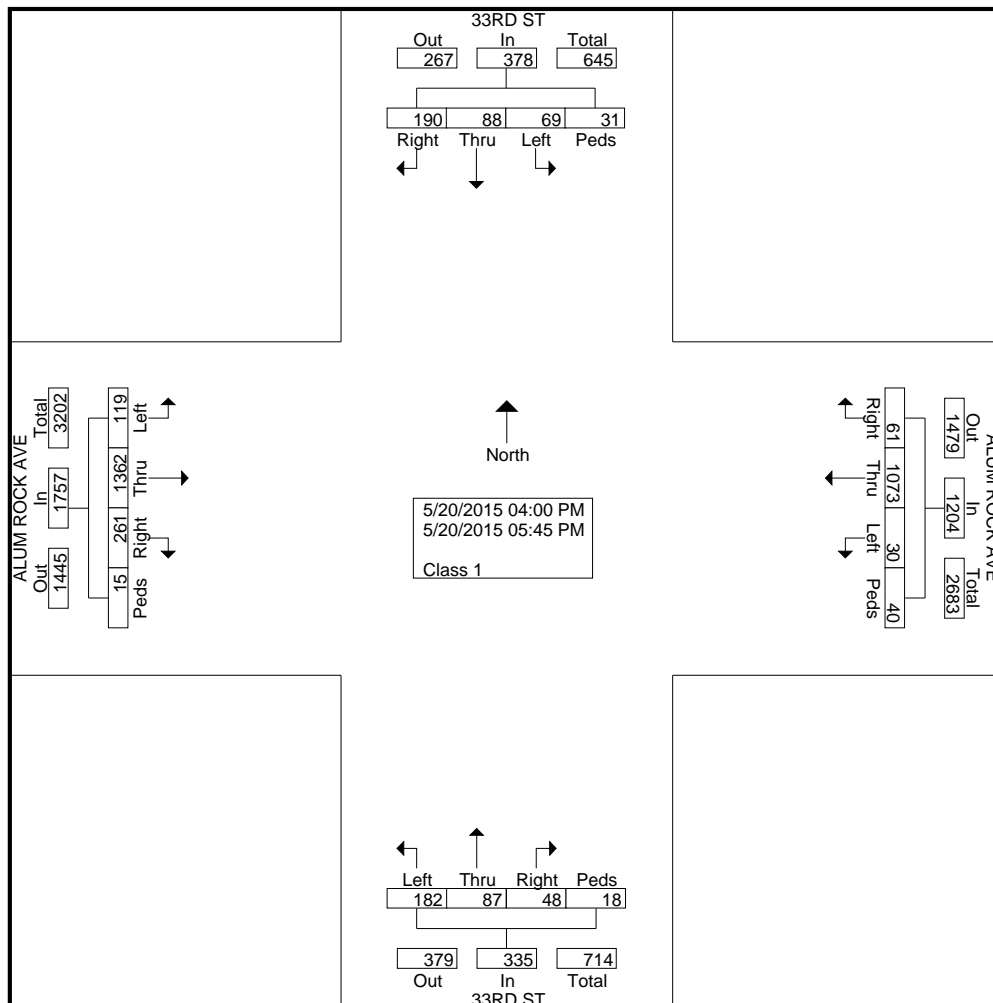

| Start Time  | 33RD ST Southbound |      |      |      |            | ALUM ROCK AVE Westbound |      |      |      |            | 33RD ST Northbound |      |      |      |            | ALUM ROCK AVE Eastbound |      |      |      |            | Int. Total |
|---|--------------------|------|------|------|------------|-------------------------|------|------|------|------------|--------------------|------|------|------|------------|-------------------------|------|------|------|------------|------------|
|   | Right              | Thru | Left | Peds | App. Total | Right                   | Thru | Left | Peds | App. Total | Right              | Thru | Left | Peds | App. Total | Right                   | Thru | Left | Peds | App. Total |            |
| <b>Peak Hour Analysis From 04:00 PM to 05:45 PM - Peak 1 of 1</b> |                    |      |      |      |            |                         |      |      |      |            |                    |      |      |      |            |                         |      |      |      |            |            |
| Peak Hour for Entire Intersection Begins at 05:00 PM              |                    |      |      |      |            |                         |      |      |      |            |                    |      |      |      |            |                         |      |      |      |            |            |
| 05:00 PM  | 23                 | 5    | 7    | 2    | 37         | 6                       | 126  | 3    | 8    | 143        | 5                  | 15   | 25   | 1    | 46         | 43                      | 171  | 22   | 0    | 236        | 462        |
| 05:15 PM  | 36                 | 8    | 14   | 3    | 61         | 11                      | 136  | 5    | 7    | 159        | 6                  | 6    | 23   | 2    | 37         | 26                      | 203  | 10   | 4    | 243        | 500        |
| 05:30 PM  | 25                 | 10   | 12   | 9    | 56         | 8                       | 134  | 7    | 1    | 150        | 11                 | 12   | 30   | 2    | 55         | 33                      | 162  | 17   | 5    | 217        | 478        |
| 05:45 PM  | 25                 | 14   | 14   | 7    | 60         | 4                       | 147  | 4    | 3    | 158        | 6                  | 8    | 17   | 2    | 33         | 26                      | 174  | 12   | 2    | 214        | 465        |
| Total Volume  | 109                | 37   | 47   | 21   | 214        | 29                      | 543  | 19   | 19   | 610        | 28                 | 41   | 95   | 7    | 171        | 128                     | 710  | 61   | 11   | 910        | 1905       |
| % App. Total  | 50.9               | 17.3 | 22   | 9.8  |            | 4.8                     | 89   | 3.1  | 3.1  |            | 16.4               | 24   | 55.6 | 4.1  |            | 14.1                    | 78   | 6.7  | 1.2  |            |            |
| PHF   | .757               | .661 | .839 | .583 | .877       | .659                    | .923 | .679 | .594 | .959       | .636               | .683 | .792 | .875 | .777       | .744                    | .874 | .693 | .550 | .936       | .953       |

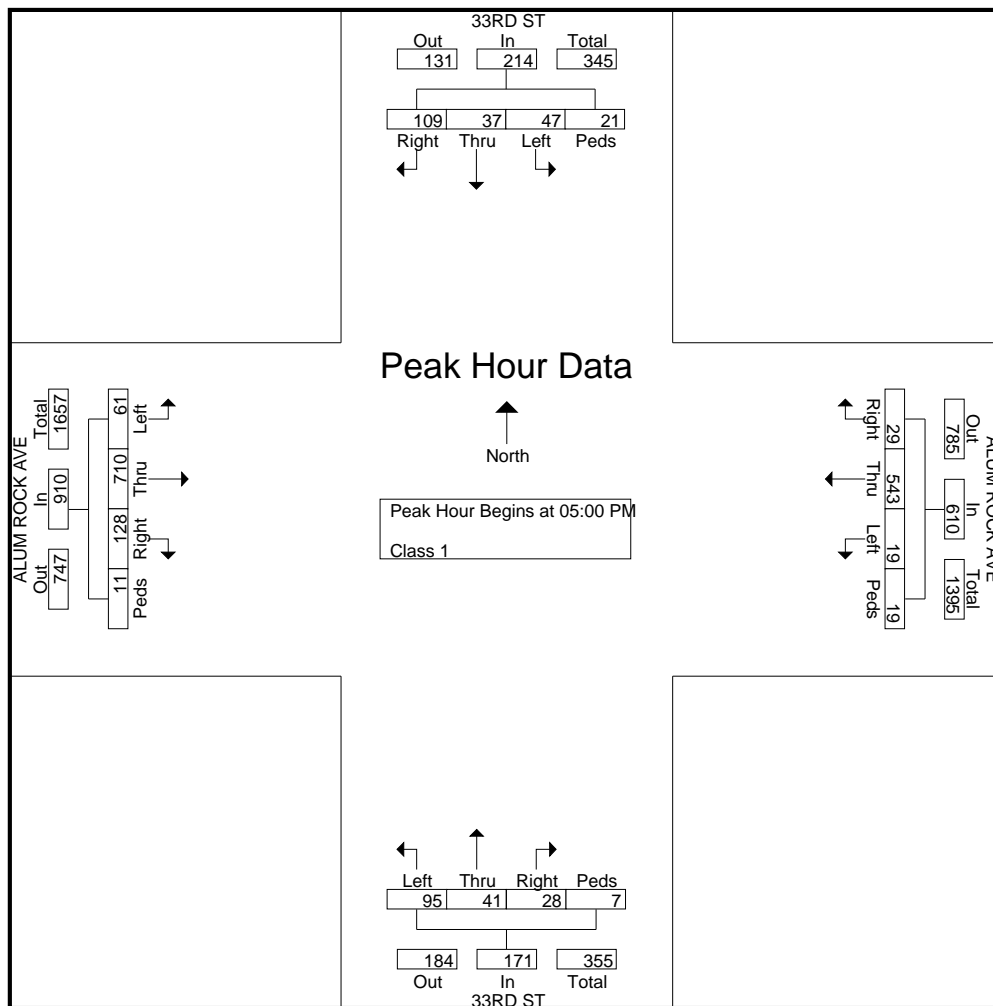



File Name : #3 KING&SANANTONIOAM  
 Site Code :  
 Start Date : 5/21/2015  
 Page No : 1

Groups Printed- Class 1

| Start Time  | KING RD Southbound |      |      |      | E SAN ANTONIO ST Westbound |      |      |      | KING RD Northbound |      |      |      | E SAN ANTONIO ST Eastbound |      |      |      | Int. Total |
|-------------|--------------------|------|------|------|----------------------------|------|------|------|--------------------|------|------|------|----------------------------|------|------|------|------------|
|             | Right              | Thru | Left | Peds | Right                      | Thru | Left | Peds | Right              | Thru | Left | Peds | Right                      | Thru | Left | Peds |            |
| 07:00 AM    | 7                  | 43   | 12   | 1    | 31                         | 38   | 17   | 0    | 17                 | 96   | 18   | 1    | 20                         | 23   | 12   | 0    | 336        |
| 07:15 AM    | 6                  | 55   | 15   | 4    | 24                         | 43   | 28   | 2    | 32                 | 134  | 25   | 2    | 22                         | 29   | 9    | 1    | 431        |
| 07:30 AM    | 10                 | 79   | 35   | 1    | 41                         | 54   | 33   | 0    | 36                 | 190  | 32   | 2    | 43                         | 42   | 19   | 3    | 620        |
| 07:45 AM    | 19                 | 118  | 30   | 25   | 34                         | 72   | 35   | 3    | 63                 | 162  | 39   | 2    | 37                         | 65   | 11   | 8    | 723        |
| Total       | 42                 | 295  | 92   | 31   | 130                        | 207  | 113  | 5    | 148                | 582  | 114  | 7    | 122                        | 159  | 51   | 12   | 2110       |
| 08:00 AM    | 21                 | 69   | 35   | 7    | 22                         | 57   | 27   | 2    | 26                 | 159  | 32   | 5    | 27                         | 50   | 12   | 5    | 556        |
| 08:15 AM    | 11                 | 73   | 36   | 1    | 19                         | 49   | 27   | 1    | 24                 | 124  | 30   | 1    | 22                         | 35   | 11   | 4    | 468        |
| 08:30 AM    | 11                 | 57   | 21   | 4    | 42                         | 60   | 15   | 0    | 14                 | 163  | 18   | 2    | 18                         | 42   | 9    | 3    | 479        |
| 08:45 AM    | 13                 | 59   | 18   | 2    | 30                         | 49   | 13   | 3    | 17                 | 126  | 18   | 2    | 15                         | 37   | 15   | 0    | 417        |
| Total       | 56                 | 258  | 110  | 14   | 113                        | 215  | 82   | 6    | 81                 | 572  | 98   | 10   | 82                         | 164  | 47   | 12   | 1920       |
| Grand Total | 98                 | 553  | 202  | 45   | 243                        | 422  | 195  | 11   | 229                | 1154 | 212  | 17   | 204                        | 323  | 98   | 24   | 4030       |
| Apprch %    | 10.9               | 61.6 | 22.5 | 5    | 27.9                       | 48.5 | 22.4 | 1.3  | 14.2               | 71.6 | 13.2 | 1.1  | 31.4                       | 49.8 | 15.1 | 3.7  |            |
| Total %     | 2.4                | 13.7 | 5    | 1.1  | 6                          | 10.5 | 4.8  | 0.3  | 5.7                | 28.6 | 5.3  | 0.4  | 5.1                        | 8    | 2.4  | 0.6  |            |

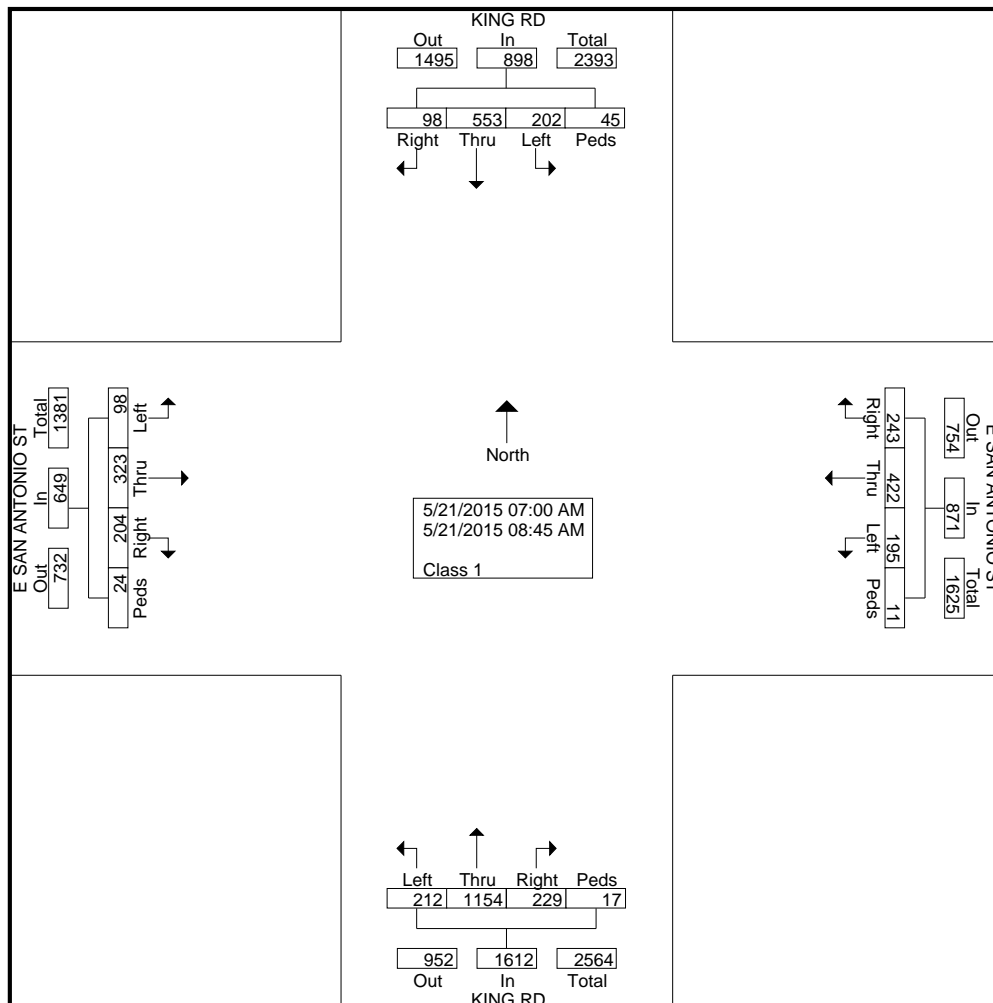

| Start Time  | KING RD Southbound |      |      |      |            | E SAN ANTONIO ST Westbound |      |      |      |            | KING RD Northbound |      |      |      |            | E SAN ANTONIO ST Eastbound |      |      |      |            | Int. Total |
|---|--------------------|------|------|------|------------|----------------------------|------|------|------|------------|--------------------|------|------|------|------------|----------------------------|------|------|------|------------|------------|
|   | Right              | Thru | Left | Peds | App. Total | Right                      | Thru | Left | Peds | App. Total | Right              | Thru | Left | Peds | App. Total | Right                      | Thru | Left | Peds | App. Total |            |
| <b>Peak Hour Analysis From 07:00 AM to 08:45 AM - Peak 1 of 1</b> |                    |      |      |      |            |                            |      |      |      |            |                    |      |      |      |            |                            |      |      |      |            |            |
| Peak Hour for Entire Intersection Begins at 07:30 AM              |                    |      |      |      |            |                            |      |      |      |            |                    |      |      |      |            |                            |      |      |      |            |            |
| 07:30 AM  | 10                 | 79   | 35   | 1    | 125        | 41                         | 54   | 33   | 0    | 128        | 36                 | 190  | 32   | 2    | 260        | 43                         | 42   | 19   | 3    | 107        | 620        |
| 07:45 AM  | 19                 | 118  | 30   | 25   | 192        | 34                         | 72   | 35   | 3    | 144        | 63                 | 162  | 39   | 2    | 266        | 37                         | 65   | 11   | 8    | 121        | 723        |
| 08:00 AM  | 21                 | 69   | 35   | 7    | 132        | 22                         | 57   | 27   | 2    | 108        | 26                 | 159  | 32   | 5    | 222        | 27                         | 50   | 12   | 5    | 94         | 556        |
| 08:15 AM  | 11                 | 73   | 36   | 1    | 121        | 19                         | 49   | 27   | 1    | 96         | 24                 | 124  | 30   | 1    | 179        | 22                         | 35   | 11   | 4    | 72         | 468        |
| Total Volume  | 61                 | 339  | 136  | 34   | 570        | 116                        | 232  | 122  | 6    | 476        | 149                | 635  | 133  | 10   | 927        | 129                        | 192  | 53   | 20   | 394        | 2367       |
| % App. Total  | 10.7               | 59.5 | 23.9 | 6    |            | 24.4                       | 48.7 | 25.6 | 1.3  |            | 16.1               | 68.5 | 14.3 | 1.1  |            | 32.7                       | 48.7 | 13.5 | 5.1  |            |            |
| PHF   | .726               | .718 | .944 | .340 | .742       | .707                       | .806 | .871 | .500 | .826       | .591               | .836 | .853 | .500 | .871       | .750                       | .738 | .697 | .625 | .814       | .818       |

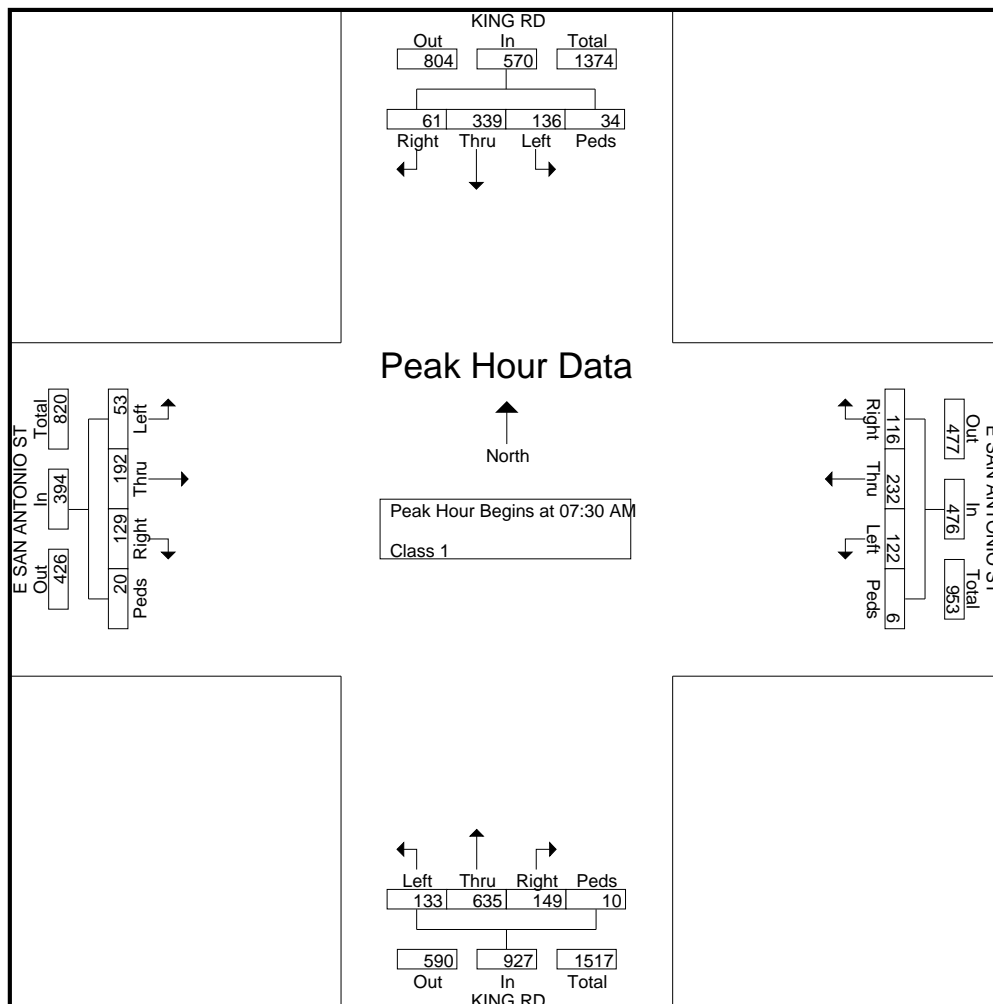

File Name : #3 KING&SANANTONIOPM  
 Site Code :  
 Start Date : 5/20/2015  
 Page No : 1

Groups Printed- Class 1

| Start Time  | KING RD Southbound |      |      |      | E SAN ANTONIO ST Westbound |      |      |      | KING RD Northbound |      |      |      | E SAN ANTONIO ST Eastbound |      |      |      | Int. Total |
|-------------|--------------------|------|------|------|----------------------------|------|------|------|--------------------|------|------|------|----------------------------|------|------|------|------------|
|             | Right              | Thru | Left | Peds | Right                      | Thru | Left | Peds | Right              | Thru | Left | Peds | Right                      | Thru | Left | Peds |            |
| 04:00 PM    | 14                 | 142  | 37   | 1    | 14                         | 38   | 30   | 0    | 31                 | 92   | 34   | 6    | 36                         | 46   | 7    | 3    | 531        |
| 04:15 PM    | 18                 | 151  | 46   | 1    | 23                         | 53   | 30   | 0    | 40                 | 80   | 31   | 1    | 27                         | 62   | 7    | 2    | 572        |
| 04:30 PM    | 12                 | 140  | 44   | 3    | 24                         | 42   | 20   | 2    | 28                 | 65   | 35   | 2    | 35                         | 54   | 10   | 1    | 517        |
| 04:45 PM    | 20                 | 111  | 36   | 0    | 22                         | 49   | 17   | 0    | 37                 | 74   | 28   | 2    | 20                         | 70   | 9    | 2    | 497        |
| Total       | 64                 | 544  | 163  | 5    | 83                         | 182  | 97   | 2    | 136                | 311  | 128  | 11   | 118                        | 232  | 33   | 8    | 2117       |
| 05:00 PM    | 12                 | 126  | 41   | 0    | 11                         | 62   | 21   | 4    | 44                 | 99   | 32   | 6    | 30                         | 55   | 11   | 0    | 554        |
| 05:15 PM    | 8                  | 131  | 45   | 1    | 25                         | 43   | 23   | 3    | 36                 | 82   | 31   | 2    | 36                         | 65   | 14   | 0    | 545        |
| 05:30 PM    | 12                 | 133  | 36   | 3    | 22                         | 38   | 26   | 2    | 35                 | 72   | 21   | 2    | 38                         | 57   | 6    | 2    | 505        |
| 05:45 PM    | 14                 | 128  | 41   | 2    | 15                         | 52   | 24   | 2    | 20                 | 79   | 30   | 0    | 33                         | 66   | 5    | 2    | 513        |
| Total       | 46                 | 518  | 163  | 6    | 73                         | 195  | 94   | 11   | 135                | 332  | 114  | 10   | 137                        | 243  | 36   | 4    | 2117       |
| Grand Total | 110                | 1062 | 326  | 11   | 156                        | 377  | 191  | 13   | 271                | 643  | 242  | 21   | 255                        | 475  | 69   | 12   | 4234       |
| Apprch %    | 7.3                | 70.4 | 21.6 | 0.7  | 21.2                       | 51.2 | 25.9 | 1.8  | 23                 | 54.6 | 20.6 | 1.8  | 31.4                       | 58.6 | 8.5  | 1.5  |            |
| Total %     | 2.6                | 25.1 | 7.7  | 0.3  | 3.7                        | 8.9  | 4.5  | 0.3  | 6.4                | 15.2 | 5.7  | 0.5  | 6                          | 11.2 | 1.6  | 0.3  |            |

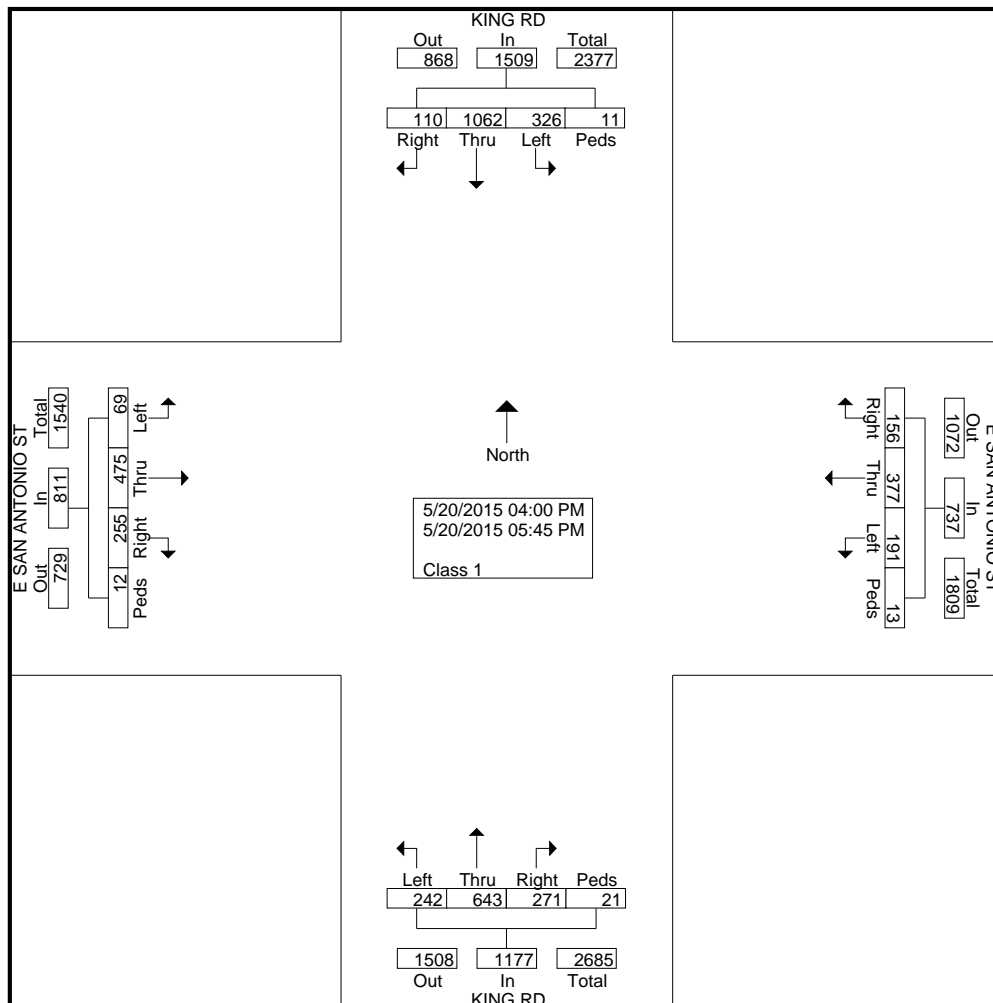

| Start Time  | KING RD Southbound |      |      |      |            | E SAN ANTONIO ST Westbound |      |      |      |            | KING RD Northbound |      |      |      |            | E SAN ANTONIO ST Eastbound |      |      |      |            | Int. Total |
|---|--------------------|------|------|------|------------|----------------------------|------|------|------|------------|--------------------|------|------|------|------------|----------------------------|------|------|------|------------|------------|
|   | Right              | Thru | Left | Peds | App. Total | Right                      | Thru | Left | Peds | App. Total | Right              | Thru | Left | Peds | App. Total | Right                      | Thru | Left | Peds | App. Total |            |
| <b>Peak Hour Analysis From 04:00 PM to 05:45 PM - Peak 1 of 1</b> |                    |      |      |      |            |                            |      |      |      |            |                    |      |      |      |            |                            |      |      |      |            |            |
| Peak Hour for Entire Intersection Begins at 04:15 PM              |                    |      |      |      |            |                            |      |      |      |            |                    |      |      |      |            |                            |      |      |      |            |            |
| 04:15 PM  | 18                 | 151  | 46   | 1    | 216        | 23                         | 53   | 30   | 0    | 106        | 40                 | 80   | 31   | 1    | 152        | 27                         | 62   | 7    | 2    | 98         | 572        |
| 04:30 PM  | 12                 | 140  | 44   | 3    | 199        | 24                         | 42   | 20   | 2    | 88         | 28                 | 65   | 35   | 2    | 130        | 35                         | 54   | 10   | 1    | 100        | 517        |
| 04:45 PM  | 20                 | 111  | 36   | 0    | 167        | 22                         | 49   | 17   | 0    | 88         | 37                 | 74   | 28   | 2    | 141        | 20                         | 70   | 9    | 2    | 101        | 497        |
| 05:00 PM  | 12                 | 126  | 41   | 0    | 179        | 11                         | 62   | 21   | 4    | 98         | 44                 | 99   | 32   | 6    | 181        | 30                         | 55   | 11   | 0    | 96         | 554        |
| Total Volume  | 62                 | 528  | 167  | 4    | 761        | 80                         | 206  | 88   | 6    | 380        | 149                | 318  | 126  | 11   | 604        | 112                        | 241  | 37   | 5    | 395        | 2140       |
| % App. Total  | 8.1                | 69.4 | 21.9 | 0.5  |            | 21.1                       | 54.2 | 23.2 | 1.6  |            | 24.7               | 52.6 | 20.9 | 1.8  |            | 28.4                       | 61   | 9.4  | 1.3  |            |            |
| PHF   | .775               | .874 | .908 | .333 | .881       | .833                       | .831 | .733 | .375 | .896       | .847               | .803 | .900 | .458 | .834       | .800                       | .861 | .841 | .625 | .978       | .935       |

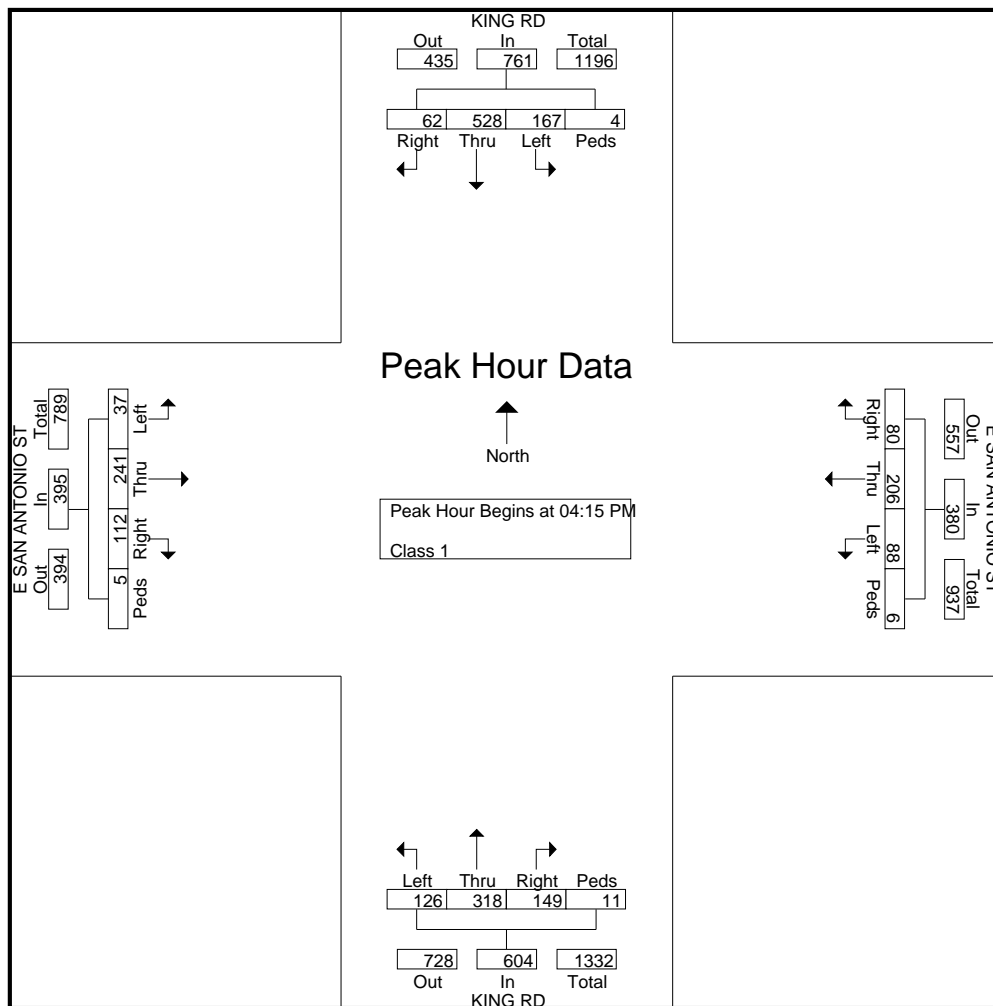

Groups Printed- Class 1

| Start Time  | COLEMAN AVE Southbound |      |      |      | TAYLOR ST Westbound |      |      |      | COLEMAN AVE Northbound |      |      |      | TAYLOR ST Eastbound |      |      |      | Int. Total |
|-------------|------------------------|------|------|------|---------------------|------|------|------|------------------------|------|------|------|---------------------|------|------|------|------------|
|             | Right                  | Thru | Left | Peds | Right               | Thru | Left | Peds | Right                  | Thru | Left | Peds | Right               | Thru | Left | Peds |            |
| 07:00 AM    | 20                     | 67   | 43   | 0    | 65                  | 83   | 16   | 1    | 2                      | 215  | 27   | 0    | 19                  | 54   | 49   | 1    | 662        |
| 07:15 AM    | 22                     | 71   | 52   | 2    | 61                  | 120  | 26   | 0    | 5                      | 256  | 46   | 1    | 25                  | 84   | 65   | 2    | 838        |
| 07:30 AM    | 49                     | 72   | 42   | 2    | 72                  | 135  | 20   | 1    | 6                      | 277  | 58   | 0    | 41                  | 127  | 75   | 3    | 980        |
| 07:45 AM    | 42                     | 90   | 55   | 1    | 61                  | 136  | 23   | 0    | 7                      | 268  | 64   | 1    | 39                  | 144  | 79   | 2    | 1012       |
| Total       | 133                    | 300  | 192  | 5    | 259                 | 474  | 85   | 2    | 20                     | 1016 | 195  | 2    | 124                 | 409  | 268  | 8    | 3492       |
| 08:00 AM    | 39                     | 84   | 42   | 2    | 76                  | 173  | 28   | 0    | 4                      | 225  | 39   | 0    | 43                  | 163  | 103  | 2    | 1023       |
| 08:15 AM    | 24                     | 93   | 44   | 2    | 79                  | 110  | 28   | 0    | 6                      | 259  | 43   | 0    | 28                  | 109  | 78   | 0    | 903        |
| 08:30 AM    | 28                     | 106  | 39   | 1    | 77                  | 100  | 25   | 1    | 6                      | 211  | 33   | 2    | 44                  | 114  | 59   | 0    | 846        |
| 08:45 AM    | 24                     | 83   | 38   | 2    | 84                  | 70   | 28   | 0    | 11                     | 196  | 38   | 0    | 27                  | 87   | 66   | 0    | 754        |
| Total       | 115                    | 366  | 163  | 7    | 316                 | 453  | 109  | 1    | 27                     | 891  | 153  | 2    | 142                 | 473  | 306  | 2    | 3526       |
| Grand Total | 248                    | 666  | 355  | 12   | 575                 | 927  | 194  | 3    | 47                     | 1907 | 348  | 4    | 266                 | 882  | 574  | 10   | 7018       |
| Apprch %    | 19.4                   | 52   | 27.7 | 0.9  | 33.8                | 54.6 | 11.4 | 0.2  | 2                      | 82.7 | 15.1 | 0.2  | 15.4                | 50.9 | 33.1 | 0.6  |            |
| Total %     | 3.5                    | 9.5  | 5.1  | 0.2  | 8.2                 | 13.2 | 2.8  | 0    | 0.7                    | 27.2 | 5    | 0.1  | 3.8                 | 12.6 | 8.2  | 0.1  |            |

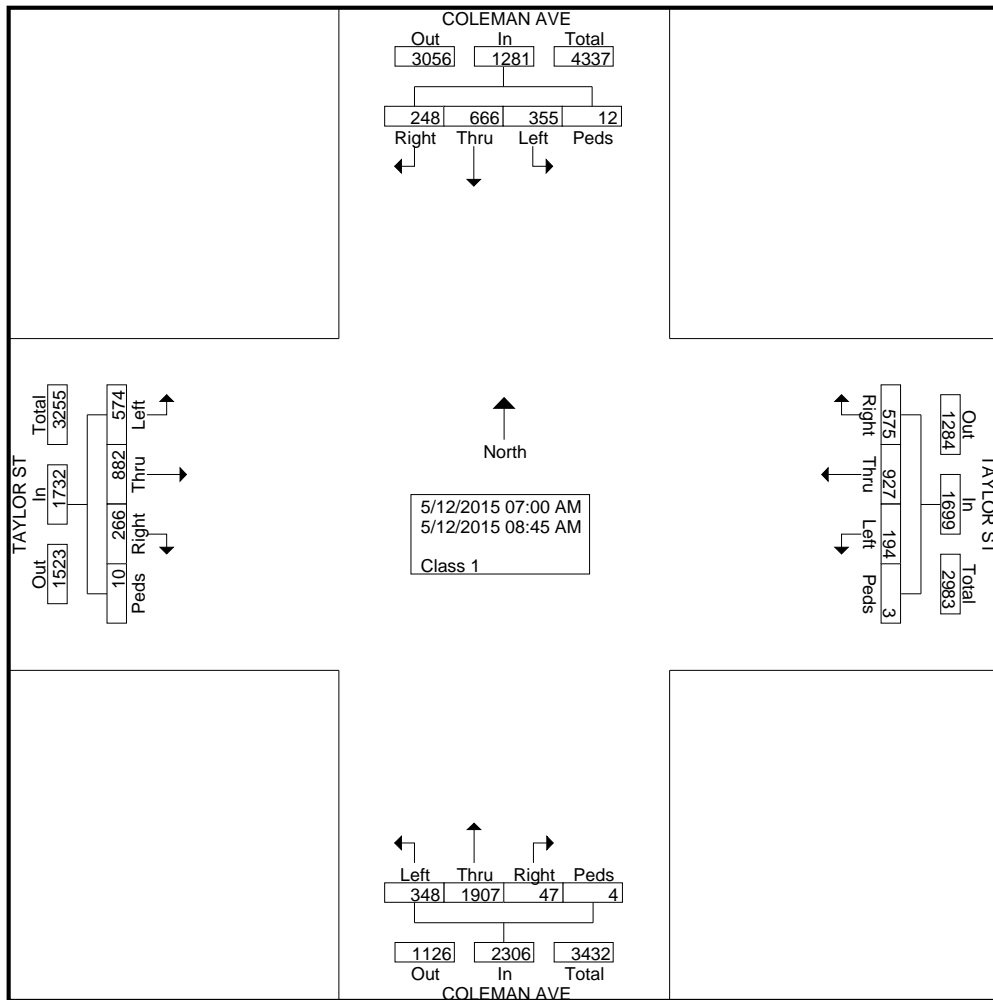

| Start Time  | COLEMAN AVE Southbound |      |      |      |            | TAYLOR ST Westbound |      |      |      |            | COLEMAN AVE Northbound |      |      |      |            | TAYLOR ST Eastbound |      |      |      |            | Int. Total |
|---|------------------------|------|------|------|------------|---------------------|------|------|------|------------|------------------------|------|------|------|------------|---------------------|------|------|------|------------|------------|
|   | Right                  | Thru | Left | Peds | App. Total | Right               | Thru | Left | Peds | App. Total | Right                  | Thru | Left | Peds | App. Total | Right               | Thru | Left | Peds | App. Total |            |
| <b>Peak Hour Analysis From 07:00 AM to 08:45 AM - Peak 1 of 1</b> |                        |      |      |      |            |                     |      |      |      |            |                        |      |      |      |            |                     |      |      |      |            |            |
| Peak Hour for Entire Intersection Begins at 07:30 AM              |                        |      |      |      |            |                     |      |      |      |            |                        |      |      |      |            |                     |      |      |      |            |            |
| 07:30 AM  | 49                     | 72   | 42   | 2    | 165        | 72                  | 135  | 20   | 1    | 228        | 6                      | 277  | 58   | 0    | 341        | 41                  | 127  | 75   | 3    | 246        | 980        |
| 07:45 AM  | 42                     | 90   | 55   | 1    | 188        | 61                  | 136  | 23   | 0    | 220        | 7                      | 268  | 64   | 1    | 340        | 39                  | 144  | 79   | 2    | 264        | 1012       |
| 08:00 AM  | 39                     | 84   | 42   | 2    | 167        | 76                  | 173  | 28   | 0    | 277        | 4                      | 225  | 39   | 0    | 268        | 43                  | 163  | 103  | 2    | 311        | 1023       |
| 08:15 AM  | 24                     | 93   | 44   | 2    | 163        | 79                  | 110  | 28   | 0    | 217        | 6                      | 259  | 43   | 0    | 308        | 28                  | 109  | 78   | 0    | 215        | 903        |
| Total Volume  | 154                    | 339  | 183  | 7    | 683        | 288                 | 554  | 99   | 1    | 942        | 23                     | 1029 | 204  | 1    | 1257       | 151                 | 543  | 335  | 7    | 1036       | 3918       |
| % App. Total  | 22.5                   | 49.6 | 26.8 | 1    |            | 30.6                | 58.8 | 10.5 | 0.1  |            | 1.8                    | 81.9 | 16.2 | 0.1  |            | 14.6                | 52.4 | 32.3 | 0.7  |            |            |
| PHF   | .786                   | .911 | .832 | .875 | .908       | .911                | .801 | .884 | .250 | .850       | .821                   | .929 | .797 | .250 | .922       | .878                | .833 | .813 | .583 | .833       | .957       |

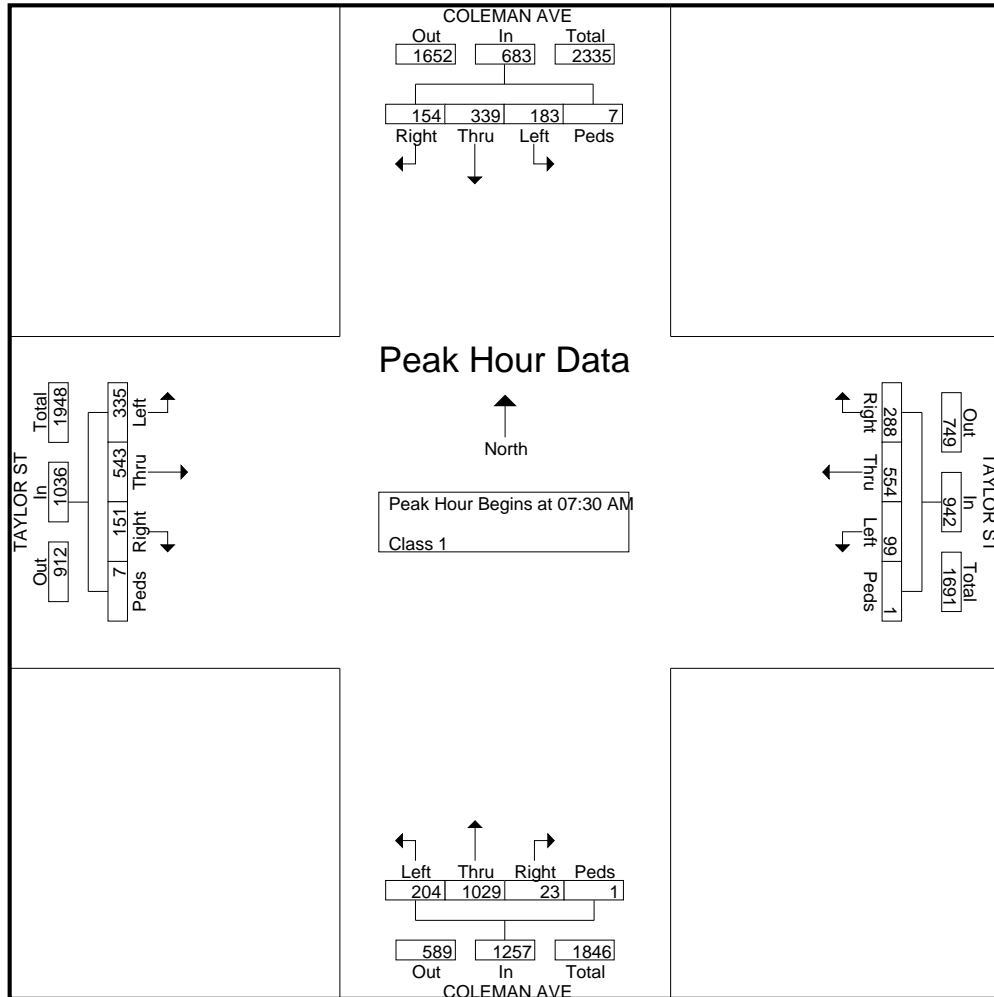



Groups Printed- Class 1

| Start Time  | COLEMAN AVE Southbound |      |      |      | TAYLOR ST Westbound |      |      |      | COLEMAN AVE Northbound |      |      |      | TAYLOR ST Eastbound |      |      |      | Int. Total |
|-------------|------------------------|------|------|------|---------------------|------|------|------|------------------------|------|------|------|---------------------|------|------|------|------------|
|             | Right                  | Thru | Left | Peds | Right               | Thru | Left | Peds | Right                  | Thru | Left | Peds | Right               | Thru | Left | Peds |            |
| 04:00 PM    | 37                     | 227  | 134  | 4    | 52                  | 112  | 69   | 0    | 16                     | 96   | 65   | 0    | 64                  | 125  | 40   | 2    | 1043       |
| 04:15 PM    | 48                     | 237  | 133  | 0    | 55                  | 113  | 61   | 1    | 19                     | 90   | 57   | 3    | 39                  | 129  | 45   | 2    | 1032       |
| 04:30 PM    | 59                     | 221  | 112  | 4    | 40                  | 114  | 59   | 1    | 16                     | 121  | 56   | 4    | 56                  | 101  | 44   | 5    | 1013       |
| 04:45 PM    | 45                     | 219  | 124  | 7    | 49                  | 109  | 61   | 1    | 16                     | 121  | 66   | 3    | 77                  | 119  | 37   | 4    | 1058       |
| Total       | 189                    | 904  | 503  | 15   | 196                 | 448  | 250  | 3    | 67                     | 428  | 244  | 10   | 236                 | 474  | 166  | 13   | 4146       |
| 05:00 PM    | 60                     | 262  | 99   | 0    | 63                  | 137  | 67   | 0    | 13                     | 105  | 55   | 1    | 76                  | 139  | 42   | 6    | 1125       |
| 05:15 PM    | 39                     | 262  | 89   | 0    | 59                  | 151  | 81   | 0    | 10                     | 148  | 60   | 5    | 74                  | 171  | 40   | 6    | 1195       |
| 05:30 PM    | 49                     | 247  | 94   | 0    | 42                  | 127  | 81   | 2    | 20                     | 102  | 69   | 0    | 82                  | 133  | 42   | 3    | 1093       |
| 05:45 PM    | 43                     | 255  | 73   | 1    | 51                  | 133  | 77   | 0    | 11                     | 100  | 77   | 5    | 92                  | 120  | 52   | 3    | 1093       |
| Total       | 191                    | 1026 | 355  | 1    | 215                 | 548  | 306  | 2    | 54                     | 455  | 261  | 11   | 324                 | 563  | 176  | 18   | 4506       |
| Grand Total | 380                    | 1930 | 858  | 16   | 411                 | 996  | 556  | 5    | 121                    | 883  | 505  | 21   | 560                 | 1037 | 342  | 31   | 8652       |
| Apprch %    | 11.9                   | 60.6 | 26.9 | 0.5  | 20.9                | 50.6 | 28.3 | 0.3  | 7.9                    | 57.7 | 33   | 1.4  | 28.4                | 52.6 | 17.4 | 1.6  |            |
| Total %     | 4.4                    | 22.3 | 9.9  | 0.2  | 4.8                 | 11.5 | 6.4  | 0.1  | 1.4                    | 10.2 | 5.8  | 0.2  | 6.5                 | 12   | 4    | 0.4  |            |

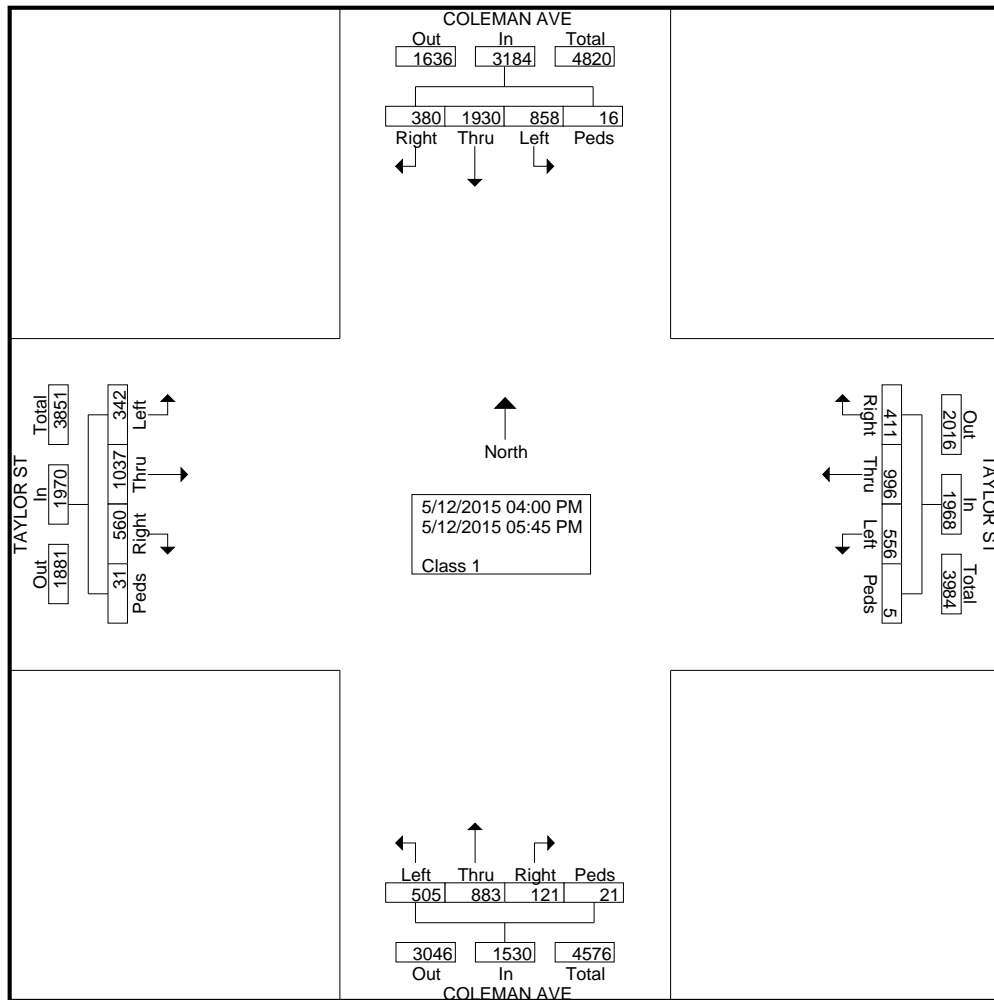

| Start Time  | COLEMAN AVE Southbound |      |      |      |            | TAYLOR ST Westbound |      |      |      |            | COLEMAN AVE Northbound |      |      |      |            | TAYLOR ST Eastbound |      |      |      |            | Int. Total |
|---|------------------------|------|------|------|------------|---------------------|------|------|------|------------|------------------------|------|------|------|------------|---------------------|------|------|------|------------|------------|
|   | Right                  | Thru | Left | Peds | App. Total | Right               | Thru | Left | Peds | App. Total | Right                  | Thru | Left | Peds | App. Total | Right               | Thru | Left | Peds | App. Total |            |
| <b>Peak Hour Analysis From 04:00 PM to 05:45 PM - Peak 1 of 1</b> |                        |      |      |      |            |                     |      |      |      |            |                        |      |      |      |            |                     |      |      |      |            |            |
| Peak Hour for Entire Intersection Begins at 05:00 PM              |                        |      |      |      |            |                     |      |      |      |            |                        |      |      |      |            |                     |      |      |      |            |            |
| 05:00 PM  | 60                     | 262  | 99   | 0    | 421        | 63                  | 137  | 67   | 0    | 267        | 13                     | 105  | 55   | 1    | 174        | 76                  | 139  | 42   | 6    | 263        | 1125       |
| 05:15 PM  | 39                     | 262  | 89   | 0    | 390        | 59                  | 151  | 81   | 0    | 291        | 10                     | 148  | 60   | 5    | 223        | 74                  | 171  | 40   | 6    | 291        | 1195       |
| 05:30 PM  | 49                     | 247  | 94   | 0    | 390        | 42                  | 127  | 81   | 2    | 252        | 20                     | 102  | 69   | 0    | 191        | 82                  | 133  | 42   | 3    | 260        | 1093       |
| 05:45 PM  | 43                     | 255  | 73   | 1    | 372        | 51                  | 133  | 77   | 0    | 261        | 11                     | 100  | 77   | 5    | 193        | 92                  | 120  | 52   | 3    | 267        | 1093       |
| Total Volume  | 191                    | 1026 | 355  | 1    | 1573       | 215                 | 548  | 306  | 2    | 1071       | 54                     | 455  | 261  | 11   | 781        | 324                 | 563  | 176  | 18   | 1081       | 4506       |
| % App. Total  | 12.1                   | 65.2 | 22.6 | 0.1  |            | 20.1                | 51.2 | 28.6 | 0.2  |            | 6.9                    | 58.3 | 33.4 | 1.4  |            | 30                  | 52.1 | 16.3 | 1.7  |            |            |
| PHF   | .796                   | .979 | .896 | .250 | .934       | .853                | .907 | .944 | .250 | .920       | .675                   | .769 | .847 | .550 | .876       | .880                | .823 | .846 | .750 | .929       | .943       |

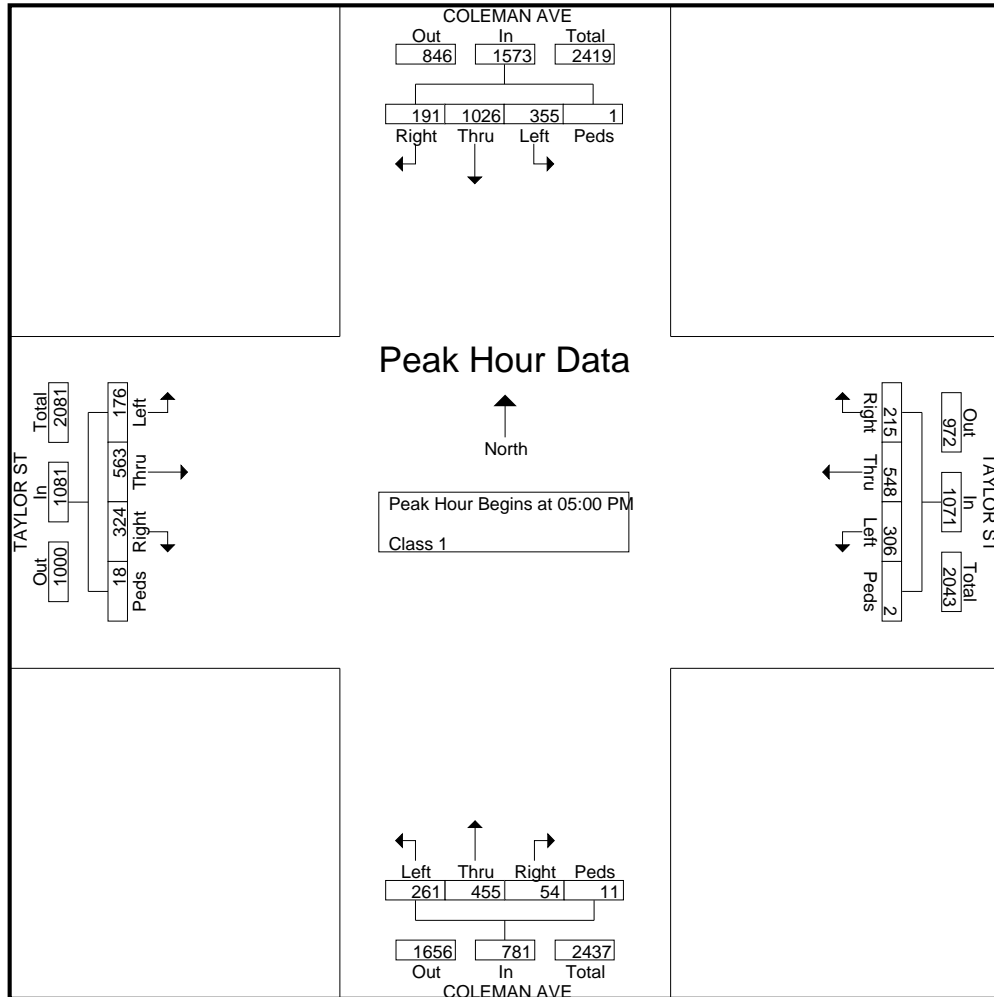

Groups Printed- Class 1

| Start Time  | JACKSON AVE Southbound |      |      |      | MCKEE RD Westbound |      |      |      | JACKSON AVE Northbound |      |      |      | MCKEE RD Eastbound |      |      |      | Int. Total |
|-------------|------------------------|------|------|------|--------------------|------|------|------|------------------------|------|------|------|--------------------|------|------|------|------------|
|             | Right                  | Thru | Left | Peds | Right              | Thru | Left | Peds | Right                  | Thru | Left | Peds | Right              | Thru | Left | Peds |            |
| 07:00 AM    | 16                     | 34   | 45   | 4    | 26                 | 140  | 38   | 4    | 46                     | 43   | 36   | 0    | 20                 | 96   | 28   | 0    | 576        |
| 07:15 AM    | 22                     | 28   | 64   | 3    | 35                 | 151  | 40   | 6    | 51                     | 55   | 39   | 2    | 24                 | 137  | 26   | 1    | 684        |
| 07:30 AM    | 20                     | 42   | 64   | 6    | 63                 | 167  | 46   | 9    | 74                     | 89   | 81   | 1    | 25                 | 233  | 37   | 3    | 960        |
| 07:45 AM    | 26                     | 56   | 59   | 8    | 74                 | 220  | 63   | 7    | 59                     | 95   | 61   | 2    | 24                 | 215  | 41   | 5    | 1015       |
| Total       | 84                     | 160  | 232  | 21   | 198                | 678  | 187  | 26   | 230                    | 282  | 217  | 5    | 93                 | 681  | 132  | 9    | 3235       |
| 08:00 AM    | 28                     | 37   | 103  | 0    | 88                 | 236  | 74   | 0    | 70                     | 105  | 64   | 2    | 25                 | 203  | 57   | 7    | 1099       |
| 08:15 AM    | 52                     | 74   | 108  | 0    | 71                 | 249  | 70   | 0    | 59                     | 68   | 51   | 3    | 22                 | 155  | 40   | 4    | 1026       |
| 08:30 AM    | 36                     | 45   | 85   | 0    | 66                 | 191  | 97   | 0    | 67                     | 84   | 36   | 7    | 32                 | 145  | 30   | 7    | 928        |
| 08:45 AM    | 53                     | 61   | 100  | 0    | 59                 | 222  | 78   | 0    | 62                     | 79   | 66   | 1    | 27                 | 121  | 35   | 4    | 968        |
| Total       | 169                    | 217  | 396  | 0    | 284                | 898  | 319  | 0    | 258                    | 336  | 217  | 13   | 106                | 624  | 162  | 22   | 4021       |
| Grand Total | 253                    | 377  | 628  | 21   | 482                | 1576 | 506  | 26   | 488                    | 618  | 434  | 18   | 199                | 1305 | 294  | 31   | 7256       |
| Apprch %    | 19.8                   | 29.5 | 49.1 | 1.6  | 18.6               | 60.8 | 19.5 | 1    | 31.3                   | 39.7 | 27.9 | 1.2  | 10.9               | 71.4 | 16.1 | 1.7  |            |
| Total %     | 3.5                    | 5.2  | 8.7  | 0.3  | 6.6                | 21.7 | 7    | 0.4  | 6.7                    | 8.5  | 6    | 0.2  | 2.7                | 18   | 4.1  | 0.4  |            |

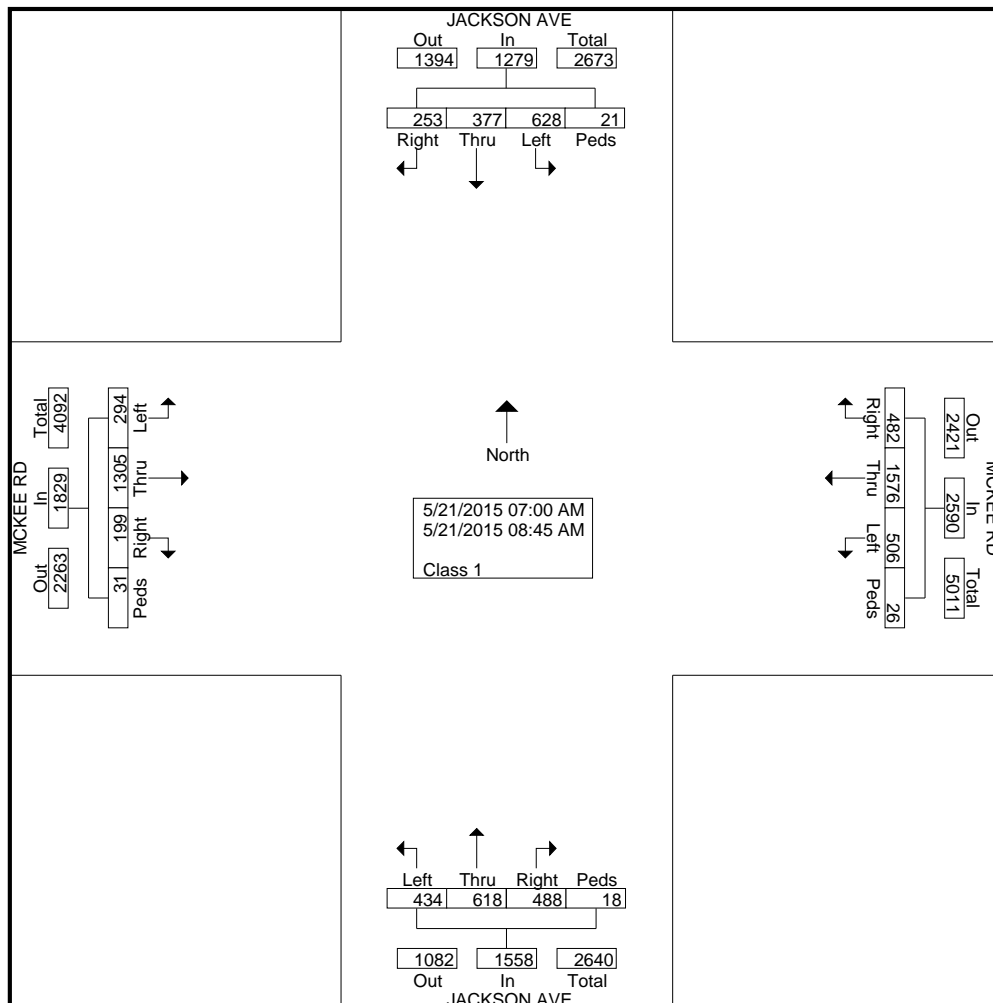

| Start Time  | JACKSON AVE Southbound |      |      |      |            | MCKEE RD Westbound |      |      |      |            | JACKSON AVE Northbound |      |      |      |            | MCKEE RD Eastbound |      |      |      |            | Int. Total |
|---|------------------------|------|------|------|------------|--------------------|------|------|------|------------|------------------------|------|------|------|------------|--------------------|------|------|------|------------|------------|
|   | Right                  | Thru | Left | Peds | App. Total | Right              | Thru | Left | Peds | App. Total | Right                  | Thru | Left | Peds | App. Total | Right              | Thru | Left | Peds | App. Total |            |
| <b>Peak Hour Analysis From 07:00 AM to 08:45 AM - Peak 1 of 1</b> |                        |      |      |      |            |                    |      |      |      |            |                        |      |      |      |            |                    |      |      |      |            |            |
| Peak Hour for Entire Intersection Begins at 07:30 AM              |                        |      |      |      |            |                    |      |      |      |            |                        |      |      |      |            |                    |      |      |      |            |            |
| 07:30 AM  | 20                     | 42   | 64   | 6    | 132        | 63                 | 167  | 46   | 9    | 285        | 74                     | 89   | 81   | 1    | 245        | 25                 | 233  | 37   | 3    | 298        | 960        |
| 07:45 AM  | 26                     | 56   | 59   | 8    | 149        | 74                 | 220  | 63   | 7    | 364        | 59                     | 95   | 61   | 2    | 217        | 24                 | 215  | 41   | 5    | 285        | 1015       |
| 08:00 AM  | 28                     | 37   | 103  | 0    | 168        | 88                 | 236  | 74   | 0    | 398        | 70                     | 105  | 64   | 2    | 241        | 25                 | 203  | 57   | 7    | 292        | 1099       |
| 08:15 AM  | 52                     | 74   | 108  | 0    | 234        | 71                 | 249  | 70   | 0    | 390        | 59                     | 68   | 51   | 3    | 181        | 22                 | 155  | 40   | 4    | 221        | 1026       |
| Total Volume  | 126                    | 209  | 334  | 14   | 683        | 296                | 872  | 253  | 16   | 1437       | 262                    | 357  | 257  | 8    | 884        | 96                 | 806  | 175  | 19   | 1096       | 4100       |
| % App. Total  | 18.4                   | 30.6 | 48.9 | 2    |            | 20.6               | 60.7 | 17.6 | 1.1  |            | 29.6                   | 40.4 | 29.1 | 0.9  |            | 8.8                | 73.5 | 16   | 1.7  |            |            |
| PHF   | .606                   | .706 | .773 | .438 | .730       | .841               | .876 | .855 | .444 | .903       | .885                   | .850 | .793 | .667 | .902       | .960               | .865 | .768 | .679 | .919       | .933       |

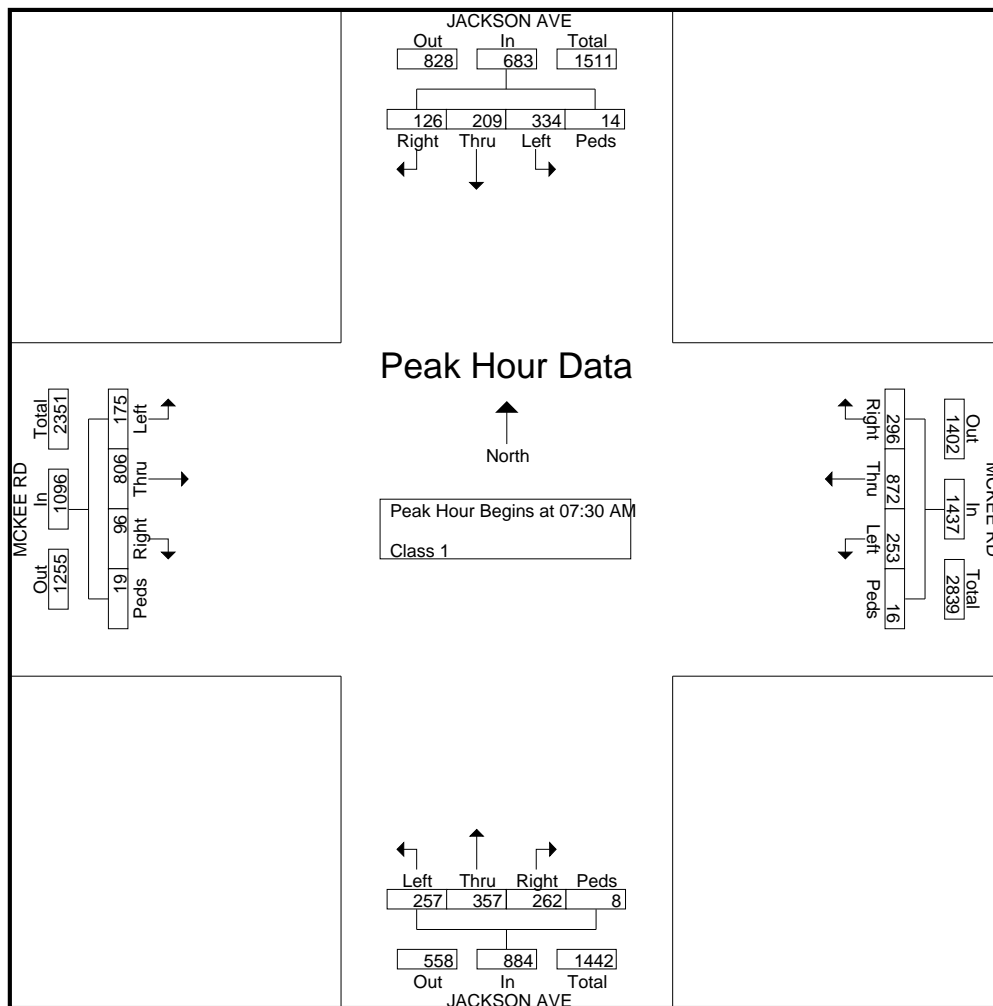

Groups Printed- Class 1

| Start Time  | JACKSON AVE Southbound |      |      |      | MCKEE RD Westbound |      |      |      | JACKSON AVE Northbound |      |      |      | MCKEE RD Eastbound |      |      |      | Int. Total |
|-------------|------------------------|------|------|------|--------------------|------|------|------|------------------------|------|------|------|--------------------|------|------|------|------------|
|             | Right                  | Thru | Left | Peds | Right              | Thru | Left | Peds | Right                  | Thru | Left | Peds | Right              | Thru | Left | Peds |            |
| 04:00 PM    | 50                     | 78   | 74   | 13   | 35                 | 201  | 74   | 9    | 68                     | 50   | 60   | 3    | 42                 | 204  | 49   | 8    | 1018       |
| 04:15 PM    | 67                     | 83   | 79   | 12   | 57                 | 204  | 82   | 3    | 84                     | 51   | 43   | 4    | 36                 | 186  | 50   | 6    | 1047       |
| 04:30 PM    | 47                     | 100  | 82   | 9    | 47                 | 215  | 70   | 11   | 69                     | 53   | 43   | 3    | 46                 | 197  | 27   | 2    | 1021       |
| 04:45 PM    | 55                     | 90   | 72   | 8    | 51                 | 179  | 60   | 48   | 49                     | 46   | 55   | 5    | 39                 | 189  | 43   | 7    | 996        |
| Total       | 219                    | 351  | 307  | 42   | 190                | 799  | 286  | 71   | 270                    | 200  | 201  | 15   | 163                | 776  | 169  | 23   | 4082       |
| 05:00 PM    | 48                     | 105  | 104  | 3    | 45                 | 175  | 72   | 9    | 64                     | 65   | 48   | 3    | 37                 | 221  | 41   | 5    | 1045       |
| 05:15 PM    | 49                     | 118  | 66   | 2    | 40                 | 159  | 70   | 2    | 63                     | 54   | 41   | 2    | 23                 | 228  | 52   | 2    | 971        |
| 05:30 PM    | 31                     | 97   | 89   | 7    | 65                 | 195  | 44   | 7    | 56                     | 47   | 47   | 1    | 32                 | 209  | 27   | 2    | 956        |
| 05:45 PM    | 47                     | 101  | 73   | 9    | 72                 | 201  | 84   | 41   | 61                     | 56   | 35   | 2    | 24                 | 178  | 44   | 4    | 1032       |
| Total       | 175                    | 421  | 332  | 21   | 222                | 730  | 270  | 59   | 244                    | 222  | 171  | 8    | 116                | 836  | 164  | 13   | 4004       |
| Grand Total | 394                    | 772  | 639  | 63   | 412                | 1529 | 556  | 130  | 514                    | 422  | 372  | 23   | 279                | 1612 | 333  | 36   | 8086       |
| Apprch %    | 21.1                   | 41.3 | 34.2 | 3.4  | 15.7               | 58.2 | 21.2 | 4.9  | 38.6                   | 31.7 | 27.9 | 1.7  | 12.3               | 71.3 | 14.7 | 1.6  |            |
| Total %     | 4.9                    | 9.5  | 7.9  | 0.8  | 5.1                | 18.9 | 6.9  | 1.6  | 6.4                    | 5.2  | 4.6  | 0.3  | 3.5                | 19.9 | 4.1  | 0.4  |            |

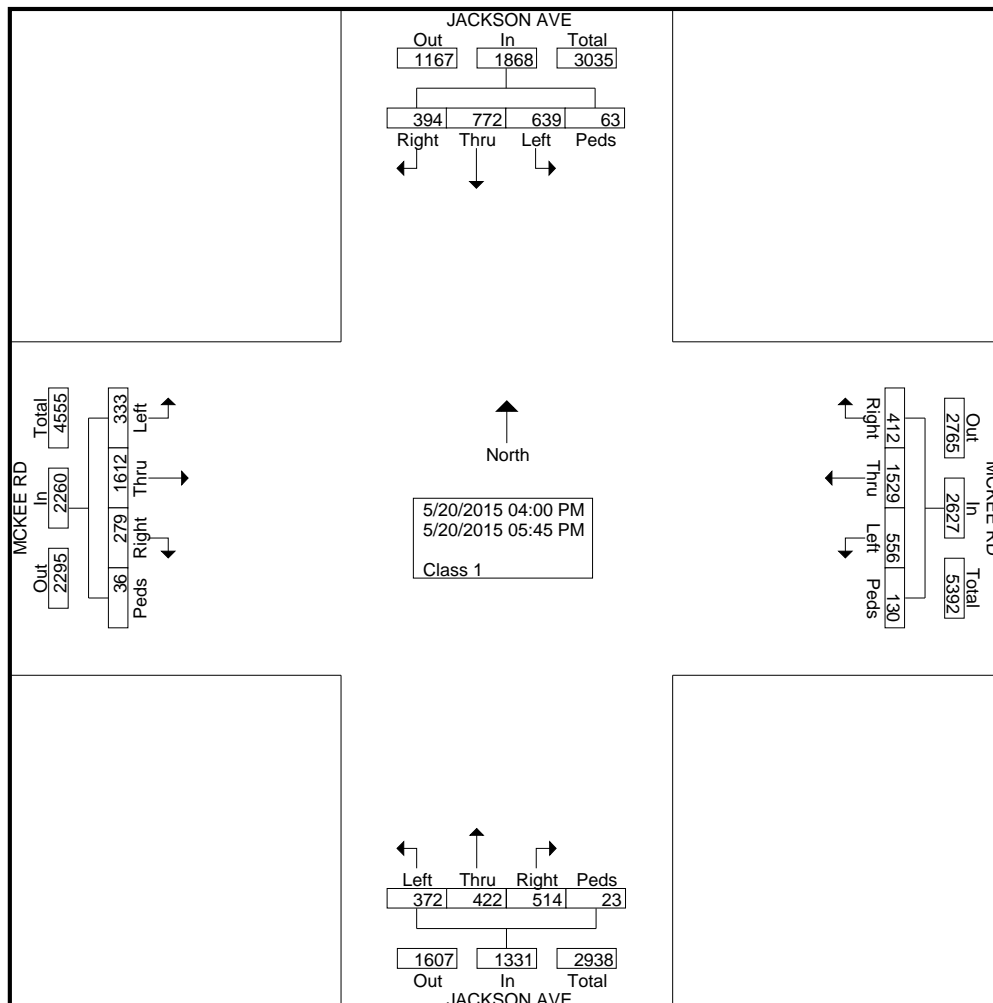

| Start Time  | JACKSON AVE Southbound |      |      |      |            | MCKEE RD Westbound |      |      |      |            | JACKSON AVE Northbound |      |      |      |            | MCKEE RD Eastbound |      |      |      |            | Int. Total |
|---|------------------------|------|------|------|------------|--------------------|------|------|------|------------|------------------------|------|------|------|------------|--------------------|------|------|------|------------|------------|
|   | Right                  | Thru | Left | Peds | App. Total | Right              | Thru | Left | Peds | App. Total | Right                  | Thru | Left | Peds | App. Total | Right              | Thru | Left | Peds | App. Total |            |
| <b>Peak Hour Analysis From 04:00 PM to 05:45 PM - Peak 1 of 1</b> |                        |      |      |      |            |                    |      |      |      |            |                        |      |      |      |            |                    |      |      |      |            |            |
| Peak Hour for Entire Intersection Begins at 04:15 PM              |                        |      |      |      |            |                    |      |      |      |            |                        |      |      |      |            |                    |      |      |      |            |            |
| 04:15 PM  | 67                     | 83   | 79   | 12   | 241        | 57                 | 204  | 82   | 3    | 346        | 84                     | 51   | 43   | 4    | 182        | 36                 | 186  | 50   | 6    | 278        | 1047       |
| 04:30 PM  | 47                     | 100  | 82   | 9    | 238        | 47                 | 215  | 70   | 11   | 343        | 69                     | 53   | 43   | 3    | 168        | 46                 | 197  | 27   | 2    | 272        | 1021       |
| 04:45 PM  | 55                     | 90   | 72   | 8    | 225        | 51                 | 179  | 60   | 48   | 338        | 49                     | 46   | 55   | 5    | 155        | 39                 | 189  | 43   | 7    | 278        | 996        |
| 05:00 PM  | 48                     | 105  | 104  | 3    | 260        | 45                 | 175  | 72   | 9    | 301        | 64                     | 65   | 48   | 3    | 180        | 37                 | 221  | 41   | 5    | 304        | 1045       |
| Total Volume  | 217                    | 378  | 337  | 32   | 964        | 200                | 773  | 284  | 71   | 1328       | 266                    | 215  | 189  | 15   | 685        | 158                | 793  | 161  | 20   | 1132       | 4109       |
| % App. Total  | 22.5                   | 39.2 | 35   | 3.3  |            | 15.1               | 58.2 | 21.4 | 5.3  |            | 38.8                   | 31.4 | 27.6 | 2.2  |            | 14                 | 70.1 | 14.2 | 1.8  |            |            |
| PHF   | .810                   | .900 | .810 | .667 | .927       | .877               | .899 | .866 | .370 | .960       | .792                   | .827 | .859 | .750 | .941       | .859               | .897 | .805 | .714 | .931       | .981       |

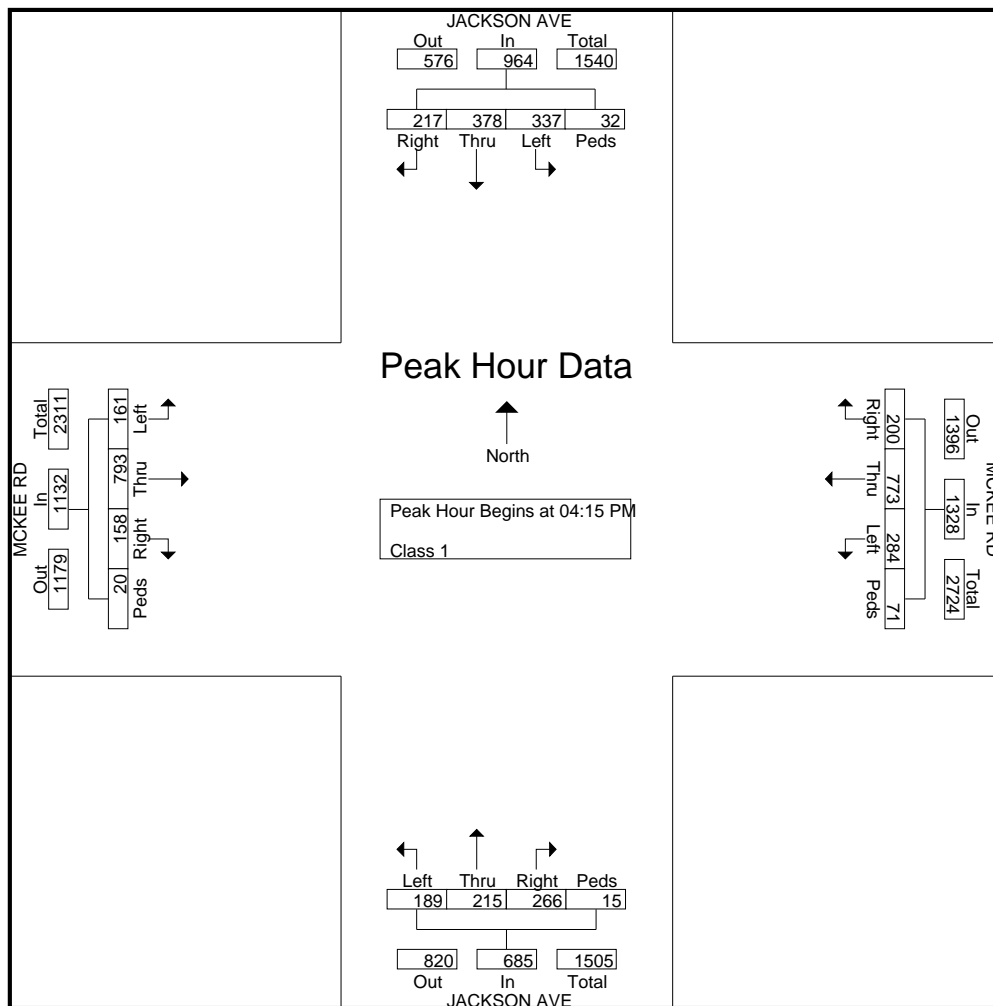

File Name : #5 JACKSON&SANANTONIOAM  
 Site Code :  
 Start Date : 5/21/2015  
 Page No : 1

Groups Printed- Class 1

| Start Time  | JACKSON AVE Southbound |      |      |      | CAPITOL EXPY Westbound |      |      |      | JACKSON AVE Northbound |      |      |      | E SAN ANTONIO ST Eastbound |      |      |      | Int. Total |
|-------------|------------------------|------|------|------|------------------------|------|------|------|------------------------|------|------|------|----------------------------|------|------|------|------------|
|             | Right                  | Thru | Left | Peds | Right                  | Thru | Left | Peds | Right                  | Thru | Left | Peds | Right                      | Thru | Left | Peds |            |
| 07:00 AM    | 22                     | 104  | 25   | 0    | 76                     | 46   | 25   | 2    | 3                      | 125  | 23   | 0    | 41                         | 32   | 27   | 1    | 552        |
| 07:15 AM    | 31                     | 105  | 37   | 6    | 103                    | 66   | 23   | 1    | 5                      | 149  | 30   | 1    | 52                         | 39   | 37   | 6    | 691        |
| 07:30 AM    | 33                     | 152  | 52   | 6    | 126                    | 82   | 28   | 3    | 8                      | 196  | 45   | 0    | 75                         | 50   | 49   | 8    | 913        |
| 07:45 AM    | 48                     | 124  | 59   | 5    | 97                     | 97   | 26   | 1    | 17                     | 171  | 54   | 2    | 64                         | 67   | 29   | 8    | 869        |
| Total       | 134                    | 485  | 173  | 17   | 402                    | 291  | 102  | 7    | 33                     | 641  | 152  | 3    | 232                        | 188  | 142  | 23   | 3025       |
| 08:00 AM    | 45                     | 107  | 42   | 9    | 92                     | 72   | 19   | 1    | 12                     | 131  | 50   | 2    | 63                         | 74   | 28   | 2    | 749        |
| 08:15 AM    | 38                     | 98   | 43   | 7    | 116                    | 84   | 17   | 0    | 5                      | 120  | 42   | 0    | 33                         | 47   | 37   | 2    | 689        |
| 08:30 AM    | 29                     | 96   | 30   | 2    | 103                    | 84   | 14   | 1    | 1                      | 146  | 44   | 0    | 36                         | 53   | 42   | 1    | 682        |
| 08:45 AM    | 35                     | 66   | 32   | 0    | 82                     | 59   | 10   | 2    | 1                      | 94   | 31   | 0    | 26                         | 50   | 41   | 3    | 532        |
| Total       | 147                    | 367  | 147  | 18   | 393                    | 299  | 60   | 4    | 19                     | 491  | 167  | 2    | 158                        | 224  | 148  | 8    | 2652       |
| Grand Total | 281                    | 852  | 320  | 35   | 795                    | 590  | 162  | 11   | 52                     | 1132 | 319  | 5    | 390                        | 412  | 290  | 31   | 5677       |
| Apprch %    | 18.9                   | 57.3 | 21.5 | 2.4  | 51                     | 37.9 | 10.4 | 0.7  | 3.4                    | 75.1 | 21.2 | 0.3  | 34.7                       | 36.7 | 25.8 | 2.8  |            |
| Total %     | 4.9                    | 15   | 5.6  | 0.6  | 14                     | 10.4 | 2.9  | 0.2  | 0.9                    | 19.9 | 5.6  | 0.1  | 6.9                        | 7.3  | 5.1  | 0.5  |            |

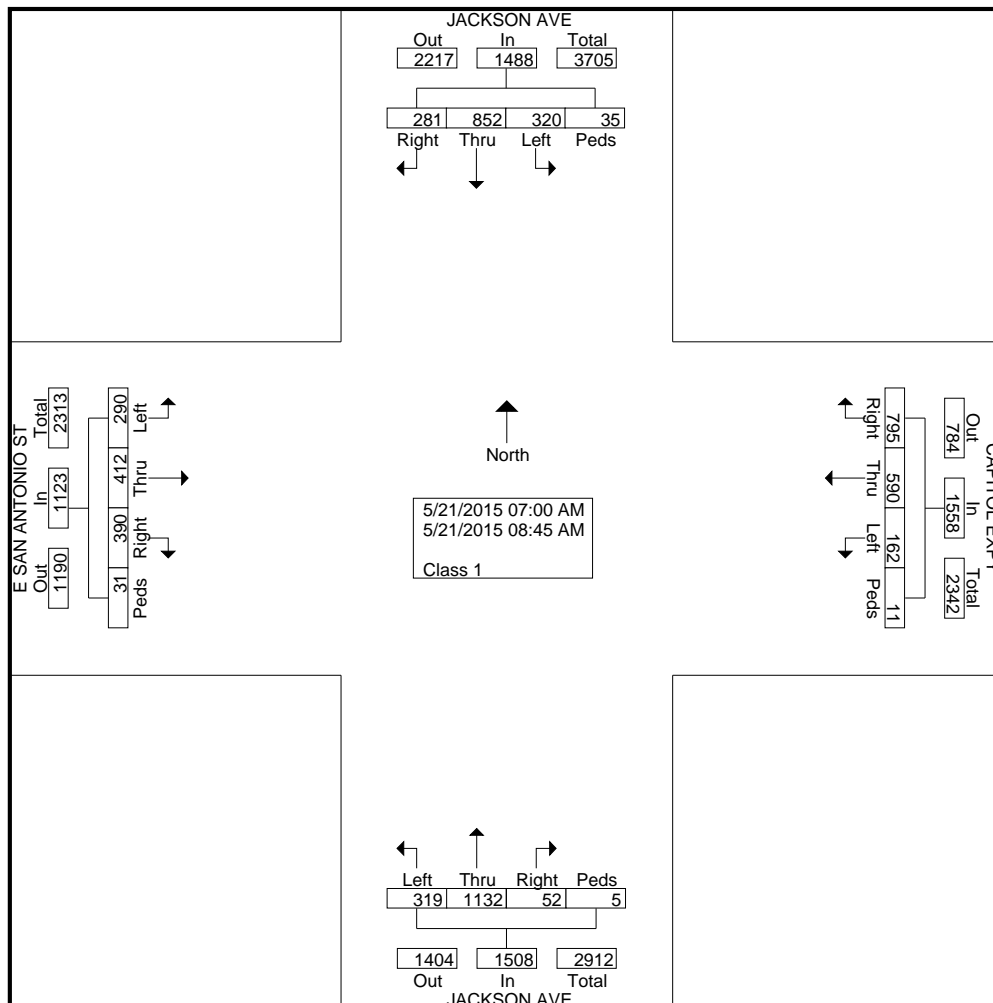



File Name : #5 JACKSON&SANANTONIOAM  
 Site Code :  
 Start Date : 5/21/2015  
 Page No : 2

| Start Time  | JACKSON AVE Southbound |      |      |      |            | CAPITOL EXPY Westbound |      |      |      |            | JACKSON AVE Northbound |      |      |      |            | E SAN ANTONIO ST Eastbound |      |      |      |            | Int. Total |
|---|------------------------|------|------|------|------------|------------------------|------|------|------|------------|------------------------|------|------|------|------------|----------------------------|------|------|------|------------|------------|
|   | Right                  | Thru | Left | Peds | App. Total | Right                  | Thru | Left | Peds | App. Total | Right                  | Thru | Left | Peds | App. Total | Right                      | Thru | Left | Peds | App. Total |            |
| <b>Peak Hour Analysis From 07:00 AM to 08:45 AM - Peak 1 of 1</b> |                        |      |      |      |            |                        |      |      |      |            |                        |      |      |      |            |                            |      |      |      |            |            |
| Peak Hour for Entire Intersection Begins at 07:15 AM              |                        |      |      |      |            |                        |      |      |      |            |                        |      |      |      |            |                            |      |      |      |            |            |
| 07:15 AM  | 31                     | 105  | 37   | 6    | 179        | 103                    | 66   | 23   | 1    | 193        | 5                      | 149  | 30   | 1    | 185        | 52                         | 39   | 37   | 6    | 134        | 691        |
| 07:30 AM  | 33                     | 152  | 52   | 6    | 243        | 126                    | 82   | 28   | 3    | 239        | 8                      | 196  | 45   | 0    | 249        | 75                         | 50   | 49   | 8    | 182        | 913        |
| 07:45 AM  | 48                     | 124  | 59   | 5    | 236        | 97                     | 97   | 26   | 1    | 221        | 17                     | 171  | 54   | 2    | 244        | 64                         | 67   | 29   | 8    | 168        | 869        |
| 08:00 AM  | 45                     | 107  | 42   | 9    | 203        | 92                     | 72   | 19   | 1    | 184        | 12                     | 131  | 50   | 2    | 195        | 63                         | 74   | 28   | 2    | 167        | 749        |
| Total Volume  | 157                    | 488  | 190  | 26   | 861        | 418                    | 317  | 96   | 6    | 837        | 42                     | 647  | 179  | 5    | 873        | 254                        | 230  | 143  | 24   | 651        | 3222       |
| % App. Total  | 18.2                   | 56.7 | 22.1 | 3    |            | 49.9                   | 37.9 | 11.5 | 0.7  |            | 4.8                    | 74.1 | 20.5 | 0.6  |            | 39                         | 35.3 | 22   | 3.7  |            |            |
| PHF   | .818                   | .803 | .805 | .722 | .886       | .829                   | .817 | .857 | .500 | .876       | .618                   | .825 | .829 | .625 | .877       | .847                       | .777 | .730 | .750 | .894       | .882       |

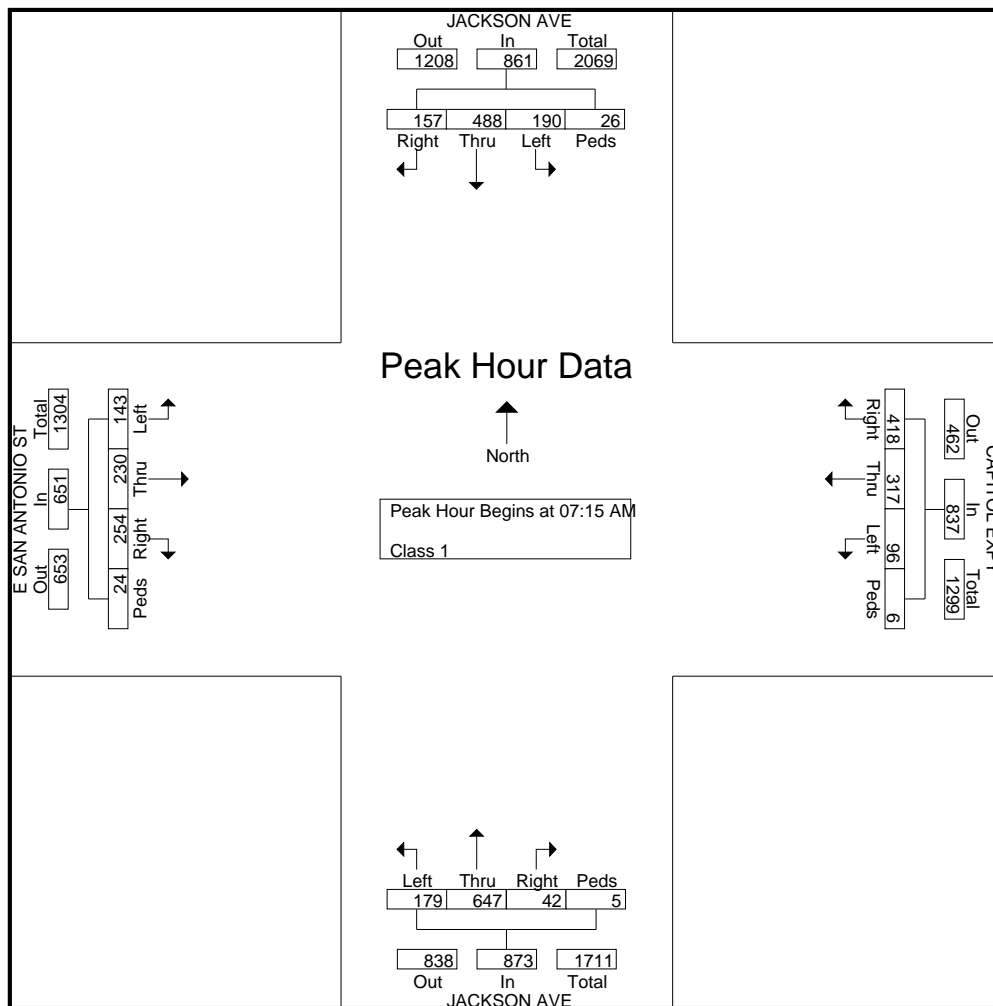

File Name : #5 JACKSON&SANANTONIOPM  
 Site Code :  
 Start Date : 5/20/2015  
 Page No : 1

Groups Printed- Class 1

| Start Time  | JACKSON AVE Southbound |      |      |      | CAPITOL EXPY Westbound |      |      |      | JACKSON AVE Northbound |      |      |      | E SAN ANTONIO ST Eastbound |      |      |      | Int. Total |
|-------------|------------------------|------|------|------|------------------------|------|------|------|------------------------|------|------|------|----------------------------|------|------|------|------------|
|             | Right                  | Thru | Left | Peds | Right                  | Thru | Left | Peds | Right                  | Thru | Left | Peds | Right                      | Thru | Left | Peds |            |
| 04:00 PM    | 40                     | 172  | 79   | 4    | 49                     | 51   | 16   | 3    | 20                     | 111  | 42   | 2    | 52                         | 98   | 39   | 0    | 778        |
| 04:15 PM    | 37                     | 197  | 91   | 2    | 46                     | 65   | 7    | 3    | 14                     | 134  | 40   | 2    | 65                         | 73   | 37   | 4    | 817        |
| 04:30 PM    | 50                     | 153  | 94   | 1    | 46                     | 56   | 11   | 0    | 21                     | 80   | 28   | 0    | 51                         | 68   | 26   | 2    | 687        |
| 04:45 PM    | 38                     | 172  | 73   | 0    | 52                     | 61   | 11   | 1    | 17                     | 81   | 38   | 1    | 43                         | 90   | 31   | 1    | 710        |
| Total       | 165                    | 694  | 337  | 7    | 193                    | 233  | 45   | 7    | 72                     | 406  | 148  | 5    | 211                        | 329  | 133  | 7    | 2992       |
| 05:00 PM    | 45                     | 215  | 83   | 0    | 50                     | 79   | 8    | 2    | 15                     | 87   | 41   | 0    | 57                         | 83   | 37   | 2    | 804        |
| 05:15 PM    | 44                     | 200  | 72   | 4    | 56                     | 63   | 15   | 0    | 24                     | 94   | 46   | 1    | 55                         | 83   | 33   | 1    | 791        |
| 05:30 PM    | 46                     | 189  | 103  | 0    | 60                     | 56   | 7    | 4    | 23                     | 83   | 33   | 0    | 49                         | 66   | 32   | 2    | 753        |
| 05:45 PM    | 51                     | 158  | 92   | 0    | 56                     | 51   | 9    | 3    | 22                     | 75   | 47   | 4    | 62                         | 91   | 31   | 1    | 753        |
| Total       | 186                    | 762  | 350  | 4    | 222                    | 249  | 39   | 9    | 84                     | 339  | 167  | 5    | 223                        | 323  | 133  | 6    | 3101       |
| Grand Total | 351                    | 1456 | 687  | 11   | 415                    | 482  | 84   | 16   | 156                    | 745  | 315  | 10   | 434                        | 652  | 266  | 13   | 6093       |
| Apprch %    | 14                     | 58.1 | 27.4 | 0.4  | 41.6                   | 48.3 | 8.4  | 1.6  | 12.7                   | 60.8 | 25.7 | 0.8  | 31.8                       | 47.8 | 19.5 | 1    |            |
| Total %     | 5.8                    | 23.9 | 11.3 | 0.2  | 6.8                    | 7.9  | 1.4  | 0.3  | 2.6                    | 12.2 | 5.2  | 0.2  | 7.1                        | 10.7 | 4.4  | 0.2  |            |

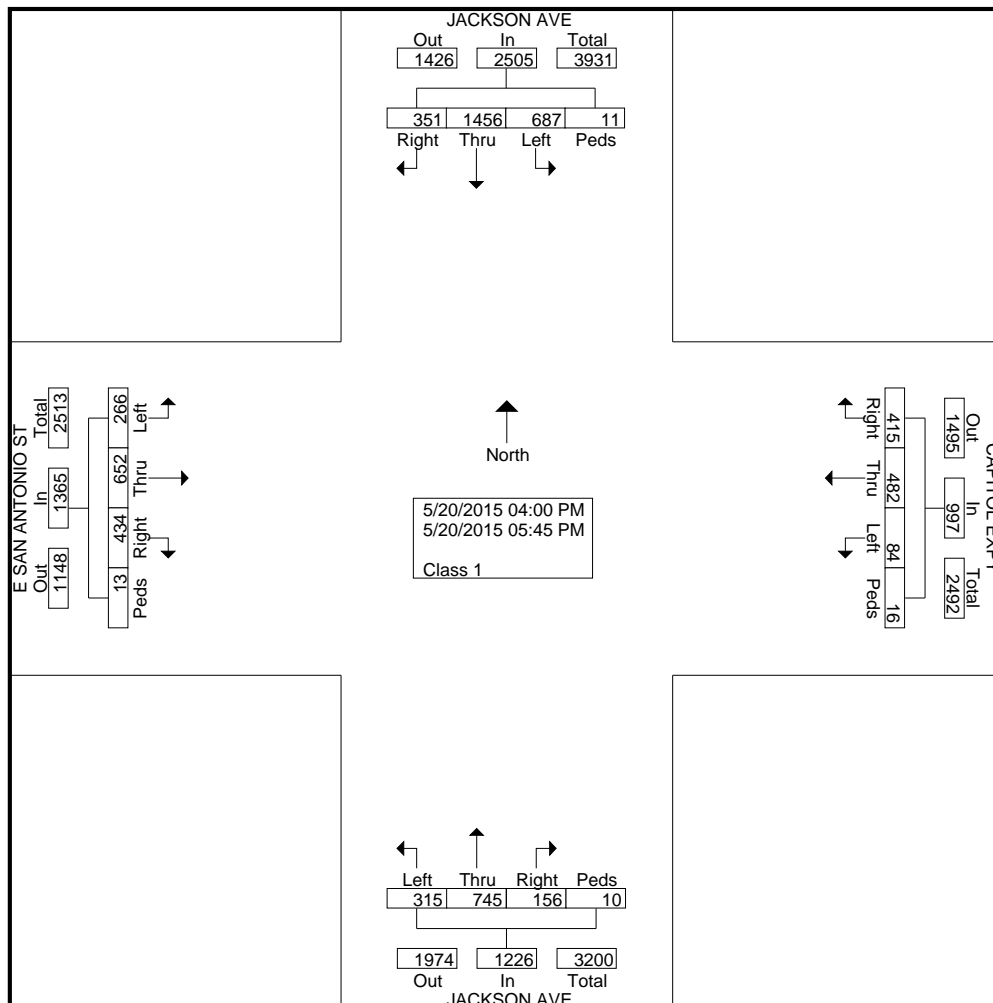

File Name : #5 JACKSON&SANANTONIOPM  
 Site Code :  
 Start Date : 5/20/2015  
 Page No : 2

| Start Time  | JACKSON AVE Southbound |      |      |      |            | CAPITOL EXPY Westbound |      |      |      |            | JACKSON AVE Northbound |      |      |      |            | E SAN ANTONIO ST Eastbound |      |      |      |            | Int. Total |
|---|------------------------|------|------|------|------------|------------------------|------|------|------|------------|------------------------|------|------|------|------------|----------------------------|------|------|------|------------|------------|
|   | Right                  | Thru | Left | Peds | App. Total | Right                  | Thru | Left | Peds | App. Total | Right                  | Thru | Left | Peds | App. Total | Right                      | Thru | Left | Peds | App. Total |            |
| <b>Peak Hour Analysis From 04:00 PM to 05:45 PM - Peak 1 of 1</b> |                        |      |      |      |            |                        |      |      |      |            |                        |      |      |      |            |                            |      |      |      |            |            |
| Peak Hour for Entire Intersection Begins at 05:00 PM              |                        |      |      |      |            |                        |      |      |      |            |                        |      |      |      |            |                            |      |      |      |            |            |
| 05:00 PM  | 45                     | 215  | 83   | 0    | 343        | 50                     | 79   | 8    | 2    | 139        | 15                     | 87   | 41   | 0    | 143        | 57                         | 83   | 37   | 2    | 179        | 804        |
| 05:15 PM  | 44                     | 200  | 72   | 4    | 320        | 56                     | 63   | 15   | 0    | 134        | 24                     | 94   | 46   | 1    | 165        | 55                         | 83   | 33   | 1    | 172        | 791        |
| 05:30 PM  | 46                     | 189  | 103  | 0    | 338        | 60                     | 56   | 7    | 4    | 127        | 23                     | 83   | 33   | 0    | 139        | 49                         | 66   | 32   | 2    | 149        | 753        |
| 05:45 PM  | 51                     | 158  | 92   | 0    | 301        | 56                     | 51   | 9    | 3    | 119        | 22                     | 75   | 47   | 4    | 148        | 62                         | 91   | 31   | 1    | 185        | 753        |
| Total Volume  | 186                    | 762  | 350  | 4    | 1302       | 222                    | 249  | 39   | 9    | 519        | 84                     | 339  | 167  | 5    | 595        | 223                        | 323  | 133  | 6    | 685        | 3101       |
| % App. Total  | 14.3                   | 58.5 | 26.9 | 0.3  |            | 42.8                   | 48   | 7.5  | 1.7  |            | 14.1                   | 57   | 28.1 | 0.8  |            | 32.6                       | 47.2 | 19.4 | 0.9  |            |            |
| PHF   | .912                   | .886 | .850 | .250 | .949       | .925                   | .788 | .650 | .563 | .933       | .875                   | .902 | .888 | .313 | .902       | .899                       | .887 | .899 | .750 | .926       | .964       |

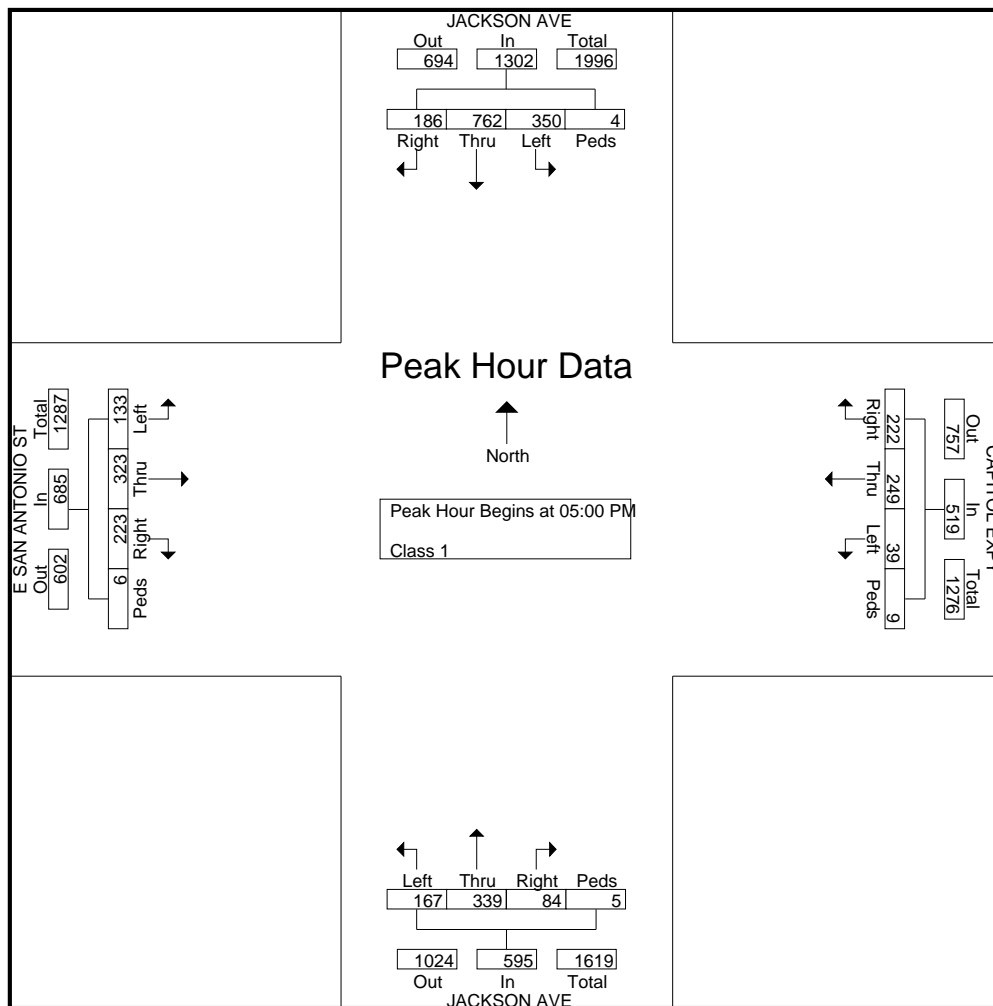

File Name : #6 JACKSON&ALUMROCKAM  
 Site Code :  
 Start Date : 5/21/2015  
 Page No : 1

Groups Printed- Class 1

| Start Time  | JACKSON AVE Southbound |      |      |      | ALUM ROCK AVE Westbound |      |      |      | JACKSON AVE Northbound |      |      |      | ALUM ROCK AVE Eastbound |      |      |      | Int. Total |
|-------------|------------------------|------|------|------|-------------------------|------|------|------|------------------------|------|------|------|-------------------------|------|------|------|------------|
|             | Right                  | Thru | Left | Peds | Right                   | Thru | Left | Peds | Right                  | Thru | Left | Peds | Right                   | Thru | Left | Peds |            |
| 07:00 AM    | 14                     | 88   | 10   | 3    | 10                      | 58   | 36   | 9    | 66                     | 109  | 32   | 3    | 13                      | 49   | 8    | 6    | 514        |
| 07:15 AM    | 9                      | 88   | 15   | 3    | 26                      | 85   | 57   | 7    | 70                     | 129  | 33   | 6    | 24                      | 53   | 12   | 4    | 621        |
| 07:30 AM    | 11                     | 122  | 35   | 8    | 44                      | 87   | 44   | 21   | 71                     | 160  | 21   | 11   | 28                      | 115  | 19   | 8    | 805        |
| 07:45 AM    | 16                     | 113  | 14   | 6    | 37                      | 89   | 36   | 9    | 70                     | 222  | 31   | 3    | 28                      | 85   | 21   | 8    | 788        |
| Total       | 50                     | 411  | 74   | 20   | 117                     | 319  | 173  | 46   | 277                    | 620  | 117  | 23   | 93                      | 302  | 60   | 26   | 2728       |
| 08:00 AM    | 18                     | 88   | 19   | 5    | 59                      | 97   | 61   | 2    | 58                     | 186  | 18   | 6    | 24                      | 87   | 18   | 5    | 751        |
| 08:15 AM    | 14                     | 102  | 22   | 9    | 47                      | 86   | 31   | 11   | 62                     | 183  | 22   | 7    | 32                      | 73   | 29   | 11   | 741        |
| 08:30 AM    | 10                     | 78   | 9    | 5    | 57                      | 102  | 30   | 5    | 53                     | 164  | 24   | 3    | 17                      | 78   | 24   | 7    | 666        |
| 08:45 AM    | 15                     | 85   | 29   | 5    | 51                      | 63   | 26   | 9    | 44                     | 183  | 23   | 4    | 16                      | 64   | 25   | 9    | 651        |
| Total       | 57                     | 353  | 79   | 24   | 214                     | 348  | 148  | 27   | 217                    | 716  | 87   | 20   | 89                      | 302  | 96   | 32   | 2809       |
| Grand Total | 107                    | 764  | 153  | 44   | 331                     | 667  | 321  | 73   | 494                    | 1336 | 204  | 43   | 182                     | 604  | 156  | 58   | 5537       |
| Apprch %    | 10                     | 71.5 | 14.3 | 4.1  | 23.8                    | 47.9 | 23.1 | 5.2  | 23.8                   | 64.3 | 9.8  | 2.1  | 18.2                    | 60.4 | 15.6 | 5.8  |            |
| Total %     | 1.9                    | 13.8 | 2.8  | 0.8  | 6                       | 12   | 5.8  | 1.3  | 8.9                    | 24.1 | 3.7  | 0.8  | 3.3                     | 10.9 | 2.8  | 1    |            |

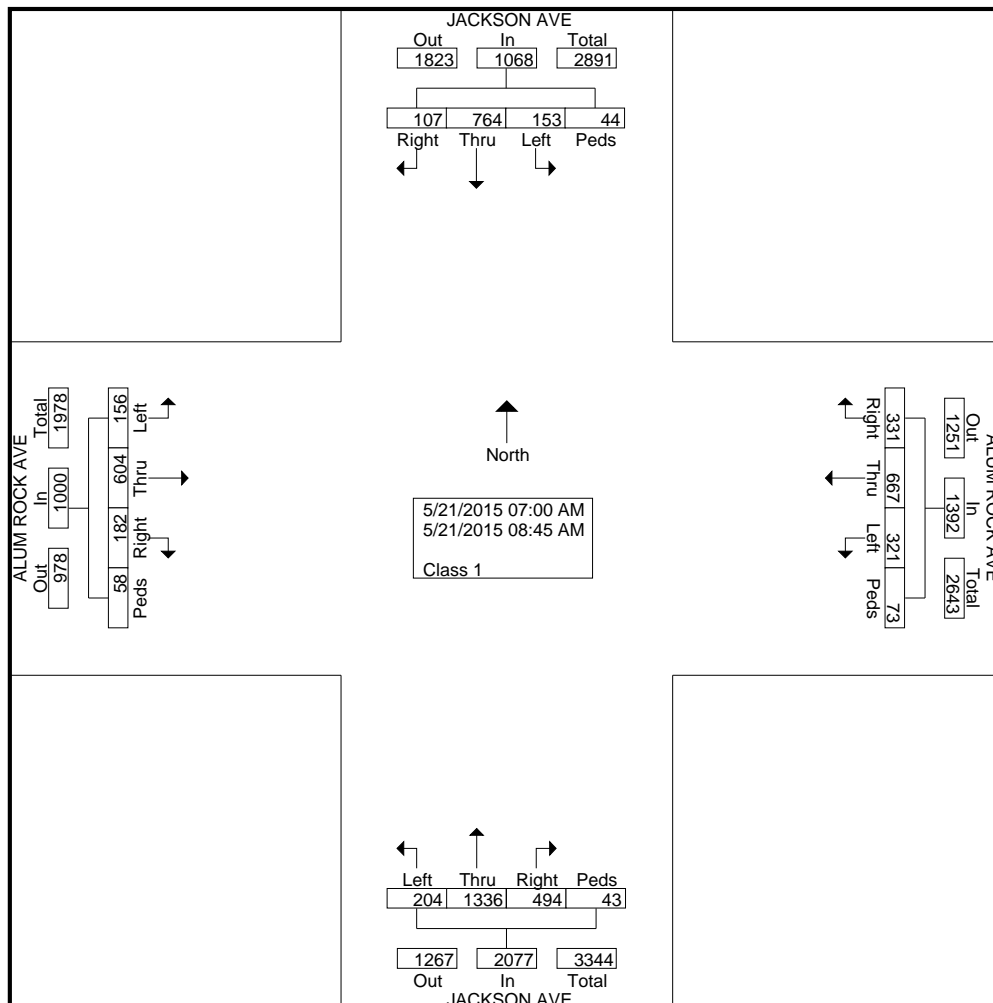

File Name : #6 JACKSON&ALUMROCKAM  
 Site Code :  
 Start Date : 5/21/2015  
 Page No : 2

| Start Time  | JACKSON AVE Southbound |      |      |      |            | ALUM ROCK AVE Westbound |      |      |      |            | JACKSON AVE Northbound |      |      |      |            | ALUM ROCK AVE Eastbound |      |      |      |            | Int. Total |
|---|------------------------|------|------|------|------------|-------------------------|------|------|------|------------|------------------------|------|------|------|------------|-------------------------|------|------|------|------------|------------|
|   | Right                  | Thru | Left | Peds | App. Total | Right                   | Thru | Left | Peds | App. Total | Right                  | Thru | Left | Peds | App. Total | Right                   | Thru | Left | Peds | App. Total |            |
| <b>Peak Hour Analysis From 07:00 AM to 08:45 AM - Peak 1 of 1</b> |                        |      |      |      |            |                         |      |      |      |            |                        |      |      |      |            |                         |      |      |      |            |            |
| Peak Hour for Entire Intersection Begins at 07:30 AM              |                        |      |      |      |            |                         |      |      |      |            |                        |      |      |      |            |                         |      |      |      |            |            |
| 07:30 AM  | 11                     | 122  | 35   | 8    | 176        | 44                      | 87   | 44   | 21   | 196        | 71                     | 160  | 21   | 11   | 263        | 28                      | 115  | 19   | 8    | 170        | 805        |
| 07:45 AM  | 16                     | 113  | 14   | 6    | 149        | 37                      | 89   | 36   | 9    | 171        | 70                     | 222  | 31   | 3    | 326        | 28                      | 85   | 21   | 8    | 142        | 788        |
| 08:00 AM  | 18                     | 88   | 19   | 5    | 130        | 59                      | 97   | 61   | 2    | 219        | 58                     | 186  | 18   | 6    | 268        | 24                      | 87   | 18   | 5    | 134        | 751        |
| 08:15 AM  | 14                     | 102  | 22   | 9    | 147        | 47                      | 86   | 31   | 11   | 175        | 62                     | 183  | 22   | 7    | 274        | 32                      | 73   | 29   | 11   | 145        | 741        |
| Total Volume  | 59                     | 425  | 90   | 28   | 602        | 187                     | 359  | 172  | 43   | 761        | 261                    | 751  | 92   | 27   | 1131       | 112                     | 360  | 87   | 32   | 591        | 3085       |
| % App. Total  | 9.8                    | 70.6 | 15   | 4.7  |            | 24.6                    | 47.2 | 22.6 | 5.7  |            | 23.1                   | 66.4 | 8.1  | 2.4  |            | 19                      | 60.9 | 14.7 | 5.4  |            |            |
| PHF   | .819                   | .871 | .643 | .778 | .855       | .792                    | .925 | .705 | .512 | .869       | .919                   | .846 | .742 | .614 | .867       | .875                    | .783 | .750 | .727 | .869       | .958       |

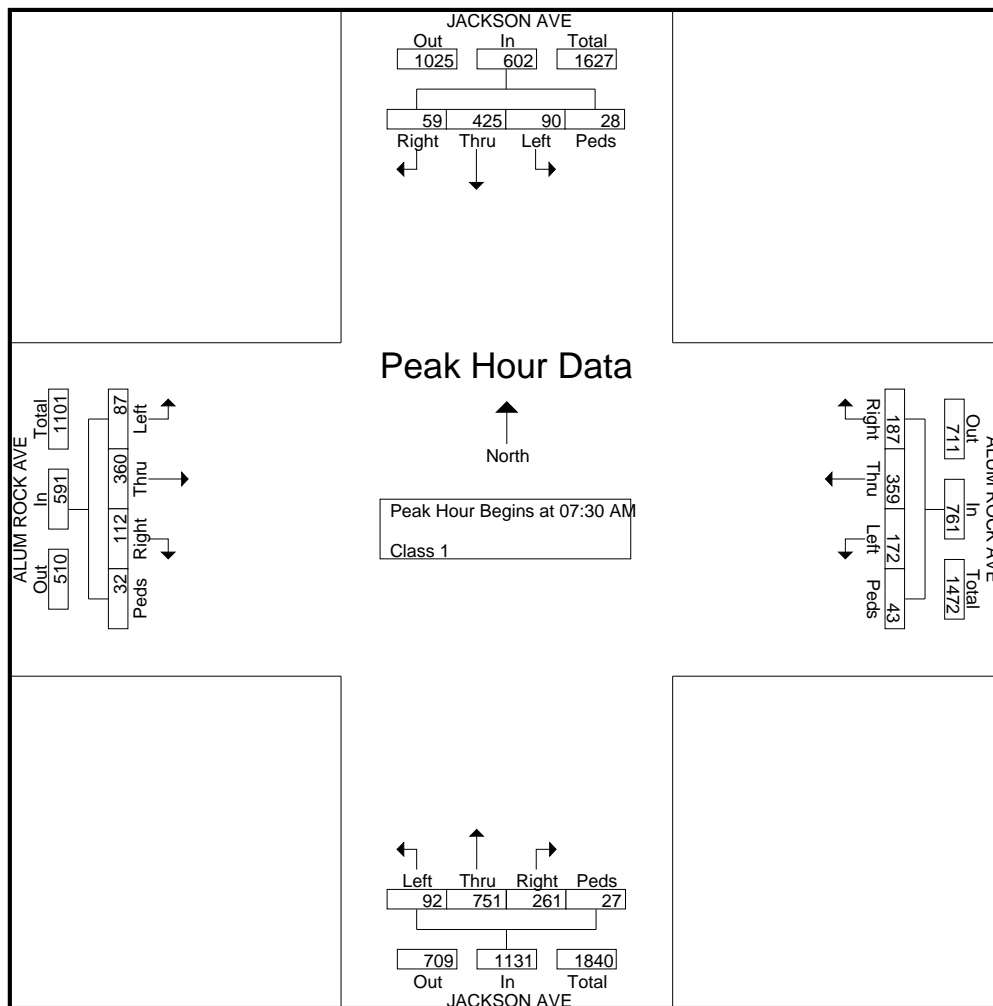

File Name : #7 I680SB&ALUMROCKAM  
 Site Code :  
 Start Date : 5/21/2015  
 Page No : 1

Groups Printed- Class 1

| Start Time  | I-680 SB RAMP Southbound |      |      |      | ALUM ROCK AVE Westbound |      |      |      | I-680 SB RAMP Northbound |      |      |      | ALUM ROCK AVE Eastbound |      |      |      | Int. Total |
|-------------|--------------------------|------|------|------|-------------------------|------|------|------|--------------------------|------|------|------|-------------------------|------|------|------|------------|
|             | Right                    | Thru | Left | Peds | Right                   | Thru | Left | Peds | Right                    | Thru | Left | Peds | Right                   | Thru | Left | Peds |            |
| 07:00 AM    | 26                       | 1    | 18   | 1    | 0                       | 89   | 3    | 0    | 5                        | 0    | 3    | 2    | 7                       | 120  | 0    | 0    | 275        |
| 07:15 AM    | 32                       | 0    | 28   | 0    | 0                       | 122  | 6    | 0    | 6                        | 0    | 9    | 1    | 7                       | 137  | 0    | 0    | 348        |
| 07:30 AM    | 43                       | 5    | 42   | 0    | 0                       | 145  | 15   | 0    | 3                        | 0    | 6    | 0    | 8                       | 180  | 0    | 0    | 447        |
| 07:45 AM    | 35                       | 1    | 42   | 0    | 0                       | 144  | 5    | 0    | 14                       | 0    | 7    | 1    | 2                       | 172  | 0    | 1    | 424        |
| Total       | 136                      | 7    | 130  | 1    | 0                       | 500  | 29   | 0    | 28                       | 0    | 25   | 4    | 24                      | 609  | 0    | 1    | 1494       |
| 08:00 AM    | 40                       | 0    | 40   | 0    | 0                       | 170  | 4    | 0    | 1                        | 0    | 12   | 1    | 3                       | 180  | 0    | 0    | 451        |
| 08:15 AM    | 33                       | 2    | 44   | 5    | 0                       | 156  | 8    | 0    | 4                        | 0    | 5    | 3    | 0                       | 172  | 0    | 0    | 432        |
| 08:30 AM    | 25                       | 1    | 33   | 0    | 0                       | 160  | 3    | 0    | 4                        | 0    | 5    | 3    | 4                       | 130  | 0    | 0    | 368        |
| 08:45 AM    | 27                       | 0    | 38   | 3    | 0                       | 129  | 4    | 0    | 2                        | 0    | 5    | 2    | 3                       | 125  | 0    | 0    | 338        |
| Total       | 125                      | 3    | 155  | 8    | 0                       | 615  | 19   | 0    | 11                       | 0    | 27   | 9    | 10                      | 607  | 0    | 0    | 1589       |
| Grand Total | 261                      | 10   | 285  | 9    | 0                       | 1115 | 48   | 0    | 39                       | 0    | 52   | 13   | 34                      | 1216 | 0    | 1    | 3083       |
| Apprch %    | 46.2                     | 1.8  | 50.4 | 1.6  | 0                       | 95.9 | 4.1  | 0    | 37.5                     | 0    | 50   | 12.5 | 2.7                     | 97.2 | 0    | 0.1  |            |
| Total %     | 8.5                      | 0.3  | 9.2  | 0.3  | 0                       | 36.2 | 1.6  | 0    | 1.3                      | 0    | 1.7  | 0.4  | 1.1                     | 39.4 | 0    | 0    |            |

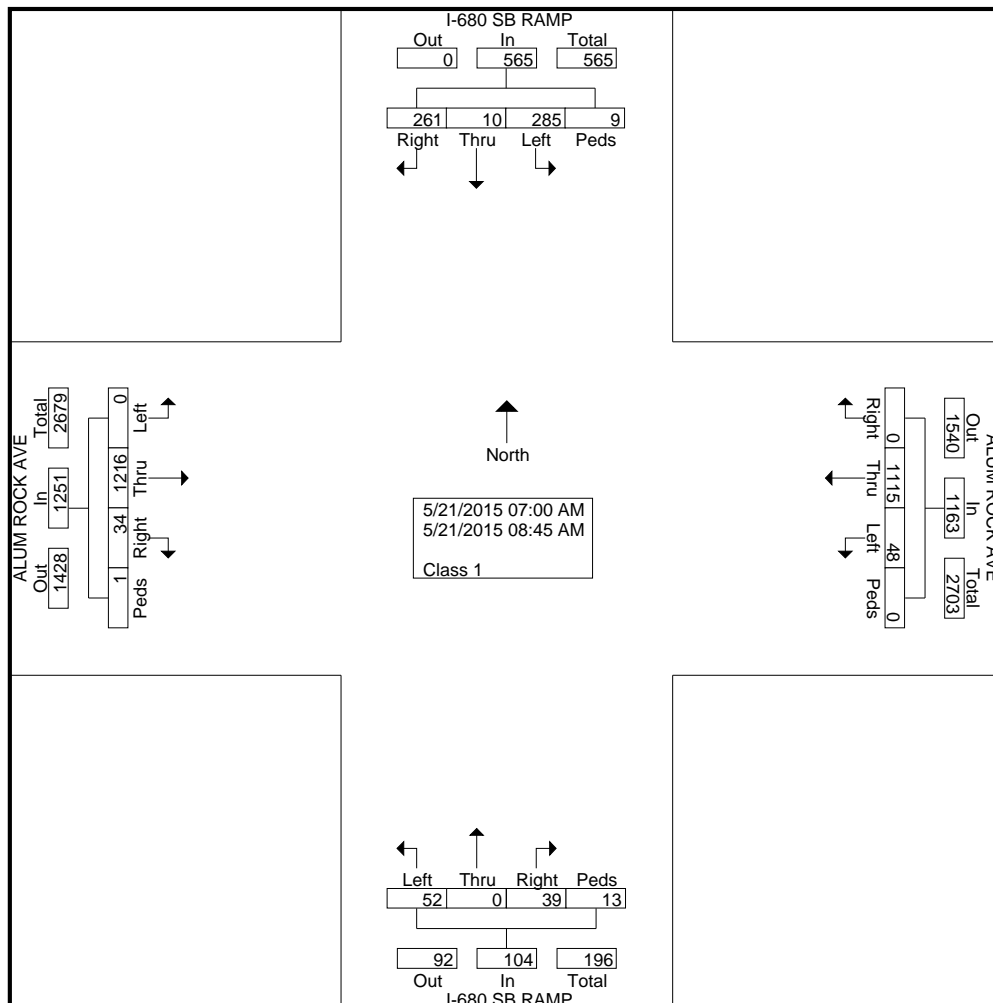

| Start Time  | I-680 SB RAMP Southbound |      |      |      |            | ALUM ROCK AVE Westbound |      |      |      |            | I-680 SB RAMP Northbound |      |      |      |            | ALUM ROCK AVE Eastbound |      |      |      |            | Int. Total |
|---|--------------------------|------|------|------|------------|-------------------------|------|------|------|------------|--------------------------|------|------|------|------------|-------------------------|------|------|------|------------|------------|
|   | Right                    | Thru | Left | Peds | App. Total | Right                   | Thru | Left | Peds | App. Total | Right                    | Thru | Left | Peds | App. Total | Right                   | Thru | Left | Peds | App. Total |            |
| <b>Peak Hour Analysis From 07:00 AM to 08:45 AM - Peak 1 of 1</b> |                          |      |      |      |            |                         |      |      |      |            |                          |      |      |      |            |                         |      |      |      |            |            |
| Peak Hour for Entire Intersection Begins at 07:30 AM              |                          |      |      |      |            |                         |      |      |      |            |                          |      |      |      |            |                         |      |      |      |            |            |
| 07:30 AM  | 43                       | 5    | 42   | 0    | 90         | 0                       | 145  | 15   | 0    | 160        | 3                        | 0    | 6    | 0    | 9          | 8                       | 180  | 0    | 0    | 188        | 447        |
| 07:45 AM  | 35                       | 1    | 42   | 0    | 78         | 0                       | 144  | 5    | 0    | 149        | 14                       | 0    | 7    | 1    | 22         | 2                       | 172  | 0    | 1    | 175        | 424        |
| 08:00 AM  | 40                       | 0    | 40   | 0    | 80         | 0                       | 170  | 4    | 0    | 174        | 1                        | 0    | 12   | 1    | 14         | 3                       | 180  | 0    | 0    | 183        | 451        |
| 08:15 AM  | 33                       | 2    | 44   | 5    | 84         | 0                       | 156  | 8    | 0    | 164        | 4                        | 0    | 5    | 3    | 12         | 0                       | 172  | 0    | 0    | 172        | 432        |
| Total Volume  | 151                      | 8    | 168  | 5    | 332        | 0                       | 615  | 32   | 0    | 647        | 22                       | 0    | 30   | 5    | 57         | 13                      | 704  | 0    | 1    | 718        | 1754       |
| % App. Total  | 45.5                     | 2.4  | 50.6 | 1.5  |            | 0                       | 95.1 | 4.9  | 0    |            | 38.6                     | 0    | 52.6 | 8.8  |            | 1.8                     | 98.1 | 0    | 0.1  |            |            |
| PHF   | .878                     | .400 | .955 | .250 | .922       | .000                    | .904 | .533 | .000 | .930       | .393                     | .000 | .625 | .417 | .648       | .406                    | .978 | .000 | .250 | .955       | .972       |

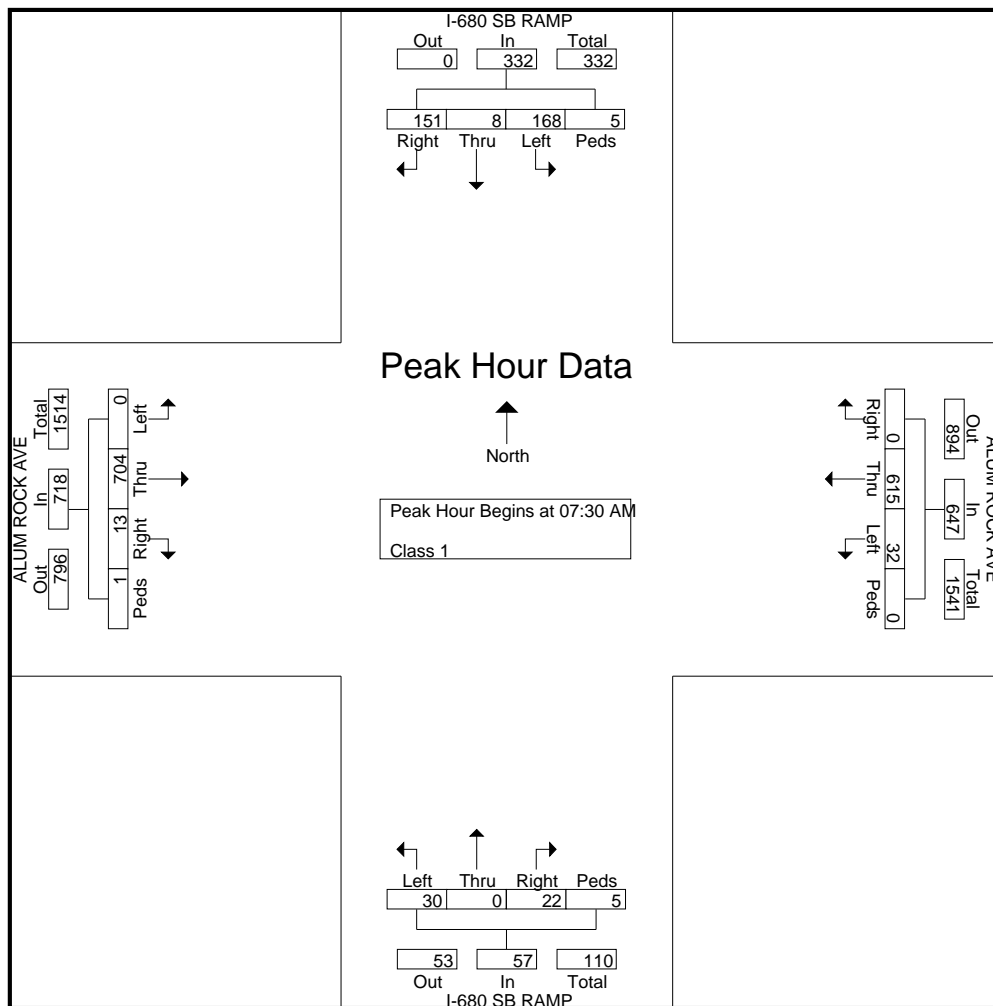



File Name : #8 I680NB&ALUMROCKAM  
 Site Code :  
 Start Date : 5/21/2015  
 Page No : 1

Groups Printed- Class 1

| Start Time  | I-680 NB RAMP Southbound |      |      |      | ALUM ROCK AVE Westbound |      |      |      | I-680 NB RAMP Northbound |      |      |      | ALUM ROCK AVE Eastbound |      |      |      | Int. Total |
|-------------|--------------------------|------|------|------|-------------------------|------|------|------|--------------------------|------|------|------|-------------------------|------|------|------|------------|
|             | Right                    | Thru | Left | Peds | Right                   | Thru | Left | Peds | Right                    | Thru | Left | Peds | Right                   | Thru | Left | Peds |            |
| 07:00 AM    | 0                        | 0    | 0    | 0    | 139                     | 386  | 0    | 0    | 98                       | 11   | 15   | 1    | 78                      | 75   | 0    | 0    | 803        |
| 07:15 AM    | 0                        | 0    | 0    | 0    | 189                     | 374  | 0    | 0    | 119                      | 29   | 30   | 0    | 91                      | 74   | 0    | 0    | 906        |
| 07:30 AM    | 0                        | 0    | 0    | 0    | 192                     | 426  | 0    | 0    | 158                      | 32   | 49   | 0    | 96                      | 135  | 0    | 0    | 1088       |
| 07:45 AM    | 0                        | 0    | 0    | 0    | 154                     | 361  | 0    | 0    | 150                      | 45   | 43   | 0    | 96                      | 139  | 0    | 0    | 988        |
| Total       | 0                        | 0    | 0    | 0    | 674                     | 1547 | 0    | 0    | 525                      | 117  | 137  | 1    | 361                     | 423  | 0    | 0    | 3785       |
| 08:00 AM    | 0                        | 0    | 0    | 0    | 176                     | 353  | 0    | 0    | 158                      | 49   | 54   | 4    | 76                      | 132  | 0    | 0    | 1002       |
| 08:15 AM    | 0                        | 0    | 0    | 6    | 141                     | 318  | 0    | 0    | 125                      | 45   | 45   | 3    | 67                      | 157  | 0    | 0    | 907        |
| 08:30 AM    | 0                        | 0    | 0    | 0    | 127                     | 316  | 0    | 0    | 137                      | 47   | 47   | 3    | 60                      | 100  | 0    | 0    | 837        |
| 08:45 AM    | 0                        | 0    | 0    | 3    | 110                     | 260  | 0    | 0    | 138                      | 46   | 46   | 5    | 47                      | 125  | 0    | 0    | 780        |
| Total       | 0                        | 0    | 0    | 9    | 554                     | 1247 | 0    | 0    | 558                      | 187  | 192  | 15   | 250                     | 514  | 0    | 0    | 3526       |
| Grand Total | 0                        | 0    | 0    | 9    | 1228                    | 2794 | 0    | 0    | 1083                     | 304  | 329  | 16   | 611                     | 937  | 0    | 0    | 7311       |
| Apprch %    | 0                        | 0    | 0    | 100  | 30.5                    | 69.5 | 0    | 0    | 62.5                     | 17.6 | 19   | 0.9  | 39.5                    | 60.5 | 0    | 0    |            |
| Total %     | 0                        | 0    | 0    | 0.1  | 16.8                    | 38.2 | 0    | 0    | 14.8                     | 4.2  | 4.5  | 0.2  | 8.4                     | 12.8 | 0    | 0    |            |

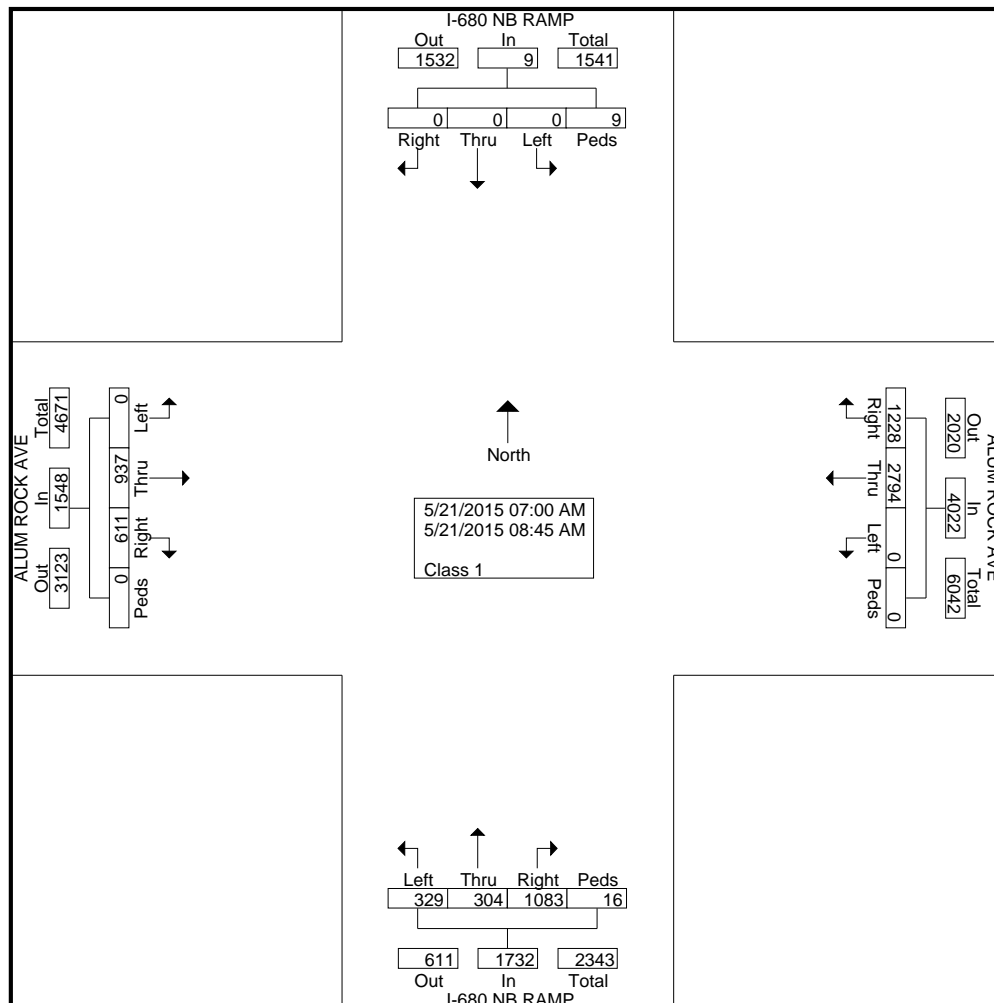

| Start Time  | I-680 NB RAMP Southbound |      |      |      |            | ALUM ROCK AVE Westbound |      |      |      |            | I-680 NB RAMP Northbound |      |      |      |            | ALUM ROCK AVE Eastbound |      |      |      |            | Int. Total |
|---|--------------------------|------|------|------|------------|-------------------------|------|------|------|------------|--------------------------|------|------|------|------------|-------------------------|------|------|------|------------|------------|
|   | Right                    | Thru | Left | Peds | App. Total | Right                   | Thru | Left | Peds | App. Total | Right                    | Thru | Left | Peds | App. Total | Right                   | Thru | Left | Peds | App. Total |            |
| <b>Peak Hour Analysis From 07:00 AM to 08:45 AM - Peak 1 of 1</b> |                          |      |      |      |            |                         |      |      |      |            |                          |      |      |      |            |                         |      |      |      |            |            |
| Peak Hour for Entire Intersection Begins at 07:30 AM              |                          |      |      |      |            |                         |      |      |      |            |                          |      |      |      |            |                         |      |      |      |            |            |
| 07:30 AM  | 0                        | 0    | 0    | 0    | 0          | 192                     | 426  | 0    | 0    | 618        | 158                      | 32   | 49   | 0    | 239        | 96                      | 135  | 0    | 0    | 231        | 1088       |
| 07:45 AM  | 0                        | 0    | 0    | 0    | 0          | 154                     | 361  | 0    | 0    | 515        | 150                      | 45   | 43   | 0    | 238        | 96                      | 139  | 0    | 0    | 235        | 988        |
| 08:00 AM  | 0                        | 0    | 0    | 0    | 0          | 176                     | 353  | 0    | 0    | 529        | 158                      | 49   | 54   | 4    | 265        | 76                      | 132  | 0    | 0    | 208        | 1002       |
| 08:15 AM  | 0                        | 0    | 0    | 6    | 6          | 141                     | 318  | 0    | 0    | 459        | 125                      | 45   | 45   | 3    | 218        | 67                      | 157  | 0    | 0    | 224        | 907        |
| Total Volume  | 0                        | 0    | 0    | 6    | 6          | 663                     | 1458 | 0    | 0    | 2121       | 591                      | 171  | 191  | 7    | 960        | 335                     | 563  | 0    | 0    | 898        | 3985       |
| % App. Total  | 0                        | 0    | 0    | 100  |            | 31.3                    | 68.7 | 0    | 0    |            | 61.6                     | 17.8 | 19.9 | 0.7  |            | 37.3                    | 62.7 | 0    | 0    |            |            |
| PHF   | .000                     | .000 | .000 | .250 | .250       | .863                    | .856 | .000 | .000 | .858       | .935                     | .872 | .884 | .438 | .906       | .872                    | .896 | .000 | .000 | .955       | .916       |

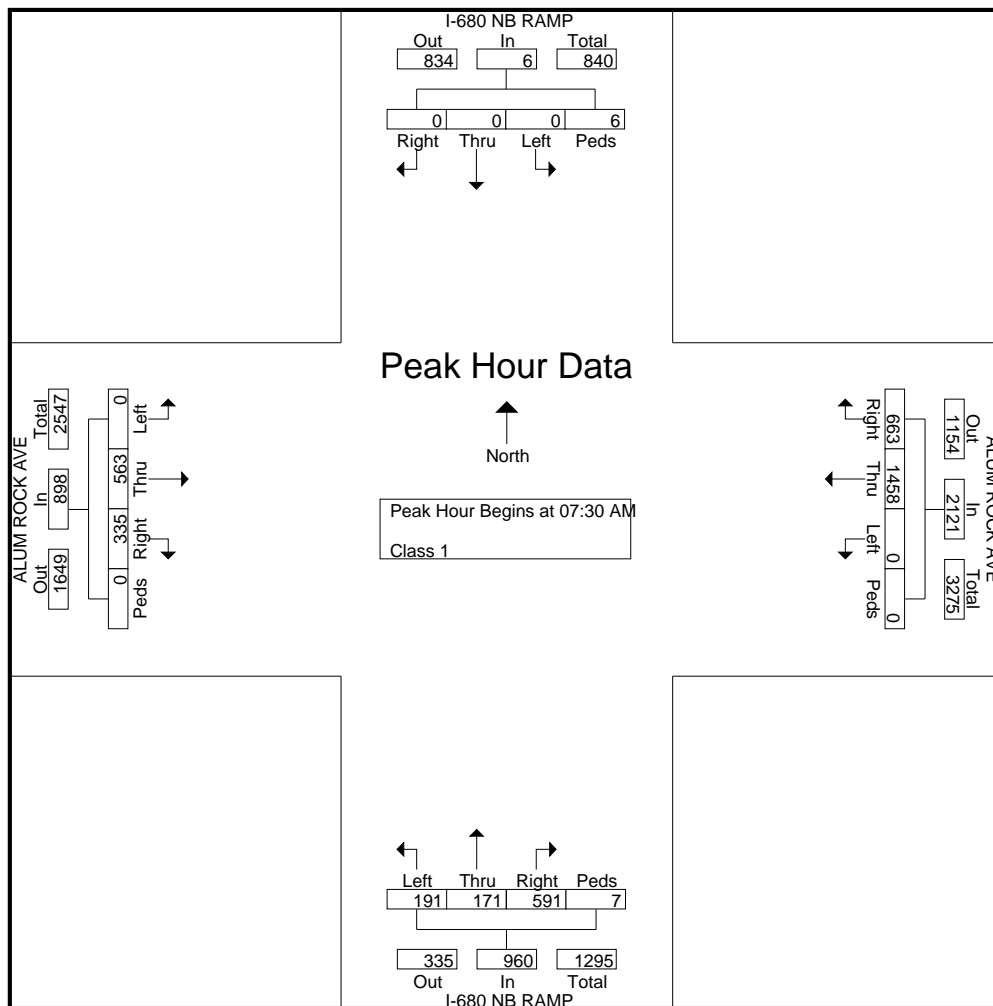

File Name : #9 LEIGH&SAN CARLOSPM  
 Site Code :  
 Start Date : 5/20/2015  
 Page No : 1

Groups Printed- Class 1

| Start Time  | SHASTA AVE Southbound |      |      |      | SAN CARLOS ST Westbound |      |      |      | LEIGH AVE Northbound |      |      |      | SAN CARLOS ST Eastbound |      |      |      | Int. Total |
|-------------|-----------------------|------|------|------|-------------------------|------|------|------|----------------------|------|------|------|-------------------------|------|------|------|------------|
|             | Right                 | Thru | Left | Peds | Right                   | Thru | Left | Peds | Right                | Thru | Left | Peds | Right                   | Thru | Left | Peds |            |
| 04:00 PM    | 8                     | 22   | 16   | 5    | 6                       | 118  | 15   | 4    | 23                   | 44   | 17   | 1    | 18                      | 191  | 19   | 3    | 510        |
| 04:15 PM    | 15                    | 20   | 5    | 9    | 1                       | 144  | 11   | 1    | 19                   | 19   | 19   | 11   | 9                       | 243  | 13   | 1    | 540        |
| 04:30 PM    | 7                     | 20   | 7    | 2    | 5                       | 140  | 15   | 2    | 9                    | 26   | 21   | 8    | 10                      | 253  | 17   | 5    | 547        |
| 04:45 PM    | 10                    | 27   | 17   | 1    | 5                       | 129  | 19   | 3    | 23                   | 36   | 21   | 12   | 8                       | 257  | 14   | 10   | 592        |
| Total       | 40                    | 89   | 45   | 17   | 17                      | 531  | 60   | 10   | 74                   | 125  | 78   | 32   | 45                      | 944  | 63   | 19   | 2189       |
| 05:00 PM    | 6                     | 30   | 14   | 5    | 7                       | 137  | 11   | 2    | 21                   | 27   | 24   | 8    | 19                      | 293  | 12   | 4    | 620        |
| 05:15 PM    | 15                    | 18   | 14   | 1    | 4                       | 134  | 11   | 1    | 22                   | 28   | 20   | 6    | 11                      | 297  | 17   | 5    | 604        |
| 05:30 PM    | 13                    | 34   | 7    | 1    | 4                       | 157  | 14   | 2    | 22                   | 42   | 24   | 5    | 17                      | 264  | 17   | 4    | 627        |
| 05:45 PM    | 14                    | 29   | 14   | 15   | 2                       | 124  | 18   | 3    | 15                   | 27   | 32   | 5    | 13                      | 284  | 16   | 5    | 616        |
| Total       | 48                    | 111  | 49   | 22   | 17                      | 552  | 54   | 8    | 80                   | 124  | 100  | 24   | 60                      | 1138 | 62   | 18   | 2467       |
| Grand Total | 88                    | 200  | 94   | 39   | 34                      | 1083 | 114  | 18   | 154                  | 249  | 178  | 56   | 105                     | 2082 | 125  | 37   | 4656       |
| Apprch %    | 20.9                  | 47.5 | 22.3 | 9.3  | 2.7                     | 86.7 | 9.1  | 1.4  | 24.2                 | 39.1 | 27.9 | 8.8  | 4.5                     | 88.6 | 5.3  | 1.6  |            |
| Total %     | 1.9                   | 4.3  | 2    | 0.8  | 0.7                     | 23.3 | 2.4  | 0.4  | 3.3                  | 5.3  | 3.8  | 1.2  | 2.3                     | 44.7 | 2.7  | 0.8  |            |

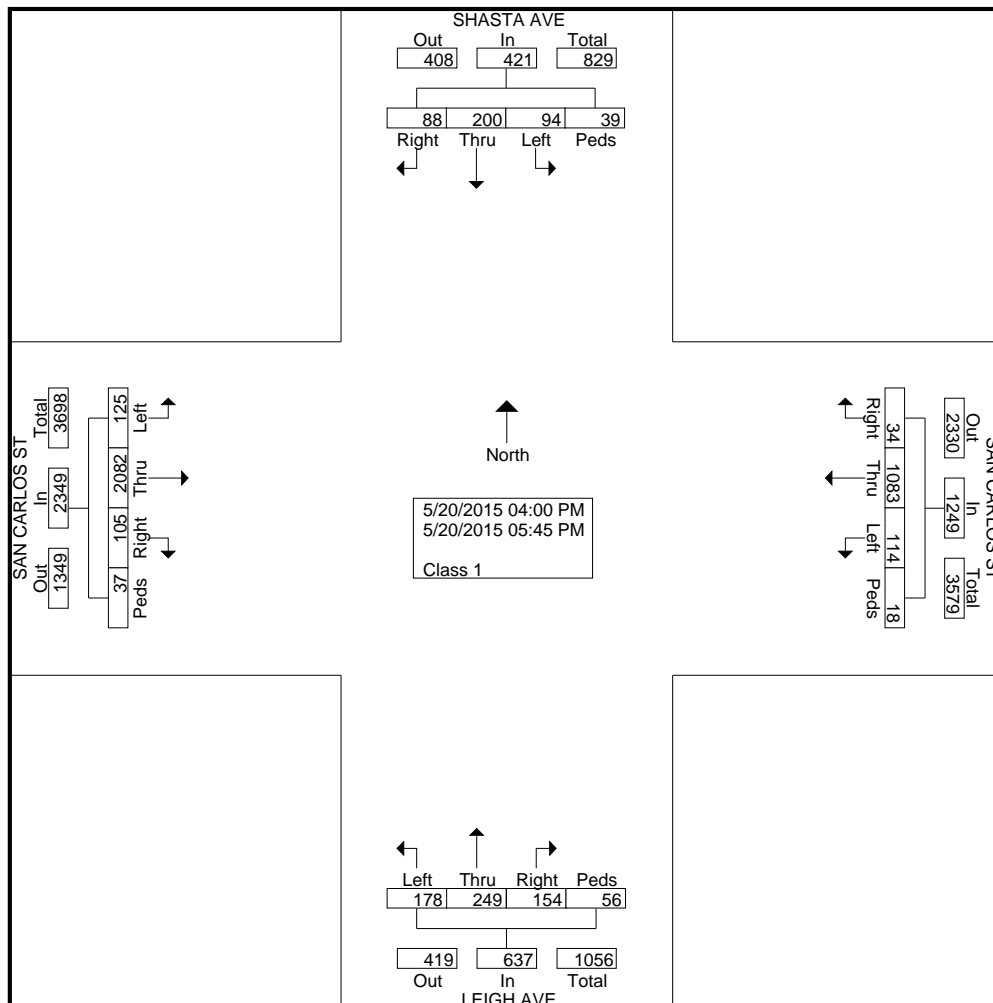

| Start Time  | SHASTA AVE Southbound |      |      |      |            | SAN CARLOS ST Westbound |      |      |      |            | LEIGH AVE Northbound |      |      |      |            | SAN CARLOS ST Eastbound |      |      |      |            | Int. Total |
|---|-----------------------|------|------|------|------------|-------------------------|------|------|------|------------|----------------------|------|------|------|------------|-------------------------|------|------|------|------------|------------|
|   | Right                 | Thru | Left | Peds | App. Total | Right                   | Thru | Left | Peds | App. Total | Right                | Thru | Left | Peds | App. Total | Right                   | Thru | Left | Peds | App. Total |            |
| <b>Peak Hour Analysis From 04:00 PM to 05:45 PM - Peak 1 of 1</b> |                       |      |      |      |            |                         |      |      |      |            |                      |      |      |      |            |                         |      |      |      |            |            |
| Peak Hour for Entire Intersection Begins at 05:00 PM              |                       |      |      |      |            |                         |      |      |      |            |                      |      |      |      |            |                         |      |      |      |            |            |
| 05:00 PM  | 6                     | 30   | 14   | 5    | 55         | 7                       | 137  | 11   | 2    | 157        | 21                   | 27   | 24   | 8    | 80         | 19                      | 293  | 12   | 4    | 328        | 620        |
| 05:15 PM  | 15                    | 18   | 14   | 1    | 48         | 4                       | 134  | 11   | 1    | 150        | 22                   | 28   | 20   | 6    | 76         | 11                      | 297  | 17   | 5    | 330        | 604        |
| 05:30 PM  | 13                    | 34   | 7    | 1    | 55         | 4                       | 157  | 14   | 2    | 177        | 22                   | 42   | 24   | 5    | 93         | 17                      | 264  | 17   | 4    | 302        | 627        |
| 05:45 PM  | 14                    | 29   | 14   | 15   | 72         | 2                       | 124  | 18   | 3    | 147        | 15                   | 27   | 32   | 5    | 79         | 13                      | 284  | 16   | 5    | 318        | 616        |
| Total Volume  | 48                    | 111  | 49   | 22   | 230        | 17                      | 552  | 54   | 8    | 631        | 80                   | 124  | 100  | 24   | 328        | 60                      | 1138 | 62   | 18   | 1278       | 2467       |
| % App. Total  | 20.9                  | 48.3 | 21.3 | 9.6  |            | 2.7                     | 87.5 | 8.6  | 1.3  |            | 24.4                 | 37.8 | 30.5 | 7.3  |            | 4.7                     | 89   | 4.9  | 1.4  |            |            |
| PHF   | .800                  | .816 | .875 | .367 | .799       | .607                    | .879 | .750 | .667 | .891       | .909                 | .738 | .781 | .750 | .882       | .789                    | .958 | .912 | .900 | .968       | .984       |

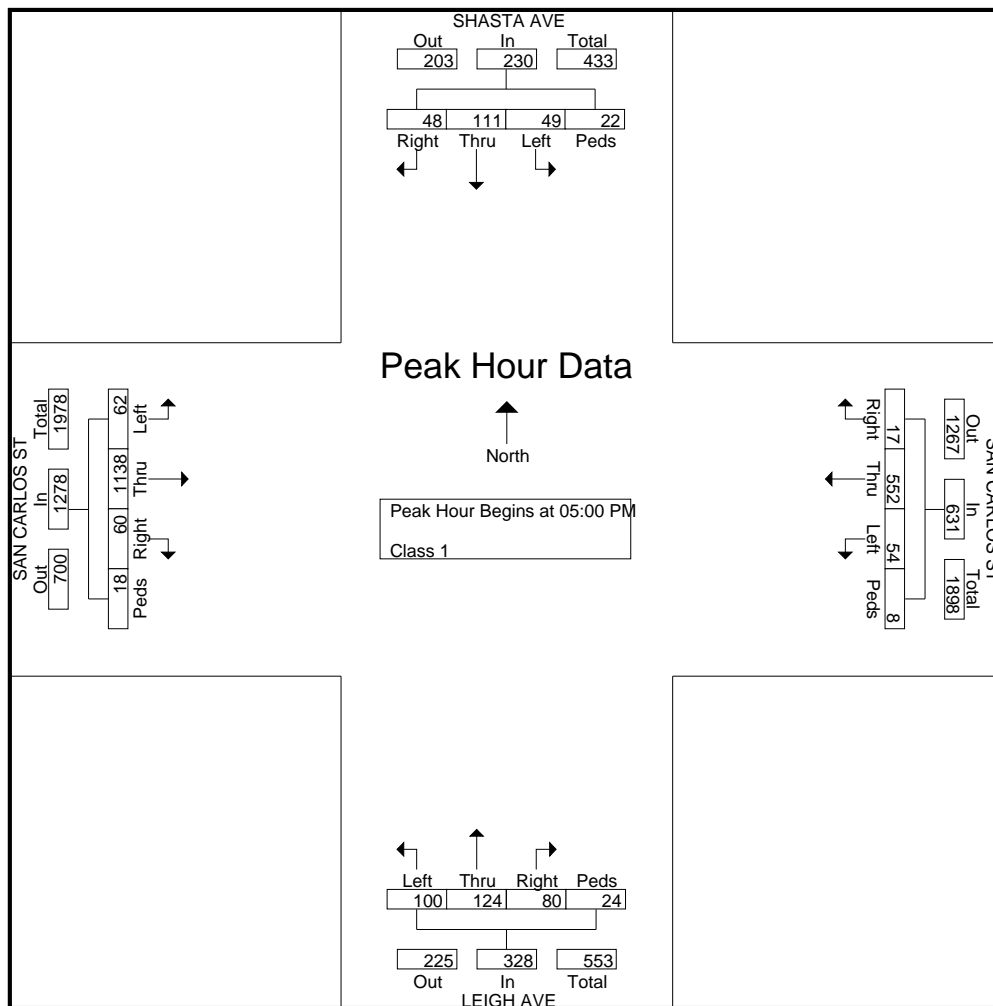

File Name : #9 LEIGH&SAN CARLOS AM  
 Site Code :  
 Start Date : 5/21/2015  
 Page No : 1

Groups Printed- Class 1

| Start Time  | SHASTA AVE Southbound |      |      |      | SAN CARLOS ST Westbound |      |      |      | LEIGH AVE Northbound |      |      |      | SAN CARLOS ST Eastbound |      |      |      | Int. Total |
|-------------|-----------------------|------|------|------|-------------------------|------|------|------|----------------------|------|------|------|-------------------------|------|------|------|------------|
|             | Right                 | Thru | Left | Peds | Right                   | Thru | Left | Peds | Right                | Thru | Left | Peds | Right                   | Thru | Left | Peds |            |
| 07:00 AM    | 6                     | 15   | 4    | 1    | 1                       | 159  | 6    | 0    | 6                    | 22   | 22   | 3    | 0                       | 48   | 3    | 1    | 297        |
| 07:15 AM    | 3                     | 39   | 18   | 5    | 3                       | 262  | 5    | 1    | 4                    | 30   | 34   | 4    | 1                       | 60   | 3    | 4    | 476        |
| 07:30 AM    | 18                    | 56   | 20   | 15   | 1                       | 328  | 6    | 6    | 5                    | 28   | 62   | 9    | 7                       | 64   | 9    | 7    | 641        |
| 07:45 AM    | 19                    | 31   | 19   | 18   | 2                       | 259  | 9    | 9    | 8                    | 37   | 34   | 6    | 9                       | 89   | 14   | 4    | 567        |
| Total       | 46                    | 141  | 61   | 39   | 7                       | 1008 | 26   | 16   | 23                   | 117  | 152  | 22   | 17                      | 261  | 29   | 16   | 1981       |
| 08:00 AM    | 10                    | 34   | 13   | 5    | 2                       | 267  | 12   | 3    | 6                    | 38   | 42   | 7    | 6                       | 100  | 9    | 3    | 557        |
| 08:15 AM    | 16                    | 43   | 8    | 1    | 4                       | 214  | 5    | 1    | 8                    | 41   | 22   | 4    | 6                       | 81   | 9    | 1    | 464        |
| 08:30 AM    | 9                     | 26   | 16   | 2    | 1                       | 220  | 6    | 3    | 15                   | 34   | 33   | 2    | 2                       | 94   | 12   | 2    | 477        |
| 08:45 AM    | 12                    | 12   | 5    | 1    | 3                       | 202  | 13   | 1    | 7                    | 23   | 28   | 2    | 4                       | 103  | 10   | 0    | 426        |
| Total       | 47                    | 115  | 42   | 9    | 10                      | 903  | 36   | 8    | 36                   | 136  | 125  | 15   | 18                      | 378  | 40   | 6    | 1924       |
| Grand Total | 93                    | 256  | 103  | 48   | 17                      | 1911 | 62   | 24   | 59                   | 253  | 277  | 37   | 35                      | 639  | 69   | 22   | 3905       |
| Apprch %    | 18.6                  | 51.2 | 20.6 | 9.6  | 0.8                     | 94.9 | 3.1  | 1.2  | 9.4                  | 40.4 | 44.2 | 5.9  | 4.6                     | 83.5 | 9    | 2.9  |            |
| Total %     | 2.4                   | 6.6  | 2.6  | 1.2  | 0.4                     | 48.9 | 1.6  | 0.6  | 1.5                  | 6.5  | 7.1  | 0.9  | 0.9                     | 16.4 | 1.8  | 0.6  |            |

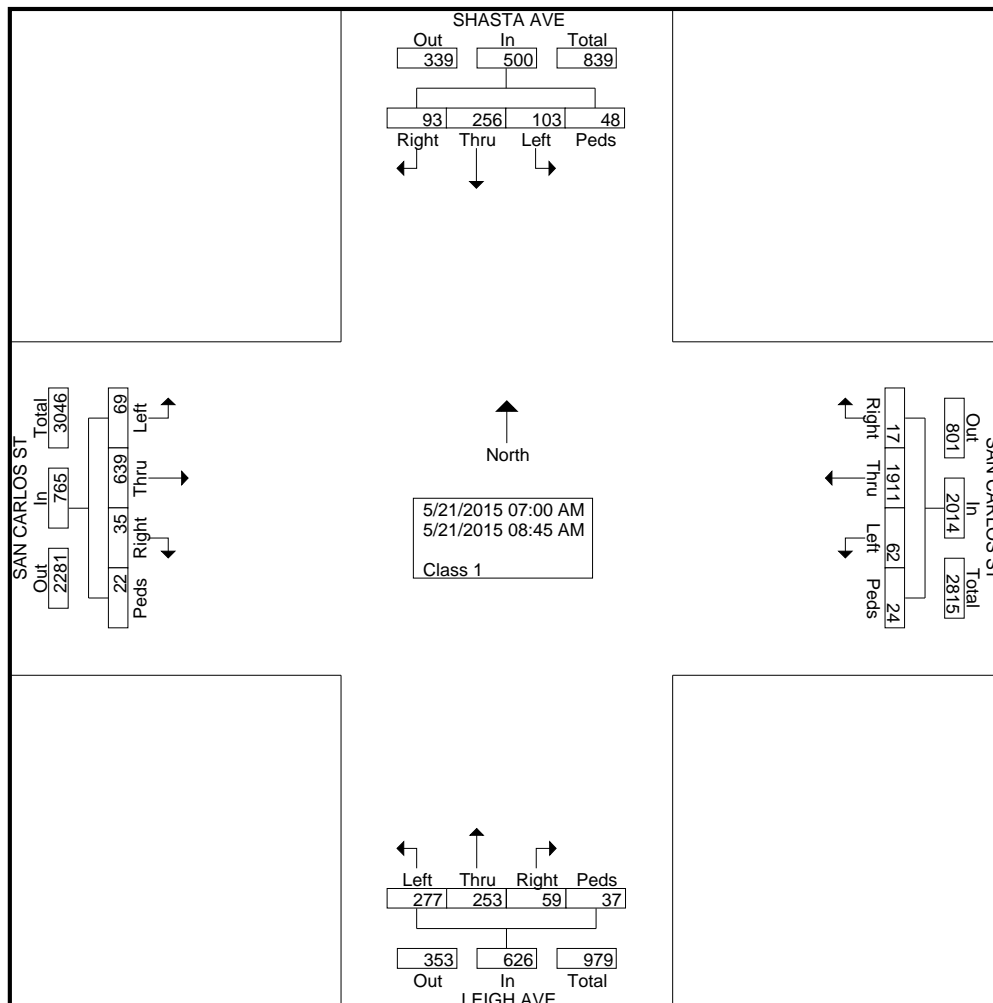

| Start Time  | SHASTA AVE Southbound |      |      |      |            | SAN CARLOS ST Westbound |      |      |      |            | LEIGH AVE Northbound |      |      |      |            | SAN CARLOS ST Eastbound |      |      |      |            | Int. Total |
|---|-----------------------|------|------|------|------------|-------------------------|------|------|------|------------|----------------------|------|------|------|------------|-------------------------|------|------|------|------------|------------|
|   | Right                 | Thru | Left | Peds | App. Total | Right                   | Thru | Left | Peds | App. Total | Right                | Thru | Left | Peds | App. Total | Right                   | Thru | Left | Peds | App. Total |            |
| <b>Peak Hour Analysis From 07:00 AM to 08:45 AM - Peak 1 of 1</b> |                       |      |      |      |            |                         |      |      |      |            |                      |      |      |      |            |                         |      |      |      |            |            |
| Peak Hour for Entire Intersection Begins at 07:15 AM              |                       |      |      |      |            |                         |      |      |      |            |                      |      |      |      |            |                         |      |      |      |            |            |
| 07:15 AM  | 3                     | 39   | 18   | 5    | 65         | 3                       | 262  | 5    | 1    | 271        | 4                    | 30   | 34   | 4    | 72         | 1                       | 60   | 3    | 4    | 68         | 476        |
| 07:30 AM  | 18                    | 56   | 20   | 15   | 109        | 1                       | 328  | 6    | 6    | 341        | 5                    | 28   | 62   | 9    | 104        | 7                       | 64   | 9    | 7    | 87         | 641        |
| 07:45 AM  | 19                    | 31   | 19   | 18   | 87         | 2                       | 259  | 9    | 9    | 279        | 8                    | 37   | 34   | 6    | 85         | 9                       | 89   | 14   | 4    | 116        | 567        |
| 08:00 AM  | 10                    | 34   | 13   | 5    | 62         | 2                       | 267  | 12   | 3    | 284        | 6                    | 38   | 42   | 7    | 93         | 6                       | 100  | 9    | 3    | 118        | 557        |
| Total Volume  | 50                    | 160  | 70   | 43   | 323        | 8                       | 1116 | 32   | 19   | 1175       | 23                   | 133  | 172  | 26   | 354        | 23                      | 313  | 35   | 18   | 389        | 2241       |
| % App. Total  | 15.5                  | 49.5 | 21.7 | 13.3 |            | 0.7                     | 95   | 2.7  | 1.6  |            | 6.5                  | 37.6 | 48.6 | 7.3  |            | 5.9                     | 80.5 | 9    | 4.6  |            |            |
| PHF   | .658                  | .714 | .875 | .597 | .741       | .667                    | .851 | .667 | .528 | .861       | .719                 | .875 | .694 | .722 | .851       | .639                    | .783 | .625 | .643 | .824       | .874       |

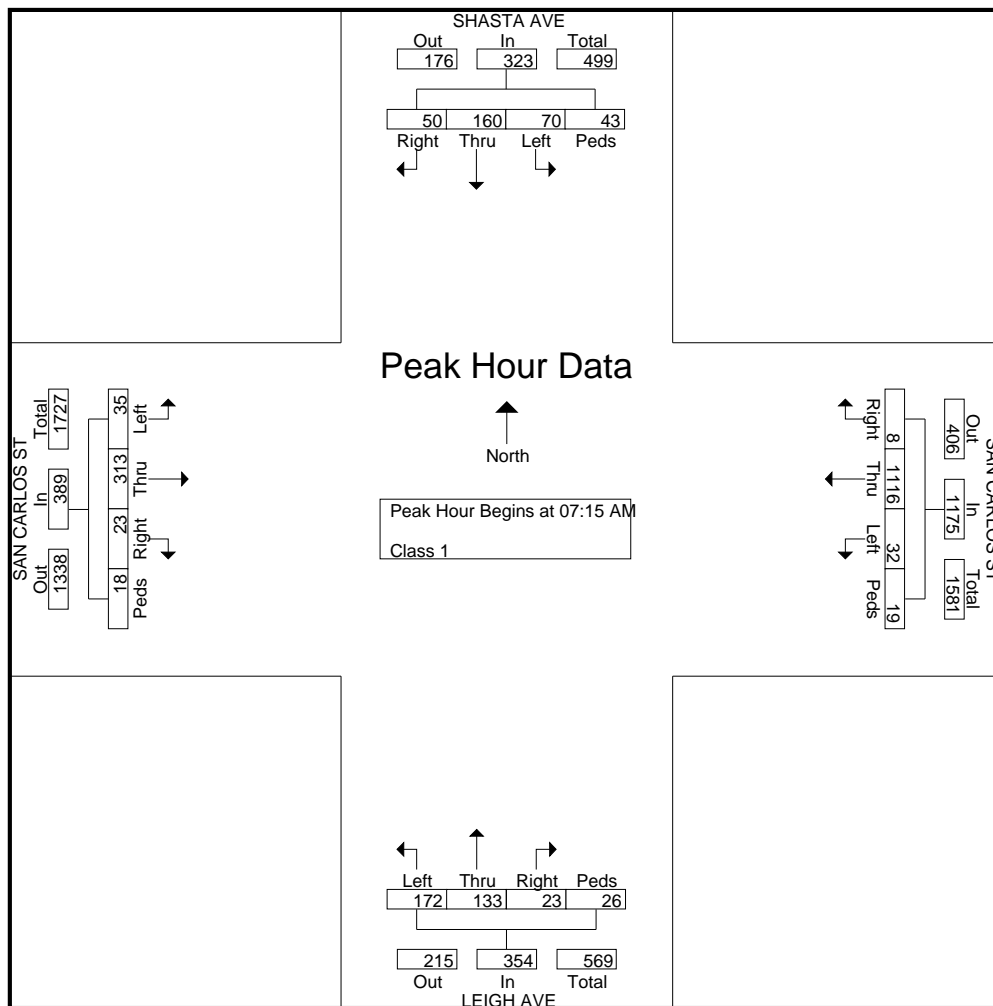

Groups Printed- Class 1

| Start Time  | DRIVEWAY Southbound |      |      |      | PARK AVE Westbound |      |      |      | MERIDIAN AVE Northbound |      |      |      | PARK AVE Eastbound |      |      |      | Int. Total |
|-------------|---------------------|------|------|------|--------------------|------|------|------|-------------------------|------|------|------|--------------------|------|------|------|------------|
|             | Right               | Thru | Left | Peds | Right              | Thru | Left | Peds | Right                   | Thru | Left | Peds | Right              | Thru | Left | Peds |            |
| 07:00 AM    | 0                   | 0    | 0    | 1    | 0                  | 80   | 16   | 0    | 20                      | 0    | 81   | 0    | 41                 | 25   | 0    | 0    | 264        |
| 07:15 AM    | 0                   | 0    | 0    | 2    | 0                  | 130  | 15   | 0    | 39                      | 0    | 75   | 2    | 68                 | 84   | 0    | 0    | 415        |
| 07:30 AM    | 0                   | 0    | 0    | 1    | 0                  | 125  | 22   | 1    | 25                      | 0    | 100  | 0    | 81                 | 102  | 0    | 0    | 457        |
| 07:45 AM    | 0                   | 0    | 0    | 4    | 0                  | 112  | 17   | 0    | 36                      | 0    | 102  | 2    | 73                 | 64   | 0    | 0    | 410        |
| Total       | 0                   | 0    | 0    | 8    | 0                  | 447  | 70   | 1    | 120                     | 0    | 358  | 4    | 263                | 275  | 0    | 0    | 1546       |
| 08:00 AM    | 0                   | 0    | 0    | 0    | 0                  | 107  | 16   | 1    | 39                      | 0    | 130  | 0    | 78                 | 55   | 0    | 0    | 426        |
| 08:15 AM    | 0                   | 0    | 0    | 1    | 0                  | 90   | 7    | 2    | 41                      | 0    | 110  | 1    | 59                 | 74   | 0    | 0    | 385        |
| 08:30 AM    | 0                   | 0    | 0    | 0    | 0                  | 71   | 27   | 2    | 36                      | 0    | 101  | 1    | 60                 | 63   | 0    | 0    | 361        |
| 08:45 AM    | 0                   | 0    | 0    | 3    | 0                  | 57   | 20   | 0    | 51                      | 0    | 111  | 0    | 40                 | 27   | 0    | 0    | 309        |
| Total       | 0                   | 0    | 0    | 4    | 0                  | 325  | 70   | 5    | 167                     | 0    | 452  | 2    | 237                | 219  | 0    | 0    | 1481       |
| Grand Total | 0                   | 0    | 0    | 12   | 0                  | 772  | 140  | 6    | 287                     | 0    | 810  | 6    | 500                | 494  | 0    | 0    | 3027       |
| Apprch %    | 0                   | 0    | 0    | 100  | 0                  | 84.1 | 15.3 | 0.7  | 26                      | 0    | 73.4 | 0.5  | 50.3               | 49.7 | 0    | 0    |            |
| Total %     | 0                   | 0    | 0    | 0.4  | 0                  | 25.5 | 4.6  | 0.2  | 9.5                     | 0    | 26.8 | 0.2  | 16.5               | 16.3 | 0    | 0    |            |

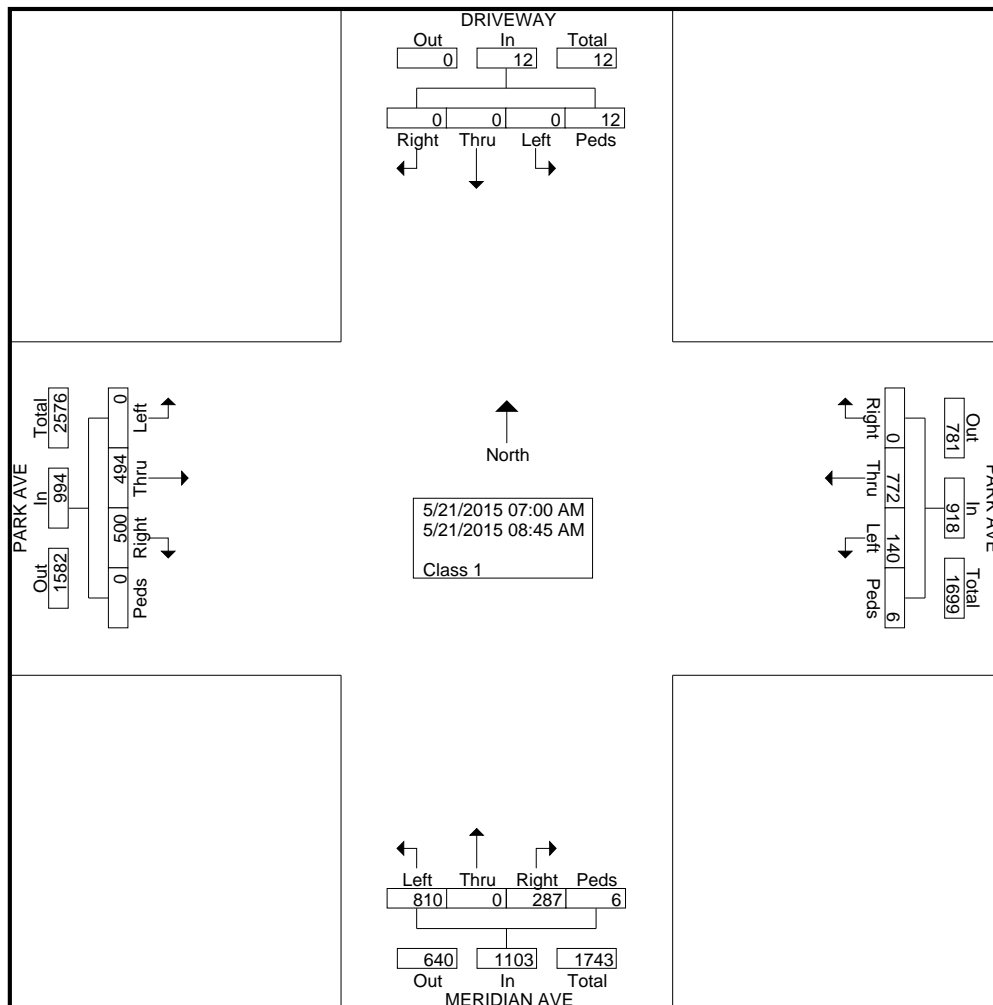



| Start Time  | DRIVEWAY Southbound |      |      |      |            | PARK AVE Westbound |      |      |      |            | MERIDIAN AVE Northbound |      |      |      |            | PARK AVE Eastbound |      |      |      |            | Int. Total |
|---|---------------------|------|------|------|------------|--------------------|------|------|------|------------|-------------------------|------|------|------|------------|--------------------|------|------|------|------------|------------|
|   | Right               | Thru | Left | Peds | App. Total | Right              | Thru | Left | Peds | App. Total | Right                   | Thru | Left | Peds | App. Total | Right              | Thru | Left | Peds | App. Total |            |
| <b>Peak Hour Analysis From 07:00 AM to 08:45 AM - Peak 1 of 1</b> |                     |      |      |      |            |                    |      |      |      |            |                         |      |      |      |            |                    |      |      |      |            |            |
| Peak Hour for Entire Intersection Begins at 07:15 AM              |                     |      |      |      |            |                    |      |      |      |            |                         |      |      |      |            |                    |      |      |      |            |            |
| 07:15 AM  | 0                   | 0    | 0    | 2    | 2          | 0                  | 130  | 15   | 0    | 145        | 39                      | 0    | 75   | 2    | 116        | 68                 | 84   | 0    | 0    | 152        | 415        |
| 07:30 AM  | 0                   | 0    | 0    | 1    | 1          | 0                  | 125  | 22   | 1    | 148        | 25                      | 0    | 100  | 0    | 125        | 81                 | 102  | 0    | 0    | 183        | 457        |
| 07:45 AM  | 0                   | 0    | 0    | 4    | 4          | 0                  | 112  | 17   | 0    | 129        | 36                      | 0    | 102  | 2    | 140        | 73                 | 64   | 0    | 0    | 137        | 410        |
| 08:00 AM  | 0                   | 0    | 0    | 0    | 0          | 0                  | 107  | 16   | 1    | 124        | 39                      | 0    | 130  | 0    | 169        | 78                 | 55   | 0    | 0    | 133        | 426        |
| Total Volume  | 0                   | 0    | 0    | 7    | 7          | 0                  | 474  | 70   | 2    | 546        | 139                     | 0    | 407  | 4    | 550        | 300                | 305  | 0    | 0    | 605        | 1708       |
| % App. Total  | 0                   | 0    | 0    | 100  |            | 0                  | 86.8 | 12.8 | 0.4  |            | 25.3                    | 0    | 74   | 0.7  |            | 49.6               | 50.4 | 0    | 0    |            |            |
| PHF   | .000                | .000 | .000 | .438 | .438       | .000               | .912 | .795 | .500 | .922       | .891                    | .000 | .783 | .500 | .814       | .926               | .748 | .000 | .000 | .827       | .934       |

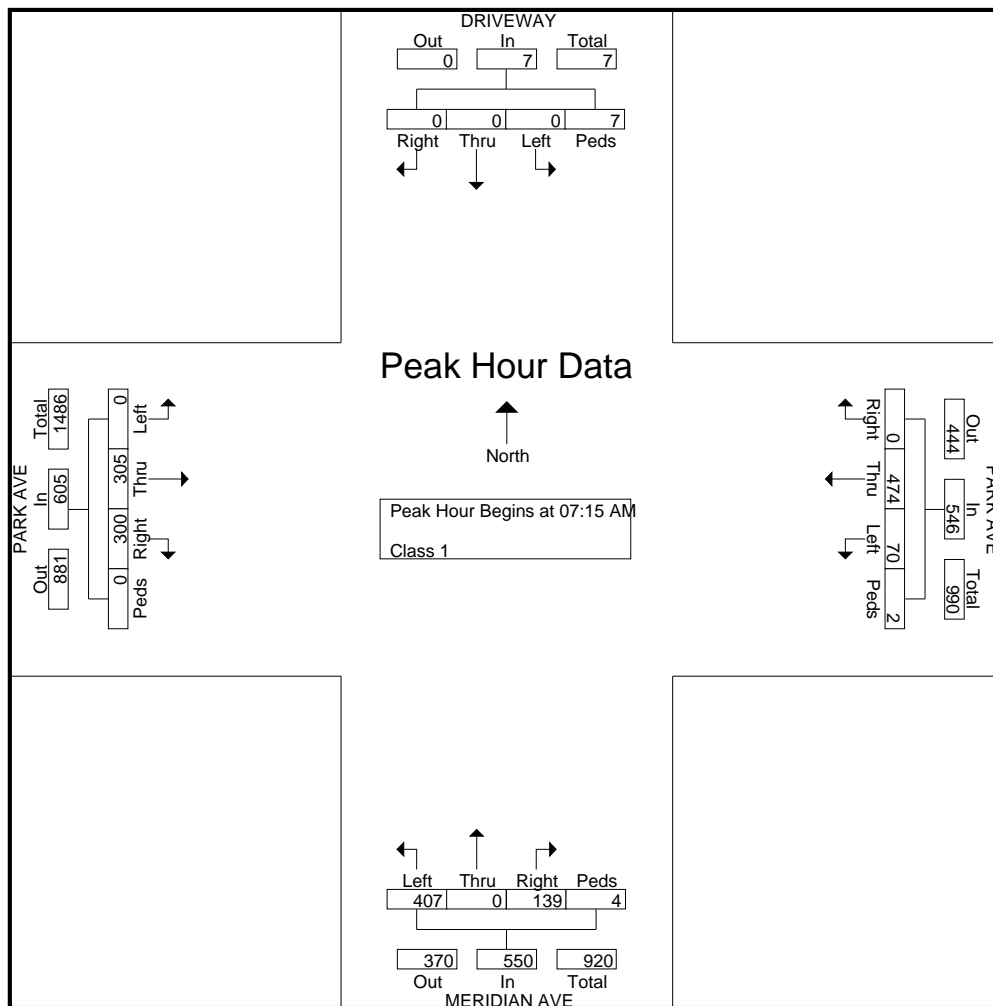

Groups Printed- Class 1

| Start Time  | DRIVEWAY Southbound |      |      |      | PARK AVE Westbound |      |      |      | MERIDIAN AVE Northbound |      |      |      | PARK AVE Eastbound |      |      |      | Int. Total |
|-------------|---------------------|------|------|------|--------------------|------|------|------|-------------------------|------|------|------|--------------------|------|------|------|------------|
|             | Right               | Thru | Left | Peds | Right              | Thru | Left | Peds | Right                   | Thru | Left | Peds | Right              | Thru | Left | Peds |            |
| 04:00 PM    | 0                   | 0    | 0    | 0    | 0                  | 45   | 30   | 0    | 27                      | 0    | 47   | 2    | 101                | 95   | 0    | 0    | 347        |
| 04:15 PM    | 0                   | 0    | 0    | 1    | 0                  | 49   | 25   | 0    | 31                      | 0    | 42   | 4    | 90                 | 79   | 0    | 0    | 323        |
| 04:30 PM    | 0                   | 0    | 0    | 1    | 0                  | 56   | 30   | 0    | 36                      | 0    | 63   | 5    | 114                | 75   | 0    | 0    | 380        |
| 04:45 PM    | 0                   | 0    | 0    | 1    | 0                  | 39   | 26   | 0    | 36                      | 0    | 49   | 1    | 131                | 91   | 0    | 0    | 374        |
| Total       | 0                   | 0    | 0    | 3    | 0                  | 189  | 111  | 2    | 130                     | 0    | 201  | 12   | 436                | 340  | 0    | 0    | 1424       |
| 05:00 PM    | 0                   | 0    | 0    | 2    | 0                  | 64   | 31   | 1    | 35                      | 0    | 42   | 0    | 134                | 103  | 0    | 0    | 412        |
| 05:15 PM    | 0                   | 0    | 0    | 2    | 0                  | 66   | 39   | 0    | 37                      | 0    | 47   | 1    | 126                | 112  | 0    | 0    | 430        |
| 05:30 PM    | 0                   | 0    | 0    | 0    | 0                  | 52   | 27   | 0    | 27                      | 0    | 52   | 2    | 130                | 112  | 0    | 0    | 402        |
| 05:45 PM    | 0                   | 0    | 0    | 2    | 0                  | 40   | 26   | 0    | 43                      | 0    | 59   | 1    | 137                | 91   | 0    | 0    | 399        |
| Total       | 0                   | 0    | 0    | 6    | 0                  | 222  | 123  | 1    | 142                     | 0    | 200  | 4    | 527                | 418  | 0    | 0    | 1643       |
| Grand Total | 0                   | 0    | 0    | 9    | 0                  | 411  | 234  | 3    | 272                     | 0    | 401  | 16   | 963                | 758  | 0    | 0    | 3067       |
| Apprch %    | 0                   | 0    | 0    | 100  | 0                  | 63.4 | 36.1 | 0.5  | 39.5                    | 0    | 58.2 | 2.3  | 56                 | 44   | 0    | 0    |            |
| Total %     | 0                   | 0    | 0    | 0.3  | 0                  | 13.4 | 7.6  | 0.1  | 8.9                     | 0    | 13.1 | 0.5  | 31.4               | 24.7 | 0    | 0    |            |

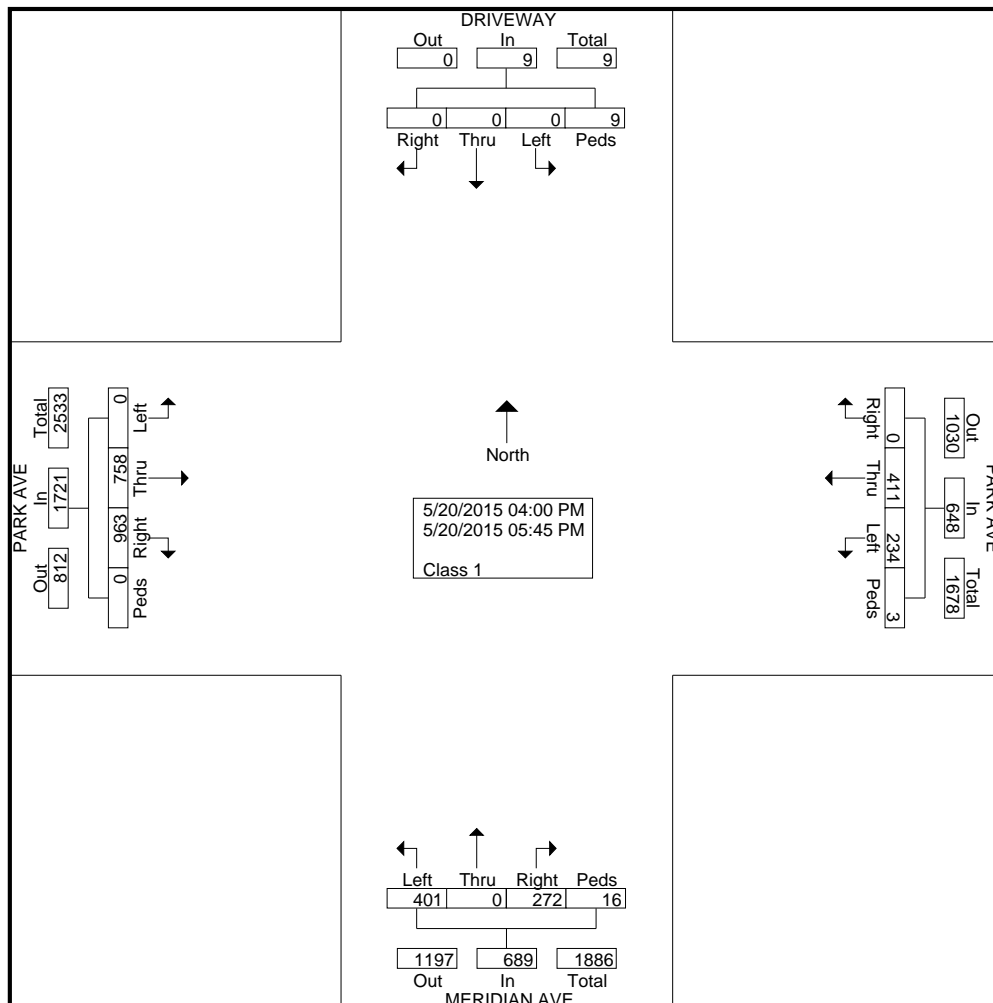

| Start Time  | DRIVEWAY Southbound |      |      |      |            | PARK AVE Westbound |      |      |      |            | MERIDIAN AVE Northbound |      |      |      |            | PARK AVE Eastbound |      |      |      |            | Int. Total |
|---|---------------------|------|------|------|------------|--------------------|------|------|------|------------|-------------------------|------|------|------|------------|--------------------|------|------|------|------------|------------|
|   | Right               | Thru | Left | Peds | App. Total | Right              | Thru | Left | Peds | App. Total | Right                   | Thru | Left | Peds | App. Total | Right              | Thru | Left | Peds | App. Total |            |
| <b>Peak Hour Analysis From 04:00 PM to 05:45 PM - Peak 1 of 1</b> |                     |      |      |      |            |                    |      |      |      |            |                         |      |      |      |            |                    |      |      |      |            |            |
| Peak Hour for Entire Intersection Begins at 05:00 PM              |                     |      |      |      |            |                    |      |      |      |            |                         |      |      |      |            |                    |      |      |      |            |            |
| 05:00 PM  | 0                   | 0    | 0    | 2    | 2          | 0                  | 64   | 31   | 1    | 96         | 35                      | 0    | 42   | 0    | 77         | 134                | 103  | 0    | 0    | 237        | 412        |
| 05:15 PM  | 0                   | 0    | 0    | 2    | 2          | 0                  | 66   | 39   | 0    | 105        | 37                      | 0    | 47   | 1    | 85         | 126                | 112  | 0    | 0    | 238        | 430        |
| 05:30 PM  | 0                   | 0    | 0    | 0    | 0          | 0                  | 52   | 27   | 0    | 79         | 27                      | 0    | 52   | 2    | 81         | 130                | 112  | 0    | 0    | 242        | 402        |
| 05:45 PM  | 0                   | 0    | 0    | 2    | 2          | 0                  | 40   | 26   | 0    | 66         | 43                      | 0    | 59   | 1    | 103        | 137                | 91   | 0    | 0    | 228        | 399        |
| Total Volume  | 0                   | 0    | 0    | 6    | 6          | 0                  | 222  | 123  | 1    | 346        | 142                     | 0    | 200  | 4    | 346        | 527                | 418  | 0    | 0    | 945        | 1643       |
| % App. Total  | 0                   | 0    | 0    | 100  |            | 0                  | 64.2 | 35.5 | 0.3  |            | 41                      | 0    | 57.8 | 1.2  |            | 55.8               | 44.2 | 0    | 0    |            |            |
| PHF   | .000                | .000 | .000 | .750 | .750       | .000               | .841 | .788 | .250 | .824       | .826                    | .000 | .847 | .500 | .840       | .962               | .933 | .000 | .000 | .976       | .955       |

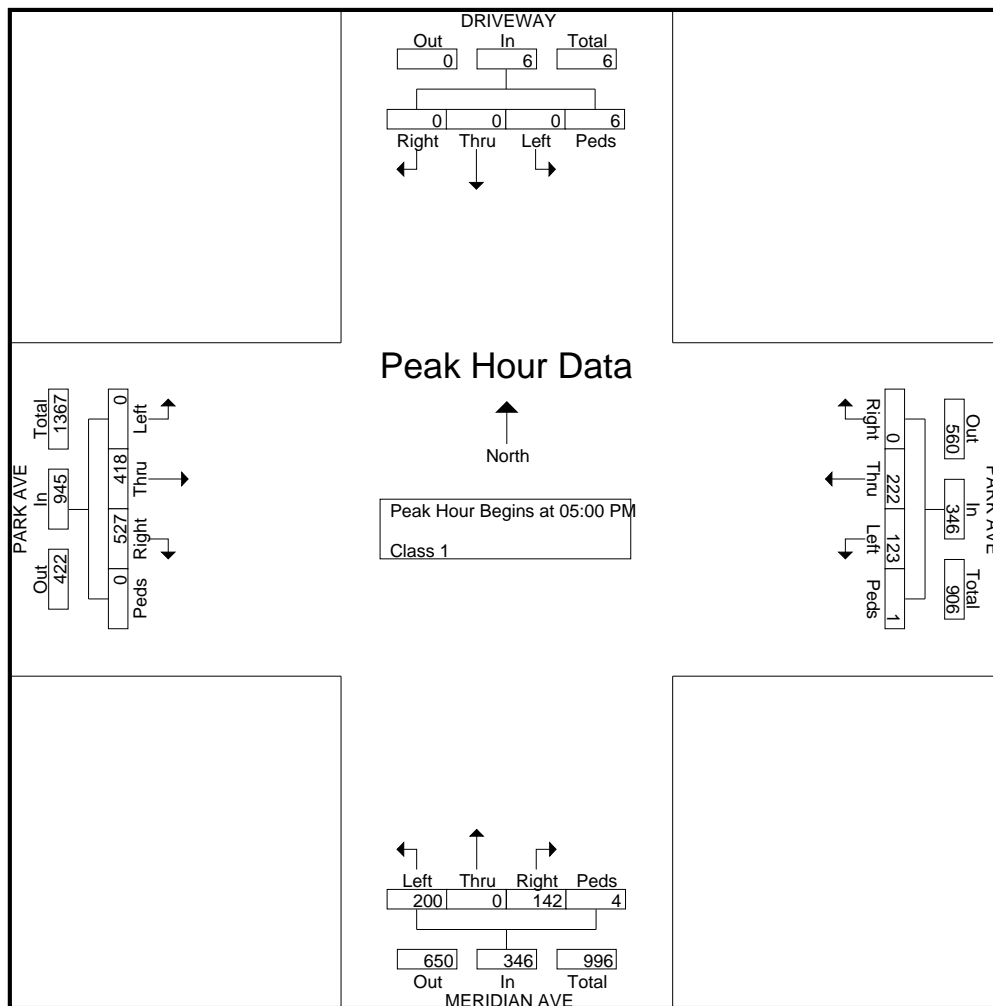

Groups Printed- Class 1

| Start Time  | RACE ST Southbound |      |      |      | PARK AVE Westbound |      |      |      | RACE ST Northbound |      |      |      | PARK AVE Eastbound |      |      |      | Int. Total |
|-------------|--------------------|------|------|------|--------------------|------|------|------|--------------------|------|------|------|--------------------|------|------|------|------------|
|             | Right              | Thru | Left | Peds | Right              | Thru | Left | Peds | Right              | Thru | Left | Peds | Right              | Thru | Left | Peds |            |
| 07:00 AM    | 3                  | 44   | 8    | 1    | 15                 | 89   | 4    | 2    | 2                  | 59   | 5    | 0    | 2                  | 33   | 12   | 2    | 281        |
| 07:15 AM    | 7                  | 63   | 3    | 3    | 23                 | 135  | 2    | 2    | 4                  | 99   | 7    | 2    | 1                  | 87   | 22   | 1    | 461        |
| 07:30 AM    | 8                  | 68   | 4    | 2    | 26                 | 128  | 7    | 2    | 4                  | 103  | 13   | 0    | 2                  | 105  | 19   | 1    | 492        |
| 07:45 AM    | 9                  | 50   | 7    | 9    | 29                 | 110  | 12   | 5    | 1                  | 128  | 11   | 0    | 7                  | 83   | 17   | 5    | 483        |
| Total       | 27                 | 225  | 22   | 15   | 93                 | 462  | 25   | 11   | 11                 | 389  | 36   | 2    | 12                 | 308  | 70   | 9    | 1717       |
| 08:00 AM    | 10                 | 62   | 6    | 1    | 16                 | 99   | 9    | 1    | 2                  | 110  | 11   | 1    | 6                  | 54   | 31   | 2    | 421        |
| 08:15 AM    | 8                  | 46   | 6    | 0    | 25                 | 72   | 7    | 2    | 1                  | 111  | 17   | 3    | 8                  | 69   | 44   | 1    | 420        |
| 08:30 AM    | 14                 | 49   | 8    | 0    | 29                 | 73   | 4    | 2    | 7                  | 97   | 5    | 0    | 3                  | 66   | 30   | 1    | 388        |
| 08:45 AM    | 8                  | 51   | 9    | 2    | 22                 | 65   | 9    | 2    | 2                  | 105  | 5    | 1    | 5                  | 39   | 36   | 1    | 362        |
| Total       | 40                 | 208  | 29   | 3    | 92                 | 309  | 29   | 7    | 12                 | 423  | 38   | 5    | 22                 | 228  | 141  | 5    | 1591       |
| Grand Total | 67                 | 433  | 51   | 18   | 185                | 771  | 54   | 18   | 23                 | 812  | 74   | 7    | 34                 | 536  | 211  | 14   | 3308       |
| Apprch %    | 11.8               | 76.1 | 9    | 3.2  | 18                 | 75   | 5.3  | 1.8  | 2.5                | 88.6 | 8.1  | 0.8  | 4.3                | 67.4 | 26.5 | 1.8  |            |
| Total %     | 2                  | 13.1 | 1.5  | 0.5  | 5.6                | 23.3 | 1.6  | 0.5  | 0.7                | 24.5 | 2.2  | 0.2  | 1                  | 16.2 | 6.4  | 0.4  |            |

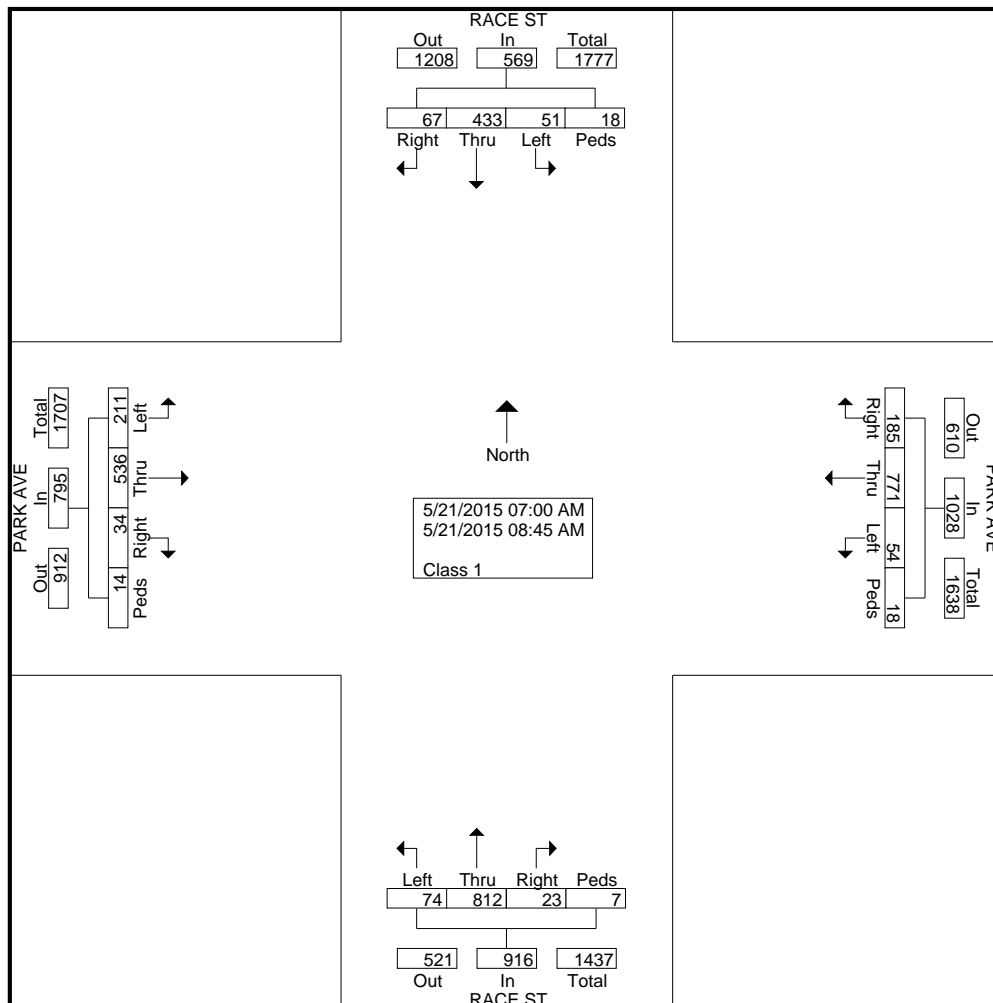

| Start Time  | RACE ST Southbound |      |      |      |            | PARK AVE Westbound |      |      |      |            | RACE ST Northbound |      |      |      |            | PARK AVE Eastbound |      |      |      |            | Int. Total |
|---|--------------------|------|------|------|------------|--------------------|------|------|------|------------|--------------------|------|------|------|------------|--------------------|------|------|------|------------|------------|
|   | Right              | Thru | Left | Peds | App. Total | Right              | Thru | Left | Peds | App. Total | Right              | Thru | Left | Peds | App. Total | Right              | Thru | Left | Peds | App. Total |            |
| <b>Peak Hour Analysis From 07:00 AM to 08:45 AM - Peak 1 of 1</b> |                    |      |      |      |            |                    |      |      |      |            |                    |      |      |      |            |                    |      |      |      |            |            |
| Peak Hour for Entire Intersection Begins at 07:15 AM              |                    |      |      |      |            |                    |      |      |      |            |                    |      |      |      |            |                    |      |      |      |            |            |
| 07:15 AM  | 7                  | 63   | 3    | 3    | 76         | 23                 | 135  | 2    | 2    | 162        | 4                  | 99   | 7    | 2    | 112        | 1                  | 87   | 22   | 1    | 111        | 461        |
| 07:30 AM  | 8                  | 68   | 4    | 2    | 82         | 26                 | 128  | 7    | 2    | 163        | 4                  | 103  | 13   | 0    | 120        | 2                  | 105  | 19   | 1    | 127        | 492        |
| 07:45 AM  | 9                  | 50   | 7    | 9    | 75         | 29                 | 110  | 12   | 5    | 156        | 1                  | 128  | 11   | 0    | 140        | 7                  | 83   | 17   | 5    | 112        | 483        |
| 08:00 AM  | 10                 | 62   | 6    | 1    | 79         | 16                 | 99   | 9    | 1    | 125        | 2                  | 110  | 11   | 1    | 124        | 6                  | 54   | 31   | 2    | 93         | 421        |
| Total Volume  | 34                 | 243  | 20   | 15   | 312        | 94                 | 472  | 30   | 10   | 606        | 11                 | 440  | 42   | 3    | 496        | 16                 | 329  | 89   | 9    | 443        | 1857       |
| % App. Total  | 10.9               | 77.9 | 6.4  | 4.8  |            | 15.5               | 77.9 | 5    | 1.7  |            | 2.2                | 88.7 | 8.5  | 0.6  |            | 3.6                | 74.3 | 20.1 | 2    |            |            |
| PHF   | .850               | .893 | .714 | .417 | .951       | .810               | .874 | .625 | .500 | .929       | .688               | .859 | .808 | .375 | .886       | .571               | .783 | .718 | .450 | .872       | .944       |

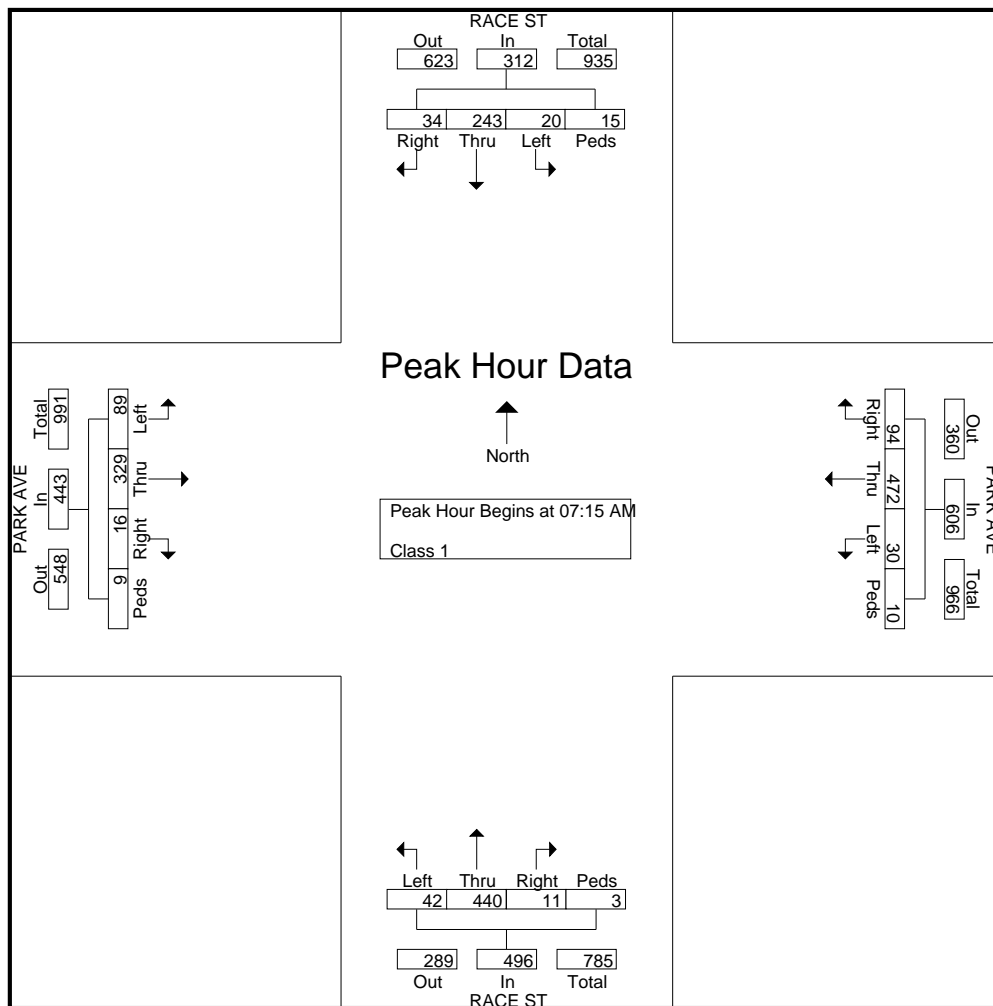

Groups Printed- Class 1

| Start Time  | RACE ST Southbound |      |      |      | PARK AVE Westbound |      |      |      | RACE ST Northbound |      |      |      | PARK AVE Eastbound |      |      |      | Int. Total |
|-------------|--------------------|------|------|------|--------------------|------|------|------|--------------------|------|------|------|--------------------|------|------|------|------------|
|             | Right              | Thru | Left | Peds | Right              | Thru | Left | Peds | Right              | Thru | Left | Peds | Right              | Thru | Left | Peds |            |
| 04:00 PM    | 13                 | 94   | 20   | 1    | 10                 | 51   | 11   | 1    | 6                  | 54   | 9    | 2    | 12                 | 98   | 20   | 3    | 405        |
| 04:15 PM    | 12                 | 108  | 25   | 1    | 11                 | 54   | 5    | 5    | 5                  | 58   | 10   | 3    | 14                 | 84   | 28   | 0    | 423        |
| 04:30 PM    | 19                 | 111  | 24   | 1    | 10                 | 48   | 7    | 4    | 7                  | 64   | 13   | 10   | 7                  | 91   | 26   | 7    | 449        |
| 04:45 PM    | 13                 | 128  | 24   | 2    | 17                 | 49   | 8    | 8    | 9                  | 74   | 6    | 3    | 6                  | 86   | 18   | 3    | 454        |
| Total       | 57                 | 441  | 93   | 5    | 48                 | 202  | 31   | 18   | 27                 | 250  | 38   | 18   | 39                 | 359  | 92   | 13   | 1731       |
| 05:00 PM    | 13                 | 133  | 21   | 2    | 9                  | 65   | 6    | 4    | 7                  | 71   | 10   | 1    | 9                  | 107  | 28   | 3    | 489        |
| 05:15 PM    | 25                 | 131  | 27   | 1    | 13                 | 80   | 5    | 9    | 13                 | 75   | 4    | 5    | 15                 | 122  | 19   | 1    | 545        |
| 05:30 PM    | 16                 | 123  | 17   | 6    | 15                 | 52   | 10   | 2    | 4                  | 59   | 11   | 3    | 13                 | 99   | 25   | 3    | 458        |
| 05:45 PM    | 12                 | 125  | 29   | 6    | 12                 | 51   | 6    | 0    | 10                 | 58   | 10   | 0    | 8                  | 112  | 29   | 3    | 471        |
| Total       | 66                 | 512  | 94   | 15   | 49                 | 248  | 27   | 15   | 34                 | 263  | 35   | 9    | 45                 | 440  | 101  | 10   | 1963       |
| Grand Total | 123                | 953  | 187  | 20   | 97                 | 450  | 58   | 33   | 61                 | 513  | 73   | 27   | 84                 | 799  | 193  | 23   | 3694       |
| Apprch %    | 9.6                | 74.3 | 14.6 | 1.6  | 15.2               | 70.5 | 9.1  | 5.2  | 9.1                | 76.1 | 10.8 | 4    | 7.6                | 72.7 | 17.6 | 2.1  |            |
| Total %     | 3.3                | 25.8 | 5.1  | 0.5  | 2.6                | 12.2 | 1.6  | 0.9  | 1.7                | 13.9 | 2    | 0.7  | 2.3                | 21.6 | 5.2  | 0.6  |            |

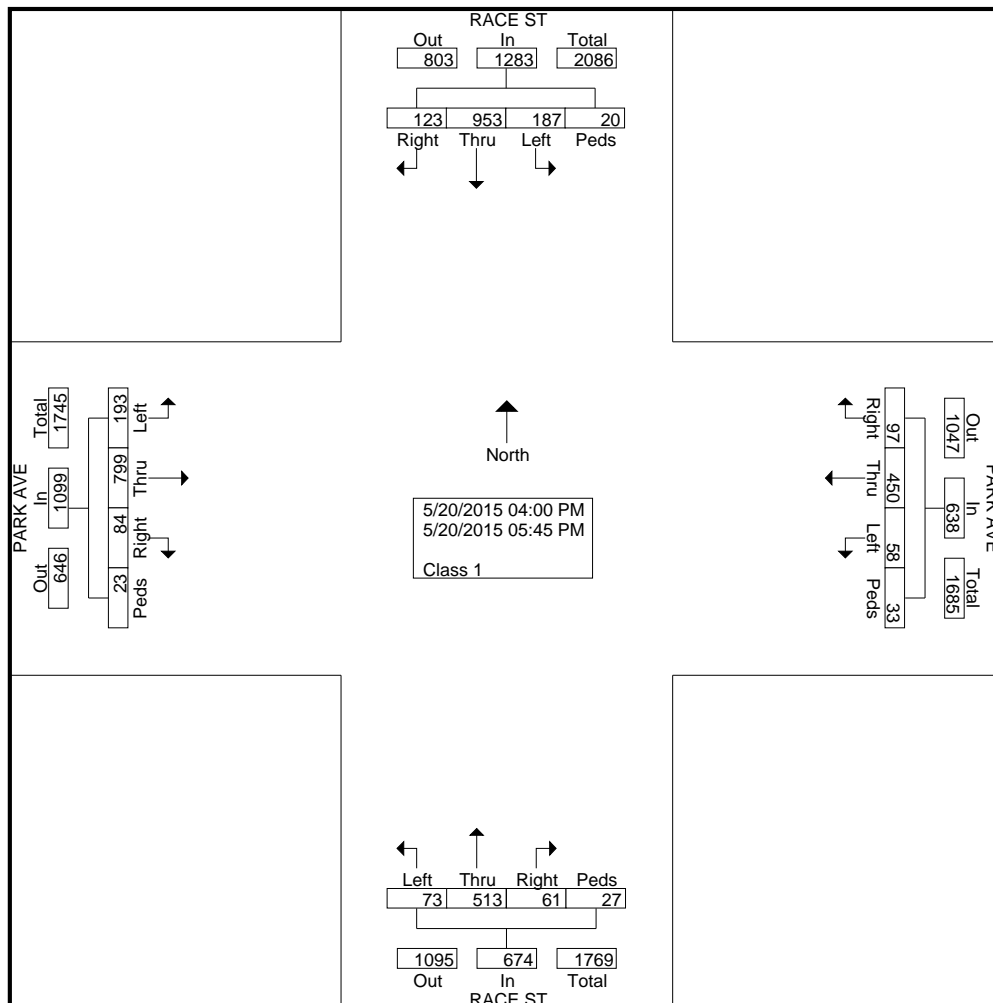

| Start Time  | RACE ST Southbound |      |      |      |            | PARK AVE Westbound |      |      |      |            | RACE ST Northbound |      |      |      |            | PARK AVE Eastbound |      |      |      |            | Int. Total |
|---|--------------------|------|------|------|------------|--------------------|------|------|------|------------|--------------------|------|------|------|------------|--------------------|------|------|------|------------|------------|
|   | Right              | Thru | Left | Peds | App. Total | Right              | Thru | Left | Peds | App. Total | Right              | Thru | Left | Peds | App. Total | Right              | Thru | Left | Peds | App. Total |            |
| <b>Peak Hour Analysis From 04:00 PM to 05:45 PM - Peak 1 of 1</b> |                    |      |      |      |            |                    |      |      |      |            |                    |      |      |      |            |                    |      |      |      |            |            |
| Peak Hour for Entire Intersection Begins at 05:00 PM              |                    |      |      |      |            |                    |      |      |      |            |                    |      |      |      |            |                    |      |      |      |            |            |
| 05:00 PM  | 13                 | 133  | 21   | 2    | 169        | 9                  | 65   | 6    | 4    | 84         | 7                  | 71   | 10   | 1    | 89         | 9                  | 107  | 28   | 3    | 147        | 489        |
| 05:15 PM  | 25                 | 131  | 27   | 1    | 184        | 13                 | 80   | 5    | 9    | 107        | 13                 | 75   | 4    | 5    | 97         | 15                 | 122  | 19   | 1    | 157        | 545        |
| 05:30 PM  | 16                 | 123  | 17   | 6    | 162        | 15                 | 52   | 10   | 2    | 79         | 4                  | 59   | 11   | 3    | 77         | 13                 | 99   | 25   | 3    | 140        | 458        |
| 05:45 PM  | 12                 | 125  | 29   | 6    | 172        | 12                 | 51   | 6    | 0    | 69         | 10                 | 58   | 10   | 0    | 78         | 8                  | 112  | 29   | 3    | 152        | 471        |
| Total Volume  | 66                 | 512  | 94   | 15   | 687        | 49                 | 248  | 27   | 15   | 339        | 34                 | 263  | 35   | 9    | 341        | 45                 | 440  | 101  | 10   | 596        | 1963       |
| % App. Total  | 9.6                | 74.5 | 13.7 | 2.2  |            | 14.5               | 73.2 | 8    | 4.4  |            | 10                 | 77.1 | 10.3 | 2.6  |            | 7.6                | 73.8 | 16.9 | 1.7  |            |            |
| PHF   | .660               | .962 | .810 | .625 | .933       | .817               | .775 | .675 | .417 | .792       | .654               | .877 | .795 | .450 | .879       | .750               | .902 | .871 | .833 | .949       | .900       |

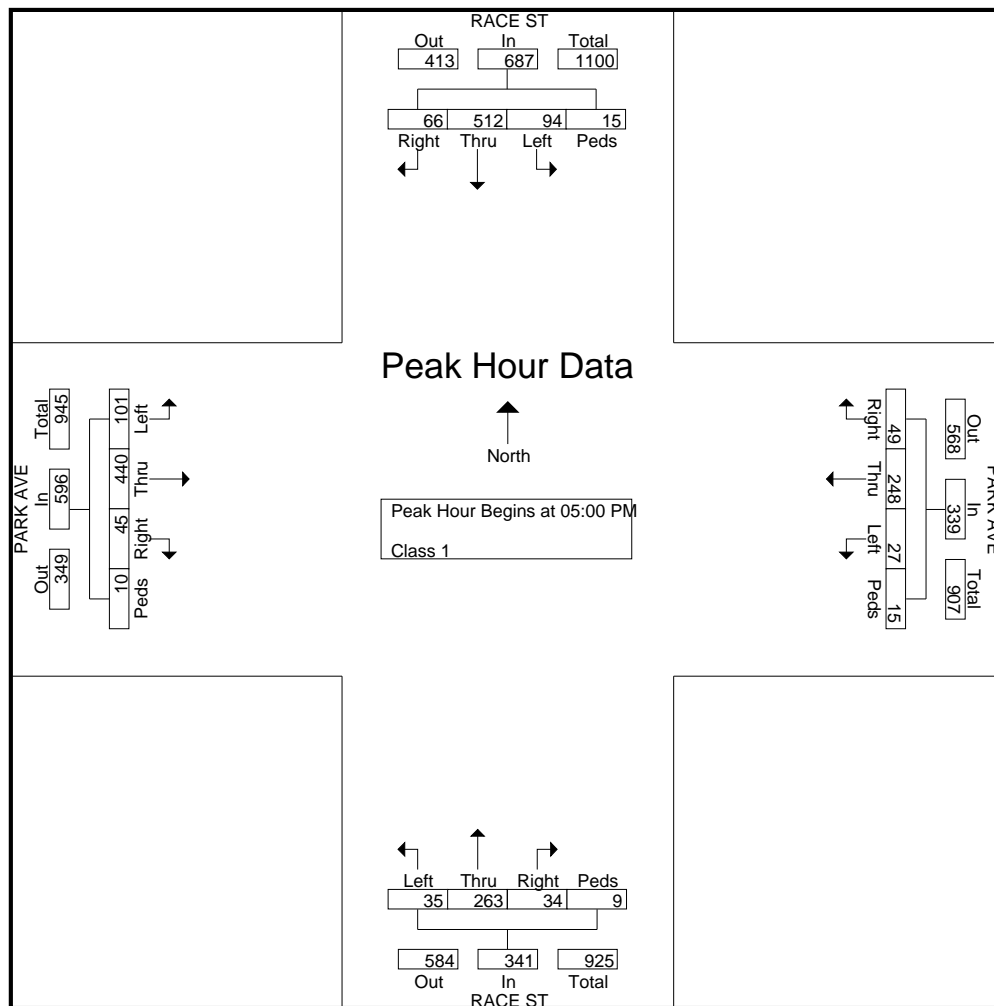



Groups Printed- Class 1

| Start Time  | SUNOL ST Southbound |      |      |      | PARK AVE Westbound |      |      |      | SUNOL ST Northbound |      |      |      | PARK AVE Eastbound |      |      |      | Int. Total |
|-------------|---------------------|------|------|------|--------------------|------|------|------|---------------------|------|------|------|--------------------|------|------|------|------------|
|             | Right               | Thru | Left | Peds | Right              | Thru | Left | Peds | Right               | Thru | Left | Peds | Right              | Thru | Left | Peds |            |
| 07:00 AM    | 2                   | 7    | 7    | 1    | 4                  | 85   | 1    | 4    | 2                   | 16   | 2    | 4    | 5                  | 37   | 1    | 0    | 178        |
| 07:15 AM    | 2                   | 5    | 19   | 1    | 12                 | 130  | 0    | 1    | 3                   | 13   | 8    | 1    | 7                  | 90   | 2    | 2    | 295        |
| 07:30 AM    | 5                   | 9    | 11   | 3    | 30                 | 112  | 5    | 1    | 5                   | 22   | 8    | 0    | 4                  | 94   | 6    | 2    | 317        |
| 07:45 AM    | 4                   | 9    | 15   | 2    | 36                 | 100  | 2    | 1    | 7                   | 18   | 4    | 0    | 2                  | 73   | 2    | 0    | 275        |
| Total       | 13                  | 30   | 52   | 7    | 82                 | 427  | 8    | 6    | 17                  | 69   | 22   | 5    | 18                 | 294  | 11   | 4    | 1065       |
| 08:00 AM    | 3                   | 12   | 5    | 0    | 17                 | 86   | 2    | 2    | 1                   | 15   | 3    | 2    | 2                  | 52   | 3    | 1    | 206        |
| 08:15 AM    | 4                   | 7    | 6    | 2    | 10                 | 91   | 2    | 0    | 7                   | 19   | 0    | 2    | 2                  | 72   | 6    | 2    | 232        |
| 08:30 AM    | 4                   | 5    | 8    | 0    | 13                 | 64   | 3    | 2    | 5                   | 18   | 1    | 0    | 4                  | 64   | 6    | 0    | 197        |
| 08:45 AM    | 7                   | 10   | 14   | 2    | 6                  | 72   | 2    | 1    | 7                   | 16   | 3    | 2    | 2                  | 44   | 1    | 3    | 192        |
| Total       | 18                  | 34   | 33   | 4    | 46                 | 313  | 9    | 5    | 20                  | 68   | 7    | 6    | 10                 | 232  | 16   | 6    | 827        |
| Grand Total | 31                  | 64   | 85   | 11   | 128                | 740  | 17   | 11   | 37                  | 137  | 29   | 11   | 28                 | 526  | 27   | 10   | 1892       |
| Apprch %    | 16.2                | 33.5 | 44.5 | 5.8  | 14.3               | 82.6 | 1.9  | 1.2  | 17.3                | 64   | 13.6 | 5.1  | 4.7                | 89   | 4.6  | 1.7  |            |
| Total %     | 1.6                 | 3.4  | 4.5  | 0.6  | 6.8                | 39.1 | 0.9  | 0.6  | 2                   | 7.2  | 1.5  | 0.6  | 1.5                | 27.8 | 1.4  | 0.5  |            |

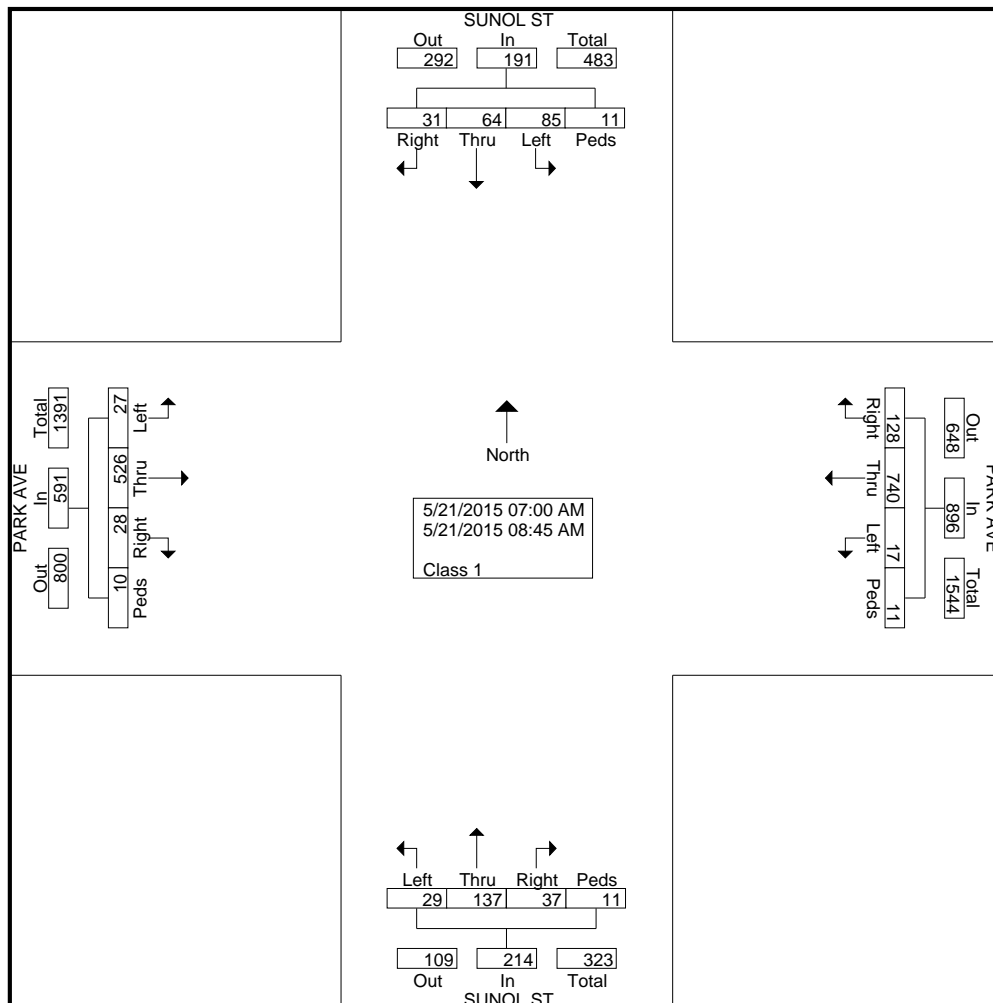

| Start Time  | SUNOL ST Southbound |      |      |      |            | PARK AVE Westbound |      |      |      |            | SUNOL ST Northbound |      |      |      |            | PARK AVE Eastbound |      |      |      |            | Int. Total |
|---|---------------------|------|------|------|------------|--------------------|------|------|------|------------|---------------------|------|------|------|------------|--------------------|------|------|------|------------|------------|
|   | Right               | Thru | Left | Peds | App. Total | Right              | Thru | Left | Peds | App. Total | Right               | Thru | Left | Peds | App. Total | Right              | Thru | Left | Peds | App. Total |            |
| <b>Peak Hour Analysis From 07:00 AM to 08:45 AM - Peak 1 of 1</b> |                     |      |      |      |            |                    |      |      |      |            |                     |      |      |      |            |                    |      |      |      |            |            |
| Peak Hour for Entire Intersection Begins at 07:15 AM              |                     |      |      |      |            |                    |      |      |      |            |                     |      |      |      |            |                    |      |      |      |            |            |
| 07:15 AM  | 2                   | 5    | 19   | 1    | 27         | 12                 | 130  | 0    | 0    | 142        | 3                   | 13   | 8    | 1    | 25         | 7                  | 90   | 2    | 2    | 101        | 295        |
| 07:30 AM  | 5                   | 9    | 11   | 3    | 28         | 30                 | 112  | 5    | 1    | 148        | 5                   | 22   | 8    | 0    | 35         | 4                  | 94   | 6    | 2    | 106        | 317        |
| 07:45 AM  | 4                   | 9    | 15   | 2    | 30         | 36                 | 100  | 2    | 1    | 139        | 7                   | 18   | 4    | 0    | 29         | 2                  | 73   | 2    | 0    | 77         | 275        |
| 08:00 AM  | 3                   | 12   | 5    | 0    | 20         | 17                 | 86   | 2    | 2    | 107        | 1                   | 15   | 3    | 2    | 21         | 2                  | 52   | 3    | 1    | 58         | 206        |
| Total Volume  | 14                  | 35   | 50   | 6    | 105        | 95                 | 428  | 9    | 4    | 536        | 16                  | 68   | 23   | 3    | 110        | 15                 | 309  | 13   | 5    | 342        | 1093       |
| % App. Total  | 13.3                | 33.3 | 47.6 | 5.7  |            | 17.7               | 79.9 | 1.7  | 0.7  |            | 14.5                | 61.8 | 20.9 | 2.7  |            | 4.4                | 90.4 | 3.8  | 1.5  |            |            |
| PHF   | .700                | .729 | .658 | .500 | .875       | .660               | .823 | .450 | .500 | .905       | .571                | .773 | .719 | .375 | .786       | .536               | .822 | .542 | .625 | .807       | .862       |

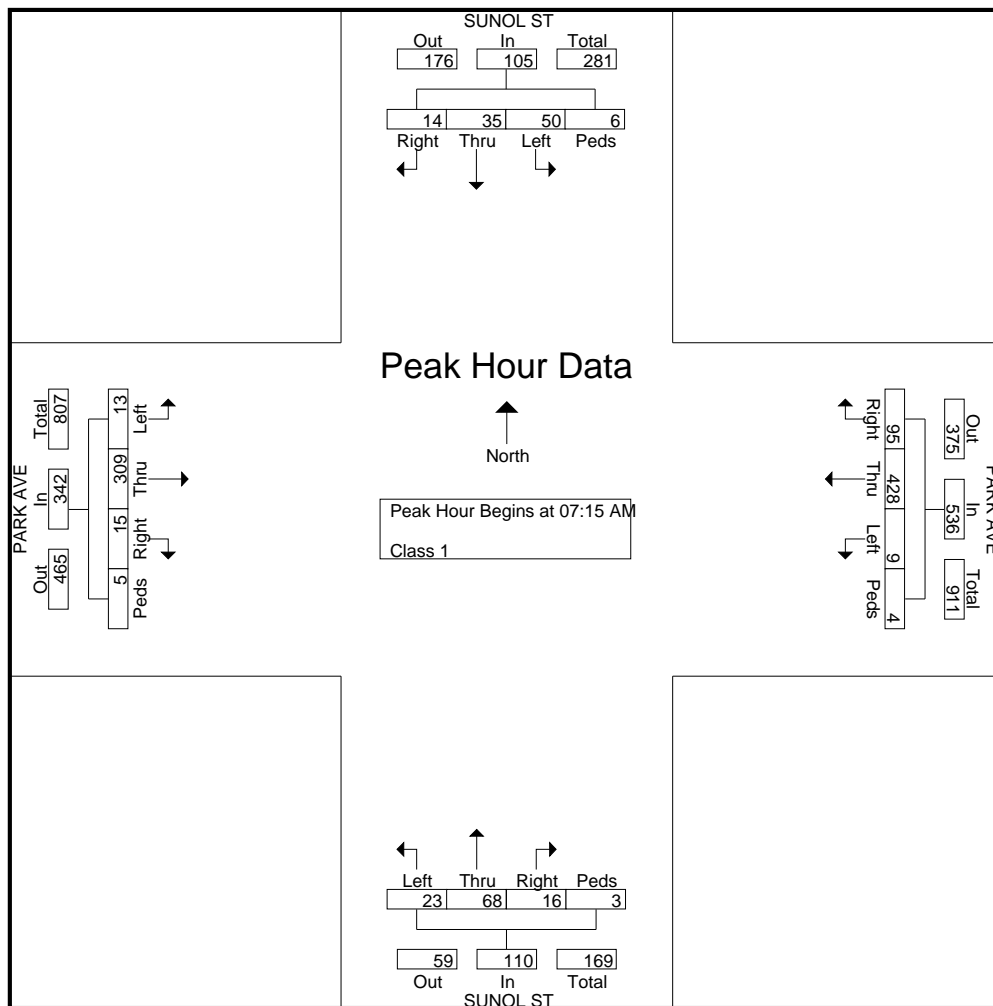

Groups Printed- Class 1

| Start Time  | SUNOL ST Southbound |      |      |      | PARK AVE Westbound |      |      |      | SUNOL ST Northbound |      |      |      | PARK AVE Eastbound |      |      |      | Int. Total |
|-------------|---------------------|------|------|------|--------------------|------|------|------|---------------------|------|------|------|--------------------|------|------|------|------------|
|             | Right               | Thru | Left | Peds | Right              | Thru | Left | Peds | Right               | Thru | Left | Peds | Right              | Thru | Left | Peds |            |
| 04:00 PM    | 9                   | 15   | 13   | 1    | 5                  | 55   | 2    | 2    | 11                  | 12   | 4    | 0    | 7                  | 90   | 9    | 2    | 237        |
| 04:15 PM    | 8                   | 19   | 15   | 6    | 11                 | 56   | 3    | 1    | 7                   | 14   | 2    | 2    | 7                  | 80   | 7    | 0    | 238        |
| 04:30 PM    | 3                   | 18   | 20   | 1    | 6                  | 55   | 3    | 1    | 10                  | 12   | 1    | 3    | 7                  | 84   | 5    | 4    | 233        |
| 04:45 PM    | 10                  | 28   | 15   | 2    | 11                 | 58   | 3    | 3    | 8                   | 16   | 5    | 2    | 5                  | 92   | 6    | 0    | 264        |
| Total       | 30                  | 80   | 63   | 10   | 33                 | 224  | 11   | 7    | 36                  | 54   | 12   | 7    | 26                 | 346  | 27   | 6    | 972        |
| 05:00 PM    | 9                   | 38   | 26   | 1    | 18                 | 81   | 6    | 7    | 7                   | 19   | 3    | 3    | 12                 | 101  | 3    | 4    | 338        |
| 05:15 PM    | 5                   | 43   | 22   | 2    | 6                  | 86   | 5    | 4    | 8                   | 20   | 6    | 2    | 13                 | 93   | 6    | 0    | 321        |
| 05:30 PM    | 8                   | 35   | 24   | 6    | 8                  | 58   | 1    | 1    | 8                   | 22   | 2    | 2    | 8                  | 84   | 3    | 6    | 276        |
| 05:45 PM    | 10                  | 29   | 25   | 2    | 7                  | 68   | 2    | 0    | 7                   | 13   | 2    | 0    | 7                  | 106  | 11   | 3    | 292        |
| Total       | 32                  | 145  | 97   | 11   | 39                 | 293  | 14   | 12   | 30                  | 74   | 13   | 7    | 40                 | 384  | 23   | 13   | 1227       |
| Grand Total | 62                  | 225  | 160  | 21   | 72                 | 517  | 25   | 19   | 66                  | 128  | 25   | 14   | 66                 | 730  | 50   | 19   | 2199       |
| Apprch %    | 13.2                | 48.1 | 34.2 | 4.5  | 11.4               | 81.7 | 3.9  | 3    | 28.3                | 54.9 | 10.7 | 6    | 7.6                | 84.4 | 5.8  | 2.2  |            |
| Total %     | 2.8                 | 10.2 | 7.3  | 1    | 3.3                | 23.5 | 1.1  | 0.9  | 3                   | 5.8  | 1.1  | 0.6  | 3                  | 33.2 | 2.3  | 0.9  |            |

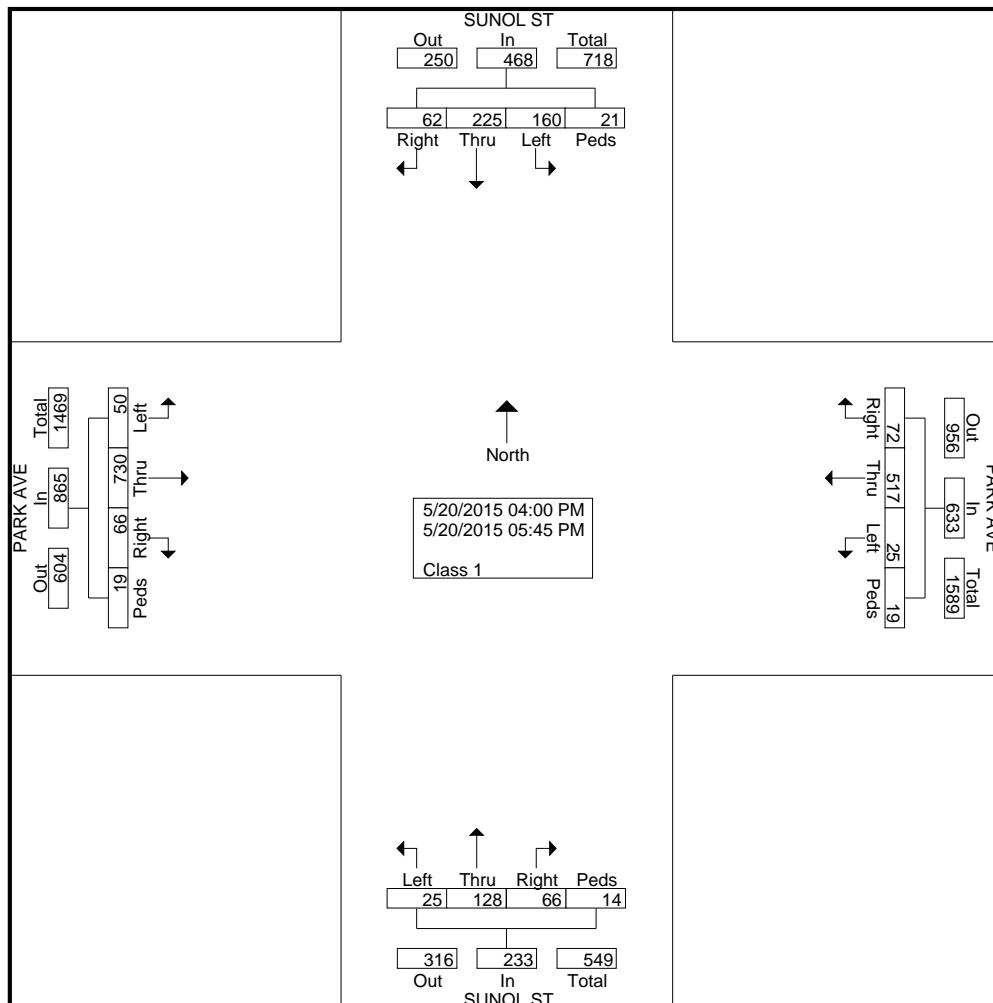

| Start Time  | SUNOL ST Southbound |      |      |      |            | PARK AVE Westbound |      |      |      |            | SUNOL ST Northbound |      |      |      |            | PARK AVE Eastbound |      |      |      |            | Int. Total |
|---|---------------------|------|------|------|------------|--------------------|------|------|------|------------|---------------------|------|------|------|------------|--------------------|------|------|------|------------|------------|
|   | Right               | Thru | Left | Peds | App. Total | Right              | Thru | Left | Peds | App. Total | Right               | Thru | Left | Peds | App. Total | Right              | Thru | Left | Peds | App. Total |            |
| <b>Peak Hour Analysis From 04:00 PM to 05:45 PM - Peak 1 of 1</b> |                     |      |      |      |            |                    |      |      |      |            |                     |      |      |      |            |                    |      |      |      |            |            |
| Peak Hour for Entire Intersection Begins at 05:00 PM              |                     |      |      |      |            |                    |      |      |      |            |                     |      |      |      |            |                    |      |      |      |            |            |
| 05:00 PM  | 9                   | 38   | 26   | 1    | 74         | 18                 | 81   | 6    | 7    | 112        | 7                   | 19   | 3    | 3    | 32         | 12                 | 101  | 3    | 4    | 120        | 338        |
| 05:15 PM  | 5                   | 43   | 22   | 2    | 72         | 6                  | 86   | 5    | 4    | 101        | 8                   | 20   | 6    | 2    | 36         | 13                 | 93   | 6    | 0    | 112        | 321        |
| 05:30 PM  | 8                   | 35   | 24   | 6    | 73         | 8                  | 58   | 1    | 1    | 68         | 8                   | 22   | 2    | 2    | 34         | 8                  | 84   | 3    | 6    | 101        | 276        |
| 05:45 PM  | 10                  | 29   | 25   | 2    | 66         | 7                  | 68   | 2    | 0    | 77         | 7                   | 13   | 2    | 0    | 22         | 7                  | 106  | 11   | 3    | 127        | 292        |
| Total Volume  | 32                  | 145  | 97   | 11   | 285        | 39                 | 293  | 14   | 12   | 358        | 30                  | 74   | 13   | 7    | 124        | 40                 | 384  | 23   | 13   | 460        | 1227       |
| % App. Total  | 11.2                | 50.9 | 34   | 3.9  |            | 10.9               | 81.8 | 3.9  | 3.4  |            | 24.2                | 59.7 | 10.5 | 5.6  |            | 8.7                | 83.5 | 5    | 2.8  |            |            |
| PHF   | .800                | .843 | .933 | .458 | .963       | .542               | .852 | .583 | .429 | .799       | .938                | .841 | .542 | .583 | .861       | .769               | .906 | .523 | .542 | .906       | .908       |

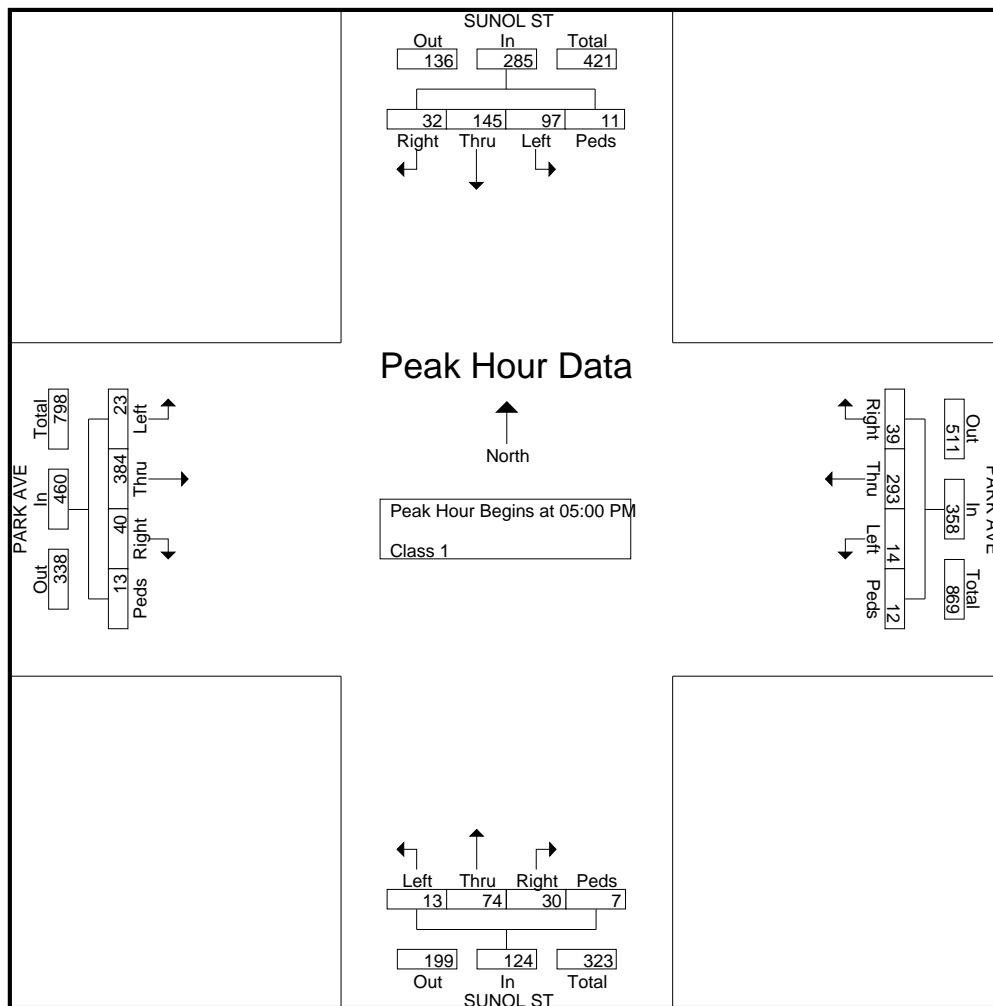

File Name : #13 MARKET&STJAMESAM  
 Site Code :  
 Start Date : 5/21/2015  
 Page No : 1

Groups Printed- Class 1

| Start Time  | N MARKET ST Southbound |      |      |      | W ST JAMES ST Westbound |      |      |      | N MARKET ST Northbound |      |      |      | W ST JAMES ST Eastbound |      |      |      | Int. Total |
|-------------|------------------------|------|------|------|-------------------------|------|------|------|------------------------|------|------|------|-------------------------|------|------|------|------------|
|             | Right                  | Thru | Left | Peds | Right                   | Thru | Left | Peds | Right                  | Thru | Left | Peds | Right                   | Thru | Left | Peds |            |
| 07:00 AM    | 0                      | 48   | 8    | 0    | 0                       | 0    | 0    | 0    | 3                      | 183  | 0    | 2    | 5                       | 60   | 31   | 1    | 341        |
| 07:15 AM    | 0                      | 82   | 11   | 0    | 0                       | 0    | 0    | 4    | 5                      | 210  | 0    | 2    | 19                      | 87   | 38   | 1    | 459        |
| 07:30 AM    | 0                      | 83   | 17   | 0    | 0                       | 0    | 0    | 2    | 4                      | 218  | 0    | 4    | 16                      | 95   | 53   | 0    | 492        |
| 07:45 AM    | 0                      | 109  | 22   | 0    | 0                       | 0    | 0    | 7    | 12                     | 195  | 0    | 4    | 26                      | 114  | 55   | 1    | 545        |
| Total       | 0                      | 322  | 58   | 0    | 0                       | 0    | 0    | 13   | 24                     | 806  | 0    | 12   | 66                      | 356  | 177  | 3    | 1837       |
| 08:00 AM    | 0                      | 100  | 17   | 0    | 0                       | 0    | 0    | 3    | 10                     | 200  | 0    | 6    | 29                      | 119  | 65   | 2    | 551        |
| 08:15 AM    | 0                      | 99   | 24   | 0    | 0                       | 0    | 0    | 3    | 7                      | 191  | 0    | 7    | 31                      | 103  | 63   | 3    | 531        |
| 08:30 AM    | 0                      | 104  | 22   | 0    | 0                       | 0    | 0    | 3    | 8                      | 159  | 0    | 4    | 28                      | 99   | 52   | 3    | 482        |
| 08:45 AM    | 0                      | 98   | 22   | 0    | 0                       | 0    | 0    | 2    | 11                     | 126  | 0    | 10   | 22                      | 122  | 50   | 7    | 470        |
| Total       | 0                      | 401  | 85   | 0    | 0                       | 0    | 0    | 11   | 36                     | 676  | 0    | 27   | 110                     | 443  | 230  | 15   | 2034       |
| Grand Total | 0                      | 723  | 143  | 0    | 0                       | 0    | 0    | 24   | 60                     | 1482 | 0    | 39   | 176                     | 799  | 407  | 18   | 3871       |
| Apprch %    | 0                      | 83.5 | 16.5 | 0    | 0                       | 0    | 0    | 100  | 3.8                    | 93.7 | 0    | 2.5  | 12.6                    | 57.1 | 29.1 | 1.3  |            |
| Total %     | 0                      | 18.7 | 3.7  | 0    | 0                       | 0    | 0    | 0.6  | 1.5                    | 38.3 | 0    | 1    | 4.5                     | 20.6 | 10.5 | 0.5  |            |

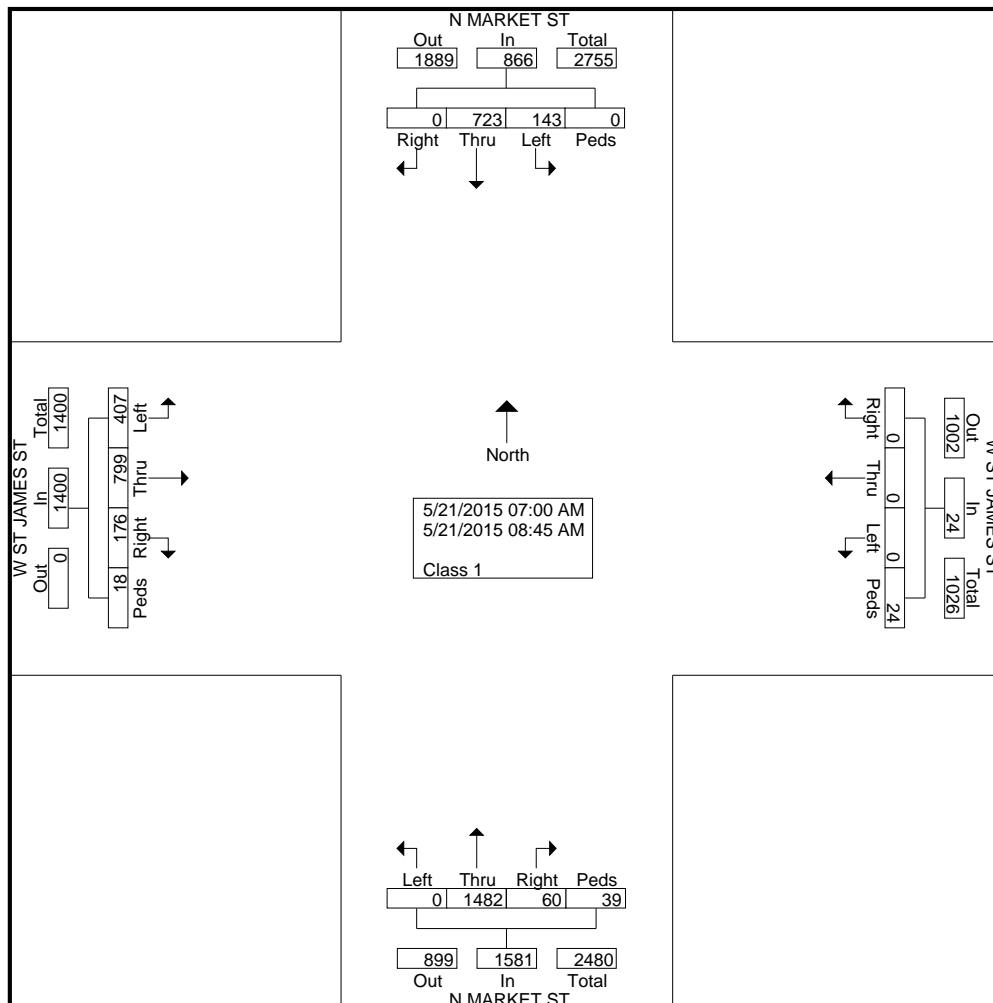

File Name : #13 MARKET&STJAMESAM  
 Site Code :  
 Start Date : 5/21/2015  
 Page No : 2

| Start Time  | N MARKET ST Southbound |      |      |      |            | W ST JAMES ST Westbound |      |      |      |            | N MARKET ST Northbound |      |      |      |            | W ST JAMES ST Eastbound |      |      |      |            | Int. Total |
|---|------------------------|------|------|------|------------|-------------------------|------|------|------|------------|------------------------|------|------|------|------------|-------------------------|------|------|------|------------|------------|
|   | Right                  | Thru | Left | Peds | App. Total | Right                   | Thru | Left | Peds | App. Total | Right                  | Thru | Left | Peds | App. Total | Right                   | Thru | Left | Peds | App. Total |            |
| <b>Peak Hour Analysis From 07:00 AM to 08:45 AM - Peak 1 of 1</b> |                        |      |      |      |            |                         |      |      |      |            |                        |      |      |      |            |                         |      |      |      |            |            |
| Peak Hour for Entire Intersection Begins at 07:30 AM              |                        |      |      |      |            |                         |      |      |      |            |                        |      |      |      |            |                         |      |      |      |            |            |
| 07:30 AM  | 0                      | 83   | 17   | 0    | 100        | 0                       | 0    | 0    | 2    | 2          | 4                      | 218  | 0    | 4    | 226        | 16                      | 95   | 53   | 0    | 164        | 492        |
| 07:45 AM  | 0                      | 109  | 22   | 0    | 131        | 0                       | 0    | 0    | 7    | 7          | 12                     | 195  | 0    | 4    | 211        | 26                      | 114  | 55   | 1    | 196        | 545        |
| 08:00 AM  | 0                      | 100  | 17   | 0    | 117        | 0                       | 0    | 0    | 3    | 3          | 10                     | 200  | 0    | 6    | 216        | 29                      | 119  | 65   | 2    | 215        | 551        |
| 08:15 AM  | 0                      | 99   | 24   | 0    | 123        | 0                       | 0    | 0    | 3    | 3          | 7                      | 191  | 0    | 7    | 205        | 31                      | 103  | 63   | 3    | 200        | 531        |
| Total Volume  | 0                      | 391  | 80   | 0    | 471        | 0                       | 0    | 0    | 15   | 15         | 33                     | 804  | 0    | 21   | 858        | 102                     | 431  | 236  | 6    | 775        | 2119       |
| % App. Total  | 0                      | 83   | 17   | 0    |            | 0                       | 0    | 0    | 100  |            | 3.8                    | 93.7 | 0    | 2.4  |            | 13.2                    | 55.6 | 30.5 | 0.8  |            |            |
| PHF   | .000                   | .897 | .833 | .000 | .899       | .000                    | .000 | .000 | .536 | .536       | .688                   | .922 | .000 | .750 | .949       | .823                    | .905 | .908 | .500 | .901       | .961       |

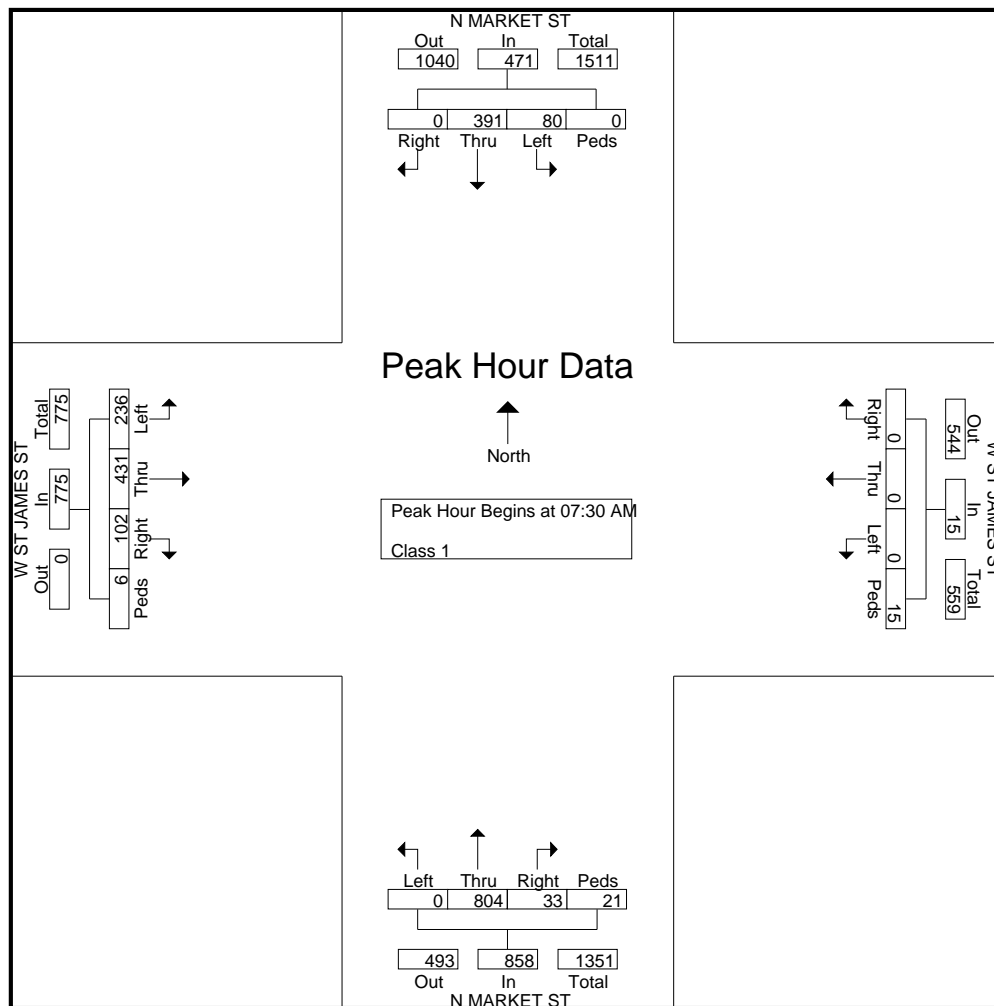

File Name : #13 MARKET&STJAMESPM  
 Site Code :  
 Start Date : 5/20/2015  
 Page No : 1

Groups Printed- Class 1

| Start Time  | N MARKET ST Southbound |      |      |      | W ST JAMES ST Westbound |      |      |      | N MARKET ST Northbound |      |      |      | W ST JAMES ST Eastbound |      |      |      | Int. Total |
|-------------|------------------------|------|------|------|-------------------------|------|------|------|------------------------|------|------|------|-------------------------|------|------|------|------------|
|             | Right                  | Thru | Left | Peds | Right                   | Thru | Left | Peds | Right                  | Thru | Left | Peds | Right                   | Thru | Left | Peds |            |
| 04:00 PM    | 0                      | 116  | 10   | 0    | 0                       | 0    | 0    | 3    | 2                      | 25   | 0    | 11   | 14                      | 143  | 24   | 5    | 353        |
| 04:15 PM    | 0                      | 142  | 11   | 0    | 0                       | 0    | 0    | 4    | 5                      | 30   | 0    | 9    | 8                       | 112  | 24   | 7    | 352        |
| 04:30 PM    | 0                      | 250  | 36   | 0    | 0                       | 0    | 0    | 6    | 5                      | 50   | 0    | 7    | 18                      | 129  | 32   | 1    | 534        |
| 04:45 PM    | 0                      | 202  | 46   | 0    | 0                       | 0    | 0    | 6    | 11                     | 96   | 0    | 10   | 11                      | 147  | 39   | 3    | 571        |
| Total       | 0                      | 710  | 103  | 0    | 0                       | 0    | 0    | 19   | 23                     | 201  | 0    | 37   | 51                      | 531  | 119  | 16   | 1810       |
| 05:00 PM    | 0                      | 203  | 54   | 0    | 0                       | 0    | 0    | 2    | 12                     | 111  | 0    | 4    | 18                      | 144  | 44   | 5    | 597        |
| 05:15 PM    | 0                      | 233  | 47   | 0    | 0                       | 0    | 0    | 4    | 10                     | 93   | 0    | 9    | 33                      | 185  | 31   | 7    | 652        |
| 05:30 PM    | 0                      | 271  | 36   | 0    | 0                       | 0    | 0    | 4    | 8                      | 81   | 0    | 5    | 25                      | 131  | 32   | 5    | 598        |
| 05:45 PM    | 0                      | 242  | 64   | 0    | 0                       | 0    | 0    | 9    | 9                      | 55   | 0    | 8    | 28                      | 158  | 26   | 7    | 606        |
| Total       | 0                      | 949  | 201  | 0    | 0                       | 0    | 0    | 19   | 39                     | 340  | 0    | 26   | 104                     | 618  | 133  | 24   | 2453       |
| Grand Total | 0                      | 1659 | 304  | 0    | 0                       | 0    | 0    | 38   | 62                     | 541  | 0    | 63   | 155                     | 1149 | 252  | 40   | 4263       |
| Apprch %    | 0                      | 84.5 | 15.5 | 0    | 0                       | 0    | 0    | 100  | 9.3                    | 81.2 | 0    | 9.5  | 9.7                     | 72   | 15.8 | 2.5  |            |
| Total %     | 0                      | 38.9 | 7.1  | 0    | 0                       | 0    | 0    | 0.9  | 1.5                    | 12.7 | 0    | 1.5  | 3.6                     | 27   | 5.9  | 0.9  |            |

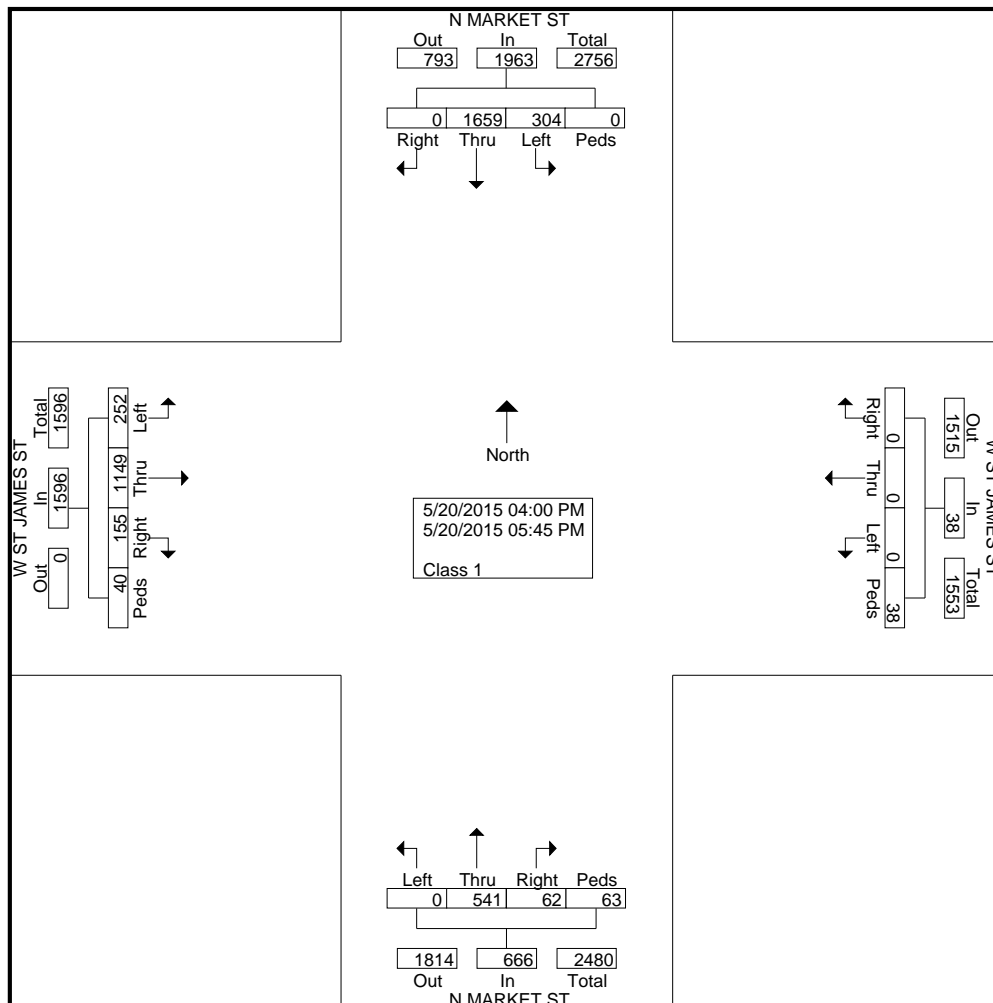



File Name : #13 MARKET&STJAMESPM  
 Site Code :  
 Start Date : 5/20/2015  
 Page No : 2

| Start Time  | N MARKET ST Southbound |      |      |      |            | W ST JAMES ST Westbound |      |      |      |            | N MARKET ST Northbound |      |      |      |            | W ST JAMES ST Eastbound |      |      |      |            | Int. Total |
|---|------------------------|------|------|------|------------|-------------------------|------|------|------|------------|------------------------|------|------|------|------------|-------------------------|------|------|------|------------|------------|
|   | Right                  | Thru | Left | Peds | App. Total | Right                   | Thru | Left | Peds | App. Total | Right                  | Thru | Left | Peds | App. Total | Right                   | Thru | Left | Peds | App. Total |            |
| <b>Peak Hour Analysis From 04:00 PM to 05:45 PM - Peak 1 of 1</b> |                        |      |      |      |            |                         |      |      |      |            |                        |      |      |      |            |                         |      |      |      |            |            |
| Peak Hour for Entire Intersection Begins at 05:00 PM              |                        |      |      |      |            |                         |      |      |      |            |                        |      |      |      |            |                         |      |      |      |            |            |
| 05:00 PM  | 0                      | 203  | 54   | 0    | 257        | 0                       | 0    | 0    | 2    | 2          | 12                     | 111  | 0    | 4    | 127        | 18                      | 144  | 44   | 5    | 211        | 597        |
| 05:15 PM  | 0                      | 233  | 47   | 0    | 280        | 0                       | 0    | 0    | 4    | 4          | 10                     | 93   | 0    | 9    | 112        | 33                      | 185  | 31   | 7    | 256        | 652        |
| 05:30 PM  | 0                      | 271  | 36   | 0    | 307        | 0                       | 0    | 0    | 4    | 4          | 8                      | 81   | 0    | 5    | 94         | 25                      | 131  | 32   | 5    | 193        | 598        |
| 05:45 PM  | 0                      | 242  | 64   | 0    | 306        | 0                       | 0    | 0    | 9    | 9          | 9                      | 55   | 0    | 8    | 72         | 28                      | 158  | 26   | 7    | 219        | 606        |
| Total Volume  | 0                      | 949  | 201  | 0    | 1150       | 0                       | 0    | 0    | 19   | 19         | 39                     | 340  | 0    | 26   | 405        | 104                     | 618  | 133  | 24   | 879        | 2453       |
| % App. Total  | 0                      | 82.5 | 17.5 | 0    |            | 0                       | 0    | 0    | 100  |            | 9.6                    | 84   | 0    | 6.4  |            | 11.8                    | 70.3 | 15.1 | 2.7  |            |            |
| PHF   | .000                   | .875 | .785 | .000 | .936       | .000                    | .000 | .000 | .528 | .528       | .813                   | .766 | .000 | .722 | .797       | .788                    | .835 | .756 | .857 | .858       | .941       |

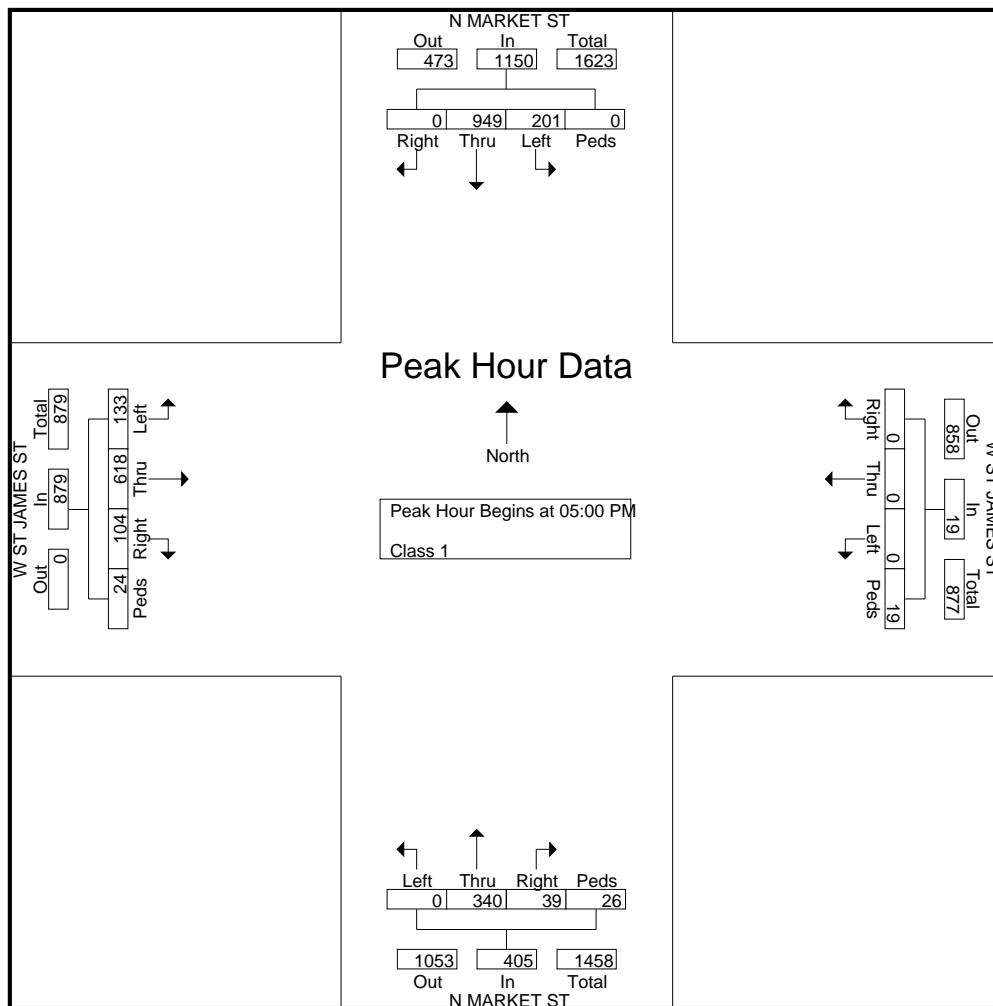

File Name : #14 ALAMEDA&NEWHALLAM  
 Site Code :  
 Start Date : 5/21/2015  
 Page No : 1

Groups Printed- Class 1

| Start Time  | NEWHALL ST Southbound |      |      |      | THE ALAMEDA Westbound |      |      |      | NEWHALL ST Northbound |      |      |      | THE ALAMEDA Eastbound |      |      |      | Int. Total |
|-------------|-----------------------|------|------|------|-----------------------|------|------|------|-----------------------|------|------|------|-----------------------|------|------|------|------------|
|             | Right                 | Thru | Left | Peds | Right                 | Thru | Left | Peds | Right                 | Thru | Left | Peds | Right                 | Thru | Left | Peds |            |
| 07:00 AM    | 8                     | 5    | 22   | 1    | 10                    | 252  | 7    | 0    | 13                    | 1    | 6    | 1    | 1                     | 98   | 2    | 3    | 430        |
| 07:15 AM    | 9                     | 12   | 21   | 0    | 5                     | 301  | 8    | 0    | 22                    | 5    | 8    | 1    | 8                     | 119  | 4    | 1    | 524        |
| 07:30 AM    | 6                     | 4    | 23   | 1    | 4                     | 343  | 17   | 2    | 24                    | 6    | 10   | 5    | 5                     | 121  | 2    | 0    | 573        |
| 07:45 AM    | 9                     | 4    | 15   | 1    | 6                     | 363  | 12   | 2    | 24                    | 4    | 14   | 2    | 4                     | 157  | 3    | 3    | 623        |
| Total       | 32                    | 25   | 81   | 3    | 25                    | 1259 | 44   | 4    | 83                    | 16   | 38   | 9    | 18                    | 495  | 11   | 7    | 2150       |
| 08:00 AM    | 8                     | 10   | 26   | 3    | 8                     | 369  | 12   | 0    | 22                    | 3    | 18   | 1    | 7                     | 166  | 1    | 1    | 655        |
| 08:15 AM    | 2                     | 2    | 19   | 0    | 11                    | 355  | 21   | 0    | 22                    | 2    | 12   | 3    | 8                     | 145  | 3    | 0    | 605        |
| 08:30 AM    | 9                     | 2    | 22   | 1    | 7                     | 364  | 9    | 2    | 22                    | 4    | 17   | 1    | 2                     | 133  | 3    | 2    | 600        |
| 08:45 AM    | 9                     | 3    | 14   | 5    | 7                     | 292  | 14   | 4    | 22                    | 3    | 14   | 2    | 6                     | 169  | 5    | 1    | 570        |
| Total       | 28                    | 17   | 81   | 9    | 33                    | 1380 | 56   | 6    | 88                    | 12   | 61   | 7    | 23                    | 613  | 12   | 4    | 2430       |
| Grand Total | 60                    | 42   | 162  | 12   | 58                    | 2639 | 100  | 10   | 171                   | 28   | 99   | 16   | 41                    | 1108 | 23   | 11   | 4580       |
| Apprch %    | 21.7                  | 15.2 | 58.7 | 4.3  | 2.1                   | 94   | 3.6  | 0.4  | 54.5                  | 8.9  | 31.5 | 5.1  | 3.5                   | 93.7 | 1.9  | 0.9  |            |
| Total %     | 1.3                   | 0.9  | 3.5  | 0.3  | 1.3                   | 57.6 | 2.2  | 0.2  | 3.7                   | 0.6  | 2.2  | 0.3  | 0.9                   | 24.2 | 0.5  | 0.2  |            |

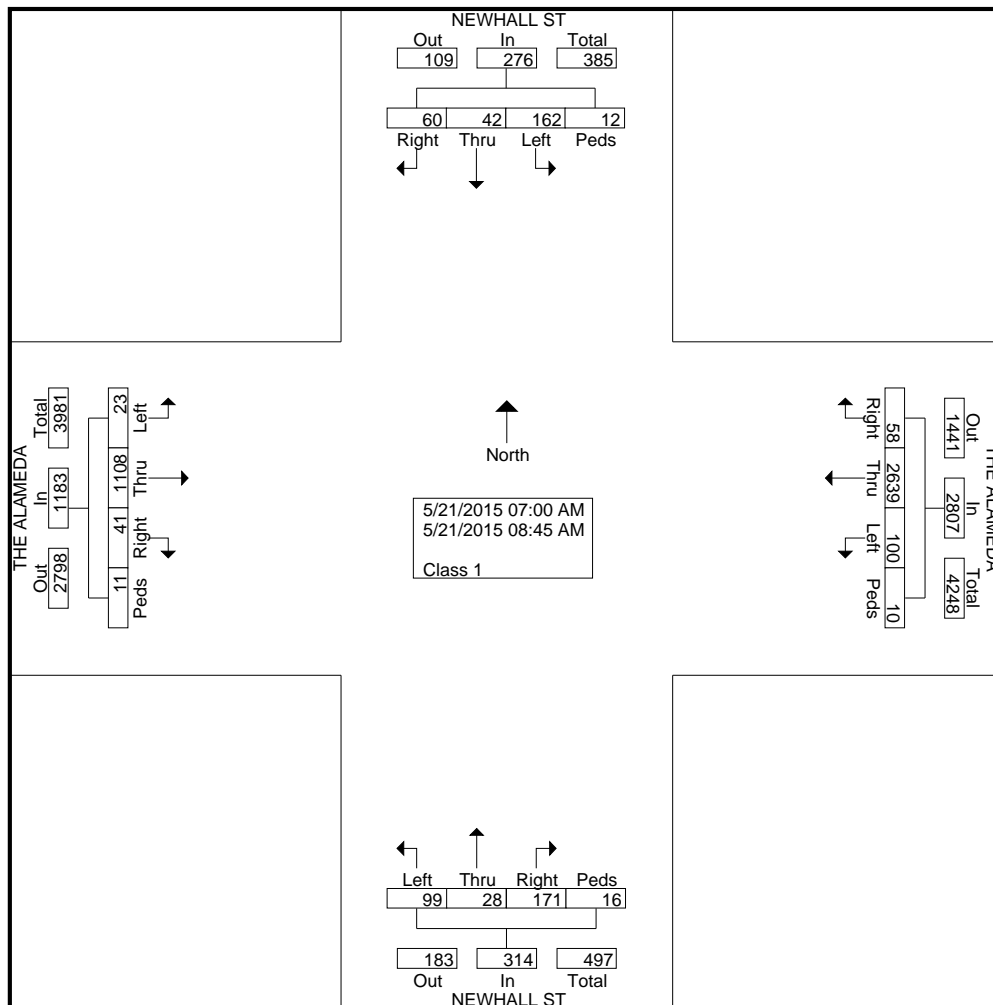

| Start Time  | NEWHALL ST Southbound |      |      |      |            | THE ALAMEDA Westbound |      |      |      |            | NEWHALL ST Northbound |      |      |      |            | THE ALAMEDA Eastbound |      |      |      |            | Int. Total |
|---|-----------------------|------|------|------|------------|-----------------------|------|------|------|------------|-----------------------|------|------|------|------------|-----------------------|------|------|------|------------|------------|
|   | Right                 | Thru | Left | Peds | App. Total | Right                 | Thru | Left | Peds | App. Total | Right                 | Thru | Left | Peds | App. Total | Right                 | Thru | Left | Peds | App. Total |            |
| <b>Peak Hour Analysis From 07:00 AM to 08:45 AM - Peak 1 of 1</b> |                       |      |      |      |            |                       |      |      |      |            |                       |      |      |      |            |                       |      |      |      |            |            |
| Peak Hour for Entire Intersection Begins at 07:45 AM              |                       |      |      |      |            |                       |      |      |      |            |                       |      |      |      |            |                       |      |      |      |            |            |
| 07:45 AM  | 9                     | 4    | 15   | 1    | 29         | 6                     | 363  | 12   | 2    | 383        | 24                    | 4    | 14   | 2    | 44         | 4                     | 157  | 3    | 3    | 167        | 623        |
| 08:00 AM  | 8                     | 10   | 26   | 3    | 47         | 8                     | 369  | 12   | 0    | 389        | 22                    | 3    | 18   | 1    | 44         | 7                     | 166  | 1    | 1    | 175        | 655        |
| 08:15 AM  | 2                     | 2    | 19   | 0    | 23         | 11                    | 355  | 21   | 0    | 387        | 22                    | 2    | 12   | 3    | 39         | 8                     | 145  | 3    | 0    | 156        | 605        |
| 08:30 AM  | 9                     | 2    | 22   | 1    | 34         | 7                     | 364  | 9    | 2    | 382        | 22                    | 4    | 17   | 1    | 44         | 2                     | 133  | 3    | 2    | 140        | 600        |
| Total Volume  | 28                    | 18   | 82   | 5    | 133        | 32                    | 1451 | 54   | 4    | 1541       | 90                    | 13   | 61   | 7    | 171        | 21                    | 601  | 10   | 6    | 638        | 2483       |
| % App. Total  | 21.1                  | 13.5 | 61.7 | 3.8  |            | 2.1                   | 94.2 | 3.5  | 0.3  |            | 52.6                  | 7.6  | 35.7 | 4.1  |            | 3.3                   | 94.2 | 1.6  | 0.9  |            |            |
| PHF   | .778                  | .450 | .788 | .417 | .707       | .727                  | .983 | .643 | .500 | .990       | .938                  | .813 | .847 | .583 | .972       | .656                  | .905 | .833 | .500 | .911       | .948       |

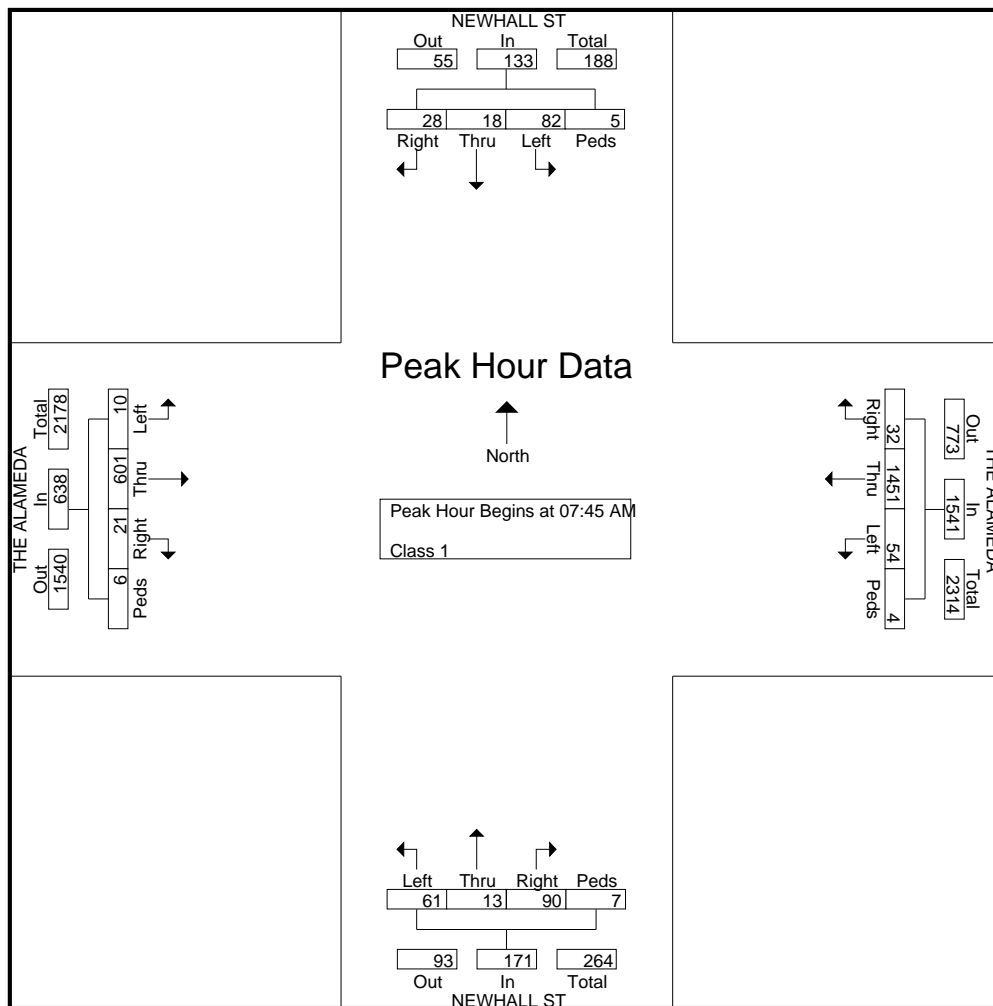

Groups Printed- Class 1

| Start Time  | NEWHALL ST Southbound |      |      |      | THE ALAMEDA Westbound |      |      |      | NEWHALL ST Northbound |      |      |      | THE ALAMEDA Eastbound |      |      |      | Int. Total |
|-------------|-----------------------|------|------|------|-----------------------|------|------|------|-----------------------|------|------|------|-----------------------|------|------|------|------------|
|             | Right                 | Thru | Left | Peds | Right                 | Thru | Left | Peds | Right                 | Thru | Left | Peds | Right                 | Thru | Left | Peds |            |
| 04:00 PM    | 10                    | 6    | 11   | 2    | 11                    | 207  | 10   | 1    | 15                    | 2    | 5    | 11   | 4                     | 341  | 3    | 1    | 640        |
| 04:15 PM    | 5                     | 4    | 17   | 0    | 17                    | 203  | 16   | 0    | 21                    | 7    | 3    | 4    | 11                    | 284  | 8    | 3    | 603        |
| 04:30 PM    | 9                     | 7    | 19   | 1    | 9                     | 207  | 11   | 2    | 19                    | 8    | 5    | 1    | 7                     | 360  | 3    | 6    | 674        |
| 04:45 PM    | 4                     | 4    | 21   | 1    | 10                    | 210  | 10   | 2    | 12                    | 4    | 6    | 1    | 14                    | 378  | 8    | 1    | 686        |
| Total       | 28                    | 21   | 68   | 4    | 47                    | 827  | 47   | 5    | 67                    | 21   | 19   | 17   | 36                    | 1363 | 22   | 11   | 2603       |
| 05:00 PM    | 4                     | 7    | 23   | 1    | 18                    | 217  | 17   | 0    | 18                    | 5    | 6    | 4    | 11                    | 462  | 12   | 0    | 805        |
| 05:15 PM    | 8                     | 9    | 18   | 0    | 11                    | 245  | 20   | 0    | 22                    | 7    | 11   | 0    | 10                    | 421  | 12   | 3    | 797        |
| 05:30 PM    | 8                     | 3    | 26   | 2    | 16                    | 174  | 12   | 0    | 29                    | 8    | 10   | 0    | 10                    | 403  | 8    | 0    | 709        |
| 05:45 PM    | 7                     | 7    | 17   | 0    | 19                    | 183  | 12   | 1    | 26                    | 4    | 9    | 2    | 22                    | 389  | 8    | 1    | 707        |
| Total       | 27                    | 26   | 84   | 3    | 64                    | 819  | 61   | 1    | 95                    | 24   | 36   | 6    | 53                    | 1675 | 40   | 4    | 3018       |
| Grand Total | 55                    | 47   | 152  | 7    | 111                   | 1646 | 108  | 6    | 162                   | 45   | 55   | 23   | 89                    | 3038 | 62   | 15   | 5621       |
| Apprch %    | 21.1                  | 18   | 58.2 | 2.7  | 5.9                   | 88   | 5.8  | 0.3  | 56.8                  | 15.8 | 19.3 | 8.1  | 2.8                   | 94.8 | 1.9  | 0.5  |            |
| Total %     | 1                     | 0.8  | 2.7  | 0.1  | 2                     | 29.3 | 1.9  | 0.1  | 2.9                   | 0.8  | 1    | 0.4  | 1.6                   | 54   | 1.1  | 0.3  |            |

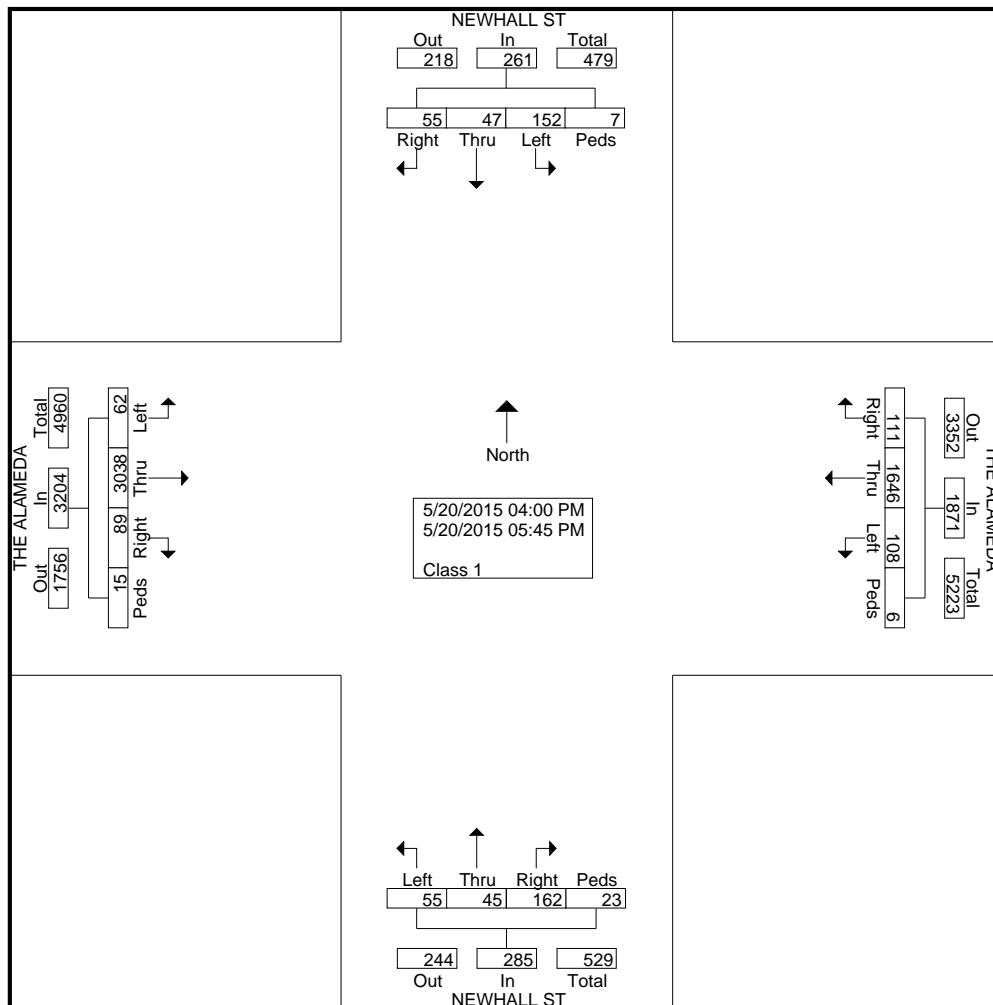

File Name : #14 ALAMEDA&NEWHALLPM  
 Site Code :  
 Start Date : 5/20/2015  
 Page No : 2

| Start Time  | NEWHALL ST Southbound |      |      |      |            | THE ALAMEDA Westbound |      |      |      |            | NEWHALL ST Northbound |      |      |      |            | THE ALAMEDA Eastbound |      |      |      |            | Int. Total |
|---|-----------------------|------|------|------|------------|-----------------------|------|------|------|------------|-----------------------|------|------|------|------------|-----------------------|------|------|------|------------|------------|
|   | Right                 | Thru | Left | Peds | App. Total | Right                 | Thru | Left | Peds | App. Total | Right                 | Thru | Left | Peds | App. Total | Right                 | Thru | Left | Peds | App. Total |            |
| <b>Peak Hour Analysis From 04:00 PM to 05:45 PM - Peak 1 of 1</b> |                       |      |      |      |            |                       |      |      |      |            |                       |      |      |      |            |                       |      |      |      |            |            |
| Peak Hour for Entire Intersection Begins at 05:00 PM              |                       |      |      |      |            |                       |      |      |      |            |                       |      |      |      |            |                       |      |      |      |            |            |
| 05:00 PM  | 4                     | 7    | 23   | 1    | 35         | 18                    | 217  | 17   | 0    | 252        | 18                    | 5    | 6    | 4    | 33         | 11                    | 462  | 12   | 0    | 485        | 805        |
| 05:15 PM  | 8                     | 9    | 18   | 0    | 35         | 11                    | 245  | 20   | 0    | 276        | 22                    | 7    | 11   | 0    | 40         | 10                    | 421  | 12   | 3    | 446        | 797        |
| 05:30 PM  | 8                     | 3    | 26   | 2    | 39         | 16                    | 174  | 12   | 0    | 202        | 29                    | 8    | 10   | 0    | 47         | 10                    | 403  | 8    | 0    | 421        | 709        |
| 05:45 PM  | 7                     | 7    | 17   | 0    | 31         | 19                    | 183  | 12   | 1    | 215        | 26                    | 4    | 9    | 2    | 41         | 22                    | 389  | 8    | 1    | 420        | 707        |
| Total Volume  | 27                    | 26   | 84   | 3    | 140        | 64                    | 819  | 61   | 1    | 945        | 95                    | 24   | 36   | 6    | 161        | 53                    | 1675 | 40   | 4    | 1772       | 3018       |
| % App. Total  | 19.3                  | 18.6 | 60   | 2.1  |            | 6.8                   | 86.7 | 6.5  | 0.1  |            | 5.9                   | 14.9 | 22.4 | 3.7  |            | 3                     | 94.5 | 2.3  | 0.2  |            |            |
| PHF   | .844                  | .722 | .808 | .375 | .897       | .842                  | .836 | .763 | .250 | .856       | .819                  | .750 | .818 | .375 | .856       | .602                  | .906 | .833 | .333 | .913       | .937       |

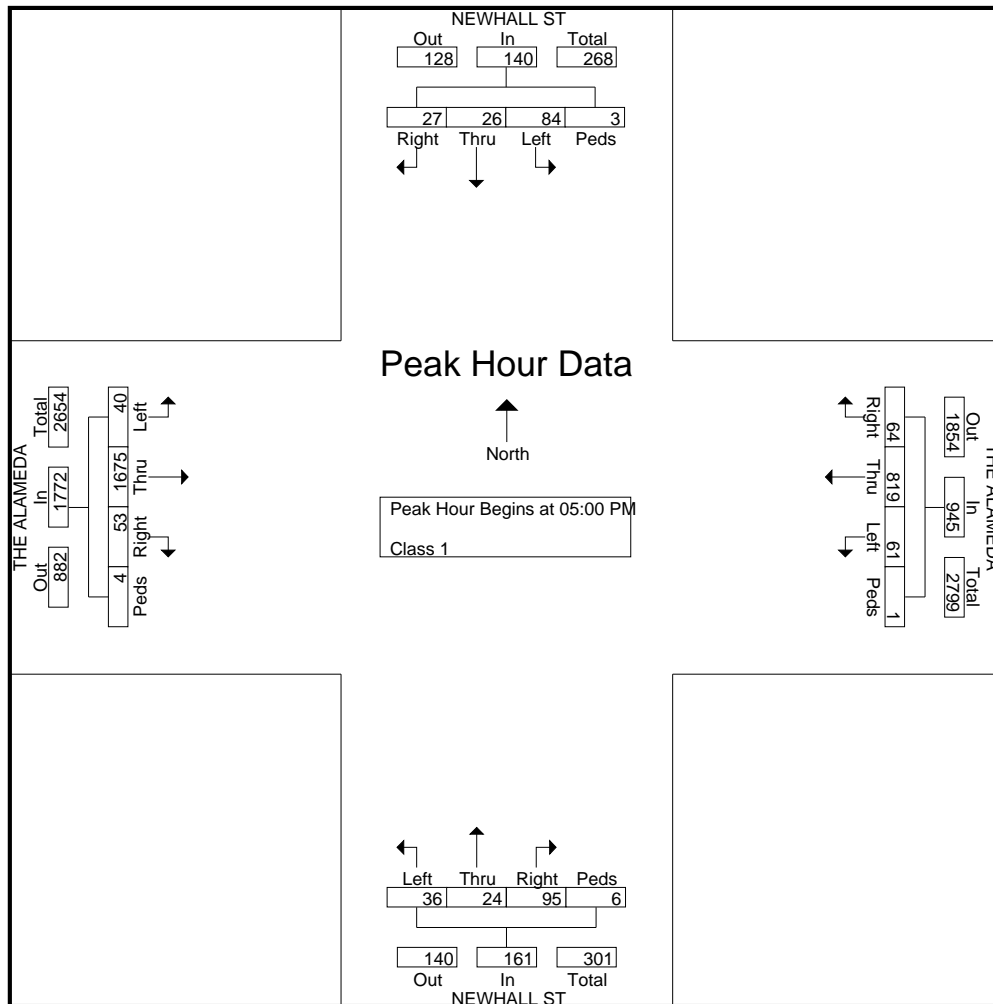

Groups Printed- Class 1

| Start Time  | LAFAYETTE ST Southbound |      |      |      | WALSH AVE Westbound |      |      |      | LAFAYETTE ST Northbound |      |      |      | WALSH AVE Eastbound |      |      |      | Int. Total |
|-------------|-------------------------|------|------|------|---------------------|------|------|------|-------------------------|------|------|------|---------------------|------|------|------|------------|
|             | Right                   | Thru | Left | Peds | Right               | Thru | Left | Peds | Right                   | Thru | Left | Peds | Right               | Thru | Left | Peds |            |
| 07:00 AM    | 20                      | 71   | 8    | 0    | 2                   | 5    | 2    | 1    | 1                       | 184  | 26   | 0    | 6                   | 1    | 13   | 2    | 342        |
| 07:15 AM    | 13                      | 73   | 3    | 0    | 4                   | 3    | 2    | 0    | 7                       | 272  | 19   | 0    | 9                   | 1    | 13   | 0    | 419        |
| 07:30 AM    | 16                      | 110  | 3    | 0    | 4                   | 0    | 3    | 0    | 1                       | 288  | 38   | 0    | 9                   | 4    | 13   | 0    | 489        |
| 07:45 AM    | 31                      | 130  | 4    | 0    | 1                   | 2    | 2    | 1    | 11                      | 335  | 44   | 0    | 10                  | 6    | 21   | 0    | 598        |
| Total       | 80                      | 384  | 18   | 0    | 11                  | 10   | 9    | 2    | 20                      | 1079 | 127  | 0    | 34                  | 12   | 60   | 2    | 1848       |
| 08:00 AM    | 13                      | 114  | 4    | 0    | 3                   | 5    | 3    | 0    | 5                       | 327  | 42   | 0    | 8                   | 2    | 26   | 0    | 552        |
| 08:15 AM    | 24                      | 119  | 6    | 0    | 5                   | 2    | 3    | 0    | 10                      | 319  | 41   | 0    | 14                  | 2    | 13   | 0    | 558        |
| 08:30 AM    | 24                      | 80   | 6    | 0    | 6                   | 1    | 4    | 0    | 5                       | 360  | 51   | 0    | 16                  | 2    | 25   | 0    | 580        |
| 08:45 AM    | 17                      | 124  | 8    | 0    | 5                   | 1    | 2    | 0    | 5                       | 323  | 43   | 0    | 9                   | 1    | 24   | 0    | 562        |
| Total       | 78                      | 437  | 24   | 0    | 19                  | 9    | 12   | 0    | 25                      | 1329 | 177  | 0    | 47                  | 7    | 88   | 0    | 2252       |
| Grand Total | 158                     | 821  | 42   | 0    | 30                  | 19   | 21   | 2    | 45                      | 2408 | 304  | 0    | 81                  | 19   | 148  | 2    | 4100       |
| Apprch %    | 15.5                    | 80.4 | 4.1  | 0    | 41.7                | 26.4 | 29.2 | 2.8  | 1.6                     | 87.3 | 11   | 0    | 32.4                | 7.6  | 59.2 | 0.8  |            |
| Total %     | 3.9                     | 20   | 1    | 0    | 0.7                 | 0.5  | 0.5  | 0    | 1.1                     | 58.7 | 7.4  | 0    | 2                   | 0.5  | 3.6  | 0    |            |

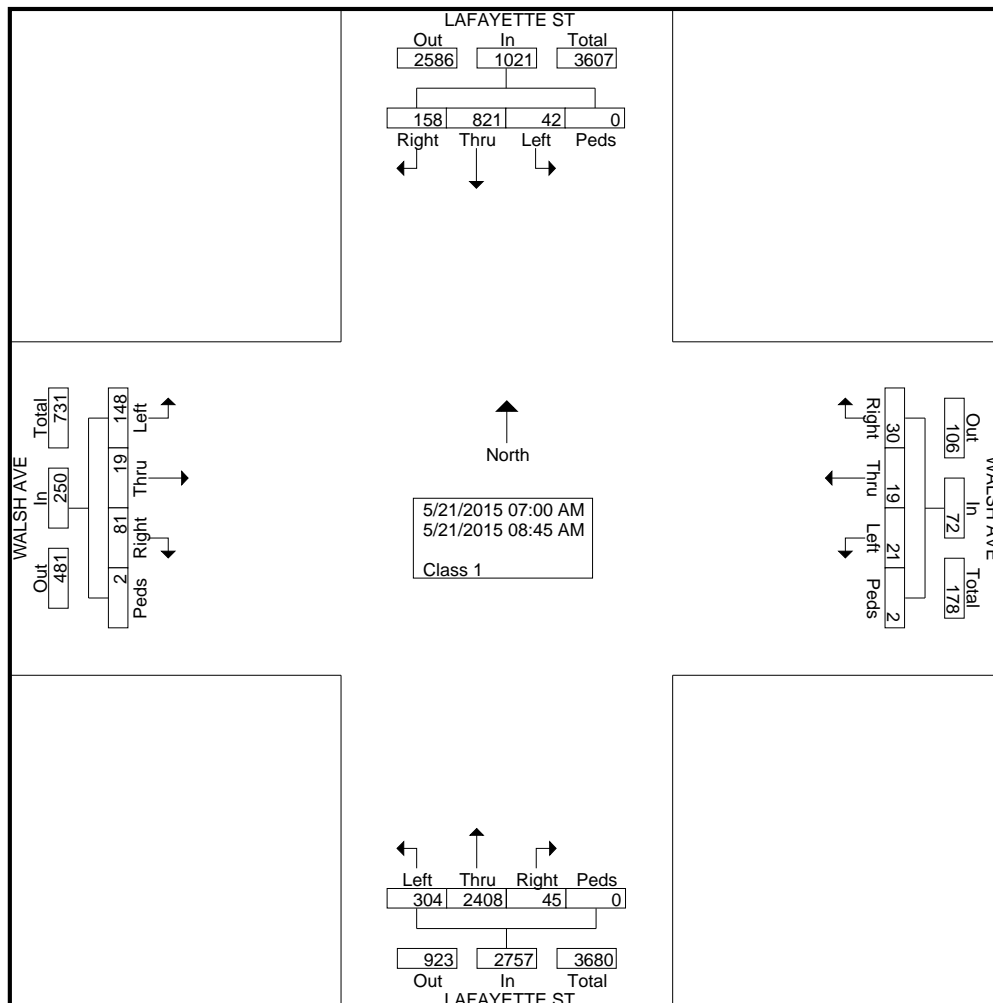

| Start Time  | LAFAYETTE ST Southbound |      |      |      |            | WALSH AVE Westbound |      |      |      |            | LAFAYETTE ST Northbound |      |      |      |            | WALSH AVE Eastbound |      |      |      |            | Int. Total |
|---|-------------------------|------|------|------|------------|---------------------|------|------|------|------------|-------------------------|------|------|------|------------|---------------------|------|------|------|------------|------------|
|   | Right                   | Thru | Left | Peds | App. Total | Right               | Thru | Left | Peds | App. Total | Right                   | Thru | Left | Peds | App. Total | Right               | Thru | Left | Peds | App. Total |            |
| <b>Peak Hour Analysis From 07:00 AM to 08:45 AM - Peak 1 of 1</b> |                         |      |      |      |            |                     |      |      |      |            |                         |      |      |      |            |                     |      |      |      |            |            |
| Peak Hour for Entire Intersection Begins at 07:45 AM              |                         |      |      |      |            |                     |      |      |      |            |                         |      |      |      |            |                     |      |      |      |            |            |
| 07:45 AM  | 31                      | 130  | 4    | 0    | 165        | 1                   | 2    | 2    | 1    | 6          | 11                      | 335  | 44   | 0    | 390        | 10                  | 6    | 21   | 0    | 37         | 598        |
| 08:00 AM  | 13                      | 114  | 4    | 0    | 131        | 3                   | 5    | 3    | 0    | 11         | 5                       | 327  | 42   | 0    | 374        | 8                   | 2    | 26   | 0    | 36         | 552        |
| 08:15 AM  | 24                      | 119  | 6    | 0    | 149        | 5                   | 2    | 3    | 0    | 10         | 10                      | 319  | 41   | 0    | 370        | 14                  | 2    | 13   | 0    | 29         | 558        |
| 08:30 AM  | 24                      | 80   | 6    | 0    | 110        | 6                   | 1    | 4    | 0    | 11         | 5                       | 360  | 51   | 0    | 416        | 16                  | 2    | 25   | 0    | 43         | 580        |
| Total Volume  | 92                      | 443  | 20   | 0    | 555        | 15                  | 10   | 12   | 1    | 38         | 31                      | 1341 | 178  | 0    | 1550       | 48                  | 12   | 85   | 0    | 145        | 2288       |
| % App. Total  | 16.6                    | 79.8 | 3.6  | 0    |            | 39.5                | 26.3 | 31.6 | 2.6  |            | 2                       | 86.5 | 11.5 | 0    |            | 33.1                | 8.3  | 58.6 | 0    |            |            |
| PHF   | .742                    | .852 | .833 | .000 | .841       | .625                | .500 | .750 | .250 | .864       | .705                    | .931 | .873 | .000 | .931       | .750                | .500 | .817 | .000 | .843       | .957       |

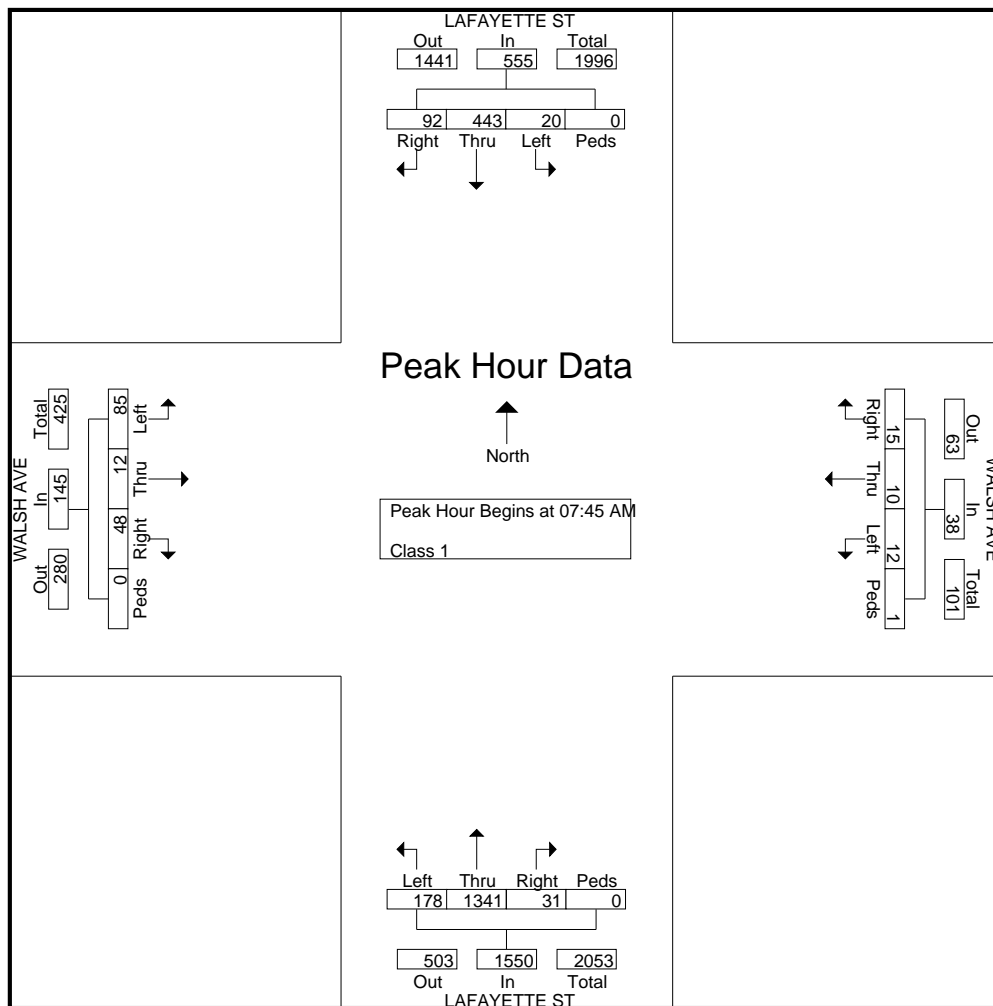



Groups Printed- Class 1

| Start Time  | LAFAYETTE ST Southbound |      |      |      | WALSH AVE Westbound |      |      |      | LAFAYETTE ST Northbound |      |      |      | WALSH AVE Eastbound |      |      |      | Int. Total |
|-------------|-------------------------|------|------|------|---------------------|------|------|------|-------------------------|------|------|------|---------------------|------|------|------|------------|
|             | Right                   | Thru | Left | Peds | Right               | Thru | Left | Peds | Right                   | Thru | Left | Peds | Right               | Thru | Left | Peds |            |
| 04:00 PM    | 17                      | 285  | 5    | 0    | 7                   | 4    | 3    | 0    | 2                       | 130  | 9    | 1    | 57                  | 4    | 21   | 0    | 545        |
| 04:15 PM    | 16                      | 278  | 3    | 0    | 10                  | 2    | 7    | 0    | 1                       | 114  | 9    | 0    | 52                  | 1    | 25   | 0    | 518        |
| 04:30 PM    | 17                      | 271  | 1    | 0    | 4                   | 6    | 6    | 1    | 2                       | 134  | 11   | 1    | 67                  | 2    | 39   | 0    | 562        |
| 04:45 PM    | 21                      | 353  | 1    | 0    | 3                   | 2    | 8    | 0    | 0                       | 113  | 9    | 0    | 45                  | 4    | 33   | 0    | 592        |
| Total       | 71                      | 1187 | 10   | 0    | 24                  | 14   | 24   | 1    | 5                       | 491  | 38   | 2    | 221                 | 11   | 118  | 0    | 2217       |
| 05:00 PM    | 22                      | 378  | 2    | 1    | 5                   | 2    | 7    | 0    | 1                       | 134  | 11   | 0    | 72                  | 2    | 36   | 0    | 673        |
| 05:15 PM    | 31                      | 355  | 2    | 0    | 2                   | 1    | 5    | 0    | 2                       | 134  | 6    | 0    | 57                  | 2    | 39   | 0    | 636        |
| 05:30 PM    | 17                      | 348  | 3    | 0    | 5                   | 2    | 8    | 0    | 2                       | 107  | 8    | 0    | 85                  | 1    | 37   | 0    | 623        |
| 05:45 PM    | 25                      | 402  | 2    | 0    | 0                   | 0    | 5    | 0    | 1                       | 105  | 11   | 0    | 74                  | 4    | 35   | 0    | 664        |
| Total       | 95                      | 1483 | 9    | 1    | 12                  | 5    | 25   | 0    | 6                       | 480  | 36   | 0    | 288                 | 9    | 147  | 0    | 2596       |
| Grand Total | 166                     | 2670 | 19   | 1    | 36                  | 19   | 49   | 1    | 11                      | 971  | 74   | 2    | 509                 | 20   | 265  | 0    | 4813       |
| Apprch %    | 5.8                     | 93.5 | 0.7  | 0    | 34.3                | 18.1 | 46.7 | 1    | 1                       | 91.8 | 7    | 0.2  | 64.1                | 2.5  | 33.4 | 0    |            |
| Total %     | 3.4                     | 55.5 | 0.4  | 0    | 0.7                 | 0.4  | 1    | 0    | 0.2                     | 20.2 | 1.5  | 0    | 10.6                | 0.4  | 5.5  | 0    |            |

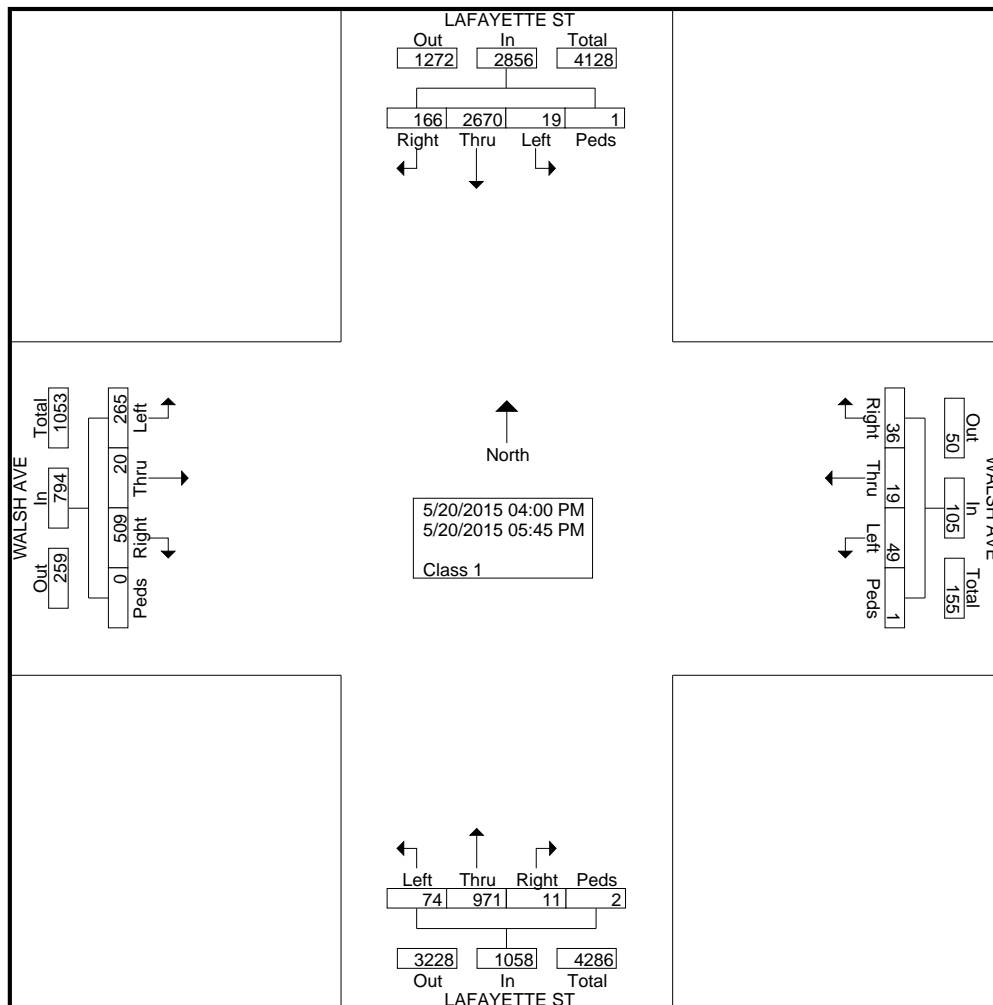

File Name : #15 LAFAYETTE&WALSHPM  
 Site Code :  
 Start Date : 5/20/2015  
 Page No : 2

| Start Time  | LAFAYETTE ST Southbound |      |      |      |            | WALSH AVE Westbound |      |      |      |            | LAFAYETTE ST Northbound |      |      |      |            | WALSH AVE Eastbound |      |      |      |            | Int. Total |
|---|-------------------------|------|------|------|------------|---------------------|------|------|------|------------|-------------------------|------|------|------|------------|---------------------|------|------|------|------------|------------|
|   | Right                   | Thru | Left | Peds | App. Total | Right               | Thru | Left | Peds | App. Total | Right                   | Thru | Left | Peds | App. Total | Right               | Thru | Left | Peds | App. Total |            |
| <b>Peak Hour Analysis From 04:00 PM to 05:45 PM - Peak 1 of 1</b> |                         |      |      |      |            |                     |      |      |      |            |                         |      |      |      |            |                     |      |      |      |            |            |
| Peak Hour for Entire Intersection Begins at 05:00 PM              |                         |      |      |      |            |                     |      |      |      |            |                         |      |      |      |            |                     |      |      |      |            |            |
| 05:00 PM  | 22                      | 378  | 2    | 1    | 403        | 5                   | 2    | 7    | 0    | 14         | 1                       | 134  | 11   | 0    | 146        | 72                  | 2    | 36   | 0    | 110        | 673        |
| 05:15 PM  | 31                      | 355  | 2    | 0    | 388        | 2                   | 1    | 5    | 0    | 8          | 2                       | 134  | 6    | 0    | 142        | 57                  | 2    | 39   | 0    | 98         | 636        |
| 05:30 PM  | 17                      | 348  | 3    | 0    | 368        | 5                   | 2    | 8    | 0    | 15         | 2                       | 107  | 8    | 0    | 117        | 85                  | 1    | 37   | 0    | 123        | 623        |
| 05:45 PM  | 25                      | 402  | 2    | 0    | 429        | 0                   | 0    | 5    | 0    | 5          | 1                       | 105  | 11   | 0    | 117        | 74                  | 4    | 35   | 0    | 113        | 664        |
| Total Volume  | 95                      | 1483 | 9    | 1    | 1588       | 12                  | 5    | 25   | 0    | 42         | 6                       | 480  | 36   | 0    | 522        | 288                 | 9    | 147  | 0    | 444        | 2596       |
| % App. Total  | 6                       | 93.4 | 0.6  | 0.1  |            | 28.6                | 11.9 | 59.5 | 0    |            | 1.1                     | 92   | 6.9  | 0    |            | 64.9                | 2    | 33.1 | 0    |            |            |
| PHF   | .766                    | .922 | .750 | .250 | .925       | .600                | .625 | .781 | .000 | .700       | .750                    | .896 | .818 | .000 | .894       | .847                | .563 | .942 | .000 | .902       | .964       |

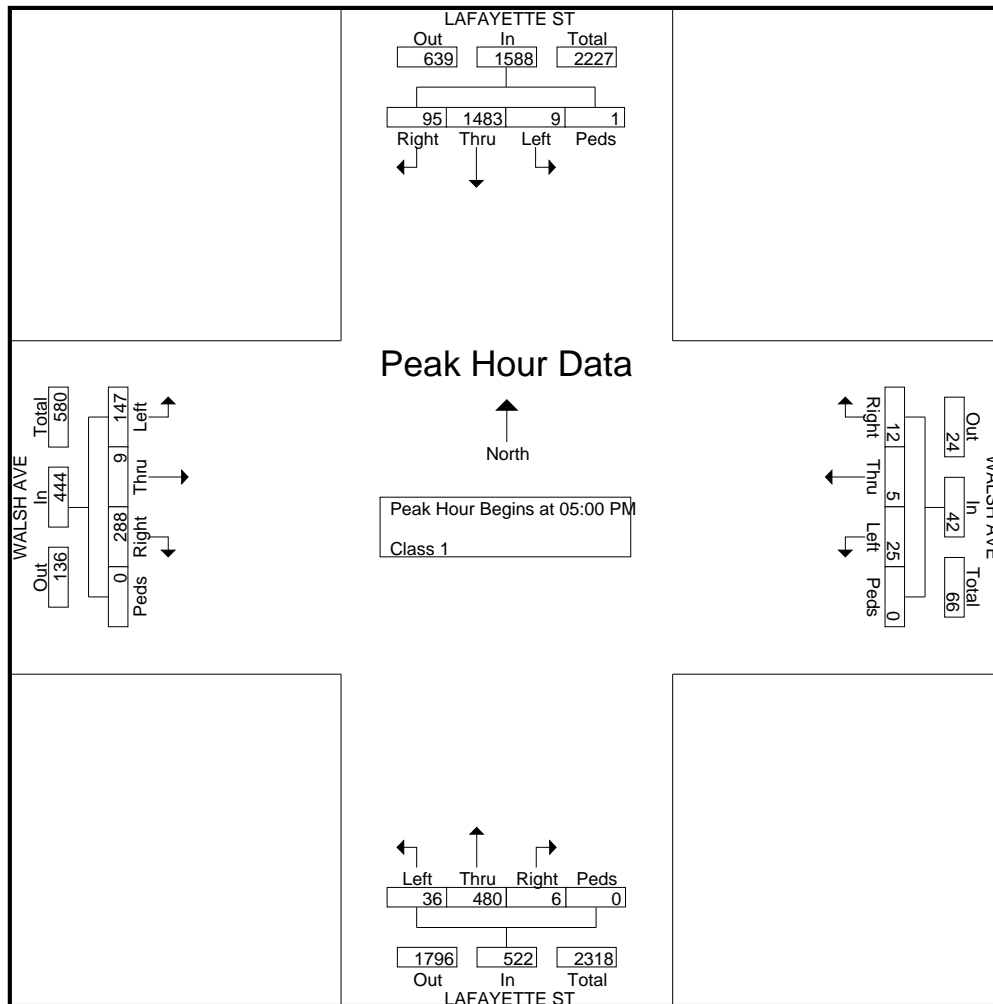

File Name : #16 ALMADEN&SANTA CLARA AM  
 Site Code : 16  
 Start Date : 5/6/2015  
 Page No : 1

Groups Printed- Class 1

| Start Time  | NOTRE DAME AVE<br>Southbound |      |      |      | SANTA CLARA ST<br>Westbound |      |      |      | ALMADEN BLVD E<br>Northbound |      |      |      | SANTA CLARA ST<br>Eastbound |      |      |      | Int. Total |
|-------------|------------------------------|------|------|------|-----------------------------|------|------|------|------------------------------|------|------|------|-----------------------------|------|------|------|------------|
|             | Right                        | Thru | Left | Peds | Right                       | Thru | Left | Peds | Right                        | Thru | Left | Peds | Right                       | Thru | Left | Peds |            |
| 07:00 AM    | 0                            | 0    | 0    | 11   | 11                          | 65   | 5    | 0    | 18                           | 48   | 22   | 3    | 0                           | 123  | 26   | 0    | 332        |
| 07:15 AM    | 0                            | 0    | 0    | 17   | 12                          | 112  | 6    | 1    | 17                           | 84   | 32   | 7    | 0                           | 164  | 29   | 0    | 481        |
| 07:30 AM    | 0                            | 0    | 0    | 15   | 14                          | 99   | 8    | 5    | 24                           | 119  | 45   | 11   | 0                           | 194  | 42   | 0    | 576        |
| 07:45 AM    | 0                            | 0    | 0    | 22   | 22                          | 124  | 23   | 5    | 25                           | 100  | 35   | 23   | 0                           | 242  | 39   | 0    | 660        |
| Total       | 0                            | 0    | 0    | 65   | 59                          | 400  | 42   | 11   | 84                           | 351  | 134  | 44   | 0                           | 723  | 136  | 0    | 2049       |
| 08:00 AM    | 0                            | 0    | 0    | 23   | 20                          | 101  | 17   | 1    | 31                           | 145  | 43   | 16   | 0                           | 257  | 43   | 0    | 697        |
| 08:15 AM    | 0                            | 0    | 0    | 22   | 22                          | 90   | 9    | 3    | 34                           | 95   | 30   | 13   | 0                           | 247  | 44   | 1    | 610        |
| 08:30 AM    | 0                            | 0    | 0    | 48   | 21                          | 71   | 17   | 8    | 43                           | 111  | 42   | 15   | 0                           | 272  | 40   | 0    | 688        |
| 08:45 AM    | 0                            | 0    | 0    | 19   | 16                          | 75   | 17   | 4    | 24                           | 108  | 27   | 15   | 0                           | 248  | 28   | 0    | 581        |
| Total       | 0                            | 0    | 0    | 112  | 79                          | 337  | 60   | 16   | 132                          | 459  | 142  | 59   | 0                           | 1024 | 155  | 1    | 2576       |
| Grand Total | 0                            | 0    | 0    | 177  | 138                         | 737  | 102  | 27   | 216                          | 810  | 276  | 103  | 0                           | 1747 | 291  | 1    | 4625       |
| Apprch %    | 0                            | 0    | 0    | 100  | 13.7                        | 73.4 | 10.2 | 2.7  | 15.4                         | 57.7 | 19.6 | 7.3  | 0                           | 85.7 | 14.3 | 0    |            |
| Total %     | 0                            | 0    | 0    | 3.8  | 3                           | 15.9 | 2.2  | 0.6  | 4.7                          | 17.5 | 6    | 2.2  | 0                           | 37.8 | 6.3  | 0    |            |

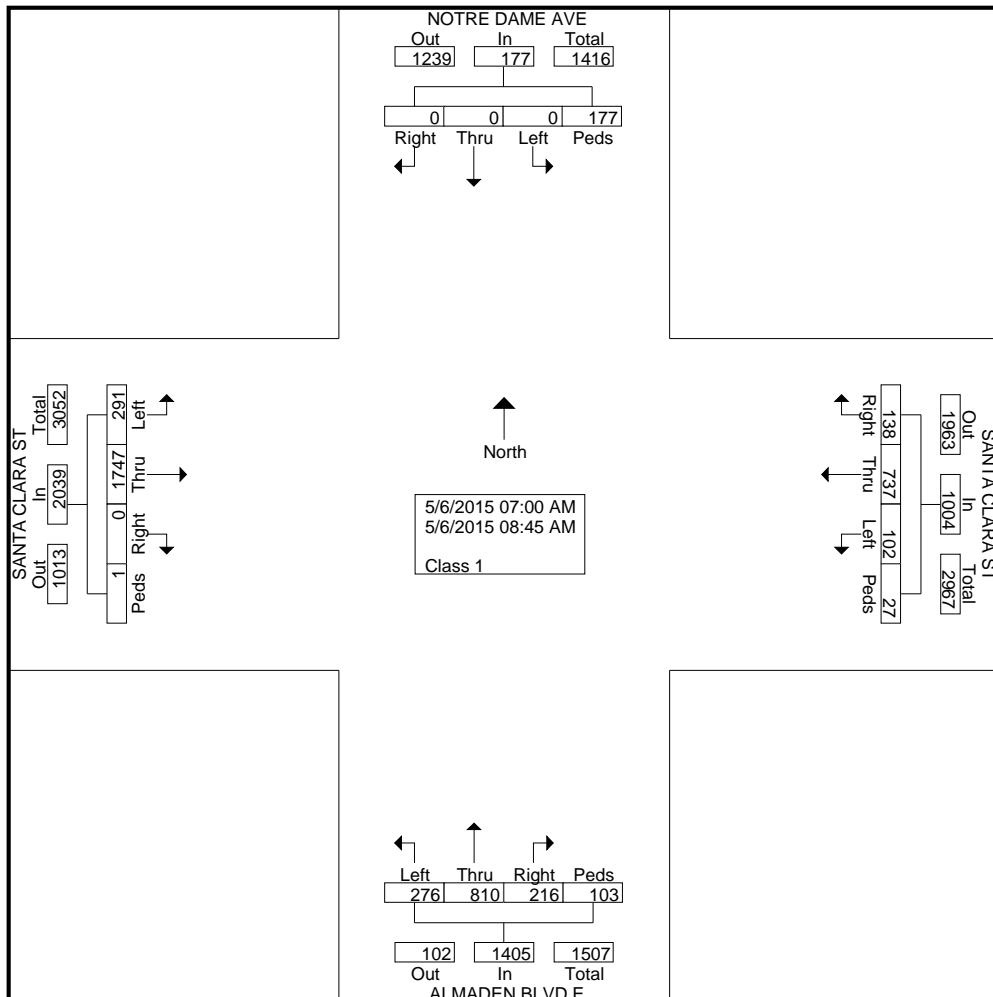

File Name : #16 ALMADEN&SANTA CLARA AM  
 Site Code : 16  
 Start Date : 5/6/2015  
 Page No : 2

| Start Time  | NOTRE DAME AVE Southbound |      |      |      |            | SANTA CLARA ST Westbound |      |      |      |            | ALMADEN BLVD E Northbound |      |      |      |            | SANTA CLARA ST Eastbound |      |      |      |            | Int. Total |
|---|---------------------------|------|------|------|------------|--------------------------|------|------|------|------------|---------------------------|------|------|------|------------|--------------------------|------|------|------|------------|------------|
|   | Right                     | Thru | Left | Peds | App. Total | Right                    | Thru | Left | Peds | App. Total | Right                     | Thru | Left | Peds | App. Total | Right                    | Thru | Left | Peds | App. Total |            |
| <b>Peak Hour Analysis From 07:00 AM to 08:45 AM - Peak 1 of 1</b> |                           |      |      |      |            |                          |      |      |      |            |                           |      |      |      |            |                          |      |      |      |            |            |
| Peak Hour for Entire Intersection Begins at 07:45 AM              |                           |      |      |      |            |                          |      |      |      |            |                           |      |      |      |            |                          |      |      |      |            |            |
| 07:45 AM  | 0                         | 0    | 0    | 22   | 22         | 22                       | 124  | 23   | 5    | 174        | 25                        | 100  | 35   | 23   | 183        | 0                        | 242  | 39   | 0    | 281        | 660        |
| 08:00 AM  | 0                         | 0    | 0    | 23   | 23         | 20                       | 101  | 17   | 1    | 139        | 31                        | 145  | 43   | 16   | 235        | 0                        | 257  | 43   | 0    | 300        | 697        |
| 08:15 AM  | 0                         | 0    | 0    | 22   | 22         | 22                       | 90   | 9    | 3    | 124        | 34                        | 95   | 30   | 13   | 172        | 0                        | 247  | 44   | 1    | 292        | 610        |
| 08:30 AM  | 0                         | 0    | 0    | 48   | 48         | 21                       | 71   | 17   | 8    | 117        | 43                        | 111  | 42   | 15   | 211        | 0                        | 272  | 40   | 0    | 312        | 688        |
| Total Volume  | 0                         | 0    | 0    | 115  | 115        | 85                       | 386  | 66   | 17   | 554        | 133                       | 451  | 150  | 67   | 801        | 0                        | 1018 | 166  | 1    | 1185       | 2655       |
| % App. Total  | 0                         | 0    | 0    | 100  |            | 15.3                     | 69.7 | 11.9 | 3.1  |            | 16.6                      | 56.3 | 18.7 | 8.4  |            | 0                        | 85.9 | 14   | 0.1  |            |            |
| PHF   | .000                      | .000 | .000 | .599 | .599       | .966                     | .778 | .717 | .531 | .796       | .773                      | .778 | .872 | .728 | .852       | .000                     | .936 | .943 | .250 | .950       | .952       |

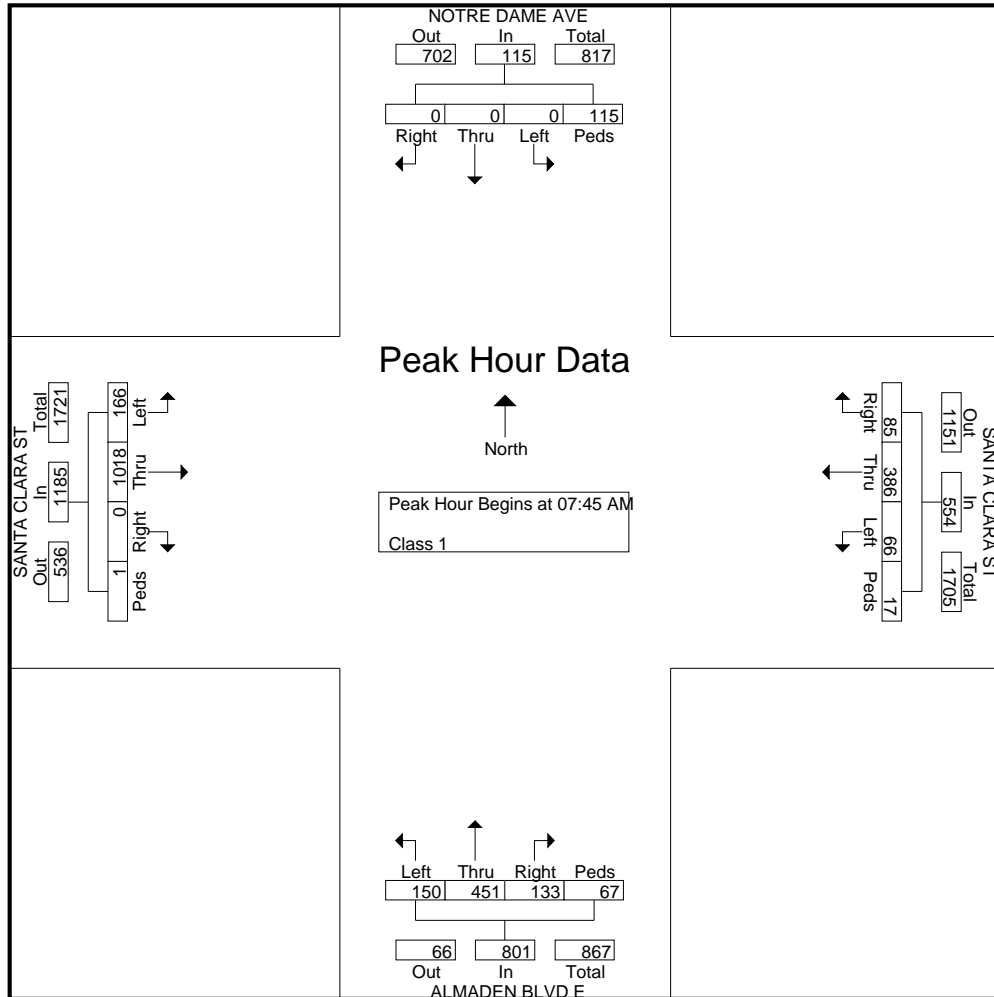

File Name : #16 ALMADEN&SANTA CLARA PM  
 Site Code : 16  
 Start Date : 5/5/2015  
 Page No : 1

Groups Printed- Class 1

| Start Time  | NOTRE DAME AVE Southbound |      |      |      | SANTA CLARA ST Westbound |      |      |      | ALMADEN BLVD E Northbound |      |      |      | SANTA CLARA ST Eastbound |      |      |      | Int. Total |
|-------------|---------------------------|------|------|------|--------------------------|------|------|------|---------------------------|------|------|------|--------------------------|------|------|------|------------|
|             | Right                     | Thru | Left | Peds | Right                    | Thru | Left | Peds | Right                     | Thru | Left | Peds | Right                    | Thru | Left | Peds |            |
| 04:00 PM    | 0                         | 0    | 0    | 16   | 20                       | 66   | 21   | 2    | 19                        | 51   | 14   | 11   | 0                        | 183  | 14   | 0    | 417        |
| 04:15 PM    | 0                         | 0    | 0    | 25   | 19                       | 93   | 28   | 1    | 17                        | 43   | 18   | 9    | 0                        | 152  | 19   | 0    | 424        |
| 04:30 PM    | 0                         | 0    | 0    | 30   | 37                       | 68   | 26   | 5    | 21                        | 48   | 22   | 13   | 0                        | 153  | 24   | 0    | 447        |
| 04:45 PM    | 0                         | 0    | 0    | 20   | 28                       | 98   | 30   | 9    | 23                        | 40   | 25   | 14   | 0                        | 201  | 31   | 0    | 519        |
| Total       | 0                         | 0    | 0    | 91   | 104                      | 325  | 105  | 17   | 80                        | 182  | 79   | 47   | 0                        | 689  | 88   | 0    | 1807       |
| 05:00 PM    | 0                         | 0    | 0    | 42   | 34                       | 98   | 36   | 12   | 26                        | 75   | 36   | 28   | 4                        | 188  | 36   | 0    | 615        |
| 05:15 PM    | 0                         | 0    | 0    | 37   | 42                       | 90   | 42   | 5    | 33                        | 56   | 38   | 21   | 0                        | 223  | 31   | 1    | 619        |
| 05:30 PM    | 0                         | 0    | 0    | 30   | 43                       | 77   | 37   | 9    | 23                        | 47   | 24   | 18   | 2                        | 220  | 27   | 0    | 557        |
| 05:45 PM    | 0                         | 0    | 0    | 37   | 26                       | 95   | 34   | 16   | 26                        | 49   | 20   | 19   | 0                        | 171  | 20   | 0    | 513        |
| Total       | 0                         | 0    | 0    | 146  | 145                      | 360  | 149  | 42   | 108                       | 227  | 118  | 86   | 6                        | 802  | 114  | 1    | 2304       |
| Grand Total | 0                         | 0    | 0    | 237  | 249                      | 685  | 254  | 59   | 188                       | 409  | 197  | 133  | 6                        | 1491 | 202  | 1    | 4111       |
| Apprch %    | 0                         | 0    | 0    | 100  | 20                       | 54.9 | 20.4 | 4.7  | 20.3                      | 44.1 | 21.3 | 14.3 | 0.4                      | 87.7 | 11.9 | 0.1  |            |
| Total %     | 0                         | 0    | 0    | 5.8  | 6.1                      | 16.7 | 6.2  | 1.4  | 4.6                       | 9.9  | 4.8  | 3.2  | 0.1                      | 36.3 | 4.9  | 0    |            |

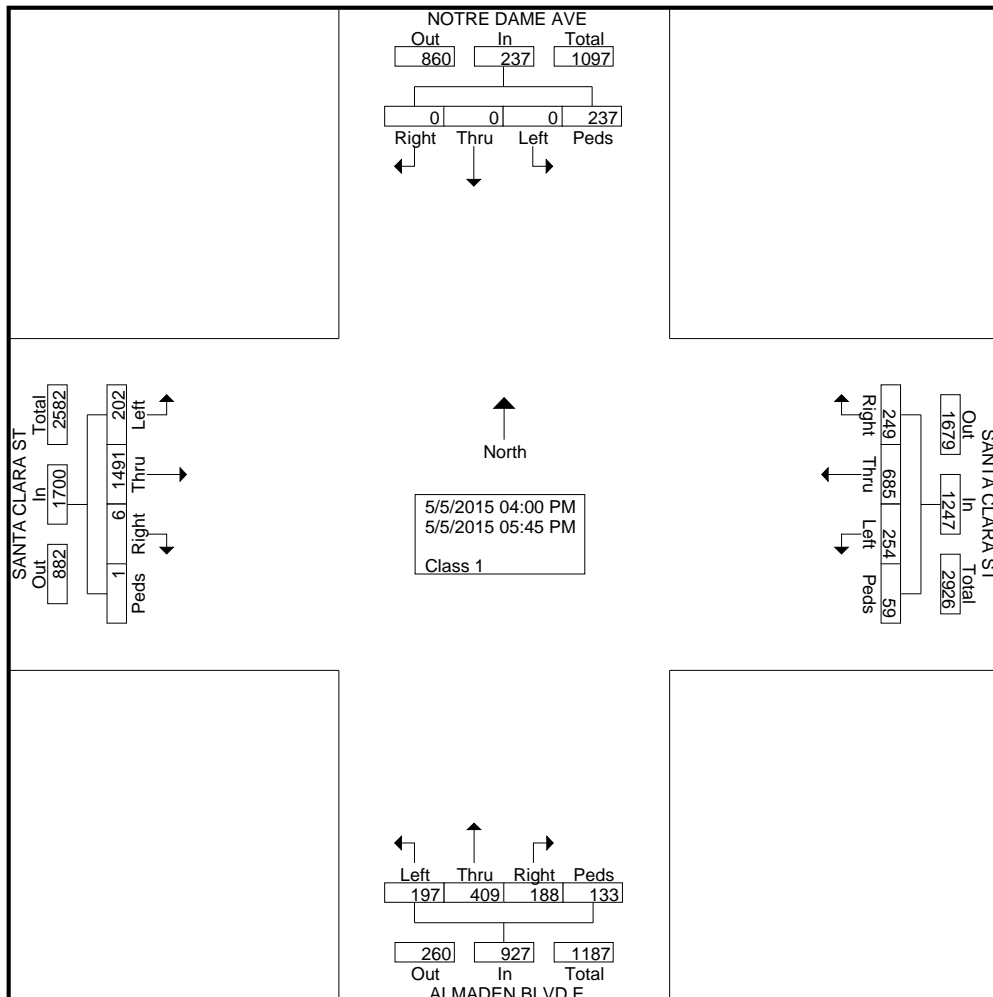

File Name : #16 ALMADEN&SANTA CLARA PM  
 Site Code : 16  
 Start Date : 5/5/2015  
 Page No : 2

| Start Time  | NOTRE DAME AVE Southbound |      |      |      |            | SANTA CLARA ST Westbound |      |      |      |            | ALMADEN BLVD E Northbound |      |      |      |            | SANTA CLARA ST Eastbound |      |      |      |            | Int. Total |
|---|---------------------------|------|------|------|------------|--------------------------|------|------|------|------------|---------------------------|------|------|------|------------|--------------------------|------|------|------|------------|------------|
|   | Right                     | Thru | Left | Peds | App. Total | Right                    | Thru | Left | Peds | App. Total | Right                     | Thru | Left | Peds | App. Total | Right                    | Thru | Left | Peds | App. Total |            |
| <b>Peak Hour Analysis From 04:00 PM to 05:45 PM - Peak 1 of 1</b> |                           |      |      |      |            |                          |      |      |      |            |                           |      |      |      |            |                          |      |      |      |            |            |
| Peak Hour for Entire Intersection Begins at 04:45 PM              |                           |      |      |      |            |                          |      |      |      |            |                           |      |      |      |            |                          |      |      |      |            |            |
| 04:45 PM  | 0                         | 0    | 0    | 20   | 20         | 28                       | 98   | 30   | 9    | 165        | 23                        | 40   | 25   | 14   | 102        | 0                        | 201  | 31   | 0    | 232        | 519        |
| 05:00 PM  | 0                         | 0    | 0    | 42   | 42         | 34                       | 98   | 36   | 12   | 180        | 26                        | 75   | 36   | 28   | 165        | 4                        | 188  | 36   | 0    | 228        | 615        |
| 05:15 PM  | 0                         | 0    | 0    | 37   | 37         | 42                       | 90   | 42   | 5    | 179        | 33                        | 56   | 38   | 21   | 148        | 0                        | 223  | 31   | 1    | 255        | 619        |
| 05:30 PM  | 0                         | 0    | 0    | 30   | 30         | 43                       | 77   | 37   | 9    | 166        | 23                        | 47   | 24   | 18   | 112        | 2                        | 220  | 27   | 0    | 249        | 557        |
| Total Volume  | 0                         | 0    | 0    | 129  | 129        | 147                      | 363  | 145  | 35   | 690        | 105                       | 218  | 123  | 81   | 527        | 6                        | 832  | 125  | 1    | 964        | 2310       |
| % App. Total  | 0                         | 0    | 0    | 100  |            | 21.3                     | 52.6 | 21   | 5.1  |            | 19.9                      | 41.4 | 23.3 | 15.4 |            | 0.6                      | 86.3 | 13   | 0.1  |            |            |
| PHF   | .000                      | .000 | .000 | .768 | .768       | .855                     | .926 | .863 | .729 | .958       | .795                      | .727 | .809 | .723 | .798       | .375                     | .933 | .868 | .250 | .945       | .933       |

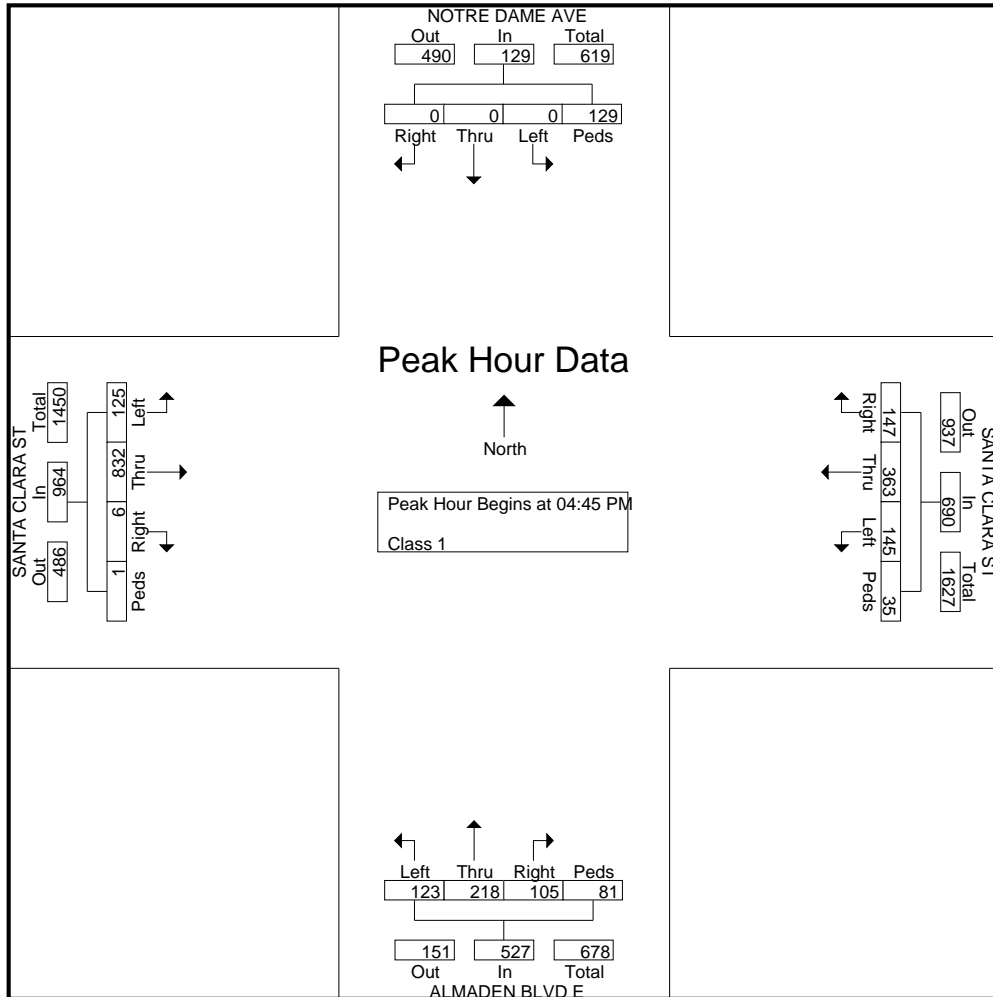

Groups Printed- Class 1

| Start Time  | LAFAYETTE ST Southbound |      |      |      | MARTIN AVE Westbound |      |      |      | LAFAYETTE ST Northbound |      |      |      | MARTIN AVE Eastbound |      |      |      | Int. Total |
|-------------|-------------------------|------|------|------|----------------------|------|------|------|-------------------------|------|------|------|----------------------|------|------|------|------------|
|             | Right                   | Thru | Left | Peds | Right                | Thru | Left | Peds | Right                   | Thru | Left | Peds | Right                | Thru | Left | Peds |            |
| 07:00 AM    | 15                      | 60   | 14   | 0    | 23                   | 37   | 16   | 1    | 16                      | 197  | 13   | 2    | 0                    | 8    | 13   | 0    | 415        |
| 07:15 AM    | 12                      | 59   | 11   | 0    | 29                   | 32   | 21   | 0    | 19                      | 249  | 17   | 4    | 3                    | 20   | 11   | 0    | 487        |
| 07:30 AM    | 13                      | 82   | 15   | 0    | 38                   | 75   | 16   | 0    | 19                      | 289  | 18   | 0    | 4                    | 19   | 11   | 0    | 599        |
| 07:45 AM    | 8                       | 97   | 21   | 0    | 55                   | 92   | 21   | 0    | 22                      | 321  | 17   | 1    | 7                    | 23   | 7    | 0    | 692        |
| Total       | 48                      | 298  | 61   | 0    | 145                  | 236  | 74   | 1    | 76                      | 1056 | 65   | 7    | 14                   | 70   | 42   | 0    | 2193       |
| 08:00 AM    | 10                      | 122  | 23   | 0    | 56                   | 69   | 20   | 0    | 25                      | 300  | 19   | 0    | 9                    | 28   | 11   | 1    | 693        |
| 08:15 AM    | 9                       | 91   | 21   | 0    | 49                   | 69   | 11   | 0    | 30                      | 332  | 23   | 1    | 9                    | 25   | 16   | 0    | 686        |
| 08:30 AM    | 7                       | 76   | 15   | 0    | 50                   | 77   | 11   | 0    | 23                      | 365  | 25   | 0    | 11                   | 24   | 10   | 0    | 694        |
| 08:45 AM    | 12                      | 102  | 21   | 0    | 48                   | 63   | 18   | 0    | 17                      | 323  | 21   | 1    | 16                   | 22   | 16   | 0    | 680        |
| Total       | 38                      | 391  | 80   | 0    | 203                  | 278  | 60   | 0    | 95                      | 1320 | 88   | 2    | 45                   | 99   | 53   | 1    | 2753       |
| Grand Total | 86                      | 689  | 141  | 0    | 348                  | 514  | 134  | 1    | 171                     | 2376 | 153  | 9    | 59                   | 169  | 95   | 1    | 4946       |
| Apprch %    | 9.4                     | 75.2 | 15.4 | 0    | 34.9                 | 51.6 | 13.4 | 0.1  | 6.3                     | 87.7 | 5.6  | 0.3  | 18.2                 | 52.2 | 29.3 | 0.3  |            |
| Total %     | 1.7                     | 13.9 | 2.9  | 0    | 7                    | 10.4 | 2.7  | 0    | 3.5                     | 48   | 3.1  | 0.2  | 1.2                  | 3.4  | 1.9  | 0    |            |

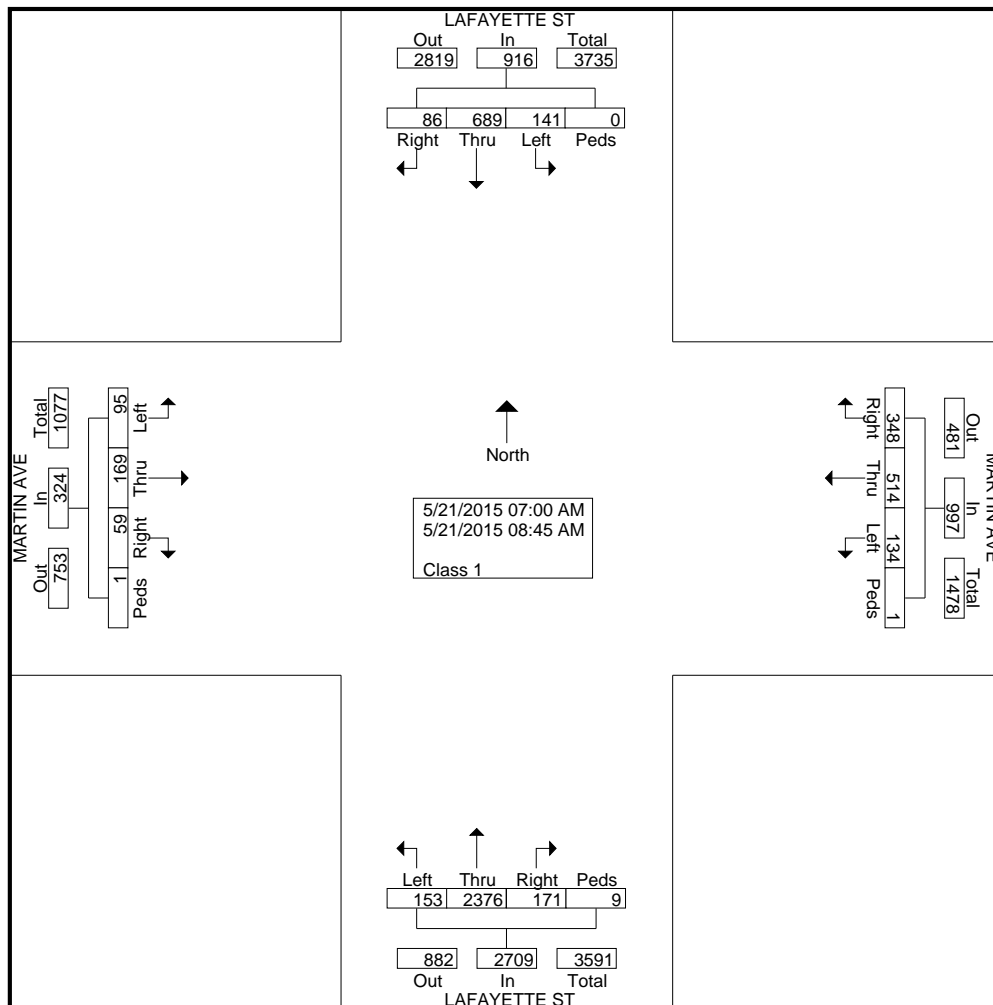

File Name : #16 LAFAYETTE&MARTINAM  
 Site Code :  
 Start Date : 5/21/2015  
 Page No : 2

| Start Time  | LAFAYETTE ST Southbound |      |      |      |            | MARTIN AVE Westbound |      |      |      |            | LAFAYETTE ST Northbound |      |      |      |            | MARTIN AVE Eastbound |      |      |      |            | Int. Total |
|---|-------------------------|------|------|------|------------|----------------------|------|------|------|------------|-------------------------|------|------|------|------------|----------------------|------|------|------|------------|------------|
|   | Right                   | Thru | Left | Peds | App. Total | Right                | Thru | Left | Peds | App. Total | Right                   | Thru | Left | Peds | App. Total | Right                | Thru | Left | Peds | App. Total |            |
| <b>Peak Hour Analysis From 07:00 AM to 08:45 AM - Peak 1 of 1</b> |                         |      |      |      |            |                      |      |      |      |            |                         |      |      |      |            |                      |      |      |      |            |            |
| Peak Hour for Entire Intersection Begins at 07:45 AM              |                         |      |      |      |            |                      |      |      |      |            |                         |      |      |      |            |                      |      |      |      |            |            |
| 07:45 AM  | 8                       | 97   | 21   | 0    | 126        | 55                   | 92   | 21   | 0    | 168        | 22                      | 321  | 17   | 1    | 361        | 7                    | 23   | 7    | 0    | 37         | 692        |
| 08:00 AM  | 10                      | 122  | 23   | 0    | 155        | 56                   | 69   | 20   | 0    | 145        | 25                      | 300  | 19   | 0    | 344        | 9                    | 28   | 11   | 1    | 49         | 693        |
| 08:15 AM  | 9                       | 91   | 21   | 0    | 121        | 49                   | 69   | 11   | 0    | 129        | 30                      | 332  | 23   | 1    | 386        | 9                    | 25   | 16   | 0    | 50         | 686        |
| 08:30 AM  | 7                       | 76   | 15   | 0    | 98         | 50                   | 77   | 11   | 0    | 138        | 23                      | 365  | 25   | 0    | 413        | 11                   | 24   | 10   | 0    | 45         | 694        |
| Total Volume  | 34                      | 386  | 80   | 0    | 500        | 210                  | 307  | 63   | 0    | 580        | 100                     | 1318 | 84   | 2    | 1504       | 36                   | 100  | 44   | 1    | 181        | 2765       |
| % App. Total  | 6.8                     | 77.2 | 16   | 0    |            | 36.2                 | 52.9 | 10.9 | 0    |            | 6.6                     | 87.6 | 5.6  | 0.1  |            | 19.9                 | 55.2 | 24.3 | 0.6  |            |            |
| PHF   | .850                    | .791 | .870 | .000 | .806       | .938                 | .834 | .750 | .000 | .863       | .833                    | .903 | .840 | .500 | .910       | .818                 | .893 | .688 | .250 | .905       | .996       |

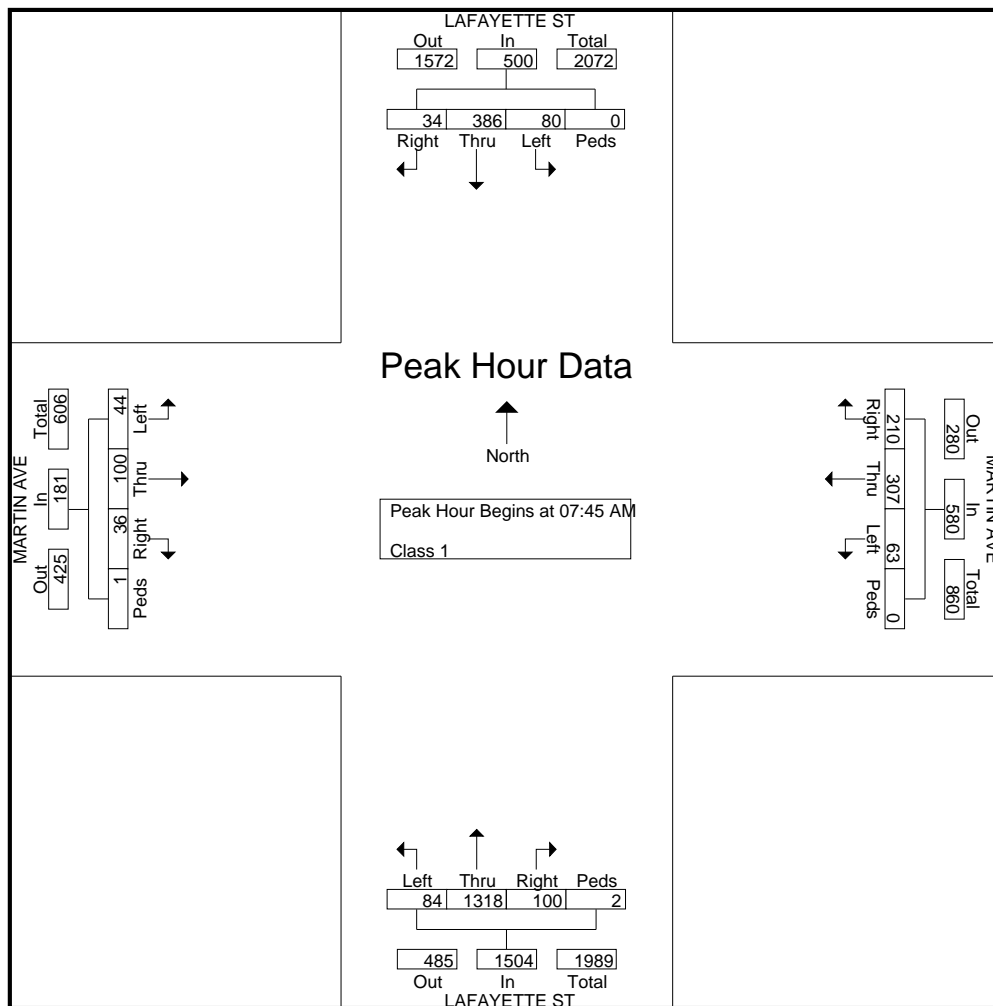



Groups Printed- Class 1

| Start Time  | LAFAYETTE ST Southbound |      |      |      | MARTIN AVE Westbound |      |      |      | LAFAYETTE ST Northbound |      |      |      | MARTIN AVE Eastbound |      |      |      | Int. Total |
|-------------|-------------------------|------|------|------|----------------------|------|------|------|-------------------------|------|------|------|----------------------|------|------|------|------------|
|             | Right                   | Thru | Left | Peds | Right                | Thru | Left | Peds | Right                   | Thru | Left | Peds | Right                | Thru | Left | Peds |            |
| 04:00 PM    | 14                      | 241  | 64   | 1    | 14                   | 7    | 9    | 1    | 28                      | 113  | 11   | 1    | 31                   | 51   | 9    | 0    | 595        |
| 04:15 PM    | 13                      | 271  | 61   | 0    | 14                   | 14   | 26   | 1    | 21                      | 97   | 4    | 3    | 21                   | 46   | 9    | 1    | 602        |
| 04:30 PM    | 18                      | 288  | 51   | 0    | 17                   | 20   | 24   | 0    | 22                      | 108  | 2    | 1    | 20                   | 64   | 14   | 1    | 650        |
| 04:45 PM    | 17                      | 313  | 46   | 0    | 10                   | 20   | 22   | 0    | 13                      | 103  | 8    | 0    | 11                   | 49   | 11   | 0    | 623        |
| Total       | 62                      | 1113 | 222  | 1    | 55                   | 61   | 81   | 2    | 84                      | 421  | 25   | 5    | 83                   | 210  | 43   | 2    | 2470       |
| 05:00 PM    | 23                      | 319  | 86   | 1    | 12                   | 18   | 18   | 0    | 11                      | 101  | 11   | 2    | 26                   | 102  | 12   | 0    | 742        |
| 05:15 PM    | 25                      | 345  | 82   | 0    | 14                   | 17   | 9    | 0    | 12                      | 120  | 9    | 1    | 12                   | 71   | 9    | 0    | 726        |
| 05:30 PM    | 30                      | 329  | 103  | 1    | 11                   | 21   | 8    | 0    | 4                       | 93   | 12   | 0    | 13                   | 68   | 9    | 0    | 702        |
| 05:45 PM    | 29                      | 291  | 105  | 0    | 12                   | 15   | 9    | 0    | 10                      | 100  | 6    | 0    | 21                   | 71   | 7    | 0    | 676        |
| Total       | 107                     | 1284 | 376  | 2    | 49                   | 71   | 44   | 0    | 37                      | 414  | 38   | 3    | 72                   | 312  | 37   | 0    | 2846       |
| Grand Total | 169                     | 2397 | 598  | 3    | 104                  | 132  | 125  | 2    | 121                     | 835  | 63   | 8    | 155                  | 522  | 80   | 2    | 5316       |
| Apprch %    | 5.3                     | 75.7 | 18.9 | 0.1  | 28.7                 | 36.4 | 34.4 | 0.6  | 11.8                    | 81.3 | 6.1  | 0.8  | 20.4                 | 68.8 | 10.5 | 0.3  |            |
| Total %     | 3.2                     | 45.1 | 11.2 | 0.1  | 2                    | 2.5  | 2.4  | 0    | 2.3                     | 15.7 | 1.2  | 0.2  | 2.9                  | 9.8  | 1.5  | 0    |            |

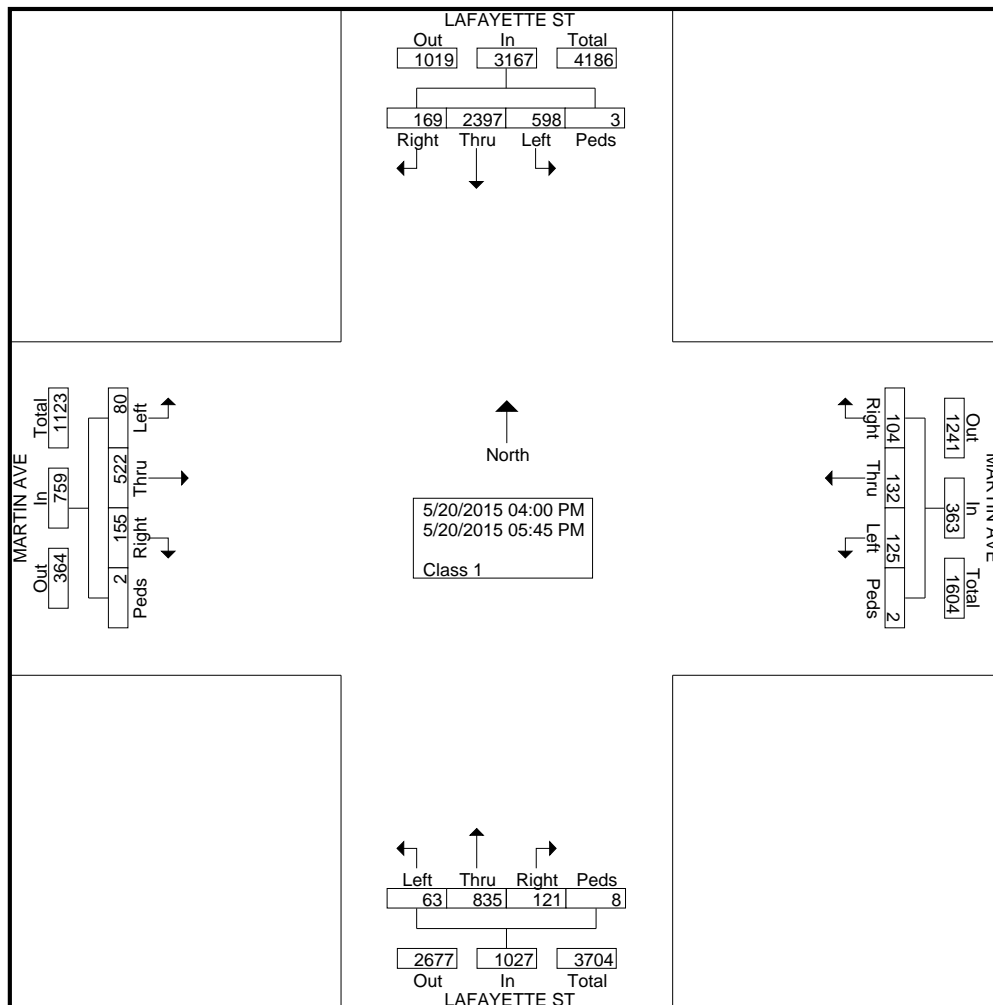

| Start Time  | LAFAYETTE ST Southbound |      |      |      |            | MARTIN AVE Westbound |      |      |      |            | LAFAYETTE ST Northbound |      |      |      |            | MARTIN AVE Eastbound |      |      |      |            | Int. Total |
|---|-------------------------|------|------|------|------------|----------------------|------|------|------|------------|-------------------------|------|------|------|------------|----------------------|------|------|------|------------|------------|
|   | Right                   | Thru | Left | Peds | App. Total | Right                | Thru | Left | Peds | App. Total | Right                   | Thru | Left | Peds | App. Total | Right                | Thru | Left | Peds | App. Total |            |
| <b>Peak Hour Analysis From 04:00 PM to 05:45 PM - Peak 1 of 1</b> |                         |      |      |      |            |                      |      |      |      |            |                         |      |      |      |            |                      |      |      |      |            |            |
| Peak Hour for Entire Intersection Begins at 05:00 PM              |                         |      |      |      |            |                      |      |      |      |            |                         |      |      |      |            |                      |      |      |      |            |            |
| 05:00 PM  | 23                      | 319  | 86   | 1    | 429        | 12                   | 18   | 18   | 0    | 48         | 11                      | 101  | 11   | 2    | 125        | 26                   | 102  | 12   | 0    | 140        | 742        |
| 05:15 PM  | 25                      | 345  | 82   | 0    | 452        | 14                   | 17   | 9    | 0    | 40         | 12                      | 120  | 9    | 1    | 142        | 12                   | 71   | 9    | 0    | 92         | 726        |
| 05:30 PM  | 30                      | 329  | 103  | 1    | 463        | 11                   | 21   | 8    | 0    | 40         | 4                       | 93   | 12   | 0    | 109        | 13                   | 68   | 9    | 0    | 90         | 702        |
| 05:45 PM  | 29                      | 291  | 105  | 0    | 425        | 12                   | 15   | 9    | 0    | 36         | 10                      | 100  | 6    | 0    | 116        | 21                   | 71   | 7    | 0    | 99         | 676        |
| Total Volume  | 107                     | 1284 | 376  | 2    | 1769       | 49                   | 71   | 44   | 0    | 164        | 37                      | 414  | 38   | 3    | 492        | 72                   | 312  | 37   | 0    | 421        | 2846       |
| % App. Total  | 6                       | 72.6 | 21.3 | 0.1  |            | 29.9                 | 43.3 | 26.8 | 0    |            | 7.5                     | 84.1 | 7.7  | 0.6  |            | 17.1                 | 74.1 | 8.8  | 0    |            |            |
| PHF   | .892                    | .930 | .895 | .500 | .955       | .875                 | .845 | .611 | .000 | .854       | .771                    | .863 | .792 | .375 | .866       | .692                 | .765 | .771 | .000 | .752       | .959       |

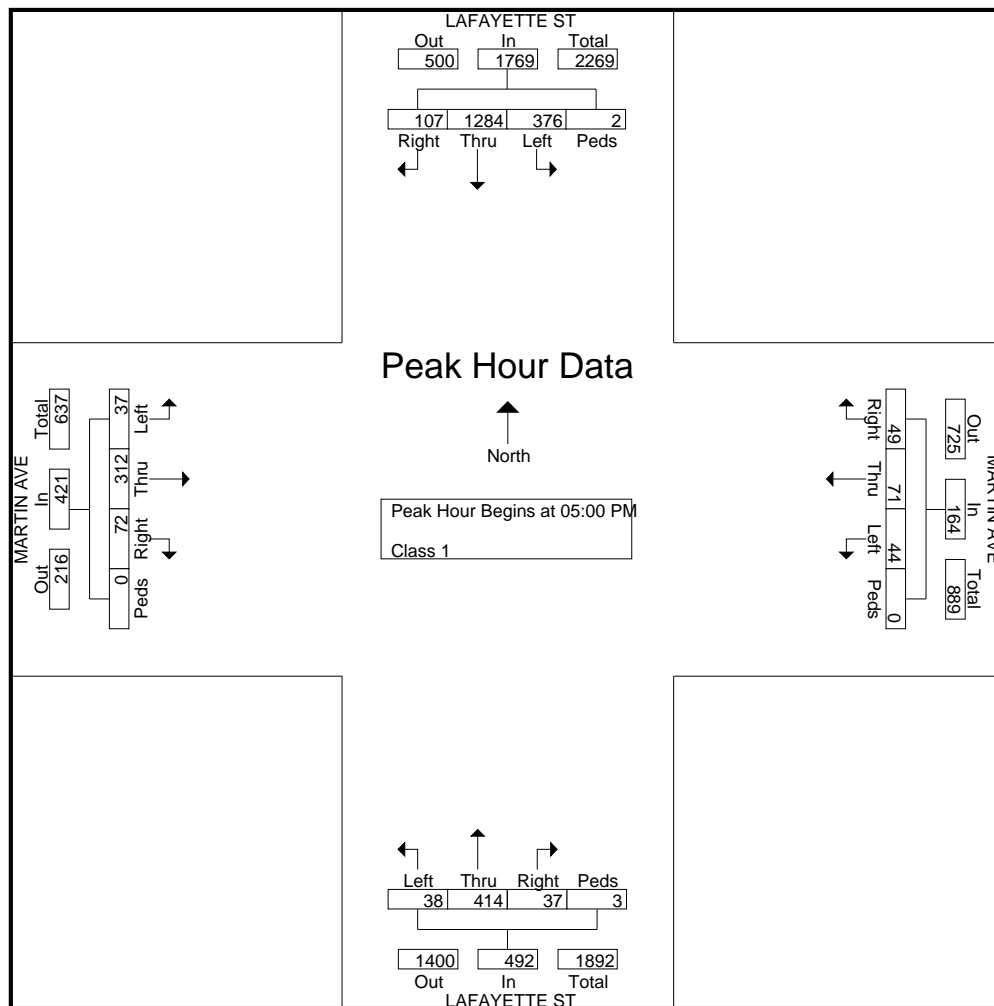

File Name : #17 ALMADEN&SANFERNANDOAM  
 Site Code : 17  
 Start Date : 5/6/2015  
 Page No : 1

Groups Printed- Class 1

| Start Time  | ALMADEN BLVD Southbound |      |      |      | SAN FERNANDO ST Westbound |      |      |      | ALMADEN BLVD Northbound |      |      |      | SAN FERNANDO ST Eastbound |      |      |      | Int. Total |
|-------------|-------------------------|------|------|------|---------------------------|------|------|------|-------------------------|------|------|------|---------------------------|------|------|------|------------|
|             | Right                   | Thru | Left | Peds | Right                     | Thru | Left | Peds | Right                   | Thru | Left | Peds | Right                     | Thru | Left | Peds |            |
| 07:00 AM    | 9                       | 52   | 11   | 6    | 4                         | 13   | 9    | 5    | 19                      | 81   | 12   | 2    | 5                         | 12   | 1    | 2    | 243        |
| 07:15 AM    | 16                      | 62   | 33   | 6    | 2                         | 17   | 4    | 6    | 32                      | 161  | 13   | 9    | 8                         | 12   | 1    | 8    | 390        |
| 07:30 AM    | 16                      | 57   | 16   | 4    | 6                         | 14   | 15   | 8    | 38                      | 190  | 23   | 7    | 2                         | 17   | 0    | 11   | 424        |
| 07:45 AM    | 16                      | 82   | 29   | 6    | 5                         | 36   | 8    | 9    | 50                      | 179  | 24   | 21   | 10                        | 17   | 0    | 2    | 494        |
| Total       | 57                      | 253  | 89   | 22   | 17                        | 80   | 36   | 28   | 139                     | 611  | 72   | 39   | 25                        | 58   | 2    | 23   | 1551       |
| 08:00 AM    | 17                      | 85   | 33   | 10   | 7                         | 19   | 10   | 15   | 44                      | 212  | 22   | 10   | 4                         | 19   | 6    | 10   | 523        |
| 08:15 AM    | 24                      | 87   | 29   | 10   | 9                         | 21   | 15   | 17   | 56                      | 192  | 21   | 14   | 7                         | 33   | 2    | 9    | 546        |
| 08:30 AM    | 18                      | 91   | 26   | 6    | 14                        | 13   | 8    | 18   | 70                      | 154  | 23   | 16   | 8                         | 21   | 4    | 7    | 497        |
| 08:45 AM    | 17                      | 108  | 23   | 9    | 8                         | 28   | 21   | 9    | 44                      | 187  | 29   | 20   | 16                        | 25   | 3    | 9    | 556        |
| Total       | 76                      | 371  | 111  | 35   | 38                        | 81   | 54   | 59   | 214                     | 745  | 95   | 60   | 35                        | 98   | 15   | 35   | 2122       |
| Grand Total | 133                     | 624  | 200  | 57   | 55                        | 161  | 90   | 87   | 353                     | 1356 | 167  | 99   | 60                        | 156  | 17   | 58   | 3673       |
| Apprch %    | 13.1                    | 61.5 | 19.7 | 5.6  | 14                        | 41   | 22.9 | 22.1 | 17.9                    | 68.7 | 8.5  | 5    | 20.6                      | 53.6 | 5.8  | 19.9 |            |
| Total %     | 3.6                     | 17   | 5.4  | 1.6  | 1.5                       | 4.4  | 2.5  | 2.4  | 9.6                     | 36.9 | 4.5  | 2.7  | 1.6                       | 4.2  | 0.5  | 1.6  |            |

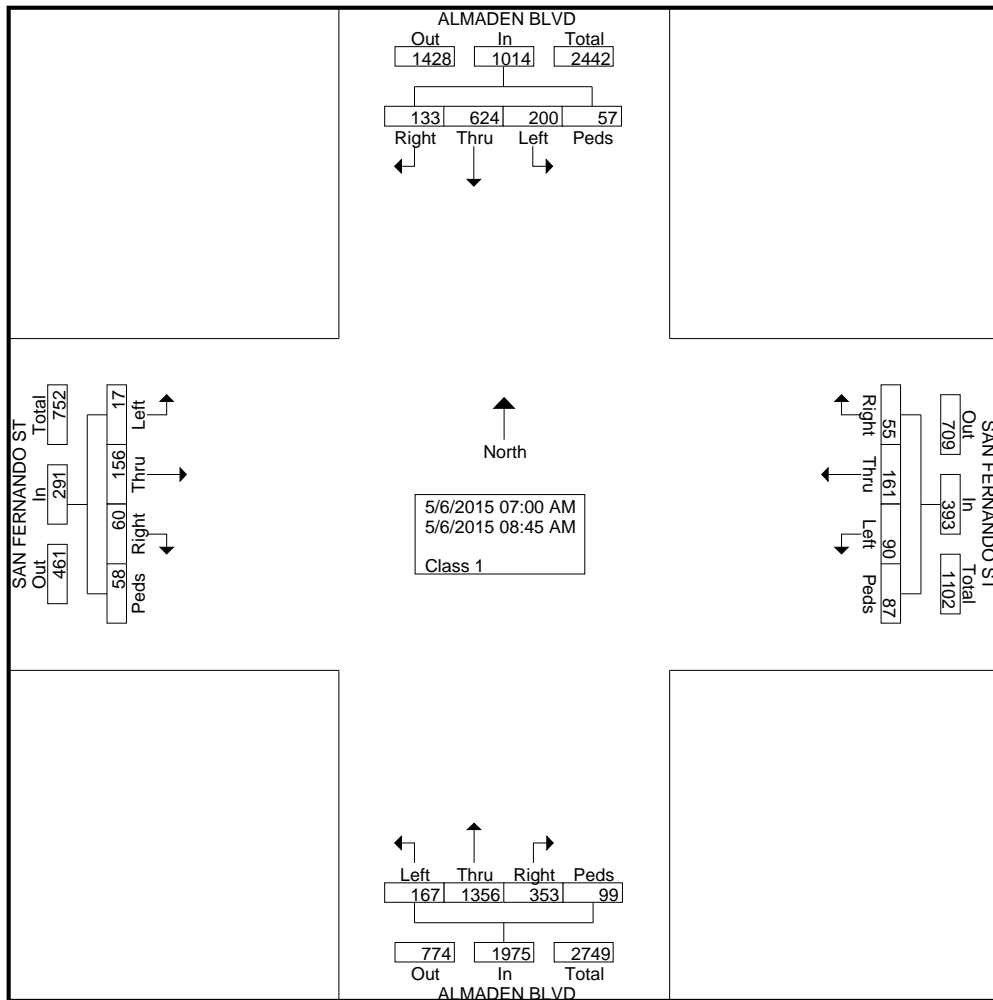

File Name : #17 ALMADEN&SANFERNANDOAM  
 Site Code : 17  
 Start Date : 5/6/2015  
 Page No : 2

| Start Time  | ALMADEN BLVD Southbound |      |      |      |            | SAN FERNANDO ST Westbound |      |      |      |            | ALMADEN BLVD Northbound |      |      |      |            | SAN FERNANDO ST Eastbound |      |      |      |            | Int. Total |
|---|-------------------------|------|------|------|------------|---------------------------|------|------|------|------------|-------------------------|------|------|------|------------|---------------------------|------|------|------|------------|------------|
|   | Right                   | Thru | Left | Peds | App. Total | Right                     | Thru | Left | Peds | App. Total | Right                   | Thru | Left | Peds | App. Total | Right                     | Thru | Left | Peds | App. Total |            |
| <b>Peak Hour Analysis From 07:00 AM to 08:45 AM - Peak 1 of 1</b> |                         |      |      |      |            |                           |      |      |      |            |                         |      |      |      |            |                           |      |      |      |            |            |
| Peak Hour for Entire Intersection Begins at 08:00 AM              |                         |      |      |      |            |                           |      |      |      |            |                         |      |      |      |            |                           |      |      |      |            |            |
| 08:00 AM  | 17                      | 85   | 33   | 10   | 145        | 7                         | 19   | 10   | 15   | 51         | 44                      | 212  | 22   | 10   | 288        | 4                         | 19   | 6    | 10   | 39         | 523        |
| 08:15 AM  | 24                      | 87   | 29   | 10   | 150        | 9                         | 21   | 15   | 17   | 62         | 56                      | 192  | 21   | 14   | 283        | 7                         | 33   | 2    | 9    | 51         | 546        |
| 08:30 AM  | 18                      | 91   | 26   | 6    | 141        | 14                        | 13   | 8    | 18   | 53         | 70                      | 154  | 23   | 16   | 263        | 8                         | 21   | 4    | 7    | 40         | 497        |
| 08:45 AM  | 17                      | 108  | 23   | 9    | 157        | 8                         | 28   | 21   | 9    | 66         | 44                      | 187  | 29   | 20   | 280        | 16                        | 25   | 3    | 9    | 53         | 556        |
| Total Volume  | 76                      | 371  | 111  | 35   | 593        | 38                        | 81   | 54   | 59   | 232        | 214                     | 745  | 95   | 60   | 1114       | 35                        | 98   | 15   | 35   | 183        | 2122       |
| % App. Total  | 12.8                    | 62.6 | 18.7 | 5.9  |            | 16.4                      | 34.9 | 23.3 | 25.4 |            | 19.2                    | 66.9 | 8.5  | 5.4  |            | 19.1                      | 53.6 | 8.2  | 19.1 |            |            |
| PHF   | .792                    | .859 | .841 | .875 | .944       | .679                      | .723 | .643 | .819 | .879       | .764                    | .879 | .819 | .750 | .967       | .547                      | .742 | .625 | .875 | .863       | .954       |

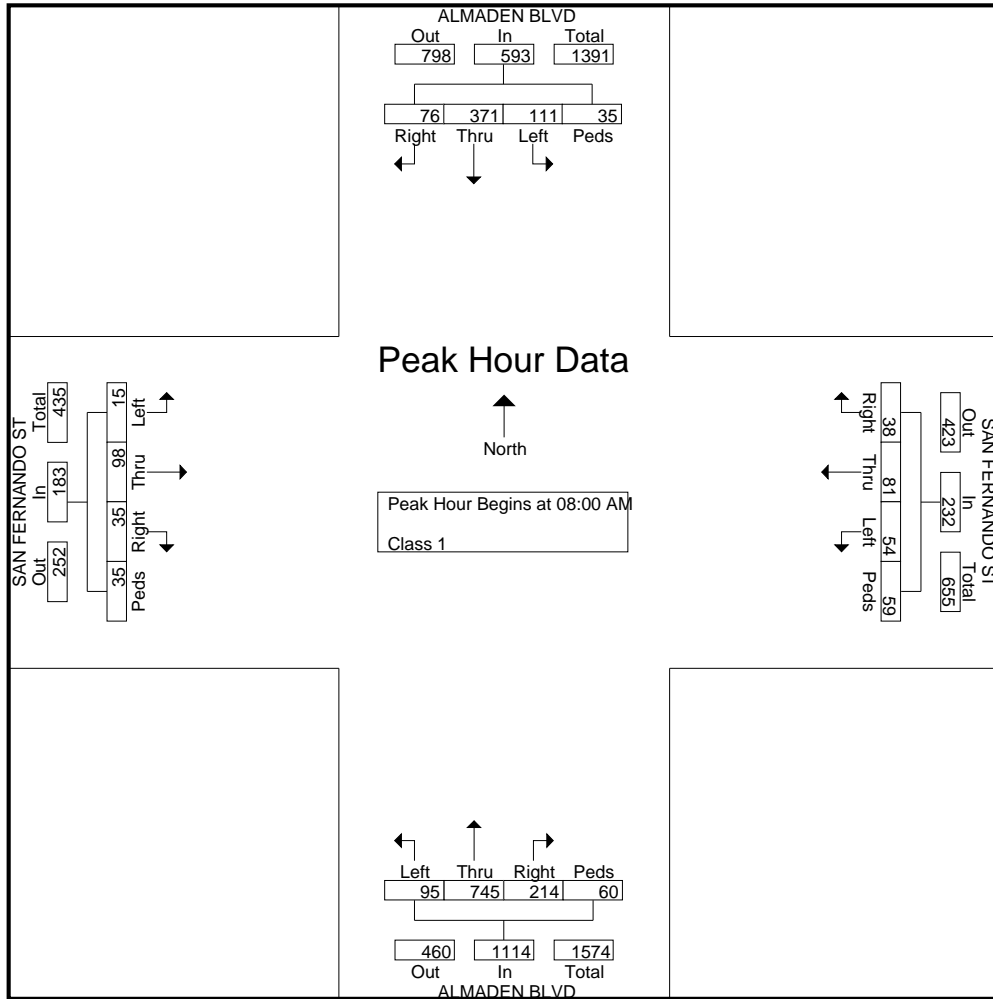

File Name : #17 ALMADEN&SANFERNANDOPM  
 Site Code : 17  
 Start Date : 5/5/2015  
 Page No : 1

Groups Printed- Class 1

| Start Time  | ALMADEN BLVD Southbound |      |      |      | SAN FERNANDO ST Westbound |      |      |      | ALMADEN BLVD Northbound |      |      |      | SAN FERNANDO ST Eastbound |      |      |      | Int. Total |
|-------------|-------------------------|------|------|------|---------------------------|------|------|------|-------------------------|------|------|------|---------------------------|------|------|------|------------|
|             | Right                   | Thru | Left | Peds | Right                     | Thru | Left | Peds | Right                   | Thru | Left | Peds | Right                     | Thru | Left | Peds |            |
| 04:00 PM    | 6                       | 75   | 11   | 20   | 8                         | 17   | 36   | 12   | 32                      | 58   | 2    | 8    | 25                        | 8    | 10   | 7    | 335        |
| 04:15 PM    | 10                      | 97   | 13   | 12   | 11                        | 29   | 42   | 14   | 30                      | 58   | 4    | 3    | 31                        | 21   | 8    | 8    | 391        |
| 04:30 PM    | 3                       | 92   | 21   | 11   | 12                        | 23   | 69   | 32   | 26                      | 60   | 6    | 9    | 37                        | 25   | 15   | 5    | 446        |
| 04:45 PM    | 4                       | 92   | 25   | 20   | 12                        | 30   | 56   | 18   | 35                      | 61   | 6    | 7    | 33                        | 29   | 8    | 8    | 444        |
| Total       | 23                      | 356  | 70   | 63   | 43                        | 99   | 203  | 76   | 123                     | 237  | 18   | 27   | 126                       | 83   | 41   | 28   | 1616       |
| 05:00 PM    | 4                       | 146  | 21   | 68   | 14                        | 44   | 75   | 64   | 40                      | 73   | 4    | 31   | 53                        | 26   | 11   | 9    | 683        |
| 05:15 PM    | 0                       | 127  | 24   | 27   | 11                        | 51   | 67   | 26   | 21                      | 61   | 4    | 10   | 45                        | 29   | 5    | 9    | 517        |
| 05:30 PM    | 2                       | 134  | 31   | 22   | 9                         | 23   | 58   | 24   | 27                      | 80   | 7    | 16   | 31                        | 23   | 3    | 11   | 501        |
| 05:45 PM    | 2                       | 86   | 25   | 20   | 12                        | 31   | 52   | 40   | 29                      | 58   | 4    | 9    | 25                        | 21   | 5    | 6    | 425        |
| Total       | 8                       | 493  | 101  | 137  | 46                        | 149  | 252  | 154  | 117                     | 272  | 19   | 66   | 154                       | 99   | 24   | 35   | 2126       |
| Grand Total | 31                      | 849  | 171  | 200  | 89                        | 248  | 455  | 230  | 240                     | 509  | 37   | 93   | 280                       | 182  | 65   | 63   | 3742       |
| Apprch %    | 2.5                     | 67.9 | 13.7 | 16   | 8.7                       | 24.3 | 44.5 | 22.5 | 27.3                    | 57.9 | 4.2  | 10.6 | 47.5                      | 30.8 | 11   | 10.7 |            |
| Total %     | 0.8                     | 22.7 | 4.6  | 5.3  | 2.4                       | 6.6  | 12.2 | 6.1  | 6.4                     | 13.6 | 1    | 2.5  | 7.5                       | 4.9  | 1.7  | 1.7  |            |

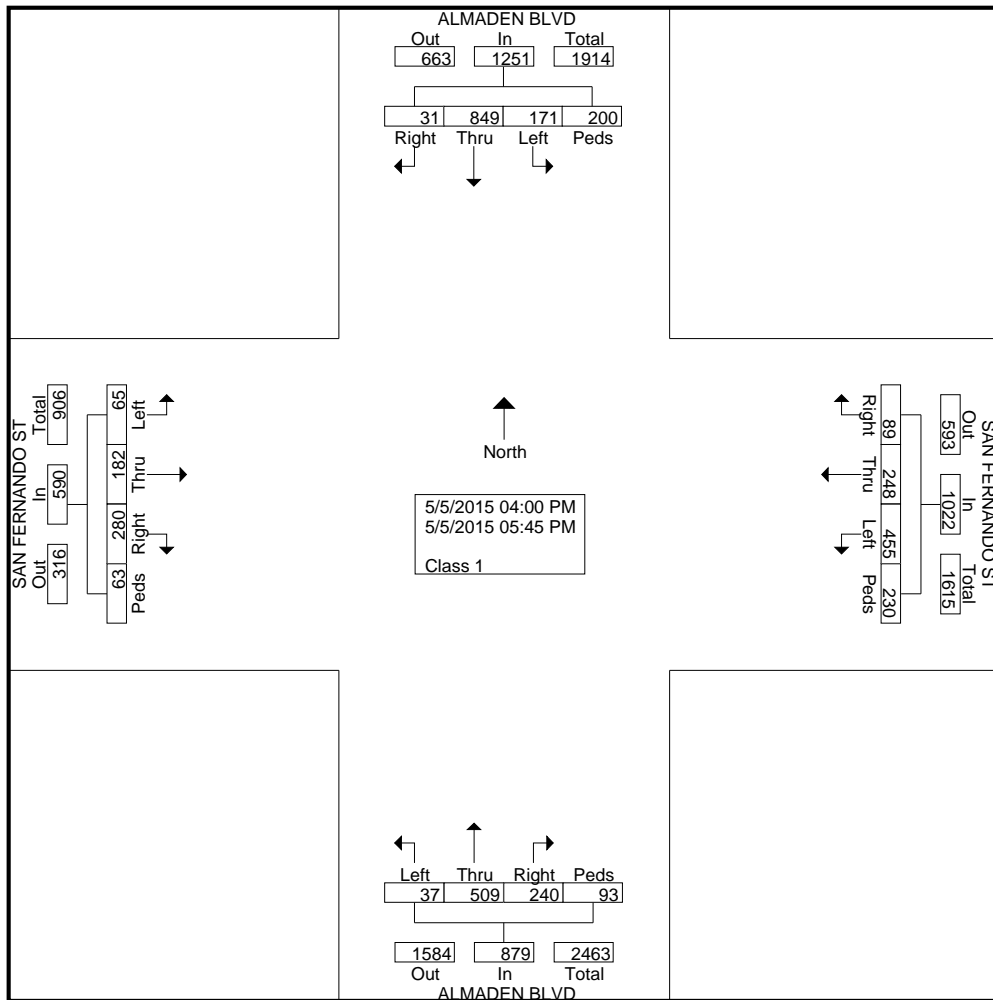

File Name : #17 ALMADEN&SANFERNANDOPM  
 Site Code : 17  
 Start Date : 5/5/2015  
 Page No : 2

| Start Time  | ALMADEN BLVD Southbound |      |      |      |            | SAN FERNANDO ST Westbound |      |      |      |            | ALMADEN BLVD Northbound |      |      |      |            | SAN FERNANDO ST Eastbound |      |      |      |            | Int. Total |
|---|-------------------------|------|------|------|------------|---------------------------|------|------|------|------------|-------------------------|------|------|------|------------|---------------------------|------|------|------|------------|------------|
|   | Right                   | Thru | Left | Peds | App. Total | Right                     | Thru | Left | Peds | App. Total | Right                   | Thru | Left | Peds | App. Total | Right                     | Thru | Left | Peds | App. Total |            |
| <b>Peak Hour Analysis From 04:00 PM to 05:45 PM - Peak 1 of 1</b> |                         |      |      |      |            |                           |      |      |      |            |                         |      |      |      |            |                           |      |      |      |            |            |
| Peak Hour for Entire Intersection Begins at 04:45 PM              |                         |      |      |      |            |                           |      |      |      |            |                         |      |      |      |            |                           |      |      |      |            |            |
| 04:45 PM  | 4                       | 92   | 25   | 20   | 141        | 12                        | 30   | 56   | 18   | 116        | 35                      | 61   | 6    | 7    | 109        | 33                        | 29   | 8    | 8    | 78         | 444        |
| 05:00 PM  | 4                       | 146  | 21   | 68   | 239        | 14                        | 44   | 75   | 64   | 197        | 40                      | 73   | 4    | 31   | 148        | 53                        | 26   | 11   | 9    | 99         | 683        |
| 05:15 PM  | 0                       | 127  | 24   | 27   | 178        | 11                        | 51   | 67   | 26   | 155        | 21                      | 61   | 4    | 10   | 96         | 45                        | 29   | 5    | 9    | 88         | 517        |
| 05:30 PM  | 2                       | 134  | 31   | 22   | 189        | 9                         | 23   | 58   | 24   | 114        | 27                      | 80   | 7    | 16   | 130        | 31                        | 23   | 3    | 11   | 68         | 501        |
| Total Volume  | 10                      | 499  | 101  | 137  | 747        | 46                        | 148  | 256  | 132  | 582        | 123                     | 275  | 21   | 64   | 483        | 162                       | 107  | 27   | 37   | 333        | 2145       |
| % App. Total  | 1.3                     | 66.8 | 13.5 | 18.3 |            | 7.9                       | 25.4 | 44   | 22.7 |            | 25.5                    | 56.9 | 4.3  | 13.3 |            | 48.6                      | 32.1 | 8.1  | 11.1 |            |            |
| PHF   | .625                    | .854 | .815 | .504 | .781       | .821                      | .725 | .853 | .516 | .739       | .769                    | .859 | .750 | .516 | .816       | .764                      | .922 | .614 | .841 | .841       | .785       |

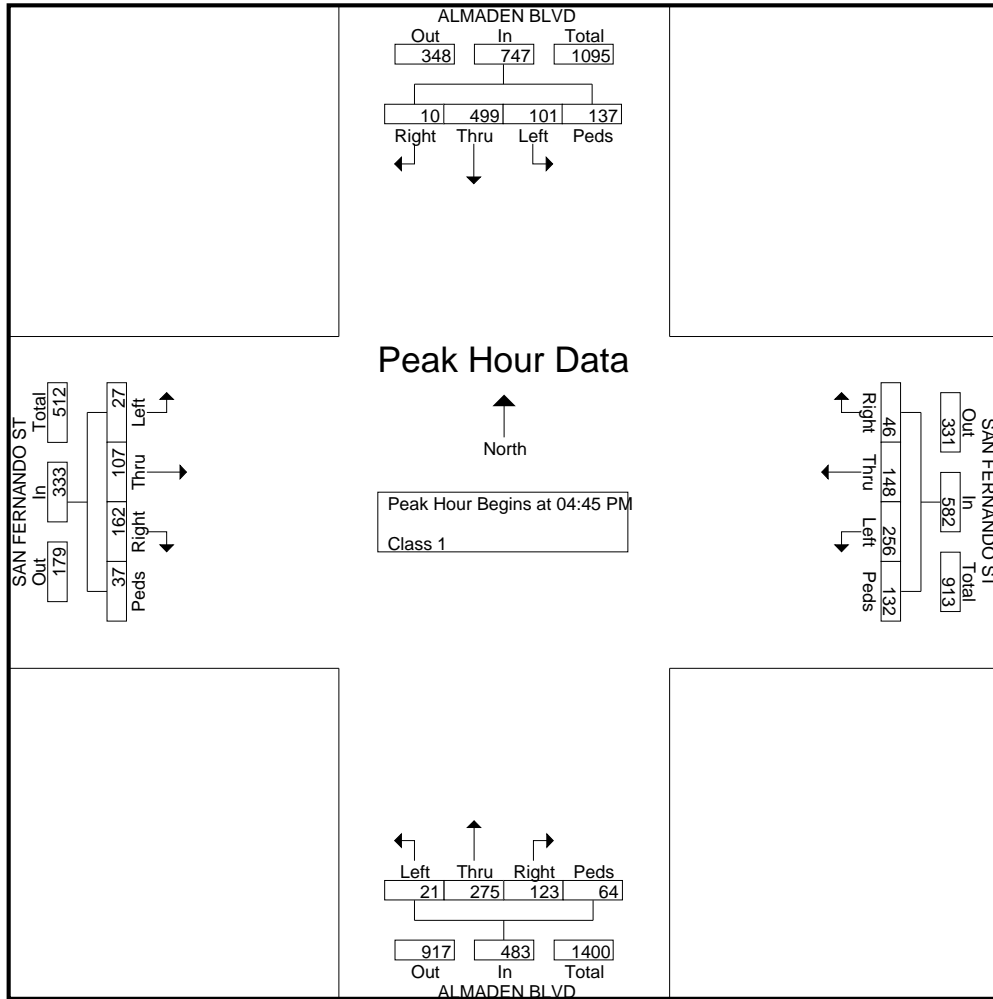

File Name : #17 HOMESTEAD&LINCOLNAM  
 Site Code :  
 Start Date : 5/21/2015  
 Page No : 1

Groups Printed- Class 1

| Start Time  | LINCOLN ST Southbound |      |      |      | HOMESTEAD RD Westbound |      |      |      | WINCHESTER BLVD Northbound |      |      |      | HOMESTEAD RD Eastbound |      |      |      | Int. Total |
|-------------|-----------------------|------|------|------|------------------------|------|------|------|----------------------------|------|------|------|------------------------|------|------|------|------------|
|             | Right                 | Thru | Left | Peds | Right                  | Thru | Left | Peds | Right                      | Thru | Left | Peds | Right                  | Thru | Left | Peds |            |
| 07:00 AM    | 8                     | 8    | 5    | 0    | 1                      | 14   | 5    | 0    | 3                          | 42   | 9    | 0    | 3                      | 10   | 8    | 1    | 117        |
| 07:15 AM    | 5                     | 21   | 5    | 0    | 5                      | 19   | 4    | 0    | 3                          | 48   | 6    | 1    | 3                      | 27   | 7    | 2    | 156        |
| 07:30 AM    | 4                     | 24   | 4    | 0    | 6                      | 29   | 1    | 1    | 8                          | 74   | 7    | 1    | 5                      | 33   | 10   | 0    | 207        |
| 07:45 AM    | 14                    | 39   | 8    | 0    | 4                      | 41   | 1    | 1    | 11                         | 81   | 16   | 0    | 2                      | 58   | 16   | 0    | 292        |
| Total       | 31                    | 92   | 22   | 0    | 16                     | 103  | 11   | 2    | 25                         | 245  | 38   | 2    | 13                     | 128  | 41   | 3    | 772        |
| 08:00 AM    | 18                    | 37   | 10   | 2    | 5                      | 56   | 7    | 2    | 12                         | 87   | 12   | 1    | 0                      | 54   | 9    | 0    | 312        |
| 08:15 AM    | 10                    | 20   | 6    | 0    | 6                      | 28   | 5    | 0    | 9                          | 97   | 3    | 0    | 0                      | 61   | 9    | 0    | 254        |
| 08:30 AM    | 7                     | 27   | 6    | 0    | 3                      | 26   | 5    | 2    | 12                         | 87   | 9    | 1    | 1                      | 32   | 11   | 1    | 230        |
| 08:45 AM    | 9                     | 18   | 5    | 2    | 6                      | 25   | 8    | 1    | 13                         | 57   | 5    | 1    | 1                      | 33   | 11   | 0    | 195        |
| Total       | 44                    | 102  | 27   | 4    | 20                     | 135  | 25   | 5    | 46                         | 328  | 29   | 3    | 2                      | 180  | 40   | 1    | 991        |
| Grand Total | 75                    | 194  | 49   | 4    | 36                     | 238  | 36   | 7    | 71                         | 573  | 67   | 5    | 15                     | 308  | 81   | 4    | 1763       |
| Apprch %    | 23.3                  | 60.2 | 15.2 | 1.2  | 11.4                   | 75.1 | 11.4 | 2.2  | 9.9                        | 80   | 9.4  | 0.7  | 3.7                    | 75.5 | 19.9 | 1    |            |
| Total %     | 4.3                   | 11   | 2.8  | 0.2  | 2                      | 13.5 | 2    | 0.4  | 4                          | 32.5 | 3.8  | 0.3  | 0.9                    | 17.5 | 4.6  | 0.2  |            |

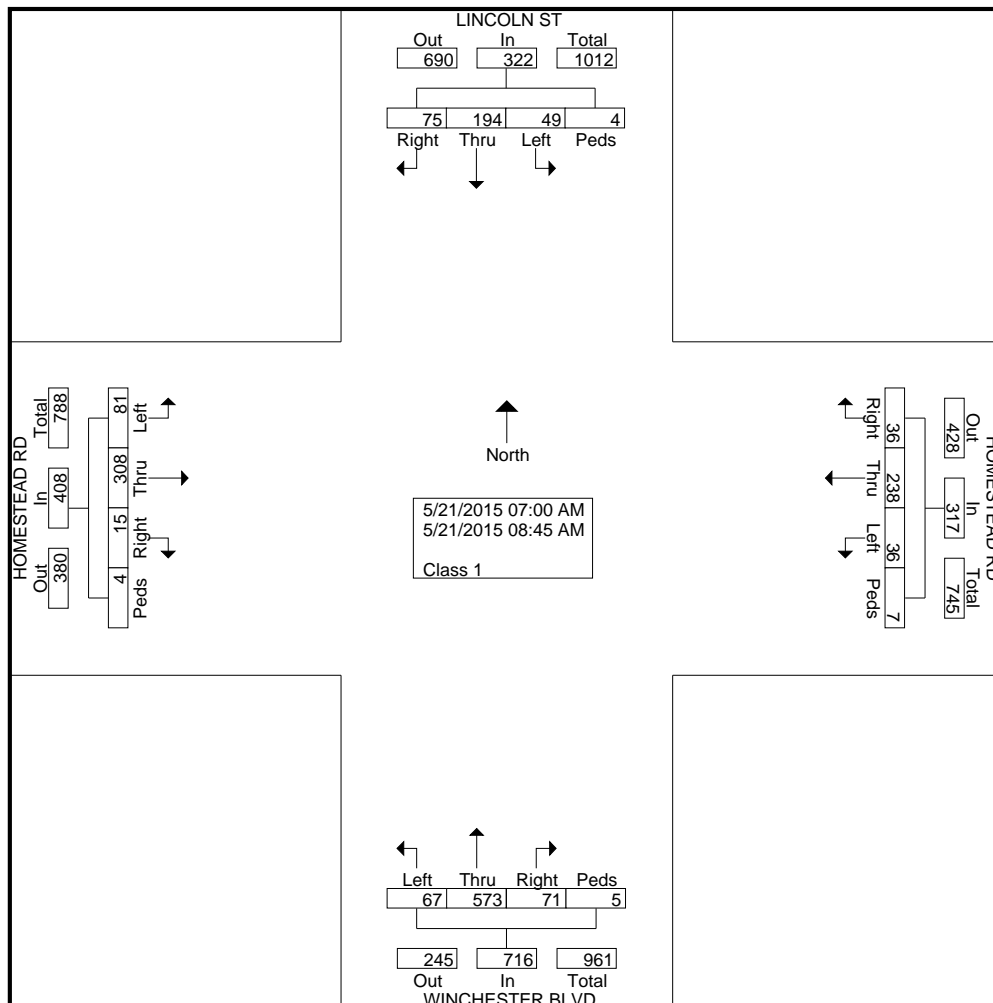

File Name : #17 HOMESTEAD&LINCOLNAM  
 Site Code :  
 Start Date : 5/21/2015  
 Page No : 2

| Start Time  | LINCOLN ST Southbound |      |      |      |            | HOMESTEAD RD Westbound |      |      |      |            | WINCHESTER BLVD Northbound |      |      |      |            | HOMESTEAD RD Eastbound |      |      |      |            | Int. Total |
|---|-----------------------|------|------|------|------------|------------------------|------|------|------|------------|----------------------------|------|------|------|------------|------------------------|------|------|------|------------|------------|
|   | Right                 | Thru | Left | Peds | App. Total | Right                  | Thru | Left | Peds | App. Total | Right                      | Thru | Left | Peds | App. Total | Right                  | Thru | Left | Peds | App. Total |            |
| <b>Peak Hour Analysis From 07:00 AM to 08:45 AM - Peak 1 of 1</b> |                       |      |      |      |            |                        |      |      |      |            |                            |      |      |      |            |                        |      |      |      |            |            |
| Peak Hour for Entire Intersection Begins at 07:45 AM              |                       |      |      |      |            |                        |      |      |      |            |                            |      |      |      |            |                        |      |      |      |            |            |
| 07:45 AM  | 14                    | 39   | 8    | 0    | 61         | 4                      | 41   | 1    | 1    | 47         | 11                         | 81   | 16   | 0    | 108        | 2                      | 58   | 16   | 0    | 76         | 292        |
| 08:00 AM  | 18                    | 37   | 10   | 2    | 67         | 5                      | 56   | 7    | 2    | 70         | 12                         | 87   | 12   | 1    | 112        | 0                      | 54   | 9    | 0    | 63         | 312        |
| 08:15 AM  | 10                    | 20   | 6    | 0    | 36         | 6                      | 28   | 5    | 0    | 39         | 9                          | 97   | 3    | 0    | 109        | 0                      | 61   | 9    | 0    | 70         | 254        |
| 08:30 AM  | 7                     | 27   | 6    | 0    | 40         | 3                      | 26   | 5    | 2    | 36         | 12                         | 87   | 9    | 1    | 109        | 1                      | 32   | 11   | 1    | 45         | 230        |
| Total Volume  | 49                    | 123  | 30   | 2    | 204        | 18                     | 151  | 18   | 5    | 192        | 44                         | 352  | 40   | 2    | 438        | 3                      | 205  | 45   | 1    | 254        | 1088       |
| % App. Total  | 24                    | 60.3 | 14.7 | 1    |            | 9.4                    | 78.6 | 9.4  | 2.6  |            | 10                         | 80.4 | 9.1  | 0.5  |            | 1.2                    | 80.7 | 17.7 | 0.4  |            |            |
| PHF   | .681                  | .788 | .750 | .250 | .761       | .750                   | .674 | .643 | .625 | .686       | .917                       | .907 | .625 | .500 | .978       | .375                   | .840 | .703 | .250 | .836       | .872       |

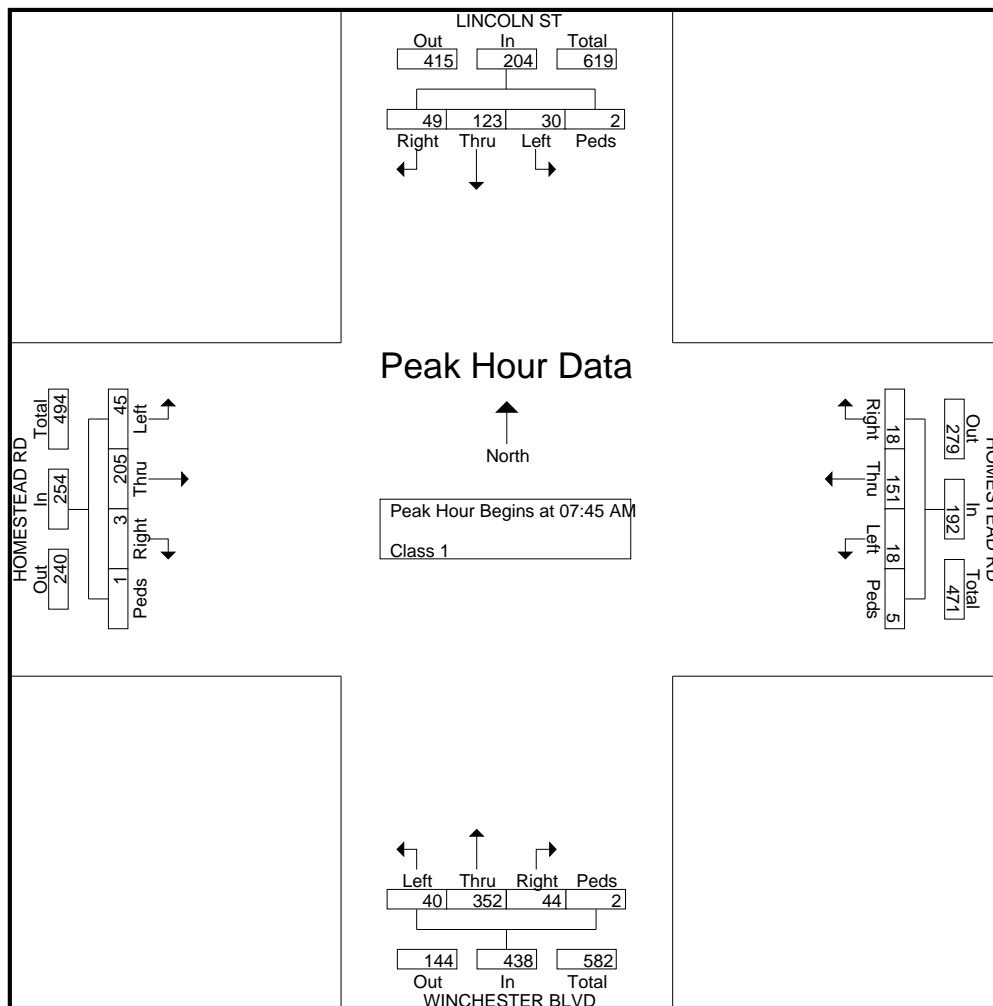



File Name : #17 HOMESTEAD&LINCOLNPM  
 Site Code :  
 Start Date : 5/20/2015  
 Page No : 1

Groups Printed- Class 1

| Start Time  | LINCOLN ST Southbound |      |      |      | HOMESTEAD RD Westbound |      |      |      | WINCHESTER BLVD Northbound |      |      |      | HOMESTEAD RD Eastbound |      |      |      | Int. Total |
|-------------|-----------------------|------|------|------|------------------------|------|------|------|----------------------------|------|------|------|------------------------|------|------|------|------------|
|             | Right                 | Thru | Left | Peds | Right                  | Thru | Left | Peds | Right                      | Thru | Left | Peds | Right                  | Thru | Left | Peds |            |
| 04:00 PM    | 11                    | 39   | 8    | 0    | 6                      | 36   | 5    | 0    | 9                          | 47   | 5    | 1    | 3                      | 39   | 3    | 0    | 212        |
| 04:15 PM    | 7                     | 38   | 5    | 3    | 5                      | 34   | 10   | 1    | 10                         | 47   | 6    | 0    | 6                      | 51   | 4    | 0    | 227        |
| 04:30 PM    | 9                     | 61   | 5    | 0    | 4                      | 34   | 17   | 4    | 5                          | 34   | 8    | 0    | 4                      | 36   | 9    | 1    | 231        |
| 04:45 PM    | 9                     | 58   | 11   | 3    | 2                      | 61   | 12   | 7    | 5                          | 47   | 3    | 1    | 8                      | 42   | 12   | 0    | 281        |
| Total       | 36                    | 196  | 29   | 6    | 17                     | 165  | 44   | 12   | 29                         | 175  | 22   | 2    | 21                     | 168  | 28   | 1    | 951        |
| 05:00 PM    | 11                    | 91   | 13   | 0    | 4                      | 44   | 19   | 2    | 12                         | 46   | 7    | 0    | 1                      | 40   | 10   | 0    | 300        |
| 05:15 PM    | 10                    | 77   | 11   | 4    | 2                      | 41   | 15   | 6    | 6                          | 48   | 10   | 0    | 5                      | 57   | 10   | 1    | 303        |
| 05:30 PM    | 2                     | 94   | 13   | 0    | 3                      | 33   | 16   | 2    | 8                          | 37   | 6    | 0    | 7                      | 42   | 8    | 0    | 271        |
| 05:45 PM    | 14                    | 89   | 13   | 0    | 2                      | 40   | 11   | 1    | 6                          | 40   | 4    | 0    | 2                      | 66   | 6    | 0    | 294        |
| Total       | 37                    | 351  | 50   | 4    | 11                     | 158  | 61   | 11   | 32                         | 171  | 27   | 0    | 15                     | 205  | 34   | 1    | 1168       |
| Grand Total | 73                    | 547  | 79   | 10   | 28                     | 323  | 105  | 23   | 61                         | 346  | 49   | 2    | 36                     | 373  | 62   | 2    | 2119       |
| Apprch %    | 10.3                  | 77.2 | 11.1 | 1.4  | 5.8                    | 67.4 | 21.9 | 4.8  | 13.3                       | 75.5 | 10.7 | 0.4  | 7.6                    | 78.9 | 13.1 | 0.4  |            |
| Total %     | 3.4                   | 25.8 | 3.7  | 0.5  | 1.3                    | 15.2 | 5    | 1.1  | 2.9                        | 16.3 | 2.3  | 0.1  | 1.7                    | 17.6 | 2.9  | 0.1  |            |

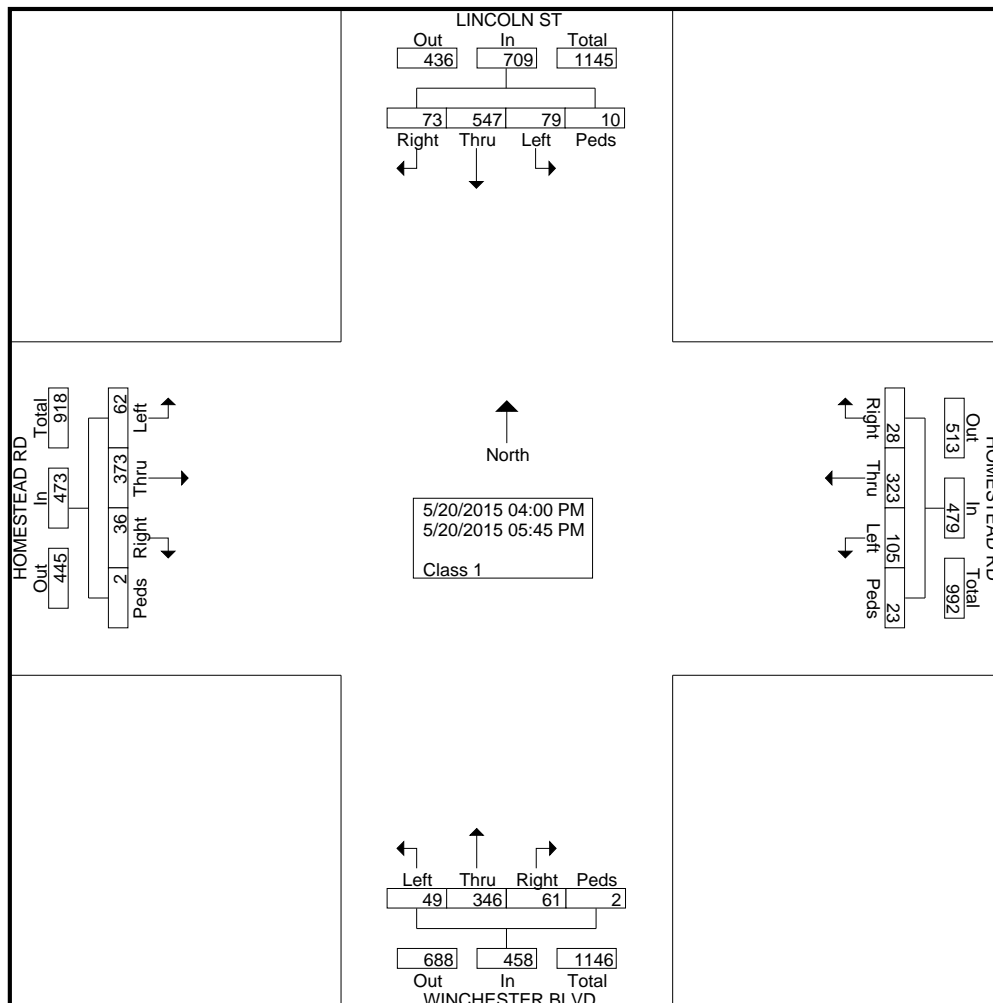

File Name : #17 HOMESTEAD&LINCOLNPM  
 Site Code :  
 Start Date : 5/20/2015  
 Page No : 2

| Start Time  | LINCOLN ST Southbound |      |      |      |            | HOMESTEAD RD Westbound |      |      |      |            | WINCHESTER BLVD Northbound |      |      |      |            | HOMESTEAD RD Eastbound |      |      |      |            | Int. Total |
|---|-----------------------|------|------|------|------------|------------------------|------|------|------|------------|----------------------------|------|------|------|------------|------------------------|------|------|------|------------|------------|
|   | Right                 | Thru | Left | Peds | App. Total | Right                  | Thru | Left | Peds | App. Total | Right                      | Thru | Left | Peds | App. Total | Right                  | Thru | Left | Peds | App. Total |            |
| <b>Peak Hour Analysis From 04:00 PM to 05:45 PM - Peak 1 of 1</b> |                       |      |      |      |            |                        |      |      |      |            |                            |      |      |      |            |                        |      |      |      |            |            |
| Peak Hour for Entire Intersection Begins at 05:00 PM              |                       |      |      |      |            |                        |      |      |      |            |                            |      |      |      |            |                        |      |      |      |            |            |
| 05:00 PM  | 11                    | 91   | 13   | 0    | 115        | 4                      | 44   | 19   | 2    | 69         | 12                         | 46   | 7    | 0    | 65         | 1                      | 40   | 10   | 0    | 51         | 300        |
| 05:15 PM  | 10                    | 77   | 11   | 4    | 102        | 2                      | 41   | 15   | 6    | 64         | 6                          | 48   | 10   | 0    | 64         | 5                      | 57   | 10   | 1    | 73         | 303        |
| 05:30 PM  | 2                     | 94   | 13   | 0    | 109        | 3                      | 33   | 16   | 2    | 54         | 8                          | 37   | 6    | 0    | 51         | 7                      | 42   | 8    | 0    | 57         | 271        |
| 05:45 PM  | 14                    | 89   | 13   | 0    | 116        | 2                      | 40   | 11   | 1    | 54         | 6                          | 40   | 4    | 0    | 50         | 2                      | 66   | 6    | 0    | 74         | 294        |
| Total Volume  | 37                    | 351  | 50   | 4    | 442        | 11                     | 158  | 61   | 11   | 241        | 32                         | 171  | 27   | 0    | 230        | 15                     | 205  | 34   | 1    | 255        | 1168       |
| % App. Total  | 8.4                   | 79.4 | 11.3 | 0.9  |            | 4.6                    | 65.6 | 25.3 | 4.6  |            | 13.9                       | 74.3 | 11.7 | 0    |            | 5.9                    | 80.4 | 13.3 | 0.4  |            |            |
| PHF   | .661                  | .934 | .962 | .250 | .953       | .688                   | .898 | .803 | .458 | .873       | .667                       | .891 | .675 | .000 | .885       | .536                   | .777 | .850 | .250 | .861       | .964       |

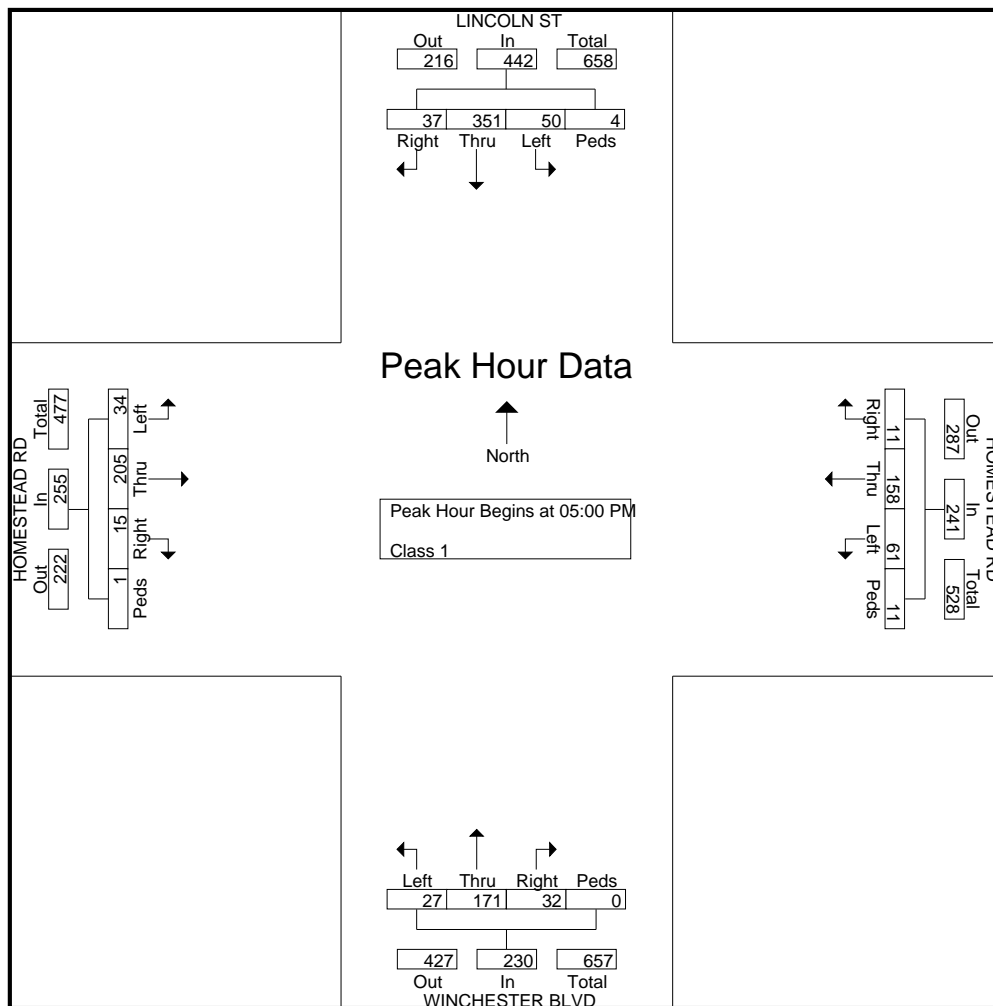

File Name : #18 ALMADEN&SAN CARLOS AM  
 Site Code : 18  
 Start Date : 5/6/2015  
 Page No : 1

Groups Printed- Class 1

| Start Time  | ALMADEN BLVD Southbound |      |      |      | SAN CARLOS ST Westbound |      |      |      | ALMADEN BLVD Northbound |      |      |      | SAN CARLOS ST Eastbound |      |      |      | Int. Total |
|-------------|-------------------------|------|------|------|-------------------------|------|------|------|-------------------------|------|------|------|-------------------------|------|------|------|------------|
|             | Right                   | Thru | Left | Peds | Right                   | Thru | Left | Peds | Right                   | Thru | Left | Peds | Right                   | Thru | Left | Peds |            |
| 07:00 AM    | 3                       | 43   | 24   | 2    | 11                      | 68   | 5    | 4    | 13                      | 128  | 10   | 7    | 2                       | 39   | 9    | 2    | 370        |
| 07:15 AM    | 7                       | 51   | 21   | 3    | 19                      | 64   | 5    | 13   | 22                      | 216  | 17   | 9    | 2                       | 35   | 5    | 5    | 494        |
| 07:30 AM    | 6                       | 53   | 28   | 3    | 21                      | 81   | 4    | 15   | 15                      | 294  | 9    | 5    | 4                       | 39   | 11   | 6    | 594        |
| 07:45 AM    | 6                       | 71   | 16   | 6    | 29                      | 77   | 5    | 30   | 27                      | 262  | 21   | 13   | 5                       | 48   | 23   | 7    | 646        |
| Total       | 22                      | 218  | 89   | 14   | 80                      | 290  | 19   | 62   | 77                      | 900  | 57   | 34   | 13                      | 161  | 48   | 20   | 2104       |
| 08:00 AM    | 8                       | 55   | 18   | 0    | 18                      | 65   | 7    | 14   | 28                      | 314  | 19   | 8    | 1                       | 62   | 11   | 0    | 628        |
| 08:15 AM    | 5                       | 69   | 33   | 0    | 36                      | 86   | 9    | 22   | 24                      | 274  | 3    | 11   | 0                       | 70   | 22   | 0    | 664        |
| 08:30 AM    | 8                       | 78   | 28   | 0    | 25                      | 61   | 8    | 35   | 33                      | 298  | 5    | 12   | 1                       | 77   | 20   | 0    | 689        |
| 08:45 AM    | 11                      | 79   | 39   | 5    | 40                      | 74   | 5    | 19   | 24                      | 272  | 14   | 10   | 0                       | 75   | 20   | 6    | 693        |
| Total       | 32                      | 281  | 118  | 5    | 119                     | 286  | 29   | 90   | 109                     | 1158 | 41   | 41   | 2                       | 284  | 73   | 6    | 2674       |
| Grand Total | 54                      | 499  | 207  | 19   | 199                     | 576  | 48   | 152  | 186                     | 2058 | 98   | 75   | 15                      | 445  | 121  | 26   | 4778       |
| Apprch %    | 6.9                     | 64.1 | 26.6 | 2.4  | 20.4                    | 59.1 | 4.9  | 15.6 | 7.7                     | 85.1 | 4.1  | 3.1  | 2.5                     | 73.3 | 19.9 | 4.3  |            |
| Total %     | 1.1                     | 10.4 | 4.3  | 0.4  | 4.2                     | 12.1 | 1    | 3.2  | 3.9                     | 43.1 | 2.1  | 1.6  | 0.3                     | 9.3  | 2.5  | 0.5  |            |

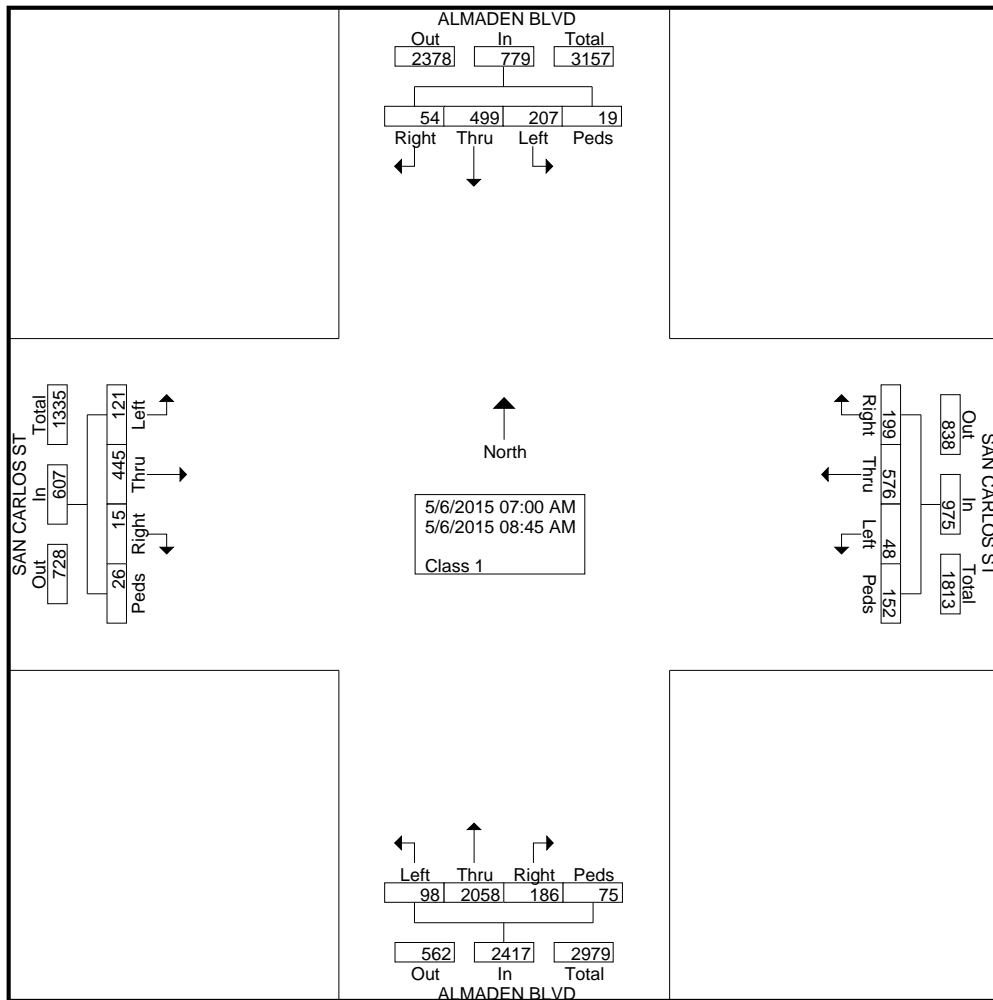

File Name : #18 ALMADEN&SAN CARLOS AM  
 Site Code : 18  
 Start Date : 5/6/2015  
 Page No : 2

| Start Time  | ALMADEN BLVD Southbound |      |      |      |            | SAN CARLOS ST Westbound |      |      |      |            | ALMADEN BLVD Northbound |      |      |      |            | SAN CARLOS ST Eastbound |      |      |      |            | Int. Total |
|---|-------------------------|------|------|------|------------|-------------------------|------|------|------|------------|-------------------------|------|------|------|------------|-------------------------|------|------|------|------------|------------|
|   | Right                   | Thru | Left | Peds | App. Total | Right                   | Thru | Left | Peds | App. Total | Right                   | Thru | Left | Peds | App. Total | Right                   | Thru | Left | Peds | App. Total |            |
| <b>Peak Hour Analysis From 07:00 AM to 08:45 AM - Peak 1 of 1</b> |                         |      |      |      |            |                         |      |      |      |            |                         |      |      |      |            |                         |      |      |      |            |            |
| Peak Hour for Entire Intersection Begins at 08:00 AM              |                         |      |      |      |            |                         |      |      |      |            |                         |      |      |      |            |                         |      |      |      |            |            |
| 08:00 AM  | 8                       | 55   | 18   | 0    | 81         | 18                      | 65   | 7    | 14   | 104        | 28                      | 314  | 19   | 8    | 369        | 1                       | 62   | 11   | 0    | 74         | 628        |
| 08:15 AM  | 5                       | 69   | 33   | 0    | 107        | 36                      | 86   | 9    | 22   | 153        | 24                      | 274  | 3    | 11   | 312        | 0                       | 70   | 22   | 0    | 92         | 664        |
| 08:30 AM  | 8                       | 78   | 28   | 0    | 114        | 25                      | 61   | 8    | 35   | 129        | 33                      | 298  | 5    | 12   | 348        | 1                       | 77   | 20   | 0    | 98         | 689        |
| 08:45 AM  | 11                      | 79   | 39   | 5    | 134        | 40                      | 74   | 5    | 19   | 138        | 24                      | 272  | 14   | 10   | 320        | 0                       | 75   | 20   | 6    | 101        | 693        |
| Total Volume  | 32                      | 281  | 118  | 5    | 436        | 119                     | 286  | 29   | 90   | 524        | 109                     | 1158 | 41   | 41   | 1349       | 2                       | 284  | 73   | 6    | 365        | 2674       |
| % App. Total  | 7.3                     | 64.4 | 27.1 | 1.1  |            | 22.7                    | 54.6 | 5.5  | 17.2 |            | 8.1                     | 85.8 | 3    | 3    |            | 0.5                     | 77.8 | 20   | 1.6  |            |            |
| PHF   | .727                    | .889 | .756 | .250 | .813       | .744                    | .831 | .806 | .643 | .856       | .826                    | .922 | .539 | .854 | .914       | .500                    | .922 | .830 | .250 | .903       | .965       |

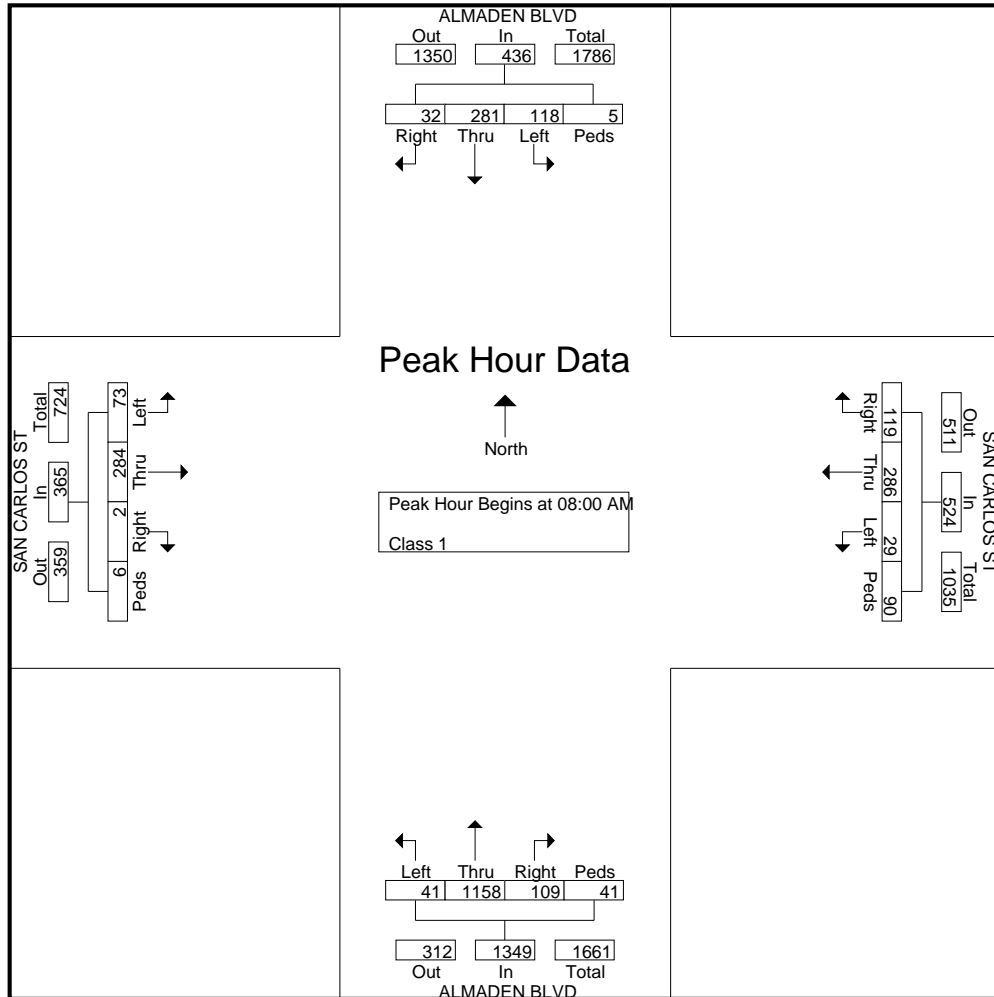

File Name : #18 HOMESTEAD&MONROEAM  
 Site Code :  
 Start Date : 5/21/2015  
 Page No : 1

Groups Printed- Class 1

| Start Time  | MONROE ST Southbound |      |      |      | HOMESTEAD RD Westbound |      |      |      | MONROE ST Northbound |      |      |      | HOMESTEAD RD Eastbound |      |      |      | Int. Total |
|-------------|----------------------|------|------|------|------------------------|------|------|------|----------------------|------|------|------|------------------------|------|------|------|------------|
|             | Right                | Thru | Left | Peds | Right                  | Thru | Left | Peds | Right                | Thru | Left | Peds | Right                  | Thru | Left | Peds |            |
| 07:00 AM    | 1                    | 27   | 3    | 0    | 4                      | 14   | 4    | 0    | 5                    | 48   | 3    | 0    | 5                      | 8    | 2    | 0    | 124        |
| 07:15 AM    | 0                    | 42   | 3    | 1    | 5                      | 13   | 2    | 2    | 3                    | 71   | 7    | 0    | 5                      | 21   | 2    | 2    | 179        |
| 07:30 AM    | 4                    | 54   | 7    | 2    | 4                      | 21   | 4    | 0    | 6                    | 94   | 9    | 1    | 11                     | 26   | 4    | 0    | 247        |
| 07:45 AM    | 1                    | 79   | 13   | 0    | 12                     | 24   | 2    | 3    | 12                   | 124  | 17   | 0    | 16                     | 48   | 5    | 4    | 360        |
| Total       | 6                    | 202  | 26   | 3    | 25                     | 72   | 12   | 5    | 26                   | 337  | 36   | 1    | 37                     | 103  | 13   | 6    | 910        |
| 08:00 AM    | 1                    | 104  | 8    | 2    | 13                     | 28   | 9    | 4    | 8                    | 140  | 25   | 5    | 16                     | 51   | 5    | 1    | 420        |
| 08:15 AM    | 3                    | 83   | 6    | 0    | 5                      | 21   | 1    | 2    | 11                   | 117  | 19   | 1    | 21                     | 51   | 3    | 1    | 345        |
| 08:30 AM    | 3                    | 42   | 5    | 0    | 7                      | 13   | 4    | 0    | 9                    | 133  | 13   | 2    | 5                      | 44   | 4    | 1    | 285        |
| 08:45 AM    | 4                    | 47   | 11   | 1    | 13                     | 22   | 0    | 1    | 7                    | 115  | 8    | 0    | 8                      | 32   | 1    | 0    | 270        |
| Total       | 11                   | 276  | 30   | 3    | 38                     | 84   | 14   | 7    | 35                   | 505  | 65   | 8    | 50                     | 178  | 13   | 3    | 1320       |
| Grand Total | 17                   | 478  | 56   | 6    | 63                     | 156  | 26   | 12   | 61                   | 842  | 101  | 9    | 87                     | 281  | 26   | 9    | 2230       |
| Apprch %    | 3.1                  | 85.8 | 10.1 | 1.1  | 24.5                   | 60.7 | 10.1 | 4.7  | 6                    | 83.1 | 10   | 0.9  | 21.6                   | 69.7 | 6.5  | 2.2  |            |
| Total %     | 0.8                  | 21.4 | 2.5  | 0.3  | 2.8                    | 7    | 1.2  | 0.5  | 2.7                  | 37.8 | 4.5  | 0.4  | 3.9                    | 12.6 | 1.2  | 0.4  |            |

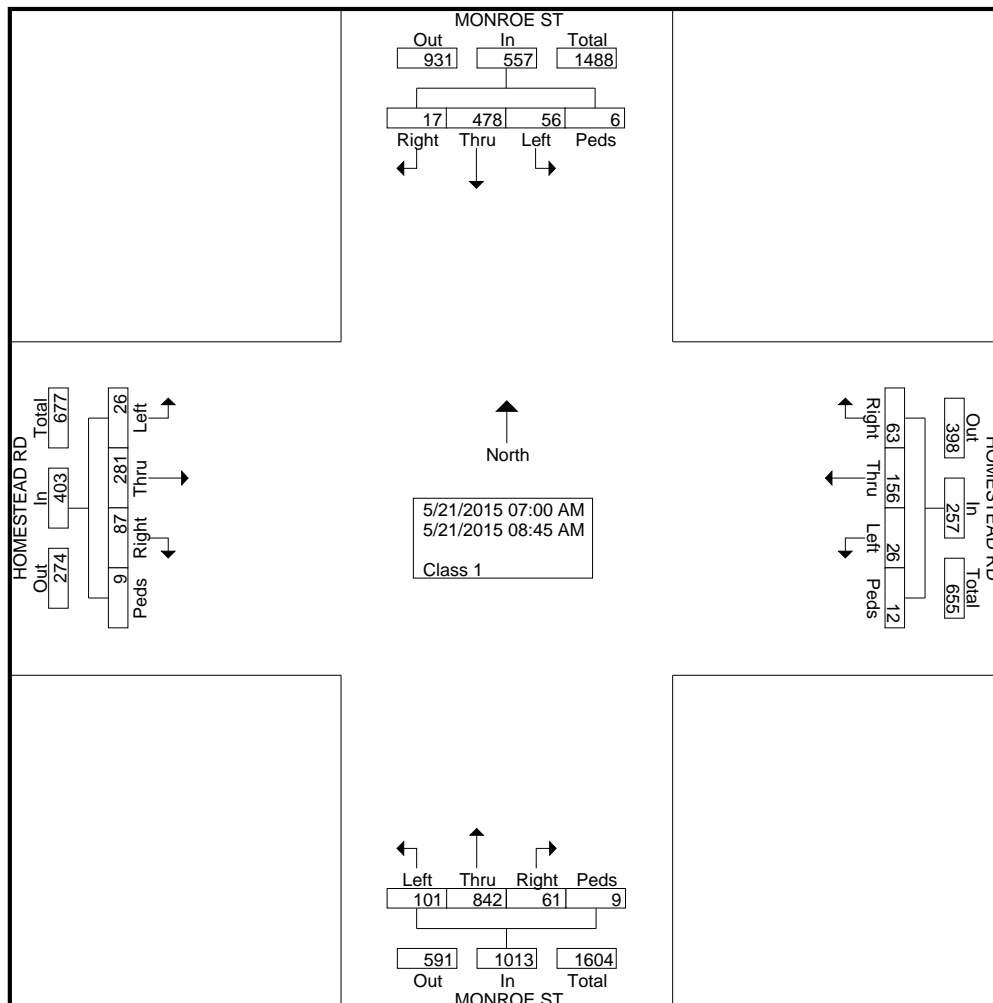

File Name : #18 HOMESTEAD&MONROEAM  
 Site Code :  
 Start Date : 5/21/2015  
 Page No : 2

| Start Time  | MONROE ST Southbound |      |      |      |            | HOMESTEAD RD Westbound |      |      |      |            | MONROE ST Northbound |      |      |      |            | HOMESTEAD RD Eastbound |      |      |      |            | Int. Total |
|---|----------------------|------|------|------|------------|------------------------|------|------|------|------------|----------------------|------|------|------|------------|------------------------|------|------|------|------------|------------|
|   | Right                | Thru | Left | Peds | App. Total | Right                  | Thru | Left | Peds | App. Total | Right                | Thru | Left | Peds | App. Total | Right                  | Thru | Left | Peds | App. Total |            |
| <b>Peak Hour Analysis From 07:00 AM to 08:45 AM - Peak 1 of 1</b> |                      |      |      |      |            |                        |      |      |      |            |                      |      |      |      |            |                        |      |      |      |            |            |
| Peak Hour for Entire Intersection Begins at 07:45 AM              |                      |      |      |      |            |                        |      |      |      |            |                      |      |      |      |            |                        |      |      |      |            |            |
| 07:45 AM  | 1                    | 79   | 13   | 0    | 93         | 12                     | 24   | 2    | 3    | 41         | 12                   | 124  | 17   | 0    | 153        | 16                     | 48   | 5    | 4    | 73         | 360        |
| 08:00 AM  | 1                    | 104  | 8    | 2    | 115        | 13                     | 28   | 9    | 4    | 54         | 8                    | 140  | 25   | 5    | 178        | 16                     | 51   | 5    | 1    | 73         | 420        |
| 08:15 AM  | 3                    | 83   | 6    | 0    | 92         | 5                      | 21   | 1    | 2    | 29         | 11                   | 117  | 19   | 1    | 148        | 21                     | 51   | 3    | 1    | 76         | 345        |
| 08:30 AM  | 3                    | 42   | 5    | 0    | 50         | 7                      | 13   | 4    | 0    | 24         | 9                    | 133  | 13   | 2    | 157        | 5                      | 44   | 4    | 1    | 54         | 285        |
| Total Volume  | 8                    | 308  | 32   | 2    | 350        | 37                     | 86   | 16   | 9    | 148        | 40                   | 514  | 74   | 8    | 636        | 58                     | 194  | 17   | 7    | 276        | 1410       |
| % App. Total  | 2.3                  | 88   | 9.1  | 0.6  |            | 25                     | 58.1 | 10.8 | 6.1  |            | 6.3                  | 80.8 | 11.6 | 1.3  |            | 21                     | 70.3 | 6.2  | 2.5  |            |            |
| PHF   | .667                 | .740 | .615 | .250 | .761       | .712                   | .768 | .444 | .563 | .685       | .833                 | .918 | .740 | .400 | .893       | .690                   | .951 | .850 | .438 | .908       | .839       |

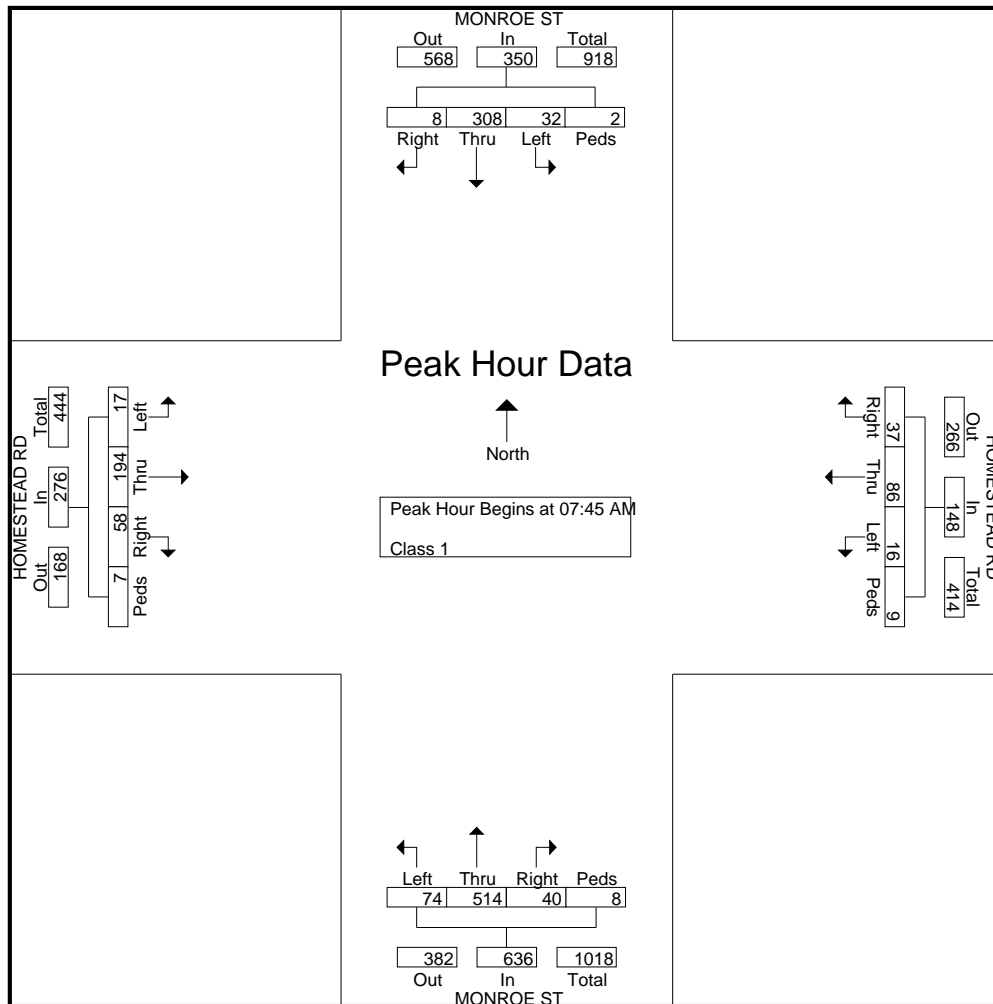

File Name : #18 HOMESTEAD&MONROEPM  
 Site Code :  
 Start Date : 5/20/2015  
 Page No : 1

Groups Printed- Class 1

| Start Time  | MONROE ST Southbound |      |      |      | HOMESTEAD RD Westbound |      |      |      | MONROE ST Northbound |      |      |      | HOMESTEAD RD Eastbound |      |      |      | Int. Total |
|-------------|----------------------|------|------|------|------------------------|------|------|------|----------------------|------|------|------|------------------------|------|------|------|------------|
|             | Right                | Thru | Left | Peds | Right                  | Thru | Left | Peds | Right                | Thru | Left | Peds | Right                  | Thru | Left | Peds |            |
| 04:00 PM    | 4                    | 53   | 14   | 1    | 13                     | 33   | 6    | 3    | 5                    | 61   | 15   | 2    | 7                      | 39   | 5    | 1    | 262        |
| 04:15 PM    | 5                    | 96   | 14   | 4    | 14                     | 32   | 7    | 3    | 13                   | 41   | 9    | 1    | 12                     | 45   | 4    | 0    | 300        |
| 04:30 PM    | 8                    | 120  | 10   | 2    | 7                      | 39   | 6    | 0    | 8                    | 61   | 6    | 0    | 12                     | 29   | 5    | 0    | 313        |
| 04:45 PM    | 7                    | 100  | 9    | 0    | 9                      | 51   | 6    | 0    | 9                    | 61   | 12   | 2    | 12                     | 32   | 5    | 2    | 317        |
| Total       | 24                   | 369  | 47   | 7    | 43                     | 155  | 25   | 6    | 35                   | 224  | 42   | 5    | 43                     | 145  | 19   | 3    | 1192       |
| 05:00 PM    | 8                    | 136  | 15   | 0    | 12                     | 49   | 8    | 2    | 4                    | 59   | 8    | 5    | 12                     | 42   | 4    | 5    | 369        |
| 05:15 PM    | 10                   | 150  | 15   | 1    | 17                     | 51   | 13   | 2    | 5                    | 75   | 11   | 6    | 10                     | 43   | 5    | 3    | 417        |
| 05:30 PM    | 5                    | 148  | 10   | 0    | 11                     | 42   | 12   | 2    | 6                    | 67   | 5    | 0    | 15                     | 39   | 8    | 4    | 374        |
| 05:45 PM    | 6                    | 175  | 16   | 1    | 9                      | 39   | 4    | 2    | 2                    | 54   | 6    | 1    | 13                     | 39   | 1    | 0    | 368        |
| Total       | 29                   | 609  | 56   | 2    | 49                     | 181  | 37   | 8    | 17                   | 255  | 30   | 12   | 50                     | 163  | 18   | 12   | 1528       |
| Grand Total | 53                   | 978  | 103  | 9    | 92                     | 336  | 62   | 14   | 52                   | 479  | 72   | 17   | 93                     | 308  | 37   | 15   | 2720       |
| Apprch %    | 4.6                  | 85.6 | 9    | 0.8  | 18.3                   | 66.7 | 12.3 | 2.8  | 8.4                  | 77.3 | 11.6 | 2.7  | 20.5                   | 68   | 8.2  | 3.3  |            |
| Total %     | 1.9                  | 36   | 3.8  | 0.3  | 3.4                    | 12.4 | 2.3  | 0.5  | 1.9                  | 17.6 | 2.6  | 0.6  | 3.4                    | 11.3 | 1.4  | 0.6  |            |

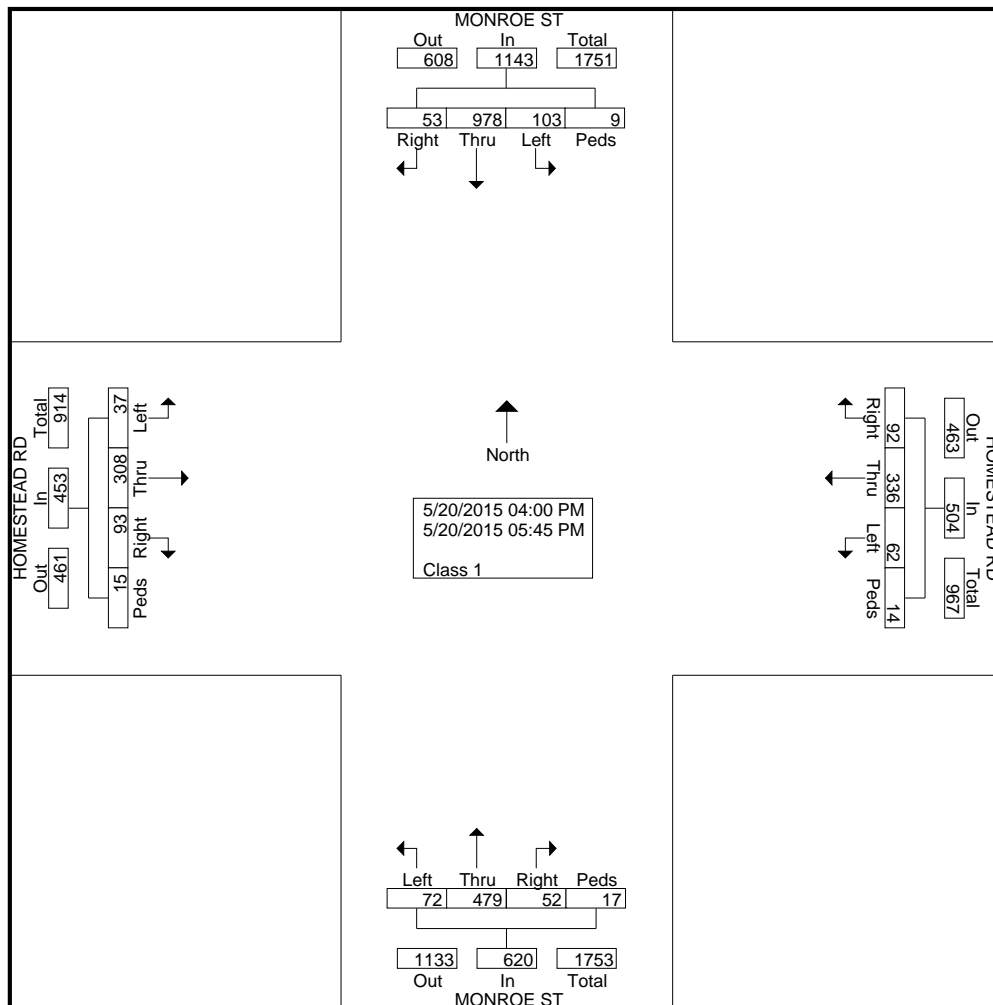

File Name : #18 HOMESTEAD&MONROEPM  
 Site Code :  
 Start Date : 5/20/2015  
 Page No : 2

| Start Time  | MONROE ST Southbound |      |      |      |            | HOMESTEAD RD Westbound |      |      |      |            | MONROE ST Northbound |      |      |      |            | HOMESTEAD RD Eastbound |      |      |      |            | Int. Total |
|---|----------------------|------|------|------|------------|------------------------|------|------|------|------------|----------------------|------|------|------|------------|------------------------|------|------|------|------------|------------|
|   | Right                | Thru | Left | Peds | App. Total | Right                  | Thru | Left | Peds | App. Total | Right                | Thru | Left | Peds | App. Total | Right                  | Thru | Left | Peds | App. Total |            |
| <b>Peak Hour Analysis From 04:00 PM to 05:45 PM - Peak 1 of 1</b> |                      |      |      |      |            |                        |      |      |      |            |                      |      |      |      |            |                        |      |      |      |            |            |
| Peak Hour for Entire Intersection Begins at 05:00 PM              |                      |      |      |      |            |                        |      |      |      |            |                      |      |      |      |            |                        |      |      |      |            |            |
| 05:00 PM  | 8                    | 136  | 15   | 0    | 159        | 12                     | 49   | 8    | 2    | 71         | 4                    | 59   | 8    | 5    | 76         | 12                     | 42   | 4    | 5    | 63         | 369        |
| 05:15 PM  | 10                   | 150  | 15   | 1    | 176        | 17                     | 51   | 13   | 2    | 83         | 5                    | 75   | 11   | 6    | 97         | 10                     | 43   | 5    | 3    | 61         | 417        |
| 05:30 PM  | 5                    | 148  | 10   | 0    | 163        | 11                     | 42   | 12   | 2    | 67         | 6                    | 67   | 5    | 0    | 78         | 15                     | 39   | 8    | 4    | 66         | 374        |
| 05:45 PM  | 6                    | 175  | 16   | 1    | 198        | 9                      | 39   | 4    | 2    | 54         | 2                    | 54   | 6    | 1    | 63         | 13                     | 39   | 1    | 0    | 53         | 368        |
| Total Volume  | 29                   | 609  | 56   | 2    | 696        | 49                     | 181  | 37   | 8    | 275        | 17                   | 255  | 30   | 12   | 314        | 50                     | 163  | 18   | 12   | 243        | 1528       |
| % App. Total  | 4.2                  | 87.5 | 8    | 0.3  |            | 17.8                   | 65.8 | 13.5 | 2.9  |            | 5.4                  | 81.2 | 9.6  | 3.8  |            | 20.6                   | 67.1 | 7.4  | 4.9  |            |            |
| PHF   | .725                 | .870 | .875 | .500 | .879       | .721                   | .887 | .712 | 1.00 | .828       | .708                 | .850 | .682 | .500 | .809       | .833                   | .948 | .563 | .600 | .920       | .916       |

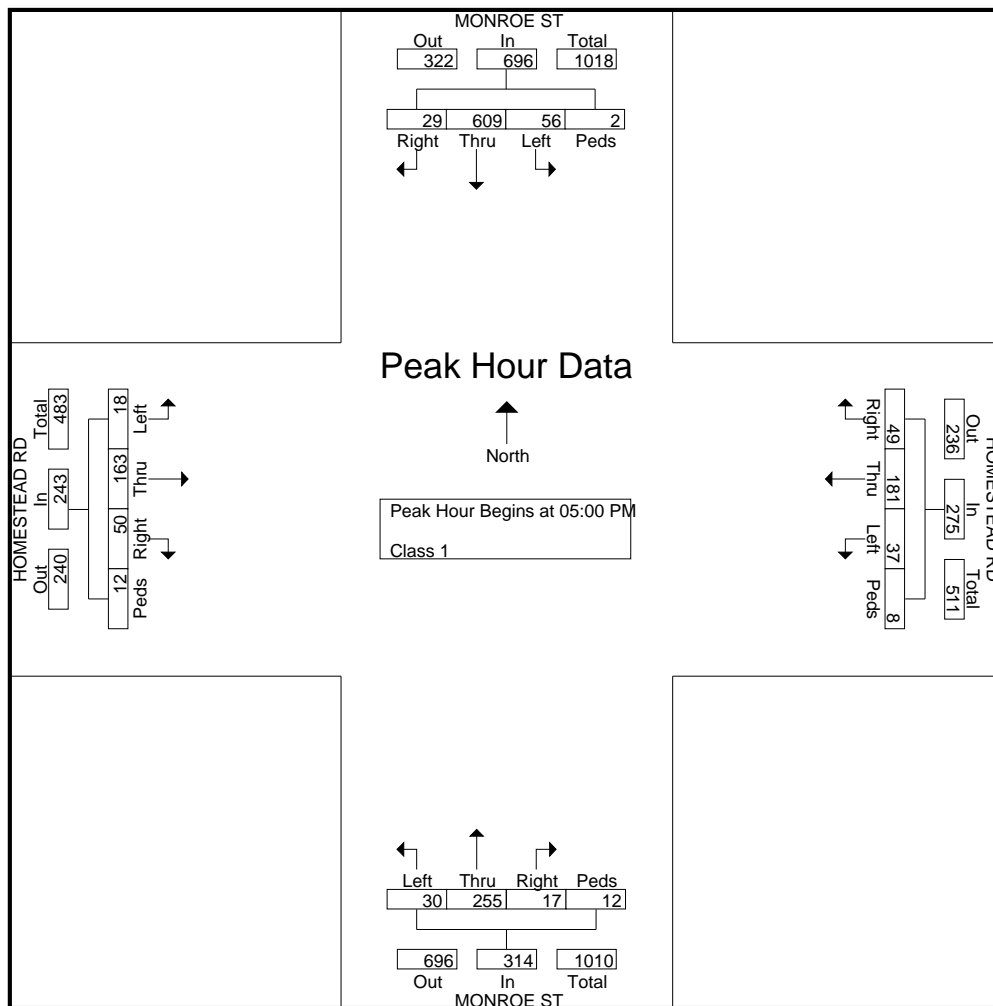



File Name : #19 HOMESTEAD&LAFAYETTE TEAM  
 Site Code :  
 Start Date : 5/21/2015  
 Page No : 1

Groups Printed- Class 1

| Start Time  | LAFAYETTE ST Southbound |      |      |      | Westbound |      |      |      | LAFAYETTE ST Northbound |      |      |      | HOMESTEAD RD Eastbound |      |      |      | Int. Total |
|-------------|-------------------------|------|------|------|-----------|------|------|------|-------------------------|------|------|------|------------------------|------|------|------|------------|
|             | Right                   | Thru | Left | Peds | Right     | Thru | Left | Peds | Right                   | Thru | Left | Peds | Right                  | Thru | Left | Peds |            |
| 07:00 AM    | 8                       | 27   | 0    | 1    | 0         | 0    | 0    | 0    | 0                       | 152  | 9    | 2    | 8                      | 0    | 8    | 0    | 215        |
| 07:15 AM    | 7                       | 50   | 0    | 3    | 0         | 0    | 0    | 0    | 0                       | 184  | 14   | 4    | 5                      | 0    | 12   | 1    | 280        |
| 07:30 AM    | 11                      | 67   | 0    | 0    | 0         | 0    | 0    | 0    | 0                       | 236  | 30   | 2    | 10                     | 0    | 27   | 0    | 383        |
| 07:45 AM    | 22                      | 85   | 0    | 2    | 0         | 0    | 0    | 0    | 0                       | 264  | 30   | 3    | 18                     | 0    | 36   | 0    | 460        |
| Total       | 48                      | 229  | 0    | 6    | 0         | 0    | 0    | 0    | 0                       | 836  | 83   | 11   | 41                     | 0    | 83   | 1    | 1338       |
| 08:00 AM    | 28                      | 118  | 0    | 2    | 0         | 0    | 0    | 0    | 0                       | 303  | 24   | 4    | 17                     | 0    | 56   | 0    | 552        |
| 08:15 AM    | 16                      | 104  | 0    | 3    | 0         | 0    | 0    | 0    | 0                       | 312  | 32   | 4    | 30                     | 0    | 43   | 0    | 544        |
| 08:30 AM    | 20                      | 65   | 0    | 0    | 0         | 0    | 0    | 0    | 0                       | 301  | 34   | 2    | 20                     | 0    | 33   | 0    | 475        |
| 08:45 AM    | 9                       | 61   | 0    | 1    | 0         | 0    | 0    | 0    | 0                       | 278  | 24   | 1    | 20                     | 0    | 34   | 3    | 431        |
| Total       | 73                      | 348  | 0    | 6    | 0         | 0    | 0    | 0    | 0                       | 1194 | 114  | 11   | 87                     | 0    | 166  | 3    | 2002       |
| Grand Total | 121                     | 577  | 0    | 12   | 0         | 0    | 0    | 0    | 0                       | 2030 | 197  | 22   | 128                    | 0    | 249  | 4    | 3340       |
| Aprch %     | 17                      | 81.3 | 0    | 1.7  | 0         | 0    | 0    | 0    | 0                       | 90.3 | 8.8  | 1    | 33.6                   | 0    | 65.4 | 1    |            |
| Total %     | 3.6                     | 17.3 | 0    | 0.4  | 0         | 0    | 0    | 0    | 0                       | 60.8 | 5.9  | 0.7  | 3.8                    | 0    | 7.5  | 0.1  |            |

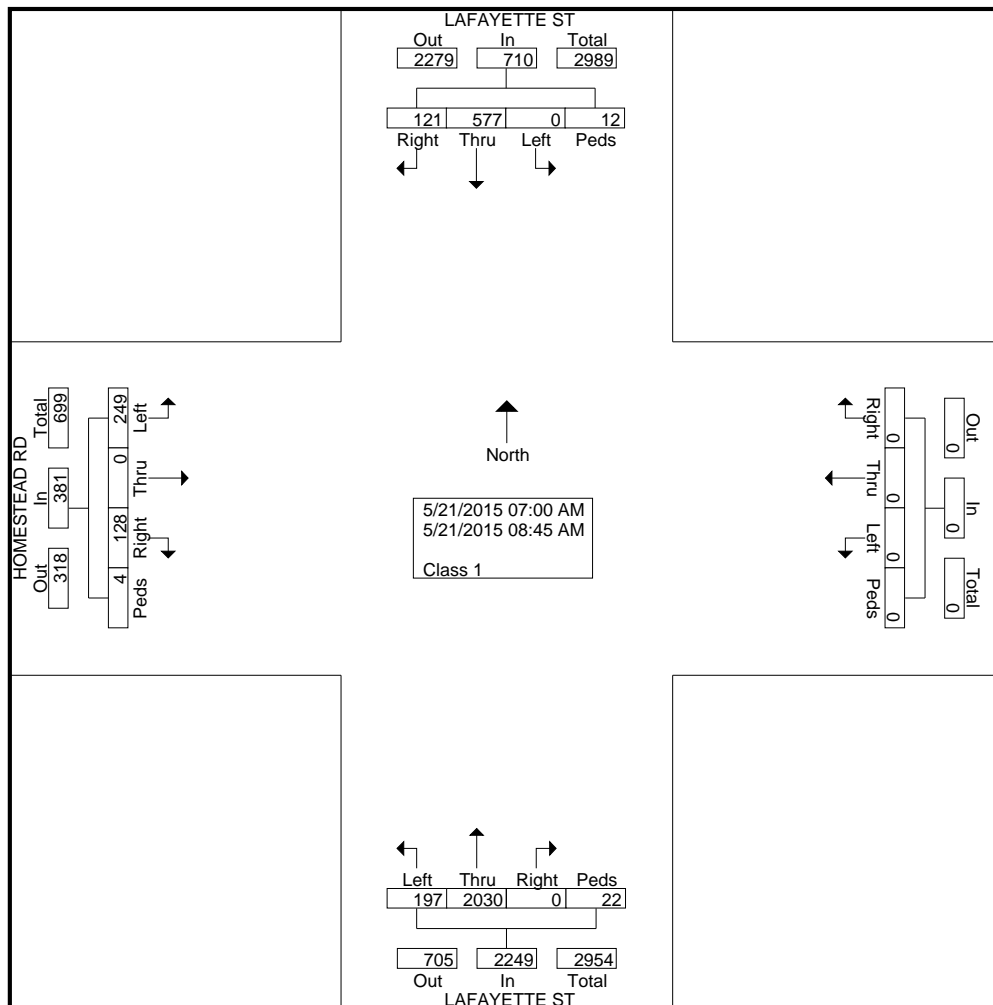

File Name : #19 HOMESTEAD&LAFAYETTE TEAM  
 Site Code :  
 Start Date : 5/21/2015  
 Page No : 2

| Start Time  | LAFAYETTE ST Southbound |      |      |      |            | Westbound |      |      |      |            | LAFAYETTE ST Northbound |      |      |      |            | HOMESTEAD RD Eastbound |      |      |      |            | Int. Total |
|---|-------------------------|------|------|------|------------|-----------|------|------|------|------------|-------------------------|------|------|------|------------|------------------------|------|------|------|------------|------------|
|   | Right                   | Thru | Left | Peds | App. Total | Right     | Thru | Left | Peds | App. Total | Right                   | Thru | Left | Peds | App. Total | Right                  | Thru | Left | Peds | App. Total |            |
| <b>Peak Hour Analysis From 07:00 AM to 08:45 AM - Peak 1 of 1</b> |                         |      |      |      |            |           |      |      |      |            |                         |      |      |      |            |                        |      |      |      |            |            |
| Peak Hour for Entire Intersection Begins at 07:45 AM              |                         |      |      |      |            |           |      |      |      |            |                         |      |      |      |            |                        |      |      |      |            |            |
| 07:45 AM  | 22                      | 85   | 0    | 2    | 109        | 0         | 0    | 0    | 0    | 0          | 0                       | 264  | 30   | 3    | 297        | 18                     | 0    | 36   | 0    | 54         | 460        |
| 08:00 AM  | 28                      | 118  | 0    | 2    | 148        | 0         | 0    | 0    | 0    | 0          | 0                       | 303  | 24   | 4    | 331        | 17                     | 0    | 56   | 0    | 73         | 552        |
| 08:15 AM  | 16                      | 104  | 0    | 3    | 123        | 0         | 0    | 0    | 0    | 0          | 0                       | 312  | 32   | 4    | 348        | 30                     | 0    | 43   | 0    | 73         | 544        |
| 08:30 AM  | 20                      | 65   | 0    | 0    | 85         | 0         | 0    | 0    | 0    | 0          | 0                       | 301  | 34   | 2    | 337        | 20                     | 0    | 33   | 0    | 53         | 475        |
| Total Volume  | 86                      | 372  | 0    | 7    | 465        | 0         | 0    | 0    | 0    | 0          | 0                       | 1180 | 120  | 13   | 1313       | 85                     | 0    | 168  | 0    | 253        | 2031       |
| % App. Total  | 18.5                    | 80   | 0    | 1.5  |            | 0         | 0    | 0    | 0    |            | 0                       | 89.9 | 9.1  | 1    |            | 33.6                   | 0    | 66.4 | 0    |            |            |
| PHF   | .768                    | .788 | .000 | .583 | .785       | .000      | .000 | .000 | .000 | .000       | .000                    | .946 | .882 | .813 | .943       | .708                   | .000 | .750 | .000 | .866       | .920       |

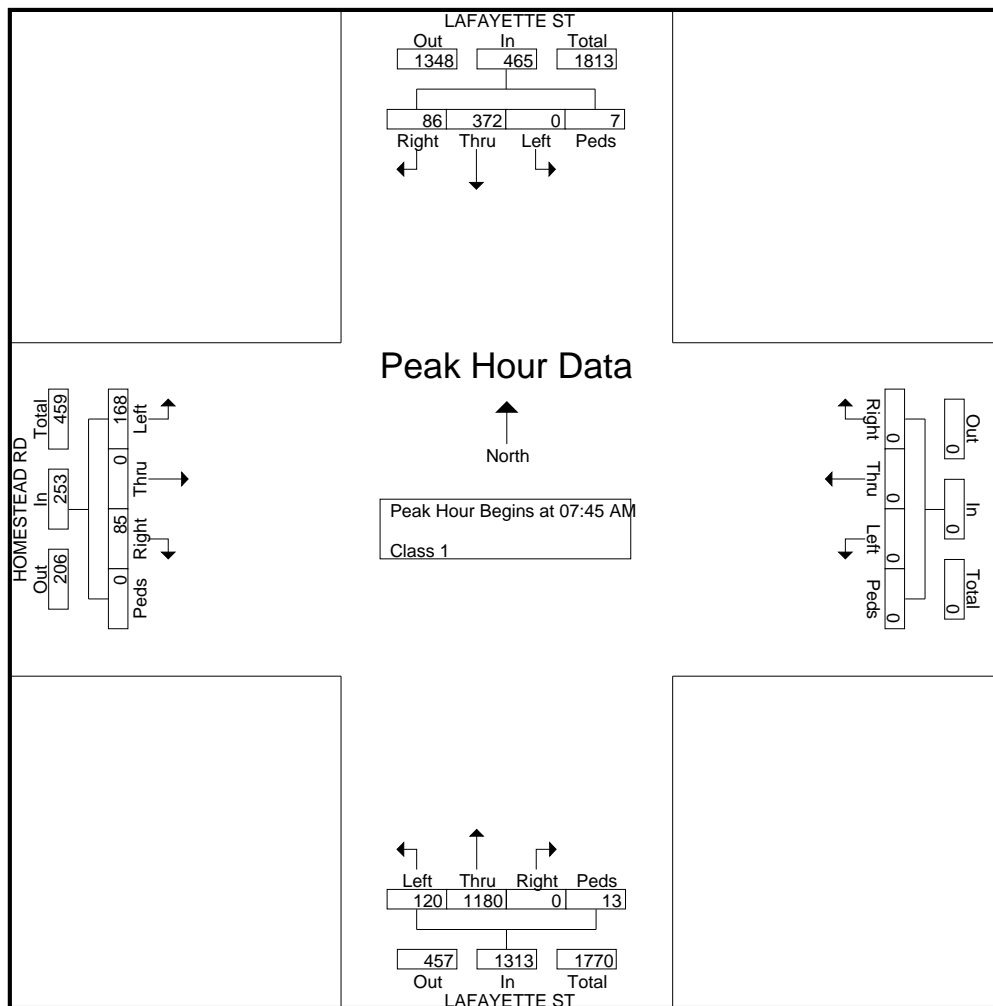

File Name : #19 HOMESTEAD&LAFAYETTEPM  
 Site Code :  
 Start Date : 5/20/2015  
 Page No : 1

Groups Printed- Class 1

| Start Time  | LAFAYETTE ST Southbound |      |      |      | Westbound |      |      |      | LAFAYETTE ST Northbound |      |      |      | HOMESTEAD RD Eastbound |      |      |      | Int. Total |
|-------------|-------------------------|------|------|------|-----------|------|------|------|-------------------------|------|------|------|------------------------|------|------|------|------------|
|             | Right                   | Thru | Left | Peds | Right     | Thru | Left | Peds | Right                   | Thru | Left | Peds | Right                  | Thru | Left | Peds |            |
| 04:00 PM    | 25                      | 270  | 0    | 7    | 0         | 0    | 0    | 0    | 0                       | 90   | 17   | 5    | 36                     | 0    | 16   | 1    | 467        |
| 04:15 PM    | 18                      | 256  | 0    | 4    | 0         | 0    | 0    | 0    | 0                       | 72   | 17   | 5    | 37                     | 0    | 29   | 2    | 440        |
| 04:30 PM    | 21                      | 293  | 0    | 8    | 0         | 0    | 0    | 0    | 0                       | 87   | 21   | 6    | 44                     | 0    | 20   | 3    | 503        |
| 04:45 PM    | 35                      | 296  | 0    | 6    | 0         | 0    | 0    | 0    | 0                       | 98   | 16   | 5    | 39                     | 0    | 27   | 4    | 526        |
| Total       | 99                      | 1115 | 0    | 25   | 0         | 0    | 0    | 0    | 0                       | 347  | 71   | 21   | 156                    | 0    | 92   | 10   | 1936       |
| 05:00 PM    | 44                      | 325  | 0    | 5    | 0         | 0    | 0    | 0    | 0                       | 102  | 15   | 11   | 37                     | 0    | 23   | 4    | 566        |
| 05:15 PM    | 36                      | 314  | 0    | 4    | 0         | 0    | 0    | 0    | 0                       | 93   | 24   | 11   | 36                     | 0    | 27   | 0    | 545        |
| 05:30 PM    | 61                      | 322  | 0    | 4    | 0         | 0    | 0    | 0    | 0                       | 86   | 17   | 1    | 30                     | 0    | 21   | 1    | 543        |
| 05:45 PM    | 37                      | 303  | 0    | 7    | 0         | 0    | 0    | 0    | 0                       | 92   | 18   | 2    | 37                     | 0    | 21   | 5    | 522        |
| Total       | 178                     | 1264 | 0    | 20   | 0         | 0    | 0    | 0    | 0                       | 373  | 74   | 25   | 140                    | 0    | 92   | 10   | 2176       |
| Grand Total | 277                     | 2379 | 0    | 45   | 0         | 0    | 0    | 0    | 0                       | 720  | 145  | 46   | 296                    | 0    | 184  | 20   | 4112       |
| Apprch %    | 10.3                    | 88.1 | 0    | 1.7  | 0         | 0    | 0    | 0    | 0                       | 79   | 15.9 | 5    | 59.2                   | 0    | 36.8 | 4    |            |
| Total %     | 6.7                     | 57.9 | 0    | 1.1  | 0         | 0    | 0    | 0    | 0                       | 17.5 | 3.5  | 1.1  | 7.2                    | 0    | 4.5  | 0.5  |            |

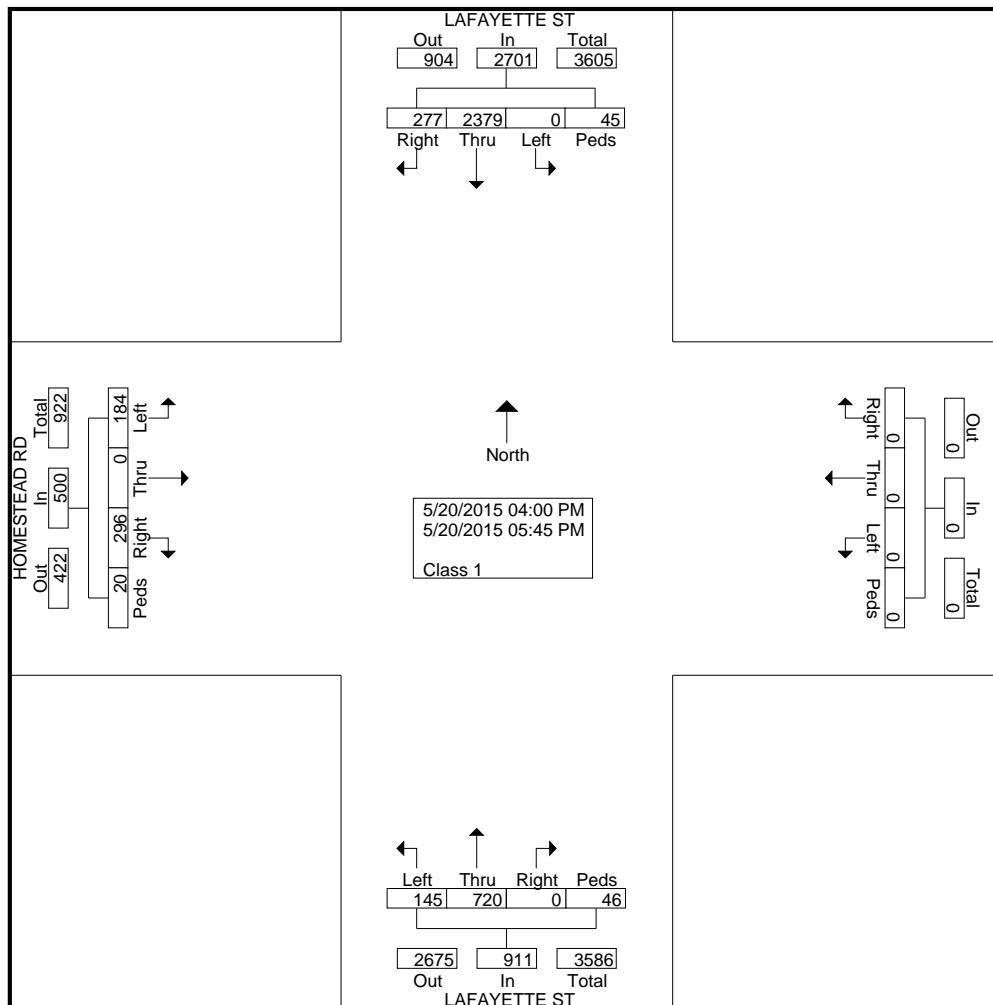

File Name : #19 HOMESTEAD&LAFAYETTEPM  
 Site Code :  
 Start Date : 5/20/2015  
 Page No : 2

| Start Time  | LAFAYETTE ST Southbound |      |      |      |            | Westbound |      |      |      |            | LAFAYETTE ST Northbound |      |      |      |            | HOMESTEAD RD Eastbound |      |      |      |            | Int. Total |
|---|-------------------------|------|------|------|------------|-----------|------|------|------|------------|-------------------------|------|------|------|------------|------------------------|------|------|------|------------|------------|
|   | Right                   | Thru | Left | Peds | App. Total | Right     | Thru | Left | Peds | App. Total | Right                   | Thru | Left | Peds | App. Total | Right                  | Thru | Left | Peds | App. Total |            |
| <b>Peak Hour Analysis From 04:00 PM to 05:45 PM - Peak 1 of 1</b> |                         |      |      |      |            |           |      |      |      |            |                         |      |      |      |            |                        |      |      |      |            |            |
| Peak Hour for Entire Intersection Begins at 04:45 PM              |                         |      |      |      |            |           |      |      |      |            |                         |      |      |      |            |                        |      |      |      |            |            |
| 04:45 PM  | 35                      | 296  | 0    | 6    | 337        | 0         | 0    | 0    | 0    | 0          | 0                       | 98   | 16   | 5    | 119        | 39                     | 0    | 27   | 4    | 70         | 526        |
| 05:00 PM  | 44                      | 325  | 0    | 5    | 374        | 0         | 0    | 0    | 0    | 0          | 0                       | 102  | 15   | 11   | 128        | 37                     | 0    | 23   | 4    | 64         | 566        |
| 05:15 PM  | 36                      | 314  | 0    | 4    | 354        | 0         | 0    | 0    | 0    | 0          | 0                       | 93   | 24   | 11   | 128        | 36                     | 0    | 27   | 0    | 63         | 545        |
| 05:30 PM  | 61                      | 322  | 0    | 4    | 387        | 0         | 0    | 0    | 0    | 0          | 0                       | 86   | 17   | 1    | 104        | 30                     | 0    | 21   | 1    | 52         | 543        |
| Total Volume  | 176                     | 1257 | 0    | 19   | 1452       | 0         | 0    | 0    | 0    | 0          | 0                       | 379  | 72   | 28   | 479        | 142                    | 0    | 98   | 9    | 249        | 2180       |
| % App. Total  | 12.1                    | 86.6 | 0    | 1.3  |            | 0         | 0    | 0    | 0    |            | 0                       | 79.1 | 15   | 5.8  |            | 57                     | 0    | 39.4 | 3.6  |            |            |
| PHF   | .721                    | .967 | .000 | .792 | .938       | .000      | .000 | .000 | .000 | .000       | .000                    | .929 | .750 | .636 | .936       | .910                   | .000 | .907 | .563 | .889       | .963       |

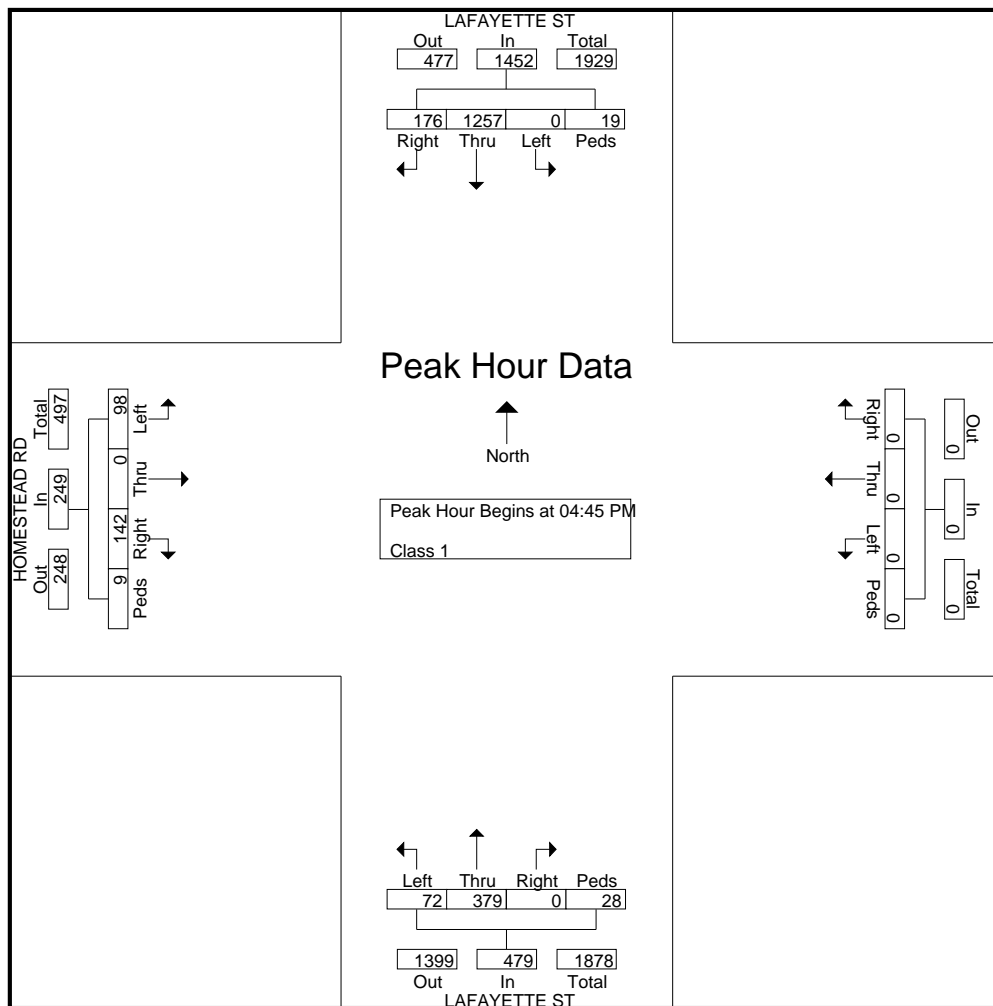

Groups Printed- Class 1

| Start Time  | COLEMAN AVE Southbound |      |      |           |      | LITTLE MARKET ST Southwestbound |            |           |           |      | JULIAN ST Westbound |       |      |      |      | MARKET ST Northbound |            |      |      |      | JULIAN ST Eastbound |      |           |      |      | Int. Total |      |
|-------------|------------------------|------|------|-----------|------|---------------------------------|------------|-----------|-----------|------|---------------------|-------|------|------|------|----------------------|------------|------|------|------|---------------------|------|-----------|------|------|------------|------|
|             | Right                  | Thru | Left | Hard Left | Peds | Hard Right                      | Bear Right | Bear Left | Hard Left | Peds | Hard Right          | Right | Thru | Left | Peds | Right                | Bear Right | Thru | Left | Peds | Right               | Thru | Bear Left | Left | Peds |            |      |
| 07:00 AM    | 14                     | 35   | 0    | 0         | 0    | 0                               | 0          | 0         | 0         | 0    | 4                   | 70    | 66   | 18   | 1    | 0                    | 2          | 183  | 8    | 3    | 0                   | 0    | 0         | 0    | 0    | 6          | 410  |
| 07:15 AM    | 20                     | 70   | 0    | 0         | 0    | 0                               | 0          | 0         | 0         | 0    | 2                   | 87    | 114  | 21   | 1    | 0                    | 3          | 264  | 8    | 3    | 0                   | 0    | 0         | 0    | 0    | 2          | 595  |
| 07:30 AM    | 24                     | 76   | 0    | 0         | 0    | 0                               | 0          | 0         | 0         | 0    | 2                   | 107   | 119  | 20   | 6    | 0                    | 4          | 298  | 10   | 3    | 0                   | 0    | 0         | 0    | 0    | 4          | 673  |
| 07:45 AM    | 22                     | 101  | 0    | 0         | 0    | 0                               | 0          | 0         | 0         | 1    | 1                   | 89    | 141  | 25   | 4    | 0                    | 6          | 283  | 10   | 2    | 0                   | 0    | 0         | 0    | 0    | 2          | 687  |
| Total       | 80                     | 282  | 0    | 0         | 0    | 0                               | 0          | 0         | 0         | 1    | 9                   | 353   | 440  | 84   | 12   | 0                    | 15         | 1028 | 36   | 11   | 0                   | 0    | 0         | 0    | 0    | 14         | 2365 |
| 08:00 AM    | 32                     | 83   | 0    | 0         | 1    | 0                               | 0          | 0         | 0         | 0    | 1                   | 98    | 104  | 27   | 5    | 0                    | 15         | 235  | 7    | 2    | 0                   | 0    | 0         | 0    | 0    | 2          | 612  |
| 08:15 AM    | 23                     | 90   | 0    | 0         | 0    | 0                               | 0          | 0         | 0         | 0    | 2                   | 80    | 98   | 34   | 3    | 0                    | 5          | 248  | 16   | 2    | 0                   | 0    | 0         | 0    | 0    | 1          | 602  |
| 08:30 AM    | 22                     | 99   | 0    | 0         | 0    | 0                               | 0          | 0         | 0         | 0    | 3                   | 74    | 110  | 30   | 8    | 0                    | 8          | 255  | 4    | 7    | 0                   | 0    | 0         | 0    | 0    | 2          | 622  |
| 08:45 AM    | 26                     | 93   | 0    | 0         | 0    | 0                               | 0          | 0         | 0         | 0    | 5                   | 74    | 127  | 27   | 6    | 0                    | 9          | 198  | 11   | 6    | 0                   | 0    | 0         | 0    | 0    | 3          | 585  |
| Total       | 103                    | 365  | 0    | 0         | 1    | 0                               | 0          | 0         | 0         | 0    | 11                  | 326   | 439  | 118  | 22   | 0                    | 37         | 936  | 38   | 17   | 0                   | 0    | 0         | 0    | 0    | 8          | 2421 |
| Grand Total | 183                    | 647  | 0    | 0         | 1    | 0                               | 0          | 0         | 0         | 1    | 20                  | 679   | 879  | 202  | 34   | 0                    | 52         | 1964 | 74   | 28   | 0                   | 0    | 0         | 0    | 0    | 22         | 4786 |
| Apprch %    | 22                     | 77.9 | 0    | 0         | 0.1  | 0                               | 0          | 0         | 0         | 100  | 1.1                 | 37.4  | 48.5 | 11.1 | 1.9  | 0                    | 2.5        | 92.7 | 3.5  | 1.3  | 0                   | 0    | 0         | 0    | 0    | 100        |      |
| Total %     | 3.8                    | 13.5 | 0    | 0         | 0    | 0                               | 0          | 0         | 0         | 0    | 0.4                 | 14.2  | 18.4 | 4.2  | 0.7  | 0                    | 1.1        | 41   | 1.5  | 0.6  | 0                   | 0    | 0         | 0    | 0    | 0.5        |      |

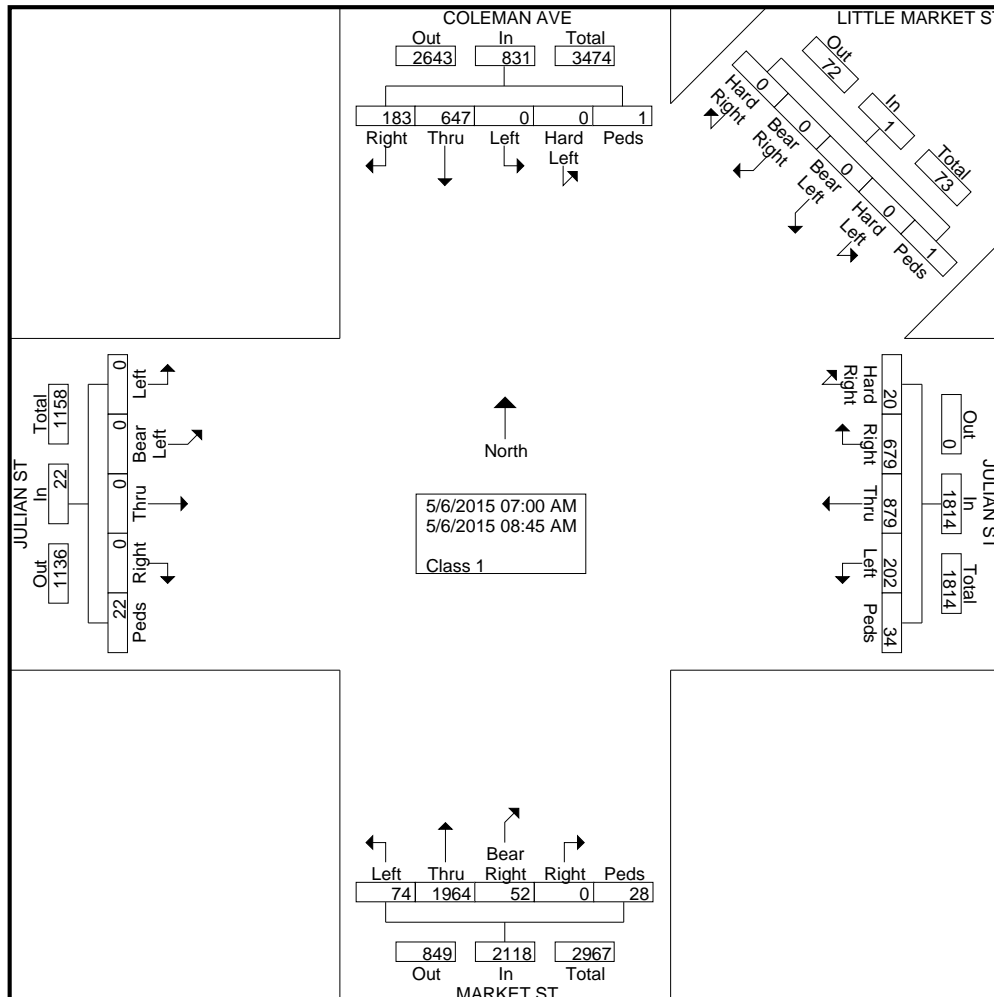

| Start Time | COLEMAN AVE Southbound |      |      |           |       |            | LITTLE MARKET ST Southwestbound |             |           |           |       |            | JULIAN ST Westbound |        |      |      |       |            | MARKET ST Northbound |             |      |      |       |            | JULIAN ST Eastbound |      |           |      |       |            | Int. Total |
|------------|------------------------|------|------|-----------|-------|------------|---------------------------------|-------------|-----------|-----------|-------|------------|---------------------|--------|------|------|-------|------------|----------------------|-------------|------|------|-------|------------|---------------------|------|-----------|------|-------|------------|------------|
|            | Righ t                 | Thru | Left | Hard Left | Ped s | App. Total | Hard Righ t                     | Bear Righ t | Bear Left | Hard Left | Ped s | App. Total | Hard Righ t         | Righ t | Thru | Left | Ped s | App. Total | Righ t               | Bear Righ t | Thru | Left | Ped s | App. Total | Righ t              | Thru | Bear Left | Left | Ped s | App. Total |            |

**Peak Hour Analysis From 07:00 AM to 08:45 AM - Peak 1 of 1**  
 Peak Hour for Entire Intersection Begins at 07:30 AM

|              |      |      |      |      |      |      |      |      |      |      |      |      |      |      |      |      |      |      |      |      |      |      |      |      |      |      |      |      |      |      |      |
|--------------|------|------|------|------|------|------|------|------|------|------|------|------|------|------|------|------|------|------|------|------|------|------|------|------|------|------|------|------|------|------|------|
| 07:30 AM     | 24   | 76   | 0    | 0    | 0    | 100  | 0    | 0    | 0    | 0    | 0    | 0    | 2    | 107  | 119  | 20   | 6    | 254  | 0    | 4    | 298  | 10   | 3    | 315  | 0    | 0    | 0    | 0    | 4    | 4    | 673  |
| 07:45 AM     | 22   | 101  | 0    | 0    | 0    | 123  | 0    | 0    | 0    | 0    | 1    | 1    | 1    | 89   | 141  | 25   | 4    | 260  | 0    | 6    | 283  | 10   | 2    | 301  | 0    | 0    | 0    | 0    | 2    | 2    | 687  |
| 08:00 AM     | 32   | 83   | 0    | 0    | 1    | 116  | 0    | 0    | 0    | 0    | 0    | 0    | 1    | 98   | 104  | 27   | 5    | 235  | 0    | 15   | 235  | 7    | 2    | 259  | 0    | 0    | 0    | 0    | 2    | 2    | 612  |
| 08:15 AM     | 23   | 90   | 0    | 0    | 0    | 113  | 0    | 0    | 0    | 0    | 0    | 0    | 2    | 80   | 98   | 34   | 3    | 217  | 0    | 5    | 248  | 16   | 2    | 271  | 0    | 0    | 0    | 0    | 1    | 1    | 602  |
| Total Volume | 101  | 350  | 0    | 0    | 1    | 452  | 0    | 0    | 0    | 0    | 1    | 1    | 6    | 374  | 462  | 106  | 18   | 966  | 0    | 30   | 1064 | 43   | 9    | 1146 | 0    | 0    | 0    | 0    | 9    | 9    | 2574 |
| % App. Total | 22.3 | 77.4 | 0    | 0    | 0.2  |      | 0    | 0    | 0    | 0    | 100  |      | 0.6  | 38.7 | 47.8 | 11   | 1.9  |      | 0    | 2.6  | 92.8 | 3.8  | 0.8  |      | 0    | 0    | 0    | 0    | 100  |      |      |
| PHF          | .789 | .866 | .000 | .000 | .250 | .919 | .000 | .000 | .000 | .000 | .250 | .250 | .750 | .874 | .819 | .779 | .750 | .929 | .000 | .500 | .893 | .672 | .750 | .910 | .000 | .000 | .000 | .000 | .563 | .563 | .937 |

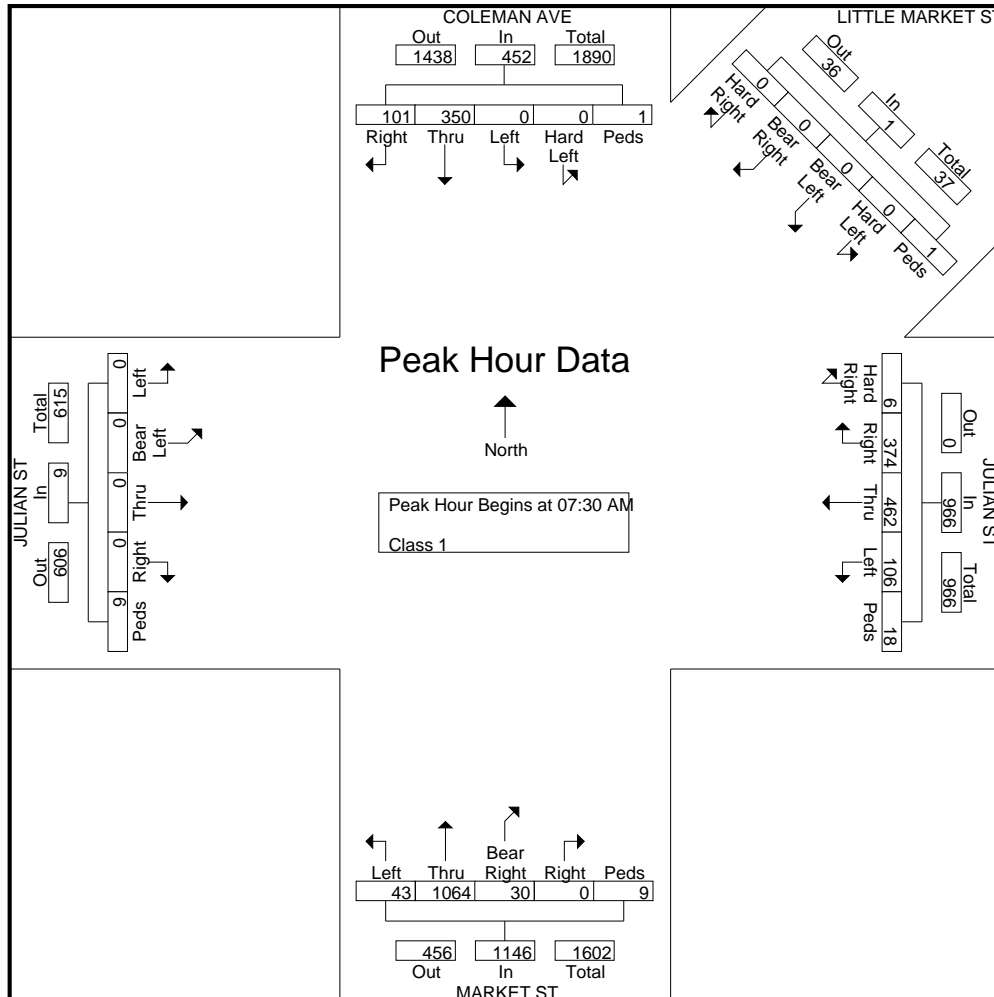

Groups Printed- Class 1

| Start Time  | COLEMAN AVE Southbound |      |      |           |      | LITTLE MARKET ST Southwestbound |            |           |           |      | JULIAN ST Westbound |       |      |      |      | MARKET ST Northbound |            |      |      |      | JULIAN ST Eastbound |      |           |      |      | Int. Total |
|-------------|------------------------|------|------|-----------|------|---------------------------------|------------|-----------|-----------|------|---------------------|-------|------|------|------|----------------------|------------|------|------|------|---------------------|------|-----------|------|------|------------|
|             | Right                  | Thru | Left | Hard Left | Peds | Hard Right                      | Bear Right | Bear Left | Hard Left | Peds | Hard Right          | Right | Thru | Left | Peds | Right                | Bear Right | Thru | Left | Peds | Right               | Thru | Bear Left | Left | Peds |            |
| 04:00 PM    | 87                     | 163  | 0    | 0         | 0    | 0                               | 0          | 0         | 0         | 0    | 2                   | 42    | 104  | 44   | 0    | 0                    | 12         | 116  | 20   | 1    | 0                   | 0    | 0         | 0    | 7    | 598        |
| 04:15 PM    | 78                     | 192  | 0    | 0         | 0    | 0                               | 0          | 0         | 0         | 0    | 5                   | 36    | 119  | 58   | 1    | 0                    | 5          | 82   | 19   | 2    | 2                   | 0    | 0         | 0    | 4    | 603        |
| 04:30 PM    | 89                     | 219  | 0    | 0         | 0    | 0                               | 0          | 0         | 0         | 0    | 5                   | 32    | 108  | 48   | 1    | 0                    | 6          | 120  | 30   | 2    | 0                   | 0    | 0         | 0    | 2    | 662        |
| 04:45 PM    | 128                    | 229  | 0    | 0         | 0    | 0                               | 0          | 0         | 0         | 0    | 4                   | 34    | 96   | 68   | 4    | 0                    | 6          | 127  | 18   | 2    | 0                   | 0    | 0         | 0    | 4    | 720        |
| Total       | 382                    | 803  | 0    | 0         | 0    | 0                               | 0          | 0         | 0         | 0    | 16                  | 144   | 427  | 218  | 6    | 0                    | 29         | 445  | 87   | 7    | 2                   | 0    | 0         | 0    | 17   | 2583       |
| 05:00 PM    | 122                    | 250  | 0    | 0         | 0    | 0                               | 0          | 0         | 0         | 0    | 3                   | 47    | 129  | 35   | 5    | 0                    | 8          | 134  | 30   | 6    | 0                   | 0    | 0         | 0    | 3    | 772        |
| 05:15 PM    | 119                    | 211  | 0    | 1         | 0    | 0                               | 0          | 0         | 0         | 0    | 4                   | 39    | 112  | 74   | 3    | 0                    | 14         | 131  | 24   | 8    | 0                   | 0    | 0         | 0    | 3    | 743        |
| 05:30 PM    | 117                    | 262  | 0    | 0         | 0    | 0                               | 0          | 0         | 0         | 0    | 2                   | 40    | 126  | 65   | 4    | 0                    | 4          | 150  | 16   | 4    | 0                   | 0    | 0         | 0    | 6    | 796        |
| 05:45 PM    | 114                    | 240  | 0    | 0         | 0    | 0                               | 0          | 0         | 0         | 0    | 3                   | 47    | 125  | 60   | 3    | 0                    | 15         | 130  | 12   | 6    | 0                   | 0    | 0         | 0    | 4    | 759        |
| Total       | 472                    | 963  | 0    | 1         | 0    | 0                               | 0          | 0         | 0         | 0    | 12                  | 173   | 492  | 234  | 15   | 0                    | 41         | 545  | 82   | 24   | 0                   | 0    | 0         | 0    | 16   | 3070       |
| Grand Total | 854                    | 1766 | 0    | 1         | 0    | 0                               | 0          | 0         | 0         | 0    | 28                  | 317   | 919  | 452  | 21   | 0                    | 70         | 990  | 169  | 31   | 2                   | 0    | 0         | 0    | 33   | 5653       |
| Apprch %    | 32.6                   | 67.4 | 0    | 0         | 0    | 0                               | 0          | 0         | 0         | 0    | 1.6                 | 18.2  | 52.9 | 26   | 1.2  | 0                    | 5.6        | 78.6 | 13.4 | 2.5  | 5.7                 | 0    | 0         | 0    | 0    | 94.3       |
| Total %     | 15.1                   | 31.2 | 0    | 0         | 0    | 0                               | 0          | 0         | 0         | 0    | 0.5                 | 5.6   | 16.3 | 8    | 0.4  | 0                    | 1.2        | 17.5 | 3    | 0.5  | 0                   | 0    | 0         | 0    | 0.6  |            |

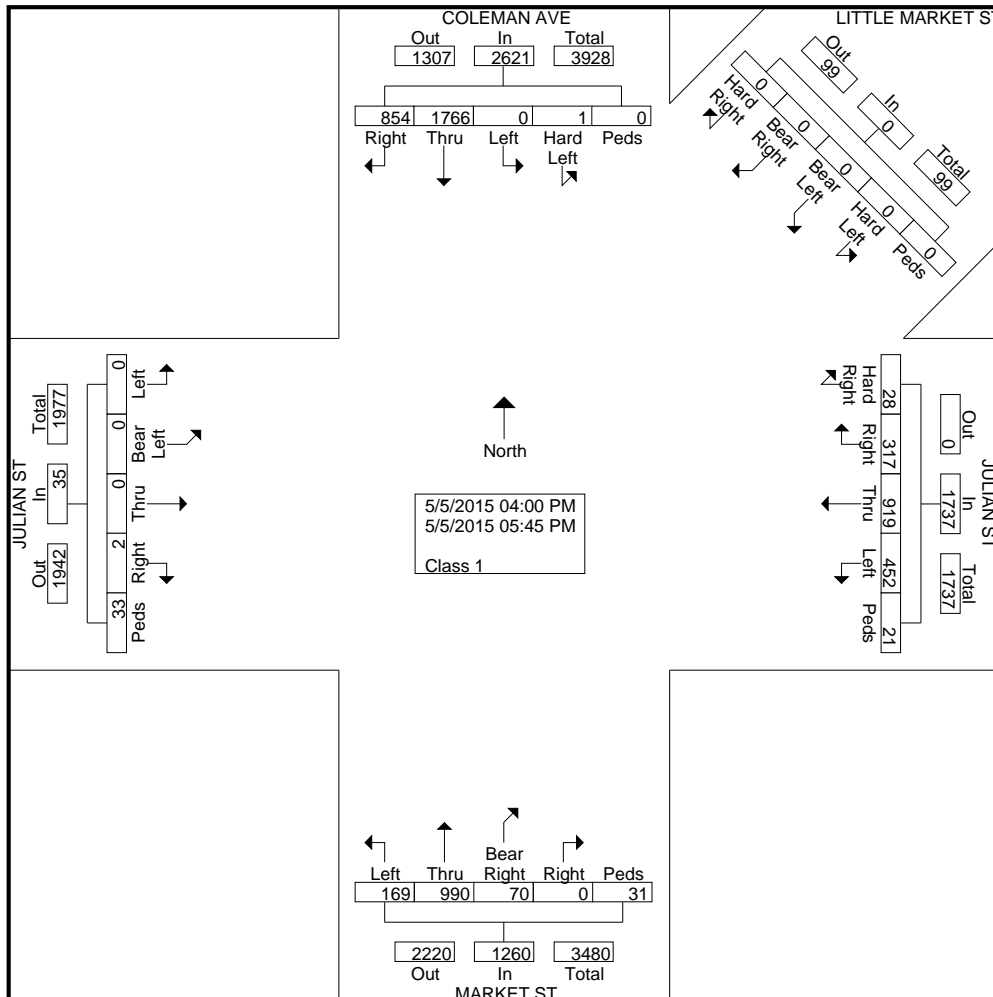

| Start Time | COLEMAN AVE Southbound |      |      |           |      |            | LITTLE MARKET ST Southwestbound |           |           |           |      |            | JULIAN ST Westbound |      |      |      |      |            | MARKET ST Northbound |           |      |      |      |            | JULIAN ST Eastbound |      |           |      |      |            | Int. Total |
|------------|------------------------|------|------|-----------|------|------------|---------------------------------|-----------|-----------|-----------|------|------------|---------------------|------|------|------|------|------------|----------------------|-----------|------|------|------|------------|---------------------|------|-----------|------|------|------------|------------|
|            | Rght                   | Thru | Left | Hard Left | Peds | App. Total | Hard Rght                       | Bear Rght | Bear Left | Hard Left | Peds | App. Total | Hard Rght           | Rght | Thru | Left | Peds | App. Total | Rght                 | Bear Rght | Thru | Left | Peds | App. Total | Rght                | Thru | Bear Left | Left | Peds | App. Total |            |

**Peak Hour Analysis From 04:00 PM to 05:45 PM - Peak 1 of 1**  
 Peak Hour for Entire Intersection Begins at 05:00 PM

|              |      |      |      |      |      |      |      |      |      |      |      |      |      |      |      |      |      |      |      |      |      |      |      |      |      |      |      |      |      |      |      |
|--------------|------|------|------|------|------|------|------|------|------|------|------|------|------|------|------|------|------|------|------|------|------|------|------|------|------|------|------|------|------|------|------|
| 05:00 PM     | 122  | 250  | 0    | 0    | 0    | 372  | 0    | 0    | 0    | 0    | 0    | 0    | 3    | 47   | 129  | 35   | 5    | 219  | 0    | 8    | 134  | 30   | 6    | 178  | 0    | 0    | 0    | 0    | 3    | 3    | 772  |
| 05:15 PM     | 119  | 211  | 0    | 1    | 0    | 331  | 0    | 0    | 0    | 0    | 0    | 0    | 4    | 39   | 112  | 74   | 3    | 232  | 0    | 14   | 131  | 24   | 8    | 177  | 0    | 0    | 0    | 0    | 3    | 3    | 743  |
| 05:30 PM     | 117  | 262  | 0    | 0    | 0    | 379  | 0    | 0    | 0    | 0    | 0    | 0    | 2    | 40   | 126  | 65   | 4    | 237  | 0    | 4    | 150  | 16   | 4    | 174  | 0    | 0    | 0    | 0    | 6    | 6    | 796  |
| 05:45 PM     | 114  | 240  | 0    | 0    | 0    | 354  | 0    | 0    | 0    | 0    | 0    | 0    | 3    | 47   | 125  | 60   | 3    | 238  | 0    | 15   | 130  | 12   | 6    | 163  | 0    | 0    | 0    | 0    | 4    | 4    | 759  |
| Total Volume | 472  | 963  | 0    | 1    | 0    | 1436 | 0    | 0    | 0    | 0    | 0    | 0    | 12   | 173  | 492  | 234  | 15   | 926  | 0    | 41   | 545  | 82   | 24   | 692  | 0    | 0    | 0    | 0    | 16   | 16   | 3070 |
| % App. Total | 32.9 | 67.1 | 0    | 0.1  | 0    |      | 0    | 0    | 0    | 0    | 0    | 0    | 1.3  | 18.7 | 53.1 | 25.3 | 1.6  |      | 0    | 5.9  | 78.8 | 11.8 | 3.5  |      | 0    | 0    | 0    | 0    | 100  |      |      |
| PHF          | .967 | .919 | .000 | .250 | .000 | .947 | .000 | .000 | .000 | .000 | .000 | .000 | .750 | .920 | .953 | .791 | .750 | .973 | .000 | .683 | .908 | .683 | .750 | .972 | .000 | .000 | .000 | .000 | .667 | .667 | .964 |

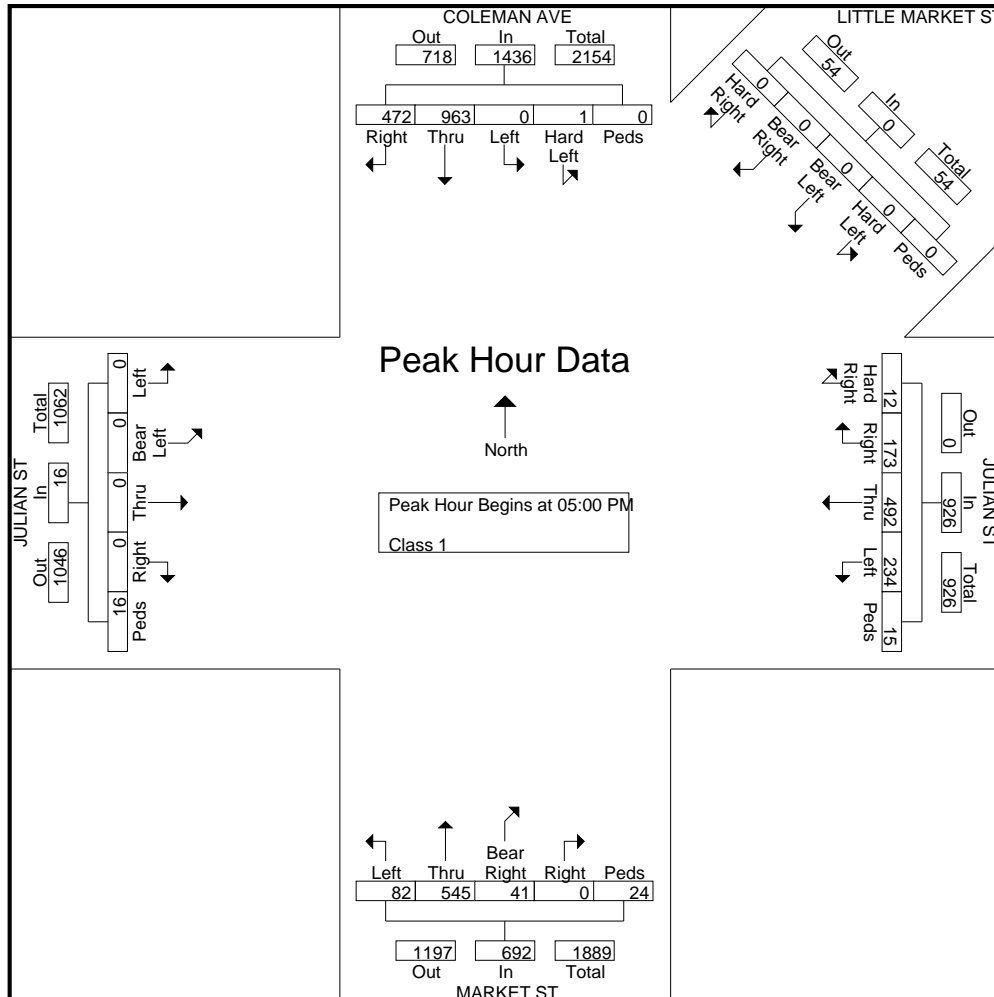



File Name : #20 LAFAYETTE&MARKETAM  
 Site Code :  
 Start Date : 5/21/2015  
 Page No : 1

Groups Printed- Class 1

| Start Time  | LAFAYETTE ST Southbound |      |      |      | MARKET ST Westbound |      |      |      | LAFAYETTE ST Northbound |      |      |      | MARKET ST Eastbound |      |      |      | Int. Total |
|-------------|-------------------------|------|------|------|---------------------|------|------|------|-------------------------|------|------|------|---------------------|------|------|------|------------|
|             | Right                   | Thru | Left | Peds | Right               | Thru | Left | Peds | Right                   | Thru | Left | Peds | Right               | Thru | Left | Peds |            |
| 07:00 AM    | 6                       | 19   | 8    | 2    | 39                  | 5    | 0    | 1    | 0                       | 131  | 5    | 0    | 3                   | 1    | 2    | 0    | 222        |
| 07:15 AM    | 4                       | 35   | 12   | 1    | 41                  | 7    | 1    | 1    | 1                       | 169  | 5    | 1    | 1                   | 3    | 5    | 0    | 287        |
| 07:30 AM    | 19                      | 44   | 16   | 1    | 48                  | 11   | 0    | 2    | 2                       | 225  | 5    | 2    | 2                   | 6    | 12   | 0    | 395        |
| 07:45 AM    | 28                      | 46   | 27   | 3    | 59                  | 23   | 1    | 1    | 5                       | 262  | 30   | 1    | 4                   | 9    | 20   | 0    | 519        |
| Total       | 57                      | 144  | 63   | 7    | 187                 | 46   | 2    | 5    | 8                       | 787  | 45   | 4    | 10                  | 19   | 39   | 0    | 1423       |
| 08:00 AM    | 35                      | 76   | 36   | 2    | 70                  | 18   | 3    | 3    | 3                       | 253  | 18   | 1    | 7                   | 12   | 29   | 0    | 566        |
| 08:15 AM    | 17                      | 92   | 38   | 4    | 69                  | 7    | 0    | 6    | 1                       | 256  | 15   | 4    | 1                   | 21   | 18   | 4    | 553        |
| 08:30 AM    | 5                       | 48   | 22   | 4    | 58                  | 6    | 3    | 1    | 0                       | 272  | 15   | 2    | 3                   | 17   | 6    | 0    | 462        |
| 08:45 AM    | 4                       | 53   | 29   | 5    | 42                  | 10   | 4    | 2    | 4                       | 235  | 10   | 6    | 2                   | 12   | 4    | 2    | 424        |
| Total       | 61                      | 269  | 125  | 15   | 239                 | 41   | 10   | 12   | 8                       | 1016 | 58   | 13   | 13                  | 62   | 57   | 6    | 2005       |
| Grand Total | 118                     | 413  | 188  | 22   | 426                 | 87   | 12   | 17   | 16                      | 1803 | 103  | 17   | 23                  | 81   | 96   | 6    | 3428       |
| Apprch %    | 15.9                    | 55.7 | 25.4 | 3    | 78.6                | 16.1 | 2.2  | 3.1  | 0.8                     | 93   | 5.3  | 0.9  | 11.2                | 39.3 | 46.6 | 2.9  |            |
| Total %     | 3.4                     | 12   | 5.5  | 0.6  | 12.4                | 2.5  | 0.4  | 0.5  | 0.5                     | 52.6 | 3    | 0.5  | 0.7                 | 2.4  | 2.8  | 0.2  |            |

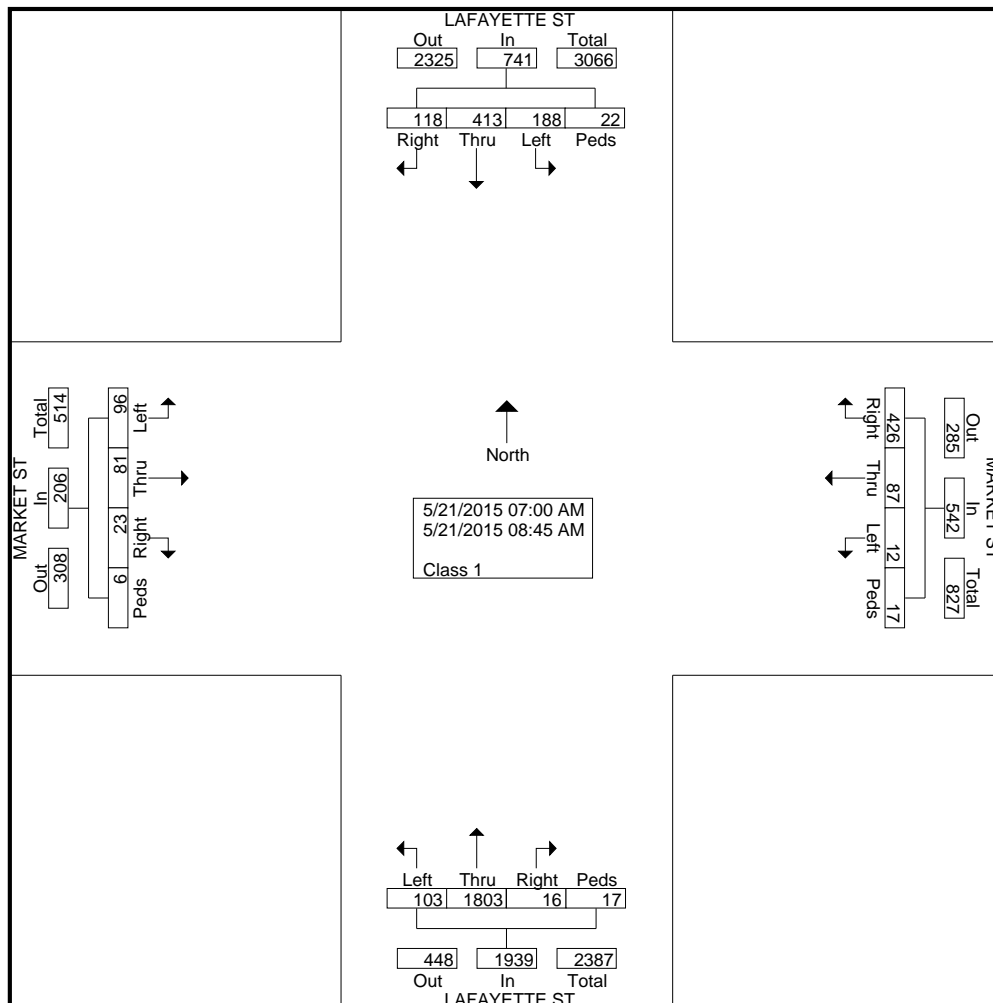

File Name : #20 LAFAYETTE&MARKETAM  
 Site Code :  
 Start Date : 5/21/2015  
 Page No : 2

| Start Time  | LAFAYETTE ST Southbound |      |      |      |            | MARKET ST Westbound |      |      |      |            | LAFAYETTE ST Northbound |      |      |      |            | MARKET ST Eastbound |      |      |      |            | Int. Total |
|---|-------------------------|------|------|------|------------|---------------------|------|------|------|------------|-------------------------|------|------|------|------------|---------------------|------|------|------|------------|------------|
|   | Right                   | Thru | Left | Peds | App. Total | Right               | Thru | Left | Peds | App. Total | Right                   | Thru | Left | Peds | App. Total | Right               | Thru | Left | Peds | App. Total |            |
| <b>Peak Hour Analysis From 07:00 AM to 08:45 AM - Peak 1 of 1</b> |                         |      |      |      |            |                     |      |      |      |            |                         |      |      |      |            |                     |      |      |      |            |            |
| Peak Hour for Entire Intersection Begins at 07:45 AM              |                         |      |      |      |            |                     |      |      |      |            |                         |      |      |      |            |                     |      |      |      |            |            |
| 07:45 AM  | 28                      | 46   | 27   | 3    | 104        | 59                  | 23   | 1    | 1    | 84         | 5                       | 262  | 30   | 1    | 298        | 4                   | 9    | 20   | 0    | 33         | 519        |
| 08:00 AM  | 35                      | 76   | 36   | 2    | 149        | 70                  | 18   | 3    | 3    | 94         | 3                       | 253  | 18   | 1    | 275        | 7                   | 12   | 29   | 0    | 48         | 566        |
| 08:15 AM  | 17                      | 92   | 38   | 4    | 151        | 69                  | 7    | 0    | 6    | 82         | 1                       | 256  | 15   | 4    | 276        | 1                   | 21   | 18   | 4    | 44         | 553        |
| 08:30 AM  | 5                       | 48   | 22   | 4    | 79         | 58                  | 6    | 3    | 1    | 68         | 0                       | 272  | 15   | 2    | 289        | 3                   | 17   | 6    | 0    | 26         | 462        |
| Total Volume  | 85                      | 262  | 123  | 13   | 483        | 256                 | 54   | 7    | 11   | 328        | 9                       | 1043 | 78   | 8    | 1138       | 15                  | 59   | 73   | 4    | 151        | 2100       |
| % App. Total  | 17.6                    | 54.2 | 25.5 | 2.7  |            | 78                  | 16.5 | 2.1  | 3.4  |            | 0.8                     | 91.7 | 6.9  | 0.7  |            | 9.9                 | 39.1 | 48.3 | 2.6  |            |            |
| PHF   | .607                    | .712 | .809 | .813 | .800       | .914                | .587 | .583 | .458 | .872       | .450                    | .959 | .650 | .500 | .955       | .536                | .702 | .629 | .250 | .786       | .928       |

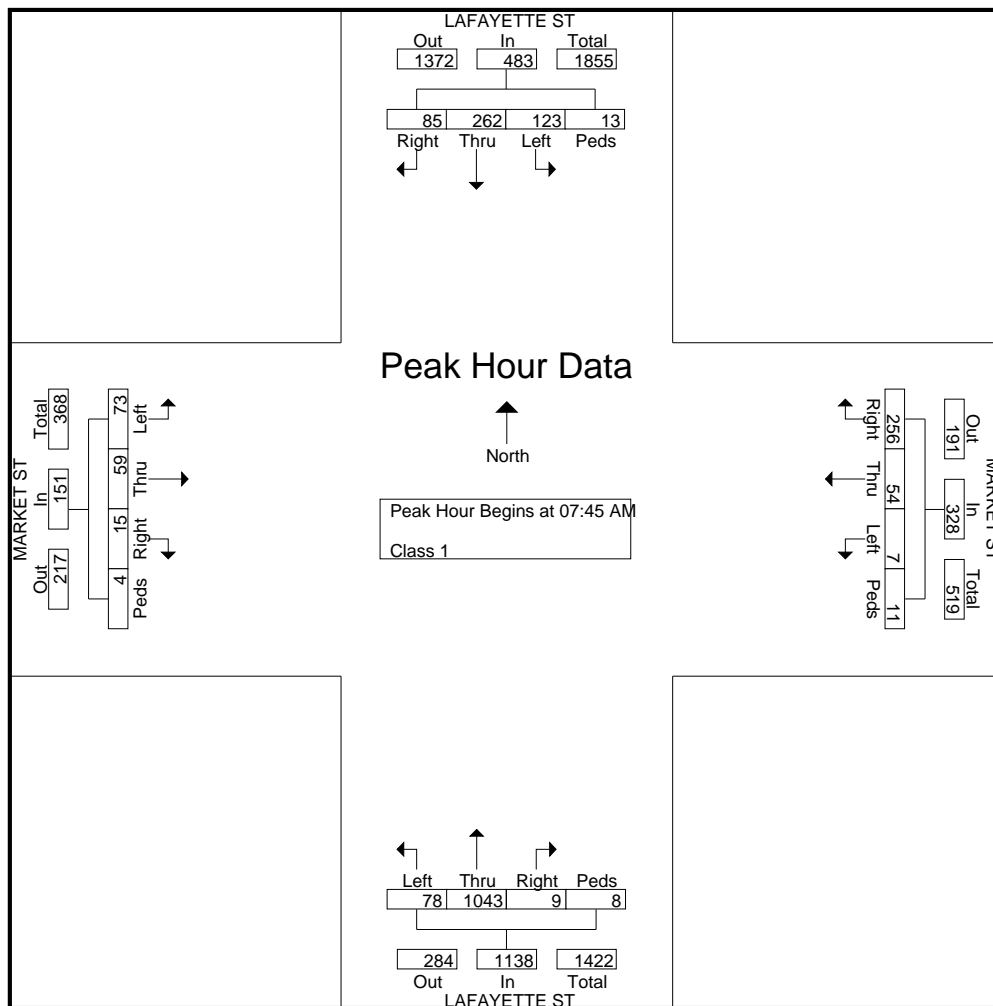

File Name : #20 LAFAYETTE&MARKETPM  
 Site Code :  
 Start Date : 5/20/2015  
 Page No : 1

Groups Printed- Class 1

| Start Time  | LAFAYETTE ST Southbound |      |      |      | MARKET ST Westbound |      |      |      | LAFAYETTE ST Northbound |      |      |      | MARKET ST Eastbound |      |      |      | Int. Total |
|-------------|-------------------------|------|------|------|---------------------|------|------|------|-------------------------|------|------|------|---------------------|------|------|------|------------|
|             | Right                   | Thru | Left | Peds | Right               | Thru | Left | Peds | Right                   | Thru | Left | Peds | Right               | Thru | Left | Peds |            |
| 04:00 PM    | 6                       | 249  | 66   | 6    | 31                  | 14   | 2    | 5    | 2                       | 71   | 7    | 7    | 0                   | 9    | 5    | 2    | 482        |
| 04:15 PM    | 3                       | 211  | 67   | 2    | 30                  | 11   | 2    | 4    | 8                       | 54   | 11   | 3    | 2                   | 5    | 5    | 0    | 418        |
| 04:30 PM    | 4                       | 247  | 76   | 5    | 28                  | 17   | 3    | 3    | 5                       | 76   | 10   | 4    | 6                   | 14   | 5    | 3    | 506        |
| 04:45 PM    | 5                       | 241  | 63   | 5    | 36                  | 20   | 3    | 2    | 3                       | 80   | 11   | 14   | 6                   | 13   | 1    | 2    | 505        |
| Total       | 18                      | 948  | 272  | 18   | 125                 | 62   | 10   | 14   | 18                      | 281  | 39   | 28   | 14                  | 41   | 16   | 7    | 1911       |
| 05:00 PM    | 7                       | 280  | 85   | 10   | 45                  | 24   | 1    | 4    | 6                       | 82   | 9    | 2    | 1                   | 12   | 3    | 4    | 575        |
| 05:15 PM    | 6                       | 249  | 63   | 16   | 32                  | 25   | 5    | 15   | 8                       | 86   | 19   | 15   | 2                   | 17   | 5    | 4    | 567        |
| 05:30 PM    | 4                       | 311  | 94   | 10   | 22                  | 21   | 7    | 3    | 4                       | 70   | 12   | 7    | 3                   | 12   | 1    | 0    | 581        |
| 05:45 PM    | 3                       | 254  | 74   | 17   | 27                  | 23   | 6    | 12   | 4                       | 103  | 9    | 17   | 4                   | 18   | 4    | 9    | 584        |
| Total       | 20                      | 1094 | 316  | 53   | 126                 | 93   | 19   | 34   | 22                      | 341  | 49   | 41   | 10                  | 59   | 13   | 17   | 2307       |
| Grand Total | 38                      | 2042 | 588  | 71   | 251                 | 155  | 29   | 48   | 40                      | 622  | 88   | 69   | 24                  | 100  | 29   | 24   | 4218       |
| Apprch %    | 1.4                     | 74.6 | 21.5 | 2.6  | 52                  | 32.1 | 6    | 9.9  | 4.9                     | 75.9 | 10.7 | 8.4  | 13.6                | 56.5 | 16.4 | 13.6 |            |
| Total %     | 0.9                     | 48.4 | 13.9 | 1.7  | 6                   | 3.7  | 0.7  | 1.1  | 0.9                     | 14.7 | 2.1  | 1.6  | 0.6                 | 2.4  | 0.7  | 0.6  |            |

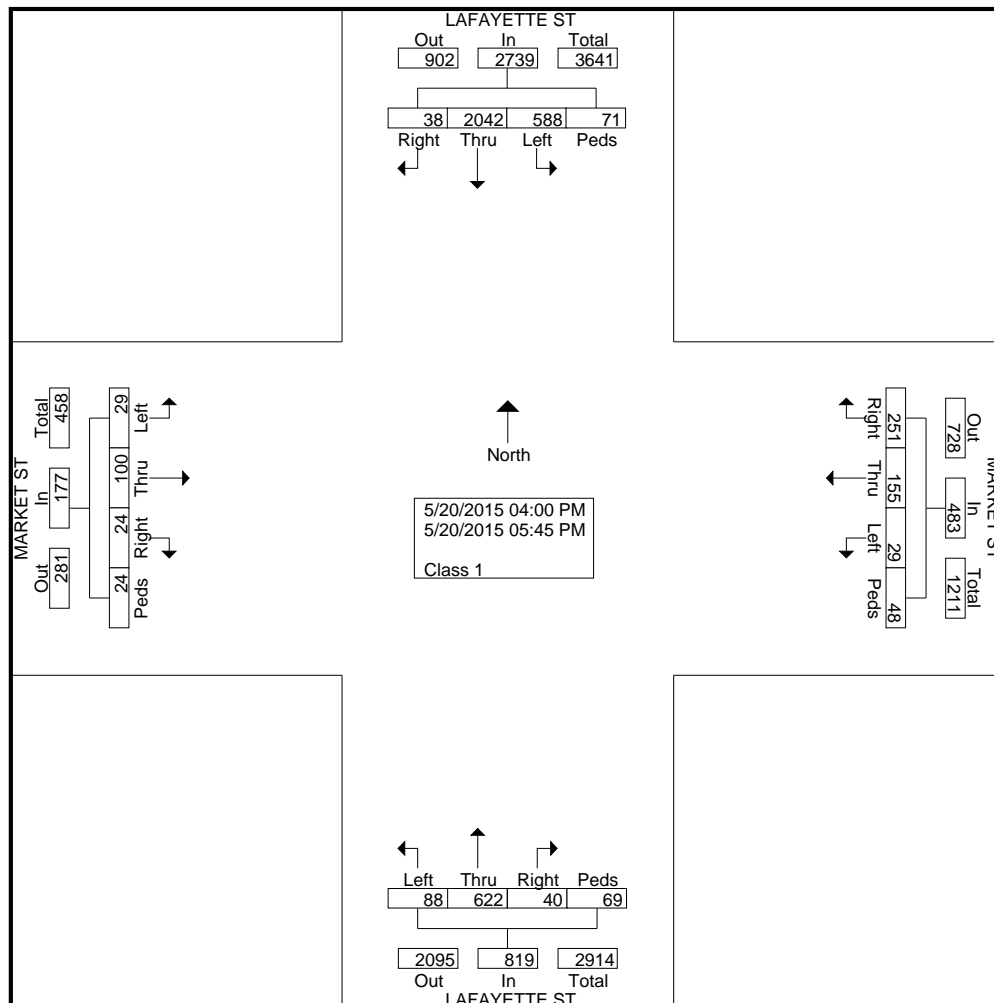

File Name : #20 LAFAYETTE&MARKETPM  
 Site Code :  
 Start Date : 5/20/2015  
 Page No : 2

| Start Time | LAFAYETTE ST Southbound |      |      |      |            | MARKET ST Westbound |      |      |      |            | LAFAYETTE ST Northbound |      |      |      |            | MARKET ST Eastbound |      |      |      |            | Int. Total |
|------------|-------------------------|------|------|------|------------|---------------------|------|------|------|------------|-------------------------|------|------|------|------------|---------------------|------|------|------|------------|------------|
|            | Right                   | Thru | Left | Peds | App. Total | Right               | Thru | Left | Peds | App. Total | Right                   | Thru | Left | Peds | App. Total | Right               | Thru | Left | Peds | App. Total |            |

**Peak Hour Analysis From 04:00 PM to 05:45 PM - Peak 1 of 1**

Peak Hour for Entire Intersection Begins at 05:00 PM

|              |      |      |      |      |      |      |      |      |      |      |      |      |      |      |      |      |      |      |      |      |      |
|--------------|------|------|------|------|------|------|------|------|------|------|------|------|------|------|------|------|------|------|------|------|------|
| 05:00 PM     | 7    | 280  | 85   | 10   | 382  | 45   | 24   | 1    | 4    | 74   | 6    | 82   | 9    | 2    | 99   | 1    | 12   | 3    | 4    | 20   | 575  |
| 05:15 PM     | 6    | 249  | 63   | 16   | 334  | 32   | 25   | 5    | 15   | 77   | 8    | 86   | 19   | 15   | 128  | 2    | 17   | 5    | 4    | 28   | 567  |
| 05:30 PM     | 4    | 311  | 94   | 10   | 419  | 22   | 21   | 7    | 3    | 53   | 4    | 70   | 12   | 7    | 93   | 3    | 12   | 1    | 0    | 16   | 581  |
| 05:45 PM     | 3    | 254  | 74   | 17   | 348  | 27   | 23   | 6    | 12   | 68   | 4    | 103  | 9    | 17   | 133  | 4    | 18   | 4    | 9    | 35   | 584  |
| Total Volume | 20   | 1094 | 316  | 53   | 1483 | 126  | 93   | 19   | 34   | 272  | 22   | 341  | 49   | 41   | 453  | 10   | 59   | 13   | 17   | 99   | 2307 |
| % App. Total | 1.3  | 73.8 | 21.3 | 3.6  |      | 46.3 | 34.2 | 7    | 12.5 |      | 4.9  | 75.3 | 10.8 | 9.1  |      | 10.1 | 59.6 | 13.1 | 17.2 |      |      |
| PHF          | .714 | .879 | .840 | .779 | .885 | .700 | .930 | .679 | .567 | .883 | .688 | .828 | .645 | .603 | .852 | .625 | .819 | .650 | .472 | .707 | .988 |

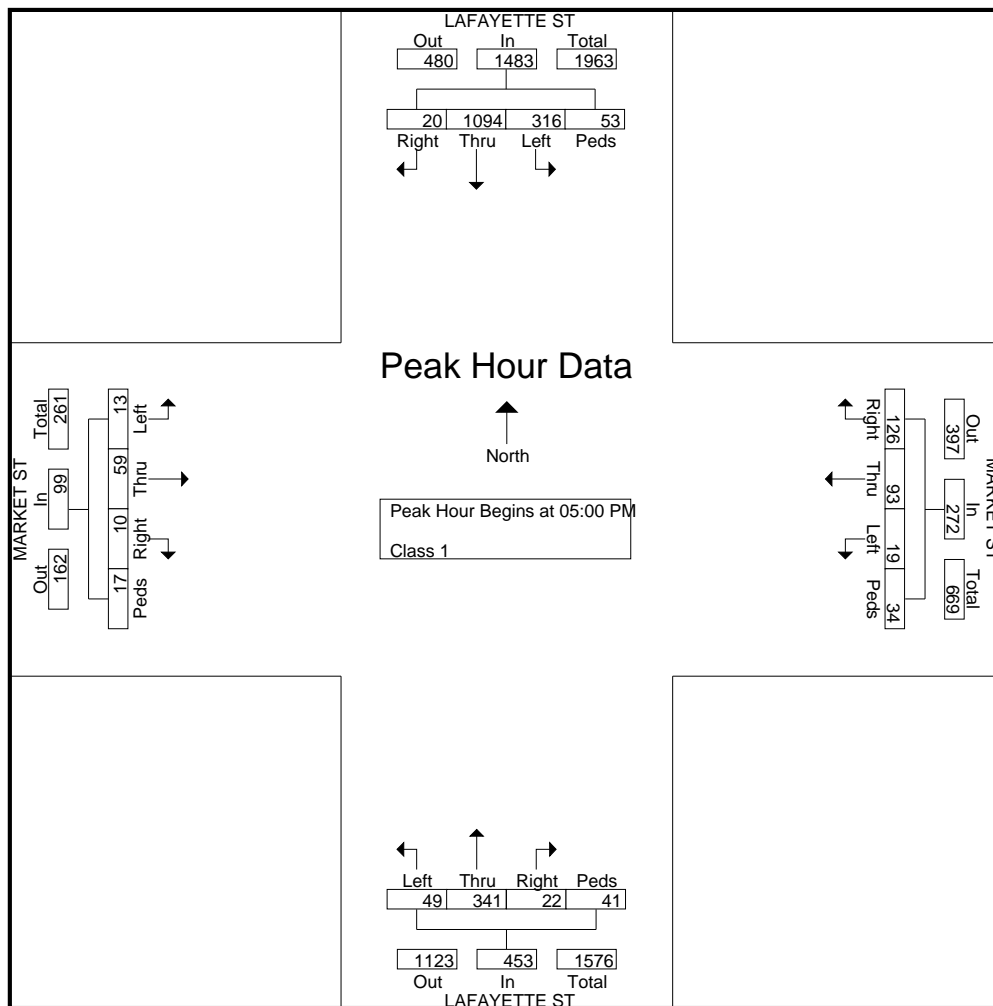

Groups Printed- Class 1

| Start Time  | 4TH ST Southbound |      |      |      | JULIAN ST Westbound |      |      |      | 4TH ST Northbound |      |      |      | JULIAN ST Eastbound |      |      |      | Int. Total |
|-------------|-------------------|------|------|------|---------------------|------|------|------|-------------------|------|------|------|---------------------|------|------|------|------------|
|             | Right             | Thru | Left | Peds | Right               | Thru | Left | Peds | Right             | Thru | Left | Peds | Right               | Thru | Left | Peds |            |
| 07:00 AM    | 5                 | 34   | 3    | 2    | 4                   | 95   | 13   | 1    | 3                 | 8    | 7    | 1    | 1                   | 13   | 3    | 1    | 194        |
| 07:15 AM    | 13                | 46   | 3    | 2    | 4                   | 109  | 8    | 2    | 5                 | 15   | 7    | 4    | 3                   | 5    | 1    | 1    | 228        |
| 07:30 AM    | 18                | 55   | 4    | 3    | 12                  | 101  | 5    | 5    | 2                 | 17   | 12   | 5    | 3                   | 19   | 4    | 6    | 271        |
| 07:45 AM    | 19                | 62   | 12   | 2    | 3                   | 104  | 5    | 2    | 1                 | 15   | 12   | 4    | 3                   | 14   | 5    | 0    | 263        |
| Total       | 55                | 197  | 22   | 9    | 23                  | 409  | 31   | 10   | 11                | 55   | 38   | 14   | 10                  | 51   | 13   | 8    | 956        |
| 08:00 AM    | 14                | 55   | 3    | 7    | 1                   | 72   | 13   | 1    | 4                 | 10   | 11   | 2    | 6                   | 12   | 4    | 2    | 217        |
| 08:15 AM    | 19                | 65   | 2    | 6    | 3                   | 106  | 8    | 2    | 6                 | 9    | 6    | 0    | 1                   | 13   | 5    | 4    | 255        |
| 08:30 AM    | 11                | 70   | 2    | 7    | 5                   | 96   | 23   | 1    | 8                 | 10   | 18   | 0    | 2                   | 9    | 6    | 5    | 273        |
| 08:45 AM    | 8                 | 53   | 1    | 5    | 6                   | 113  | 27   | 4    | 6                 | 16   | 10   | 4    | 1                   | 16   | 3    | 7    | 280        |
| Total       | 52                | 243  | 8    | 25   | 15                  | 387  | 71   | 8    | 24                | 45   | 45   | 6    | 10                  | 50   | 18   | 18   | 1025       |
| Grand Total | 107               | 440  | 30   | 34   | 38                  | 796  | 102  | 18   | 35                | 100  | 83   | 20   | 20                  | 101  | 31   | 26   | 1981       |
| Apprch %    | 17.5              | 72   | 4.9  | 5.6  | 4                   | 83.4 | 10.7 | 1.9  | 14.7              | 42   | 34.9 | 8.4  | 11.2                | 56.7 | 17.4 | 14.6 |            |
| Total %     | 5.4               | 22.2 | 1.5  | 1.7  | 1.9                 | 40.2 | 5.1  | 0.9  | 1.8               | 5    | 4.2  | 1    | 1                   | 5.1  | 1.6  | 1.3  |            |

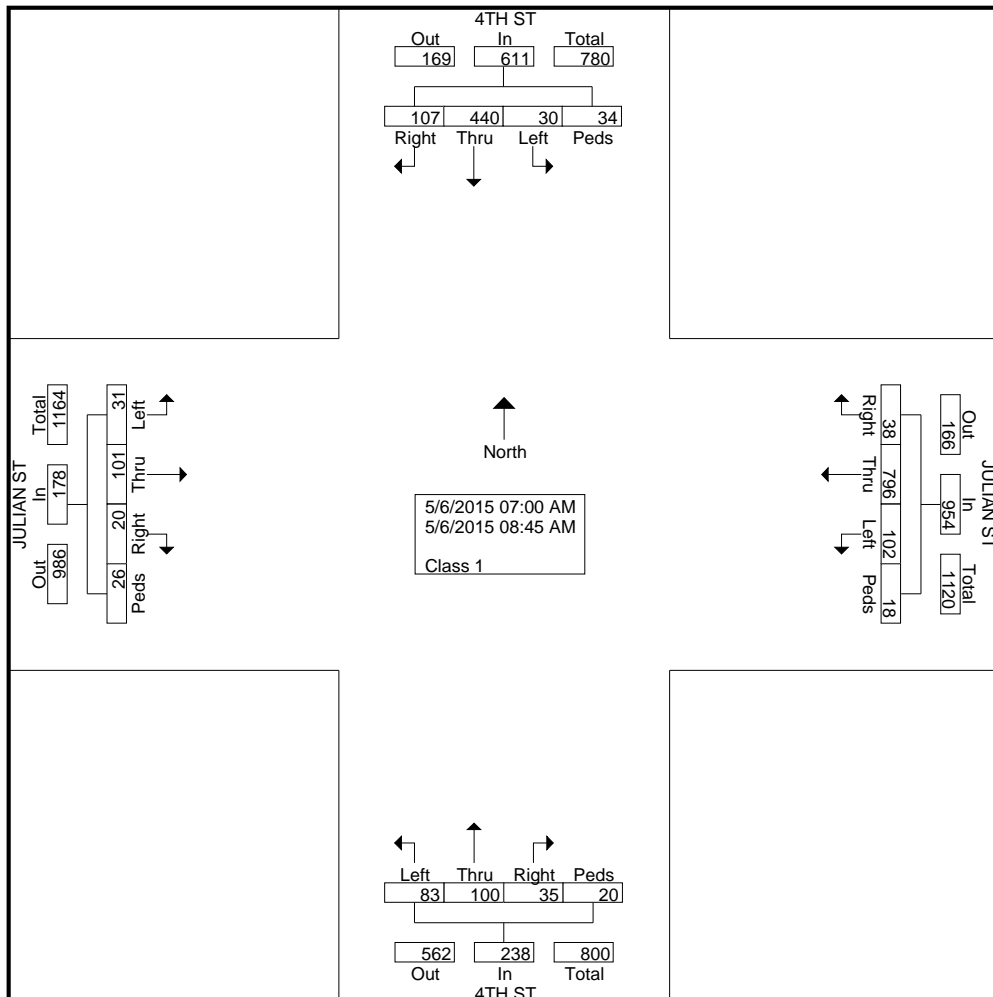

| Start Time  | 4TH ST Southbound |      |      |      |            | JULIAN ST Westbound |      |      |      |            | 4TH ST Northbound |      |      |      |            | JULIAN ST Eastbound |      |      |      |            | Int. Total |
|---|-------------------|------|------|------|------------|---------------------|------|------|------|------------|-------------------|------|------|------|------------|---------------------|------|------|------|------------|------------|
|   | Right             | Thru | Left | Peds | App. Total | Right               | Thru | Left | Peds | App. Total | Right             | Thru | Left | Peds | App. Total | Right               | Thru | Left | Peds | App. Total |            |
| <b>Peak Hour Analysis From 07:00 AM to 08:45 AM - Peak 1 of 1</b> |                   |      |      |      |            |                     |      |      |      |            |                   |      |      |      |            |                     |      |      |      |            |            |
| Peak Hour for Entire Intersection Begins at 08:00 AM              |                   |      |      |      |            |                     |      |      |      |            |                   |      |      |      |            |                     |      |      |      |            |            |
| 08:00 AM  | 14                | 55   | 3    | 7    | 79         | 1                   | 72   | 13   | 1    | 87         | 4                 | 10   | 11   | 2    | 27         | 6                   | 12   | 4    | 2    | 24         | 217        |
| 08:15 AM  | 19                | 65   | 2    | 6    | 92         | 3                   | 106  | 8    | 2    | 119        | 6                 | 9    | 6    | 0    | 21         | 1                   | 13   | 5    | 4    | 23         | 255        |
| 08:30 AM  | 11                | 70   | 2    | 7    | 90         | 5                   | 96   | 23   | 1    | 125        | 8                 | 10   | 18   | 0    | 36         | 2                   | 9    | 6    | 5    | 22         | 273        |
| 08:45 AM  | 8                 | 53   | 1    | 5    | 67         | 6                   | 113  | 27   | 4    | 150        | 6                 | 16   | 10   | 4    | 36         | 1                   | 16   | 3    | 7    | 27         | 280        |
| Total Volume  | 52                | 243  | 8    | 25   | 328        | 15                  | 387  | 71   | 8    | 481        | 24                | 45   | 45   | 6    | 120        | 10                  | 50   | 18   | 18   | 96         | 1025       |
| % App. Total  | 15.9              | 74.1 | 2.4  | 7.6  |            | 3.1                 | 80.5 | 14.8 | 1.7  |            | 20                | 37.5 | 37.5 | 5    |            | 10.4                | 52.1 | 18.8 | 18.8 |            |            |
| PHF   | .684              | .868 | .667 | .893 | .891       | .625                | .856 | .657 | .500 | .802       | .750              | .703 | .625 | .375 | .833       | .417                | .781 | .750 | .643 | .889       | .915       |

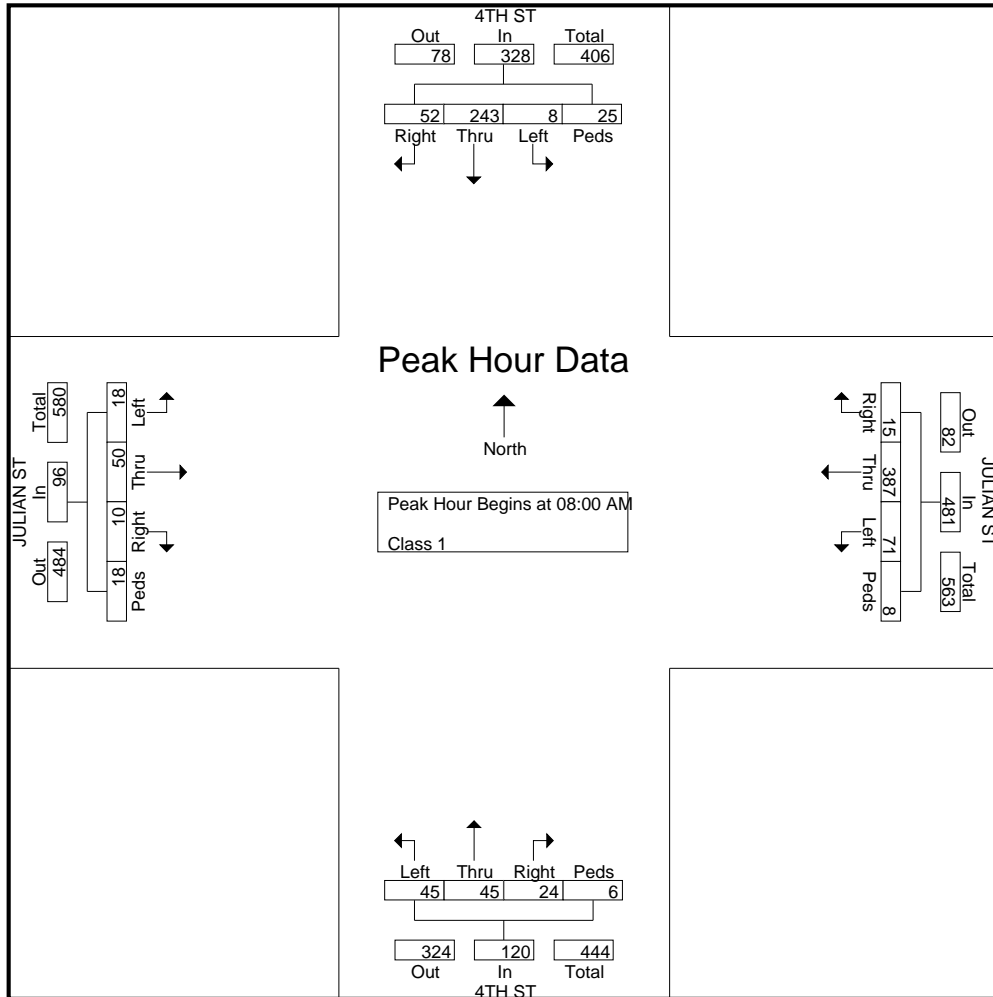

Groups Printed- Class 1

| Start Time  | 4TH ST Southbound |      |      |      | JULIAN ST Westbound |      |      |      | 4TH ST Northbound |      |      |      | JULIAN ST Eastbound |      |      |      | Int. Total |
|-------------|-------------------|------|------|------|---------------------|------|------|------|-------------------|------|------|------|---------------------|------|------|------|------------|
|             | Right             | Thru | Left | Peds | Right               | Thru | Left | Peds | Right             | Thru | Left | Peds | Right               | Thru | Left | Peds |            |
| 04:00 PM    | 16                | 81   | 15   | 6    | 4                   | 68   | 14   | 3    | 16                | 9    | 3    | 1    | 7                   | 41   | 3    | 9    | 296        |
| 04:15 PM    | 11                | 78   | 11   | 7    | 5                   | 82   | 14   | 2    | 21                | 10   | 10   | 5    | 8                   | 26   | 3    | 4    | 297        |
| 04:30 PM    | 14                | 105  | 9    | 5    | 4                   | 64   | 18   | 6    | 23                | 15   | 3    | 2    | 6                   | 25   | 8    | 4    | 311        |
| 04:45 PM    | 9                 | 104  | 6    | 10   | 0                   | 80   | 14   | 6    | 21                | 9    | 6    | 2    | 6                   | 41   | 1    | 5    | 320        |
| Total       | 50                | 368  | 41   | 28   | 13                  | 294  | 60   | 17   | 81                | 43   | 22   | 10   | 27                  | 133  | 15   | 22   | 1224       |
| 05:00 PM    | 13                | 85   | 12   | 4    | 7                   | 69   | 12   | 1    | 31                | 13   | 11   | 5    | 6                   | 40   | 0    | 9    | 318        |
| 05:15 PM    | 15                | 106  | 15   | 8    | 6                   | 81   | 24   | 2    | 24                | 8    | 5    | 5    | 5                   | 33   | 2    | 14   | 353        |
| 05:30 PM    | 6                 | 127  | 19   | 5    | 3                   | 83   | 18   | 4    | 29                | 18   | 7    | 9    | 7                   | 27   | 1    | 14   | 377        |
| 05:45 PM    | 6                 | 109  | 14   | 6    | 4                   | 63   | 25   | 1    | 24                | 12   | 8    | 5    | 8                   | 31   | 0    | 29   | 345        |
| Total       | 40                | 427  | 60   | 23   | 20                  | 296  | 79   | 8    | 108               | 51   | 31   | 24   | 26                  | 131  | 3    | 66   | 1393       |
| Grand Total | 90                | 795  | 101  | 51   | 33                  | 590  | 139  | 25   | 189               | 94   | 53   | 34   | 53                  | 264  | 18   | 88   | 2617       |
| Apprch %    | 8.7               | 76.7 | 9.7  | 4.9  | 4.2                 | 75   | 17.7 | 3.2  | 51.1              | 25.4 | 14.3 | 9.2  | 12.5                | 62.4 | 4.3  | 20.8 |            |
| Total %     | 3.4               | 30.4 | 3.9  | 1.9  | 1.3                 | 22.5 | 5.3  | 1    | 7.2               | 3.6  | 2    | 1.3  | 2                   | 10.1 | 0.7  | 3.4  |            |

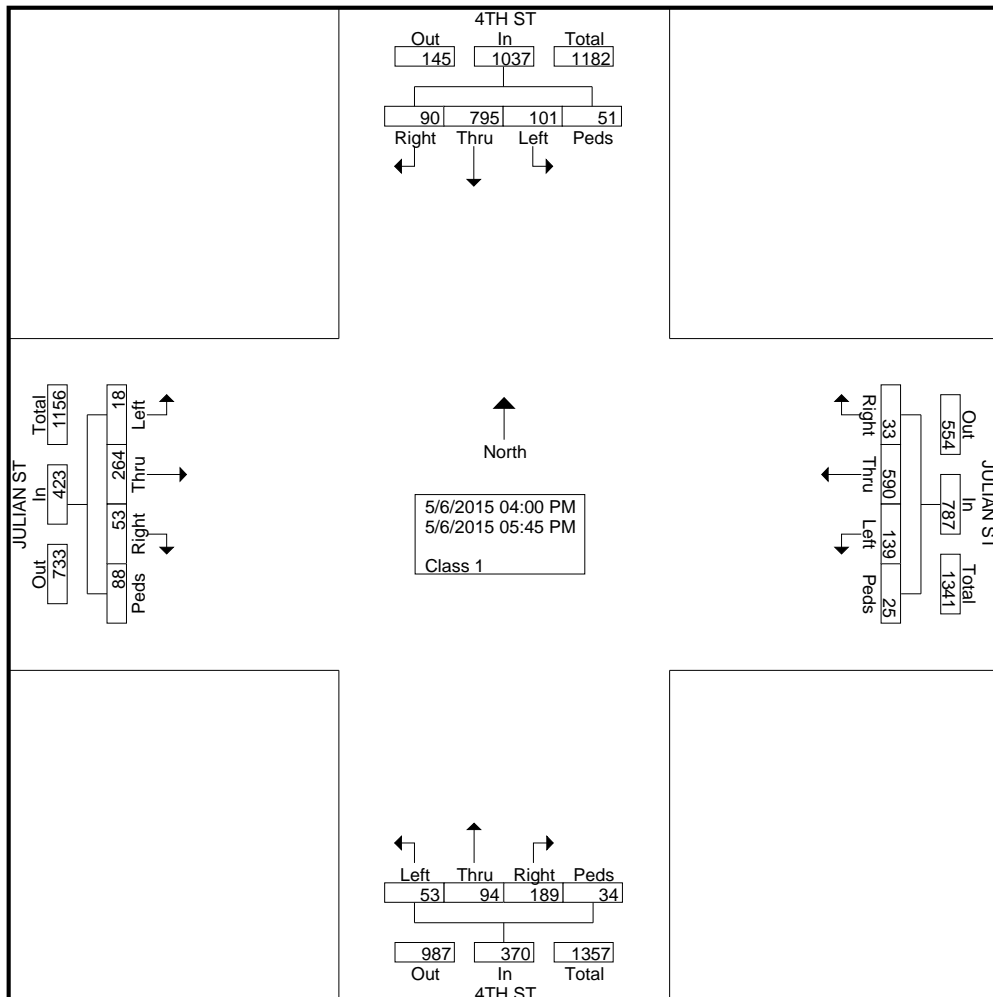

| Start Time  | 4TH ST Southbound |      |      |      |            | JULIAN ST Westbound |      |      |      |            | 4TH ST Northbound |      |      |      |            | JULIAN ST Eastbound |      |      |      |            | Int. Total |
|---|-------------------|------|------|------|------------|---------------------|------|------|------|------------|-------------------|------|------|------|------------|---------------------|------|------|------|------------|------------|
|   | Right             | Thru | Left | Peds | App. Total | Right               | Thru | Left | Peds | App. Total | Right             | Thru | Left | Peds | App. Total | Right               | Thru | Left | Peds | App. Total |            |
| <b>Peak Hour Analysis From 04:00 PM to 05:45 PM - Peak 1 of 1</b> |                   |      |      |      |            |                     |      |      |      |            |                   |      |      |      |            |                     |      |      |      |            |            |
| Peak Hour for Entire Intersection Begins at 05:00 PM              |                   |      |      |      |            |                     |      |      |      |            |                   |      |      |      |            |                     |      |      |      |            |            |
| 05:00 PM  | 13                | 85   | 12   | 4    | 114        | 7                   | 69   | 12   | 1    | 89         | 31                | 13   | 11   | 5    | 60         | 6                   | 40   | 0    | 9    | 55         | 318        |
| 05:15 PM  | 15                | 106  | 15   | 8    | 144        | 6                   | 81   | 24   | 2    | 113        | 24                | 8    | 5    | 5    | 42         | 5                   | 33   | 2    | 14   | 54         | 353        |
| 05:30 PM  | 6                 | 127  | 19   | 5    | 157        | 3                   | 83   | 18   | 4    | 108        | 29                | 18   | 7    | 9    | 63         | 7                   | 27   | 1    | 14   | 49         | 377        |
| 05:45 PM  | 6                 | 109  | 14   | 6    | 135        | 4                   | 63   | 25   | 1    | 93         | 24                | 12   | 8    | 5    | 49         | 8                   | 31   | 0    | 29   | 68         | 345        |
| Total Volume  | 40                | 427  | 60   | 23   | 550        | 20                  | 296  | 79   | 8    | 403        | 108               | 51   | 31   | 24   | 214        | 26                  | 131  | 3    | 66   | 226        | 1393       |
| % App. Total  | 7.3               | 77.6 | 10.9 | 4.2  |            | 5                   | 73.4 | 19.6 | 2    |            | 50.5              | 23.8 | 14.5 | 11.2 |            | 11.5                | 58   | 1.3  | 29.2 |            |            |
| PHF   | .667              | .841 | .789 | .719 | .876       | .714                | .892 | .790 | .500 | .892       | .871              | .708 | .705 | .667 | .849       | .813                | .819 | .375 | .569 | .831       | .924       |

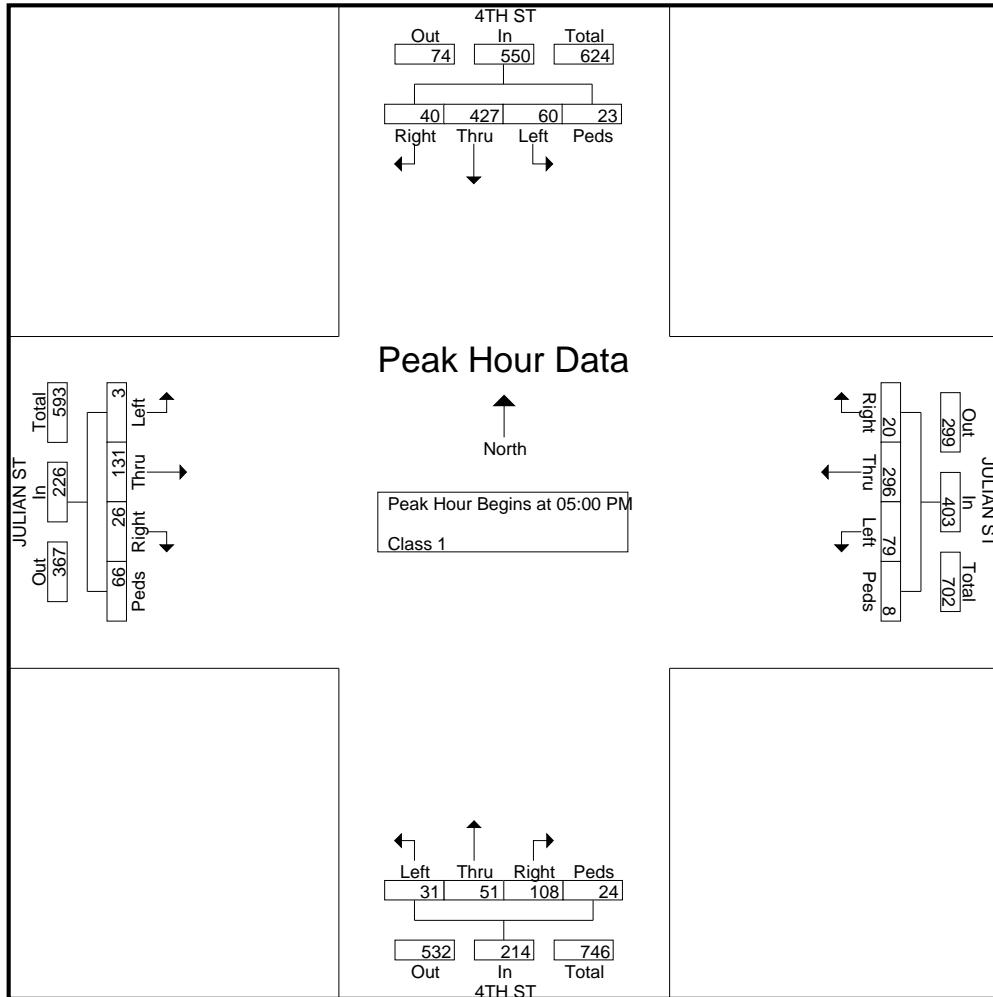



File Name : #21 ALAMEDA&HEDDINGAM  
 Site Code :  
 Start Date : 5/21/2015  
 Page No : 1

Groups Printed- Class 1

| Start Time  | HEDDING ST Southbound |      |      |      | THE ALAMEDA Westbound |      |      |      | HEDDING ST Northbound |      |      |      | THE ALAMEDA Eastbound |      |      |      | Int. Total |
|-------------|-----------------------|------|------|------|-----------------------|------|------|------|-----------------------|------|------|------|-----------------------|------|------|------|------------|
|             | Right                 | Thru | Left | Peds | Right                 | Thru | Left | Peds | Right                 | Thru | Left | Peds | Right                 | Thru | Left | Peds |            |
| 07:00 AM    | 21                    | 21   | 5    | 1    | 12                    | 269  | 9    | 1    | 9                     | 27   | 22   | 1    | 13                    | 97   | 1    | 2    | 511        |
| 07:15 AM    | 33                    | 47   | 11   | 2    | 15                    | 297  | 7    | 0    | 15                    | 41   | 24   | 4    | 13                    | 132  | 21   | 1    | 663        |
| 07:30 AM    | 15                    | 62   | 9    | 2    | 20                    | 338  | 9    | 0    | 20                    | 67   | 54   | 2    | 21                    | 141  | 12   | 0    | 772        |
| 07:45 AM    | 34                    | 54   | 4    | 0    | 18                    | 342  | 9    | 1    | 21                    | 93   | 39   | 4    | 3                     | 163  | 20   | 3    | 808        |
| Total       | 103                   | 184  | 29   | 5    | 65                    | 1246 | 34   | 2    | 65                    | 228  | 139  | 11   | 50                    | 533  | 54   | 6    | 2754       |
| 08:00 AM    | 35                    | 52   | 3    | 4    | 25                    | 349  | 8    | 1    | 23                    | 87   | 52   | 0    | 6                     | 165  | 39   | 0    | 849        |
| 08:15 AM    | 36                    | 54   | 7    | 4    | 29                    | 291  | 14   | 3    | 31                    | 109  | 45   | 1    | 19                    | 146  | 35   | 0    | 824        |
| 08:30 AM    | 26                    | 38   | 8    | 2    | 18                    | 303  | 4    | 0    | 21                    | 114  | 55   | 1    | 5                     | 118  | 22   | 0    | 735        |
| 08:45 AM    | 20                    | 36   | 14   | 1    | 18                    | 243  | 9    | 2    | 24                    | 71   | 43   | 0    | 10                    | 141  | 26   | 1    | 659        |
| Total       | 117                   | 180  | 32   | 11   | 90                    | 1186 | 35   | 6    | 99                    | 381  | 195  | 2    | 40                    | 570  | 122  | 1    | 3067       |
| Grand Total | 220                   | 364  | 61   | 16   | 155                   | 2432 | 69   | 8    | 164                   | 609  | 334  | 13   | 90                    | 1103 | 176  | 7    | 5821       |
| Apprch %    | 33.3                  | 55.1 | 9.2  | 2.4  | 5.8                   | 91.3 | 2.6  | 0.3  | 14.6                  | 54.4 | 29.8 | 1.2  | 6.5                   | 80.2 | 12.8 | 0.5  |            |
| Total %     | 3.8                   | 6.3  | 1    | 0.3  | 2.7                   | 41.8 | 1.2  | 0.1  | 2.8                   | 10.5 | 5.7  | 0.2  | 1.5                   | 18.9 | 3    | 0.1  |            |

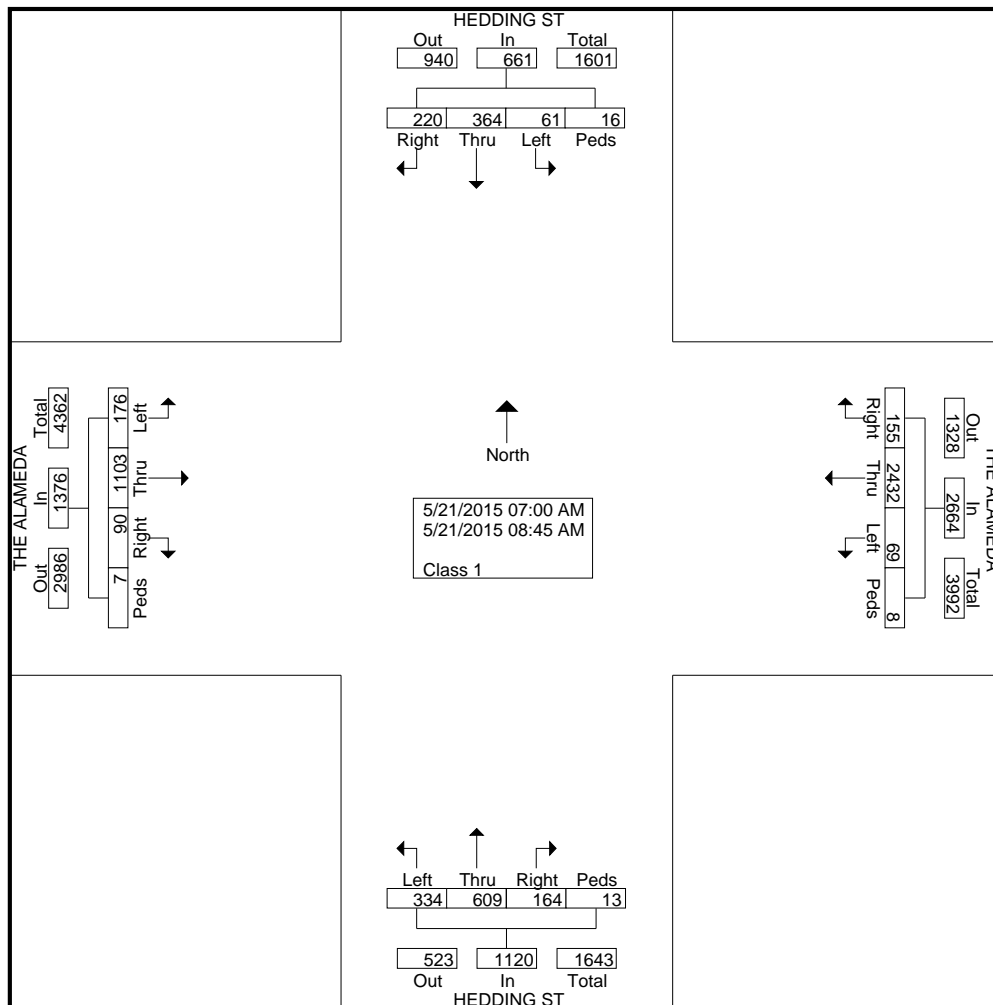

File Name : #21 ALAMEDA&HEDDINGAM  
 Site Code :  
 Start Date : 5/21/2015  
 Page No : 2

| Start Time  | HEDDING ST Southbound |      |      |      |            | THE ALAMEDA Westbound |      |      |      |            | HEDDING ST Northbound |      |      |      |            | THE ALAMEDA Eastbound |      |      |      |            | Int. Total |
|---|-----------------------|------|------|------|------------|-----------------------|------|------|------|------------|-----------------------|------|------|------|------------|-----------------------|------|------|------|------------|------------|
|   | Right                 | Thru | Left | Peds | App. Total | Right                 | Thru | Left | Peds | App. Total | Right                 | Thru | Left | Peds | App. Total | Right                 | Thru | Left | Peds | App. Total |            |
| <b>Peak Hour Analysis From 07:00 AM to 08:45 AM - Peak 1 of 1</b> |                       |      |      |      |            |                       |      |      |      |            |                       |      |      |      |            |                       |      |      |      |            |            |
| Peak Hour for Entire Intersection Begins at 07:30 AM              |                       |      |      |      |            |                       |      |      |      |            |                       |      |      |      |            |                       |      |      |      |            |            |
| 07:30 AM  | 15                    | 62   | 9    | 2    | 88         | 20                    | 338  | 9    | 0    | 367        | 20                    | 67   | 54   | 2    | 143        | 21                    | 141  | 12   | 0    | 174        | 772        |
| 07:45 AM  | 34                    | 54   | 4    | 0    | 92         | 18                    | 342  | 9    | 1    | 370        | 21                    | 93   | 39   | 4    | 157        | 3                     | 163  | 20   | 3    | 189        | 808        |
| 08:00 AM  | 35                    | 52   | 3    | 4    | 94         | 25                    | 349  | 8    | 1    | 383        | 23                    | 87   | 52   | 0    | 162        | 6                     | 165  | 39   | 0    | 210        | 849        |
| 08:15 AM  | 36                    | 54   | 7    | 4    | 101        | 29                    | 291  | 14   | 3    | 337        | 31                    | 109  | 45   | 1    | 186        | 19                    | 146  | 35   | 0    | 200        | 824        |
| Total Volume  | 120                   | 222  | 23   | 10   | 375        | 92                    | 1320 | 40   | 5    | 1457       | 95                    | 356  | 190  | 7    | 648        | 49                    | 615  | 106  | 3    | 773        | 3253       |
| % App. Total  | 32                    | 59.2 | 6.1  | 2.7  |            | 6.3                   | 90.6 | 2.7  | 0.3  |            | 14.7                  | 54.9 | 29.3 | 1.1  |            | 6.3                   | 79.6 | 13.7 | 0.4  |            |            |
| PHF   | .833                  | .895 | .639 | .625 | .928       | .793                  | .946 | .714 | .417 | .951       | .766                  | .817 | .880 | .438 | .871       | .583                  | .932 | .679 | .250 | .920       | .958       |

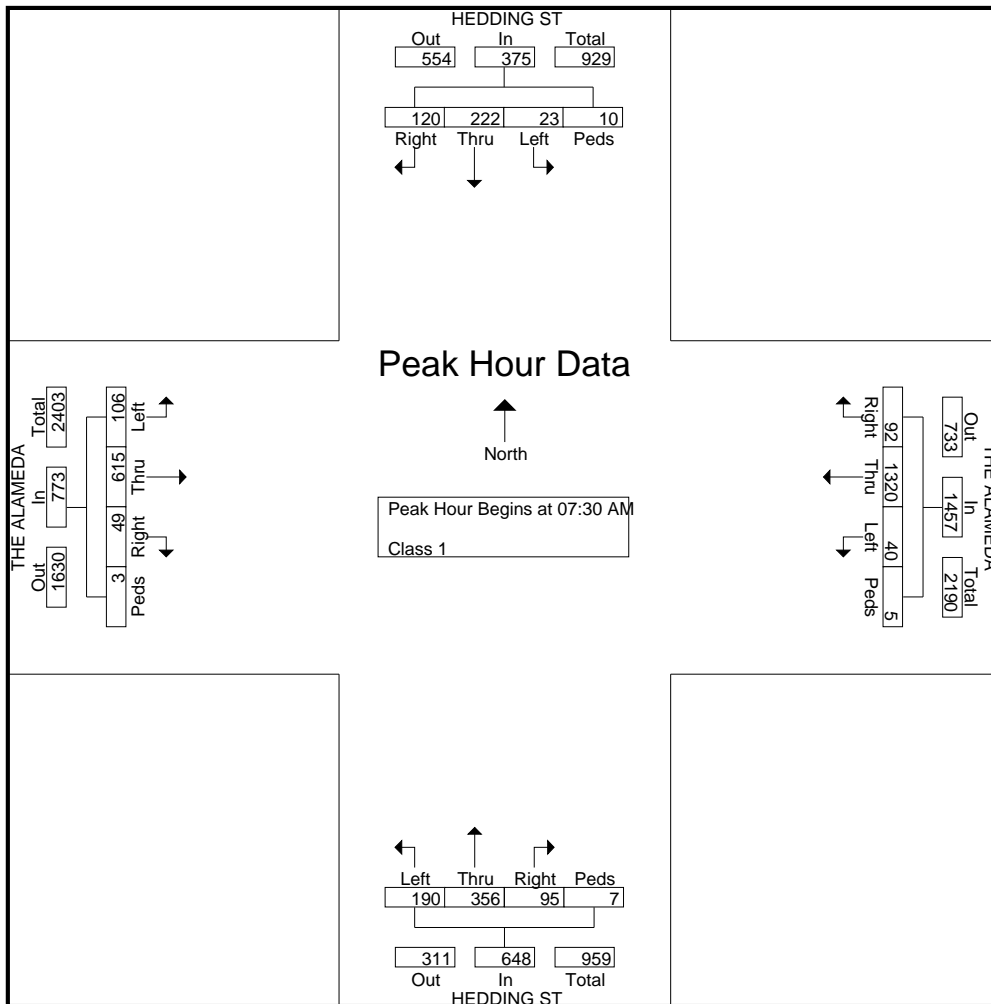

Groups Printed- Class 1

| Start Time  | 4TH ST Southbound |      |      |      | ST JAMES ST Westbound |      |      |      | 4TH ST Northbound |      |      |      | ST JAMES ST Eastbound |      |      |      | Int. Total |
|-------------|-------------------|------|------|------|-----------------------|------|------|------|-------------------|------|------|------|-----------------------|------|------|------|------------|
|             | Right             | Thru | Left | Peds | Right                 | Thru | Left | Peds | Right             | Thru | Left | Peds | Right                 | Thru | Left | Peds |            |
| 07:00 AM    | 0                 | 44   | 2    | 0    | 7                     | 0    | 7    | 1    | 0                 | 0    | 0    | 2    | 22                    | 35   | 7    | 3    | 130        |
| 07:15 AM    | 0                 | 59   | 4    | 0    | 11                    | 0    | 3    | 1    | 0                 | 0    | 0    | 1    | 39                    | 35   | 17   | 4    | 174        |
| 07:30 AM    | 0                 | 48   | 8    | 2    | 11                    | 0    | 9    | 6    | 0                 | 0    | 0    | 3    | 36                    | 48   | 14   | 2    | 187        |
| 07:45 AM    | 0                 | 70   | 11   | 1    | 26                    | 0    | 18   | 1    | 0                 | 0    | 0    | 6    | 34                    | 58   | 20   | 1    | 246        |
| Total       | 0                 | 221  | 25   | 3    | 55                    | 0    | 37   | 9    | 0                 | 0    | 0    | 12   | 131                   | 176  | 58   | 10   | 737        |
| 08:00 AM    | 0                 | 58   | 4    | 7    | 15                    | 0    | 17   | 2    | 0                 | 0    | 0    | 4    | 37                    | 35   | 23   | 3    | 205        |
| 08:15 AM    | 0                 | 64   | 8    | 4    | 14                    | 0    | 11   | 2    | 0                 | 0    | 0    | 0    | 45                    | 52   | 14   | 3    | 217        |
| 08:30 AM    | 0                 | 80   | 7    | 1    | 15                    | 0    | 9    | 1    | 0                 | 0    | 0    | 3    | 51                    | 60   | 19   | 4    | 250        |
| 08:45 AM    | 0                 | 74   | 3    | 4    | 20                    | 0    | 15   | 5    | 0                 | 0    | 0    | 10   | 55                    | 55   | 29   | 8    | 278        |
| Total       | 0                 | 276  | 22   | 16   | 64                    | 0    | 52   | 10   | 0                 | 0    | 0    | 17   | 188                   | 202  | 85   | 18   | 950        |
| Grand Total | 0                 | 497  | 47   | 19   | 119                   | 0    | 89   | 19   | 0                 | 0    | 0    | 29   | 319                   | 378  | 143  | 28   | 1687       |
| Apprch %    | 0                 | 88.3 | 8.3  | 3.4  | 52.4                  | 0    | 39.2 | 8.4  | 0                 | 0    | 0    | 100  | 36.8                  | 43.5 | 16.5 | 3.2  |            |
| Total %     | 0                 | 29.5 | 2.8  | 1.1  | 7.1                   | 0    | 5.3  | 1.1  | 0                 | 0    | 0    | 1.7  | 18.9                  | 22.4 | 8.5  | 1.7  |            |

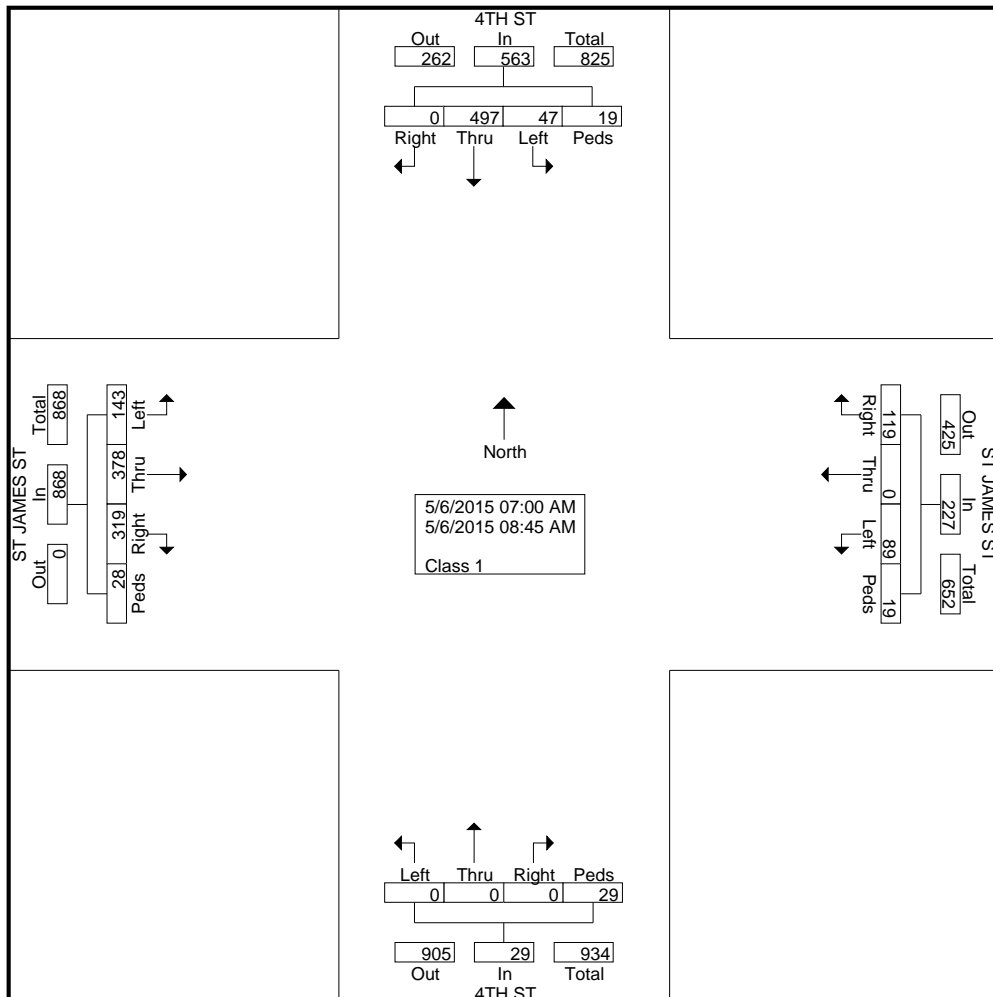

| Start Time  | 4TH ST Southbound |      |      |      |            | ST JAMES ST Westbound |      |      |      |            | 4TH ST Northbound |      |      |      |            | ST JAMES ST Eastbound |      |      |      |            | Int. Total |
|---|-------------------|------|------|------|------------|-----------------------|------|------|------|------------|-------------------|------|------|------|------------|-----------------------|------|------|------|------------|------------|
|   | Right             | Thru | Left | Peds | App. Total | Right                 | Thru | Left | Peds | App. Total | Right             | Thru | Left | Peds | App. Total | Right                 | Thru | Left | Peds | App. Total |            |
| <b>Peak Hour Analysis From 07:00 AM to 08:45 AM - Peak 1 of 1</b> |                   |      |      |      |            |                       |      |      |      |            |                   |      |      |      |            |                       |      |      |      |            |            |
| Peak Hour for Entire Intersection Begins at 08:00 AM              |                   |      |      |      |            |                       |      |      |      |            |                   |      |      |      |            |                       |      |      |      |            |            |
| 08:00 AM  | 0                 | 58   | 4    | 7    | 69         | 15                    | 0    | 17   | 2    | 34         | 0                 | 0    | 0    | 4    | 4          | 37                    | 35   | 23   | 3    | 98         | 205        |
| 08:15 AM  | 0                 | 64   | 8    | 4    | 76         | 14                    | 0    | 11   | 2    | 27         | 0                 | 0    | 0    | 0    | 0          | 45                    | 52   | 14   | 3    | 114        | 217        |
| 08:30 AM  | 0                 | 80   | 7    | 1    | 88         | 15                    | 0    | 9    | 1    | 25         | 0                 | 0    | 0    | 3    | 3          | 51                    | 60   | 19   | 4    | 134        | 250        |
| 08:45 AM  | 0                 | 74   | 3    | 4    | 81         | 20                    | 0    | 15   | 5    | 40         | 0                 | 0    | 0    | 10   | 10         | 55                    | 55   | 29   | 8    | 147        | 278        |
| Total Volume  | 0                 | 276  | 22   | 16   | 314        | 64                    | 0    | 52   | 10   | 126        | 0                 | 0    | 0    | 17   | 17         | 188                   | 202  | 85   | 18   | 493        | 950        |
| % App. Total  | 0                 | 87.9 | 7    | 5.1  |            | 50.8                  | 0    | 41.3 | 7.9  |            | 0                 | 0    | 0    | 100  |            | 38.1                  | 41   | 17.2 | 3.7  |            |            |
| PHF   | .000              | .863 | .688 | .571 | .892       | .800                  | .000 | .765 | .500 | .788       | .000              | .000 | .000 | .425 | .425       | .855                  | .842 | .733 | .563 | .838       | .854       |

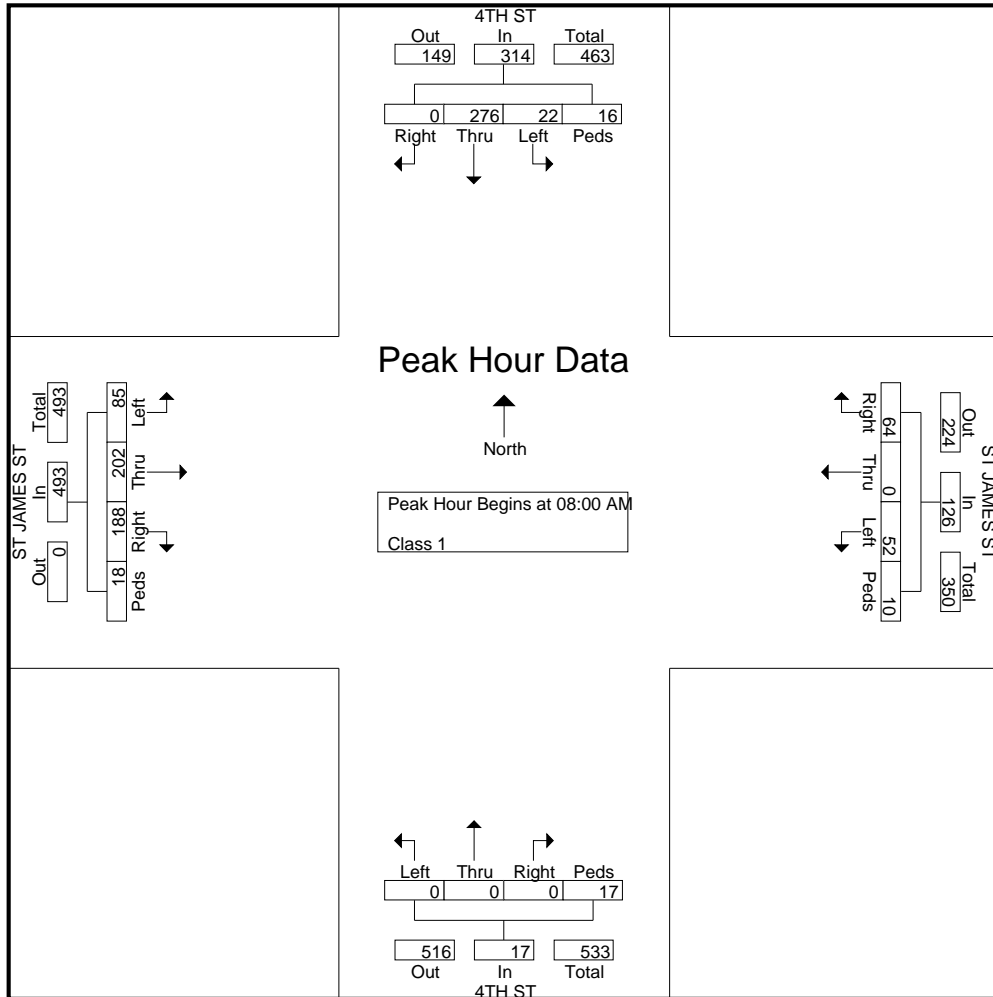

Groups Printed- Class 1

| Start Time  | 4TH ST Southbound |      |      |      | ST JAMES ST Westbound |      |      |      | 4TH ST Northbound |      |      |      | ST JAMES ST Eastbound |      |      |      | Int. Total |
|-------------|-------------------|------|------|------|-----------------------|------|------|------|-------------------|------|------|------|-----------------------|------|------|------|------------|
|             | Right             | Thru | Left | Peds | Right                 | Thru | Left | Peds | Right             | Thru | Left | Peds | Right                 | Thru | Left | Peds |            |
| 04:00 PM    | 0                 | 89   | 6    | 3    | 4                     | 0    | 5    | 3    | 0                 | 0    | 0    | 6    | 32                    | 100  | 19   | 5    | 272        |
| 04:15 PM    | 0                 | 93   | 3    | 2    | 10                    | 0    | 14   | 4    | 0                 | 0    | 0    | 7    | 31                    | 102  | 25   | 4    | 295        |
| 04:30 PM    | 0                 | 121  | 7    | 1    | 4                     | 0    | 8    | 4    | 0                 | 0    | 0    | 6    | 23                    | 97   | 33   | 9    | 313        |
| 04:45 PM    | 0                 | 113  | 1    | 2    | 3                     | 0    | 5    | 4    | 0                 | 0    | 0    | 7    | 33                    | 101  | 29   | 6    | 304        |
| Total       | 0                 | 416  | 17   | 8    | 21                    | 0    | 32   | 15   | 0                 | 0    | 0    | 26   | 119                   | 400  | 106  | 24   | 1184       |
| 05:00 PM    | 0                 | 112  | 8    | 5    | 9                     | 0    | 7    | 6    | 0                 | 0    | 0    | 5    | 37                    | 116  | 29   | 12   | 346        |
| 05:15 PM    | 0                 | 114  | 7    | 4    | 3                     | 0    | 13   | 7    | 0                 | 0    | 0    | 10   | 28                    | 133  | 33   | 11   | 363        |
| 05:30 PM    | 0                 | 145  | 4    | 10   | 8                     | 0    | 9    | 5    | 0                 | 0    | 0    | 17   | 42                    | 120  | 36   | 16   | 412        |
| 05:45 PM    | 0                 | 125  | 6    | 3    | 12                    | 0    | 9    | 3    | 0                 | 0    | 0    | 8    | 34                    | 130  | 34   | 17   | 381        |
| Total       | 0                 | 496  | 25   | 22   | 32                    | 0    | 38   | 21   | 0                 | 0    | 0    | 40   | 141                   | 499  | 132  | 56   | 1502       |
| Grand Total | 0                 | 912  | 42   | 30   | 53                    | 0    | 70   | 36   | 0                 | 0    | 0    | 66   | 260                   | 899  | 238  | 80   | 2686       |
| Approch %   | 0                 | 92.7 | 4.3  | 3    | 33.3                  | 0    | 44   | 22.6 | 0                 | 0    | 0    | 100  | 17.6                  | 60.9 | 16.1 | 5.4  |            |
| Total %     | 0                 | 34   | 1.6  | 1.1  | 2                     | 0    | 2.6  | 1.3  | 0                 | 0    | 0    | 2.5  | 9.7                   | 33.5 | 8.9  | 3    |            |

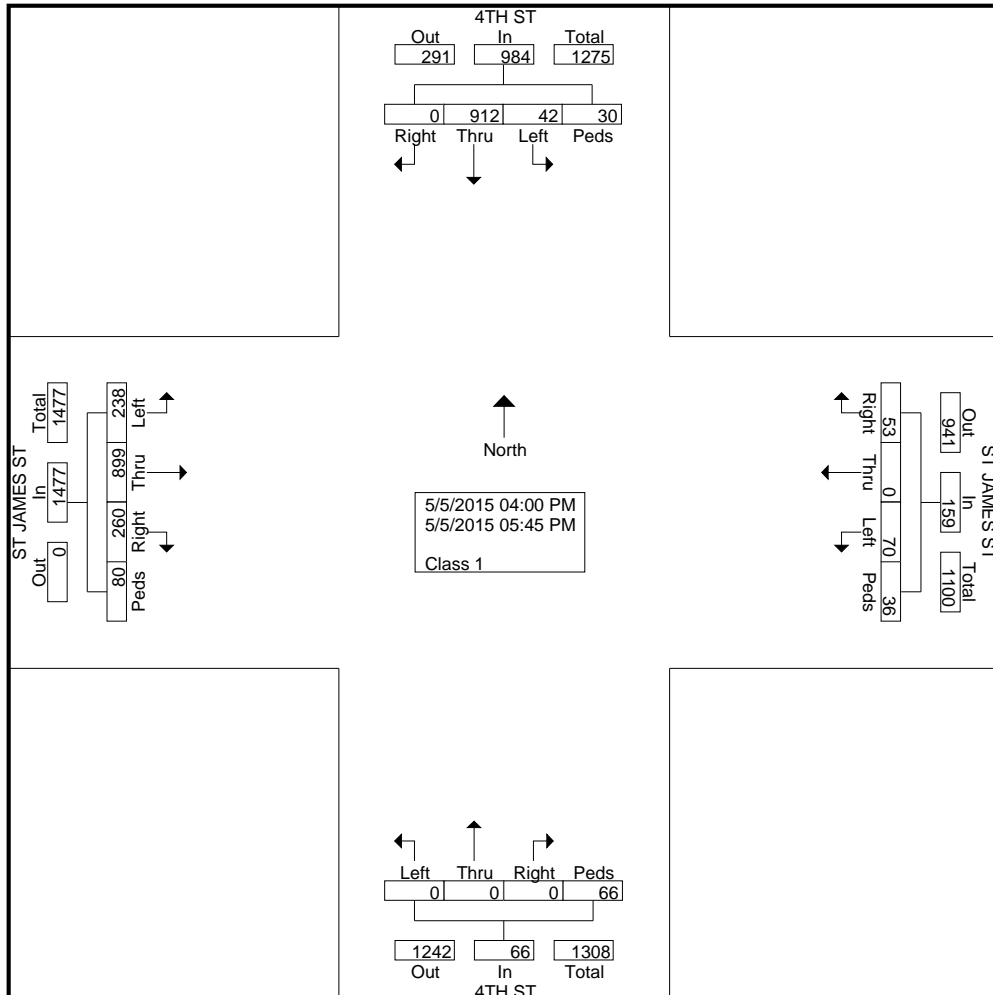

| Start Time  | 4TH ST Southbound |      |      |      |            | ST JAMES ST Westbound |      |      |      |            | 4TH ST Northbound |      |      |      |            | ST JAMES ST Eastbound |      |      |      |            | Int. Total |
|---|-------------------|------|------|------|------------|-----------------------|------|------|------|------------|-------------------|------|------|------|------------|-----------------------|------|------|------|------------|------------|
|   | Right             | Thru | Left | Peds | App. Total | Right                 | Thru | Left | Peds | App. Total | Right             | Thru | Left | Peds | App. Total | Right                 | Thru | Left | Peds | App. Total |            |
| <b>Peak Hour Analysis From 04:00 PM to 05:45 PM - Peak 1 of 1</b> |                   |      |      |      |            |                       |      |      |      |            |                   |      |      |      |            |                       |      |      |      |            |            |
| Peak Hour for Entire Intersection Begins at 05:00 PM              |                   |      |      |      |            |                       |      |      |      |            |                   |      |      |      |            |                       |      |      |      |            |            |
| 05:00 PM  | 0                 | 112  | 8    | 5    | 125        | 9                     | 0    | 7    | 6    | 22         | 0                 | 0    | 0    | 5    | 5          | 37                    | 116  | 29   | 12   | 194        | 346        |
| 05:15 PM  | 0                 | 114  | 7    | 4    | 125        | 3                     | 0    | 13   | 7    | 23         | 0                 | 0    | 0    | 10   | 10         | 28                    | 133  | 33   | 11   | 205        | 363        |
| 05:30 PM  | 0                 | 145  | 4    | 10   | 159        | 8                     | 0    | 9    | 5    | 22         | 0                 | 0    | 0    | 17   | 17         | 42                    | 120  | 36   | 16   | 214        | 412        |
| 05:45 PM  | 0                 | 125  | 6    | 3    | 134        | 12                    | 0    | 9    | 3    | 24         | 0                 | 0    | 0    | 8    | 8          | 34                    | 130  | 34   | 17   | 215        | 381        |
| Total Volume  | 0                 | 496  | 25   | 22   | 543        | 32                    | 0    | 38   | 21   | 91         | 0                 | 0    | 0    | 40   | 40         | 141                   | 499  | 132  | 56   | 828        | 1502       |
| % App. Total  | 0                 | 91.3 | 4.6  | 4.1  |            | 35.2                  | 0    | 41.8 | 23.1 |            | 0                 | 0    | 0    | 100  |            | 17                    | 60.3 | 15.9 | 6.8  |            |            |
| PHF   | .000              | .855 | .781 | .550 | .854       | .667                  | .000 | .731 | .750 | .948       | .000              | .000 | .000 | .588 | .588       | .839                  | .938 | .917 | .824 | .963       | .911       |

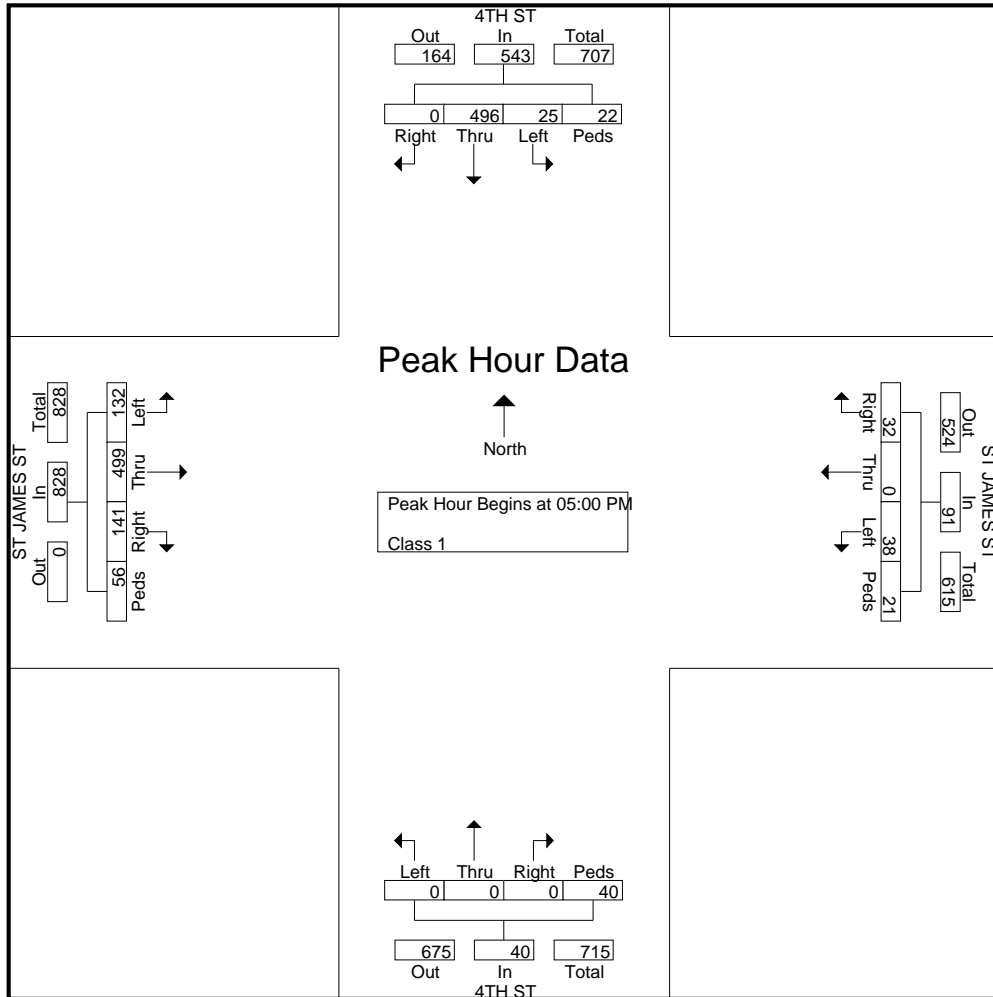

Groups Printed- Class 1

| Start Time  | TAYLOR ST Southbound |      |      |      | THE ALAMEDA Westbound |      |      |      | NAGLEE AVE Northbound |      |      |      | THE ALAMEDA Eastbound |      |      |      | Int. Total |
|-------------|----------------------|------|------|------|-----------------------|------|------|------|-----------------------|------|------|------|-----------------------|------|------|------|------------|
|             | Right                | Thru | Left | Peds | Right                 | Thru | Left | Peds | Right                 | Thru | Left | Peds | Right                 | Thru | Left | Peds |            |
| 07:00 AM    | 28                   | 50   | 9    | 3    | 3                     | 202  | 10   | 0    | 4                     | 47   | 25   | 0    | 5                     | 81   | 14   | 7    | 488        |
| 07:15 AM    | 29                   | 109  | 9    | 2    | 2                     | 224  | 23   | 0    | 14                    | 59   | 37   | 0    | 19                    | 102  | 18   | 11   | 658        |
| 07:30 AM    | 32                   | 112  | 14   | 2    | 3                     | 287  | 24   | 3    | 28                    | 104  | 35   | 2    | 12                    | 127  | 24   | 7    | 816        |
| 07:45 AM    | 33                   | 79   | 13   | 3    | 6                     | 300  | 27   | 0    | 22                    | 110  | 33   | 12   | 11                    | 131  | 22   | 16   | 818        |
| Total       | 122                  | 350  | 45   | 10   | 14                    | 1013 | 84   | 3    | 68                    | 320  | 130  | 14   | 47                    | 441  | 78   | 41   | 2780       |
| 08:00 AM    | 38                   | 76   | 8    | 5    | 2                     | 300  | 42   | 0    | 25                    | 102  | 41   | 6    | 13                    | 111  | 31   | 10   | 810        |
| 08:15 AM    | 27                   | 92   | 16   | 4    | 5                     | 257  | 21   | 4    | 18                    | 87   | 44   | 9    | 10                    | 109  | 30   | 6    | 739        |
| 08:30 AM    | 32                   | 61   | 15   | 3    | 5                     | 249  | 19   | 2    | 17                    | 82   | 46   | 4    | 10                    | 94   | 33   | 6    | 678        |
| 08:45 AM    | 38                   | 71   | 24   | 6    | 10                    | 217  | 19   | 5    | 12                    | 69   | 33   | 7    | 12                    | 103  | 24   | 4    | 654        |
| Total       | 135                  | 300  | 63   | 18   | 22                    | 1023 | 101  | 11   | 72                    | 340  | 164  | 26   | 45                    | 417  | 118  | 26   | 2881       |
| Grand Total | 257                  | 650  | 108  | 28   | 36                    | 2036 | 185  | 14   | 140                   | 660  | 294  | 40   | 92                    | 858  | 196  | 67   | 5661       |
| Apprch %    | 24.6                 | 62.3 | 10.4 | 2.7  | 1.6                   | 89.7 | 8.1  | 0.6  | 12.3                  | 58.2 | 25.9 | 3.5  | 7.6                   | 70.7 | 16.2 | 5.5  |            |
| Total %     | 4.5                  | 11.5 | 1.9  | 0.5  | 0.6                   | 36   | 3.3  | 0.2  | 2.5                   | 11.7 | 5.2  | 0.7  | 1.6                   | 15.2 | 3.5  | 1.2  |            |

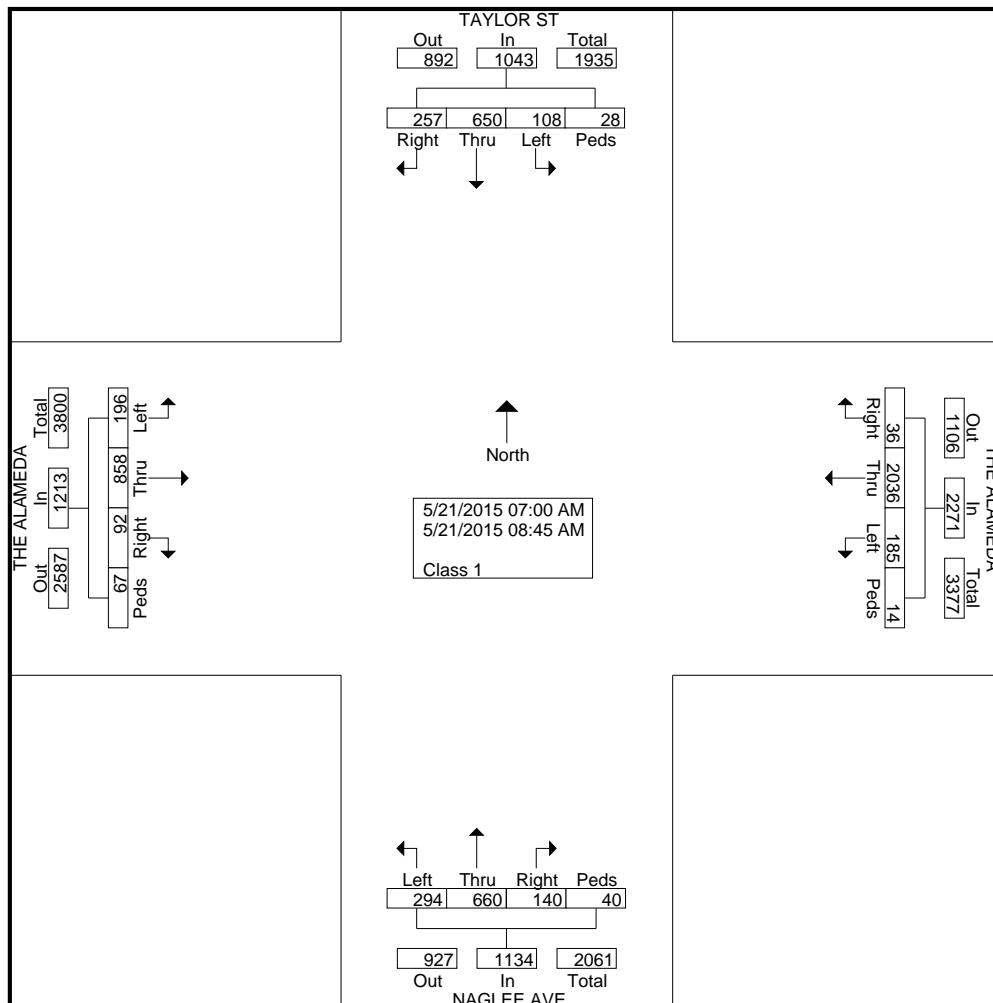

File Name : #22 ALAMEDA&TAYLORAM  
 Site Code :  
 Start Date : 5/21/2015  
 Page No : 2

| Start Time  | TAYLOR ST Southbound |      |      |      |            | THE ALAMEDA Westbound |      |      |      |            | NAGLEE AVE Northbound |      |      |      |            | THE ALAMEDA Eastbound |      |      |      |            | Int. Total |
|---|----------------------|------|------|------|------------|-----------------------|------|------|------|------------|-----------------------|------|------|------|------------|-----------------------|------|------|------|------------|------------|
|   | Right                | Thru | Left | Peds | App. Total | Right                 | Thru | Left | Peds | App. Total | Right                 | Thru | Left | Peds | App. Total | Right                 | Thru | Left | Peds | App. Total |            |
| <b>Peak Hour Analysis From 07:00 AM to 08:45 AM - Peak 1 of 1</b> |                      |      |      |      |            |                       |      |      |      |            |                       |      |      |      |            |                       |      |      |      |            |            |
| Peak Hour for Entire Intersection Begins at 07:30 AM              |                      |      |      |      |            |                       |      |      |      |            |                       |      |      |      |            |                       |      |      |      |            |            |
| 07:30 AM  | 32                   | 112  | 14   | 2    | 160        | 3                     | 287  | 24   | 3    | 317        | 28                    | 104  | 35   | 2    | 169        | 12                    | 127  | 24   | 7    | 170        | 816        |
| 07:45 AM  | 33                   | 79   | 13   | 3    | 128        | 6                     | 300  | 27   | 0    | 333        | 22                    | 110  | 33   | 12   | 177        | 11                    | 131  | 22   | 16   | 180        | 818        |
| 08:00 AM  | 38                   | 76   | 8    | 5    | 127        | 2                     | 300  | 42   | 0    | 344        | 25                    | 102  | 41   | 6    | 174        | 13                    | 111  | 31   | 10   | 165        | 810        |
| 08:15 AM  | 27                   | 92   | 16   | 4    | 139        | 5                     | 257  | 21   | 4    | 287        | 18                    | 87   | 44   | 9    | 158        | 10                    | 109  | 30   | 6    | 155        | 739        |
| Total Volume  | 130                  | 359  | 51   | 14   | 554        | 16                    | 1144 | 114  | 7    | 1281       | 93                    | 403  | 153  | 29   | 678        | 46                    | 478  | 107  | 39   | 670        | 3183       |
| % App. Total  | 23.5                 | 64.8 | 9.2  | 2.5  |            | 1.2                   | 89.3 | 8.9  | 0.5  |            | 13.7                  | 59.4 | 22.6 | 4.3  |            | 6.9                   | 71.3 | 16   | 5.8  |            |            |
| PHF   | .855                 | .801 | .797 | .700 | .866       | .667                  | .953 | .679 | .438 | .931       | .830                  | .916 | .869 | .604 | .958       | .885                  | .912 | .863 | .609 | .931       | .973       |

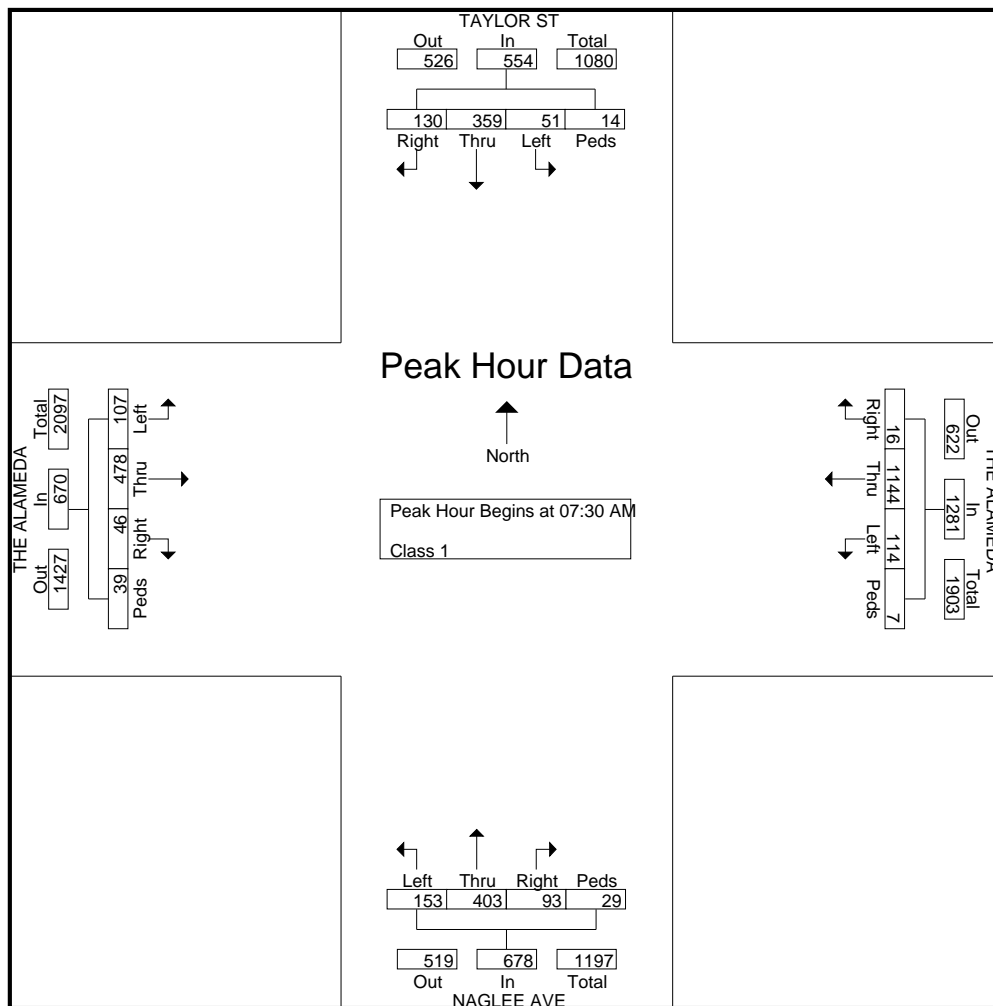



Groups Printed- Class 1

| Start Time  | SCOTT BLVD Southbound |      |      |      | CENTRAL EXPY Westbound |      |      |      | SCOTT BLVD Northbound |      |      |      | CENTRAL EXPY Eastbound |      |      |      | Int. Total |
|-------------|-----------------------|------|------|------|------------------------|------|------|------|-----------------------|------|------|------|------------------------|------|------|------|------------|
|             | Right                 | Thru | Left | Peds | Right                  | Thru | Left | Peds | Right                 | Thru | Left | Peds | Right                  | Thru | Left | Peds |            |
| 07:00 AM    | 5                     | 6    | 2    | 0    | 45                     | 456  | 28   | 1    | 44                    | 53   | 61   | 0    | 26                     | 102  | 5    | 0    | 834        |
| 07:15 AM    | 9                     | 12   | 1    | 0    | 47                     | 553  | 31   | 0    | 58                    | 42   | 84   | 0    | 28                     | 113  | 6    | 0    | 984        |
| 07:30 AM    | 7                     | 18   | 4    | 0    | 69                     | 565  | 40   | 1    | 73                    | 68   | 94   | 0    | 25                     | 159  | 19   | 0    | 1142       |
| 07:45 AM    | 4                     | 38   | 10   | 1    | 86                     | 565  | 36   | 0    | 84                    | 116  | 109  | 0    | 46                     | 162  | 42   | 1    | 1300       |
| Total       | 25                    | 74   | 17   | 1    | 247                    | 2139 | 135  | 2    | 259                   | 279  | 348  | 0    | 125                    | 536  | 72   | 1    | 4260       |
| 08:00 AM    | 25                    | 48   | 8    | 0    | 77                     | 541  | 70   | 0    | 49                    | 101  | 91   | 0    | 44                     | 201  | 16   | 0    | 1271       |
| 08:15 AM    | 5                     | 39   | 8    | 0    | 73                     | 509  | 71   | 0    | 68                    | 97   | 126  | 1    | 40                     | 211  | 18   | 4    | 1270       |
| 08:30 AM    | 2                     | 28   | 8    | 2    | 96                     | 541  | 69   | 0    | 66                    | 89   | 96   | 0    | 40                     | 211  | 35   | 0    | 1283       |
| 08:45 AM    | 7                     | 29   | 4    | 2    | 72                     | 473  | 91   | 0    | 77                    | 106  | 120  | 0    | 45                     | 197  | 32   | 5    | 1260       |
| Total       | 39                    | 144  | 28   | 4    | 318                    | 2064 | 301  | 0    | 260                   | 393  | 433  | 1    | 169                    | 820  | 101  | 9    | 5084       |
| Grand Total | 64                    | 218  | 45   | 5    | 565                    | 4203 | 436  | 2    | 519                   | 672  | 781  | 1    | 294                    | 1356 | 173  | 10   | 9344       |
| Apprch %    | 19.3                  | 65.7 | 13.6 | 1.5  | 10.9                   | 80.7 | 8.4  | 0    | 26.3                  | 34.1 | 39.6 | 0.1  | 16                     | 74   | 9.4  | 0.5  |            |
| Total %     | 0.7                   | 2.3  | 0.5  | 0.1  | 6                      | 45   | 4.7  | 0    | 5.6                   | 7.2  | 8.4  | 0    | 3.1                    | 14.5 | 1.9  | 0.1  |            |

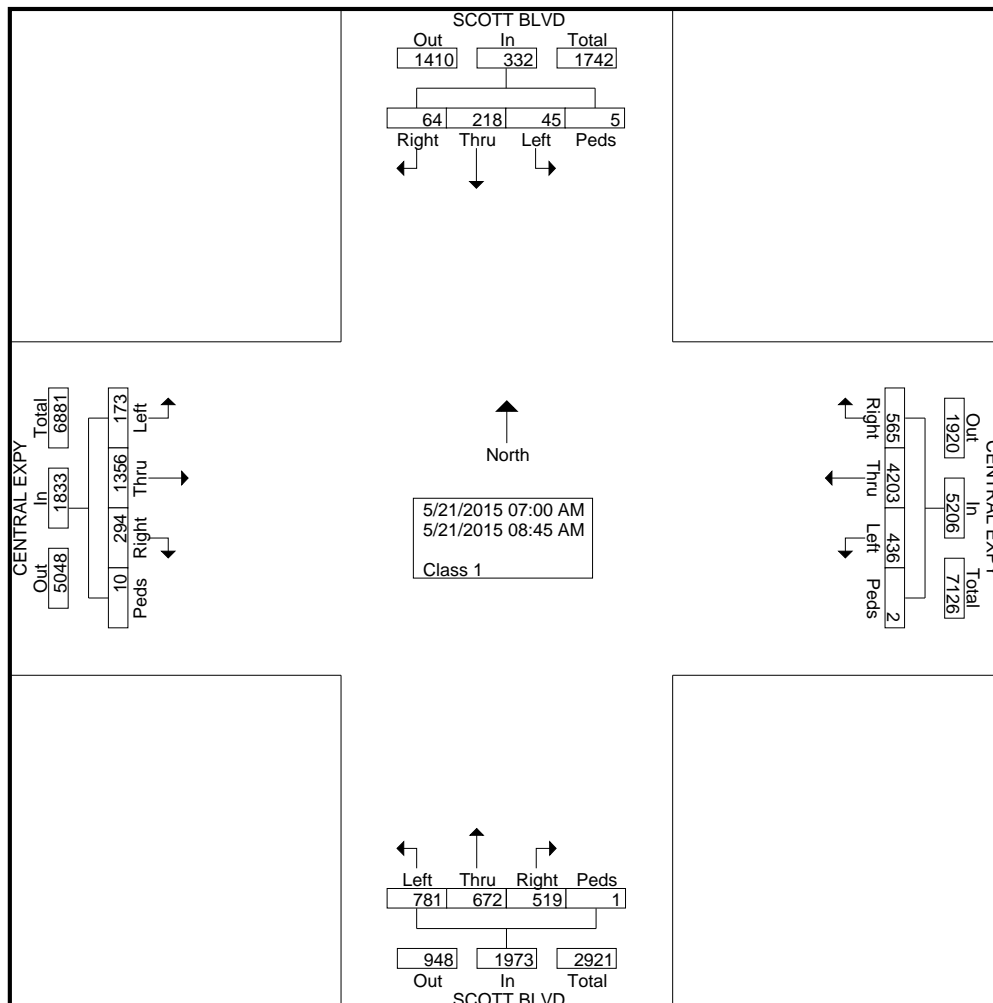

| Start Time  | SCOTT BLVD Southbound |      |      |      |            | CENTRAL EXPY Westbound |      |      |      |            | SCOTT BLVD Northbound |      |      |      |            | CENTRAL EXPY Eastbound |      |      |      |            | Int. Total |
|---|-----------------------|------|------|------|------------|------------------------|------|------|------|------------|-----------------------|------|------|------|------------|------------------------|------|------|------|------------|------------|
|   | Right                 | Thru | Left | Peds | App. Total | Right                  | Thru | Left | Peds | App. Total | Right                 | Thru | Left | Peds | App. Total | Right                  | Thru | Left | Peds | App. Total |            |
| <b>Peak Hour Analysis From 07:00 AM to 08:45 AM - Peak 1 of 1</b> |                       |      |      |      |            |                        |      |      |      |            |                       |      |      |      |            |                        |      |      |      |            |            |
| Peak Hour for Entire Intersection Begins at 07:45 AM              |                       |      |      |      |            |                        |      |      |      |            |                       |      |      |      |            |                        |      |      |      |            |            |
| 07:45 AM  | 4                     | 38   | 10   | 1    | 53         | 86                     | 565  | 36   | 0    | 687        | 84                    | 116  | 109  | 0    | 309        | 46                     | 162  | 42   | 1    | 251        | 1300       |
| 08:00 AM  | 25                    | 48   | 8    | 0    | 81         | 77                     | 541  | 70   | 0    | 688        | 49                    | 101  | 91   | 0    | 241        | 44                     | 201  | 16   | 0    | 261        | 1271       |
| 08:15 AM  | 5                     | 39   | 8    | 0    | 52         | 73                     | 509  | 71   | 0    | 653        | 68                    | 97   | 126  | 1    | 292        | 40                     | 211  | 18   | 4    | 273        | 1270       |
| 08:30 AM  | 2                     | 28   | 8    | 2    | 40         | 96                     | 541  | 69   | 0    | 706        | 66                    | 89   | 96   | 0    | 251        | 40                     | 211  | 35   | 0    | 286        | 1283       |
| Total Volume  | 36                    | 153  | 34   | 3    | 226        | 332                    | 2156 | 246  | 0    | 2734       | 267                   | 403  | 422  | 1    | 1093       | 170                    | 785  | 111  | 5    | 1071       | 5124       |
| % App. Total  | 15.9                  | 67.7 | 15   | 1.3  |            | 12.1                   | 78.9 | 9    | 0    |            | 24.4                  | 36.9 | 38.6 | 0.1  |            | 15.9                   | 73.3 | 10.4 | 0.5  |            |            |
| PHF   | .360                  | .797 | .850 | .375 | .698       | .865                   | .954 | .866 | .000 | .968       | .795                  | .869 | .837 | .250 | .884       | .924                   | .930 | .661 | .313 | .936       | .985       |

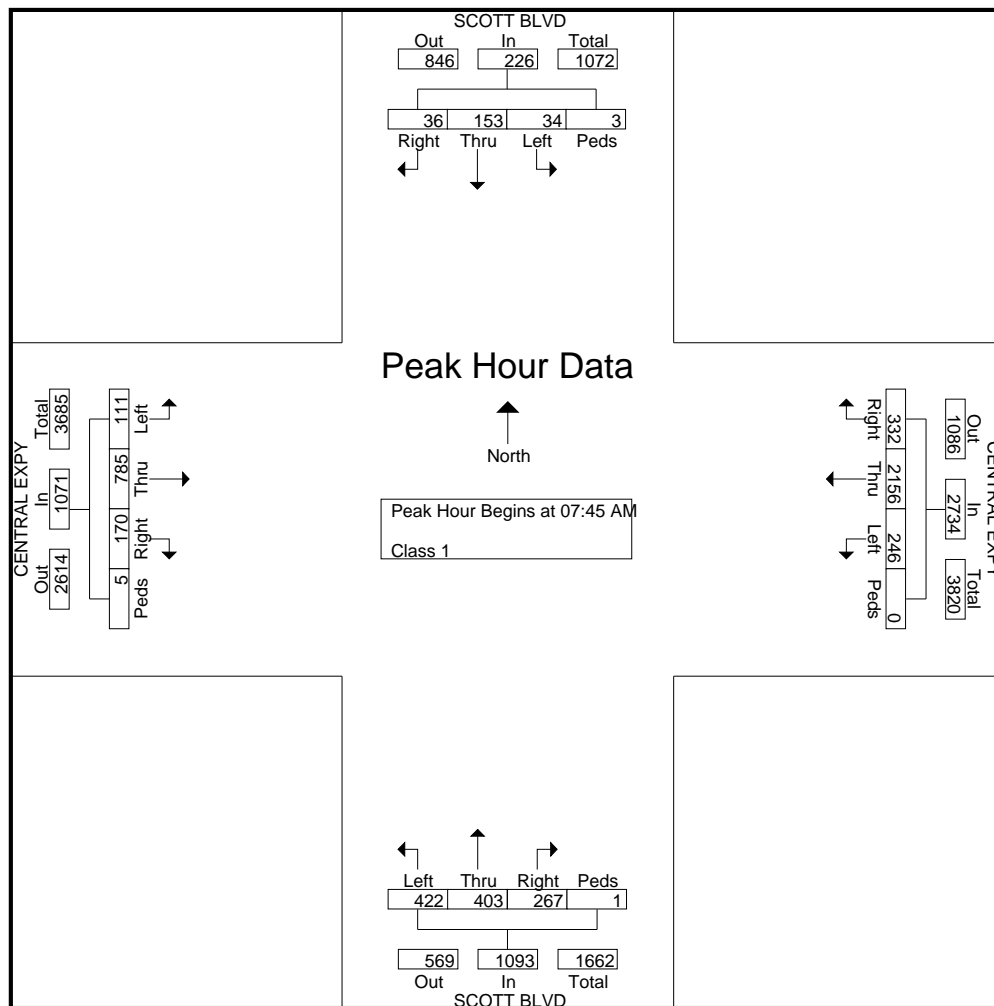

File Name : #24 LAFAYETTE&CENTRALAM  
 Site Code :  
 Start Date : 5/21/2015  
 Page No : 1

Groups Printed- Class 1

| Start Time  | LAFAYETTE ST Southbound |      |      |      | CENTRAL EXPY Westbound |      |      |      | LAFAYETTE ST Northbound |      |      |      | CENTRAL EXPY Eastbound |      |      |      | Int. Total |
|-------------|-------------------------|------|------|------|------------------------|------|------|------|-------------------------|------|------|------|------------------------|------|------|------|------------|
|             | Right                   | Thru | Left | Peds | Right                  | Thru | Left | Peds | Right                   | Thru | Left | Peds | Right                  | Thru | Left | Peds |            |
| 07:00 AM    | 26                      | 28   | 20   | 0    | 64                     | 447  | 82   | 2    | 26                      | 74   | 59   | 0    | 13                     | 112  | 26   | 0    | 979        |
| 07:15 AM    | 27                      | 48   | 27   | 0    | 64                     | 489  | 45   | 0    | 39                      | 114  | 83   | 0    | 22                     | 101  | 32   | 0    | 1091       |
| 07:30 AM    | 40                      | 74   | 32   | 1    | 71                     | 488  | 67   | 0    | 41                      | 141  | 97   | 0    | 26                     | 142  | 38   | 0    | 1258       |
| 07:45 AM    | 36                      | 115  | 33   | 1    | 63                     | 510  | 57   | 2    | 50                      | 162  | 127  | 1    | 27                     | 172  | 60   | 2    | 1418       |
| Total       | 129                     | 265  | 112  | 2    | 262                    | 1934 | 251  | 4    | 156                     | 491  | 366  | 1    | 88                     | 527  | 156  | 2    | 4746       |
| 08:00 AM    | 39                      | 81   | 27   | 0    | 91                     | 544  | 66   | 0    | 40                      | 138  | 111  | 0    | 40                     | 190  | 43   | 0    | 1410       |
| 08:15 AM    | 41                      | 88   | 42   | 0    | 85                     | 512  | 70   | 0    | 39                      | 181  | 96   | 0    | 28                     | 189  | 48   | 0    | 1419       |
| 08:30 AM    | 39                      | 78   | 37   | 0    | 80                     | 497  | 60   | 0    | 55                      | 197  | 89   | 0    | 29                     | 178  | 60   | 0    | 1399       |
| 08:45 AM    | 34                      | 95   | 48   | 2    | 92                     | 488  | 56   | 2    | 59                      | 170  | 103  | 0    | 37                     | 234  | 56   | 0    | 1476       |
| Total       | 153                     | 342  | 154  | 2    | 348                    | 2041 | 252  | 2    | 193                     | 686  | 399  | 0    | 134                    | 791  | 207  | 0    | 5704       |
| Grand Total | 282                     | 607  | 266  | 4    | 610                    | 3975 | 503  | 6    | 349                     | 1177 | 765  | 1    | 222                    | 1318 | 363  | 2    | 10450      |
| Apprch %    | 24.3                    | 52.4 | 23   | 0.3  | 12                     | 78   | 9.9  | 0.1  | 15.2                    | 51.4 | 33.4 | 0    | 11.7                   | 69.2 | 19.1 | 0.1  |            |
| Total %     | 2.7                     | 5.8  | 2.5  | 0    | 5.8                    | 38   | 4.8  | 0.1  | 3.3                     | 11.3 | 7.3  | 0    | 2.1                    | 12.6 | 3.5  | 0    |            |

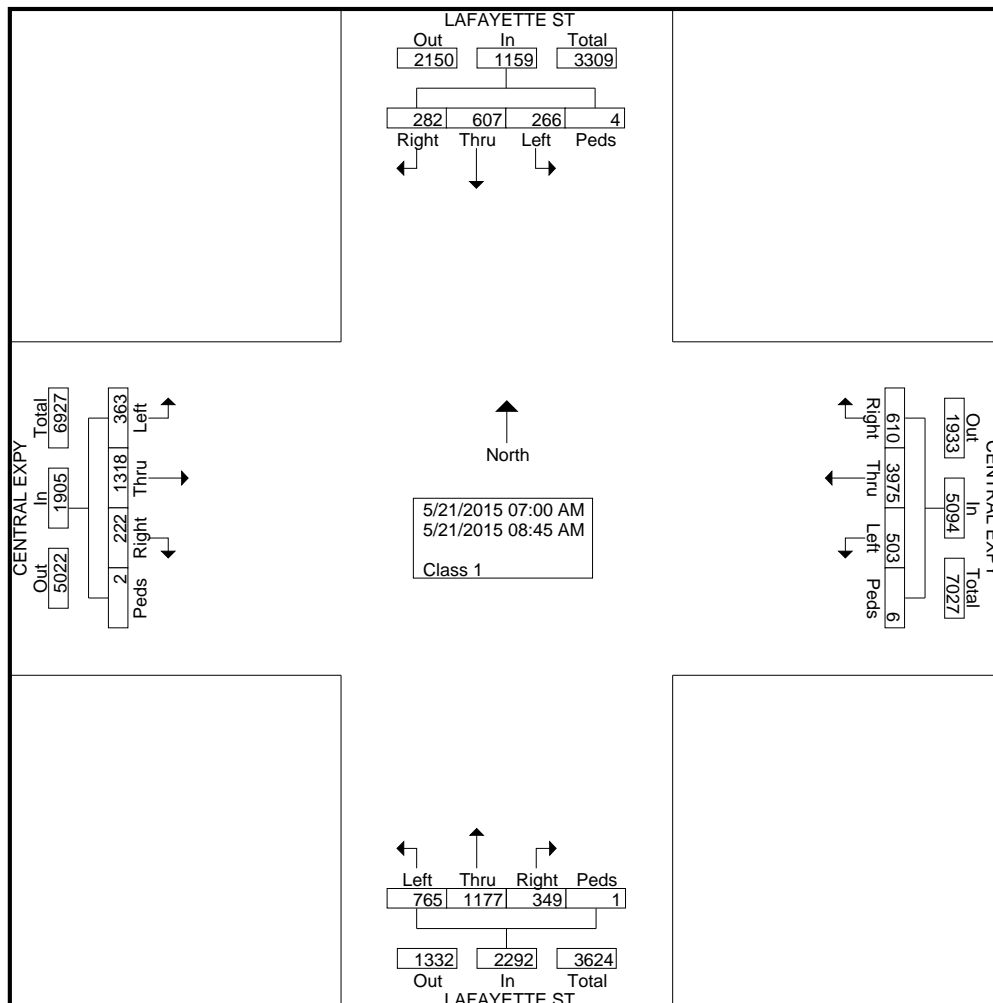

File Name : #24 LAFAYETTE&CENTRALAM  
 Site Code :  
 Start Date : 5/21/2015  
 Page No : 2

| Start Time  | LAFAYETTE ST Southbound |      |      |      |            | CENTRAL EXPY Westbound |      |      |      |            | LAFAYETTE ST Northbound |      |      |      |            | CENTRAL EXPY Eastbound |      |      |      |            | Int. Total |
|---|-------------------------|------|------|------|------------|------------------------|------|------|------|------------|-------------------------|------|------|------|------------|------------------------|------|------|------|------------|------------|
|   | Right                   | Thru | Left | Peds | App. Total | Right                  | Thru | Left | Peds | App. Total | Right                   | Thru | Left | Peds | App. Total | Right                  | Thru | Left | Peds | App. Total |            |
| <b>Peak Hour Analysis From 07:00 AM to 08:45 AM - Peak 1 of 1</b> |                         |      |      |      |            |                        |      |      |      |            |                         |      |      |      |            |                        |      |      |      |            |            |
| Peak Hour for Entire Intersection Begins at 08:00 AM              |                         |      |      |      |            |                        |      |      |      |            |                         |      |      |      |            |                        |      |      |      |            |            |
| 08:00 AM  | 39                      | 81   | 27   | 0    | 147        | 91                     | 544  | 66   | 0    | 701        | 40                      | 138  | 111  | 0    | 289        | 40                     | 190  | 43   | 0    | 273        | 1410       |
| 08:15 AM  | 41                      | 88   | 42   | 0    | 171        | 85                     | 512  | 70   | 0    | 667        | 39                      | 181  | 96   | 0    | 316        | 28                     | 189  | 48   | 0    | 265        | 1419       |
| 08:30 AM  | 39                      | 78   | 37   | 0    | 154        | 80                     | 497  | 60   | 0    | 637        | 55                      | 197  | 89   | 0    | 341        | 29                     | 178  | 60   | 0    | 267        | 1399       |
| 08:45 AM  | 34                      | 95   | 48   | 2    | 179        | 92                     | 488  | 56   | 2    | 638        | 59                      | 170  | 103  | 0    | 332        | 37                     | 234  | 56   | 0    | 327        | 1476       |
| Total Volume  | 153                     | 342  | 154  | 2    | 651        | 348                    | 2041 | 252  | 2    | 2643       | 193                     | 686  | 399  | 0    | 1278       | 134                    | 791  | 207  | 0    | 1132       | 5704       |
| % App. Total  | 23.5                    | 52.5 | 23.7 | 0.3  |            | 13.2                   | 77.2 | 9.5  | 0.1  |            | 15.1                    | 53.7 | 31.2 | 0    |            | 11.8                   | 69.9 | 18.3 | 0    |            |            |
| PHF   | .933                    | .900 | .802 | .250 | .909       | .946                   | .938 | .900 | .250 | .943       | .818                    | .871 | .899 | .000 | .937       | .838                   | .845 | .863 | .000 | .865       | .966       |

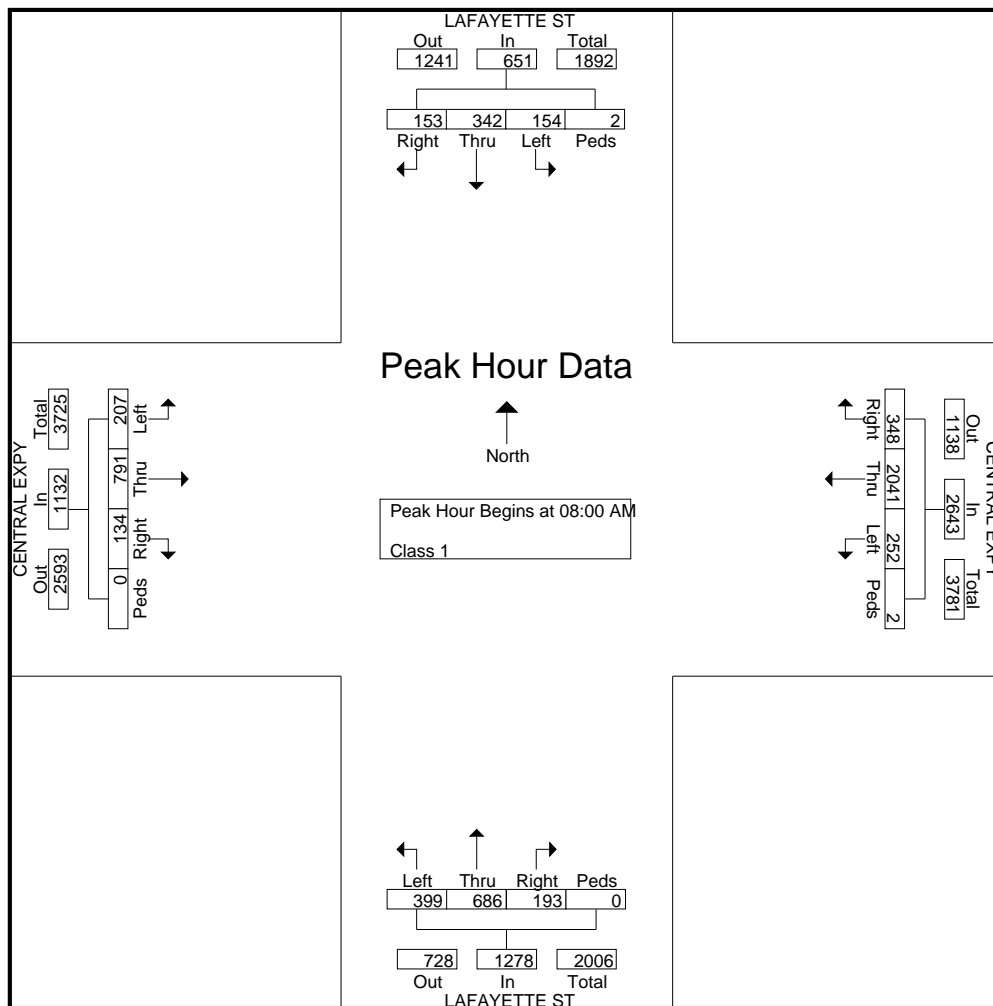

Groups Printed- Class 1

| Start Time  | BASCOM AVE Southbound |      |      |      | NAGLEE AVE Westbound |      |      |      | BASCOM AVE Northbound |      |      |      | NAGLEE AVE Eastbound |      |      |      | Int. Total |
|-------------|-----------------------|------|------|------|----------------------|------|------|------|-----------------------|------|------|------|----------------------|------|------|------|------------|
|             | Right                 | Thru | Left | Peds | Right                | Thru | Left | Peds | Right                 | Thru | Left | Peds | Right                | Thru | Left | Peds |            |
| 07:00 AM    | 14                    | 64   | 20   | 1    | 24                   | 29   | 11   | 2    | 22                    | 174  | 17   | 4    | 1                    | 11   | 7    | 2    | 403        |
| 07:15 AM    | 26                    | 96   | 27   | 4    | 28                   | 54   | 24   | 2    | 33                    | 220  | 31   | 1    | 0                    | 34   | 7    | 3    | 590        |
| 07:30 AM    | 44                    | 85   | 24   | 2    | 30                   | 65   | 34   | 2    | 28                    | 290  | 20   | 2    | 0                    | 38   | 14   | 0    | 678        |
| 07:45 AM    | 38                    | 93   | 10   | 0    | 25                   | 77   | 27   | 2    | 51                    | 313  | 35   | 0    | 3                    | 45   | 36   | 1    | 756        |
| Total       | 122                   | 338  | 81   | 7    | 107                  | 225  | 96   | 8    | 134                   | 997  | 103  | 7    | 4                    | 128  | 64   | 6    | 2427       |
| 08:00 AM    | 27                    | 90   | 24   | 2    | 26                   | 68   | 39   | 0    | 49                    | 312  | 24   | 1    | 0                    | 59   | 21   | 0    | 742        |
| 08:15 AM    | 27                    | 92   | 28   | 1    | 42                   | 56   | 31   | 3    | 52                    | 329  | 51   | 3    | 1                    | 38   | 18   | 1    | 773        |
| 08:30 AM    | 37                    | 102  | 18   | 0    | 32                   | 54   | 29   | 1    | 50                    | 313  | 23   | 3    | 2                    | 34   | 9    | 0    | 707        |
| 08:45 AM    | 30                    | 81   | 11   | 1    | 17                   | 51   | 31   | 0    | 58                    | 309  | 38   | 2    | 0                    | 37   | 12   | 1    | 679        |
| Total       | 121                   | 365  | 81   | 4    | 117                  | 229  | 130  | 4    | 209                   | 1263 | 136  | 9    | 3                    | 168  | 60   | 2    | 2901       |
| Grand Total | 243                   | 703  | 162  | 11   | 224                  | 454  | 226  | 12   | 343                   | 2260 | 239  | 16   | 7                    | 296  | 124  | 8    | 5328       |
| Apprch %    | 21.7                  | 62.8 | 14.5 | 1    | 24.5                 | 49.6 | 24.7 | 1.3  | 12                    | 79.1 | 8.4  | 0.6  | 1.6                  | 68   | 28.5 | 1.8  |            |
| Total %     | 4.6                   | 13.2 | 3    | 0.2  | 4.2                  | 8.5  | 4.2  | 0.2  | 6.4                   | 42.4 | 4.5  | 0.3  | 0.1                  | 5.6  | 2.3  | 0.2  |            |

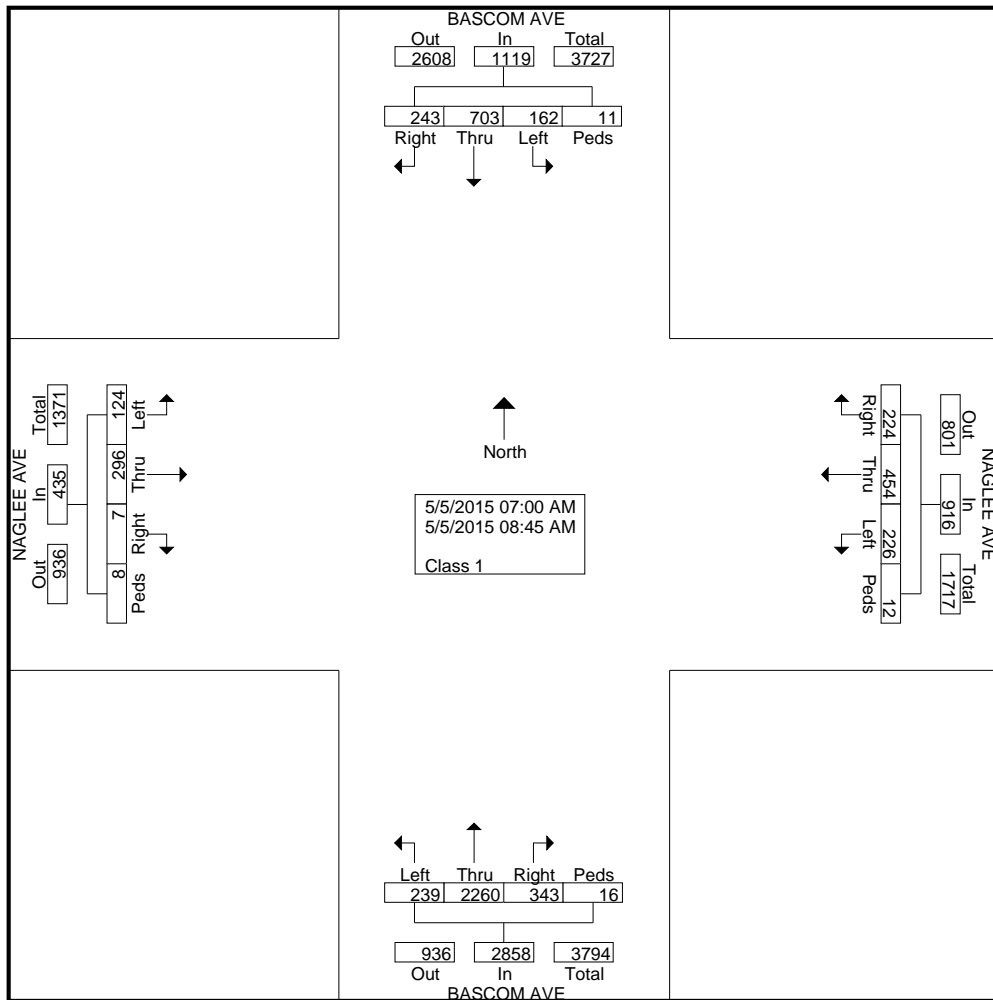

| Start Time  | BASCOM AVE Southbound |      |      |      |            | NAGLEE AVE Westbound |      |      |      |            | BASCOM AVE Northbound |      |      |      |            | NAGLEE AVE Eastbound |      |      |      |            | Int. Total |
|---|-----------------------|------|------|------|------------|----------------------|------|------|------|------------|-----------------------|------|------|------|------------|----------------------|------|------|------|------------|------------|
|   | Right                 | Thru | Left | Peds | App. Total | Right                | Thru | Left | Peds | App. Total | Right                 | Thru | Left | Peds | App. Total | Right                | Thru | Left | Peds | App. Total |            |
| <b>Peak Hour Analysis From 07:00 AM to 08:45 AM - Peak 1 of 1</b> |                       |      |      |      |            |                      |      |      |      |            |                       |      |      |      |            |                      |      |      |      |            |            |
| Peak Hour for Entire Intersection Begins at 07:45 AM              |                       |      |      |      |            |                      |      |      |      |            |                       |      |      |      |            |                      |      |      |      |            |            |
| 07:45 AM  | 38                    | 93   | 10   | 0    | 141        | 25                   | 77   | 27   | 2    | 131        | 51                    | 313  | 35   | 0    | 399        | 3                    | 45   | 36   | 1    | 85         | 756        |
| 08:00 AM  | 27                    | 90   | 24   | 2    | 143        | 26                   | 68   | 39   | 0    | 133        | 49                    | 312  | 24   | 1    | 386        | 0                    | 59   | 21   | 0    | 80         | 742        |
| 08:15 AM  | 27                    | 92   | 28   | 1    | 148        | 42                   | 56   | 31   | 3    | 132        | 52                    | 329  | 51   | 3    | 435        | 1                    | 38   | 18   | 1    | 58         | 773        |
| 08:30 AM  | 37                    | 102  | 18   | 0    | 157        | 32                   | 54   | 29   | 1    | 116        | 50                    | 313  | 23   | 3    | 389        | 2                    | 34   | 9    | 0    | 45         | 707        |
| Total Volume  | 129                   | 377  | 80   | 3    | 589        | 125                  | 255  | 126  | 6    | 512        | 202                   | 1267 | 133  | 7    | 1609       | 6                    | 176  | 84   | 2    | 268        | 2978       |
| % App. Total  | 21.9                  | 64   | 13.6 | 0.5  |            | 24.4                 | 49.8 | 24.6 | 1.2  |            | 12.6                  | 78.7 | 8.3  | 0.4  |            | 2.2                  | 65.7 | 31.3 | 0.7  |            |            |
| PHF   | .849                  | .924 | .714 | .375 | .938       | .744                 | .828 | .808 | .500 | .962       | .971                  | .963 | .652 | .583 | .925       | .500                 | .746 | .583 | .500 | .788       | .963       |

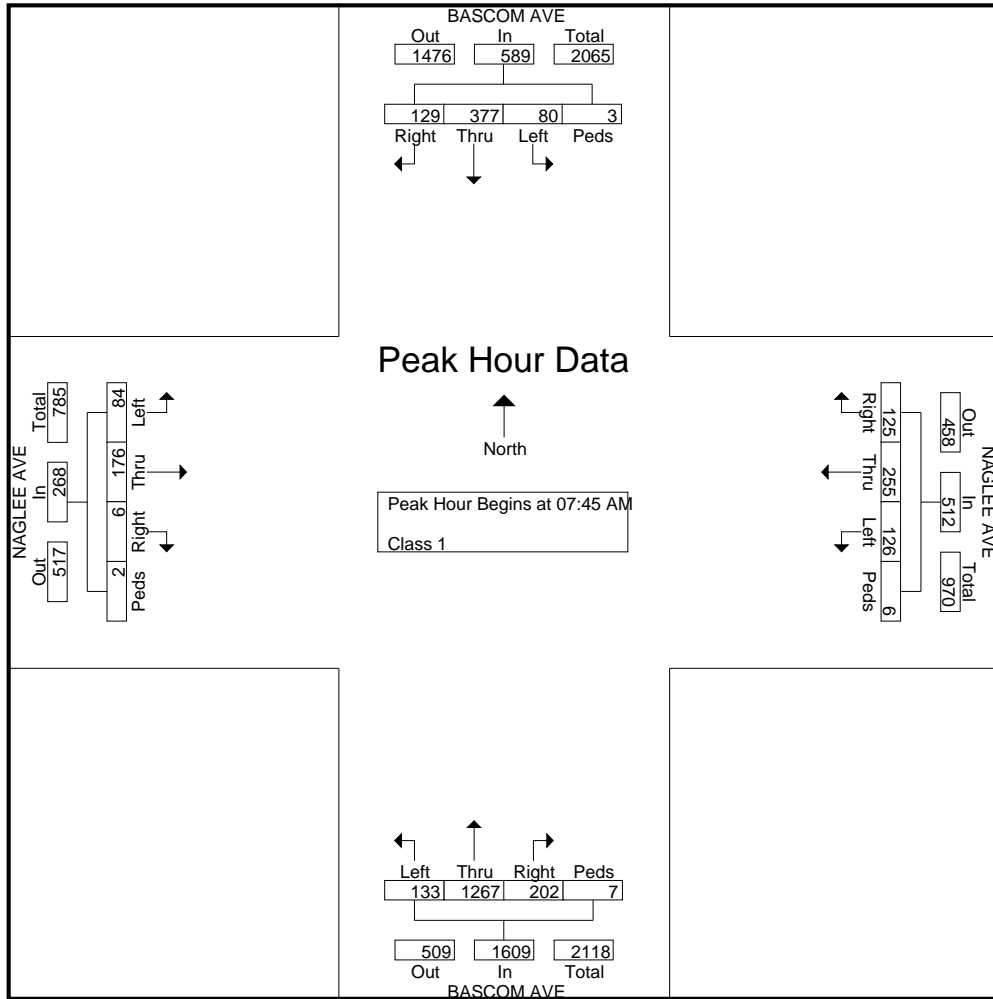

Groups Printed- Class 1

| Start Time  | BASCOM AVE Southbound |      |      |      | NAGLEE AVE Westbound |      |      |      | BASCOM AVE Northbound |      |      |      | NAGLEE AVE Eastbound |      |      |      | Int. Total |
|-------------|-----------------------|------|------|------|----------------------|------|------|------|-----------------------|------|------|------|----------------------|------|------|------|------------|
|             | Right                 | Thru | Left | Peds | Right                | Thru | Left | Peds | Right                 | Thru | Left | Peds | Right                | Thru | Left | Peds |            |
| 04:00 PM    | 35                    | 207  | 29   | 0    | 17                   | 51   | 49   | 1    | 29                    | 103  | 26   | 2    | 6                    | 67   | 30   | 2    | 654        |
| 04:15 PM    | 27                    | 188  | 29   | 0    | 17                   | 47   | 36   | 0    | 49                    | 90   | 25   | 0    | 6                    | 73   | 22   | 1    | 610        |
| 04:30 PM    | 26                    | 207  | 35   | 0    | 20                   | 54   | 39   | 1    | 32                    | 124  | 18   | 3    | 0                    | 62   | 45   | 4    | 670        |
| 04:45 PM    | 28                    | 219  | 35   | 2    | 17                   | 49   | 35   | 1    | 29                    | 122  | 22   | 4    | 7                    | 70   | 19   | 0    | 659        |
| Total       | 116                   | 821  | 128  | 2    | 71                   | 201  | 159  | 3    | 139                   | 439  | 91   | 9    | 19                   | 272  | 116  | 7    | 2593       |
| 05:00 PM    | 18                    | 258  | 49   | 3    | 22                   | 72   | 44   | 0    | 46                    | 127  | 21   | 5    | 5                    | 71   | 27   | 2    | 770        |
| 05:15 PM    | 27                    | 285  | 49   | 0    | 20                   | 53   | 45   | 5    | 49                    | 109  | 25   | 6    | 6                    | 92   | 34   | 0    | 805        |
| 05:30 PM    | 28                    | 287  | 49   | 1    | 24                   | 68   | 49   | 0    | 49                    | 102  | 28   | 2    | 5                    | 107  | 35   | 0    | 834        |
| 05:45 PM    | 19                    | 262  | 57   | 3    | 23                   | 54   | 43   | 0    | 55                    | 99   | 29   | 2    | 4                    | 101  | 28   | 2    | 781        |
| Total       | 92                    | 1092 | 204  | 7    | 89                   | 247  | 181  | 5    | 199                   | 437  | 103  | 15   | 20                   | 371  | 124  | 4    | 3190       |
| Grand Total | 208                   | 1913 | 332  | 9    | 160                  | 448  | 340  | 8    | 338                   | 876  | 194  | 24   | 39                   | 643  | 240  | 11   | 5783       |
| Apprch %    | 8.4                   | 77.7 | 13.5 | 0.4  | 16.7                 | 46.9 | 35.6 | 0.8  | 23.6                  | 61.2 | 13.5 | 1.7  | 4.2                  | 68.9 | 25.7 | 1.2  |            |
| Total %     | 3.6                   | 33.1 | 5.7  | 0.2  | 2.8                  | 7.7  | 5.9  | 0.1  | 5.8                   | 15.1 | 3.4  | 0.4  | 0.7                  | 11.1 | 4.2  | 0.2  |            |

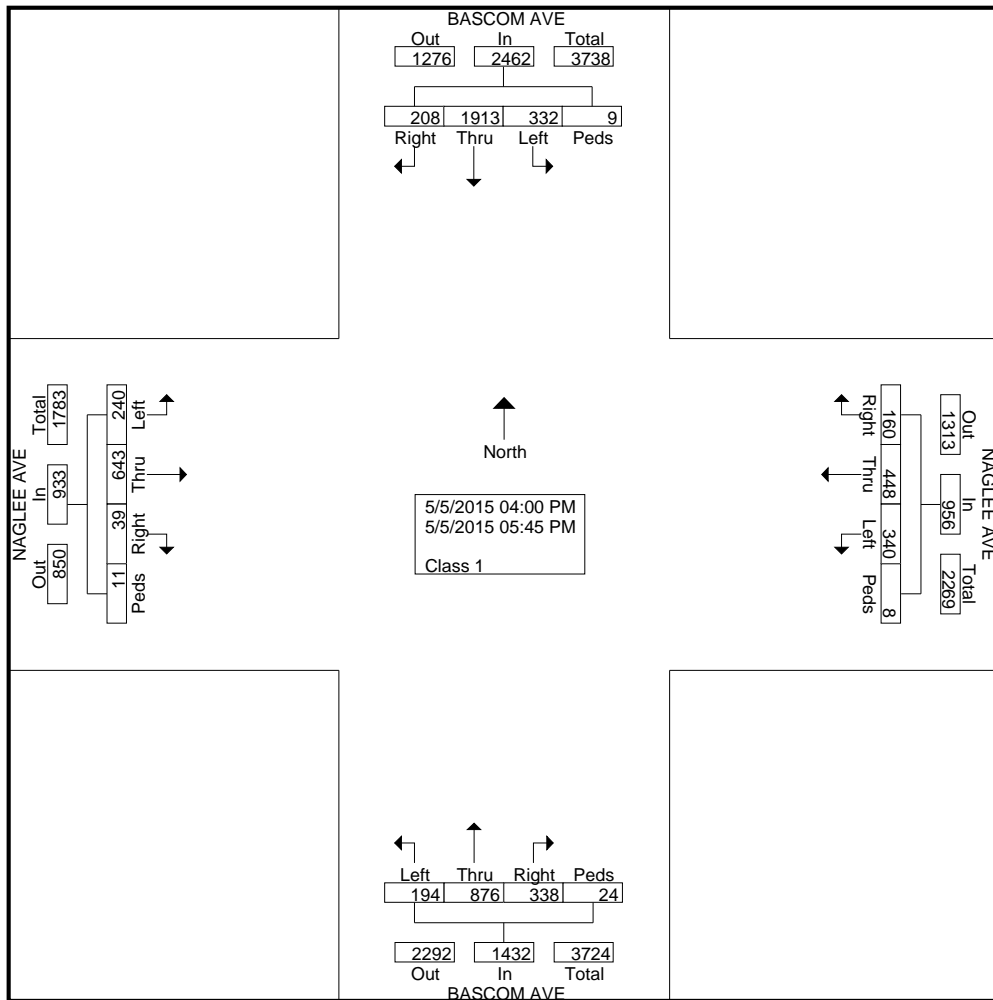

| Start Time  | BASCOM AVE Southbound |      |      |      |            | NAGLEE AVE Westbound |      |      |      |            | BASCOM AVE Northbound |      |      |      |            | NAGLEE AVE Eastbound |      |      |      |            | Int. Total |
|---|-----------------------|------|------|------|------------|----------------------|------|------|------|------------|-----------------------|------|------|------|------------|----------------------|------|------|------|------------|------------|
|   | Right                 | Thru | Left | Peds | App. Total | Right                | Thru | Left | Peds | App. Total | Right                 | Thru | Left | Peds | App. Total | Right                | Thru | Left | Peds | App. Total |            |
| <b>Peak Hour Analysis From 04:00 PM to 05:45 PM - Peak 1 of 1</b> |                       |      |      |      |            |                      |      |      |      |            |                       |      |      |      |            |                      |      |      |      |            |            |
| Peak Hour for Entire Intersection Begins at 05:00 PM              |                       |      |      |      |            |                      |      |      |      |            |                       |      |      |      |            |                      |      |      |      |            |            |
| 05:00 PM  | 18                    | 258  | 49   | 3    | 328        | 22                   | 72   | 44   | 0    | 138        | 46                    | 127  | 21   | 5    | 199        | 5                    | 71   | 27   | 2    | 105        | 770        |
| 05:15 PM  | 27                    | 285  | 49   | 0    | 361        | 20                   | 53   | 45   | 5    | 123        | 49                    | 109  | 25   | 6    | 189        | 6                    | 92   | 34   | 0    | 132        | 805        |
| 05:30 PM  | 28                    | 287  | 49   | 1    | 365        | 24                   | 68   | 49   | 0    | 141        | 49                    | 102  | 28   | 2    | 181        | 5                    | 107  | 35   | 0    | 147        | 834        |
| 05:45 PM  | 19                    | 262  | 57   | 3    | 341        | 23                   | 54   | 43   | 0    | 120        | 55                    | 99   | 29   | 2    | 185        | 4                    | 101  | 28   | 2    | 135        | 781        |
| Total Volume  | 92                    | 1092 | 204  | 7    | 1395       | 89                   | 247  | 181  | 5    | 522        | 199                   | 437  | 103  | 15   | 754        | 20                   | 371  | 124  | 4    | 519        | 3190       |
| % App. Total  | 6.6                   | 78.3 | 14.6 | 0.5  |            | 17                   | 47.3 | 34.7 | 1    |            | 26.4                  | 58   | 13.7 | 2    |            | 3.9                  | 71.5 | 23.9 | 0.8  |            |            |
| PHF   | .821                  | .951 | .895 | .583 | .955       | .927                 | .858 | .923 | .250 | .926       | .905                  | .860 | .888 | .625 | .947       | .833                 | .867 | .886 | .500 | .883       | .956       |

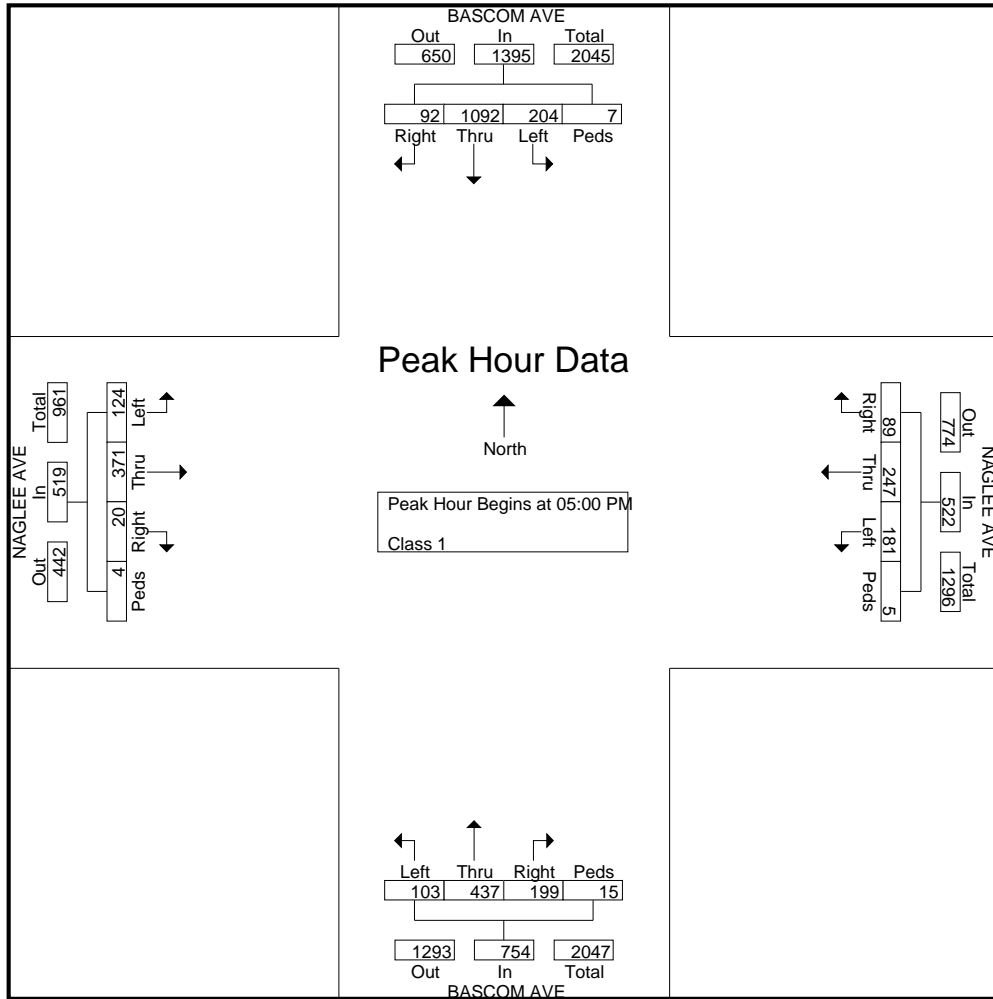



File Name : #25 LINCOLN&ELCAMINOAM  
 Site Code :  
 Start Date : 5/21/2015  
 Page No : 1

Groups Printed- Class 1

| Start Time  | LINCOLN ST Southbound |      |      |      | EL CAMINO REAL Westbound |      |      |      | LINCOLN ST Northbound |      |      |      | EL CAMINO REAL Eastbound |      |      |      | Int. Total |
|-------------|-----------------------|------|------|------|--------------------------|------|------|------|-----------------------|------|------|------|--------------------------|------|------|------|------------|
|             | Right                 | Thru | Left | Peds | Right                    | Thru | Left | Peds | Right                 | Thru | Left | Peds | Right                    | Thru | Left | Peds |            |
| 07:00 AM    | 2                     | 5    | 5    | 1    | 7                        | 161  | 1    | 1    | 13                    | 10   | 19   | 0    | 11                       | 82   | 0    | 0    | 318        |
| 07:15 AM    | 7                     | 6    | 5    | 0    | 3                        | 193  | 1    | 0    | 14                    | 4    | 9    | 0    | 9                        | 91   | 3    | 0    | 345        |
| 07:30 AM    | 9                     | 5    | 6    | 2    | 13                       | 236  | 5    | 0    | 19                    | 18   | 31   | 2    | 5                        | 105  | 4    | 1    | 461        |
| 07:45 AM    | 5                     | 7    | 8    | 0    | 11                       | 239  | 12   | 2    | 30                    | 22   | 26   | 2    | 10                       | 151  | 6    | 0    | 531        |
| Total       | 23                    | 23   | 24   | 3    | 34                       | 829  | 19   | 3    | 76                    | 54   | 85   | 4    | 35                       | 429  | 13   | 1    | 1655       |
| 08:00 AM    | 4                     | 4    | 5    | 4    | 13                       | 226  | 12   | 2    | 24                    | 16   | 38   | 1    | 13                       | 141  | 5    | 0    | 508        |
| 08:15 AM    | 7                     | 8    | 5    | 8    | 8                        | 230  | 9    | 1    | 24                    | 16   | 37   | 2    | 6                        | 167  | 1    | 0    | 529        |
| 08:30 AM    | 12                    | 5    | 8    | 0    | 8                        | 226  | 11   | 1    | 20                    | 11   | 23   | 1    | 7                        | 141  | 7    | 2    | 483        |
| 08:45 AM    | 10                    | 6    | 6    | 6    | 8                        | 214  | 8    | 1    | 18                    | 17   | 27   | 3    | 10                       | 132  | 8    | 1    | 475        |
| Total       | 33                    | 23   | 24   | 18   | 37                       | 896  | 40   | 5    | 86                    | 60   | 125  | 7    | 36                       | 581  | 21   | 3    | 1995       |
| Grand Total | 56                    | 46   | 48   | 21   | 71                       | 1725 | 59   | 8    | 162                   | 114  | 210  | 11   | 71                       | 1010 | 34   | 4    | 3650       |
| Apprch %    | 32.7                  | 26.9 | 28.1 | 12.3 | 3.8                      | 92.6 | 3.2  | 0.4  | 32.6                  | 22.9 | 42.3 | 2.2  | 6.3                      | 90.3 | 3    | 0.4  |            |
| Total %     | 1.5                   | 1.3  | 1.3  | 0.6  | 1.9                      | 47.3 | 1.6  | 0.2  | 4.4                   | 3.1  | 5.8  | 0.3  | 1.9                      | 27.7 | 0.9  | 0.1  |            |

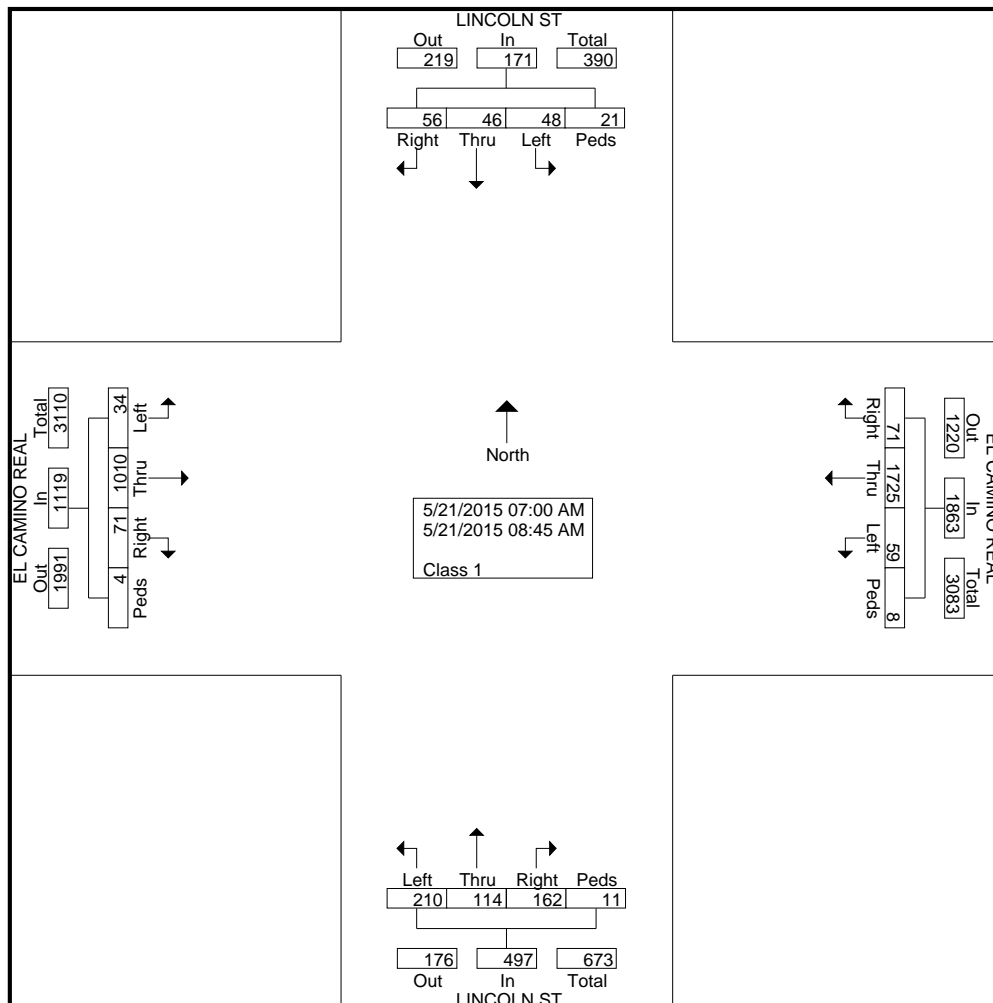

File Name : #25 LINCOLN&ELCAMINOAM  
 Site Code :  
 Start Date : 5/21/2015  
 Page No : 2

| Start Time  | LINCOLN ST Southbound |      |      |      |            | EL CAMINO REAL Westbound |      |      |      |            | LINCOLN ST Northbound |      |      |      |            | EL CAMINO REAL Eastbound |      |      |      |            | Int. Total |
|---|-----------------------|------|------|------|------------|--------------------------|------|------|------|------------|-----------------------|------|------|------|------------|--------------------------|------|------|------|------------|------------|
|   | Right                 | Thru | Left | Peds | App. Total | Right                    | Thru | Left | Peds | App. Total | Right                 | Thru | Left | Peds | App. Total | Right                    | Thru | Left | Peds | App. Total |            |
| <b>Peak Hour Analysis From 07:00 AM to 08:45 AM - Peak 1 of 1</b> |                       |      |      |      |            |                          |      |      |      |            |                       |      |      |      |            |                          |      |      |      |            |            |
| Peak Hour for Entire Intersection Begins at 07:45 AM              |                       |      |      |      |            |                          |      |      |      |            |                       |      |      |      |            |                          |      |      |      |            |            |
| 07:45 AM  | 5                     | 7    | 8    | 0    | 20         | 11                       | 239  | 12   | 2    | 264        | 30                    | 22   | 26   | 2    | 80         | 10                       | 151  | 6    | 0    | 167        | 531        |
| 08:00 AM  | 4                     | 4    | 5    | 4    | 17         | 13                       | 226  | 12   | 2    | 253        | 24                    | 16   | 38   | 1    | 79         | 13                       | 141  | 5    | 0    | 159        | 508        |
| 08:15 AM  | 7                     | 8    | 5    | 8    | 28         | 8                        | 230  | 9    | 1    | 248        | 24                    | 16   | 37   | 2    | 79         | 6                        | 167  | 1    | 0    | 174        | 529        |
| 08:30 AM  | 12                    | 5    | 8    | 0    | 25         | 8                        | 226  | 11   | 1    | 246        | 20                    | 11   | 23   | 1    | 55         | 7                        | 141  | 7    | 2    | 157        | 483        |
| Total Volume  | 28                    | 24   | 26   | 12   | 90         | 40                       | 921  | 44   | 6    | 1011       | 98                    | 65   | 124  | 6    | 293        | 36                       | 600  | 19   | 2    | 657        | 2051       |
| % App. Total  | 31.1                  | 26.7 | 28.9 | 13.3 |            | 4                        | 91.1 | 4.4  | 0.6  |            | 33.4                  | 22.2 | 42.3 | 2    |            | 5.5                      | 91.3 | 2.9  | 0.3  |            |            |
| PHF   | .583                  | .750 | .813 | .375 | .804       | .769                     | .963 | .917 | .750 | .957       | .817                  | .739 | .816 | .750 | .916       | .692                     | .898 | .679 | .250 | .944       | .966       |

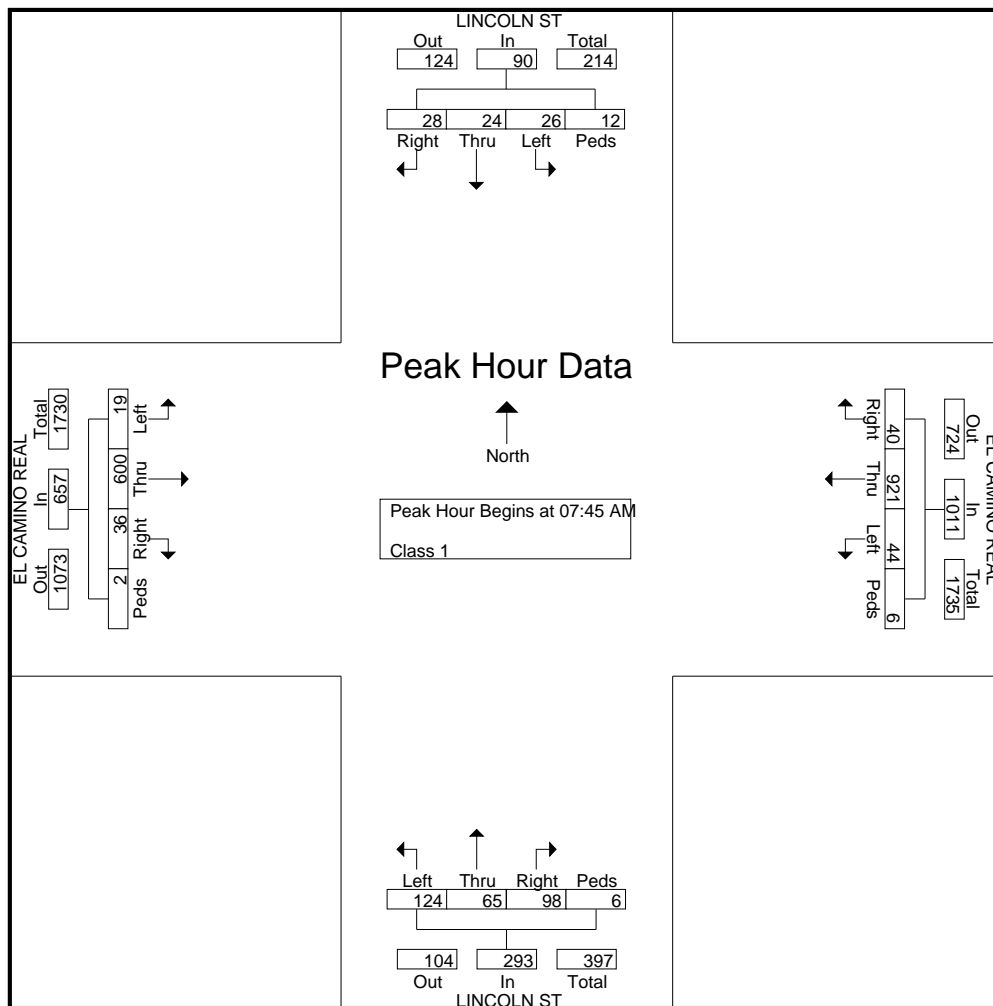

File Name : #26 BASCOM&SAN CARLOS AM  
 Site Code : 26  
 Start Date : 5/6/2015  
 Page No : 1

Groups Printed- Class 1

| Start Time  | BASCOM AVE Southbound |      |      |      | SAN CARLOS ST Westbound |      |      |      | BASCOM AVE Northbound |      |      |      | SAN CARLOS ST Eastbound |      |      |      | Int. Total |
|-------------|-----------------------|------|------|------|-------------------------|------|------|------|-----------------------|------|------|------|-------------------------|------|------|------|------------|
|             | Right                 | Thru | Left | Peds | Right                   | Thru | Left | Peds | Right                 | Thru | Left | Peds | Right                   | Thru | Left | Peds |            |
| 07:00 AM    | 11                    | 53   | 20   | 2    | 50                      | 132  | 18   | 1    | 11                    | 163  | 47   | 2    | 8                       | 24   | 4    | 2    | 548        |
| 07:15 AM    | 17                    | 86   | 13   | 2    | 49                      | 204  | 19   | 1    | 15                    | 218  | 57   | 3    | 23                      | 30   | 5    | 1    | 743        |
| 07:30 AM    | 13                    | 98   | 21   | 3    | 63                      | 223  | 39   | 2    | 25                    | 250  | 55   | 1    | 29                      | 29   | 9    | 7    | 867        |
| 07:45 AM    | 13                    | 100  | 22   | 0    | 71                      | 281  | 36   | 7    | 41                    | 277  | 70   | 2    | 22                      | 45   | 11   | 0    | 998        |
| Total       | 54                    | 337  | 76   | 7    | 233                     | 840  | 112  | 11   | 92                    | 908  | 229  | 8    | 82                      | 128  | 29   | 10   | 3156       |
| 08:00 AM    | 15                    | 121  | 24   | 1    | 68                      | 181  | 40   | 2    | 18                    | 331  | 57   | 5    | 16                      | 40   | 19   | 2    | 940        |
| 08:15 AM    | 20                    | 91   | 23   | 1    | 82                      | 212  | 40   | 7    | 40                    | 258  | 54   | 5    | 20                      | 44   | 32   | 0    | 929        |
| 08:30 AM    | 14                    | 119  | 29   | 3    | 55                      | 163  | 24   | 8    | 49                    | 310  | 47   | 7    | 19                      | 49   | 13   | 0    | 909        |
| 08:45 AM    | 12                    | 96   | 21   | 1    | 75                      | 147  | 39   | 3    | 38                    | 278  | 38   | 8    | 17                      | 50   | 21   | 1    | 845        |
| Total       | 61                    | 427  | 97   | 6    | 280                     | 703  | 143  | 20   | 145                   | 1177 | 196  | 25   | 72                      | 183  | 85   | 3    | 3623       |
| Grand Total | 115                   | 764  | 173  | 13   | 513                     | 1543 | 255  | 31   | 237                   | 2085 | 425  | 33   | 154                     | 311  | 114  | 13   | 6779       |
| Apprch %    | 10.8                  | 71.7 | 16.2 | 1.2  | 21.9                    | 65.9 | 10.9 | 1.3  | 8.5                   | 75   | 15.3 | 1.2  | 26                      | 52.5 | 19.3 | 2.2  |            |
| Total %     | 1.7                   | 11.3 | 2.6  | 0.2  | 7.6                     | 22.8 | 3.8  | 0.5  | 3.5                   | 30.8 | 6.3  | 0.5  | 2.3                     | 4.6  | 1.7  | 0.2  |            |

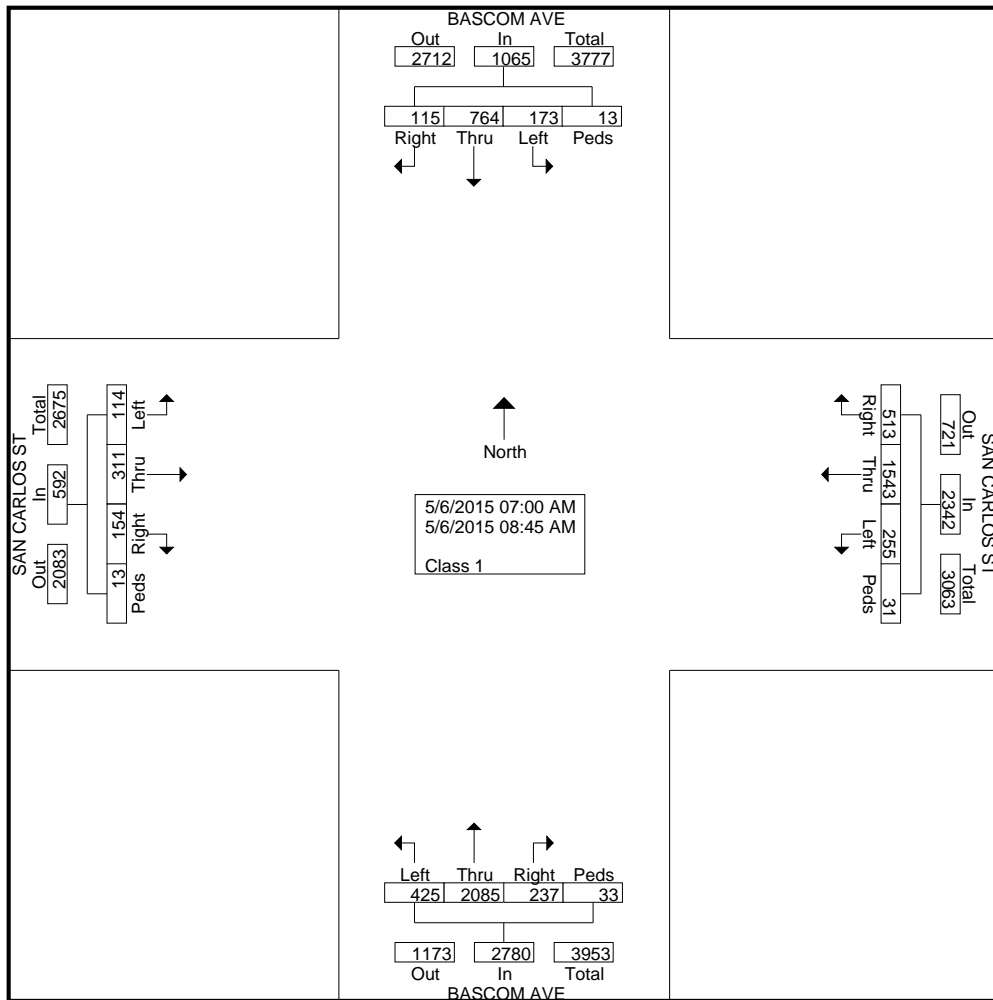

File Name : #26 BASCOM&SAN CARLOS AM  
 Site Code : 26  
 Start Date : 5/6/2015  
 Page No : 2

| Start Time  | BASCOM AVE Southbound |      |      |      |            | SAN CARLOS ST Westbound |      |      |      |            | BASCOM AVE Northbound |      |      |      |            | SAN CARLOS ST Eastbound |      |      |      |            | Int. Total |
|---|-----------------------|------|------|------|------------|-------------------------|------|------|------|------------|-----------------------|------|------|------|------------|-------------------------|------|------|------|------------|------------|
|   | Right                 | Thru | Left | Peds | App. Total | Right                   | Thru | Left | Peds | App. Total | Right                 | Thru | Left | Peds | App. Total | Right                   | Thru | Left | Peds | App. Total |            |
| <b>Peak Hour Analysis From 07:00 AM to 08:45 AM - Peak 1 of 1</b> |                       |      |      |      |            |                         |      |      |      |            |                       |      |      |      |            |                         |      |      |      |            |            |
| Peak Hour for Entire Intersection Begins at 07:45 AM              |                       |      |      |      |            |                         |      |      |      |            |                       |      |      |      |            |                         |      |      |      |            |            |
| 07:45 AM  | 13                    | 100  | 22   | 0    | 135        | 71                      | 281  | 36   | 7    | 395        | 41                    | 277  | 70   | 2    | 390        | 22                      | 45   | 11   | 0    | 78         | 998        |
| 08:00 AM  | 15                    | 121  | 24   | 1    | 161        | 68                      | 181  | 40   | 2    | 291        | 18                    | 331  | 57   | 5    | 411        | 16                      | 40   | 19   | 2    | 77         | 940        |
| 08:15 AM  | 20                    | 91   | 23   | 1    | 135        | 82                      | 212  | 40   | 7    | 341        | 40                    | 258  | 54   | 5    | 357        | 20                      | 44   | 32   | 0    | 96         | 929        |
| 08:30 AM  | 14                    | 119  | 29   | 3    | 165        | 55                      | 163  | 24   | 8    | 250        | 49                    | 310  | 47   | 7    | 413        | 19                      | 49   | 13   | 0    | 81         | 909        |
| Total Volume  | 62                    | 431  | 98   | 5    | 596        | 276                     | 837  | 140  | 24   | 1277       | 148                   | 1176 | 228  | 19   | 1571       | 77                      | 178  | 75   | 2    | 332        | 3776       |
| % App. Total  | 10.4                  | 72.3 | 16.4 | 0.8  |            | 21.6                    | 65.5 | 11   | 1.9  |            | 9.4                   | 74.9 | 14.5 | 1.2  |            | 23.2                    | 53.6 | 22.6 | 0.6  |            |            |
| PHF   | .775                  | .890 | .845 | .417 | .903       | .841                    | .745 | .875 | .750 | .808       | .755                  | .888 | .814 | .679 | .951       | .875                    | .908 | .586 | .250 | .865       | .946       |

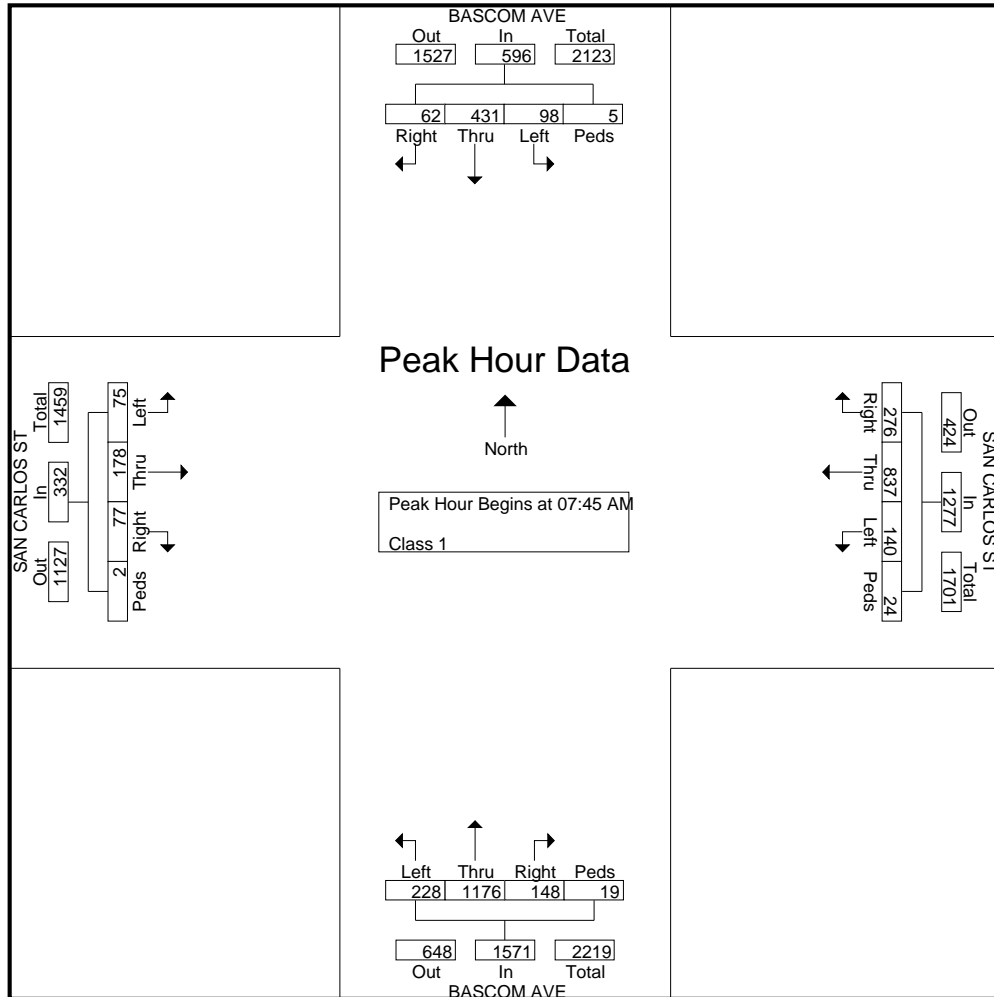

File Name : #26 BASCOM&SANCARLOSPM  
 Site Code : 26  
 Start Date : 5/5/2015  
 Page No : 1

Groups Printed- Class 1

| Start Time  | BASCOM AVE Southbound |      |      |      | SAN CARLOS ST Westbound |      |      |      | BASCOM AVE Northbound |      |      |      | SAN CARLOS ST Eastbound |      |      |      | Int. Total |
|-------------|-----------------------|------|------|------|-------------------------|------|------|------|-----------------------|------|------|------|-------------------------|------|------|------|------------|
|             | Right                 | Thru | Left | Peds | Right                   | Thru | Left | Peds | Right                 | Thru | Left | Peds | Right                   | Thru | Left | Peds |            |
| 04:00 PM    | 27                    | 217  | 64   | 4    | 30                      | 77   | 33   | 4    | 41                    | 112  | 34   | 5    | 39                      | 124  | 14   | 3    | 828        |
| 04:15 PM    | 29                    | 223  | 56   | 0    | 28                      | 96   | 33   | 9    | 37                    | 119  | 39   | 12   | 30                      | 144  | 19   | 0    | 874        |
| 04:30 PM    | 21                    | 247  | 52   | 5    | 35                      | 74   | 50   | 3    | 38                    | 123  | 42   | 4    | 46                      | 134  | 19   | 8    | 901        |
| 04:45 PM    | 26                    | 244  | 53   | 4    | 34                      | 87   | 39   | 11   | 29                    | 119  | 47   | 8    | 64                      | 152  | 25   | 1    | 943        |
| Total       | 103                   | 931  | 225  | 13   | 127                     | 334  | 155  | 27   | 145                   | 473  | 162  | 29   | 179                     | 554  | 77   | 12   | 3546       |
| 05:00 PM    | 31                    | 292  | 58   | 4    | 35                      | 79   | 38   | 2    | 48                    | 141  | 36   | 2    | 53                      | 135  | 15   | 1    | 970        |
| 05:15 PM    | 20                    | 311  | 68   | 3    | 36                      | 86   | 46   | 4    | 55                    | 126  | 26   | 11   | 56                      | 163  | 20   | 5    | 1036       |
| 05:30 PM    | 21                    | 296  | 60   | 6    | 25                      | 89   | 42   | 4    | 46                    | 130  | 31   | 1    | 40                      | 161  | 19   | 4    | 975        |
| 05:45 PM    | 17                    | 282  | 64   | 9    | 27                      | 84   | 51   | 13   | 57                    | 125  | 28   | 11   | 37                      | 141  | 20   | 5    | 971        |
| Total       | 89                    | 1181 | 250  | 22   | 123                     | 338  | 177  | 23   | 206                   | 522  | 121  | 25   | 186                     | 600  | 74   | 15   | 3952       |
| Grand Total | 192                   | 2112 | 475  | 35   | 250                     | 672  | 332  | 50   | 351                   | 995  | 283  | 54   | 365                     | 1154 | 151  | 27   | 7498       |
| Apprch %    | 6.8                   | 75.1 | 16.9 | 1.2  | 19.2                    | 51.5 | 25.5 | 3.8  | 20.9                  | 59.1 | 16.8 | 3.2  | 21.5                    | 68   | 8.9  | 1.6  |            |
| Total %     | 2.6                   | 28.2 | 6.3  | 0.5  | 3.3                     | 9    | 4.4  | 0.7  | 4.7                   | 13.3 | 3.8  | 0.7  | 4.9                     | 15.4 | 2    | 0.4  |            |

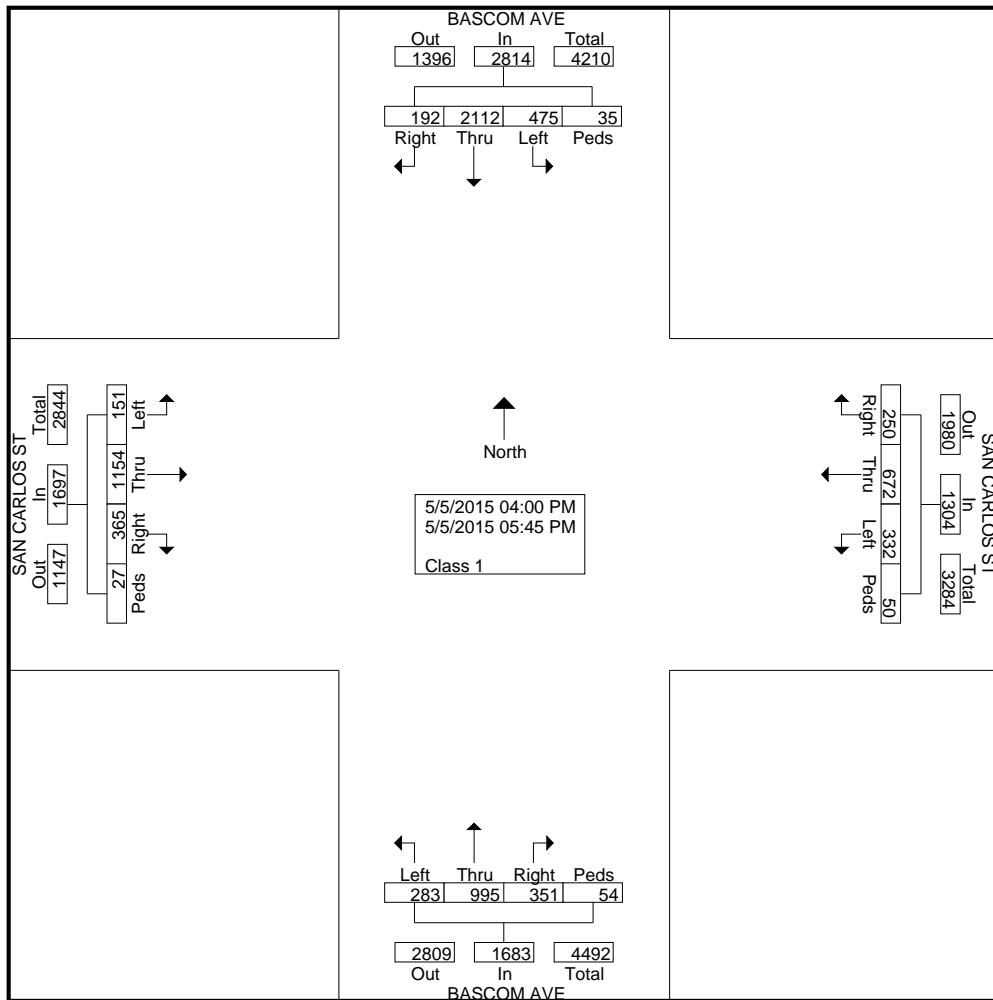

File Name : #26 BASCOM&SAN CARLOSPM  
 Site Code : 26  
 Start Date : 5/5/2015  
 Page No : 2

| Start Time  | BASCOM AVE Southbound |      |      |      |            | SAN CARLOS ST Westbound |      |      |      |            | BASCOM AVE Northbound |      |      |      |            | SAN CARLOS ST Eastbound |      |      |      |            | Int. Total |
|---|-----------------------|------|------|------|------------|-------------------------|------|------|------|------------|-----------------------|------|------|------|------------|-------------------------|------|------|------|------------|------------|
|   | Right                 | Thru | Left | Peds | App. Total | Right                   | Thru | Left | Peds | App. Total | Right                 | Thru | Left | Peds | App. Total | Right                   | Thru | Left | Peds | App. Total |            |
| <b>Peak Hour Analysis From 04:00 PM to 05:45 PM - Peak 1 of 1</b> |                       |      |      |      |            |                         |      |      |      |            |                       |      |      |      |            |                         |      |      |      |            |            |
| Peak Hour for Entire Intersection Begins at 05:00 PM              |                       |      |      |      |            |                         |      |      |      |            |                       |      |      |      |            |                         |      |      |      |            |            |
| 05:00 PM  | 31                    | 292  | 58   | 4    | 385        | 35                      | 79   | 38   | 2    | 154        | 48                    | 141  | 36   | 2    | 227        | 53                      | 135  | 15   | 1    | 204        | 970        |
| 05:15 PM  | 20                    | 311  | 68   | 3    | 402        | 36                      | 86   | 46   | 4    | 172        | 55                    | 126  | 26   | 11   | 218        | 56                      | 163  | 20   | 5    | 244        | 1036       |
| 05:30 PM  | 21                    | 296  | 60   | 6    | 383        | 25                      | 89   | 42   | 4    | 160        | 46                    | 130  | 31   | 1    | 208        | 40                      | 161  | 19   | 4    | 224        | 975        |
| 05:45 PM  | 17                    | 282  | 64   | 9    | 372        | 27                      | 84   | 51   | 13   | 175        | 57                    | 125  | 28   | 11   | 221        | 37                      | 141  | 20   | 5    | 203        | 971        |
| Total Volume  | 89                    | 1181 | 250  | 22   | 1542       | 123                     | 338  | 177  | 23   | 661        | 206                   | 522  | 121  | 25   | 874        | 186                     | 600  | 74   | 15   | 875        | 3952       |
| % App. Total  | 5.8                   | 76.6 | 16.2 | 1.4  |            | 18.6                    | 51.1 | 26.8 | 3.5  |            | 23.6                  | 59.7 | 13.8 | 2.9  |            | 21.3                    | 68.6 | 8.5  | 1.7  |            |            |
| PHF   | .718                  | .949 | .919 | .611 | .959       | .854                    | .949 | .868 | .442 | .944       | .904                  | .926 | .840 | .568 | .963       | .830                    | .920 | .925 | .750 | .897       | .954       |

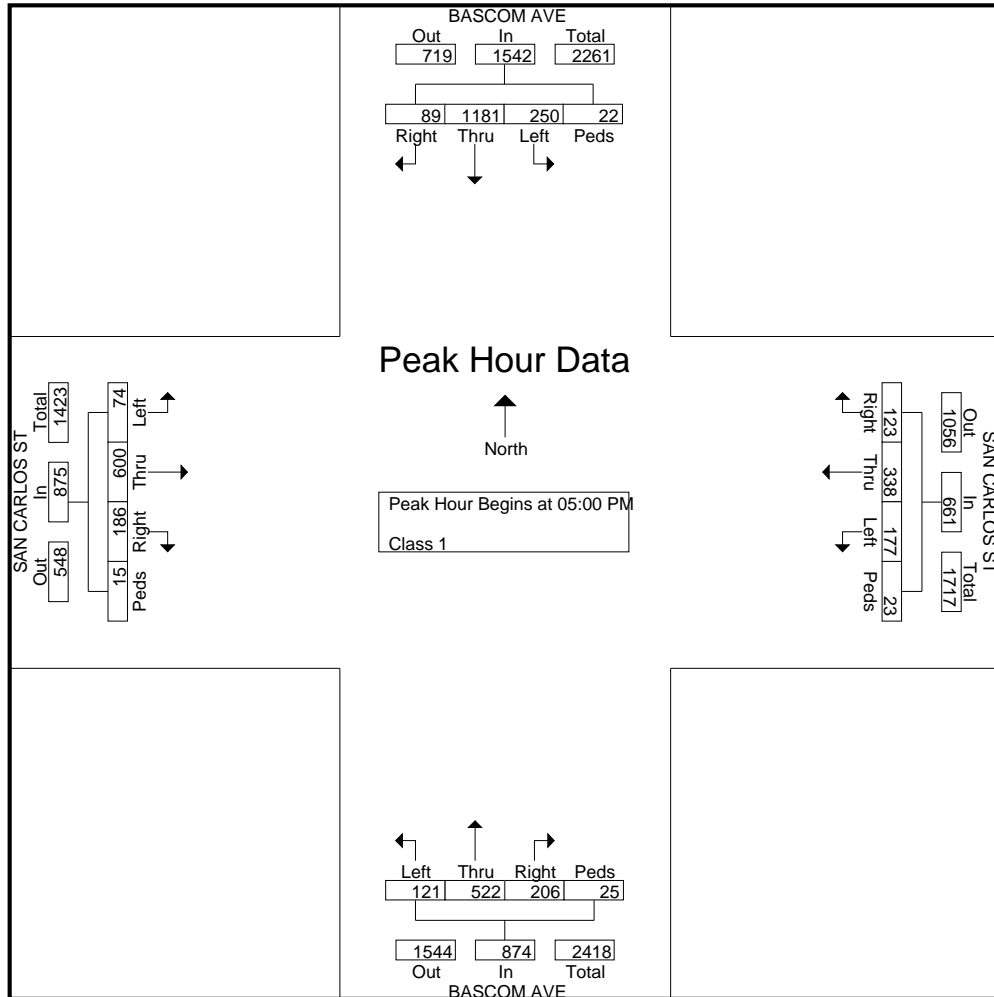

Groups Printed- Class 1

| Start Time  | I-880 SB RAMP Southbound |      |      |      | THE ALAMEDA Westbound |      |      |      | I-880 SB RAMP Northbound |      |      |      | THE ALAMEDA Eastbound |      |      |      | Int. Total |
|-------------|--------------------------|------|------|------|-----------------------|------|------|------|--------------------------|------|------|------|-----------------------|------|------|------|------------|
|             | Right                    | Thru | Left | Peds | Right                 | Thru | Left | Peds | Right                    | Thru | Left | Peds | Right                 | Thru | Left | Peds |            |
| 07:00 AM    | 63                       | 0    | 46   | 0    | 39                    | 233  | 0    | 0    | 0                        | 0    | 0    | 0    | 41                    | 113  | 0    | 0    | 535        |
| 07:15 AM    | 74                       | 0    | 53   | 1    | 68                    | 298  | 0    | 0    | 0                        | 0    | 0    | 0    | 44                    | 141  | 0    | 0    | 679        |
| 07:30 AM    | 59                       | 0    | 48   | 1    | 74                    | 294  | 0    | 0    | 0                        | 0    | 0    | 1    | 53                    | 157  | 0    | 0    | 687        |
| 07:45 AM    | 83                       | 0    | 71   | 0    | 99                    | 347  | 0    | 0    | 0                        | 0    | 0    | 0    | 34                    | 166  | 0    | 0    | 800        |
| Total       | 279                      | 0    | 218  | 2    | 280                   | 1172 | 0    | 0    | 0                        | 0    | 0    | 1    | 172                   | 577  | 0    | 0    | 2701       |
| 08:00 AM    | 70                       | 0    | 45   | 1    | 82                    | 343  | 0    | 0    | 0                        | 0    | 0    | 0    | 48                    | 161  | 0    | 0    | 750        |
| 08:15 AM    | 88                       | 0    | 36   | 1    | 53                    | 348  | 0    | 0    | 0                        | 0    | 0    | 2    | 41                    | 186  | 0    | 0    | 755        |
| 08:30 AM    | 83                       | 0    | 35   | 2    | 60                    | 294  | 0    | 0    | 0                        | 0    | 0    | 2    | 59                    | 152  | 0    | 0    | 687        |
| 08:45 AM    | 81                       | 0    | 57   | 1    | 48                    | 245  | 0    | 0    | 0                        | 0    | 0    | 2    | 30                    | 148  | 0    | 0    | 612        |
| Total       | 322                      | 0    | 173  | 5    | 243                   | 1230 | 0    | 0    | 0                        | 0    | 0    | 6    | 178                   | 647  | 0    | 0    | 2804       |
| Grand Total | 601                      | 0    | 391  | 7    | 523                   | 2402 | 0    | 0    | 0                        | 0    | 0    | 7    | 350                   | 1224 | 0    | 0    | 5505       |
| Apprch %    | 60.2                     | 0    | 39.1 | 0.7  | 17.9                  | 82.1 | 0    | 0    | 0                        | 0    | 0    | 100  | 22.2                  | 77.8 | 0    | 0    |            |
| Total %     | 10.9                     | 0    | 7.1  | 0.1  | 9.5                   | 43.6 | 0    | 0    | 0                        | 0    | 0    | 0.1  | 6.4                   | 22.2 | 0    | 0    |            |

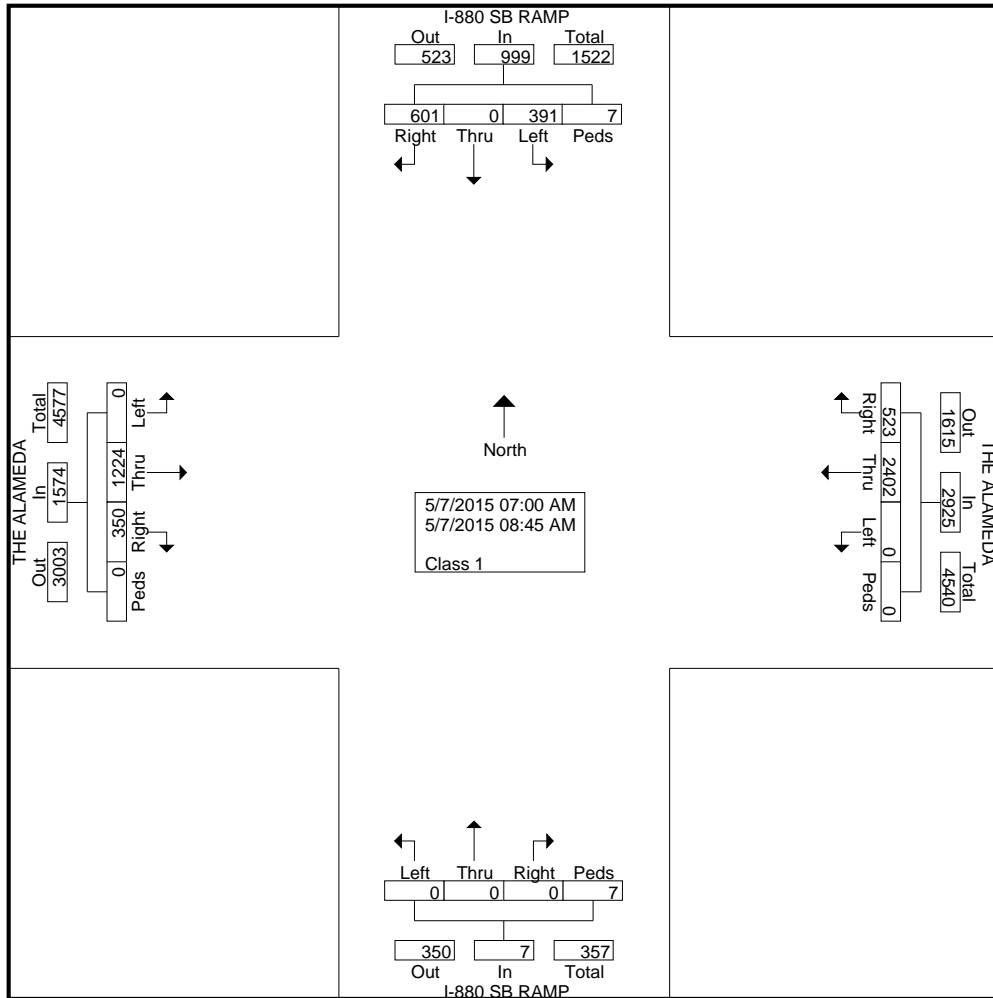

| Start Time  | I-880 SB RAMP Southbound |      |      |      |            | THE ALAMEDA Westbound |      |      |      |            | I-880 SB RAMP Northbound |      |      |      |            | THE ALAMEDA Eastbound |      |      |      |            | Int. Total |
|---|--------------------------|------|------|------|------------|-----------------------|------|------|------|------------|--------------------------|------|------|------|------------|-----------------------|------|------|------|------------|------------|
|   | Right                    | Thru | Left | Peds | App. Total | Right                 | Thru | Left | Peds | App. Total | Right                    | Thru | Left | Peds | App. Total | Right                 | Thru | Left | Peds | App. Total |            |
| <b>Peak Hour Analysis From 07:00 AM to 08:45 AM - Peak 1 of 1</b> |                          |      |      |      |            |                       |      |      |      |            |                          |      |      |      |            |                       |      |      |      |            |            |
| Peak Hour for Entire Intersection Begins at 07:30 AM              |                          |      |      |      |            |                       |      |      |      |            |                          |      |      |      |            |                       |      |      |      |            |            |
| 07:30 AM  | 59                       | 0    | 48   | 1    | 108        | 74                    | 294  | 0    | 0    | 368        | 0                        | 0    | 0    | 1    | 1          | 53                    | 157  | 0    | 0    | 210        | 687        |
| 07:45 AM  | 83                       | 0    | 71   | 0    | 154        | 99                    | 347  | 0    | 0    | 446        | 0                        | 0    | 0    | 0    | 0          | 34                    | 166  | 0    | 0    | 200        | 800        |
| 08:00 AM  | 70                       | 0    | 45   | 1    | 116        | 82                    | 343  | 0    | 0    | 425        | 0                        | 0    | 0    | 0    | 0          | 48                    | 161  | 0    | 0    | 209        | 750        |
| 08:15 AM  | 88                       | 0    | 36   | 1    | 125        | 53                    | 348  | 0    | 0    | 401        | 0                        | 0    | 0    | 2    | 2          | 41                    | 186  | 0    | 0    | 227        | 755        |
| Total Volume  | 300                      | 0    | 200  | 3    | 503        | 308                   | 1332 | 0    | 0    | 1640       | 0                        | 0    | 0    | 3    | 3          | 176                   | 670  | 0    | 0    | 846        | 2992       |
| % App. Total  | 59.6                     | 0    | 39.8 | 0.6  |            | 18.8                  | 81.2 | 0    | 0    |            | 0                        | 0    | 0    | 100  |            | 20.8                  | 79.2 | 0    | 0    |            |            |
| PHF   | .852                     | .000 | .704 | .750 | .817       | .778                  | .957 | .000 | .000 | .919       | .000                     | .000 | .000 | .375 | .375       | .830                  | .901 | .000 | .000 | .932       | .935       |

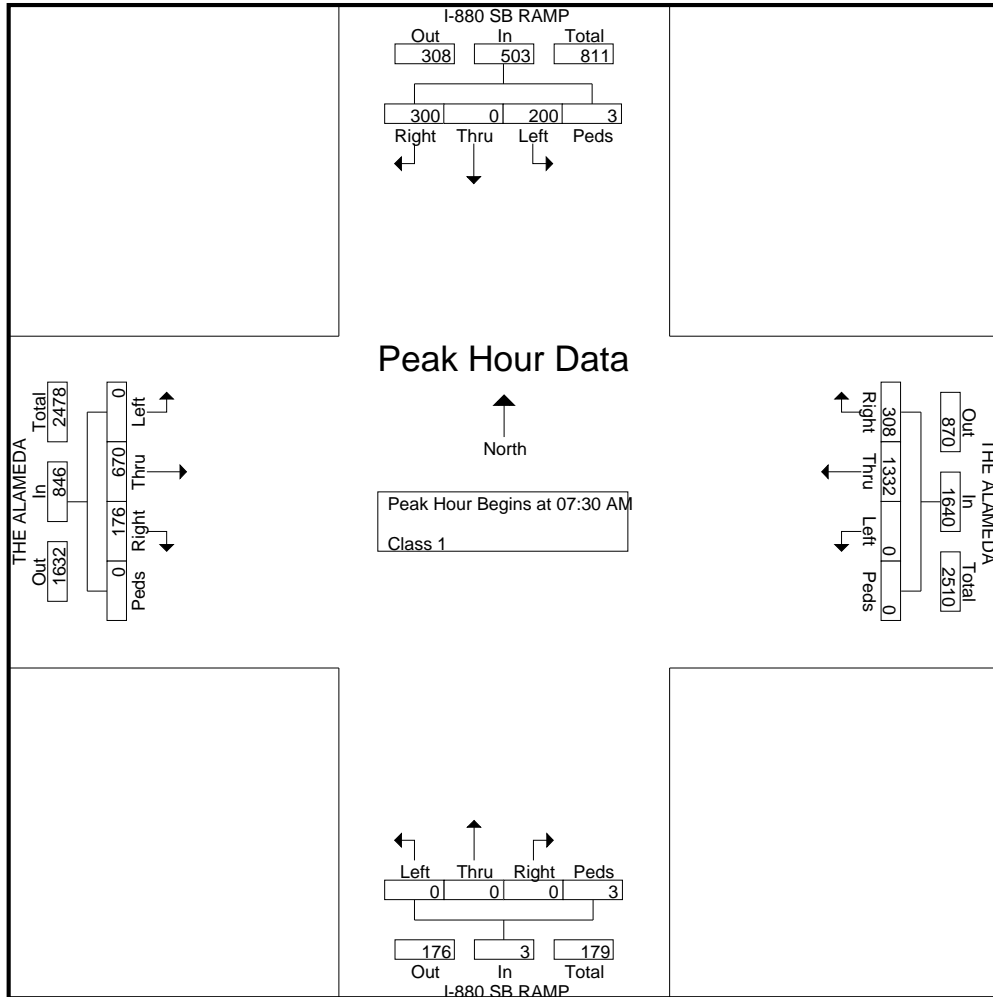



Groups Printed- Class 1

| Start Time  | I-880 NB RAMP Southbound |      |      |      | THE ALAMEDA Westbound |      |      |      | I-880 NB RAMP Northbound |      |      |      | THE ALAMEDA Eastbound |      |      |      | Int. Total |
|-------------|--------------------------|------|------|------|-----------------------|------|------|------|--------------------------|------|------|------|-----------------------|------|------|------|------------|
|             | Right                    | Thru | Left | Peds | Right                 | Thru | Left | Peds | Right                    | Thru | Left | Peds | Right                 | Thru | Left | Peds |            |
| 07:00 AM    | 0                        | 0    | 0    | 0    | 91                    | 228  | 0    | 0    | 62                       | 0    | 46   | 0    | 53                    | 104  | 0    | 0    | 584        |
| 07:15 AM    | 0                        | 0    | 0    | 0    | 111                   | 321  | 0    | 0    | 107                      | 0    | 38   | 2    | 66                    | 131  | 0    | 0    | 776        |
| 07:30 AM    | 0                        | 0    | 0    | 0    | 139                   | 322  | 0    | 0    | 105                      | 1    | 43   | 2    | 70                    | 124  | 0    | 0    | 806        |
| 07:45 AM    | 0                        | 0    | 0    | 0    | 125                   | 380  | 0    | 0    | 121                      | 0    | 66   | 1    | 50                    | 185  | 0    | 0    | 928        |
| Total       | 0                        | 0    | 0    | 0    | 466                   | 1251 | 0    | 0    | 395                      | 1    | 193  | 5    | 239                   | 544  | 0    | 0    | 3094       |
| 08:00 AM    | 0                        | 0    | 0    | 0    | 108                   | 369  | 0    | 0    | 104                      | 5    | 57   | 0    | 57                    | 148  | 0    | 0    | 848        |
| 08:15 AM    | 0                        | 0    | 0    | 2    | 97                    | 369  | 0    | 0    | 76                       | 7    | 43   | 2    | 73                    | 153  | 1    | 0    | 823        |
| 08:30 AM    | 0                        | 0    | 0    | 0    | 104                   | 307  | 0    | 0    | 55                       | 2    | 51   | 5    | 58                    | 126  | 0    | 0    | 708        |
| 08:45 AM    | 0                        | 0    | 0    | 0    | 84                    | 242  | 0    | 0    | 54                       | 4    | 61   | 1    | 40                    | 151  | 0    | 0    | 637        |
| Total       | 0                        | 0    | 0    | 2    | 393                   | 1287 | 0    | 0    | 289                      | 18   | 212  | 8    | 228                   | 578  | 1    | 0    | 3016       |
| Grand Total | 0                        | 0    | 0    | 2    | 859                   | 2538 | 0    | 0    | 684                      | 19   | 405  | 13   | 467                   | 1122 | 1    | 0    | 6110       |
| Apprch %    | 0                        | 0    | 0    | 100  | 25.3                  | 74.7 | 0    | 0    | 61                       | 1.7  | 36.1 | 1.2  | 29.4                  | 70.6 | 0.1  | 0    |            |
| Total %     | 0                        | 0    | 0    | 0    | 14.1                  | 41.5 | 0    | 0    | 11.2                     | 0.3  | 6.6  | 0.2  | 7.6                   | 18.4 | 0    | 0    |            |

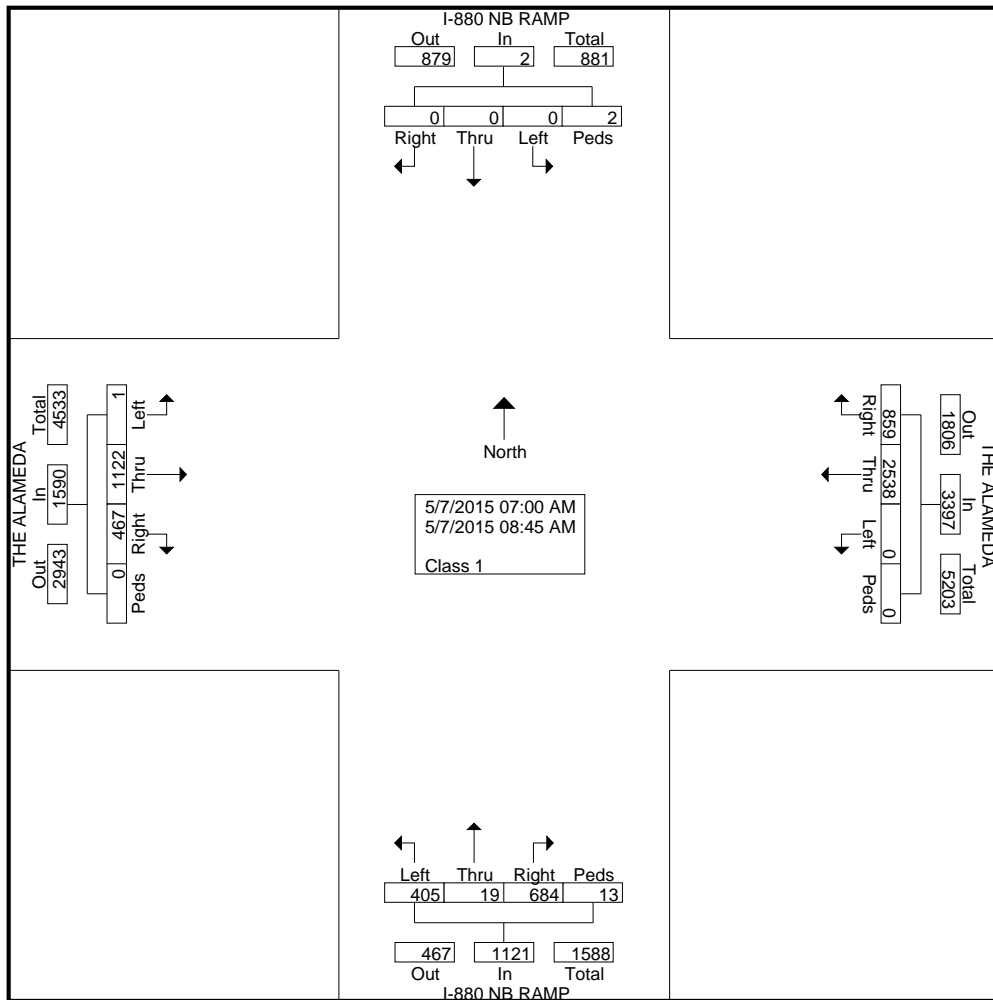

| Start Time  | I-880 NB RAMP Southbound |      |      |      |            | THE ALAMEDA Westbound |      |      |      |            | I-880 NB RAMP Northbound |      |      |      |            | THE ALAMEDA Eastbound |      |      |      |            | Int. Total |
|---|--------------------------|------|------|------|------------|-----------------------|------|------|------|------------|--------------------------|------|------|------|------------|-----------------------|------|------|------|------------|------------|
|   | Right                    | Thru | Left | Peds | App. Total | Right                 | Thru | Left | Peds | App. Total | Right                    | Thru | Left | Peds | App. Total | Right                 | Thru | Left | Peds | App. Total |            |
| <b>Peak Hour Analysis From 07:00 AM to 08:45 AM - Peak 1 of 1</b> |                          |      |      |      |            |                       |      |      |      |            |                          |      |      |      |            |                       |      |      |      |            |            |
| Peak Hour for Entire Intersection Begins at 07:30 AM              |                          |      |      |      |            |                       |      |      |      |            |                          |      |      |      |            |                       |      |      |      |            |            |
| 07:30 AM  | 0                        | 0    | 0    | 0    | 0          | 139                   | 322  | 0    | 0    | 461        | 105                      | 1    | 43   | 2    | 151        | 70                    | 124  | 0    | 0    | 194        | 806        |
| 07:45 AM  | 0                        | 0    | 0    | 0    | 0          | 125                   | 380  | 0    | 0    | 505        | 121                      | 0    | 66   | 1    | 188        | 50                    | 185  | 0    | 0    | 235        | 928        |
| 08:00 AM  | 0                        | 0    | 0    | 0    | 0          | 108                   | 369  | 0    | 0    | 477        | 104                      | 5    | 57   | 0    | 166        | 57                    | 148  | 0    | 0    | 205        | 848        |
| 08:15 AM  | 0                        | 0    | 0    | 2    | 2          | 97                    | 369  | 0    | 0    | 466        | 76                       | 7    | 43   | 2    | 128        | 73                    | 153  | 1    | 0    | 227        | 823        |
| Total Volume  | 0                        | 0    | 0    | 2    | 2          | 469                   | 1440 | 0    | 0    | 1909       | 406                      | 13   | 209  | 5    | 633        | 250                   | 610  | 1    | 0    | 861        | 3405       |
| % App. Total  | 0                        | 0    | 0    | 100  |            | 24.6                  | 75.4 | 0    | 0    |            | 64.1                     | 2.1  | 33   | 0.8  |            | 29                    | 70.8 | 0.1  | 0    |            |            |
| PHF   | .000                     | .000 | .000 | .250 | .250       | .844                  | .947 | .000 | .000 | .945       | .839                     | .464 | .792 | .625 | .842       | .856                  | .824 | .250 | .000 | .916       | .917       |

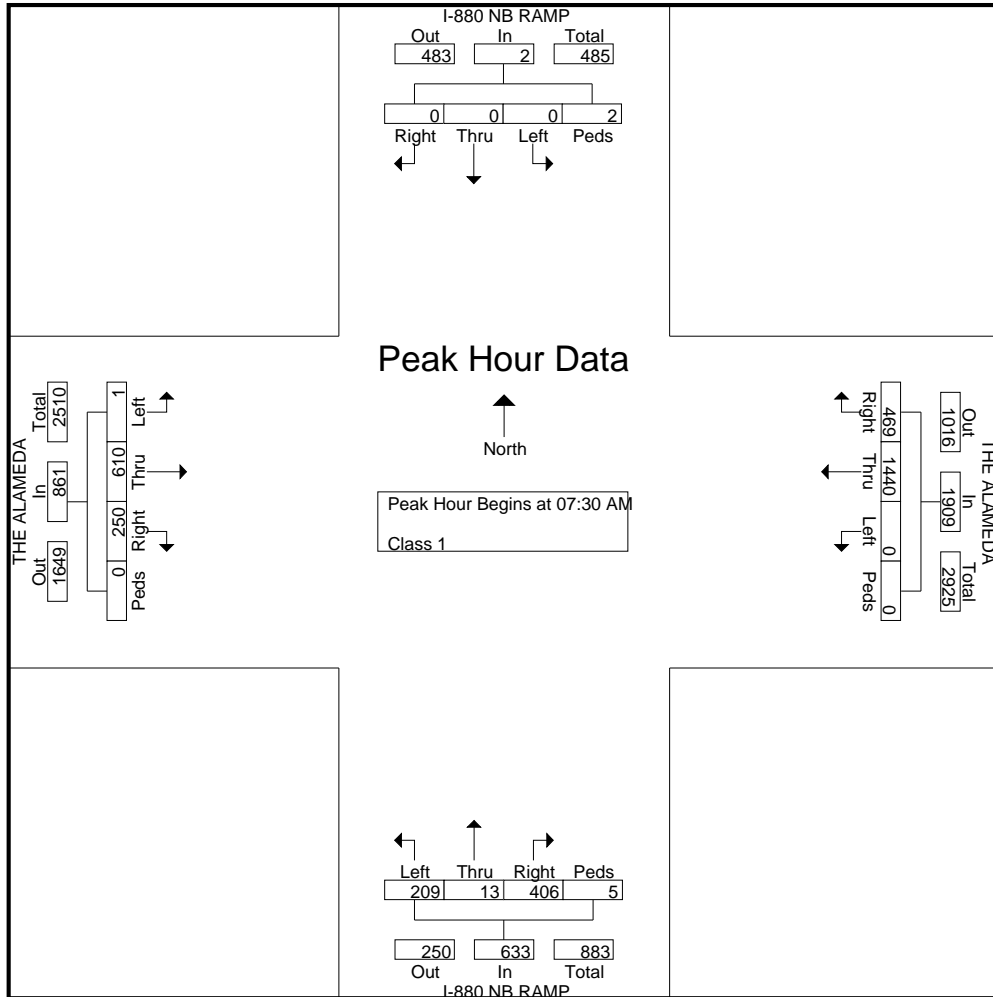

Groups Printed- Class 1

| Start Time  | LINCOLN AVE Southbound |      |      |      | W SAN CARLOS ST Westbound |      |      |      | LINCOLN AVE Northbound |      |      |      | W SAN CARLOS ST Eastbound |      |      |      | Int. Total |
|-------------|------------------------|------|------|------|---------------------------|------|------|------|------------------------|------|------|------|---------------------------|------|------|------|------------|
|             | Right                  | Thru | Left | Peds | Right                     | Thru | Left | Peds | Right                  | Thru | Left | Peds | Right                     | Thru | Left | Peds |            |
| 07:00 AM    | 4                      | 3    | 4    | 0    | 5                         | 139  | 12   | 0    | 14                     | 29   | 68   | 0    | 13                        | 65   | 1    | 0    | 357        |
| 07:15 AM    | 4                      | 7    | 4    | 2    | 0                         | 177  | 10   | 1    | 41                     | 36   | 107  | 1    | 20                        | 81   | 2    | 0    | 493        |
| 07:30 AM    | 7                      | 13   | 5    | 1    | 1                         | 181  | 16   | 0    | 32                     | 45   | 71   | 0    | 23                        | 99   | 2    | 0    | 496        |
| 07:45 AM    | 11                     | 14   | 3    | 1    | 4                         | 154  | 14   | 0    | 47                     | 42   | 82   | 2    | 25                        | 109  | 0    | 0    | 508        |
| Total       | 26                     | 37   | 16   | 4    | 10                        | 651  | 52   | 1    | 134                    | 152  | 328  | 3    | 81                        | 354  | 5    | 0    | 1854       |
| 08:00 AM    | 7                      | 11   | 1    | 1    | 0                         | 148  | 8    | 1    | 47                     | 36   | 88   | 0    | 14                        | 93   | 2    | 0    | 457        |
| 08:15 AM    | 4                      | 16   | 5    | 0    | 0                         | 116  | 4    | 2    | 32                     | 40   | 78   | 0    | 20                        | 98   | 5    | 0    | 420        |
| 08:30 AM    | 2                      | 13   | 1    | 3    | 1                         | 142  | 4    | 7    | 27                     | 44   | 76   | 1    | 23                        | 125  | 3    | 0    | 472        |
| 08:45 AM    | 7                      | 14   | 3    | 2    | 1                         | 108  | 10   | 5    | 29                     | 33   | 53   | 2    | 23                        | 128  | 7    | 0    | 425        |
| Total       | 20                     | 54   | 10   | 6    | 2                         | 514  | 26   | 15   | 135                    | 153  | 295  | 3    | 80                        | 444  | 17   | 0    | 1774       |
| Grand Total | 46                     | 91   | 26   | 10   | 12                        | 1165 | 78   | 16   | 269                    | 305  | 623  | 6    | 161                       | 798  | 22   | 0    | 3628       |
| Apprch %    | 26.6                   | 52.6 | 15   | 5.8  | 0.9                       | 91.7 | 6.1  | 1.3  | 22.4                   | 25.4 | 51.8 | 0.5  | 16.4                      | 81.3 | 2.2  | 0    |            |
| Total %     | 1.3                    | 2.5  | 0.7  | 0.3  | 0.3                       | 32.1 | 2.1  | 0.4  | 7.4                    | 8.4  | 17.2 | 0.2  | 4.4                       | 22   | 0.6  | 0    |            |

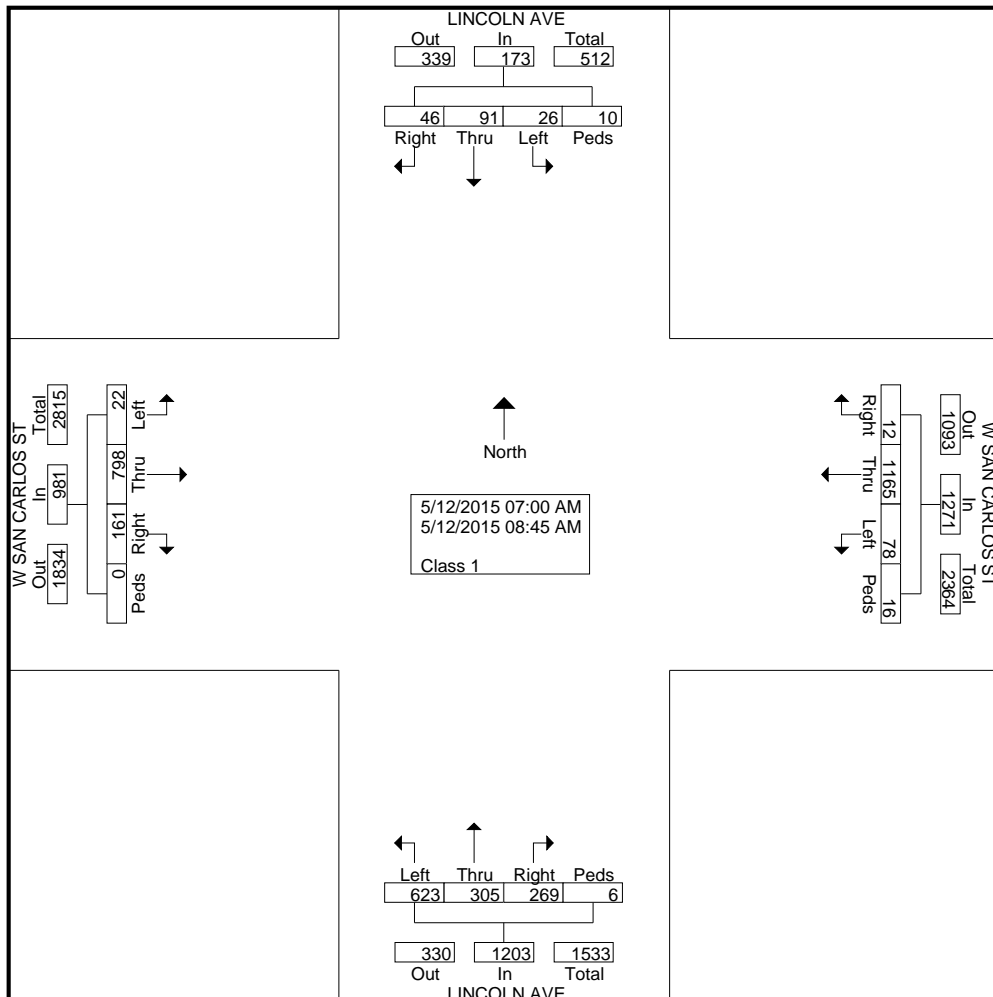

File Name : #37 LINCOLN&SAN CARLOS AM  
 Site Code :  
 Start Date : 5/12/2015  
 Page No : 2

| Start Time  | LINCOLN AVE Southbound |      |      |      |            | W SAN CARLOS ST Westbound |      |      |      |            | LINCOLN AVE Northbound |      |      |      |            | W SAN CARLOS ST Eastbound |      |      |      |            | Int. Total |
|---|------------------------|------|------|------|------------|---------------------------|------|------|------|------------|------------------------|------|------|------|------------|---------------------------|------|------|------|------------|------------|
|   | Right                  | Thru | Left | Peds | App. Total | Right                     | Thru | Left | Peds | App. Total | Right                  | Thru | Left | Peds | App. Total | Right                     | Thru | Left | Peds | App. Total |            |
| <b>Peak Hour Analysis From 07:00 AM to 08:45 AM - Peak 1 of 1</b> |                        |      |      |      |            |                           |      |      |      |            |                        |      |      |      |            |                           |      |      |      |            |            |
| Peak Hour for Entire Intersection Begins at 07:15 AM              |                        |      |      |      |            |                           |      |      |      |            |                        |      |      |      |            |                           |      |      |      |            |            |
| 07:15 AM  | 4                      | 7    | 4    | 2    | 17         | 0                         | 177  | 10   | 1    | 188        | 41                     | 36   | 107  | 1    | 185        | 20                        | 81   | 2    | 0    | 103        | 493        |
| 07:30 AM  | 7                      | 13   | 5    | 1    | 26         | 1                         | 181  | 16   | 0    | 198        | 32                     | 45   | 71   | 0    | 148        | 23                        | 99   | 2    | 0    | 124        | 496        |
| 07:45 AM  | 11                     | 14   | 3    | 1    | 29         | 4                         | 154  | 14   | 0    | 172        | 47                     | 42   | 82   | 2    | 173        | 25                        | 109  | 0    | 0    | 134        | 508        |
| 08:00 AM  | 7                      | 11   | 1    | 1    | 20         | 0                         | 148  | 8    | 1    | 157        | 47                     | 36   | 88   | 0    | 171        | 14                        | 93   | 2    | 0    | 109        | 457        |
| Total Volume  | 29                     | 45   | 13   | 5    | 92         | 5                         | 660  | 48   | 2    | 715        | 167                    | 159  | 348  | 3    | 677        | 82                        | 382  | 6    | 0    | 470        | 1954       |
| % App. Total  | 31.5                   | 48.9 | 14.1 | 5.4  |            | 0.7                       | 92.3 | 6.7  | 0.3  |            | 24.7                   | 23.5 | 51.4 | 0.4  |            | 17.4                      | 81.3 | 1.3  | 0    |            |            |
| PHF   | .659                   | .804 | .650 | .625 | .793       | .313                      | .912 | .750 | .500 | .903       | .888                   | .883 | .813 | .375 | .915       | .820                      | .876 | .750 | .000 | .877       | .962       |

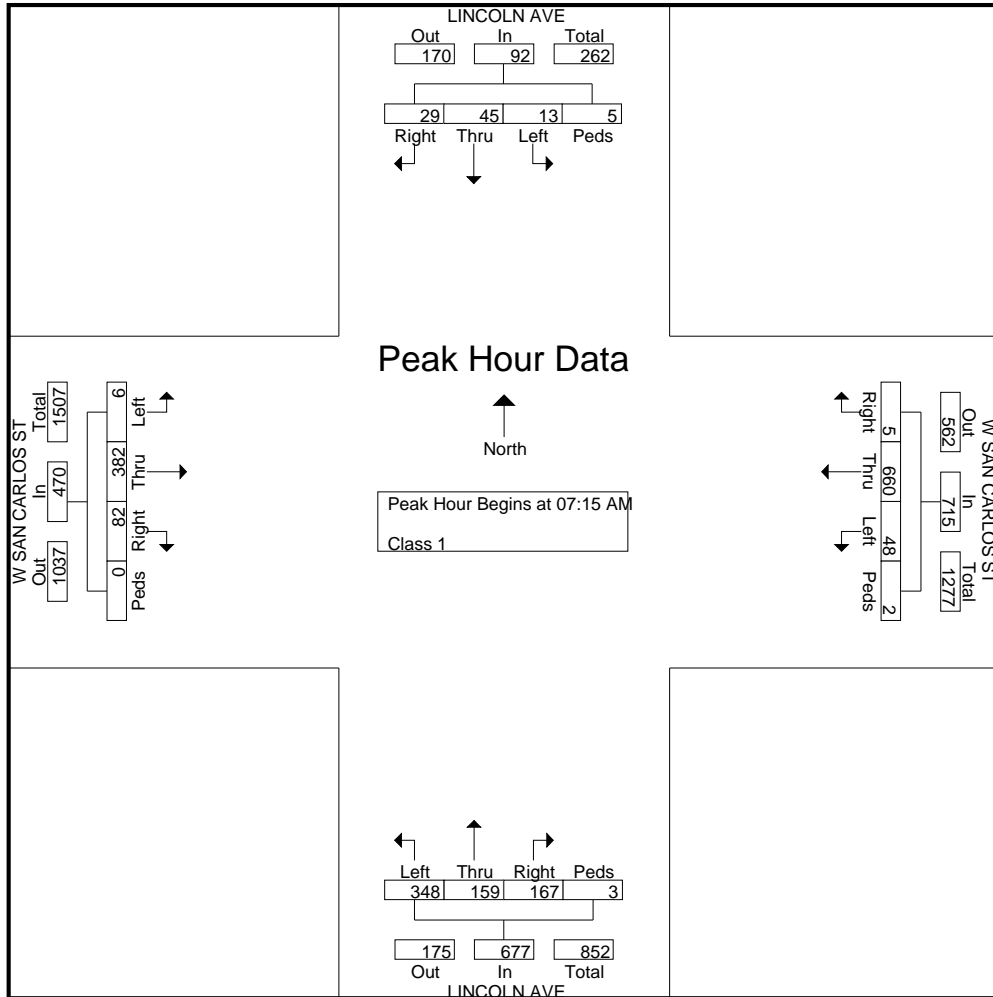

File Name : #37 LINCOLN&SAN CARLOSPM  
 Site Code :  
 Start Date : 5/12/2015  
 Page No : 1

Groups Printed- Class 1

| Start Time  | LINCOLN AVE Southbound |      |      |      | W SAN CARLOS ST Westbound |      |      |      | LINCOLN AVE Northbound |      |      |      | W SAN CARLOS ST Eastbound |      |      |      | Int. Total |
|-------------|------------------------|------|------|------|---------------------------|------|------|------|------------------------|------|------|------|---------------------------|------|------|------|------------|
|             | Right                  | Thru | Left | Peds | Right                     | Thru | Left | Peds | Right                  | Thru | Left | Peds | Right                     | Thru | Left | Peds |            |
| 04:00 PM    | 5                      | 28   | 5    | 2    | 4                         | 78   | 13   | 2    | 19                     | 18   | 22   | 3    | 48                        | 186  | 4    | 0    | 437        |
| 04:15 PM    | 10                     | 32   | 1    | 0    | 6                         | 97   | 15   | 2    | 11                     | 11   | 19   | 3    | 36                        | 203  | 7    | 0    | 453        |
| 04:30 PM    | 11                     | 38   | 5    | 4    | 8                         | 94   | 12   | 4    | 31                     | 13   | 21   | 2    | 54                        | 192  | 12   | 0    | 501        |
| 04:45 PM    | 5                      | 39   | 4    | 2    | 1                         | 112  | 8    | 2    | 18                     | 8    | 22   | 1    | 50                        | 205  | 4    | 0    | 481        |
| Total       | 31                     | 137  | 15   | 8    | 19                        | 381  | 48   | 10   | 79                     | 50   | 84   | 9    | 188                       | 786  | 27   | 0    | 1872       |
| 05:00 PM    | 7                      | 36   | 3    | 1    | 4                         | 102  | 19   | 2    | 33                     | 8    | 30   | 2    | 61                        | 217  | 1    | 0    | 526        |
| 05:15 PM    | 4                      | 43   | 1    | 0    | 4                         | 134  | 23   | 3    | 15                     | 17   | 17   | 3    | 52                        | 243  | 11   | 0    | 570        |
| 05:30 PM    | 6                      | 51   | 3    | 2    | 5                         | 94   | 23   | 2    | 27                     | 9    | 35   | 1    | 55                        | 244  | 10   | 0    | 567        |
| 05:45 PM    | 3                      | 41   | 10   | 4    | 1                         | 121  | 23   | 0    | 24                     | 13   | 22   | 4    | 59                        | 207  | 11   | 0    | 543        |
| Total       | 20                     | 171  | 17   | 7    | 14                        | 451  | 88   | 7    | 99                     | 47   | 104  | 10   | 227                       | 911  | 33   | 0    | 2206       |
| Grand Total | 51                     | 308  | 32   | 15   | 33                        | 832  | 136  | 17   | 178                    | 97   | 188  | 19   | 415                       | 1697 | 60   | 0    | 4078       |
| Apprch %    | 12.6                   | 75.9 | 7.9  | 3.7  | 3.2                       | 81.7 | 13.4 | 1.7  | 36.9                   | 20.1 | 39   | 3.9  | 19.1                      | 78.1 | 2.8  | 0    |            |
| Total %     | 1.3                    | 7.6  | 0.8  | 0.4  | 0.8                       | 20.4 | 3.3  | 0.4  | 4.4                    | 2.4  | 4.6  | 0.5  | 10.2                      | 41.6 | 1.5  | 0    |            |

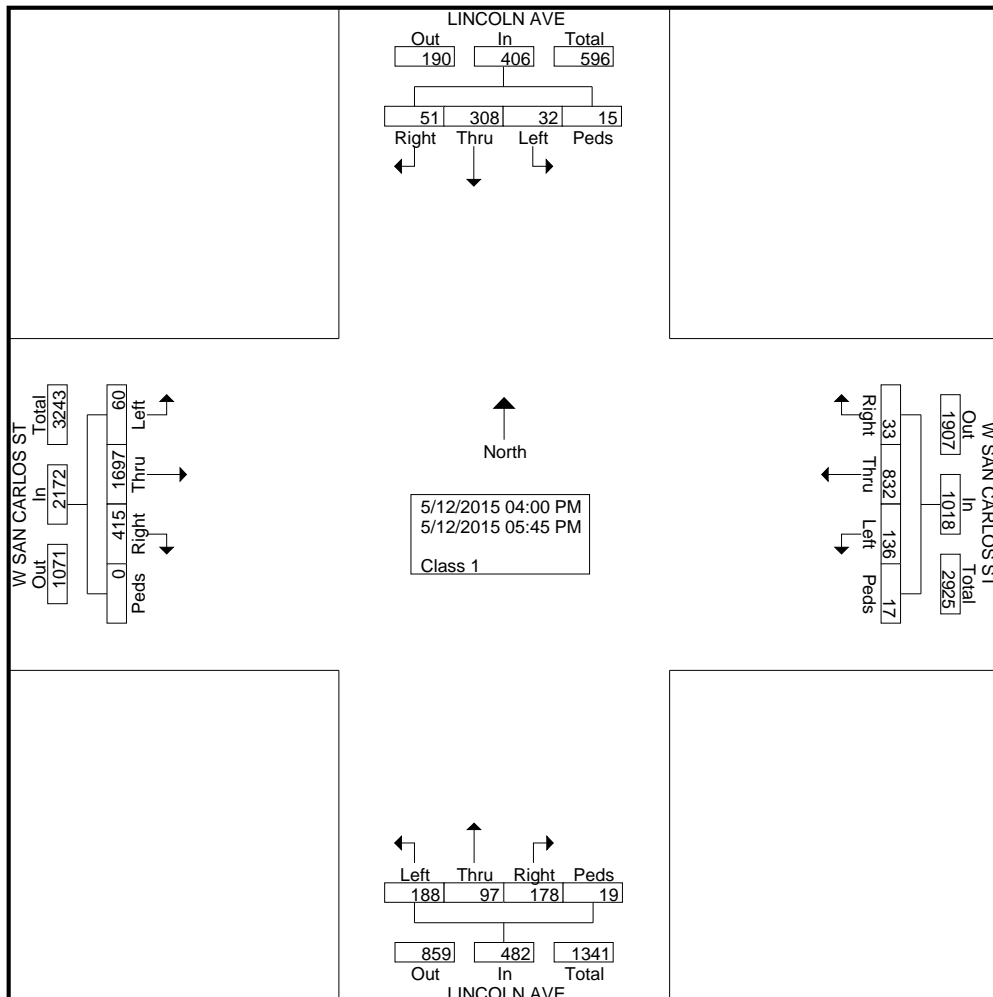

File Name : #37 LINCOLN&SAN CARLOSPM  
 Site Code :  
 Start Date : 5/12/2015  
 Page No : 2

| Start Time  | LINCOLN AVE Southbound |      |      |      |            | W SAN CARLOS ST Westbound |      |      |      |            | LINCOLN AVE Northbound |      |      |      |            | W SAN CARLOS ST Eastbound |      |      |      |            | Int. Total |
|---|------------------------|------|------|------|------------|---------------------------|------|------|------|------------|------------------------|------|------|------|------------|---------------------------|------|------|------|------------|------------|
|   | Right                  | Thru | Left | Peds | App. Total | Right                     | Thru | Left | Peds | App. Total | Right                  | Thru | Left | Peds | App. Total | Right                     | Thru | Left | Peds | App. Total |            |
| <b>Peak Hour Analysis From 04:00 PM to 05:45 PM - Peak 1 of 1</b> |                        |      |      |      |            |                           |      |      |      |            |                        |      |      |      |            |                           |      |      |      |            |            |
| Peak Hour for Entire Intersection Begins at 05:00 PM              |                        |      |      |      |            |                           |      |      |      |            |                        |      |      |      |            |                           |      |      |      |            |            |
| 05:00 PM  | 7                      | 36   | 3    | 1    | 47         | 4                         | 102  | 19   | 2    | 127        | 33                     | 8    | 30   | 2    | 73         | 61                        | 217  | 1    | 0    | 279        | 526        |
| 05:15 PM  | 4                      | 43   | 1    | 0    | 48         | 4                         | 134  | 23   | 3    | 164        | 15                     | 17   | 17   | 3    | 52         | 52                        | 243  | 11   | 0    | 306        | 570        |
| 05:30 PM  | 6                      | 51   | 3    | 2    | 62         | 5                         | 94   | 23   | 2    | 124        | 27                     | 9    | 35   | 1    | 72         | 55                        | 244  | 10   | 0    | 309        | 567        |
| 05:45 PM  | 3                      | 41   | 10   | 4    | 58         | 1                         | 121  | 23   | 0    | 145        | 24                     | 13   | 22   | 4    | 63         | 59                        | 207  | 11   | 0    | 277        | 543        |
| Total Volume  | 20                     | 171  | 17   | 7    | 215        | 14                        | 451  | 88   | 7    | 560        | 99                     | 47   | 104  | 10   | 260        | 227                       | 911  | 33   | 0    | 1171       | 2206       |
| % App. Total  | 9.3                    | 79.5 | 7.9  | 3.3  |            | 2.5                       | 80.5 | 15.7 | 1.2  |            | 38.1                   | 18.1 | 40   | 3.8  |            | 19.4                      | 77.8 | 2.8  | 0    |            |            |
| PHF   | .714                   | .838 | .425 | .438 | .867       | .700                      | .841 | .957 | .583 | .854       | .750                   | .691 | .743 | .625 | .890       | .930                      | .933 | .750 | .000 | .947       | .968       |

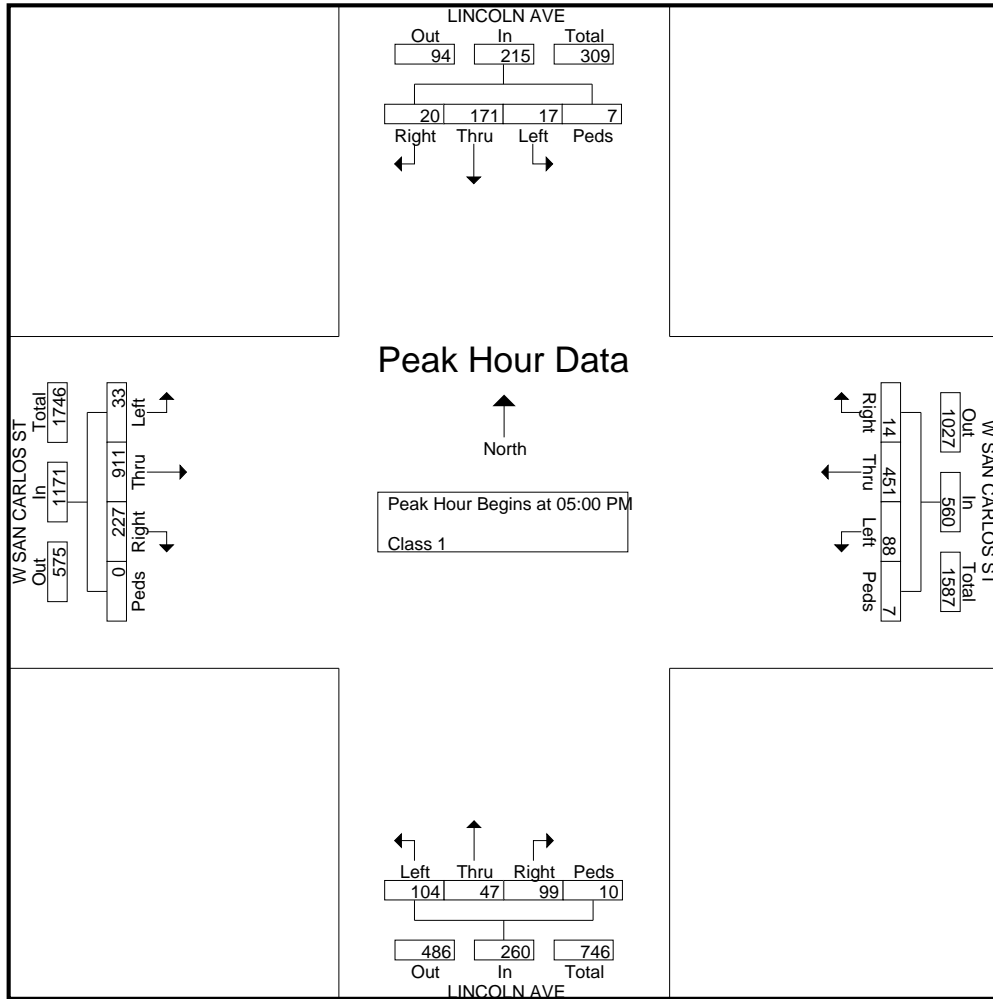

Groups Printed- Class 1

| Start Time  | I-880 NB RAMP Southbound |      |      |      | COLEMAN AVE Westbound |      |      |      | MCKENDRIE ST Northbound |      |      |      | COLEMAN AVE Eastbound |      |      |      | Int. Total |
|-------------|--------------------------|------|------|------|-----------------------|------|------|------|-------------------------|------|------|------|-----------------------|------|------|------|------------|
|             | Right                    | Thru | Left | Peds | Right                 | Thru | Left | Peds | Right                   | Thru | Left | Peds | Right                 | Thru | Left | Peds |            |
| 07:00 AM    | 235                      | 0    | 18   | 0    | 59                    | 373  | 0    | 0    | 4                       | 0    | 0    | 0    | 7                     | 127  | 37   | 0    | 860        |
| 07:15 AM    | 232                      | 0    | 31   | 0    | 67                    | 470  | 0    | 0    | 5                       | 0    | 0    | 0    | 10                    | 135  | 39   | 0    | 989        |
| 07:30 AM    | 227                      | 0    | 40   | 0    | 75                    | 515  | 0    | 0    | 1                       | 0    | 0    | 0    | 2                     | 154  | 38   | 0    | 1052       |
| 07:45 AM    | 241                      | 0    | 31   | 0    | 81                    | 568  | 0    | 0    | 3                       | 0    | 0    | 1    | 7                     | 194  | 38   | 0    | 1164       |
| Total       | 935                      | 0    | 120  | 0    | 282                   | 1926 | 0    | 0    | 13                      | 0    | 0    | 1    | 26                    | 610  | 152  | 0    | 4065       |
| 08:00 AM    | 280                      | 0    | 45   | 0    | 97                    | 516  | 0    | 0    | 4                       | 0    | 0    | 0    | 8                     | 161  | 38   | 0    | 1149       |
| 08:15 AM    | 272                      | 0    | 34   | 0    | 90                    | 541  | 0    | 0    | 2                       | 0    | 0    | 1    | 8                     | 167  | 57   | 0    | 1172       |
| 08:30 AM    | 288                      | 0    | 36   | 0    | 66                    | 540  | 0    | 0    | 4                       | 0    | 0    | 0    | 6                     | 170  | 44   | 0    | 1154       |
| 08:45 AM    | 279                      | 0    | 38   | 0    | 87                    | 504  | 0    | 0    | 2                       | 0    | 0    | 6    | 2                     | 152  | 50   | 0    | 1120       |
| Total       | 1119                     | 0    | 153  | 0    | 340                   | 2101 | 0    | 0    | 12                      | 0    | 0    | 7    | 24                    | 650  | 189  | 0    | 4595       |
| Grand Total | 2054                     | 0    | 273  | 0    | 622                   | 4027 | 0    | 0    | 25                      | 0    | 0    | 8    | 50                    | 1260 | 341  | 0    | 8660       |
| Apprch %    | 88.3                     | 0    | 11.7 | 0    | 13.4                  | 86.6 | 0    | 0    | 75.8                    | 0    | 0    | 24.2 | 3                     | 76.3 | 20.7 | 0    |            |
| Total %     | 23.7                     | 0    | 3.2  | 0    | 7.2                   | 46.5 | 0    | 0    | 0.3                     | 0    | 0    | 0.1  | 0.6                   | 14.5 | 3.9  | 0    |            |

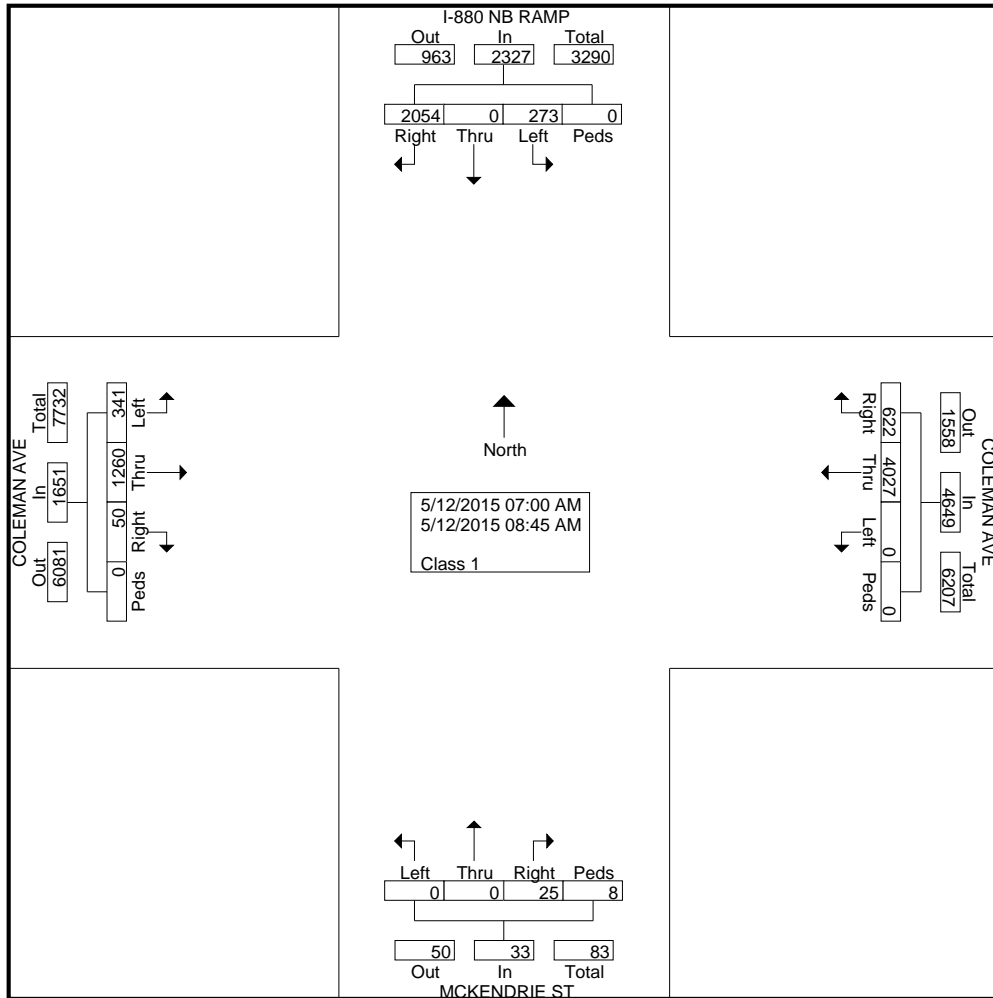

| Start Time  | I-880 NB RAMP Southbound |      |           |      |            | COLEMAN AVE Westbound |            |      |      |            | MCKENDRIE ST Northbound |      |      |          |            | COLEMAN AVE Eastbound |            |           |      |            | Int. Total  |
|---|--------------------------|------|-----------|------|------------|-----------------------|------------|------|------|------------|-------------------------|------|------|----------|------------|-----------------------|------------|-----------|------|------------|-------------|
|   | Right                    | Thru | Left      | Peds | App. Total | Right                 | Thru       | Left | Peds | App. Total | Right                   | Thru | Left | Peds     | App. Total | Right                 | Thru       | Left      | Peds | App. Total |             |
| <b>Peak Hour Analysis From 07:00 AM to 08:45 AM - Peak 1 of 1</b> |                          |      |           |      |            |                       |            |      |      |            |                         |      |      |          |            |                       |            |           |      |            |             |
| Peak Hour for Entire Intersection Begins at 07:45 AM              |                          |      |           |      |            |                       |            |      |      |            |                         |      |      |          |            |                       |            |           |      |            |             |
| 07:45 AM  | 241                      | 0    | 31        | 0    | 272        | 81                    | <b>568</b> | 0    | 0    | <b>649</b> | 3                       | 0    | 0    | <b>1</b> | <b>4</b>   | 7                     | <b>194</b> | 38        | 0    | <b>239</b> | 1164        |
| 08:00 AM  | 280                      | 0    | <b>45</b> | 0    | <b>325</b> | <b>97</b>             | 516        | 0    | 0    | 613        | <b>4</b>                | 0    | 0    | 0        | 4          | <b>8</b>              | 161        | 38        | 0    | 207        | 1149        |
| 08:15 AM  | 272                      | 0    | 34        | 0    | 306        | 90                    | 541        | 0    | 0    | 631        | 2                       | 0    | 0    | 1        | 3          | 8                     | 167        | <b>57</b> | 0    | 232        | <b>1172</b> |
| 08:30 AM  | <b>288</b>               | 0    | 36        | 0    | 324        | 66                    | 540        | 0    | 0    | 606        | 4                       | 0    | 0    | 0        | 4          | 6                     | 170        | 44        | 0    | 220        | 1154        |
| Total Volume  | 1081                     | 0    | 146       | 0    | 1227       | 334                   | 2165       | 0    | 0    | 2499       | 13                      | 0    | 0    | 2        | 15         | 29                    | 692        | 177       | 0    | 898        | 4639        |
| % App. Total  | 88.1                     | 0    | 11.9      | 0    |            | 13.4                  | 86.6       | 0    | 0    |            | 86.7                    | 0    | 0    | 13.3     |            | 3.2                   | 77.1       | 19.7      | 0    |            |             |
| PHF   | .938                     | .000 | .811      | .000 | .944       | .861                  | .953       | .000 | .000 | .963       | .813                    | .000 | .000 | .500     | .938       | .906                  | .892       | .776      | .000 | .939       | .990        |

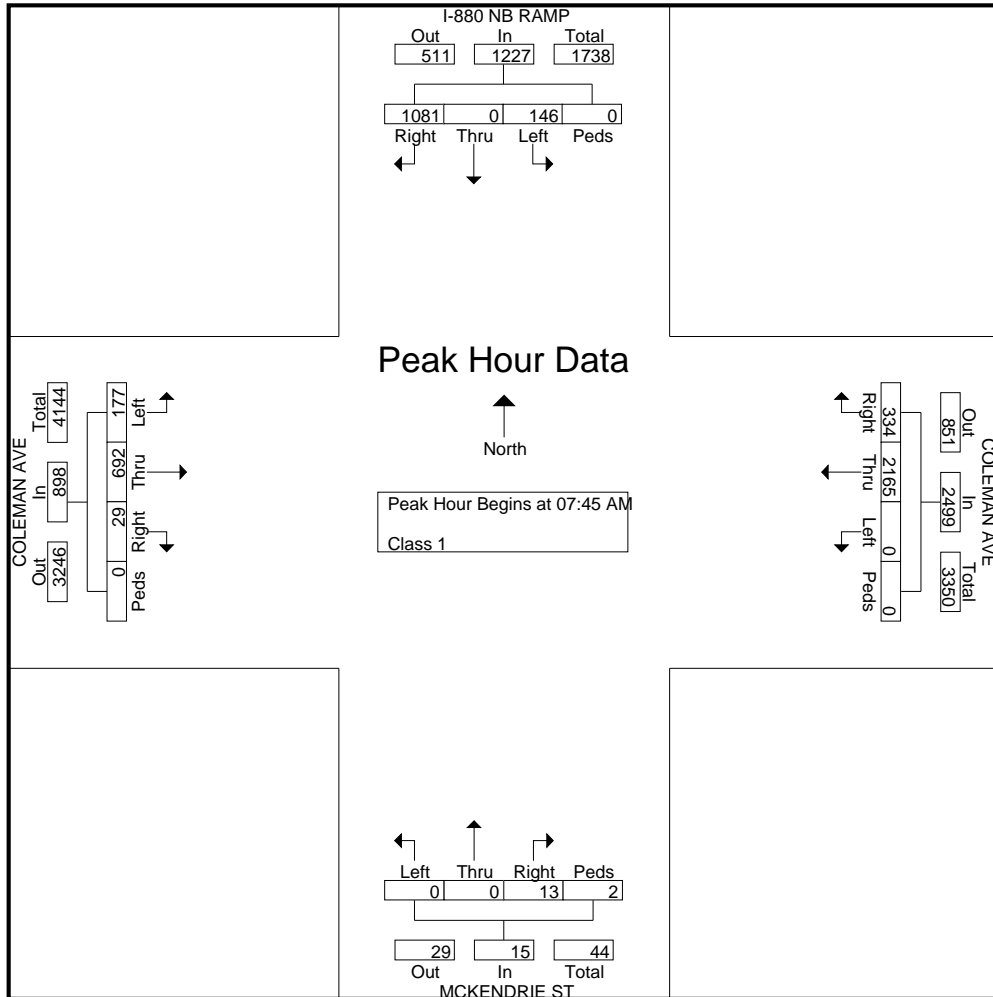



Groups Printed- Class 1

| Start Time  | I-880 SB RAMP Southbound |      |      |      | COLEMAN AVE Westbound |      |      |      | Northbound |      |      |      | COLEMAN AVE Eastbound |      |      |      | Int. Total |
|-------------|--------------------------|------|------|------|-----------------------|------|------|------|------------|------|------|------|-----------------------|------|------|------|------------|
|             | Right                    | Thru | Left | Peds | Right                 | Thru | Left | Peds | Right      | Thru | Left | Peds | Right                 | Thru | Left | Peds |            |
| 07:00 AM    | 95                       | 0    | 96   | 0    | 31                    | 577  | 0    | 0    | 0          | 0    | 0    | 0    | 34                    | 93   | 0    | 0    | 926        |
| 07:15 AM    | 101                      | 0    | 69   | 0    | 54                    | 680  | 0    | 0    | 0          | 0    | 0    | 0    | 31                    | 113  | 0    | 0    | 1048       |
| 07:30 AM    | 120                      | 0    | 100  | 0    | 48                    | 709  | 0    | 0    | 0          | 0    | 0    | 0    | 44                    | 109  | 0    | 0    | 1130       |
| 07:45 AM    | 80                       | 0    | 105  | 0    | 51                    | 759  | 0    | 0    | 0          | 0    | 0    | 0    | 38                    | 142  | 0    | 0    | 1175       |
| Total       | 396                      | 0    | 370  | 0    | 184                   | 2725 | 0    | 0    | 0          | 0    | 0    | 0    | 147                   | 457  | 0    | 0    | 4279       |
| 08:00 AM    | 104                      | 0    | 102  | 0    | 44                    | 751  | 0    | 0    | 0          | 0    | 0    | 0    | 39                    | 120  | 0    | 0    | 1160       |
| 08:15 AM    | 117                      | 0    | 69   | 0    | 37                    | 781  | 0    | 0    | 0          | 0    | 0    | 0    | 41                    | 155  | 0    | 0    | 1200       |
| 08:30 AM    | 123                      | 0    | 69   | 0    | 52                    | 812  | 0    | 0    | 0          | 0    | 0    | 0    | 57                    | 157  | 0    | 0    | 1270       |
| 08:45 AM    | 115                      | 0    | 70   | 0    | 45                    | 799  | 0    | 0    | 0          | 0    | 0    | 0    | 46                    | 132  | 0    | 0    | 1207       |
| Total       | 459                      | 0    | 310  | 0    | 178                   | 3143 | 0    | 0    | 0          | 0    | 0    | 0    | 183                   | 564  | 0    | 0    | 4837       |
| Grand Total | 855                      | 0    | 680  | 0    | 362                   | 5868 | 0    | 0    | 0          | 0    | 0    | 0    | 330                   | 1021 | 0    | 0    | 9116       |
| Apprch %    | 55.7                     | 0    | 44.3 | 0    | 5.8                   | 94.2 | 0    | 0    | 0          | 0    | 0    | 0    | 24.4                  | 75.6 | 0    | 0    |            |
| Total %     | 9.4                      | 0    | 7.5  | 0    | 4                     | 64.4 | 0    | 0    | 0          | 0    | 0    | 0    | 3.6                   | 11.2 | 0    | 0    |            |

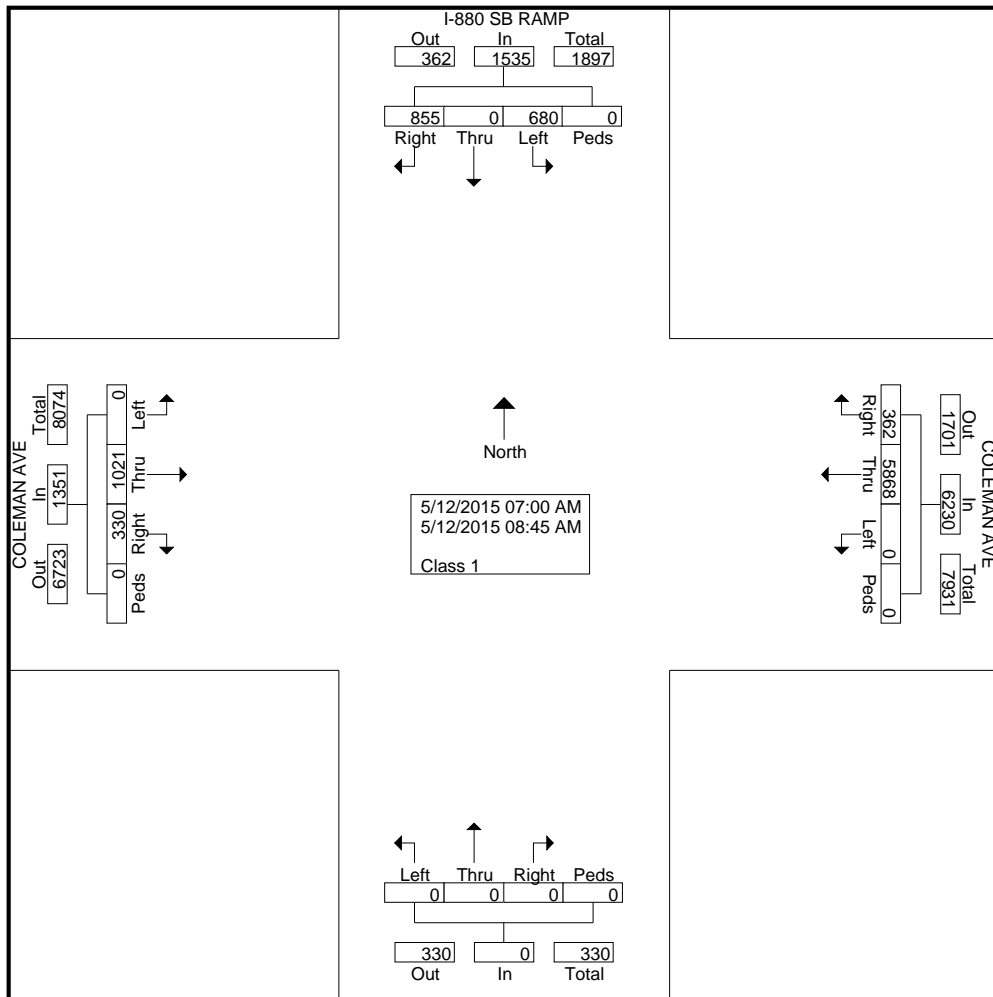

| Start Time  | I-880 SB RAMP Southbound |      |      |      |            | COLEMAN AVE Westbound |      |      |      |            | Northbound |      |      |      |            | COLEMAN AVE Eastbound |      |      |      |            | Int. Total |
|---|--------------------------|------|------|------|------------|-----------------------|------|------|------|------------|------------|------|------|------|------------|-----------------------|------|------|------|------------|------------|
|   | Right                    | Thru | Left | Peds | App. Total | Right                 | Thru | Left | Peds | App. Total | Right      | Thru | Left | Peds | App. Total | Right                 | Thru | Left | Peds | App. Total |            |
| <b>Peak Hour Analysis From 07:00 AM to 08:45 AM - Peak 1 of 1</b> |                          |      |      |      |            |                       |      |      |      |            |            |      |      |      |            |                       |      |      |      |            |            |
| Peak Hour for Entire Intersection Begins at 08:00 AM              |                          |      |      |      |            |                       |      |      |      |            |            |      |      |      |            |                       |      |      |      |            |            |
| 08:00 AM  | 104                      | 0    | 102  | 0    | 206        | 44                    | 751  | 0    | 0    | 795        | 0          | 0    | 0    | 0    | 0          | 39                    | 120  | 0    | 0    | 159        | 1160       |
| 08:15 AM  | 117                      | 0    | 69   | 0    | 186        | 37                    | 781  | 0    | 0    | 818        | 0          | 0    | 0    | 0    | 0          | 41                    | 155  | 0    | 0    | 196        | 1200       |
| 08:30 AM  | 123                      | 0    | 69   | 0    | 192        | 52                    | 812  | 0    | 0    | 864        | 0          | 0    | 0    | 0    | 0          | 57                    | 157  | 0    | 0    | 214        | 1270       |
| 08:45 AM  | 115                      | 0    | 70   | 0    | 185        | 45                    | 799  | 0    | 0    | 844        | 0          | 0    | 0    | 0    | 0          | 46                    | 132  | 0    | 0    | 178        | 1207       |
| Total Volume  | 459                      | 0    | 310  | 0    | 769        | 178                   | 3143 | 0    | 0    | 3321       | 0          | 0    | 0    | 0    | 0          | 183                   | 564  | 0    | 0    | 747        | 4837       |
| % App. Total  | 59.7                     | 0    | 40.3 | 0    |            | 5.4                   | 94.6 | 0    | 0    |            | 0          | 0    | 0    | 0    |            | 24.5                  | 75.5 | 0    | 0    |            |            |
| PHF   | .933                     | .000 | .760 | .000 | .933       | .856                  | .968 | .000 | .000 | .961       | .000       | .000 | .000 | .000 | .000       | .803                  | .898 | .000 | .000 | .873       | .952       |

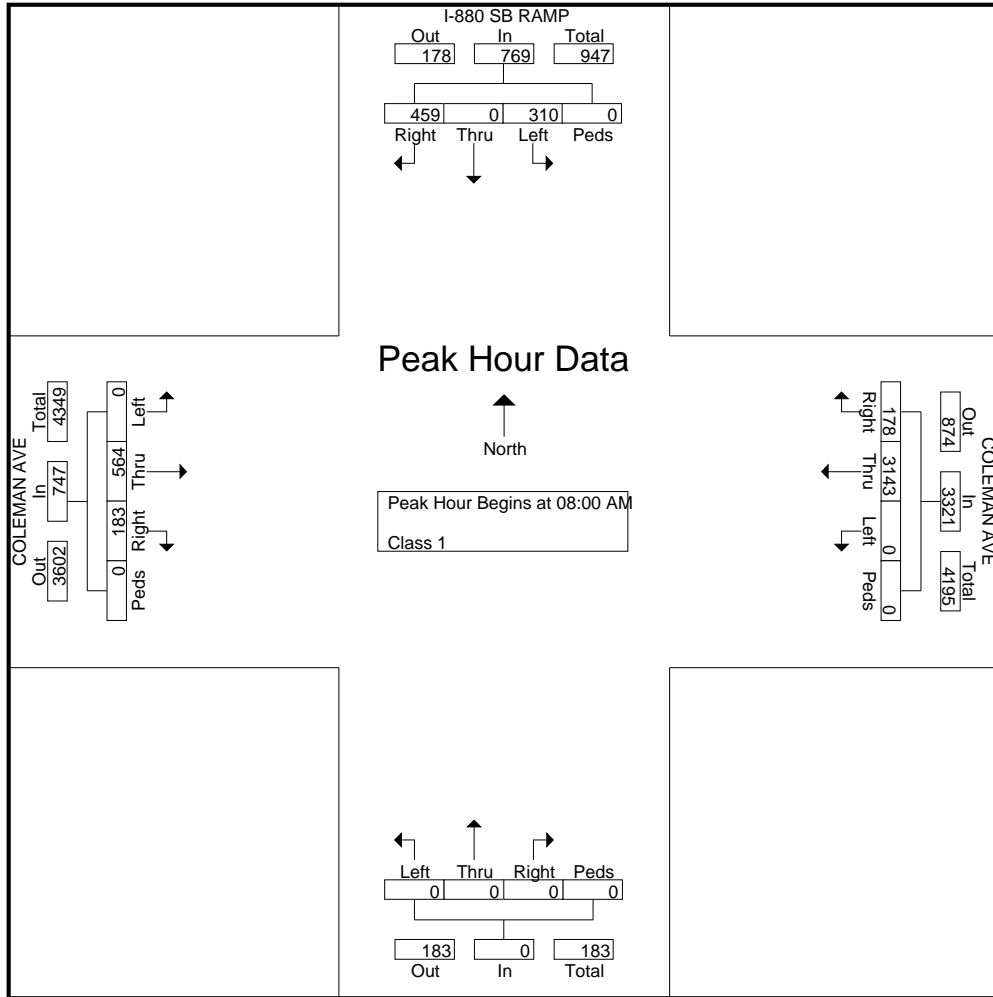

File Name : #43 COLEMAN&HEDDINGAM  
 Site Code :  
 Start Date : 5/12/2015  
 Page No : 1

Groups Printed- Class 1

| Start Time  | HEDDING ST Southbound |      |      |      | COLEMAN AVE Westbound |      |      |      | HEDDING ST Northbound |      |      |      | COLEMAN AVE Eastbound |      |      |      | Int. Total |
|-------------|-----------------------|------|------|------|-----------------------|------|------|------|-----------------------|------|------|------|-----------------------|------|------|------|------------|
|             | Right                 | Thru | Left | Peds | Right                 | Thru | Left | Peds | Right                 | Thru | Left | Peds | Right                 | Thru | Left | Peds |            |
| 07:00 AM    | 116                   | 36   | 3    | 0    | 15                    | 279  | 10   | 3    | 15                    | 28   | 39   | 1    | 20                    | 106  | 36   | 0    | 707        |
| 07:15 AM    | 136                   | 66   | 14   | 0    | 7                     | 319  | 17   | 1    | 19                    | 47   | 48   | 1    | 22                    | 110  | 30   | 0    | 837        |
| 07:30 AM    | 187                   | 111  | 11   | 0    | 7                     | 416  | 20   | 4    | 30                    | 46   | 53   | 0    | 41                    | 117  | 43   | 0    | 1086       |
| 07:45 AM    | 166                   | 118  | 13   | 0    | 2                     | 412  | 21   | 1    | 27                    | 72   | 72   | 3    | 41                    | 129  | 36   | 1    | 1114       |
| Total       | 605                   | 331  | 41   | 0    | 31                    | 1426 | 68   | 9    | 91                    | 193  | 212  | 5    | 124                   | 462  | 145  | 1    | 3744       |
| 08:00 AM    | 200                   | 83   | 10   | 1    | 5                     | 357  | 29   | 2    | 29                    | 91   | 64   | 0    | 42                    | 124  | 42   | 1    | 1080       |
| 08:15 AM    | 193                   | 64   | 11   | 0    | 7                     | 394  | 28   | 2    | 15                    | 87   | 60   | 2    | 15                    | 122  | 44   | 0    | 1044       |
| 08:30 AM    | 196                   | 63   | 13   | 0    | 6                     | 343  | 15   | 5    | 31                    | 100  | 44   | 3    | 20                    | 129  | 46   | 0    | 1014       |
| 08:45 AM    | 190                   | 61   | 10   | 0    | 10                    | 344  | 22   | 2    | 23                    | 72   | 52   | 3    | 27                    | 125  | 53   | 0    | 994        |
| Total       | 779                   | 271  | 44   | 1    | 28                    | 1438 | 94   | 11   | 98                    | 350  | 220  | 8    | 104                   | 500  | 185  | 1    | 4132       |
| Grand Total | 1384                  | 602  | 85   | 1    | 59                    | 2864 | 162  | 20   | 189                   | 543  | 432  | 13   | 228                   | 962  | 330  | 2    | 7876       |
| Apprch %    | 66.8                  | 29.1 | 4.1  | 0    | 1.9                   | 92.2 | 5.2  | 0.6  | 16.1                  | 46.1 | 36.7 | 1.1  | 15                    | 63.2 | 21.7 | 0.1  |            |
| Total %     | 17.6                  | 7.6  | 1.1  | 0    | 0.7                   | 36.4 | 2.1  | 0.3  | 2.4                   | 6.9  | 5.5  | 0.2  | 2.9                   | 12.2 | 4.2  | 0    |            |

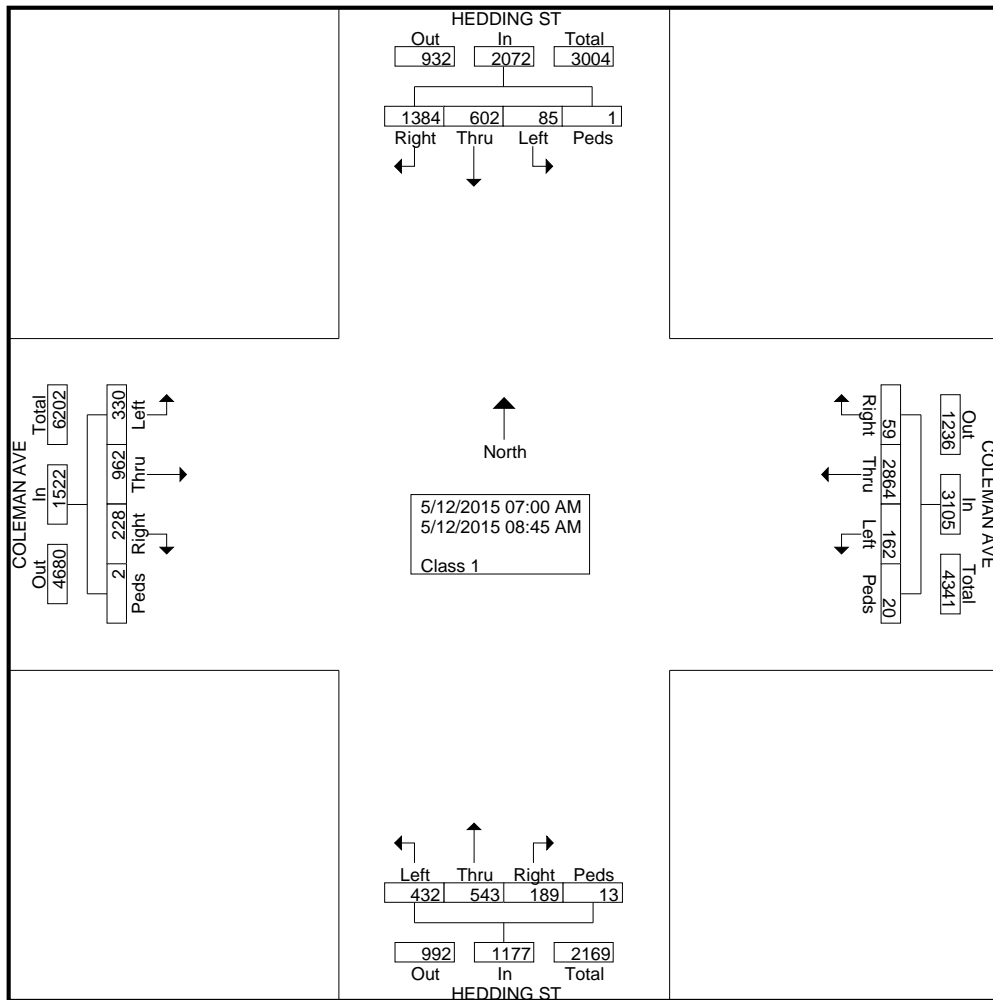

File Name : #43 COLEMAN&HEDDINGAM  
 Site Code :  
 Start Date : 5/12/2015  
 Page No : 2

| Start Time  | HEDDING ST Southbound |      |      |      |            | COLEMAN AVE Westbound |      |      |      |            | HEDDING ST Northbound |      |      |      |            | COLEMAN AVE Eastbound |      |      |      |            | Int. Total |
|---|-----------------------|------|------|------|------------|-----------------------|------|------|------|------------|-----------------------|------|------|------|------------|-----------------------|------|------|------|------------|------------|
|   | Right                 | Thru | Left | Peds | App. Total | Right                 | Thru | Left | Peds | App. Total | Right                 | Thru | Left | Peds | App. Total | Right                 | Thru | Left | Peds | App. Total |            |
| <b>Peak Hour Analysis From 07:00 AM to 08:45 AM - Peak 1 of 1</b> |                       |      |      |      |            |                       |      |      |      |            |                       |      |      |      |            |                       |      |      |      |            |            |
| Peak Hour for Entire Intersection Begins at 07:30 AM              |                       |      |      |      |            |                       |      |      |      |            |                       |      |      |      |            |                       |      |      |      |            |            |
| 07:30 AM  | 187                   | 111  | 11   | 0    | 309        | 7                     | 416  | 20   | 4    | 447        | 30                    | 46   | 53   | 0    | 129        | 41                    | 117  | 43   | 0    | 201        | 1086       |
| 07:45 AM  | 166                   | 118  | 13   | 0    | 297        | 2                     | 412  | 21   | 1    | 436        | 27                    | 72   | 72   | 3    | 174        | 41                    | 129  | 36   | 1    | 207        | 1114       |
| 08:00 AM  | 200                   | 83   | 10   | 1    | 294        | 5                     | 357  | 29   | 2    | 393        | 29                    | 91   | 64   | 0    | 184        | 42                    | 124  | 42   | 1    | 209        | 1080       |
| 08:15 AM  | 193                   | 64   | 11   | 0    | 268        | 7                     | 394  | 28   | 2    | 431        | 15                    | 87   | 60   | 2    | 164        | 15                    | 122  | 44   | 0    | 181        | 1044       |
| Total Volume  | 746                   | 376  | 45   | 1    | 1168       | 21                    | 1579 | 98   | 9    | 1707       | 101                   | 296  | 249  | 5    | 651        | 139                   | 492  | 165  | 2    | 798        | 4324       |
| % App. Total  | 63.9                  | 32.2 | 3.9  | 0.1  |            | 1.2                   | 92.5 | 5.7  | 0.5  |            | 15.5                  | 45.5 | 38.2 | 0.8  |            | 17.4                  | 61.7 | 20.7 | 0.3  |            |            |
| PHF   | .933                  | .797 | .865 | .250 | .945       | .750                  | .949 | .845 | .563 | .955       | .842                  | .813 | .865 | .417 | .885       | .827                  | .953 | .938 | .500 | .955       | .970       |

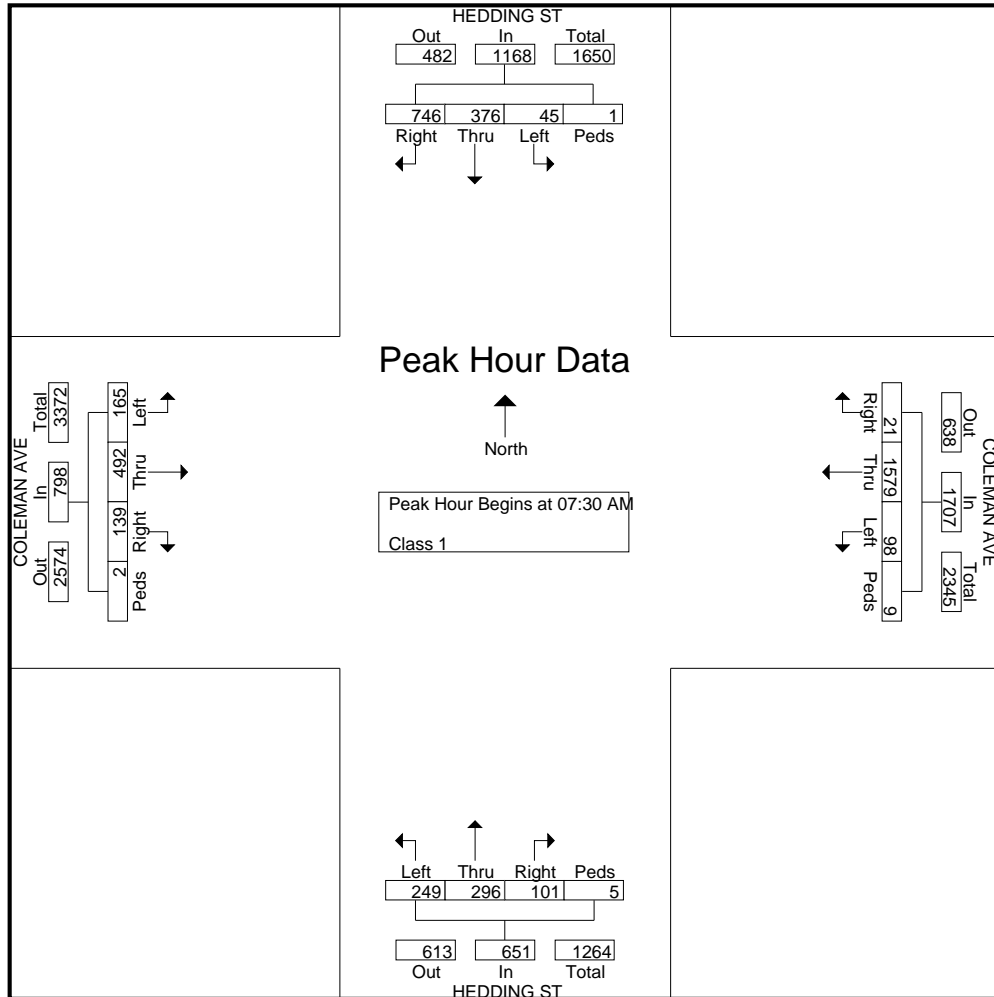

File Name : #43 COLEMAN&HEDDINGPM  
 Site Code :  
 Start Date : 5/12/2015  
 Page No : 1

Groups Printed- Class 1

| Start Time  | HEDDING ST Southbound |      |      |      | COLEMAN AVE Westbound |      |      |      | HEDDING ST Northbound |      |      |      | COLEMAN AVE Eastbound |      |      |      | Int. Total |
|-------------|-----------------------|------|------|------|-----------------------|------|------|------|-----------------------|------|------|------|-----------------------|------|------|------|------------|
|             | Right                 | Thru | Left | Peds | Right                 | Thru | Left | Peds | Right                 | Thru | Left | Peds | Right                 | Thru | Left | Peds |            |
| 04:00 PM    | 91                    | 53   | 20   | 1    | 4                     | 160  | 15   | 3    | 32                    | 67   | 37   | 1    | 25                    | 344  | 82   | 2    | 937        |
| 04:15 PM    | 79                    | 57   | 17   | 0    | 6                     | 168  | 22   | 2    | 20                    | 55   | 42   | 0    | 37                    | 341  | 70   | 3    | 919        |
| 04:30 PM    | 82                    | 89   | 17   | 0    | 12                    | 171  | 23   | 1    | 33                    | 75   | 44   | 1    | 38                    | 338  | 68   | 1    | 993        |
| 04:45 PM    | 94                    | 68   | 13   | 0    | 12                    | 160  | 30   | 2    | 34                    | 71   | 41   | 0    | 48                    | 375  | 67   | 0    | 1015       |
| Total       | 346                   | 267  | 67   | 1    | 34                    | 659  | 90   | 8    | 119                   | 268  | 164  | 2    | 148                   | 1398 | 287  | 6    | 3864       |
| 05:00 PM    | 102                   | 101  | 18   | 0    | 9                     | 198  | 20   | 5    | 44                    | 96   | 37   | 2    | 74                    | 339  | 94   | 0    | 1139       |
| 05:15 PM    | 87                    | 135  | 17   | 0    | 11                    | 212  | 35   | 2    | 51                    | 109  | 35   | 3    | 69                    | 309  | 109  | 0    | 1184       |
| 05:30 PM    | 81                    | 115  | 19   | 0    | 12                    | 174  | 40   | 3    | 27                    | 131  | 49   | 0    | 61                    | 344  | 109  | 2    | 1167       |
| 05:45 PM    | 58                    | 97   | 18   | 1    | 13                    | 182  | 23   | 4    | 36                    | 101  | 49   | 1    | 84                    | 309  | 115  | 1    | 1092       |
| Total       | 328                   | 448  | 72   | 1    | 45                    | 766  | 118  | 14   | 158                   | 437  | 170  | 6    | 288                   | 1301 | 427  | 3    | 4582       |
| Grand Total | 674                   | 715  | 139  | 2    | 79                    | 1425 | 208  | 22   | 277                   | 705  | 334  | 8    | 436                   | 2699 | 714  | 9    | 8446       |
| Apprch %    | 44.1                  | 46.7 | 9.1  | 0.1  | 4.6                   | 82.2 | 12   | 1.3  | 20.9                  | 53.2 | 25.2 | 0.6  | 11.3                  | 70   | 18.5 | 0.2  |            |
| Total %     | 8                     | 8.5  | 1.6  | 0    | 0.9                   | 16.9 | 2.5  | 0.3  | 3.3                   | 8.3  | 4    | 0.1  | 5.2                   | 32   | 8.5  | 0.1  |            |

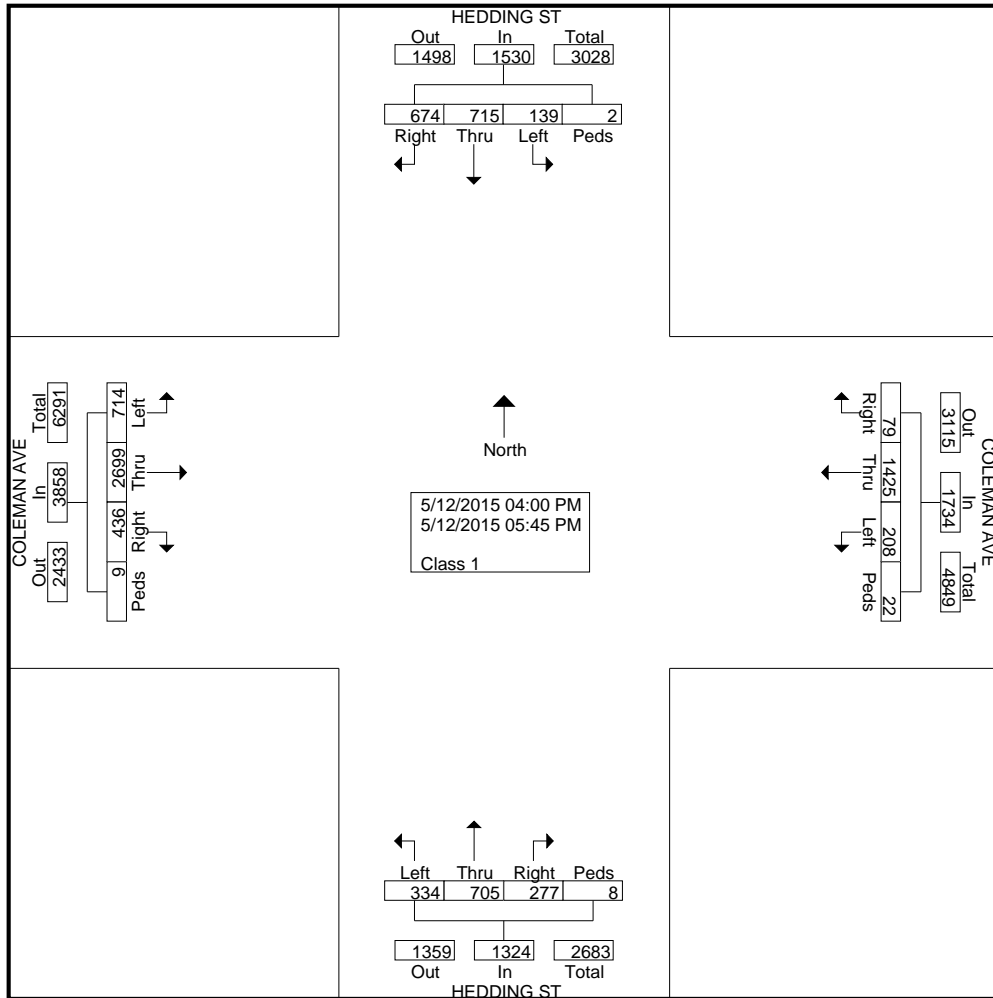

File Name : #43 COLEMAN&HEDDINGPM  
 Site Code :  
 Start Date : 5/12/2015  
 Page No : 2

| Start Time  | HEDDING ST Southbound |      |      |      |            | COLEMAN AVE Westbound |      |      |      |            | HEDDING ST Northbound |      |      |      |            | COLEMAN AVE Eastbound |      |      |      |            | Int. Total |
|---|-----------------------|------|------|------|------------|-----------------------|------|------|------|------------|-----------------------|------|------|------|------------|-----------------------|------|------|------|------------|------------|
|   | Right                 | Thru | Left | Peds | App. Total | Right                 | Thru | Left | Peds | App. Total | Right                 | Thru | Left | Peds | App. Total | Right                 | Thru | Left | Peds | App. Total |            |
| <b>Peak Hour Analysis From 04:00 PM to 05:45 PM - Peak 1 of 1</b> |                       |      |      |      |            |                       |      |      |      |            |                       |      |      |      |            |                       |      |      |      |            |            |
| Peak Hour for Entire Intersection Begins at 05:00 PM              |                       |      |      |      |            |                       |      |      |      |            |                       |      |      |      |            |                       |      |      |      |            |            |
| 05:00 PM  | 102                   | 101  | 18   | 0    | 221        | 9                     | 198  | 20   | 5    | 232        | 44                    | 96   | 37   | 2    | 179        | 74                    | 339  | 94   | 0    | 507        | 1139       |
| 05:15 PM  | 87                    | 135  | 17   | 0    | 239        | 11                    | 212  | 35   | 2    | 260        | 51                    | 109  | 35   | 3    | 198        | 69                    | 309  | 109  | 0    | 487        | 1184       |
| 05:30 PM  | 81                    | 115  | 19   | 0    | 215        | 12                    | 174  | 40   | 3    | 229        | 27                    | 131  | 49   | 0    | 207        | 61                    | 344  | 109  | 2    | 516        | 1167       |
| 05:45 PM  | 58                    | 97   | 18   | 1    | 174        | 13                    | 182  | 23   | 4    | 222        | 36                    | 101  | 49   | 1    | 187        | 84                    | 309  | 115  | 1    | 509        | 1092       |
| Total Volume  | 328                   | 448  | 72   | 1    | 849        | 45                    | 766  | 118  | 14   | 943        | 158                   | 437  | 170  | 6    | 771        | 288                   | 1301 | 427  | 3    | 2019       | 4582       |
| % App. Total  | 38.6                  | 52.8 | 8.5  | 0.1  |            | 4.8                   | 81.2 | 12.5 | 1.5  |            | 20.5                  | 56.7 | 22   | 0.8  |            | 14.3                  | 64.4 | 21.1 | 0.1  |            |            |
| PHF   | .804                  | .830 | .947 | .250 | .888       | .865                  | .903 | .738 | .700 | .907       | .775                  | .834 | .867 | .500 | .931       | .857                  | .945 | .928 | .375 | .978       | .967       |

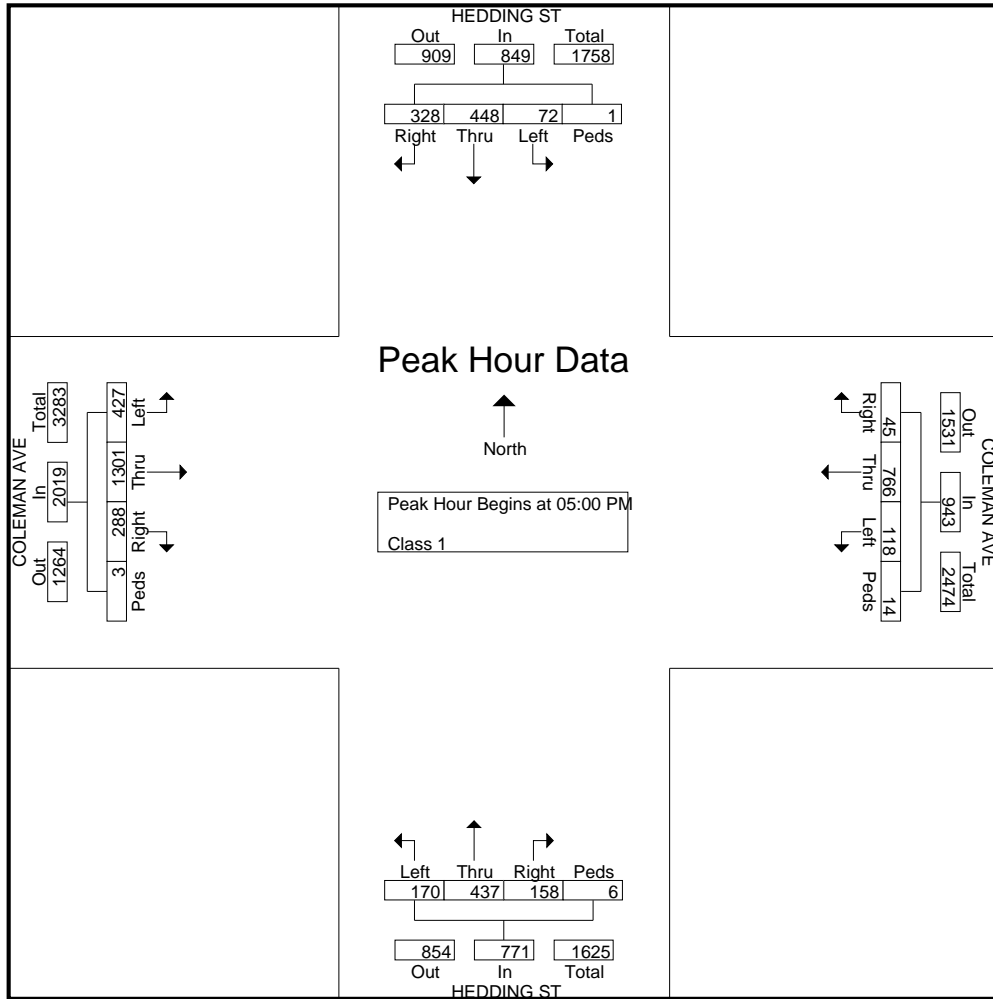

Groups Printed- Class 1

| Start Time   | SR87 NB ON RAMP Southbound |          |              |          |          |          | TAYLOR ST Westbound |              |            |             |            | SR87 NB OFF RAMP Northbound |             |          |             |             | SR87 SB ON RAMP Northeastbound |               |              |             |          | TAYLOR ST Eastbound |          |               |            |          | SR87 SB OFF RAMP Southeastbound |             |          |               |            | Int. Total |              |             |             |          |             |
|--------------|----------------------------|----------|--------------|----------|----------|----------|---------------------|--------------|------------|-------------|------------|-----------------------------|-------------|----------|-------------|-------------|--------------------------------|---------------|--------------|-------------|----------|---------------------|----------|---------------|------------|----------|---------------------------------|-------------|----------|---------------|------------|------------|--------------|-------------|-------------|----------|-------------|
|              | Har d R igh t              | Rig ht   | Bea r Ri ght | Thru     | Lef t    | Ped s    | Rig ht              | Bea r Ri ght | Thru       | Bea r Le ft | Lef t      | Ped s                       | Rig ht      | Thru     | Bea r Le ft | Har d L eft | Ped s                          | Har d R igh t | Bea r Ri ght | Bea r Le ft | Lef t    | Har d L eft         | Ped s    | Har d R igh t | Rig ht     | Thru     | Lef t                           | Har d L eft | Ped s    | Har d R igh t | Rig ht     |            | Bea r Ri ght | Bea r Le ft | Har d L eft | Ped s    |             |
| 07:00 AM     | 0                          | 0        | 0            | 0        | 0        | 0        | 29                  | 0            | 63         | 143         | 141        | 0                           | 138         | 0        | 0           | 162         | 1                              | 3             | 0            | 0           | 0        | 0                   | 0        | 0             | 60         | 0        | 29                              | 12          | 0        | 0             | 19         | 0          | 0            | 18          | 0           | 1        | 819         |
| 07:15 AM     | 0                          | 0        | 0            | 0        | 0        | 0        | 21                  | 0            | 88         | 133         | 123        | 0                           | 196         | 0        | 0           | 152         | 4                              | 1             | 0            | 0           | 0        | 0                   | 0        | 0             | 74         | 0        | 50                              | 21          | 0        | 0             | 30         | 0          | 0            | 15          | 0           | 0        | 908         |
| 07:30 AM     | 0                          | 0        | 0            | 0        | 0        | 0        | 32                  | 0            | 91         | 132         | 132        | 0                           | 306         | 0        | 0           | 188         | 1                              | 1             | 0            | 0           | 0        | 0                   | 0        | 0             | 100        | 0        | 51                              | 24          | 0        | 0             | 35         | 0          | 0            | 24          | 0           | 0        | 1117        |
| 07:45 AM     | 0                          | 0        | 0            | 0        | 0        | 0        | 40                  | 0            | 82         | 139         | 138        | 0                           | 291         | 0        | 0           | 200         | 4                              | 1             | 0            | 0           | 0        | 0                   | 0        | 1             | 105        | 0        | 72                              | 35          | 0        | 0             | 47         | 0          | 0            | 50          | 0           | 0        | 1205        |
| <b>Total</b> | <b>0</b>                   | <b>0</b> | <b>0</b>     | <b>0</b> | <b>0</b> | <b>0</b> | <b>122</b>          | <b>0</b>     | <b>324</b> | <b>547</b>  | <b>534</b> | <b>0</b>                    | <b>931</b>  | <b>0</b> | <b>0</b>    | <b>702</b>  | <b>10</b>                      | <b>6</b>      | <b>0</b>     | <b>0</b>    | <b>0</b> | <b>0</b>            | <b>0</b> | <b>1</b>      | <b>339</b> | <b>0</b> | <b>202</b>                      | <b>92</b>   | <b>0</b> | <b>0</b>      | <b>131</b> | <b>0</b>   | <b>0</b>     | <b>107</b>  | <b>0</b>    | <b>1</b> | <b>4049</b> |
| 08:00 AM     | 0                          | 0        | 0            | 0        | 0        | 0        | 23                  | 0            | 115        | 164         | 161        | 0                           | 249         | 0        | 0           | 167         | 0                              | 3             | 0            | 0           | 0        | 0                   | 0        | 0             | 114        | 0        | 59                              | 49          | 0        | 0             | 32         | 0          | 0            | 28          | 0           | 0        | 1164        |
| 08:15 AM     | 0                          | 0        | 0            | 0        | 0        | 0        | 25                  | 0            | 114        | 138         | 122        | 0                           | 254         | 0        | 0           | 162         | 0                              | 0             | 0            | 0           | 0        | 0                   | 0        | 0             | 78         | 0        | 87                              | 35          | 0        | 0             | 32         | 0          | 0            | 33          | 0           | 0        | 1080        |
| 08:30 AM     | 0                          | 0        | 0            | 0        | 0        | 0        | 24                  | 0            | 75         | 151         | 144        | 0                           | 243         | 0        | 0           | 171         | 0                              | 0             | 0            | 0           | 0        | 0                   | 0        | 0             | 72         | 0        | 58                              | 33          | 0        | 0             | 27         | 0          | 0            | 27          | 0           | 1        | 1026        |
| 08:45 AM     | 0                          | 0        | 0            | 0        | 0        | 0        | 17                  | 0            | 86         | 139         | 126        | 0                           | 267         | 0        | 0           | 148         | 0                              | 4             | 0            | 0           | 0        | 0                   | 0        | 0             | 57         | 0        | 64                              | 29          | 0        | 0             | 28         | 0          | 0            | 41          | 0           | 0        | 1006        |
| <b>Total</b> | <b>0</b>                   | <b>0</b> | <b>0</b>     | <b>0</b> | <b>0</b> | <b>0</b> | <b>89</b>           | <b>0</b>     | <b>390</b> | <b>592</b>  | <b>553</b> | <b>0</b>                    | <b>1013</b> | <b>0</b> | <b>0</b>    | <b>648</b>  | <b>0</b>                       | <b>7</b>      | <b>0</b>     | <b>0</b>    | <b>0</b> | <b>0</b>            | <b>0</b> | <b>0</b>      | <b>321</b> | <b>0</b> | <b>268</b>                      | <b>146</b>  | <b>0</b> | <b>0</b>      | <b>119</b> | <b>0</b>   | <b>0</b>     | <b>129</b>  | <b>0</b>    | <b>1</b> | <b>4276</b> |
| Grand Total  | 0                          | 0        | 0            | 0        | 0        | 0        | 211                 | 0            | 714        | 1139        | 1087       | 0                           | 1944        | 0        | 0           | 1350        | 10                             | 13            | 0            | 0           | 0        | 0                   | 0        | 1             | 660        | 0        | 470                             | 238         | 0        | 0             | 250        | 0          | 0            | 236         | 0           | 2        | 8325        |
| Apprch %     | 0                          | 0        | 0            | 0        | 0        | 0        | 6.7                 | 0            | 22.7       | 36.1        | 34.5       | 0                           | 58.6        | 0        | 0           | 40.7        | 0.3                            | 0.4           | 0            | 0           | 0        | 0                   | 0        | 100           | 48.2       | 0        | 34.4                            | 17.4        | 0        | 0             | 51.2       | 0          | 0            | 48.4        | 0           | 0.4      |             |
| Total %      | 0                          | 0        | 0            | 0        | 0        | 0        | 2.5                 | 0            | 8.6        | 13.7        | 13.1       | 0                           | 23.4        | 0        | 0           | 16.2        | 0.1                            | 0.2           | 0            | 0           | 0        | 0                   | 0        | 0             | 7.9        | 0        | 5.6                             | 2.9         | 0        | 0             | 3          | 0          | 0            | 2.8         | 0           | 0        |             |

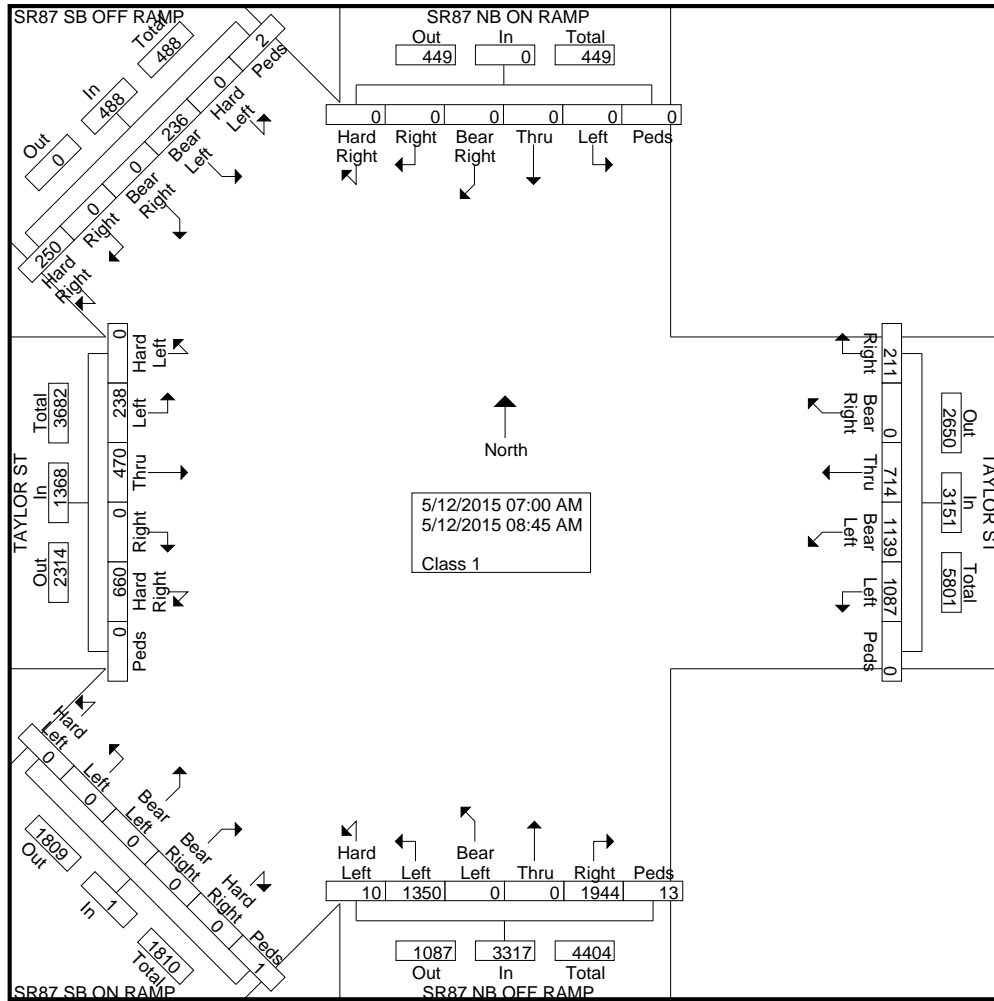

| Start Time | SR87 NB ON RAMP Southbound |    |     |     | TAYLOR ST Westbound |     |     |    | SR87 NB OFF RAMP Northbound |     |    |     | SR87 SB ON RAMP Northeastbound |    |     |     | TAYLOR ST Eastbound |     |     |    | SR87 SB OFF RAMP Southeastbound |     |    |     |     |
|------------|----------------------------|----|-----|-----|---------------------|-----|-----|----|-----------------------------|-----|----|-----|--------------------------------|----|-----|-----|---------------------|-----|-----|----|---------------------------------|-----|----|-----|-----|
|            | App                        | To | tal | App | To                  | tal | App | To | tal                         | App | To | tal | App                            | To | tal | App | To                  | tal | App | To | tal                             | App | To | tal | Int |

Peak Hour Analysis From 07:00 AM to 08:45 AM - Peak 1 of 1

Peak Hour for Entire Intersection Begins at 07:30 AM

|          |    |    |    |    |      |    |    |    |    |      |    |    |    |      |    |    |    |      |    |    |    |    |    |      |      |
|----------|----|----|----|----|------|----|----|----|----|------|----|----|----|------|----|----|----|------|----|----|----|----|----|------|------|
| 07:30 AM | 0  |    |    |    | 387  | 30 |    |    |    | 496  |    |    | 0  |      |    |    |    | 175  |    |    |    |    |    | 59   | 111  |
| 07:45 AM | 0  | 40 |    |    | 399  |    | 20 | 4  |    | 496  |    |    | 1  | 1    |    |    |    | 212  | 47 |    |    |    |    | 97   | 120  |
| 08:00 AM | 0  |    | 11 | 16 | 16   |    |    |    | 3  | 419  |    |    | 0  | 11   |    | 49 |    | 222  |    |    |    |    |    | 60   | 116  |
| 08:15 AM | 0  |    | 5  | 4  | 1    |    |    |    |    | 399  |    |    | 0  |      | 87 |    |    | 200  |    |    |    |    |    | 65   | 108  |
| Total    | 0  |    |    |    | 164  |    |    |    |    | 182  |    |    | 1  |      |    |    |    | 809  |    |    |    |    |    | 281  | 456  |
| Volume   |    |    |    |    | 8    |    |    |    |    | 7    |    |    |    |      |    |    |    |      |    |    |    |    |    |      | 6    |
| % App.   |    |    |    |    | .890 |    |    |    |    | .921 |    |    |    | .250 |    |    |    | .911 |    |    |    |    |    | .724 | .947 |
| PH       | .0 | .0 | .0 | .0 | .0   | .7 | .0 | .8 | .8 | .8   | .0 | .8 | .0 | .0   | .0 | .0 | .0 | .0   | .7 | .0 | .0 | .6 | .0 | .0   | .724 |
| F        | 00 | 00 | 00 | 00 | 00   | 50 | 00 | 74 | 73 | 59   | 00 | 99 | 00 | 00   | 96 | 13 | 17 | .921 | 00 | 00 | 00 | 00 | 00 | 50   | .250 |



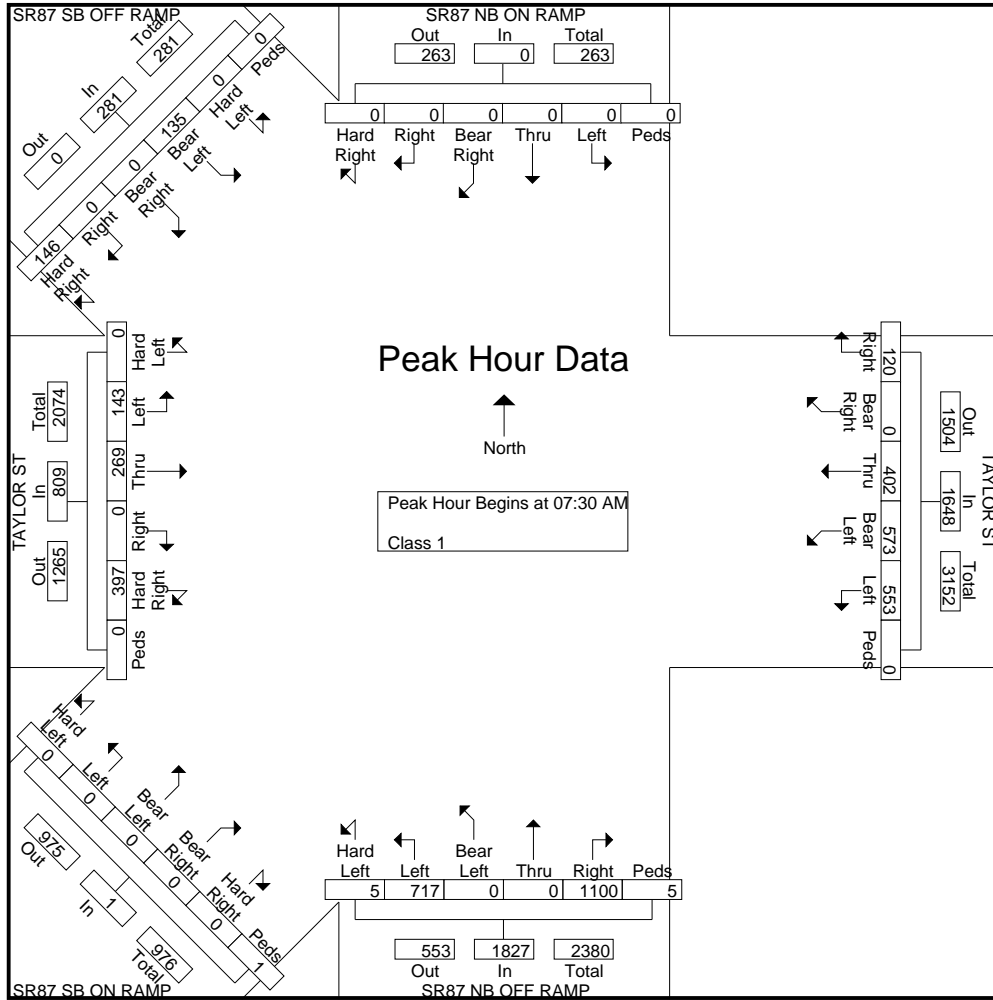

File Name : #44 SR87&TAYLORPM  
 Site Code :  
 Start Date : 5/12/2015  
 Page No : 1

Groups Printed- Class 1

| Start Time   | SR87 NB ON RAMP Southbound |          |              |          |          |           | TAYLOR ST Westbound |              |            |             |            | SR87 NB OFF RAMP Northbound |            |          |             |             | SR87 SB ON RAMP Northeastbound |               |              |             |          | TAYLOR ST Eastbound |          |               |            |          | SR87 SB OFF RAMP Southeastbound |             |          |               |            | Int. Total |              |             |             |          |             |
|--------------|----------------------------|----------|--------------|----------|----------|-----------|---------------------|--------------|------------|-------------|------------|-----------------------------|------------|----------|-------------|-------------|--------------------------------|---------------|--------------|-------------|----------|---------------------|----------|---------------|------------|----------|---------------------------------|-------------|----------|---------------|------------|------------|--------------|-------------|-------------|----------|-------------|
|              | Har d R igh t              | Rig ht   | Bea r Ri ght | Thru     | Lef t    | Ped s     | Rig ht              | Bea r Ri ght | Thru       | Bea r Le ft | Lef t      | Ped s                       | Rig ht     | Thru     | Bea r Le ft | Har d L eft | Ped s                          | Har d R igh t | Bea r Ri ght | Bea r Le ft | Lef t    | Har d L eft         | Ped s    | Har d R igh t | Rig ht     | Thru     | Lef t                           | Har d L eft | Ped s    | Har d R igh t | Rig ht     |            | Bea r Ri ght | Bea r Le ft | Har d L eft | Ped s    |             |
| 04:00 PM     | 0                          | 0        | 0            | 0        | 0        | 2         | 27                  | 0            | 97         | 204         | 199        | 0                           | 163        | 0        | 0           | 96          | 0                              | 2             | 0            | 0           | 0        | 0                   | 0        | 3             | 197        | 0        | 106                             | 20          | 0        | 0             | 23         | 0          | 0            | 15          | 0           | 0        | 1154        |
| 04:15 PM     | 0                          | 0        | 0            | 0        | 0        | 6         | 27                  | 0            | 79         | 213         | 202        | 0                           | 165        | 0        | 0           | 139         | 1                              | 0             | 0            | 0           | 0        | 0                   | 0        | 0             | 180        | 0        | 95                              | 19          | 0        | 0             | 36         | 0          | 0            | 27          | 0           | 0        | 1189        |
| 04:30 PM     | 0                          | 0        | 0            | 0        | 0        | 3         | 31                  | 0            | 97         | 215         | 207        | 0                           | 159        | 0        | 0           | 121         | 1                              | 0             | 0            | 0           | 0        | 0                   | 0        | 0             | 144        | 0        | 103                             | 23          | 0        | 0             | 23         | 0          | 0            | 24          | 0           | 0        | 1151        |
| 04:45 PM     | 0                          | 0        | 0            | 0        | 0        | 2         | 27                  | 0            | 77         | 208         | 206        | 0                           | 178        | 0        | 0           | 130         | 1                              | 1             | 0            | 0           | 0        | 0                   | 0        | 1             | 170        | 0        | 101                             | 21          | 0        | 0             | 25         | 0          | 0            | 17          | 0           | 0        | 1165        |
| <b>Total</b> | <b>0</b>                   | <b>0</b> | <b>0</b>     | <b>0</b> | <b>0</b> | <b>13</b> | <b>112</b>          | <b>0</b>     | <b>350</b> | <b>840</b>  | <b>814</b> | <b>0</b>                    | <b>665</b> | <b>0</b> | <b>0</b>    | <b>486</b>  | <b>3</b>                       | <b>3</b>      | <b>0</b>     | <b>0</b>    | <b>0</b> | <b>0</b>            | <b>0</b> | <b>4</b>      | <b>691</b> | <b>0</b> | <b>405</b>                      | <b>83</b>   | <b>0</b> | <b>0</b>      | <b>107</b> | <b>0</b>   | <b>0</b>     | <b>83</b>   | <b>0</b>    | <b>0</b> | <b>4659</b> |
| 05:00 PM     | 0                          | 0        | 0            | 0        | 0        | 0         | 45                  | 0            | 90         | 216         | 208        | 0                           | 180        | 0        | 0           | 139         | 6                              | 1             | 0            | 0           | 0        | 0                   | 0        | 1             | 183        | 0        | 115                             | 33          | 0        | 0             | 48         | 0          | 0            | 10          | 0           | 1        | 1276        |
| 05:15 PM     | 0                          | 0        | 0            | 0        | 0        | 1         | 40                  | 0            | 106        | 171         | 169        | 0                           | 169        | 0        | 0           | 161         | 1                              | 3             | 0            | 0           | 0        | 0                   | 0        | 3             | 153        | 0        | 134                             | 27          | 0        | 0             | 35         | 0          | 0            | 17          | 0           | 1        | 1191        |
| 05:30 PM     | 0                          | 0        | 0            | 0        | 0        | 2         | 38                  | 0            | 96         | 217         | 218        | 0                           | 184        | 0        | 0           | 164         | 1                              | 4             | 0            | 0           | 0        | 0                   | 0        | 4             | 131        | 0        | 118                             | 32          | 0        | 0             | 47         | 0          | 0            | 21          | 0           | 2        | 1279        |
| 05:45 PM     | 0                          | 0        | 0            | 0        | 0        | 0         | 25                  | 0            | 114        | 165         | 171        | 0                           | 185        | 0        | 0           | 120         | 1                              | 4             | 0            | 0           | 0        | 0                   | 0        | 3             | 126        | 0        | 125                             | 19          | 0        | 0             | 39         | 0          | 0            | 26          | 0           | 0        | 1123        |
| <b>Total</b> | <b>0</b>                   | <b>0</b> | <b>0</b>     | <b>0</b> | <b>0</b> | <b>3</b>  | <b>148</b>          | <b>0</b>     | <b>406</b> | <b>769</b>  | <b>766</b> | <b>0</b>                    | <b>718</b> | <b>0</b> | <b>0</b>    | <b>584</b>  | <b>9</b>                       | <b>12</b>     | <b>0</b>     | <b>0</b>    | <b>0</b> | <b>0</b>            | <b>0</b> | <b>11</b>     | <b>593</b> | <b>0</b> | <b>492</b>                      | <b>111</b>  | <b>0</b> | <b>0</b>      | <b>169</b> | <b>0</b>   | <b>0</b>     | <b>74</b>   | <b>0</b>    | <b>4</b> | <b>4869</b> |
| Grand Total  | 0                          | 0        | 0            | 0        | 0        | 16        | 260                 | 0            | 756        | 160         | 158        | 0                           | 138        | 0        | 0           | 107         | 12                             | 15            | 0            | 0           | 0        | 0                   | 0        | 15            | 128        | 0        | 897                             | 194         | 0        | 0             | 276        | 0          | 0            | 157         | 0           | 4        | 9528        |
| Apprch %     | 0                          | 0        | 0            | 0        | 0        | 100       | 6.2                 | 0            | 18         | 38.         | 37.        | 0                           | 55.        | 0        | 0           | 43.         | 0.5                            | 0.6           | 0            | 0           | 0        | 0                   | 0        | 100           | 54.        | 0        | 37.                             | 8.2         | 0        | 0             | 63.        | 0          | 0            | 35.         | 0           | 0.9      |             |
| Total %      | 0                          | 0        | 0            | 0        | 0        | 0.2       | 2.7                 | 0            | 7.9        | 16.         | 16.        | 0                           | 14.        | 0        | 0           | 11.         | 0.1                            | 0.2           | 0            | 0           | 0        | 0                   | 0        | 0.2           | 13.        | 0        | 9.4                             | 2           | 0        | 0             | 2.9        | 0          | 0            | 1.6         | 0           | 0        |             |

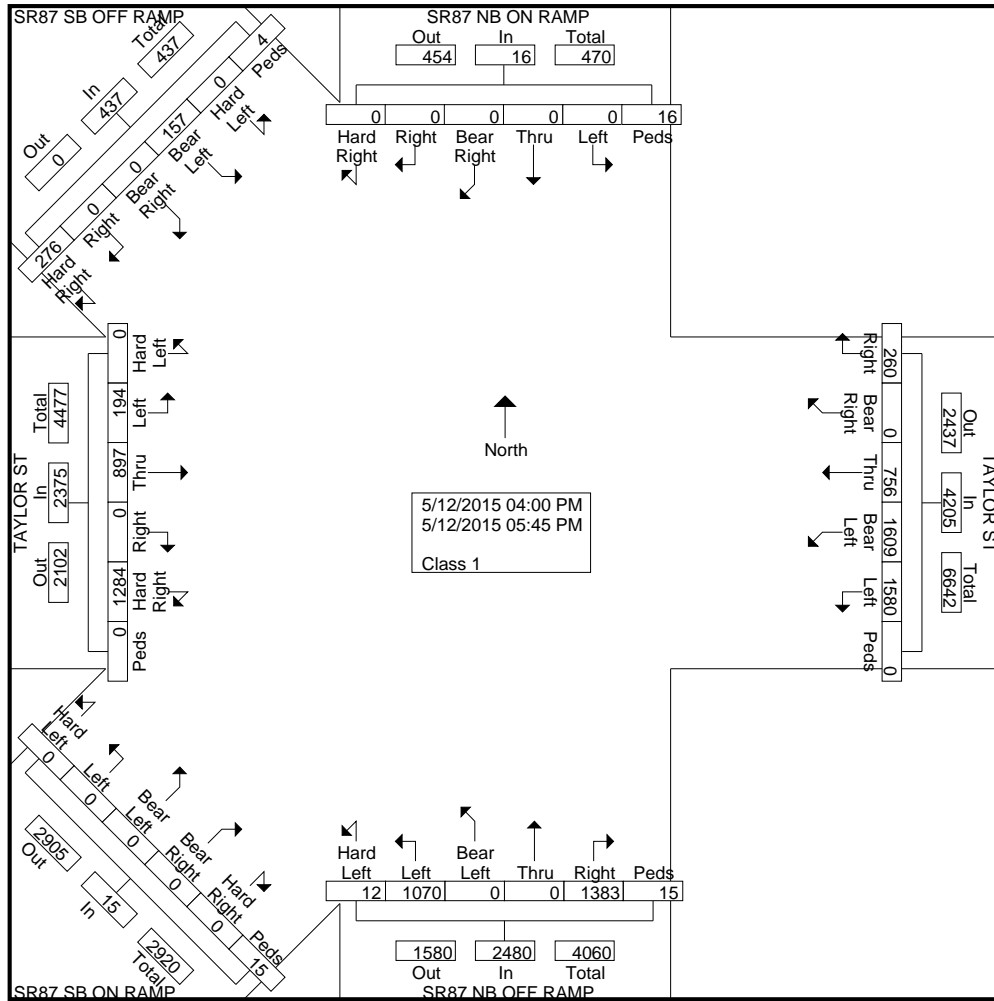

| Start Time | SR87 NB ON RAMP Southbound |         |         |         | TAYLOR ST Westbound |         |         |         | SR87 NB OFF RAMP Northbound |         |         |         | SR87 SB ON RAMP Northeastbound |         |         |         | TAYLOR ST Eastbound |         |         |         | SR87 SB OFF RAMP Southeastbound |         |  |  | Int. Total |
|------------|----------------------------|---------|---------|---------|---------------------|---------|---------|---------|-----------------------------|---------|---------|---------|--------------------------------|---------|---------|---------|---------------------|---------|---------|---------|---------------------------------|---------|--|--|------------|
|            | App. To                    | App. To | App. To | App. To | App. To             | App. To | App. To | App. To | App. To                     | App. To | App. To | App. To | App. To                        | App. To | App. To | App. To | App. To             | App. To | App. To | App. To | App. To                         | App. To |  |  |            |

**Peak Hour Analysis From 04:00 PM to 05:45 PM - Peak 1 of 1**  
 Peak Hour for Entire Intersection Begins at 04:45 PM

|              |    |    |    |    |    |    |    |    |    |    |    |    |      |    |    |    |    |    |    |      |    |    |     |     |
|--------------|----|----|----|----|----|----|----|----|----|----|----|----|------|----|----|----|----|----|----|------|----|----|-----|-----|
| 04:45 PM     | 2  | 2  |    |    |    |    |    |    |    |    |    |    |      |    |    |    |    |    |    |      |    |    | 116 |     |
| 05:00 PM     | 0  | 45 |    |    |    |    |    |    |    | 6  |    |    |      | 18 |    | 33 |    |    |    | 48   |    |    | 127 |     |
| 05:15 PM     | 1  |    | 10 |    |    |    |    |    |    |    |    |    |      | 3  |    | 13 |    |    |    |      |    |    | 119 |     |
| 05:30 PM     | 2  |    | 21 | 21 |    |    |    | 18 | 16 | 4  |    |    |      | 4  |    |    |    |    |    |      |    |    | 127 |     |
| Total        | 5  |    | 7  | 8  |    |    | 4  | 4  |    |    |    |    | 9    |    |    |    |    |    |    | 21   |    | 2  | 491 |     |
| Volume       |    |    |    |    |    |    |    |    |    |    |    |    |      |    |    |    |    |    |    |      |    |    | 491 |     |
| % App. Total |    |    |    |    |    |    |    |    |    |    |    |    |      |    |    |    |    |    |    |      |    |    | 1   |     |
| PH           | .0 | .0 | .0 | .0 | .0 | .6 | .8 | .0 | .8 | .9 | .9 | .0 | .937 | .9 | .0 | .0 | .9 | .3 | .5 | .837 | .0 | .0 | .0  | .63 |
| F            | 00 | 00 | 00 | 00 | 00 | 25 | 33 | 00 | 70 | 35 | 19 | 00 | 937  | 66 | 00 | 00 | 05 | 75 | 63 | 837  | 00 | 00 | 00  | 63  |

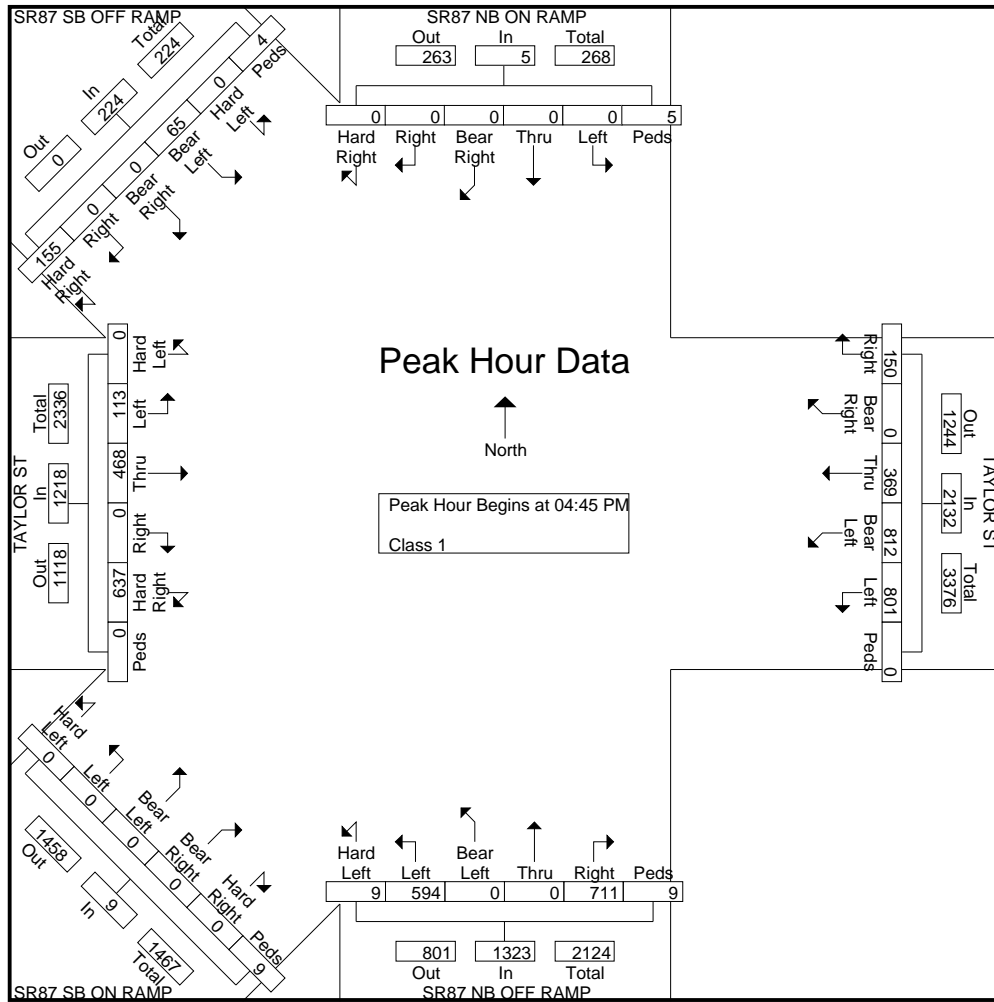

File Name : #62 ALMADEN&SANTA CLARA AM  
 Site Code :  
 Start Date : 5/19/2015  
 Page No : 1

Groups Printed- Class 1

| Start Time  | ALMADEN BLVD Southbound |      |      |      | SANTA CLARA ST Westbound |      |      |      | ALMADEN BLVD Northbound |      |      |      | SANTA CLARA ST Eastbound |      |      |      | Int. Total |
|-------------|-------------------------|------|------|------|--------------------------|------|------|------|-------------------------|------|------|------|--------------------------|------|------|------|------------|
|             | Right                   | Thru | Left | Peds | Right                    | Thru | Left | Peds | Right                   | Thru | Left | Peds | Right                    | Thru | Left | Peds |            |
| 07:00 AM    | 7                       | 12   | 10   | 11   | 0                        | 97   | 0    | 0    | 0                       | 0    | 0    | 3    | 49                       | 137  | 0    | 0    | 326        |
| 07:15 AM    | 12                      | 16   | 8    | 10   | 0                        | 142  | 0    | 0    | 0                       | 0    | 0    | 7    | 60                       | 155  | 0    | 0    | 410        |
| 07:30 AM    | 11                      | 22   | 10   | 20   | 0                        | 153  | 0    | 0    | 0                       | 0    | 0    | 13   | 72                       | 191  | 0    | 0    | 492        |
| 07:45 AM    | 15                      | 28   | 13   | 17   | 0                        | 166  | 0    | 0    | 0                       | 0    | 0    | 14   | 76                       | 274  | 0    | 0    | 603        |
| Total       | 45                      | 78   | 41   | 58   | 0                        | 558  | 0    | 0    | 0                       | 0    | 0    | 37   | 257                      | 757  | 0    | 0    | 1831       |
| 08:00 AM    | 17                      | 22   | 17   | 15   | 0                        | 134  | 0    | 0    | 0                       | 0    | 0    | 15   | 69                       | 266  | 0    | 1    | 556        |
| 08:15 AM    | 14                      | 35   | 20   | 16   | 0                        | 136  | 0    | 0    | 0                       | 0    | 0    | 21   | 91                       | 271  | 0    | 5    | 609        |
| 08:30 AM    | 15                      | 26   | 15   | 14   | 0                        | 107  | 0    | 0    | 0                       | 0    | 0    | 13   | 74                       | 245  | 0    | 1    | 510        |
| 08:45 AM    | 23                      | 23   | 23   | 16   | 0                        | 116  | 0    | 0    | 0                       | 0    | 0    | 24   | 99                       | 238  | 0    | 5    | 567        |
| Total       | 69                      | 106  | 75   | 61   | 0                        | 493  | 0    | 0    | 0                       | 0    | 0    | 73   | 333                      | 1020 | 0    | 12   | 2242       |
| Grand Total | 114                     | 184  | 116  | 119  | 0                        | 1051 | 0    | 0    | 0                       | 0    | 0    | 110  | 590                      | 1777 | 0    | 12   | 4073       |
| Apprch %    | 21.4                    | 34.5 | 21.8 | 22.3 | 0                        | 100  | 0    | 0    | 0                       | 0    | 0    | 100  | 24.8                     | 74.7 | 0    | 0.5  |            |
| Total %     | 2.8                     | 4.5  | 2.8  | 2.9  | 0                        | 25.8 | 0    | 0    | 0                       | 0    | 0    | 2.7  | 14.5                     | 43.6 | 0    | 0.3  |            |

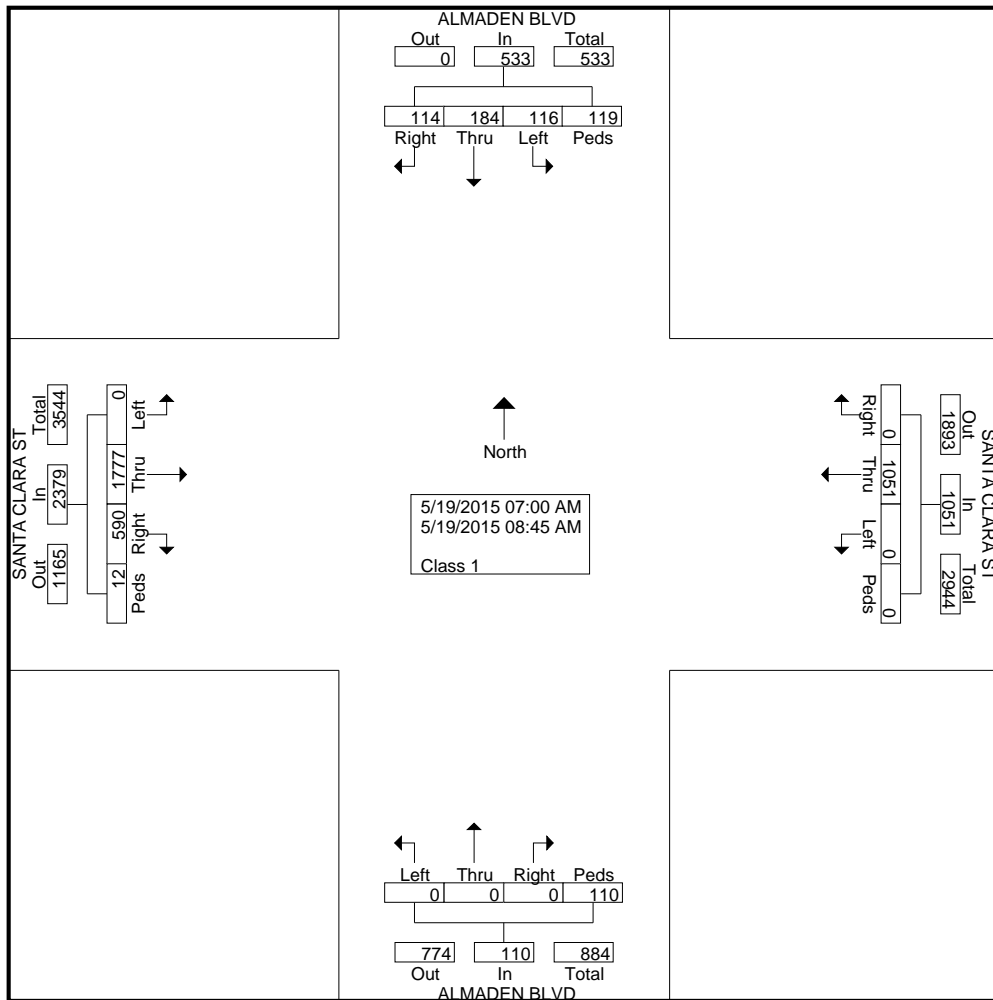

File Name : #62 ALMADEN&SANTA CLARA AM  
 Site Code :  
 Start Date : 5/19/2015  
 Page No : 2

| Start Time  | ALMADEN BLVD Southbound |      |      |      |            | SANTA CLARA ST Westbound |      |      |      |            | ALMADEN BLVD Northbound |      |      |      |            | SANTA CLARA ST Eastbound |      |      |      |            | Int. Total |
|---|-------------------------|------|------|------|------------|--------------------------|------|------|------|------------|-------------------------|------|------|------|------------|--------------------------|------|------|------|------------|------------|
|   | Right                   | Thru | Left | Peds | App. Total | Right                    | Thru | Left | Peds | App. Total | Right                   | Thru | Left | Peds | App. Total | Right                    | Thru | Left | Peds | App. Total |            |
| <b>Peak Hour Analysis From 07:00 AM to 08:45 AM - Peak 1 of 1</b> |                         |      |      |      |            |                          |      |      |      |            |                         |      |      |      |            |                          |      |      |      |            |            |
| Peak Hour for Entire Intersection Begins at 07:45 AM              |                         |      |      |      |            |                          |      |      |      |            |                         |      |      |      |            |                          |      |      |      |            |            |
| 07:45 AM  | 15                      | 28   | 13   | 17   | 73         | 0                        | 166  | 0    | 0    | 166        | 0                       | 0    | 0    | 14   | 14         | 76                       | 274  | 0    | 0    | 350        | 603        |
| 08:00 AM  | 17                      | 22   | 17   | 15   | 71         | 0                        | 134  | 0    | 0    | 134        | 0                       | 0    | 0    | 15   | 15         | 69                       | 266  | 0    | 1    | 336        | 556        |
| 08:15 AM  | 14                      | 35   | 20   | 16   | 85         | 0                        | 136  | 0    | 0    | 136        | 0                       | 0    | 0    | 21   | 21         | 91                       | 271  | 0    | 5    | 367        | 609        |
| 08:30 AM  | 15                      | 26   | 15   | 14   | 70         | 0                        | 107  | 0    | 0    | 107        | 0                       | 0    | 0    | 13   | 13         | 74                       | 245  | 0    | 1    | 320        | 510        |
| Total Volume  | 61                      | 111  | 65   | 62   | 299        | 0                        | 543  | 0    | 0    | 543        | 0                       | 0    | 0    | 63   | 63         | 310                      | 1056 | 0    | 7    | 1373       | 2278       |
| % App. Total  | 20.4                    | 37.1 | 21.7 | 20.7 |            | 0                        | 100  | 0    | 0    |            | 0                       | 0    | 0    | 100  |            | 22.6                     | 76.9 | 0    | 0.5  |            |            |
| PHF   | .897                    | .793 | .813 | .912 | .879       | .000                     | .818 | .000 | .000 | .818       | .000                    | .000 | .000 | .750 | .750       | .852                     | .964 | .000 | .350 | .935       | .935       |

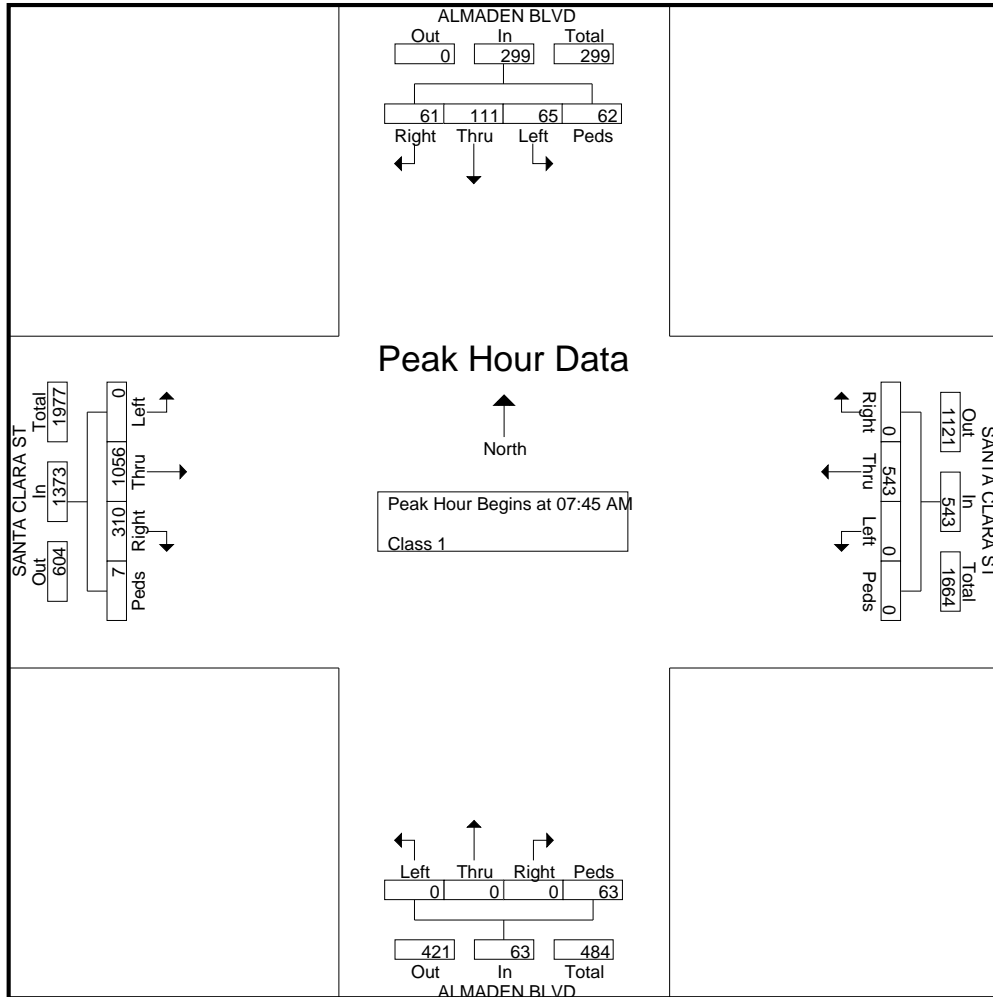

File Name : #62 ALMADEN&SANTA CLARA PM  
 Site Code :  
 Start Date : 5/19/2015  
 Page No : 1

Groups Printed- Class 1

| Start Time  | ALMADEN BLVD Southbound |      |      |      | SANTA CLARA ST Westbound |      |      |      | ALMADEN BLVD Northbound |      |      |      | SANTA CLARA ST Eastbound |      |      |      | Int. Total |
|-------------|-------------------------|------|------|------|--------------------------|------|------|------|-------------------------|------|------|------|--------------------------|------|------|------|------------|
|             | Right                   | Thru | Left | Peds | Right                    | Thru | Left | Peds | Right                   | Thru | Left | Peds | Right                    | Thru | Left | Peds |            |
| 04:00 PM    | 14                      | 16   | 14   | 37   | 0                        | 119  | 0    | 2    | 0                       | 0    | 0    | 15   | 61                       | 170  | 0    | 5    | 453        |
| 04:15 PM    | 21                      | 35   | 17   | 39   | 0                        | 110  | 0    | 0    | 0                       | 0    | 0    | 19   | 66                       | 203  | 0    | 7    | 517        |
| 04:30 PM    | 21                      | 39   | 15   | 44   | 0                        | 112  | 0    | 0    | 0                       | 0    | 0    | 26   | 58                       | 237  | 0    | 6    | 558        |
| 04:45 PM    | 22                      | 33   | 12   | 66   | 0                        | 109  | 0    | 1    | 0                       | 0    | 0    | 28   | 45                       | 212  | 0    | 3    | 531        |
| Total       | 78                      | 123  | 58   | 186  | 0                        | 450  | 0    | 3    | 0                       | 0    | 0    | 88   | 230                      | 822  | 0    | 21   | 2059       |
| 05:00 PM    | 29                      | 61   | 24   | 67   | 0                        | 130  | 0    | 0    | 0                       | 1    | 0    | 63   | 79                       | 239  | 0    | 1    | 694        |
| 05:15 PM    | 32                      | 34   | 16   | 91   | 0                        | 133  | 0    | 2    | 0                       | 0    | 0    | 68   | 78                       | 260  | 0    | 3    | 717        |
| 05:30 PM    | 28                      | 45   | 7    | 103  | 0                        | 103  | 0    | 0    | 0                       | 0    | 0    | 87   | 62                       | 251  | 0    | 3    | 689        |
| 05:45 PM    | 21                      | 30   | 15   | 100  | 0                        | 111  | 0    | 0    | 0                       | 0    | 0    | 108  | 75                       | 275  | 0    | 2    | 737        |
| Total       | 110                     | 170  | 62   | 361  | 0                        | 477  | 0    | 2    | 0                       | 1    | 0    | 326  | 294                      | 1025 | 0    | 9    | 2837       |
| Grand Total | 188                     | 293  | 120  | 547  | 0                        | 927  | 0    | 5    | 0                       | 1    | 0    | 414  | 524                      | 1847 | 0    | 30   | 4896       |
| Apprch %    | 16.4                    | 25.5 | 10.5 | 47.6 | 0                        | 99.5 | 0    | 0.5  | 0                       | 0.2  | 0    | 99.8 | 21.8                     | 76.9 | 0    | 1.2  |            |
| Total %     | 3.8                     | 6    | 2.5  | 11.2 | 0                        | 18.9 | 0    | 0.1  | 0                       | 0    | 0    | 8.5  | 10.7                     | 37.7 | 0    | 0.6  |            |

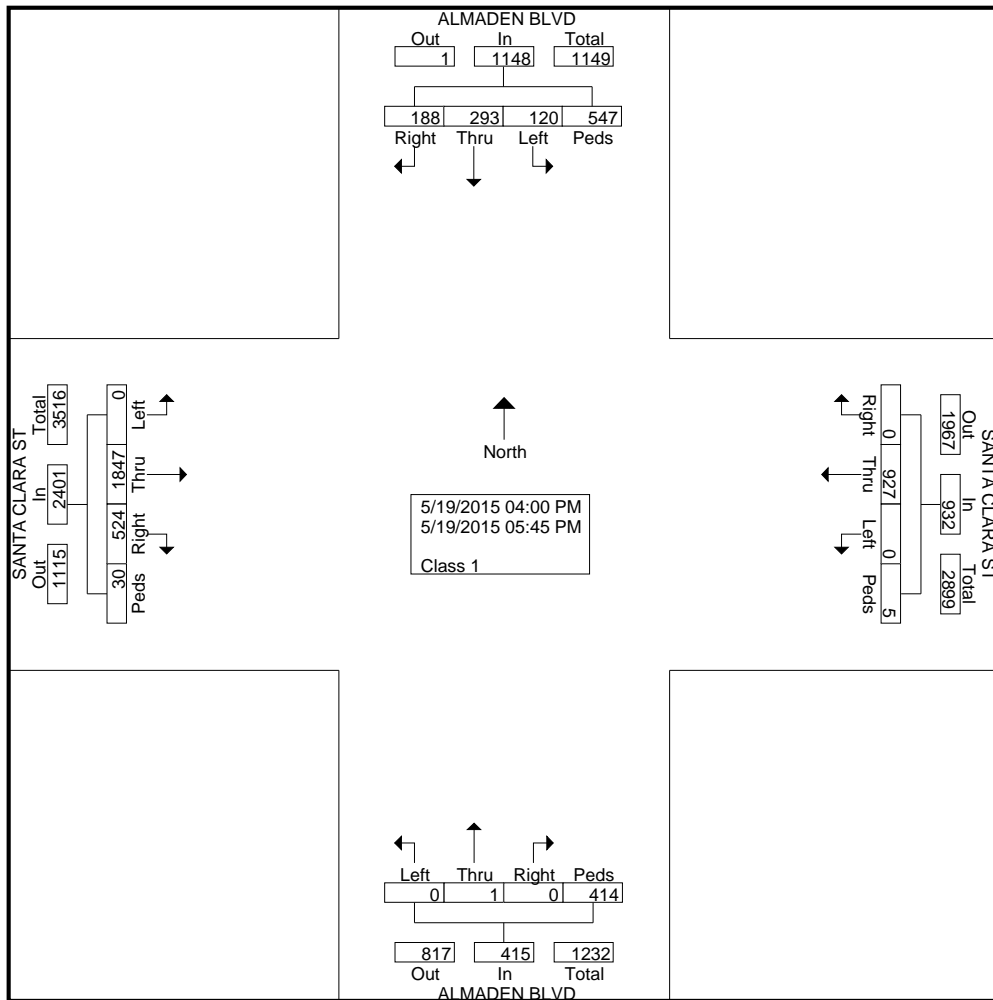

File Name : #62 ALMADEN&SANTA CLARA PM  
 Site Code :  
 Start Date : 5/19/2015  
 Page No : 2

| Start Time  | ALMADEN BLVD Southbound |      |      |      |            | SANTA CLARA ST Westbound |      |      |      |            | ALMADEN BLVD Northbound |      |      |      |            | SANTA CLARA ST Eastbound |      |      |      |            | Int. Total |
|---|-------------------------|------|------|------|------------|--------------------------|------|------|------|------------|-------------------------|------|------|------|------------|--------------------------|------|------|------|------------|------------|
|   | Right                   | Thru | Left | Peds | App. Total | Right                    | Thru | Left | Peds | App. Total | Right                   | Thru | Left | Peds | App. Total | Right                    | Thru | Left | Peds | App. Total |            |
| <b>Peak Hour Analysis From 04:00 PM to 05:45 PM - Peak 1 of 1</b> |                         |      |      |      |            |                          |      |      |      |            |                         |      |      |      |            |                          |      |      |      |            |            |
| Peak Hour for Entire Intersection Begins at 05:00 PM              |                         |      |      |      |            |                          |      |      |      |            |                         |      |      |      |            |                          |      |      |      |            |            |
| 05:00 PM  | 29                      | 61   | 24   | 67   | 181        | 0                        | 130  | 0    | 0    | 130        | 0                       | 1    | 0    | 63   | 64         | 79                       | 239  | 0    | 1    | 319        | 694        |
| 05:15 PM  | 32                      | 34   | 16   | 91   | 173        | 0                        | 133  | 0    | 2    | 135        | 0                       | 0    | 0    | 68   | 68         | 78                       | 260  | 0    | 3    | 341        | 717        |
| 05:30 PM  | 28                      | 45   | 7    | 103  | 183        | 0                        | 103  | 0    | 0    | 103        | 0                       | 0    | 0    | 87   | 87         | 62                       | 251  | 0    | 3    | 316        | 689        |
| 05:45 PM  | 21                      | 30   | 15   | 100  | 166        | 0                        | 111  | 0    | 0    | 111        | 0                       | 0    | 0    | 108  | 108        | 75                       | 275  | 0    | 2    | 352        | 737        |
| Total Volume  | 110                     | 170  | 62   | 361  | 703        | 0                        | 477  | 0    | 2    | 479        | 0                       | 1    | 0    | 326  | 327        | 294                      | 1025 | 0    | 9    | 1328       | 2837       |
| % App. Total  | 15.6                    | 24.2 | 8.8  | 51.4 |            | 0                        | 99.6 | 0    | 0.4  |            | 0                       | 0.3  | 0    | 99.7 |            | 22.1                     | 77.2 | 0    | 0.7  |            |            |
| PHF   | .859                    | .697 | .646 | .876 | .960       | .000                     | .897 | .000 | .250 | .887       | .000                    | .250 | .000 | .755 | .757       | .930                     | .932 | .000 | .750 | .943       | .962       |

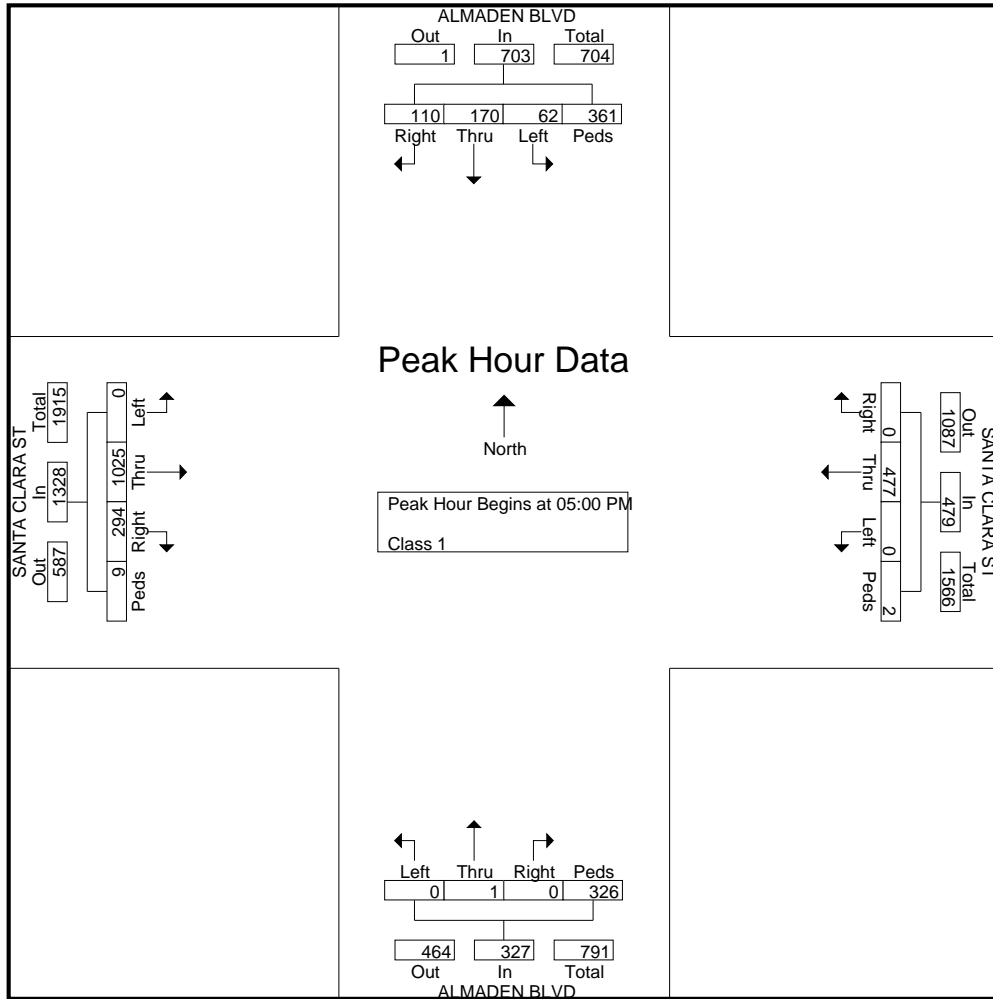



Groups Printed- Class 1

| Start Time  | N KING RD Southbound |      |      |      | ALUM ROCK AVE Westbound |      |      |      | N KING RD Northbound |      |      |      | ALUM ROCK AVE Eastbound |      |      |      | Int. Total |
|-------------|----------------------|------|------|------|-------------------------|------|------|------|----------------------|------|------|------|-------------------------|------|------|------|------------|
|             | Right                | Thru | Left | Peds | Right                   | Thru | Left | Peds | Right                | Thru | Left | Peds | Right                   | Thru | Left | Peds |            |
| 07:00 AM    | 14                   | 56   | 6    | 0    | 13                      | 111  | 2    | 4    | 9                    | 107  | 41   | 8    | 14                      | 41   | 12   | 0    | 438        |
| 07:15 AM    | 15                   | 43   | 7    | 0    | 23                      | 140  | 10   | 3    | 9                    | 120  | 43   | 2    | 11                      | 52   | 15   | 0    | 493        |
| 07:30 AM    | 12                   | 79   | 7    | 1    | 18                      | 138  | 25   | 1    | 25                   | 180  | 43   | 9    | 25                      | 57   | 14   | 0    | 634        |
| 07:45 AM    | 18                   | 103  | 17   | 3    | 18                      | 150  | 19   | 4    | 44                   | 175  | 44   | 4    | 29                      | 63   | 11   | 0    | 702        |
| Total       | 59                   | 281  | 37   | 4    | 72                      | 539  | 56   | 12   | 87                   | 582  | 171  | 23   | 79                      | 213  | 52   | 0    | 2267       |
| 08:00 AM    | 5                    | 67   | 14   | 7    | 8                       | 132  | 27   | 2    | 40                   | 133  | 43   | 6    | 30                      | 69   | 9    | 0    | 592        |
| 08:15 AM    | 17                   | 56   | 5    | 3    | 12                      | 94   | 12   | 1    | 39                   | 133  | 38   | 4    | 16                      | 48   | 11   | 0    | 489        |
| 08:30 AM    | 12                   | 46   | 14   | 7    | 11                      | 102  | 7    | 6    | 23                   | 114  | 42   | 5    | 17                      | 51   | 15   | 0    | 472        |
| 08:45 AM    | 6                    | 46   | 8    | 4    | 9                       | 97   | 19   | 0    | 22                   | 98   | 34   | 7    | 7                       | 61   | 16   | 1    | 435        |
| Total       | 40                   | 215  | 41   | 21   | 40                      | 425  | 65   | 9    | 124                  | 478  | 157  | 22   | 70                      | 229  | 51   | 1    | 1988       |
| Grand Total | 99                   | 496  | 78   | 25   | 112                     | 964  | 121  | 21   | 211                  | 1060 | 328  | 45   | 149                     | 442  | 103  | 1    | 4255       |
| Apprch %    | 14.2                 | 71.1 | 11.2 | 3.6  | 9.2                     | 79.1 | 9.9  | 1.7  | 12.8                 | 64.5 | 20   | 2.7  | 21.4                    | 63.6 | 14.8 | 0.1  |            |
| Total %     | 2.3                  | 11.7 | 1.8  | 0.6  | 2.6                     | 22.7 | 2.8  | 0.5  | 5                    | 24.9 | 7.7  | 1.1  | 3.5                     | 10.4 | 2.4  | 0    |            |

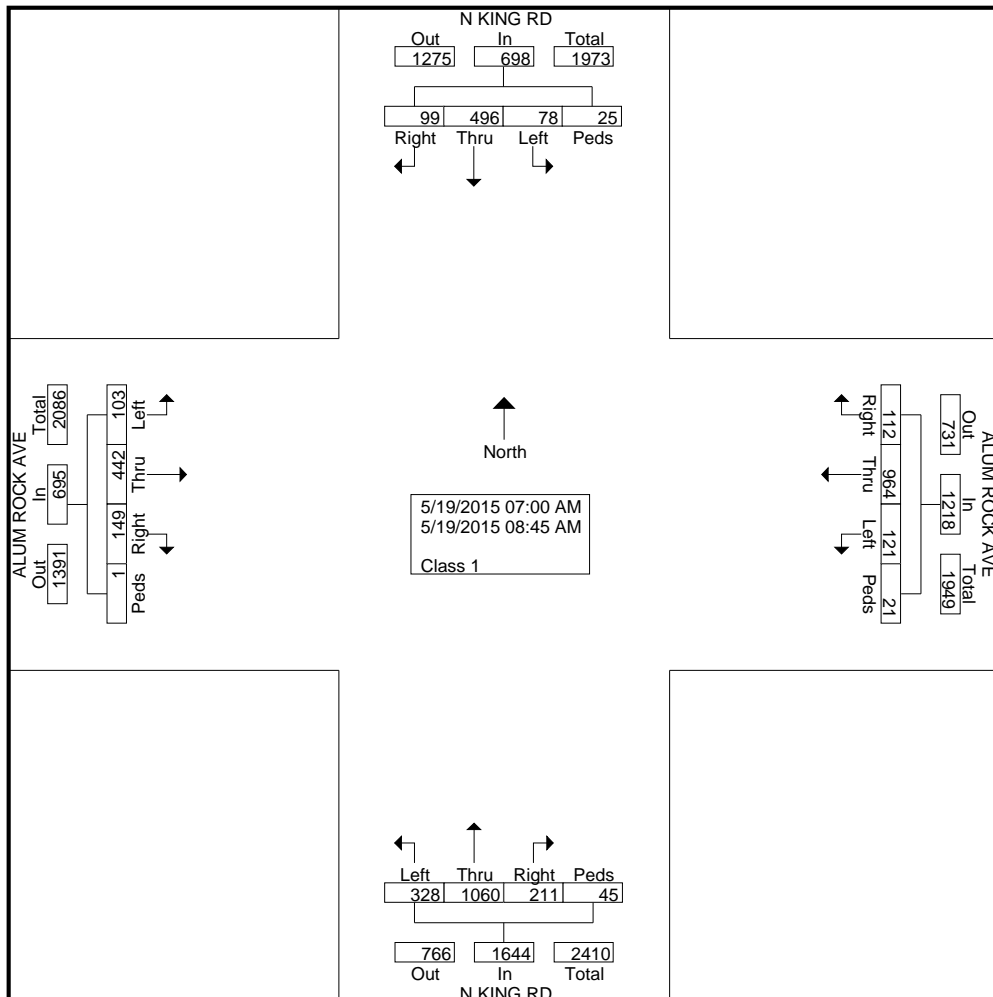

| Start Time  | N KING RD Southbound |      |      |      |            | ALUM ROCK AVE Westbound |      |      |      |            | N KING RD Northbound |      |      |      |            | ALUM ROCK AVE Eastbound |      |      |      |            | Int. Total |
|---|----------------------|------|------|------|------------|-------------------------|------|------|------|------------|----------------------|------|------|------|------------|-------------------------|------|------|------|------------|------------|
|   | Right                | Thru | Left | Peds | App. Total | Right                   | Thru | Left | Peds | App. Total | Right                | Thru | Left | Peds | App. Total | Right                   | Thru | Left | Peds | App. Total |            |
| <b>Peak Hour Analysis From 07:00 AM to 08:45 AM - Peak 1 of 1</b> |                      |      |      |      |            |                         |      |      |      |            |                      |      |      |      |            |                         |      |      |      |            |            |
| Peak Hour for Entire Intersection Begins at 07:15 AM              |                      |      |      |      |            |                         |      |      |      |            |                      |      |      |      |            |                         |      |      |      |            |            |
| 07:15 AM  | 15                   | 43   | 7    | 0    | 65         | 23                      | 140  | 10   | 3    | 176        | 9                    | 120  | 43   | 2    | 174        | 11                      | 52   | 15   | 0    | 78         | 493        |
| 07:30 AM  | 12                   | 79   | 7    | 1    | 99         | 18                      | 138  | 25   | 1    | 182        | 25                   | 180  | 43   | 9    | 257        | 25                      | 57   | 14   | 0    | 96         | 634        |
| 07:45 AM  | 18                   | 103  | 17   | 3    | 141        | 18                      | 150  | 19   | 4    | 191        | 44                   | 175  | 44   | 4    | 267        | 29                      | 63   | 11   | 0    | 103        | 702        |
| 08:00 AM  | 5                    | 67   | 14   | 7    | 93         | 8                       | 132  | 27   | 2    | 169        | 40                   | 133  | 43   | 6    | 222        | 30                      | 69   | 9    | 0    | 108        | 592        |
| Total Volume  | 50                   | 292  | 45   | 11   | 398        | 67                      | 560  | 81   | 10   | 718        | 118                  | 608  | 173  | 21   | 920        | 95                      | 241  | 49   | 0    | 385        | 2421       |
| % App. Total  | 12.6                 | 73.4 | 11.3 | 2.8  |            | 9.3                     | 78   | 11.3 | 1.4  |            | 12.8                 | 66.1 | 18.8 | 2.3  |            | 24.7                    | 62.6 | 12.7 | 0    |            |            |
| PHF   | .694                 | .709 | .662 | .393 | .706       | .728                    | .933 | .750 | .625 | .940       | .670                 | .844 | .983 | .583 | .861       | .792                    | .873 | .817 | .000 | .891       | .862       |

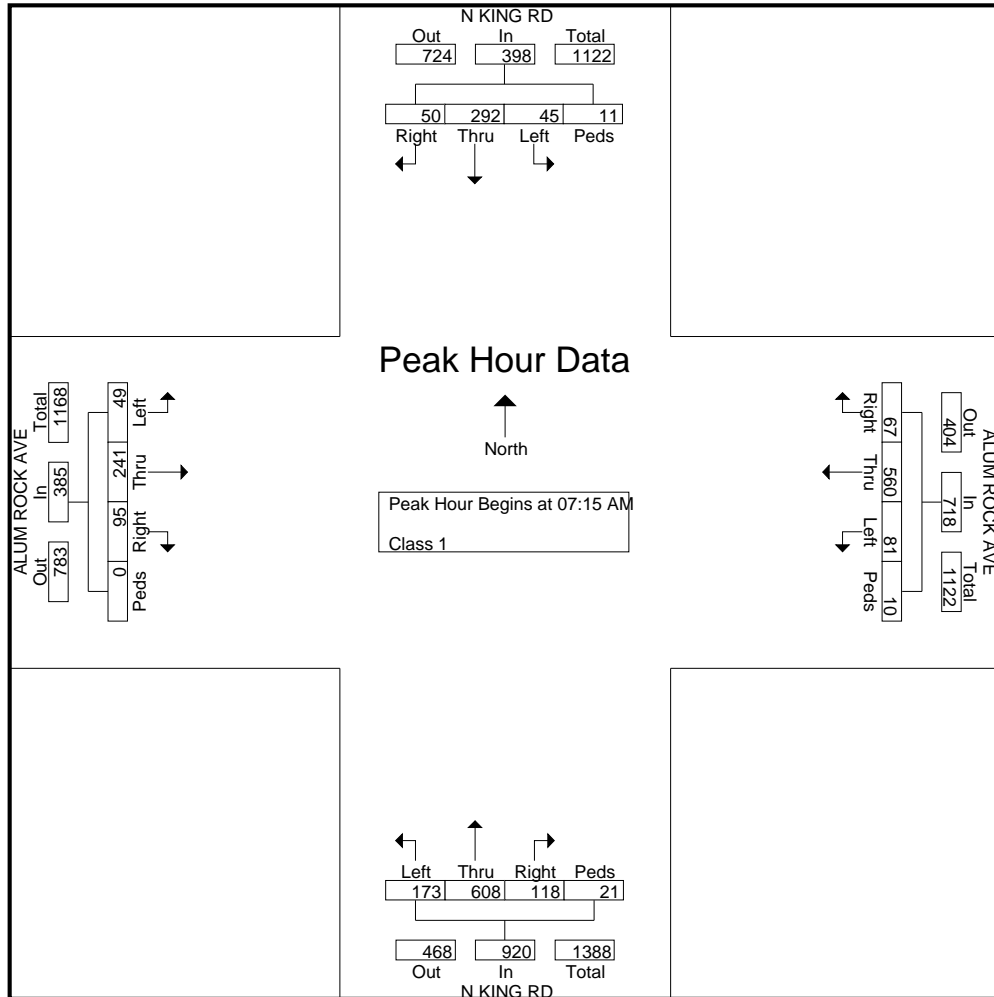

Groups Printed- Class 1

| Start Time  | N KING RD Southbound |      |      |      | STORY RD Westbound |      |      |      | N KING RD Northbound |      |      |      | STORY RD Eastbound |      |      |      | Int. Total |
|-------------|----------------------|------|------|------|--------------------|------|------|------|----------------------|------|------|------|--------------------|------|------|------|------------|
|             | Right                | Thru | Left | Peds | Right              | Thru | Left | Peds | Right                | Thru | Left | Peds | Right              | Thru | Left | Peds |            |
| 07:00 AM    | 55                   | 71   | 15   | 5    | 35                 | 151  | 9    | 10   | 9                    | 191  | 38   | 12   | 39                 | 33   | 99   | 0    | 772        |
| 07:15 AM    | 98                   | 142  | 29   | 0    | 54                 | 167  | 15   | 17   | 10                   | 229  | 52   | 15   | 54                 | 83   | 146  | 6    | 1117       |
| 07:30 AM    | 133                  | 138  | 48   | 4    | 85                 | 218  | 22   | 16   | 3                    | 134  | 33   | 5    | 41                 | 90   | 191  | 4    | 1165       |
| 07:45 AM    | 113                  | 152  | 61   | 1    | 48                 | 174  | 26   | 7    | 5                    | 132  | 51   | 13   | 49                 | 145  | 200  | 1    | 1178       |
| Total       | 399                  | 503  | 153  | 10   | 222                | 710  | 72   | 50   | 27                   | 686  | 174  | 45   | 183                | 351  | 636  | 11   | 4232       |
| 08:00 AM    | 81                   | 117  | 60   | 2    | 37                 | 170  | 16   | 14   | 19                   | 208  | 36   | 4    | 44                 | 106  | 130  | 3    | 1047       |
| 08:15 AM    | 97                   | 98   | 36   | 1    | 54                 | 197  | 24   | 10   | 11                   | 205  | 51   | 1    | 28                 | 120  | 116  | 2    | 1051       |
| 08:30 AM    | 74                   | 101  | 38   | 2    | 57                 | 145  | 36   | 7    | 14                   | 207  | 59   | 2    | 36                 | 111  | 118  | 3    | 1010       |
| 08:45 AM    | 73                   | 79   | 37   | 4    | 37                 | 159  | 32   | 7    | 9                    | 147  | 54   | 4    | 26                 | 97   | 102  | 4    | 871        |
| Total       | 325                  | 395  | 171  | 9    | 185                | 671  | 108  | 38   | 53                   | 767  | 200  | 11   | 134                | 434  | 466  | 12   | 3979       |
| Grand Total | 724                  | 898  | 324  | 19   | 407                | 1381 | 180  | 88   | 80                   | 1453 | 374  | 56   | 317                | 785  | 1102 | 23   | 8211       |
| Apprch %    | 36.8                 | 45.7 | 16.5 | 1    | 19.8               | 67.2 | 8.8  | 4.3  | 4.1                  | 74   | 19.1 | 2.9  | 14.2               | 35.2 | 49.5 | 1    |            |
| Total %     | 8.8                  | 10.9 | 3.9  | 0.2  | 5                  | 16.8 | 2.2  | 1.1  | 1                    | 17.7 | 4.6  | 0.7  | 3.9                | 9.6  | 13.4 | 0.3  |            |

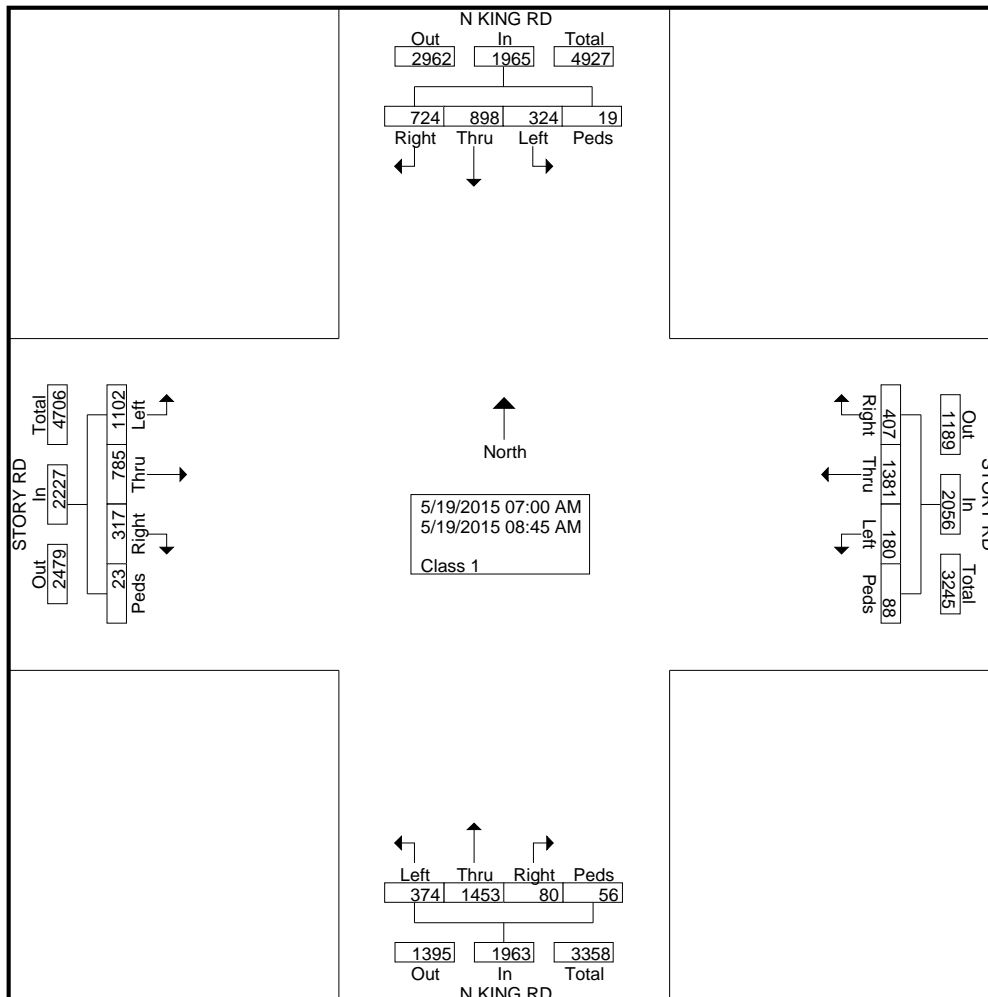

| Start Time  | N KING RD Southbound |      |      |      |            | STORY RD Westbound |      |      |      |            | N KING RD Northbound |      |      |      |            | STORY RD Eastbound |      |      |      |            | Int. Total |
|---|----------------------|------|------|------|------------|--------------------|------|------|------|------------|----------------------|------|------|------|------------|--------------------|------|------|------|------------|------------|
|   | Right                | Thru | Left | Peds | App. Total | Right              | Thru | Left | Peds | App. Total | Right                | Thru | Left | Peds | App. Total | Right              | Thru | Left | Peds | App. Total |            |
| <b>Peak Hour Analysis From 07:00 AM to 08:45 AM - Peak 1 of 1</b> |                      |      |      |      |            |                    |      |      |      |            |                      |      |      |      |            |                    |      |      |      |            |            |
| Peak Hour for Entire Intersection Begins at 07:15 AM              |                      |      |      |      |            |                    |      |      |      |            |                      |      |      |      |            |                    |      |      |      |            |            |
| 07:15 AM  | 98                   | 142  | 29   | 0    | 269        | 54                 | 167  | 15   | 17   | 253        | 10                   | 229  | 52   | 15   | 306        | 54                 | 83   | 146  | 6    | 289        | 1117       |
| 07:30 AM  | 133                  | 138  | 48   | 4    | 323        | 85                 | 218  | 22   | 16   | 341        | 3                    | 134  | 33   | 5    | 175        | 41                 | 90   | 191  | 4    | 326        | 1165       |
| 07:45 AM  | 113                  | 152  | 61   | 1    | 327        | 48                 | 174  | 26   | 7    | 255        | 5                    | 132  | 51   | 13   | 201        | 49                 | 145  | 200  | 1    | 395        | 1178       |
| 08:00 AM  | 81                   | 117  | 60   | 2    | 260        | 37                 | 170  | 16   | 14   | 237        | 19                   | 208  | 36   | 4    | 267        | 44                 | 106  | 130  | 3    | 283        | 1047       |
| Total Volume  | 425                  | 549  | 198  | 7    | 1179       | 224                | 729  | 79   | 54   | 1086       | 37                   | 703  | 172  | 37   | 949        | 188                | 424  | 667  | 14   | 1293       | 4507       |
| % App. Total  | 36                   | 46.6 | 16.8 | 0.6  |            | 20.6               | 67.1 | 7.3  | 5    |            | 3.9                  | 74.1 | 18.1 | 3.9  |            | 14.5               | 32.8 | 51.6 | 1.1  |            |            |
| PHF   | .799                 | .903 | .811 | .438 | .901       | .659               | .836 | .760 | .794 | .796       | .487                 | .767 | .827 | .617 | .775       | .870               | .731 | .834 | .583 | .818       | .956       |

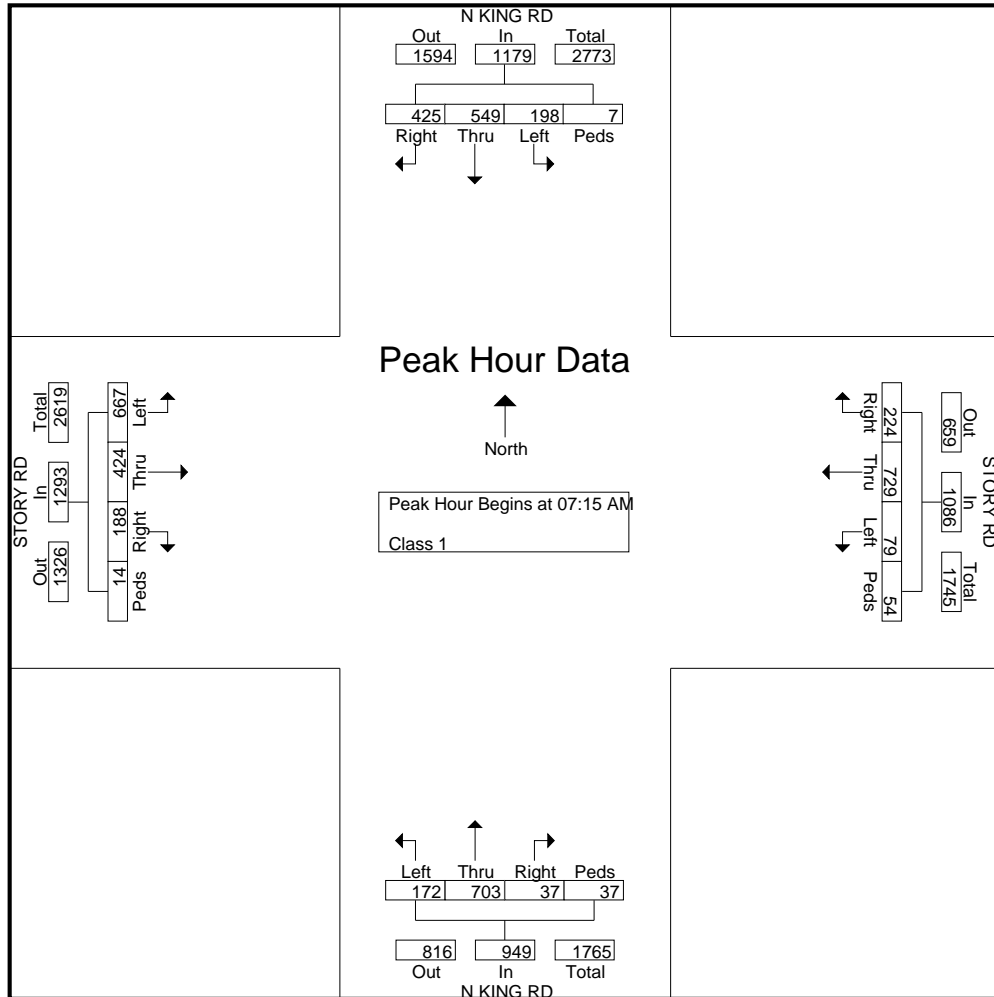

Groups Printed- Class 1

| Start Time  | N KING RD Southbound |      |      |      | STORY RD Westbound |      |      |      | N KING RD Northbound |      |      |      | STORY RD Eastbound |      |      |      | Int. Total |
|-------------|----------------------|------|------|------|--------------------|------|------|------|----------------------|------|------|------|--------------------|------|------|------|------------|
|             | Right                | Thru | Left | Peds | Right              | Thru | Left | Peds | Right                | Thru | Left | Peds | Right              | Thru | Left | Peds |            |
| 04:00 PM    | 138                  | 222  | 58   | 4    | 34                 | 140  | 68   | 25   | 9                    | 165  | 71   | 11   | 68                 | 181  | 97   | 12   | 1303       |
| 04:15 PM    | 107                  | 231  | 89   | 9    | 34                 | 138  | 65   | 24   | 16                   | 170  | 92   | 16   | 70                 | 234  | 131  | 10   | 1436       |
| 04:30 PM    | 119                  | 198  | 56   | 6    | 44                 | 170  | 52   | 16   | 10                   | 123  | 73   | 15   | 46                 | 150  | 119  | 9    | 1206       |
| 04:45 PM    | 90                   | 197  | 44   | 3    | 32                 | 167  | 52   | 10   | 2                    | 109  | 58   | 19   | 64                 | 197  | 124  | 10   | 1178       |
| Total       | 454                  | 848  | 247  | 22   | 144                | 615  | 237  | 75   | 37                   | 567  | 294  | 61   | 248                | 762  | 471  | 41   | 5123       |
| 05:00 PM    | 107                  | 223  | 61   | 6    | 29                 | 188  | 79   | 26   | 5                    | 159  | 62   | 18   | 37                 | 195  | 122  | 8    | 1325       |
| 05:15 PM    | 105                  | 204  | 64   | 3    | 34                 | 145  | 53   | 22   | 8                    | 127  | 61   | 23   | 70                 | 224  | 115  | 9    | 1267       |
| 05:30 PM    | 121                  | 197  | 51   | 12   | 26                 | 149  | 43   | 26   | 13                   | 149  | 67   | 43   | 51                 | 188  | 127  | 6    | 1269       |
| 05:45 PM    | 98                   | 193  | 40   | 7    | 36                 | 166  | 70   | 17   | 18                   | 140  | 70   | 26   | 58                 | 202  | 130  | 11   | 1282       |
| Total       | 431                  | 817  | 216  | 28   | 125                | 648  | 245  | 91   | 44                   | 575  | 260  | 110  | 216                | 809  | 494  | 34   | 5143       |
| Grand Total | 885                  | 1665 | 463  | 50   | 269                | 1263 | 482  | 166  | 81                   | 1142 | 554  | 171  | 464                | 1571 | 965  | 75   | 10266      |
| Apprch %    | 28.9                 | 54.4 | 15.1 | 1.6  | 12.3               | 57.9 | 22.1 | 7.6  | 4.2                  | 58.6 | 28.4 | 8.8  | 15.1               | 51.1 | 31.4 | 2.4  |            |
| Total %     | 8.6                  | 16.2 | 4.5  | 0.5  | 2.6                | 12.3 | 4.7  | 1.6  | 0.8                  | 11.1 | 5.4  | 1.7  | 4.5                | 15.3 | 9.4  | 0.7  |            |

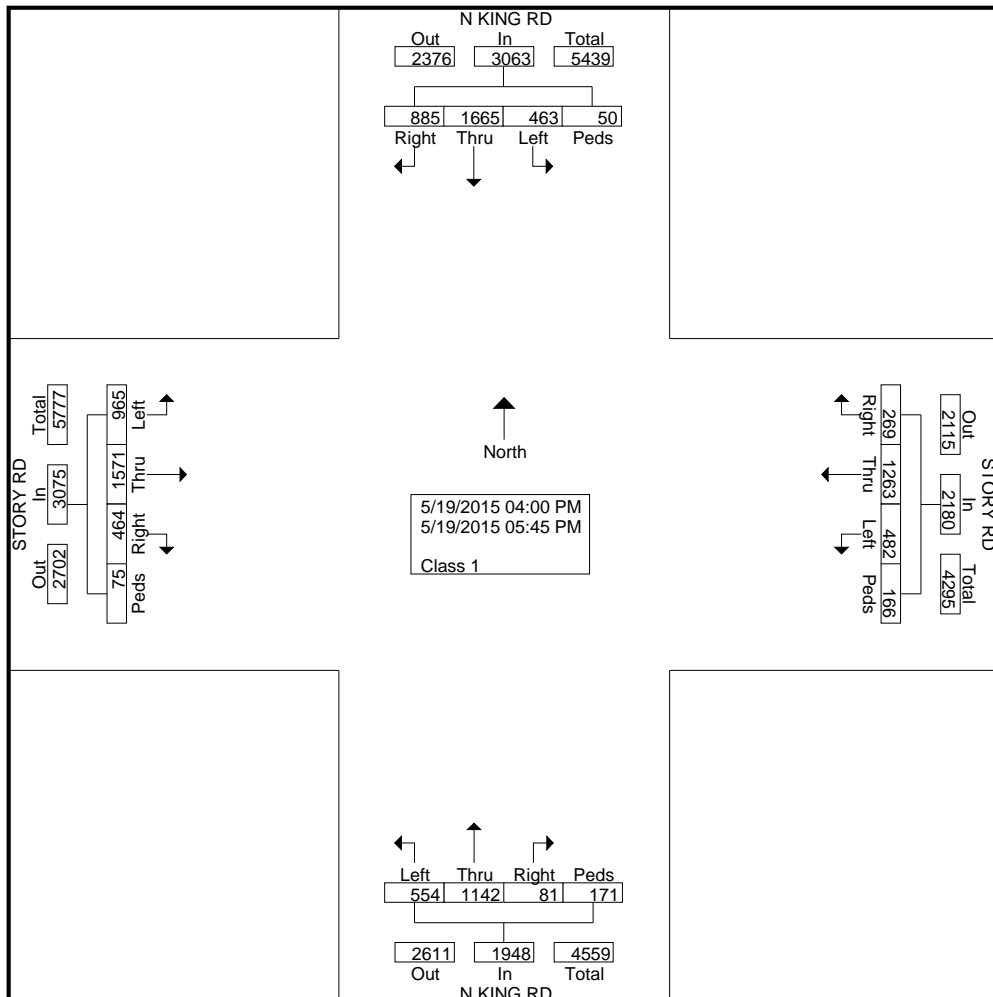

| Start Time  | N KING RD Southbound |      |      |      |            | STORY RD Westbound |      |      |      |            | N KING RD Northbound |      |      |      |            | STORY RD Eastbound |      |      |      |            | Int. Total |
|---|----------------------|------|------|------|------------|--------------------|------|------|------|------------|----------------------|------|------|------|------------|--------------------|------|------|------|------------|------------|
|   | Right                | Thru | Left | Peds | App. Total | Right              | Thru | Left | Peds | App. Total | Right                | Thru | Left | Peds | App. Total | Right              | Thru | Left | Peds | App. Total |            |
| <b>Peak Hour Analysis From 04:00 PM to 05:45 PM - Peak 1 of 1</b> |                      |      |      |      |            |                    |      |      |      |            |                      |      |      |      |            |                    |      |      |      |            |            |
| Peak Hour for Entire Intersection Begins at 04:15 PM              |                      |      |      |      |            |                    |      |      |      |            |                      |      |      |      |            |                    |      |      |      |            |            |
| 04:15 PM  | 107                  | 231  | 89   | 9    | 436        | 34                 | 138  | 65   | 24   | 261        | 16                   | 170  | 92   | 16   | 294        | 70                 | 234  | 131  | 10   | 445        | 1436       |
| 04:30 PM  | 119                  | 198  | 56   | 6    | 379        | 44                 | 170  | 52   | 16   | 282        | 10                   | 123  | 73   | 15   | 221        | 46                 | 150  | 119  | 9    | 324        | 1206       |
| 04:45 PM  | 90                   | 197  | 44   | 3    | 334        | 32                 | 167  | 52   | 10   | 261        | 2                    | 109  | 58   | 19   | 188        | 64                 | 197  | 124  | 10   | 395        | 1178       |
| 05:00 PM  | 107                  | 223  | 61   | 6    | 397        | 29                 | 188  | 79   | 26   | 322        | 5                    | 159  | 62   | 18   | 244        | 37                 | 195  | 122  | 8    | 362        | 1325       |
| Total Volume  | 423                  | 849  | 250  | 24   | 1546       | 139                | 663  | 248  | 76   | 1126       | 33                   | 561  | 285  | 68   | 947        | 217                | 776  | 496  | 37   | 1526       | 5145       |
| % App. Total  | 27.4                 | 54.9 | 16.2 | 1.6  |            | 12.3               | 58.9 | 22   | 6.7  |            | 3.5                  | 59.2 | 30.1 | 7.2  |            | 14.2               | 50.9 | 32.5 | 2.4  |            |            |
| PHF   | .889                 | .919 | .702 | .667 | .886       | .790               | .882 | .785 | .731 | .874       | .516                 | .825 | .774 | .895 | .805       | .775               | .829 | .947 | .925 | .857       | .896       |

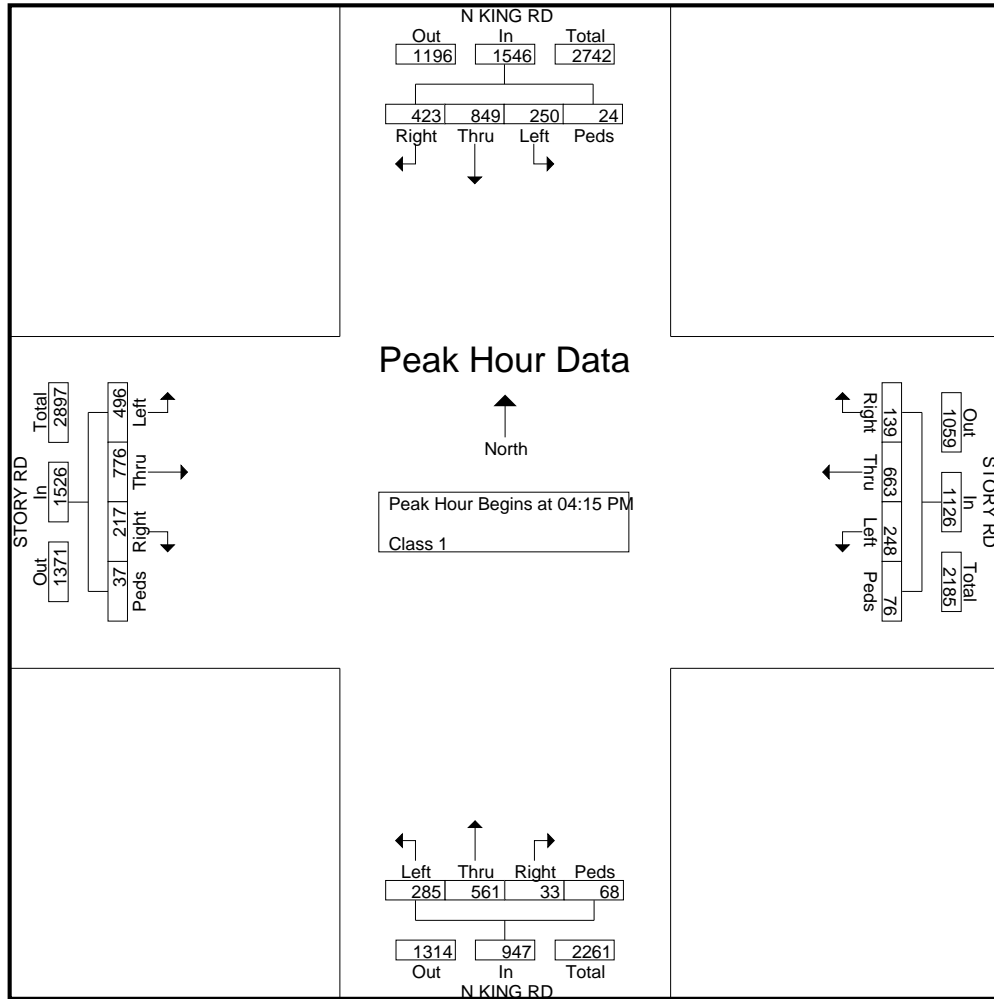

Groups Printed- Class 1

| Start Time  | N 11TH ST Southbound |      |      |      | E JULIAN ST Westbound |      |      |      | N 11TH ST Northbound |      |      |      | E JULIAN ST Eastbound |      |      |      | Int. Total |
|-------------|----------------------|------|------|------|-----------------------|------|------|------|----------------------|------|------|------|-----------------------|------|------|------|------------|
|             | Right                | Thru | Left | Peds | Right                 | Thru | Left | Peds | Right                | Thru | Left | Peds | Right                 | Thru | Left | Peds |            |
| 07:00 AM    | 0                    | 0    | 0    | 0    | 20                    | 96   | 0    | 0    | 6                    | 165  | 9    | 5    | 0                     | 39   | 4    | 2    | 346        |
| 07:15 AM    | 0                    | 0    | 0    | 0    | 31                    | 134  | 0    | 1    | 10                   | 235  | 17   | 3    | 0                     | 38   | 4    | 2    | 475        |
| 07:30 AM    | 0                    | 0    | 0    | 2    | 31                    | 131  | 0    | 2    | 13                   | 260  | 9    | 6    | 0                     | 61   | 8    | 1    | 524        |
| 07:45 AM    | 0                    | 0    | 0    | 1    | 27                    | 136  | 0    | 0    | 12                   | 236  | 10   | 4    | 0                     | 54   | 6    | 0    | 486        |
| Total       | 0                    | 0    | 0    | 3    | 109                   | 497  | 0    | 3    | 41                   | 896  | 45   | 18   | 0                     | 192  | 22   | 5    | 1831       |
| 08:00 AM    | 0                    | 0    | 0    | 0    | 17                    | 135  | 0    | 0    | 4                    | 214  | 19   | 1    | 0                     | 50   | 5    | 1    | 446        |
| 08:15 AM    | 0                    | 0    | 0    | 2    | 27                    | 124  | 0    | 2    | 10                   | 219  | 9    | 1    | 0                     | 28   | 7    | 0    | 429        |
| 08:30 AM    | 0                    | 0    | 0    | 1    | 23                    | 129  | 0    | 0    | 7                    | 192  | 13   | 2    | 0                     | 29   | 6    | 0    | 402        |
| 08:45 AM    | 0                    | 0    | 0    | 4    | 20                    | 111  | 0    | 0    | 10                   | 181  | 13   | 1    | 0                     | 29   | 3    | 0    | 372        |
| Total       | 0                    | 0    | 0    | 7    | 87                    | 499  | 0    | 2    | 31                   | 806  | 54   | 5    | 0                     | 136  | 21   | 1    | 1649       |
| Grand Total | 0                    | 0    | 0    | 10   | 196                   | 996  | 0    | 5    | 72                   | 1702 | 99   | 23   | 0                     | 328  | 43   | 6    | 3480       |
| Apprch %    | 0                    | 0    | 0    | 100  | 16.4                  | 83.2 | 0    | 0.4  | 3.8                  | 89.8 | 5.2  | 1.2  | 0                     | 87   | 11.4 | 1.6  |            |
| Total %     | 0                    | 0    | 0    | 0.3  | 5.6                   | 28.6 | 0    | 0.1  | 2.1                  | 48.9 | 2.8  | 0.7  | 0                     | 9.4  | 1.2  | 0.2  |            |

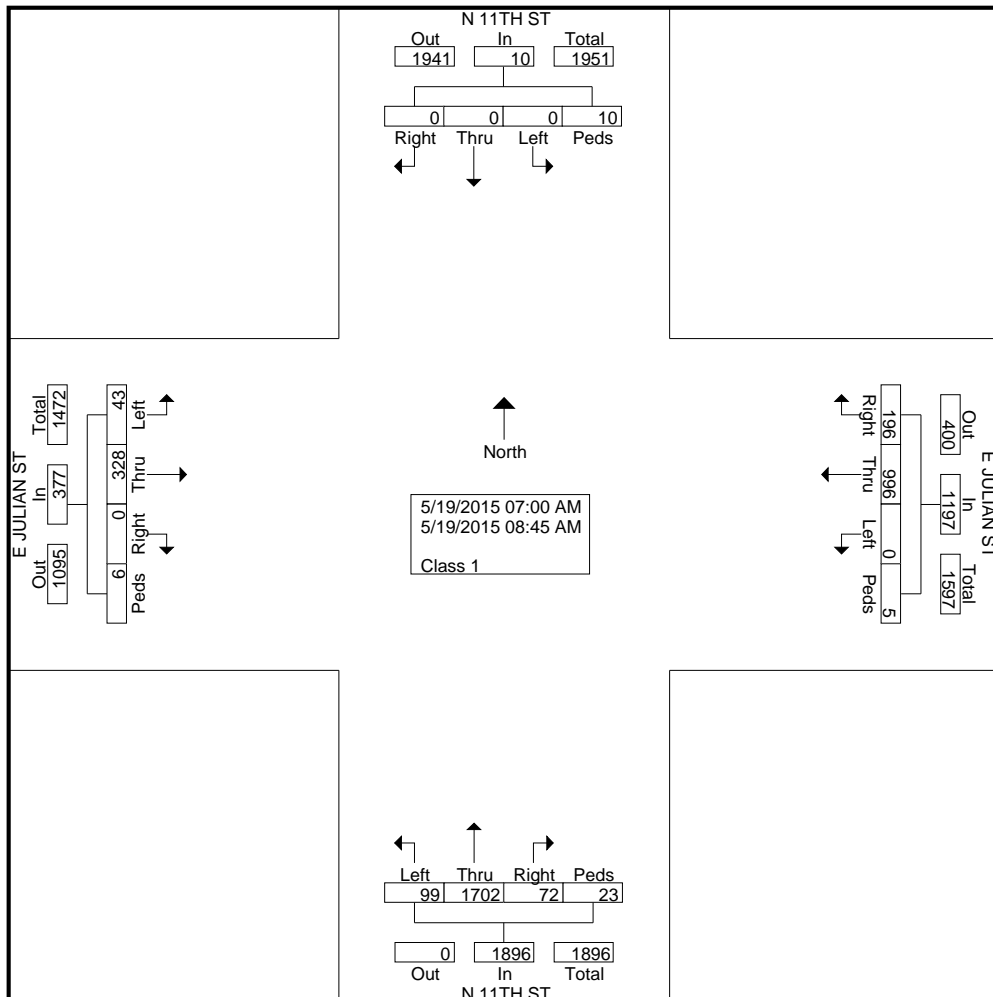

| Start Time  | N 11TH ST Southbound |      |      |      |            | E JULIAN ST Westbound |      |      |      |            | N 11TH ST Northbound |      |      |      |            | E JULIAN ST Eastbound |      |      |      |            | Int. Total |
|---|----------------------|------|------|------|------------|-----------------------|------|------|------|------------|----------------------|------|------|------|------------|-----------------------|------|------|------|------------|------------|
|   | Right                | Thru | Left | Peds | App. Total | Right                 | Thru | Left | Peds | App. Total | Right                | Thru | Left | Peds | App. Total | Right                 | Thru | Left | Peds | App. Total |            |
| <b>Peak Hour Analysis From 07:00 AM to 08:45 AM - Peak 1 of 1</b> |                      |      |      |      |            |                       |      |      |      |            |                      |      |      |      |            |                       |      |      |      |            |            |
| Peak Hour for Entire Intersection Begins at 07:15 AM              |                      |      |      |      |            |                       |      |      |      |            |                      |      |      |      |            |                       |      |      |      |            |            |
| 07:15 AM  | 0                    | 0    | 0    | 0    | 0          | 31                    | 134  | 0    | 1    | 166        | 10                   | 235  | 17   | 3    | 265        | 0                     | 38   | 4    | 2    | 44         | 475        |
| 07:30 AM  | 0                    | 0    | 0    | 2    | 2          | 31                    | 131  | 0    | 2    | 164        | 13                   | 260  | 9    | 6    | 288        | 0                     | 61   | 8    | 1    | 70         | 524        |
| 07:45 AM  | 0                    | 0    | 0    | 1    | 1          | 27                    | 136  | 0    | 0    | 163        | 12                   | 236  | 10   | 4    | 262        | 0                     | 54   | 6    | 0    | 60         | 486        |
| 08:00 AM  | 0                    | 0    | 0    | 0    | 0          | 17                    | 135  | 0    | 0    | 152        | 4                    | 214  | 19   | 1    | 238        | 0                     | 50   | 5    | 1    | 56         | 446        |
| Total Volume  | 0                    | 0    | 0    | 3    | 3          | 106                   | 536  | 0    | 3    | 645        | 39                   | 945  | 55   | 14   | 1053       | 0                     | 203  | 23   | 4    | 230        | 1931       |
| % App. Total  | 0                    | 0    | 0    | 100  |            | 16.4                  | 83.1 | 0    | 0.5  |            | 3.7                  | 89.7 | 5.2  | 1.3  |            | 0                     | 88.3 | 10   | 1.7  |            |            |
| PHF   | .000                 | .000 | .000 | .375 | .375       | .855                  | .985 | .000 | .375 | .971       | .750                 | .909 | .724 | .583 | .914       | .000                  | .832 | .719 | .500 | .821       | .921       |

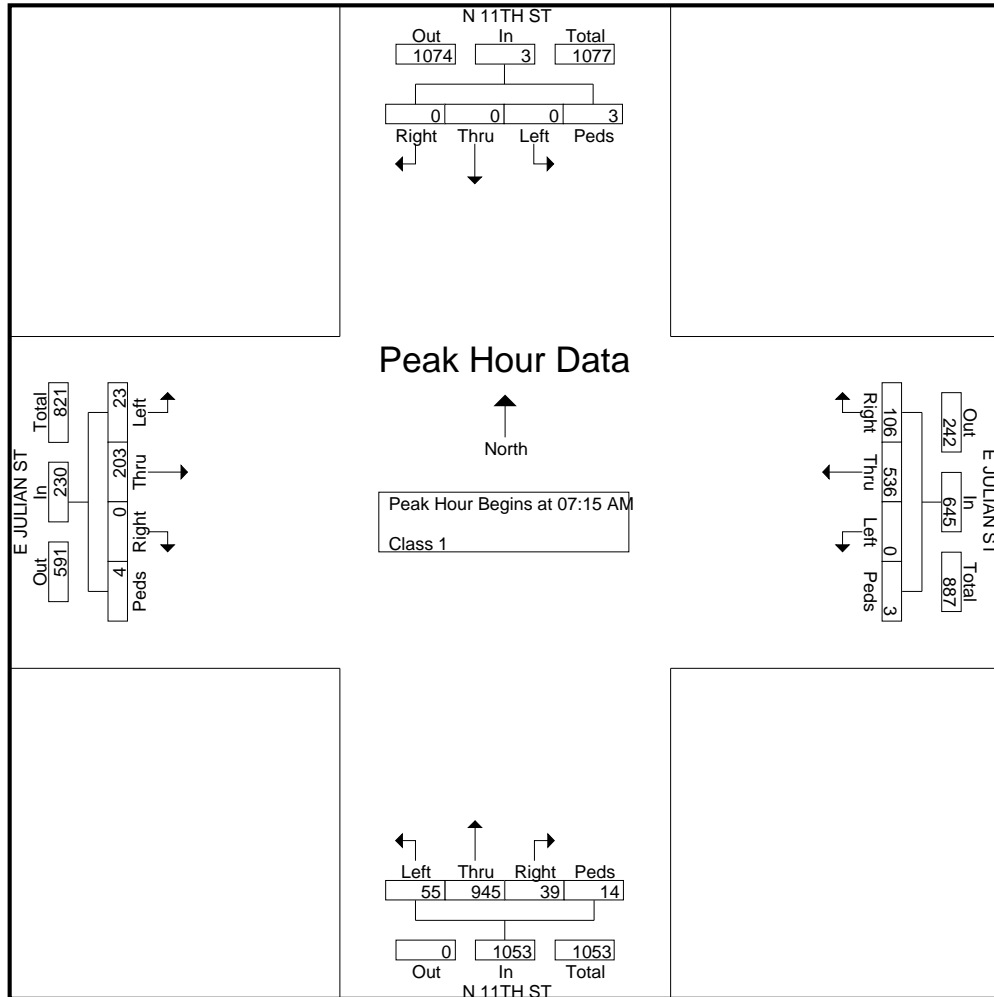



Groups Printed- Class 1

| Start Time  | N 11TH ST Southbound |      |      |      | E JULIAN ST Westbound |      |      |      | N 11TH ST Northbound |      |      |      | E JULIAN ST Eastbound |      |      |      | Int. Total |
|-------------|----------------------|------|------|------|-----------------------|------|------|------|----------------------|------|------|------|-----------------------|------|------|------|------------|
|             | Right                | Thru | Left | Peds | Right                 | Thru | Left | Peds | Right                | Thru | Left | Peds | Right                 | Thru | Left | Peds |            |
| 04:00 PM    | 0                    | 0    | 0    | 4    | 8                     | 57   | 0    | 1    | 10                   | 86   | 16   | 1    | 0                     | 71   | 8    | 1    | 263        |
| 04:15 PM    | 0                    | 0    | 0    | 0    | 7                     | 79   | 0    | 1    | 17                   | 80   | 20   | 0    | 0                     | 85   | 9    | 0    | 298        |
| 04:30 PM    | 0                    | 0    | 0    | 1    | 11                    | 80   | 1    | 1    | 20                   | 94   | 15   | 0    | 0                     | 66   | 12   | 0    | 301        |
| 04:45 PM    | 0                    | 0    | 0    | 1    | 3                     | 63   | 0    | 0    | 11                   | 95   | 12   | 0    | 0                     | 86   | 8    | 0    | 279        |
| Total       | 0                    | 0    | 0    | 6    | 29                    | 279  | 1    | 3    | 58                   | 355  | 63   | 1    | 0                     | 308  | 37   | 1    | 1141       |
| 05:00 PM    | 0                    | 0    | 0    | 4    | 7                     | 68   | 0    | 1    | 2                    | 119  | 12   | 1    | 0                     | 110  | 6    | 0    | 330        |
| 05:15 PM    | 0                    | 0    | 0    | 0    | 1                     | 81   | 0    | 1    | 11                   | 112  | 13   | 7    | 0                     | 103  | 6    | 1    | 336        |
| 05:30 PM    | 0                    | 0    | 0    | 0    | 9                     | 77   | 0    | 0    | 19                   | 92   | 24   | 2    | 0                     | 84   | 8    | 3    | 318        |
| 05:45 PM    | 0                    | 0    | 0    | 0    | 6                     | 78   | 0    | 0    | 15                   | 92   | 16   | 2    | 0                     | 92   | 9    | 5    | 315        |
| Total       | 0                    | 0    | 0    | 4    | 23                    | 304  | 0    | 2    | 47                   | 415  | 65   | 12   | 0                     | 389  | 29   | 9    | 1299       |
| Grand Total | 0                    | 0    | 0    | 10   | 52                    | 583  | 1    | 5    | 105                  | 770  | 128  | 13   | 0                     | 697  | 66   | 10   | 2440       |
| Apprch %    | 0                    | 0    | 0    | 100  | 8.1                   | 91   | 0.2  | 0.8  | 10.3                 | 75.8 | 12.6 | 1.3  | 0                     | 90.2 | 8.5  | 1.3  |            |
| Total %     | 0                    | 0    | 0    | 0.4  | 2.1                   | 23.9 | 0    | 0.2  | 4.3                  | 31.6 | 5.2  | 0.5  | 0                     | 28.6 | 2.7  | 0.4  |            |

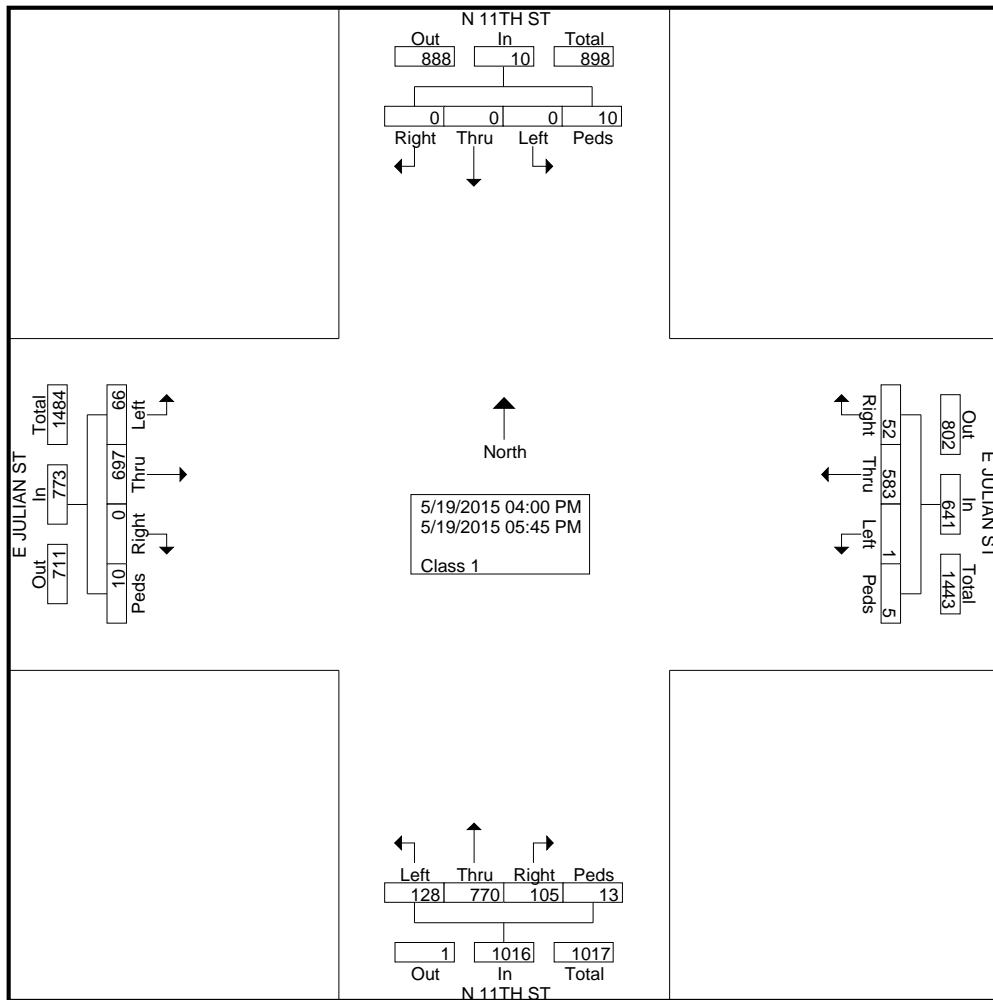

| Start Time  | N 11TH ST Southbound |      |      |      |            | E JULIAN ST Westbound |      |      |      |            | N 11TH ST Northbound |      |      |      |            | E JULIAN ST Eastbound |      |      |      |            | Int. Total |
|---|----------------------|------|------|------|------------|-----------------------|------|------|------|------------|----------------------|------|------|------|------------|-----------------------|------|------|------|------------|------------|
|   | Right                | Thru | Left | Peds | App. Total | Right                 | Thru | Left | Peds | App. Total | Right                | Thru | Left | Peds | App. Total | Right                 | Thru | Left | Peds | App. Total |            |
| <b>Peak Hour Analysis From 04:00 PM to 05:45 PM - Peak 1 of 1</b> |                      |      |      |      |            |                       |      |      |      |            |                      |      |      |      |            |                       |      |      |      |            |            |
| Peak Hour for Entire Intersection Begins at 05:00 PM              |                      |      |      |      |            |                       |      |      |      |            |                      |      |      |      |            |                       |      |      |      |            |            |
| 05:00 PM  | 0                    | 0    | 0    | 4    | 4          | 7                     | 68   | 0    | 1    | 76         | 2                    | 119  | 12   | 1    | 134        | 0                     | 110  | 6    | 0    | 116        | 330        |
| 05:15 PM  | 0                    | 0    | 0    | 0    | 0          | 1                     | 81   | 0    | 1    | 83         | 11                   | 112  | 13   | 7    | 143        | 0                     | 103  | 6    | 1    | 110        | 336        |
| 05:30 PM  | 0                    | 0    | 0    | 0    | 0          | 9                     | 77   | 0    | 0    | 86         | 19                   | 92   | 24   | 2    | 137        | 0                     | 84   | 8    | 3    | 95         | 318        |
| 05:45 PM  | 0                    | 0    | 0    | 0    | 0          | 6                     | 78   | 0    | 0    | 84         | 15                   | 92   | 16   | 2    | 125        | 0                     | 92   | 9    | 5    | 106        | 315        |
| Total Volume  | 0                    | 0    | 0    | 4    | 4          | 23                    | 304  | 0    | 2    | 329        | 47                   | 415  | 65   | 12   | 539        | 0                     | 389  | 29   | 9    | 427        | 1299       |
| % App. Total  | 0                    | 0    | 0    | 100  |            | 7                     | 92.4 | 0    | 0.6  |            | 8.7                  | 77   | 12.1 | 2.2  |            | 0                     | 91.1 | 6.8  | 2.1  |            |            |
| PHF   | .000                 | .000 | .000 | .250 | .250       | .639                  | .938 | .000 | .500 | .956       | .618                 | .872 | .677 | .429 | .942       | .000                  | .884 | .806 | .450 | .920       | .967       |

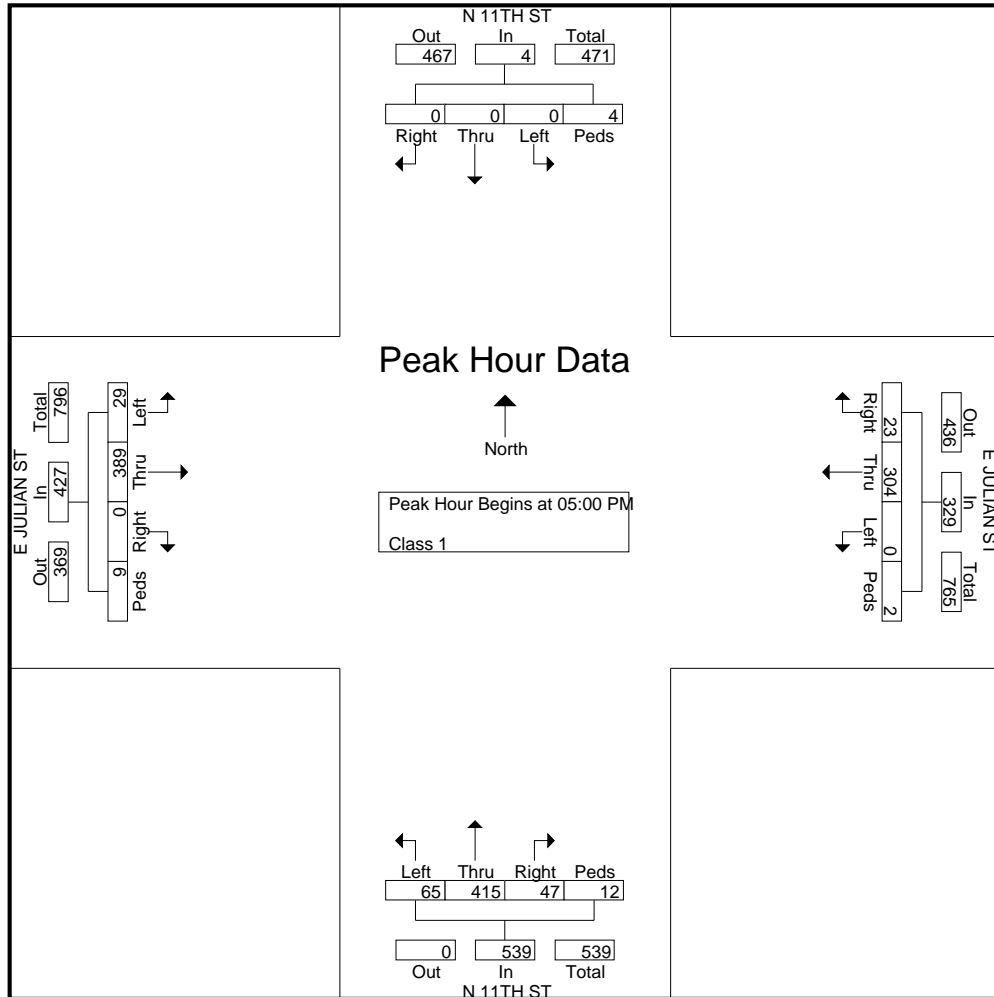

File Name : #76 11TH&SANTA CLARA AM  
 Site Code :  
 Start Date : 5/19/2015  
 Page No : 1

Groups Printed- Class 1

| Start Time  | N 11TH ST Southbound |      |      |      | E SANTA CLARA ST Westbound |      |      |      | N 11TH ST Northbound |      |      |      | E SANTA CLARA ST Eastbound |      |      |      | Int. Total |
|-------------|----------------------|------|------|------|----------------------------|------|------|------|----------------------|------|------|------|----------------------------|------|------|------|------------|
|             | Right                | Thru | Left | Peds | Right                      | Thru | Left | Peds | Right                | Thru | Left | Peds | Right                      | Thru | Left | Peds |            |
| 07:00 AM    | 1                    | 0    | 0    | 3    | 16                         | 120  | 0    | 0    | 23                   | 149  | 44   | 6    | 0                          | 37   | 9    | 4    | 412        |
| 07:15 AM    | 0                    | 0    | 0    | 3    | 28                         | 167  | 0    | 2    | 13                   | 223  | 54   | 3    | 0                          | 50   | 13   | 3    | 559        |
| 07:30 AM    | 0                    | 0    | 0    | 5    | 24                         | 215  | 0    | 1    | 17                   | 244  | 62   | 6    | 0                          | 63   | 14   | 2    | 653        |
| 07:45 AM    | 1                    | 0    | 0    | 2    | 31                         | 216  | 0    | 3    | 24                   | 217  | 85   | 4    | 0                          | 94   | 23   | 1    | 701        |
| Total       | 2                    | 0    | 0    | 13   | 99                         | 718  | 0    | 6    | 77                   | 833  | 245  | 19   | 0                          | 244  | 59   | 10   | 2325       |
| 08:00 AM    | 0                    | 0    | 0    | 2    | 24                         | 166  | 0    | 1    | 20                   | 190  | 69   | 3    | 0                          | 87   | 10   | 2    | 574        |
| 08:15 AM    | 0                    | 0    | 0    | 5    | 13                         | 138  | 0    | 2    | 25                   | 230  | 57   | 6    | 0                          | 49   | 14   | 3    | 542        |
| 08:30 AM    | 0                    | 0    | 0    | 5    | 23                         | 138  | 0    | 3    | 28                   | 159  | 48   | 6    | 0                          | 63   | 14   | 3    | 490        |
| 08:45 AM    | 0                    | 0    | 0    | 3    | 11                         | 172  | 0    | 0    | 27                   | 179  | 73   | 1    | 0                          | 62   | 9    | 10   | 547        |
| Total       | 0                    | 0    | 0    | 15   | 71                         | 614  | 0    | 6    | 100                  | 758  | 247  | 16   | 0                          | 261  | 47   | 18   | 2153       |
| Grand Total | 2                    | 0    | 0    | 28   | 170                        | 1332 | 0    | 12   | 177                  | 1591 | 492  | 35   | 0                          | 505  | 106  | 28   | 4478       |
| Apprch %    | 6.7                  | 0    | 0    | 93.3 | 11.2                       | 88   | 0    | 0.8  | 7.7                  | 69.3 | 21.4 | 1.5  | 0                          | 79   | 16.6 | 4.4  |            |
| Total %     | 0                    | 0    | 0    | 0.6  | 3.8                        | 29.7 | 0    | 0.3  | 4                    | 35.5 | 11   | 0.8  | 0                          | 11.3 | 2.4  | 0.6  |            |

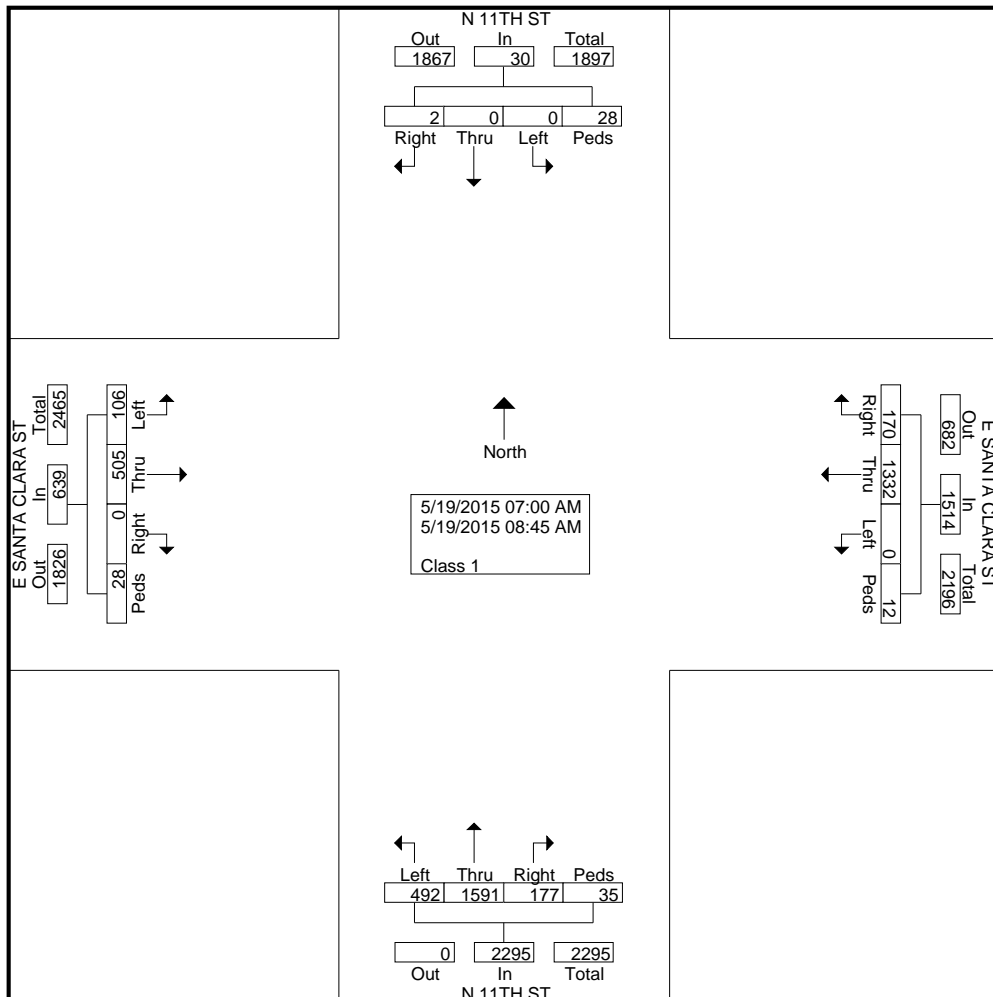

| Start Time  | N 11TH ST Southbound |      |      |      |            | E SANTA CLARA ST Westbound |      |      |      |            | N 11TH ST Northbound |      |      |      |            | E SANTA CLARA ST Eastbound |      |      |      |            | Int. Total |
|---|----------------------|------|------|------|------------|----------------------------|------|------|------|------------|----------------------|------|------|------|------------|----------------------------|------|------|------|------------|------------|
|   | Right                | Thru | Left | Peds | App. Total | Right                      | Thru | Left | Peds | App. Total | Right                | Thru | Left | Peds | App. Total | Right                      | Thru | Left | Peds | App. Total |            |
| <b>Peak Hour Analysis From 07:00 AM to 08:45 AM - Peak 1 of 1</b> |                      |      |      |      |            |                            |      |      |      |            |                      |      |      |      |            |                            |      |      |      |            |            |
| Peak Hour for Entire Intersection Begins at 07:15 AM              |                      |      |      |      |            |                            |      |      |      |            |                      |      |      |      |            |                            |      |      |      |            |            |
| 07:15 AM  | 0                    | 0    | 0    | 3    | 3          | 28                         | 167  | 0    | 2    | 197        | 13                   | 223  | 54   | 3    | 293        | 0                          | 50   | 13   | 3    | 66         | 559        |
| 07:30 AM  | 0                    | 0    | 0    | 5    | 5          | 24                         | 215  | 0    | 1    | 240        | 17                   | 244  | 62   | 6    | 329        | 0                          | 63   | 14   | 2    | 79         | 653        |
| 07:45 AM  | 1                    | 0    | 0    | 2    | 3          | 31                         | 216  | 0    | 3    | 250        | 24                   | 217  | 85   | 4    | 330        | 0                          | 94   | 23   | 1    | 118        | 701        |
| 08:00 AM  | 0                    | 0    | 0    | 2    | 2          | 24                         | 166  | 0    | 1    | 191        | 20                   | 190  | 69   | 3    | 282        | 0                          | 87   | 10   | 2    | 99         | 574        |
| Total Volume  | 1                    | 0    | 0    | 12   | 13         | 107                        | 764  | 0    | 7    | 878        | 74                   | 874  | 270  | 16   | 1234       | 0                          | 294  | 60   | 8    | 362        | 2487       |
| % App. Total  | 7.7                  | 0    | 0    | 92.3 |            | 12.2                       | 87   | 0    | 0.8  |            | 6                    | 70.8 | 21.9 | 1.3  |            | 0                          | 81.2 | 16.6 | 2.2  |            |            |
| PHF   | .250                 | .000 | .000 | .600 | .650       | .863                       | .884 | .000 | .583 | .878       | .771                 | .895 | .794 | .667 | .935       | .000                       | .782 | .652 | .667 | .767       | .887       |

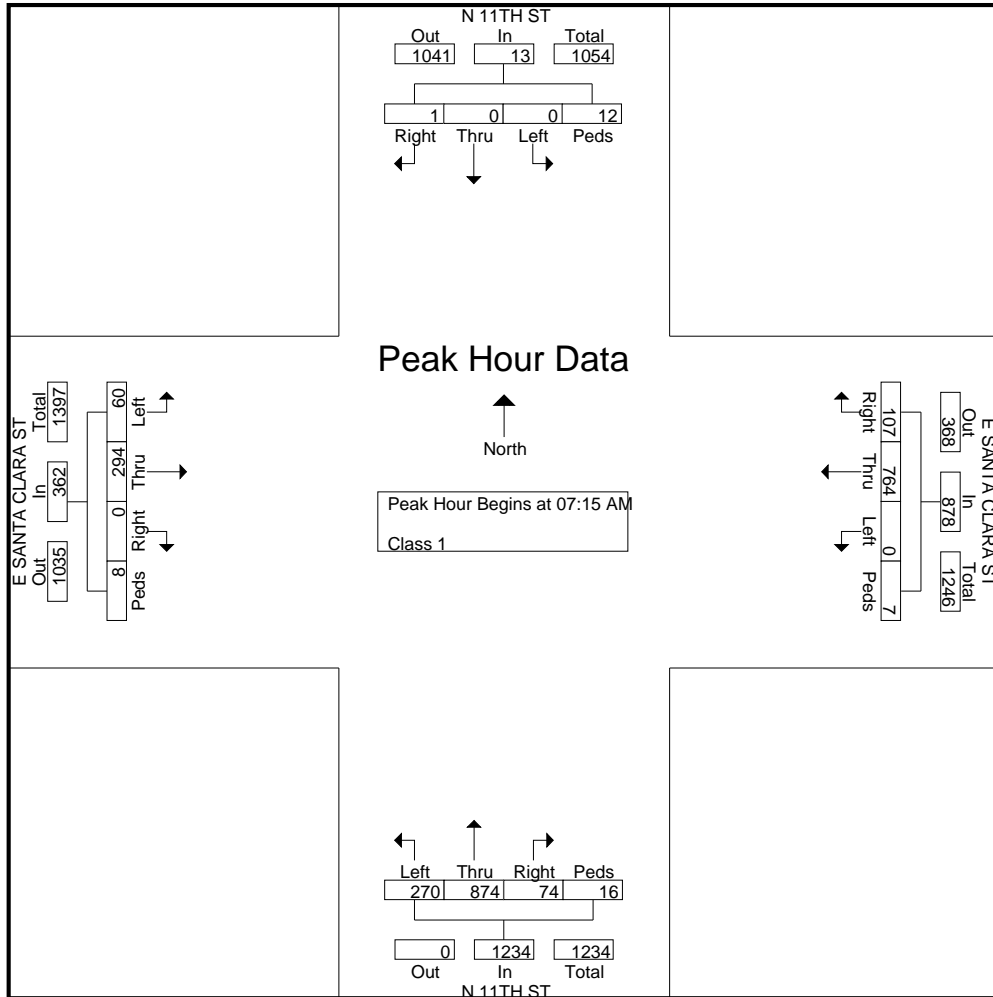

File Name : #76 11TH&SANTA CLARA PM  
 Site Code :  
 Start Date : 5/19/2015  
 Page No : 1

Groups Printed- Class 1

| Start Time  | N 11TH ST Southbound |      |      |      | E SANTA CLARA ST Westbound |      |      |      | N 11TH ST Northbound |      |      |      | E SANTA CLARA ST Eastbound |      |      |      | Int. Total |
|-------------|----------------------|------|------|------|----------------------------|------|------|------|----------------------|------|------|------|----------------------------|------|------|------|------------|
|             | Right                | Thru | Left | Peds | Right                      | Thru | Left | Peds | Right                | Thru | Left | Peds | Right                      | Thru | Left | Peds |            |
| 04:00 PM    | 0                    | 0    | 0    | 7    | 8                          | 92   | 0    | 2    | 33                   | 96   | 47   | 3    | 0                          | 159  | 15   | 3    | 465        |
| 04:15 PM    | 0                    | 0    | 0    | 4    | 7                          | 106  | 0    | 5    | 30                   | 108  | 35   | 7    | 0                          | 129  | 23   | 3    | 457        |
| 04:30 PM    | 0                    | 0    | 0    | 4    | 9                          | 106  | 0    | 5    | 20                   | 106  | 36   | 11   | 0                          | 171  | 17   | 7    | 492        |
| 04:45 PM    | 0                    | 0    | 0    | 3    | 13                         | 124  | 0    | 5    | 29                   | 113  | 36   | 11   | 0                          | 156  | 15   | 7    | 512        |
| Total       | 0                    | 0    | 0    | 18   | 37                         | 428  | 0    | 17   | 112                  | 423  | 154  | 32   | 0                          | 615  | 70   | 20   | 1926       |
| 05:00 PM    | 0                    | 0    | 0    | 9    | 12                         | 96   | 0    | 8    | 27                   | 114  | 35   | 8    | 0                          | 189  | 22   | 10   | 530        |
| 05:15 PM    | 0                    | 0    | 0    | 8    | 14                         | 120  | 0    | 8    | 43                   | 113  | 38   | 13   | 0                          | 192  | 21   | 9    | 579        |
| 05:30 PM    | 0                    | 0    | 0    | 6    | 14                         | 100  | 0    | 10   | 33                   | 101  | 46   | 12   | 0                          | 171  | 20   | 7    | 520        |
| 05:45 PM    | 0                    | 0    | 0    | 13   | 13                         | 109  | 0    | 3    | 20                   | 94   | 49   | 18   | 1                          | 192  | 22   | 8    | 542        |
| Total       | 0                    | 0    | 0    | 36   | 53                         | 425  | 0    | 29   | 123                  | 422  | 168  | 51   | 1                          | 744  | 85   | 34   | 2171       |
| Grand Total | 0                    | 0    | 0    | 54   | 90                         | 853  | 0    | 46   | 235                  | 845  | 322  | 83   | 1                          | 1359 | 155  | 54   | 4097       |
| Apprch %    | 0                    | 0    | 0    | 100  | 9.1                        | 86.2 | 0    | 4.7  | 15.8                 | 56.9 | 21.7 | 5.6  | 0.1                        | 86.6 | 9.9  | 3.4  |            |
| Total %     | 0                    | 0    | 0    | 1.3  | 2.2                        | 20.8 | 0    | 1.1  | 5.7                  | 20.6 | 7.9  | 2    | 0                          | 33.2 | 3.8  | 1.3  |            |

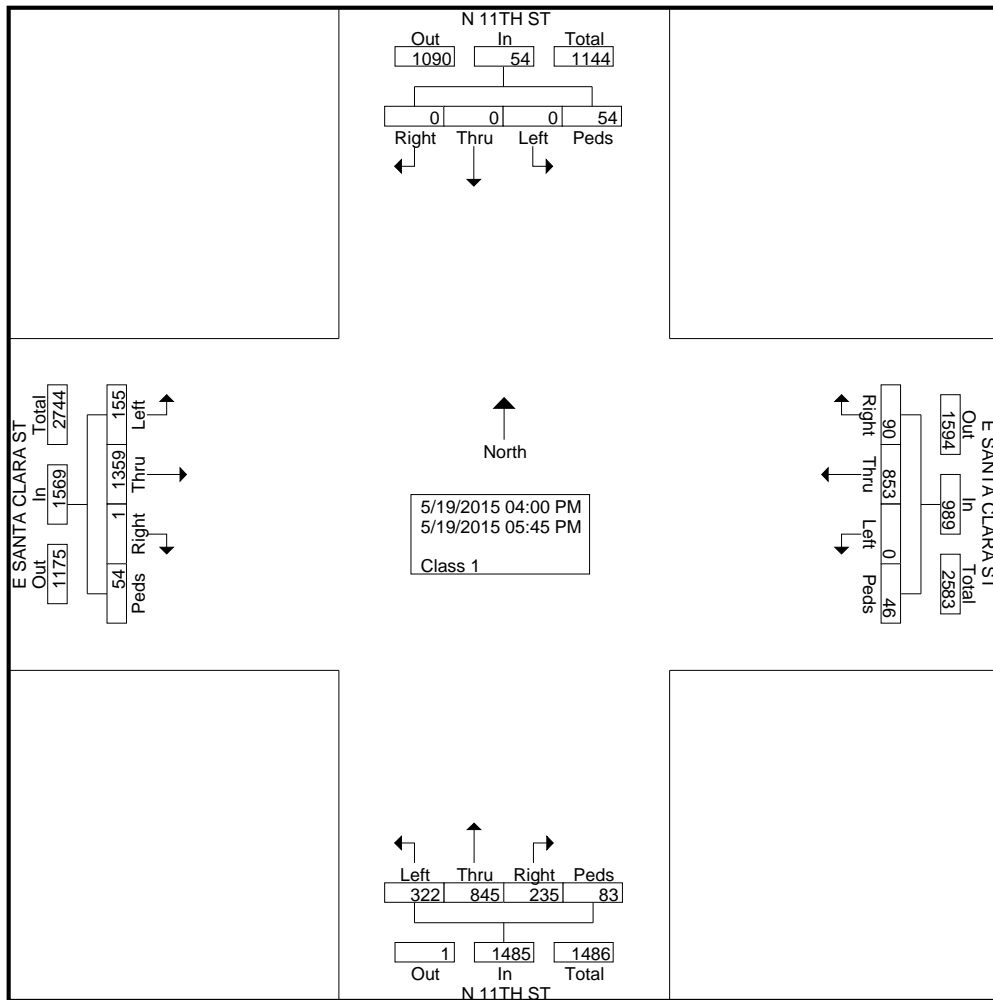

| Start Time  | N 11TH ST Southbound |      |      |      |            | E SANTA CLARA ST Westbound |      |      |      |            | N 11TH ST Northbound |      |      |      |            | E SANTA CLARA ST Eastbound |      |      |      |            | Int. Total |
|---|----------------------|------|------|------|------------|----------------------------|------|------|------|------------|----------------------|------|------|------|------------|----------------------------|------|------|------|------------|------------|
|   | Right                | Thru | Left | Peds | App. Total | Right                      | Thru | Left | Peds | App. Total | Right                | Thru | Left | Peds | App. Total | Right                      | Thru | Left | Peds | App. Total |            |
| <b>Peak Hour Analysis From 04:00 PM to 05:45 PM - Peak 1 of 1</b> |                      |      |      |      |            |                            |      |      |      |            |                      |      |      |      |            |                            |      |      |      |            |            |
| Peak Hour for Entire Intersection Begins at 05:00 PM              |                      |      |      |      |            |                            |      |      |      |            |                      |      |      |      |            |                            |      |      |      |            |            |
| 05:00 PM  | 0                    | 0    | 0    | 9    | 9          | 12                         | 96   | 0    | 8    | 116        | 27                   | 114  | 35   | 8    | 184        | 0                          | 189  | 22   | 10   | 221        | 530        |
| 05:15 PM  | 0                    | 0    | 0    | 8    | 8          | 14                         | 120  | 0    | 8    | 142        | 43                   | 113  | 38   | 13   | 207        | 0                          | 192  | 21   | 9    | 222        | 579        |
| 05:30 PM  | 0                    | 0    | 0    | 6    | 6          | 14                         | 100  | 0    | 10   | 124        | 33                   | 101  | 46   | 12   | 192        | 0                          | 171  | 20   | 7    | 198        | 520        |
| 05:45 PM  | 0                    | 0    | 0    | 13   | 13         | 13                         | 109  | 0    | 3    | 125        | 20                   | 94   | 49   | 18   | 181        | 1                          | 192  | 22   | 8    | 223        | 542        |
| Total Volume  | 0                    | 0    | 0    | 36   | 36         | 53                         | 425  | 0    | 29   | 507        | 123                  | 422  | 168  | 51   | 764        | 1                          | 744  | 85   | 34   | 864        | 2171       |
| % App. Total  | 0                    | 0    | 0    | 100  |            | 10.5                       | 83.8 | 0    | 5.7  |            | 16.1                 | 55.2 | 22   | 6.7  |            | 0.1                        | 86.1 | 9.8  | 3.9  |            |            |
| PHF   | .000                 | .000 | .000 | .692 | .692       | .946                       | .885 | .000 | .725 | .893       | .715                 | .925 | .857 | .708 | .923       | .250                       | .969 | .966 | .850 | .969       | .937       |

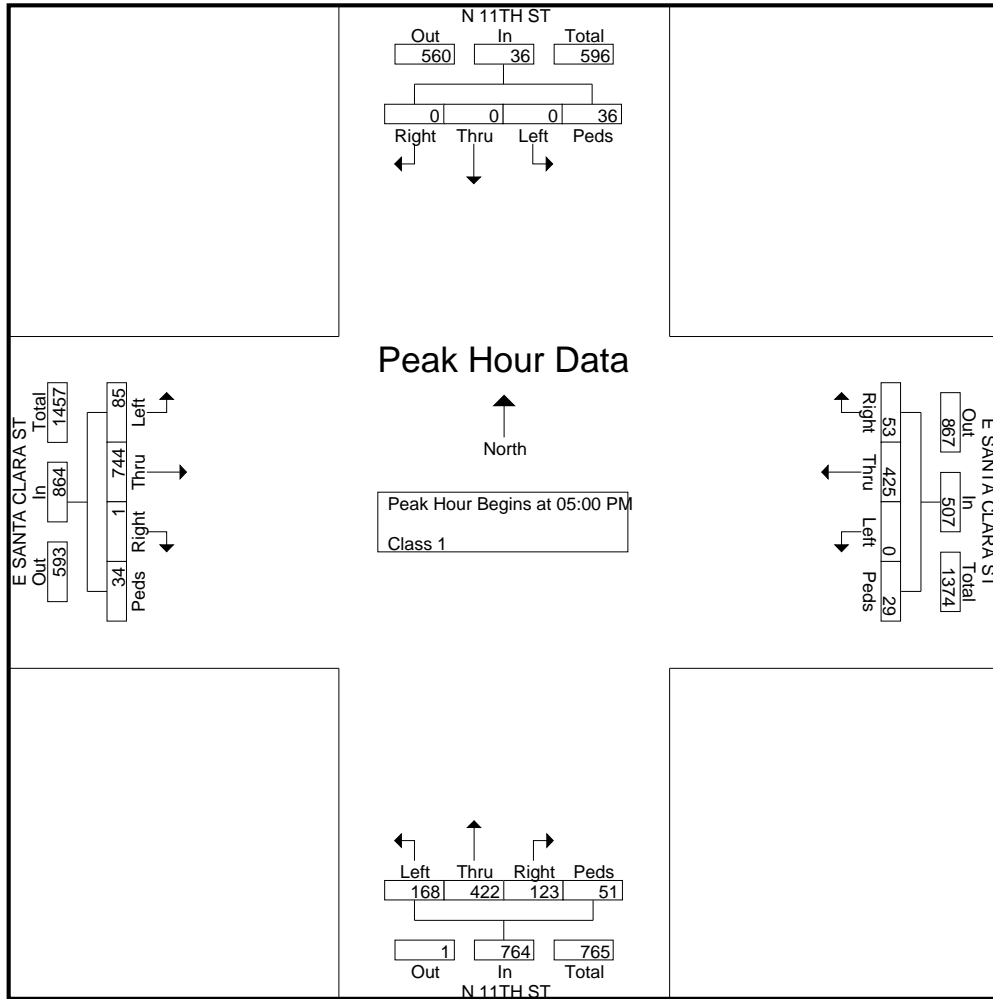

Groups Printed- Class 1

| Start Time  | N 10TH ST Southbound |      |      |      | E JULIAN ST Westbound |      |      |      | N 10TH ST Northbound |      |      |      | E JULIAN ST Eastbound |      |      |      | Int. Total |
|-------------|----------------------|------|------|------|-----------------------|------|------|------|----------------------|------|------|------|-----------------------|------|------|------|------------|
|             | Right                | Thru | Left | Peds | Right                 | Thru | Left | Peds | Right                | Thru | Left | Peds | Right                 | Thru | Left | Peds |            |
| 07:00 AM    | 7                    | 97   | 9    | 5    | 0                     | 105  | 17   | 1    | 0                    | 0    | 0    | 3    | 1                     | 22   | 0    | 0    | 267        |
| 07:15 AM    | 11                   | 97   | 9    | 1    | 0                     | 120  | 34   | 0    | 0                    | 0    | 0    | 4    | 3                     | 27   | 0    | 2    | 308        |
| 07:30 AM    | 21                   | 133  | 14   | 0    | 0                     | 123  | 18   | 1    | 0                    | 0    | 0    | 2    | 6                     | 37   | 0    | 0    | 355        |
| 07:45 AM    | 15                   | 139  | 20   | 0    | 0                     | 118  | 40   | 4    | 0                    | 0    | 0    | 2    | 7                     | 66   | 0    | 6    | 417        |
| Total       | 54                   | 466  | 52   | 6    | 0                     | 466  | 109  | 6    | 0                    | 0    | 0    | 11   | 17                    | 152  | 0    | 8    | 1347       |
| 08:00 AM    | 13                   | 110  | 13   | 2    | 0                     | 140  | 21   | 0    | 0                    | 0    | 0    | 1    | 2                     | 37   | 0    | 1    | 340        |
| 08:15 AM    | 6                    | 99   | 9    | 0    | 0                     | 131  | 22   | 0    | 0                    | 0    | 0    | 4    | 7                     | 24   | 0    | 2    | 304        |
| 08:30 AM    | 13                   | 94   | 6    | 2    | 0                     | 125  | 31   | 1    | 0                    | 0    | 0    | 1    | 7                     | 30   | 0    | 1    | 311        |
| 08:45 AM    | 5                    | 93   | 12   | 3    | 0                     | 99   | 14   | 0    | 0                    | 0    | 0    | 1    | 7                     | 30   | 0    | 0    | 264        |
| Total       | 37                   | 396  | 40   | 7    | 0                     | 495  | 88   | 1    | 0                    | 0    | 0    | 7    | 23                    | 121  | 0    | 4    | 1219       |
| Grand Total | 91                   | 862  | 92   | 13   | 0                     | 961  | 197  | 7    | 0                    | 0    | 0    | 18   | 40                    | 273  | 0    | 12   | 2566       |
| Apprch %    | 8.6                  | 81.5 | 8.7  | 1.2  | 0                     | 82.5 | 16.9 | 0.6  | 0                    | 0    | 0    | 100  | 12.3                  | 84   | 0    | 3.7  |            |
| Total %     | 3.5                  | 33.6 | 3.6  | 0.5  | 0                     | 37.5 | 7.7  | 0.3  | 0                    | 0    | 0    | 0.7  | 1.6                   | 10.6 | 0    | 0.5  |            |

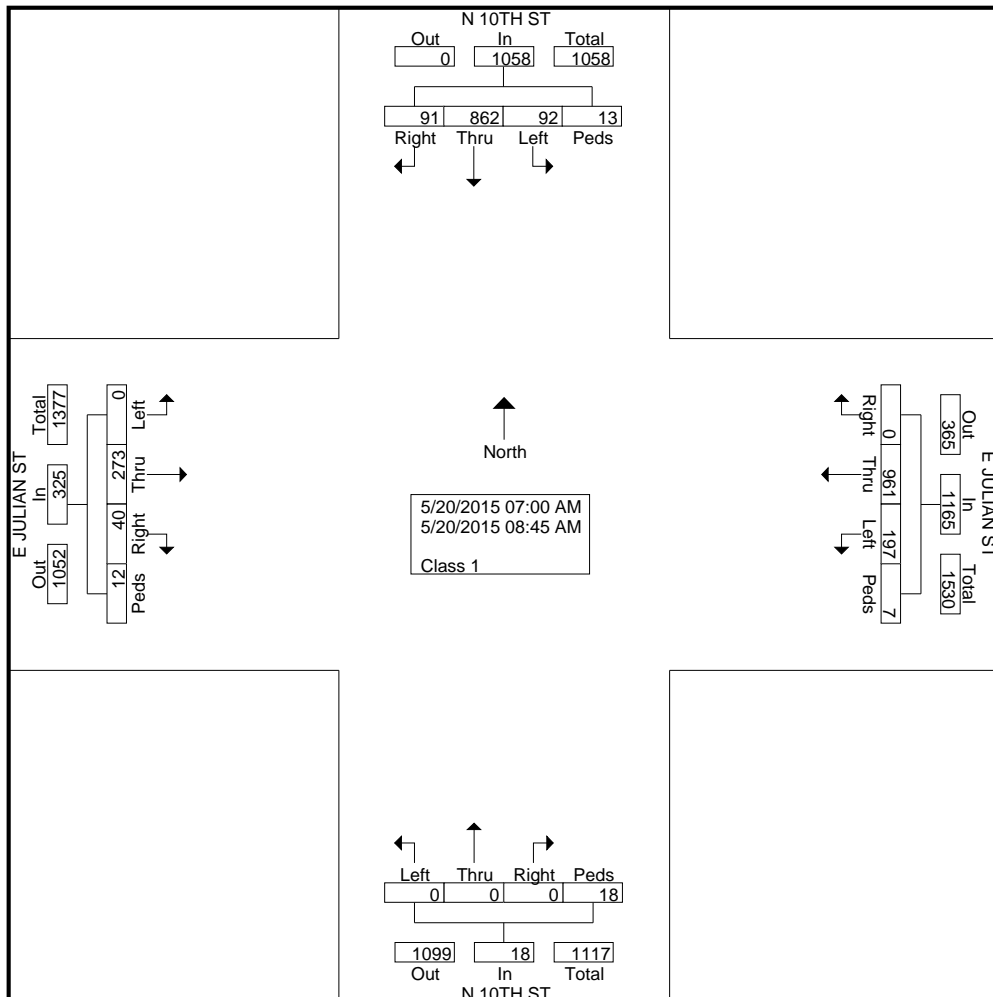

| Start Time  | N 10TH ST Southbound |      |      |      |            | E JULIAN ST Westbound |      |      |      |            | N 10TH ST Northbound |      |      |      |            | E JULIAN ST Eastbound |      |      |      |            | Int. Total |
|---|----------------------|------|------|------|------------|-----------------------|------|------|------|------------|----------------------|------|------|------|------------|-----------------------|------|------|------|------------|------------|
|   | Right                | Thru | Left | Peds | App. Total | Right                 | Thru | Left | Peds | App. Total | Right                | Thru | Left | Peds | App. Total | Right                 | Thru | Left | Peds | App. Total |            |
| <b>Peak Hour Analysis From 07:00 AM to 08:45 AM - Peak 1 of 1</b> |                      |      |      |      |            |                       |      |      |      |            |                      |      |      |      |            |                       |      |      |      |            |            |
| Peak Hour for Entire Intersection Begins at 07:15 AM              |                      |      |      |      |            |                       |      |      |      |            |                      |      |      |      |            |                       |      |      |      |            |            |
| 07:15 AM  | 11                   | 97   | 9    | 1    | 118        | 0                     | 120  | 34   | 0    | 154        | 0                    | 0    | 0    | 4    | 4          | 3                     | 27   | 0    | 2    | 32         | 308        |
| 07:30 AM  | 21                   | 133  | 14   | 0    | 168        | 0                     | 123  | 18   | 1    | 142        | 0                    | 0    | 0    | 2    | 2          | 6                     | 37   | 0    | 0    | 43         | 355        |
| 07:45 AM  | 15                   | 139  | 20   | 0    | 174        | 0                     | 118  | 40   | 4    | 162        | 0                    | 0    | 0    | 2    | 2          | 7                     | 66   | 0    | 6    | 79         | 417        |
| 08:00 AM  | 13                   | 110  | 13   | 2    | 138        | 0                     | 140  | 21   | 0    | 161        | 0                    | 0    | 0    | 1    | 1          | 2                     | 37   | 0    | 1    | 40         | 340        |
| Total Volume  | 60                   | 479  | 56   | 3    | 598        | 0                     | 501  | 113  | 5    | 619        | 0                    | 0    | 0    | 9    | 9          | 18                    | 167  | 0    | 9    | 194        | 1420       |
| % App. Total  | 10                   | 80.1 | 9.4  | 0.5  |            | 0                     | 80.9 | 18.3 | 0.8  |            | 0                    | 0    | 0    | 100  |            | 9.3                   | 86.1 | 0    | 4.6  |            |            |
| PHF   | .714                 | .862 | .700 | .375 | .859       | .000                  | .895 | .706 | .313 | .955       | .000                 | .000 | .000 | .563 | .563       | .643                  | .633 | .000 | .375 | .614       | .851       |

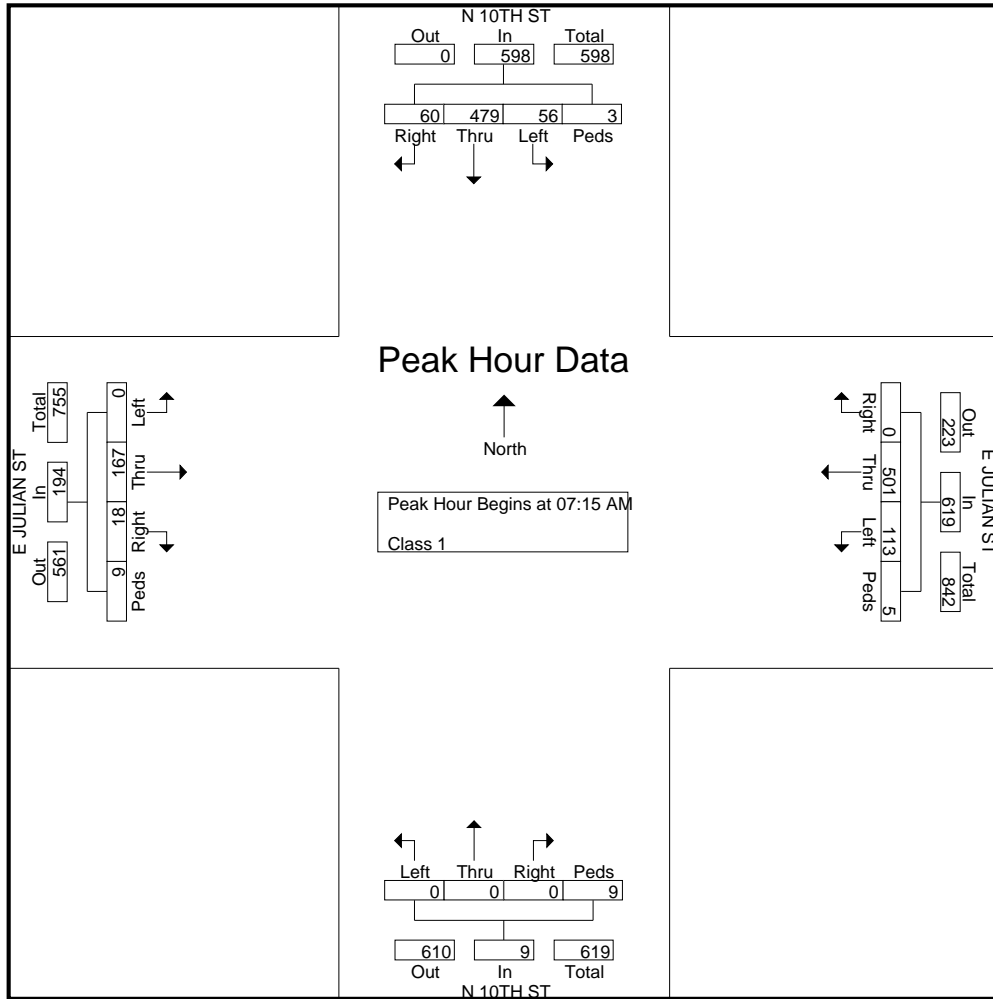



Groups Printed- Class 1

| Start Time  | N 10TH ST Southbound |      |      |      | E JULIAN ST Westbound |      |      |      | N 10TH ST Northbound |      |      |      | E JULIAN ST Eastbound |      |      |      | Int. Total |
|-------------|----------------------|------|------|------|-----------------------|------|------|------|----------------------|------|------|------|-----------------------|------|------|------|------------|
|             | Right                | Thru | Left | Peds | Right                 | Thru | Left | Peds | Right                | Thru | Left | Peds | Right                 | Thru | Left | Peds |            |
| 04:00 PM    | 17                   | 242  | 32   | 2    | 0                     | 77   | 13   | 1    | 0                    | 0    | 0    | 1    | 9                     | 61   | 0    | 0    | 455        |
| 04:15 PM    | 11                   | 182  | 22   | 0    | 0                     | 65   | 13   | 0    | 0                    | 0    | 0    | 2    | 16                    | 61   | 0    | 2    | 374        |
| 04:30 PM    | 11                   | 208  | 22   | 3    | 0                     | 81   | 17   | 5    | 0                    | 0    | 0    | 2    | 13                    | 58   | 0    | 1    | 421        |
| 04:45 PM    | 13                   | 239  | 36   | 4    | 0                     | 72   | 13   | 0    | 0                    | 0    | 0    | 3    | 14                    | 51   | 0    | 1    | 446        |
| Total       | 52                   | 871  | 112  | 9    | 0                     | 295  | 56   | 6    | 0                    | 0    | 0    | 8    | 52                    | 231  | 0    | 4    | 1696       |
| 05:00 PM    | 19                   | 230  | 21   | 6    | 0                     | 61   | 14   | 2    | 0                    | 0    | 0    | 3    | 14                    | 71   | 0    | 4    | 445        |
| 05:15 PM    | 12                   | 247  | 30   | 11   | 0                     | 73   | 17   | 2    | 0                    | 0    | 0    | 1    | 11                    | 76   | 0    | 1    | 481        |
| 05:30 PM    | 19                   | 189  | 33   | 7    | 0                     | 80   | 12   | 3    | 0                    | 0    | 0    | 0    | 9                     | 72   | 0    | 2    | 426        |
| 05:45 PM    | 10                   | 217  | 24   | 8    | 0                     | 88   | 19   | 4    | 0                    | 0    | 0    | 2    | 10                    | 70   | 0    | 3    | 455        |
| Total       | 60                   | 883  | 108  | 32   | 0                     | 302  | 62   | 11   | 0                    | 0    | 0    | 6    | 44                    | 289  | 0    | 10   | 1807       |
| Grand Total | 112                  | 1754 | 220  | 41   | 0                     | 597  | 118  | 17   | 0                    | 0    | 0    | 14   | 96                    | 520  | 0    | 14   | 3503       |
| Apprch %    | 5.3                  | 82.5 | 10.3 | 1.9  | 0                     | 81.6 | 16.1 | 2.3  | 0                    | 0    | 0    | 100  | 15.2                  | 82.5 | 0    | 2.2  |            |
| Total %     | 3.2                  | 50.1 | 6.3  | 1.2  | 0                     | 17   | 3.4  | 0.5  | 0                    | 0    | 0    | 0.4  | 2.7                   | 14.8 | 0    | 0.4  |            |

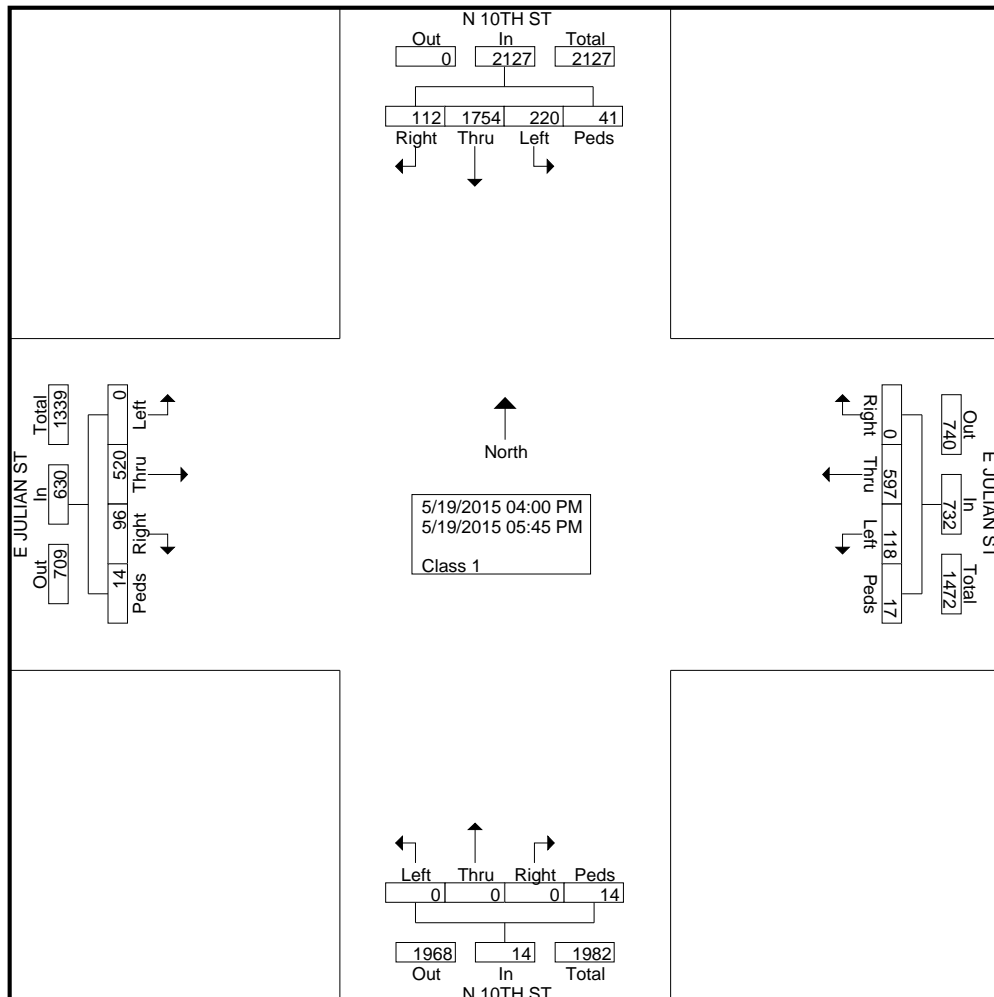

| Start Time  | N 10TH ST Southbound |      |      |      |            | E JULIAN ST Westbound |      |      |      |            | N 10TH ST Northbound |      |      |      |            | E JULIAN ST Eastbound |      |      |      |            | Int. Total |
|---|----------------------|------|------|------|------------|-----------------------|------|------|------|------------|----------------------|------|------|------|------------|-----------------------|------|------|------|------------|------------|
|   | Right                | Thru | Left | Peds | App. Total | Right                 | Thru | Left | Peds | App. Total | Right                | Thru | Left | Peds | App. Total | Right                 | Thru | Left | Peds | App. Total |            |
| <b>Peak Hour Analysis From 04:00 PM to 05:45 PM - Peak 1 of 1</b> |                      |      |      |      |            |                       |      |      |      |            |                      |      |      |      |            |                       |      |      |      |            |            |
| Peak Hour for Entire Intersection Begins at 05:00 PM              |                      |      |      |      |            |                       |      |      |      |            |                      |      |      |      |            |                       |      |      |      |            |            |
| 05:00 PM  | 19                   | 230  | 21   | 6    | 276        | 0                     | 61   | 14   | 2    | 77         | 0                    | 0    | 0    | 3    | 3          | 14                    | 71   | 0    | 4    | 89         | 445        |
| 05:15 PM  | 12                   | 247  | 30   | 11   | 300        | 0                     | 73   | 17   | 2    | 92         | 0                    | 0    | 0    | 1    | 1          | 11                    | 76   | 0    | 1    | 88         | 481        |
| 05:30 PM  | 19                   | 189  | 33   | 7    | 248        | 0                     | 80   | 12   | 3    | 95         | 0                    | 0    | 0    | 0    | 0          | 9                     | 72   | 0    | 2    | 83         | 426        |
| 05:45 PM  | 10                   | 217  | 24   | 8    | 259        | 0                     | 88   | 19   | 4    | 111        | 0                    | 0    | 0    | 2    | 2          | 10                    | 70   | 0    | 3    | 83         | 455        |
| Total Volume  | 60                   | 883  | 108  | 32   | 1083       | 0                     | 302  | 62   | 11   | 375        | 0                    | 0    | 0    | 6    | 6          | 44                    | 289  | 0    | 10   | 343        | 1807       |
| % App. Total  | 5.5                  | 81.5 | 10   | 3    |            | 0                     | 80.5 | 16.5 | 2.9  |            | 0                    | 0    | 0    | 100  |            | 12.8                  | 84.3 | 0    | 2.9  |            |            |
| PHF   | .789                 | .894 | .818 | .727 | .903       | .000                  | .858 | .816 | .688 | .845       | .000                 | .000 | .000 | .500 | .500       | .786                  | .951 | .000 | .625 | .963       | .939       |

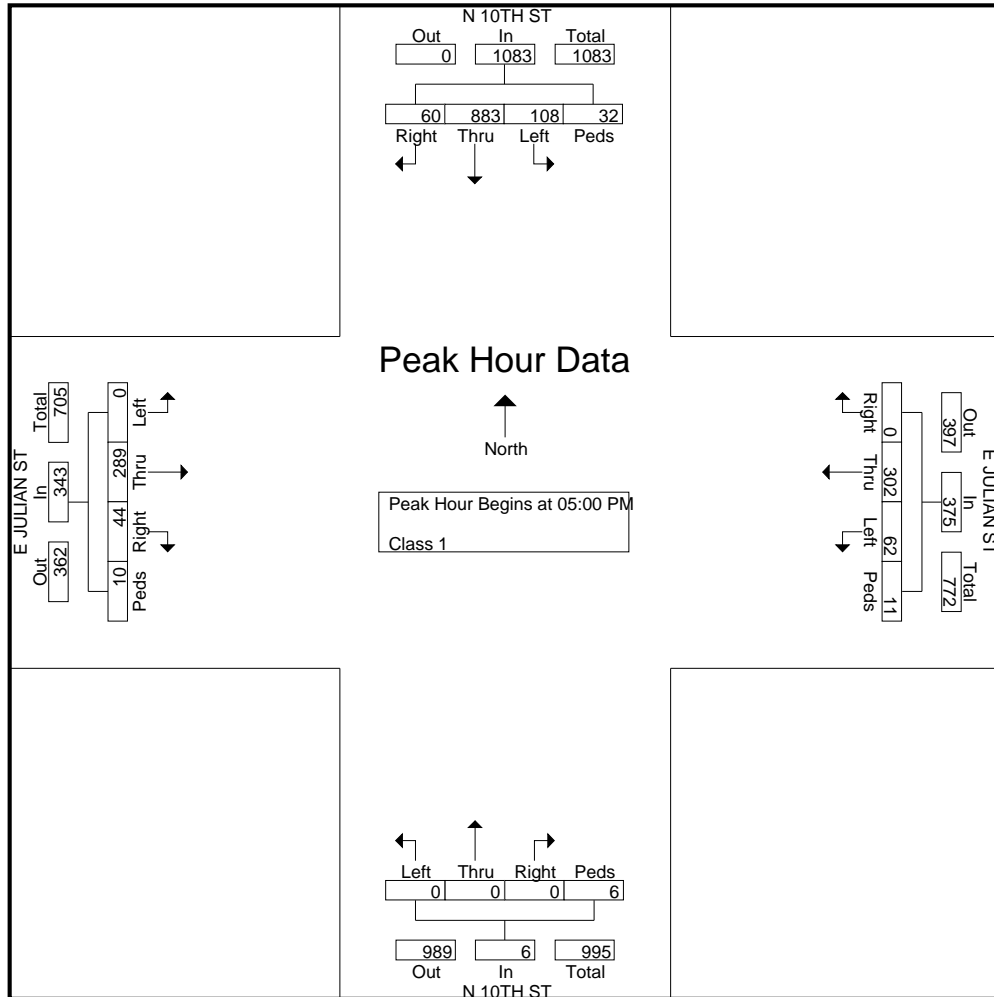

File Name : #85 10TH&SANTA CLARA AM  
 Site Code :  
 Start Date : 5/20/2015  
 Page No : 1

Groups Printed- Class 1

| Start Time  | N 10TH ST Southbound |      |      |      | E SANTA CLARA ST Westbound |      |      |      | N 10TH ST Northbound |      |      |      | E SANTA CLARA ST Eastbound |      |      |      | Int. Total |
|-------------|----------------------|------|------|------|----------------------------|------|------|------|----------------------|------|------|------|----------------------------|------|------|------|------------|
|             | Right                | Thru | Left | Peds | Right                      | Thru | Left | Peds | Right                | Thru | Left | Peds | Right                      | Thru | Left | Peds |            |
| 07:00 AM    | 11                   | 102  | 7    | 6    | 0                          | 133  | 24   | 1    | 0                    | 0    | 0    | 5    | 25                         | 39   | 0    | 0    | 353        |
| 07:15 AM    | 19                   | 108  | 7    | 2    | 0                          | 168  | 23   | 0    | 0                    | 0    | 0    | 8    | 14                         | 44   | 0    | 1    | 394        |
| 07:30 AM    | 18                   | 108  | 16   | 2    | 0                          | 213  | 13   | 4    | 0                    | 0    | 0    | 7    | 17                         | 68   | 0    | 2    | 468        |
| 07:45 AM    | 18                   | 162  | 13   | 2    | 0                          | 259  | 28   | 2    | 0                    | 0    | 0    | 4    | 28                         | 101  | 0    | 2    | 619        |
| Total       | 66                   | 480  | 43   | 12   | 0                          | 773  | 88   | 7    | 0                    | 0    | 0    | 24   | 84                         | 252  | 0    | 5    | 1834       |
| 08:00 AM    | 11                   | 138  | 8    | 6    | 0                          | 190  | 28   | 5    | 0                    | 0    | 0    | 5    | 38                         | 97   | 0    | 6    | 532        |
| 08:15 AM    | 19                   | 111  | 4    | 3    | 0                          | 167  | 27   | 2    | 0                    | 0    | 0    | 3    | 31                         | 68   | 0    | 3    | 438        |
| 08:30 AM    | 16                   | 97   | 13   | 3    | 0                          | 146  | 23   | 4    | 0                    | 0    | 0    | 3    | 24                         | 58   | 0    | 1    | 388        |
| 08:45 AM    | 20                   | 108  | 6    | 1    | 0                          | 166  | 27   | 1    | 0                    | 0    | 0    | 5    | 25                         | 67   | 0    | 0    | 426        |
| Total       | 66                   | 454  | 31   | 13   | 0                          | 669  | 105  | 12   | 0                    | 0    | 0    | 16   | 118                        | 290  | 0    | 10   | 1784       |
| Grand Total | 132                  | 934  | 74   | 25   | 0                          | 1442 | 193  | 19   | 0                    | 0    | 0    | 40   | 202                        | 542  | 0    | 15   | 3618       |
| Apprch %    | 11.3                 | 80.2 | 6.4  | 2.1  | 0                          | 87.2 | 11.7 | 1.1  | 0                    | 0    | 0    | 100  | 26.6                       | 71.4 | 0    | 2    |            |
| Total %     | 3.6                  | 25.8 | 2    | 0.7  | 0                          | 39.9 | 5.3  | 0.5  | 0                    | 0    | 0    | 1.1  | 5.6                        | 15   | 0    | 0.4  |            |

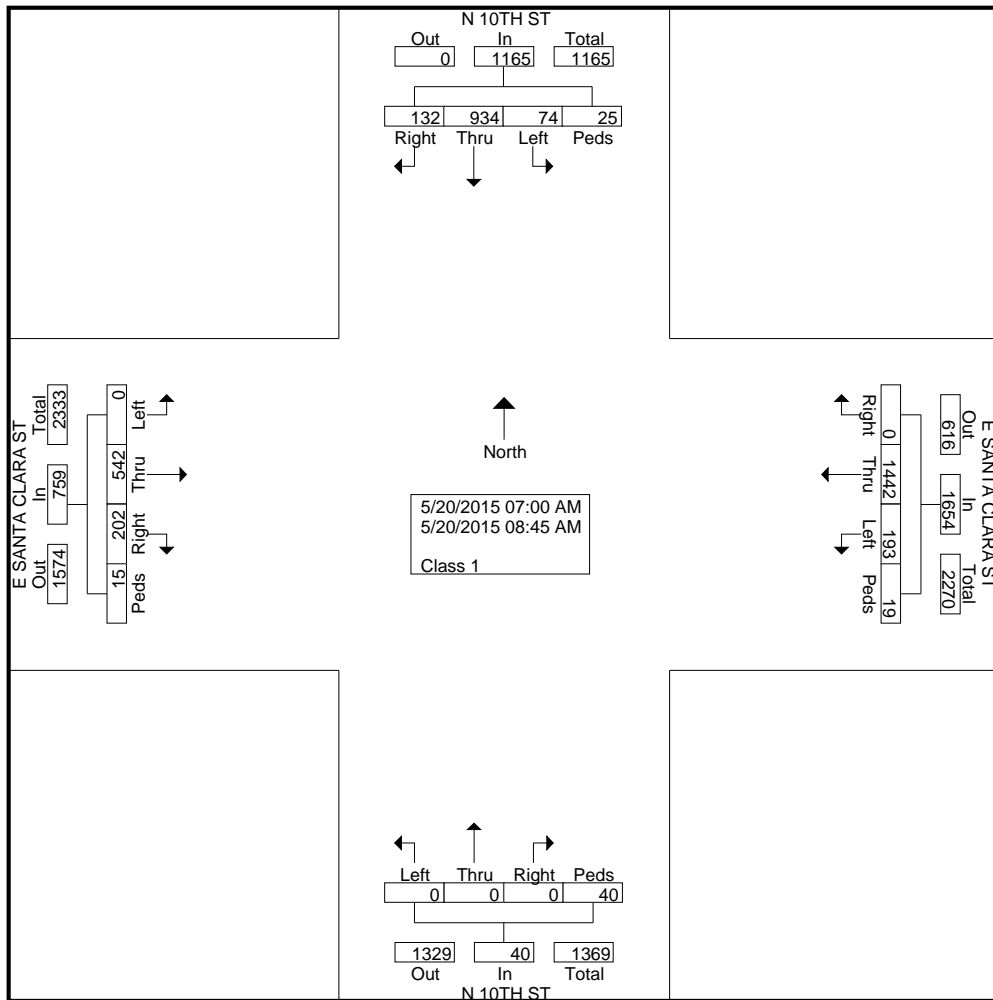

File Name : #85 10TH&SANTA CLARA AM  
 Site Code :  
 Start Date : 5/20/2015  
 Page No : 2

| Start Time  | N 10TH ST Southbound |      |      |      |            | E SANTA CLARA ST Westbound |      |      |      |            | N 10TH ST Northbound |      |      |      |            | E SANTA CLARA ST Eastbound |      |      |      |            | Int. Total |
|---|----------------------|------|------|------|------------|----------------------------|------|------|------|------------|----------------------|------|------|------|------------|----------------------------|------|------|------|------------|------------|
|   | Right                | Thru | Left | Peds | App. Total | Right                      | Thru | Left | Peds | App. Total | Right                | Thru | Left | Peds | App. Total | Right                      | Thru | Left | Peds | App. Total |            |
| <b>Peak Hour Analysis From 07:00 AM to 08:45 AM - Peak 1 of 1</b> |                      |      |      |      |            |                            |      |      |      |            |                      |      |      |      |            |                            |      |      |      |            |            |
| Peak Hour for Entire Intersection Begins at 07:30 AM              |                      |      |      |      |            |                            |      |      |      |            |                      |      |      |      |            |                            |      |      |      |            |            |
| 07:30 AM  | 18                   | 108  | 16   | 2    | 144        | 0                          | 213  | 13   | 4    | 230        | 0                    | 0    | 0    | 7    | 7          | 17                         | 68   | 0    | 2    | 87         | 468        |
| 07:45 AM  | 18                   | 162  | 13   | 2    | 195        | 0                          | 259  | 28   | 2    | 289        | 0                    | 0    | 0    | 4    | 4          | 28                         | 101  | 0    | 2    | 131        | 619        |
| 08:00 AM  | 11                   | 138  | 8    | 6    | 163        | 0                          | 190  | 28   | 5    | 223        | 0                    | 0    | 0    | 5    | 5          | 38                         | 97   | 0    | 6    | 141        | 532        |
| 08:15 AM  | 19                   | 111  | 4    | 3    | 137        | 0                          | 167  | 27   | 2    | 196        | 0                    | 0    | 0    | 3    | 3          | 31                         | 68   | 0    | 3    | 102        | 438        |
| Total Volume  | 66                   | 519  | 41   | 13   | 639        | 0                          | 829  | 96   | 13   | 938        | 0                    | 0    | 0    | 19   | 19         | 114                        | 334  | 0    | 13   | 461        | 2057       |
| % App. Total  | 10.3                 | 81.2 | 6.4  | 2    |            | 0                          | 88.4 | 10.2 | 1.4  |            | 0                    | 0    | 0    | 100  |            | 24.7                       | 72.5 | 0    | 2.8  |            |            |
| PHF   | .868                 | .801 | .641 | .542 | .819       | .000                       | .800 | .857 | .650 | .811       | .000                 | .000 | .000 | .679 | .679       | .750                       | .827 | .000 | .542 | .817       | .831       |

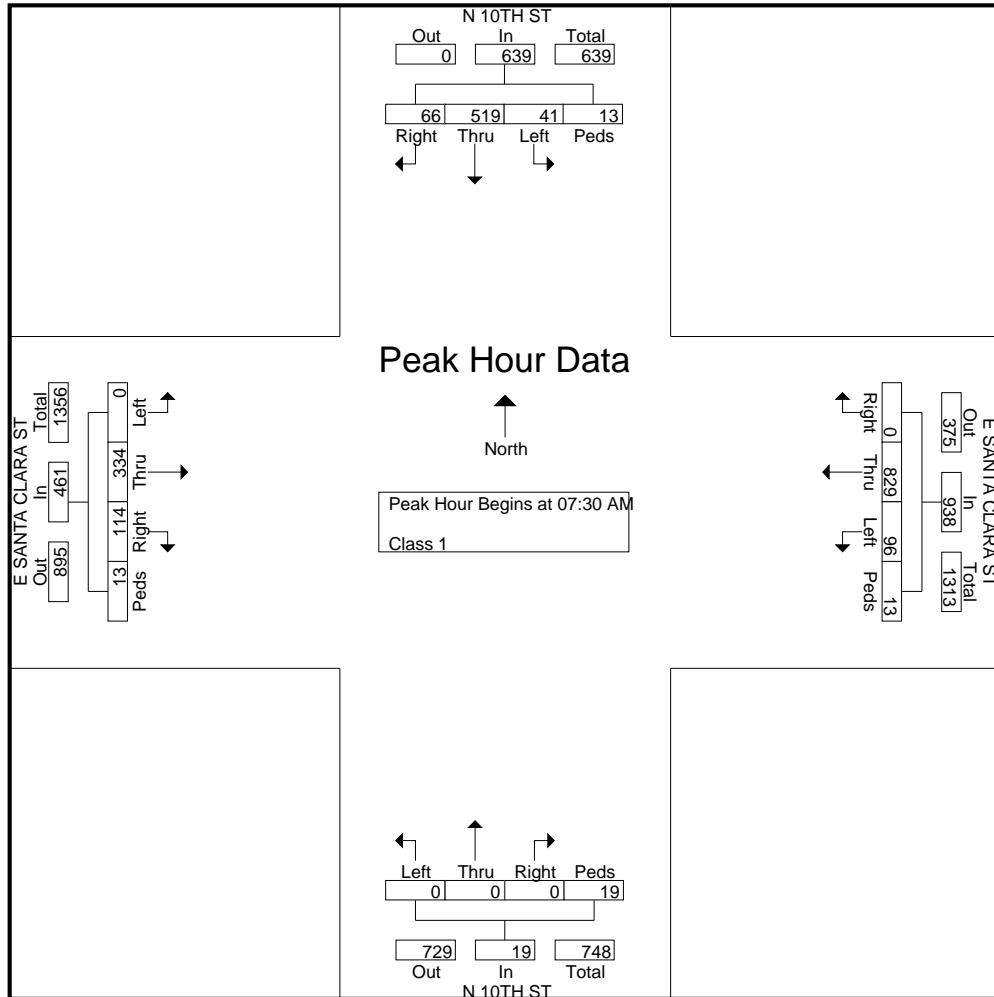

File Name : #85 10TH&SANTA CLARA PM  
 Site Code :  
 Start Date : 5/19/2015  
 Page No : 1

Groups Printed- Class 1

| Start Time  | N 10TH ST Southbound |      |      |      | E SANTA CLARA ST Westbound |      |      |      | N 10TH ST Northbound |      |      |      | E SANTA CLARA ST Eastbound |      |      |      | Int. Total |
|-------------|----------------------|------|------|------|----------------------------|------|------|------|----------------------|------|------|------|----------------------------|------|------|------|------------|
|             | Right                | Thru | Left | Peds | Right                      | Thru | Left | Peds | Right                | Thru | Left | Peds | Right                      | Thru | Left | Peds |            |
| 04:00 PM    | 21                   | 214  | 16   | 4    | 0                          | 85   | 33   | 3    | 0                    | 0    | 0    | 16   | 38                         | 128  | 0    | 7    | 565        |
| 04:15 PM    | 14                   | 185  | 28   | 7    | 0                          | 101  | 25   | 0    | 0                    | 0    | 0    | 17   | 45                         | 152  | 0    | 4    | 578        |
| 04:30 PM    | 25                   | 200  | 21   | 7    | 0                          | 92   | 46   | 4    | 0                    | 0    | 0    | 24   | 51                         | 145  | 0    | 4    | 619        |
| 04:45 PM    | 16                   | 209  | 24   | 9    | 0                          | 93   | 37   | 3    | 0                    | 0    | 0    | 12   | 45                         | 136  | 0    | 7    | 591        |
| Total       | 76                   | 808  | 89   | 27   | 0                          | 371  | 141  | 10   | 0                    | 0    | 0    | 69   | 179                        | 561  | 0    | 22   | 2353       |
| 05:00 PM    | 33                   | 222  | 35   | 5    | 0                          | 126  | 48   | 4    | 0                    | 0    | 0    | 6    | 38                         | 182  | 0    | 5    | 704        |
| 05:15 PM    | 20                   | 222  | 30   | 2    | 0                          | 119  | 32   | 7    | 0                    | 0    | 0    | 5    | 50                         | 176  | 0    | 7    | 670        |
| 05:30 PM    | 18                   | 171  | 25   | 5    | 0                          | 109  | 29   | 4    | 0                    | 0    | 0    | 15   | 41                         | 174  | 0    | 4    | 595        |
| 05:45 PM    | 20                   | 203  | 25   | 3    | 0                          | 94   | 27   | 3    | 0                    | 0    | 0    | 22   | 33                         | 165  | 0    | 4    | 599        |
| Total       | 91                   | 818  | 115  | 15   | 0                          | 448  | 136  | 18   | 0                    | 0    | 0    | 48   | 162                        | 697  | 0    | 20   | 2568       |
| Grand Total | 167                  | 1626 | 204  | 42   | 0                          | 819  | 277  | 28   | 0                    | 0    | 0    | 117  | 341                        | 1258 | 0    | 42   | 4921       |
| Apprch %    | 8.2                  | 79.7 | 10   | 2.1  | 0                          | 72.9 | 24.6 | 2.5  | 0                    | 0    | 0    | 100  | 20.8                       | 76.7 | 0    | 2.6  |            |
| Total %     | 3.4                  | 33   | 4.1  | 0.9  | 0                          | 16.6 | 5.6  | 0.6  | 0                    | 0    | 0    | 2.4  | 6.9                        | 25.6 | 0    | 0.9  |            |

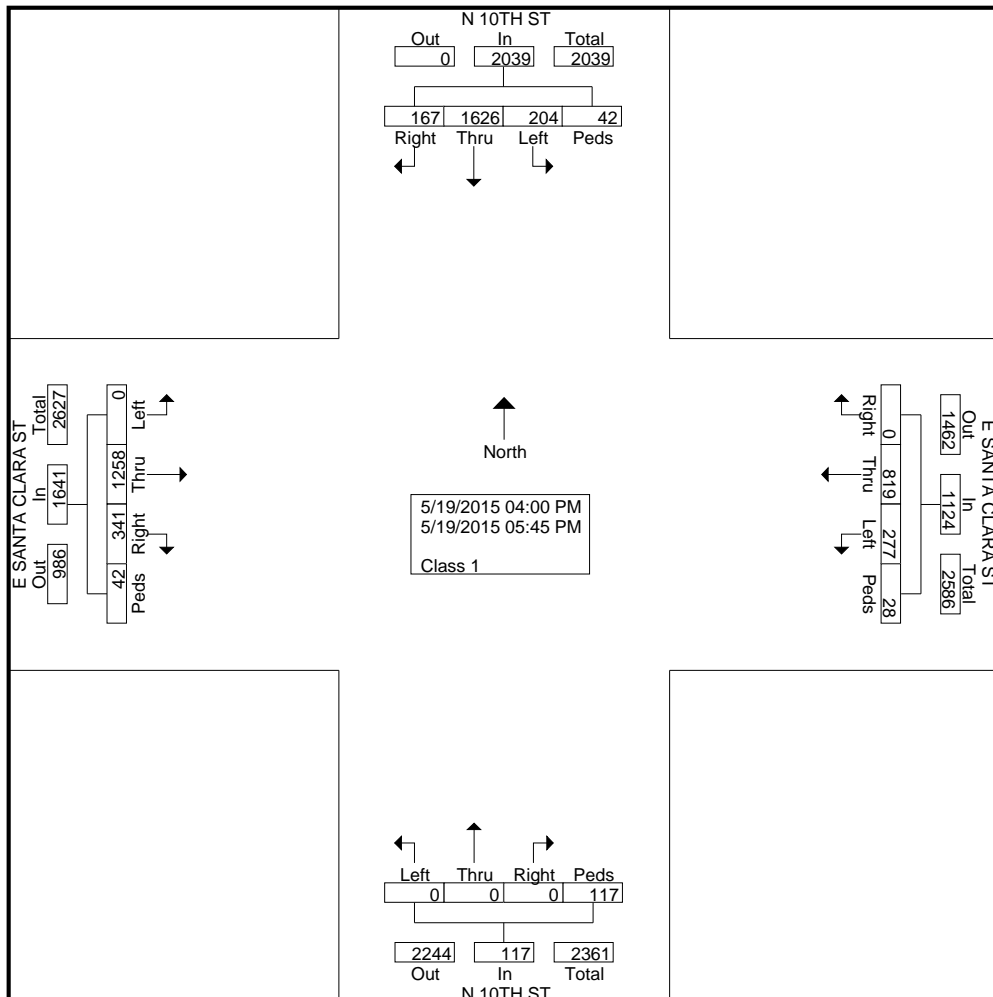

| Start Time  | N 10TH ST Southbound |      |      |      |            | E SANTA CLARA ST Westbound |      |      |      |            | N 10TH ST Northbound |      |      |      |            | E SANTA CLARA ST Eastbound |      |      |      |            | Int. Total |
|---|----------------------|------|------|------|------------|----------------------------|------|------|------|------------|----------------------|------|------|------|------------|----------------------------|------|------|------|------------|------------|
|   | Right                | Thru | Left | Peds | App. Total | Right                      | Thru | Left | Peds | App. Total | Right                | Thru | Left | Peds | App. Total | Right                      | Thru | Left | Peds | App. Total |            |
| <b>Peak Hour Analysis From 04:00 PM to 05:45 PM - Peak 1 of 1</b> |                      |      |      |      |            |                            |      |      |      |            |                      |      |      |      |            |                            |      |      |      |            |            |
| Peak Hour for Entire Intersection Begins at 04:30 PM              |                      |      |      |      |            |                            |      |      |      |            |                      |      |      |      |            |                            |      |      |      |            |            |
| 04:30 PM  | 25                   | 200  | 21   | 7    | 253        | 0                          | 92   | 46   | 4    | 142        | 0                    | 0    | 0    | 24   | 24         | 51                         | 145  | 0    | 4    | 200        | 619        |
| 04:45 PM  | 16                   | 209  | 24   | 9    | 258        | 0                          | 93   | 37   | 3    | 133        | 0                    | 0    | 0    | 12   | 12         | 45                         | 136  | 0    | 7    | 188        | 591        |
| 05:00 PM  | 33                   | 222  | 35   | 5    | 295        | 0                          | 126  | 48   | 4    | 178        | 0                    | 0    | 0    | 6    | 6          | 38                         | 182  | 0    | 5    | 225        | 704        |
| 05:15 PM  | 20                   | 222  | 30   | 2    | 274        | 0                          | 119  | 32   | 7    | 158        | 0                    | 0    | 0    | 5    | 5          | 50                         | 176  | 0    | 7    | 233        | 670        |
| Total Volume  | 94                   | 853  | 110  | 23   | 1080       | 0                          | 430  | 163  | 18   | 611        | 0                    | 0    | 0    | 47   | 47         | 184                        | 639  | 0    | 23   | 846        | 2584       |
| % App. Total  | 8.7                  | 79   | 10.2 | 2.1  |            | 0                          | 70.4 | 26.7 | 2.9  |            | 0                    | 0    | 0    | 100  |            | 21.7                       | 75.5 | 0    | 2.7  |            |            |
| PHF   | .712                 | .961 | .786 | .639 | .915       | .000                       | .853 | .849 | .643 | .858       | .000                 | .000 | .000 | .490 | .490       | .902                       | .878 | .000 | .821 | .908       | .918       |

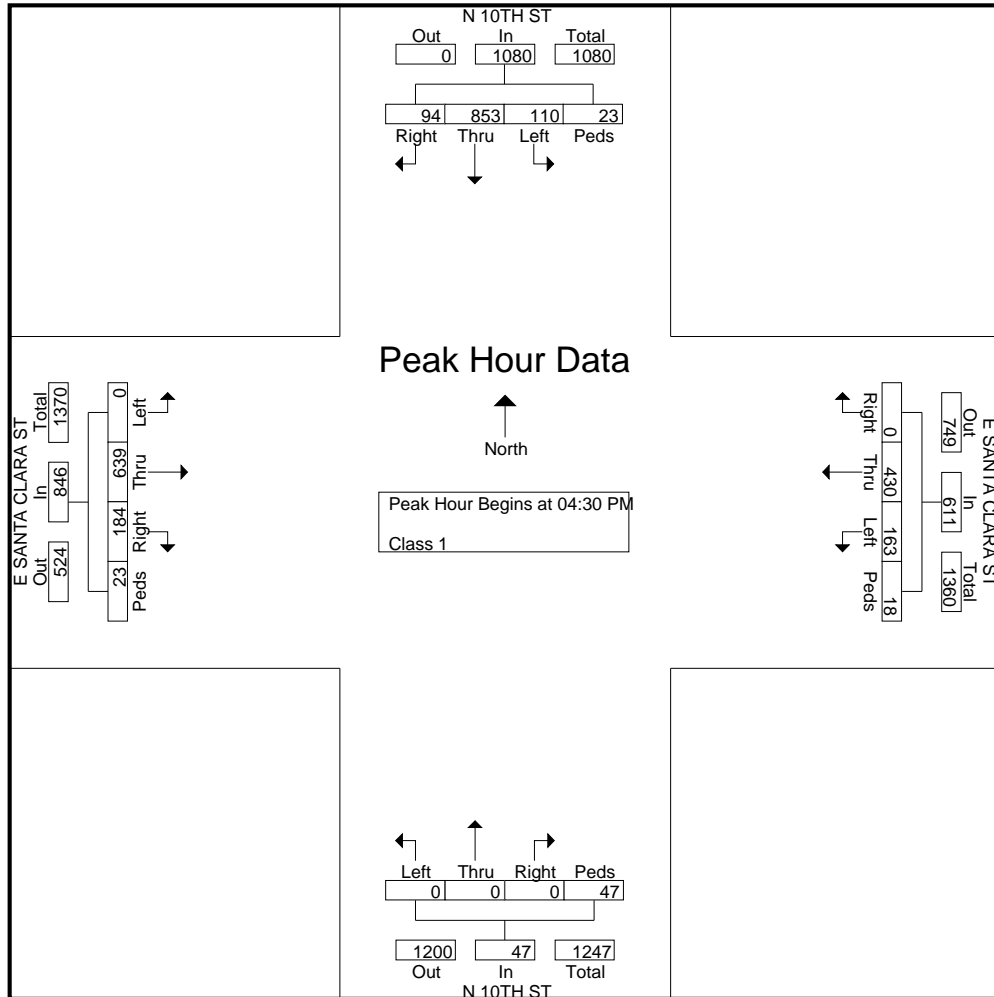

File Name : #101 MARKET&STJAMESAM  
 Site Code :  
 Start Date : 5/20/2015  
 Page No : 1

Groups Printed- Class 1

| Start Time  | N MARKET ST Southbound |      |      |      | W ST JAMES ST Westbound |      |      |      | N MARKET ST Northbound |      |      |      | W ST JAMES ST Eastbound |      |      |      | Int. Total |
|-------------|------------------------|------|------|------|-------------------------|------|------|------|------------------------|------|------|------|-------------------------|------|------|------|------------|
|             | Right                  | Thru | Left | Peds | Right                   | Thru | Left | Peds | Right                  | Thru | Left | Peds | Right                   | Thru | Left | Peds |            |
| 07:00 AM    | 0                      | 48   | 8    | 0    | 0                       | 0    | 0    | 0    | 3                      | 183  | 0    | 2    | 5                       | 60   | 31   | 1    | 341        |
| 07:15 AM    | 0                      | 82   | 11   | 0    | 0                       | 0    | 0    | 4    | 5                      | 210  | 0    | 2    | 19                      | 87   | 38   | 1    | 459        |
| 07:30 AM    | 0                      | 83   | 17   | 0    | 0                       | 0    | 0    | 2    | 4                      | 218  | 0    | 4    | 16                      | 95   | 53   | 0    | 492        |
| 07:45 AM    | 0                      | 109  | 22   | 0    | 0                       | 0    | 0    | 7    | 12                     | 195  | 0    | 4    | 26                      | 114  | 55   | 1    | 545        |
| Total       | 0                      | 322  | 58   | 0    | 0                       | 0    | 0    | 13   | 24                     | 806  | 0    | 12   | 66                      | 356  | 177  | 3    | 1837       |
| 08:00 AM    | 0                      | 100  | 17   | 0    | 0                       | 0    | 0    | 3    | 10                     | 200  | 0    | 6    | 29                      | 119  | 65   | 2    | 551        |
| 08:15 AM    | 0                      | 99   | 24   | 0    | 0                       | 0    | 0    | 3    | 7                      | 191  | 0    | 7    | 31                      | 103  | 63   | 3    | 531        |
| 08:30 AM    | 0                      | 104  | 22   | 0    | 0                       | 0    | 0    | 3    | 8                      | 159  | 0    | 4    | 28                      | 99   | 52   | 3    | 482        |
| 08:45 AM    | 0                      | 98   | 22   | 0    | 0                       | 0    | 0    | 2    | 11                     | 126  | 0    | 10   | 22                      | 122  | 50   | 7    | 470        |
| Total       | 0                      | 401  | 85   | 0    | 0                       | 0    | 0    | 11   | 36                     | 676  | 0    | 27   | 110                     | 443  | 230  | 15   | 2034       |
| Grand Total | 0                      | 723  | 143  | 0    | 0                       | 0    | 0    | 24   | 60                     | 1482 | 0    | 39   | 176                     | 799  | 407  | 18   | 3871       |
| Apprch %    | 0                      | 83.5 | 16.5 | 0    | 0                       | 0    | 0    | 100  | 3.8                    | 93.7 | 0    | 2.5  | 12.6                    | 57.1 | 29.1 | 1.3  |            |
| Total %     | 0                      | 18.7 | 3.7  | 0    | 0                       | 0    | 0    | 0.6  | 1.5                    | 38.3 | 0    | 1    | 4.5                     | 20.6 | 10.5 | 0.5  |            |

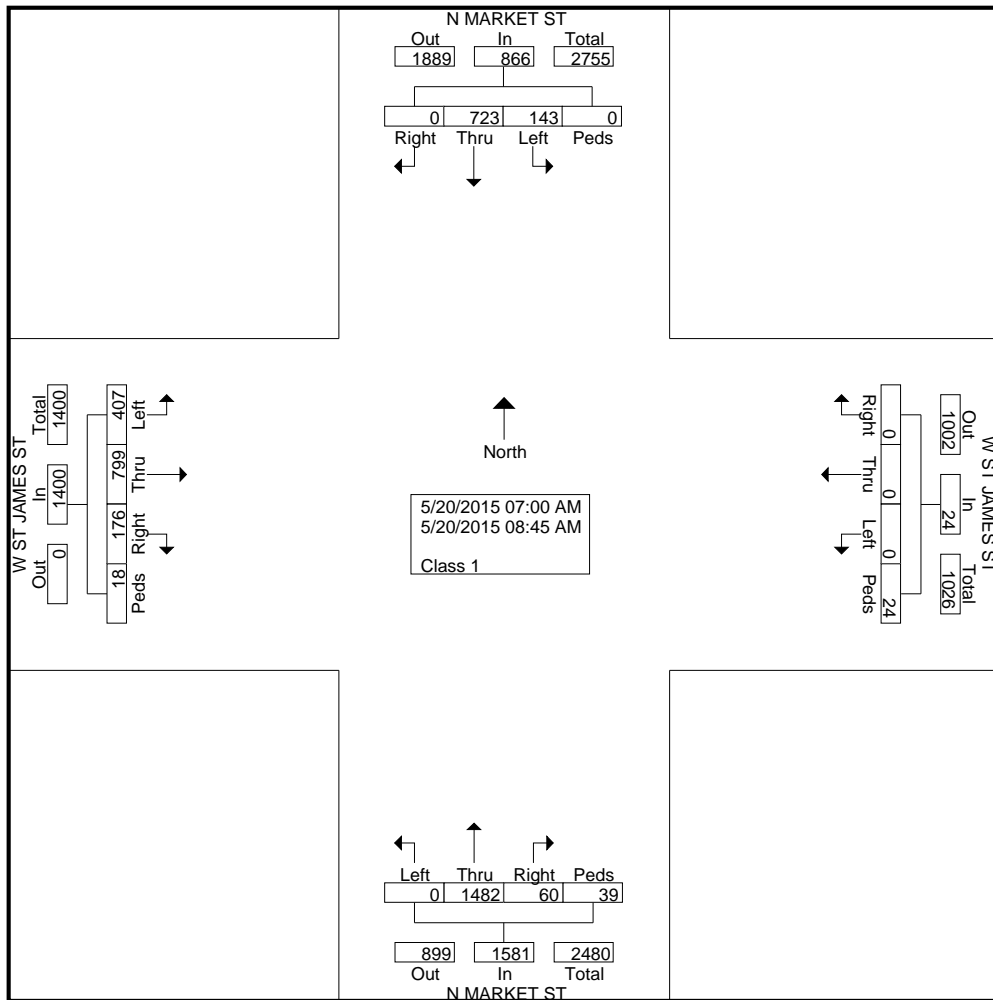

File Name : #101 MARKET&STJAMESAM  
 Site Code :  
 Start Date : 5/20/2015  
 Page No : 2

| Start Time  | N MARKET ST Southbound |      |      |      |            | W ST JAMES ST Westbound |      |      |      |            | N MARKET ST Northbound |      |      |      |            | W ST JAMES ST Eastbound |      |      |      |            | Int. Total |
|---|------------------------|------|------|------|------------|-------------------------|------|------|------|------------|------------------------|------|------|------|------------|-------------------------|------|------|------|------------|------------|
|   | Right                  | Thru | Left | Peds | App. Total | Right                   | Thru | Left | Peds | App. Total | Right                  | Thru | Left | Peds | App. Total | Right                   | Thru | Left | Peds | App. Total |            |
| <b>Peak Hour Analysis From 07:00 AM to 08:45 AM - Peak 1 of 1</b> |                        |      |      |      |            |                         |      |      |      |            |                        |      |      |      |            |                         |      |      |      |            |            |
| Peak Hour for Entire Intersection Begins at 07:30 AM              |                        |      |      |      |            |                         |      |      |      |            |                        |      |      |      |            |                         |      |      |      |            |            |
| 07:30 AM  | 0                      | 83   | 17   | 0    | 100        | 0                       | 0    | 0    | 2    | 2          | 4                      | 218  | 0    | 4    | 226        | 16                      | 95   | 53   | 0    | 164        | 492        |
| 07:45 AM  | 0                      | 109  | 22   | 0    | 131        | 0                       | 0    | 0    | 7    | 7          | 12                     | 195  | 0    | 4    | 211        | 26                      | 114  | 55   | 1    | 196        | 545        |
| 08:00 AM  | 0                      | 100  | 17   | 0    | 117        | 0                       | 0    | 0    | 3    | 3          | 10                     | 200  | 0    | 6    | 216        | 29                      | 119  | 65   | 2    | 215        | 551        |
| 08:15 AM  | 0                      | 99   | 24   | 0    | 123        | 0                       | 0    | 0    | 3    | 3          | 7                      | 191  | 0    | 7    | 205        | 31                      | 103  | 63   | 3    | 200        | 531        |
| Total Volume  | 0                      | 391  | 80   | 0    | 471        | 0                       | 0    | 0    | 15   | 15         | 33                     | 804  | 0    | 21   | 858        | 102                     | 431  | 236  | 6    | 775        | 2119       |
| % App. Total  | 0                      | 83   | 17   | 0    |            | 0                       | 0    | 0    | 100  |            | 3.8                    | 93.7 | 0    | 2.4  |            | 13.2                    | 55.6 | 30.5 | 0.8  |            |            |
| PHF   | .000                   | .897 | .833 | .000 | .899       | .000                    | .000 | .000 | .536 | .536       | .688                   | .922 | .000 | .750 | .949       | .823                    | .905 | .908 | .500 | .901       | .961       |

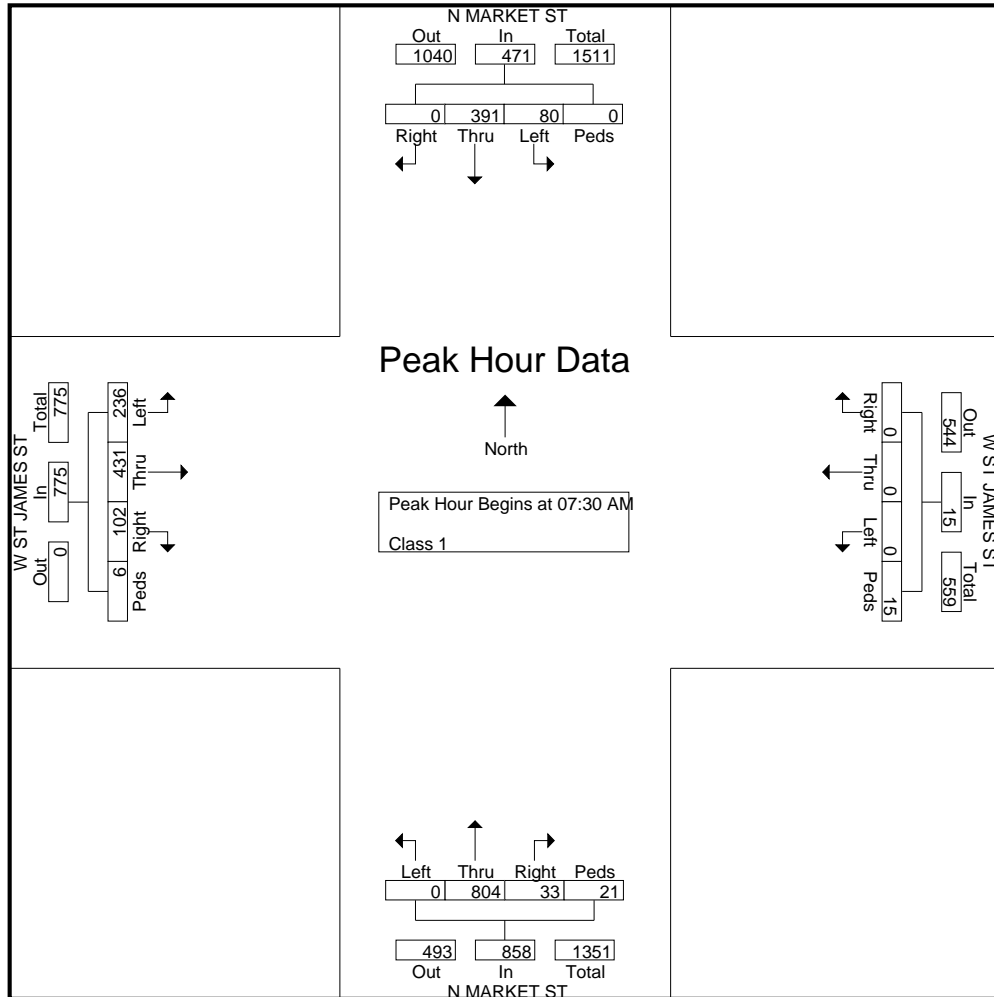



File Name : #101 MARKET&STJAMESPM  
 Site Code :  
 Start Date : 5/19/2015  
 Page No : 1

Groups Printed- Class 1

| Start Time  | N MARKET ST Southbound |      |      |      | W ST JAMES ST Westbound |      |      |      | N MARKET ST Northbound |      |      |      | W ST JAMES ST Eastbound |      |      |      | Int. Total |
|-------------|------------------------|------|------|------|-------------------------|------|------|------|------------------------|------|------|------|-------------------------|------|------|------|------------|
|             | Right                  | Thru | Left | Peds | Right                   | Thru | Left | Peds | Right                  | Thru | Left | Peds | Right                   | Thru | Left | Peds |            |
| 04:00 PM    | 0                      | 116  | 10   | 0    | 0                       | 0    | 0    | 3    | 0                      | 0    | 0    | 11   | 14                      | 143  | 24   | 5    | 326        |
| 04:15 PM    | 0                      | 142  | 11   | 0    | 0                       | 0    | 0    | 4    | 5                      | 30   | 0    | 9    | 8                       | 112  | 24   | 7    | 352        |
| 04:30 PM    | 0                      | 250  | 36   | 0    | 0                       | 0    | 0    | 6    | 5                      | 50   | 0    | 7    | 18                      | 129  | 32   | 1    | 534        |
| 04:45 PM    | 0                      | 202  | 46   | 0    | 0                       | 0    | 0    | 6    | 11                     | 96   | 0    | 10   | 11                      | 147  | 39   | 3    | 571        |
| Total       | 0                      | 710  | 103  | 0    | 0                       | 0    | 0    | 19   | 21                     | 176  | 0    | 37   | 51                      | 531  | 119  | 16   | 1783       |
| 05:00 PM    | 0                      | 203  | 54   | 0    | 0                       | 0    | 0    | 2    | 12                     | 111  | 0    | 4    | 18                      | 144  | 44   | 5    | 597        |
| 05:15 PM    | 0                      | 233  | 47   | 0    | 0                       | 0    | 0    | 4    | 10                     | 93   | 0    | 9    | 33                      | 185  | 31   | 7    | 652        |
| 05:30 PM    | 0                      | 271  | 36   | 0    | 0                       | 0    | 0    | 4    | 8                      | 81   | 0    | 5    | 25                      | 131  | 32   | 5    | 598        |
| 05:45 PM    | 0                      | 242  | 64   | 0    | 0                       | 0    | 0    | 9    | 9                      | 55   | 0    | 8    | 28                      | 158  | 26   | 7    | 606        |
| Total       | 0                      | 949  | 201  | 0    | 0                       | 0    | 0    | 19   | 39                     | 340  | 0    | 26   | 104                     | 618  | 133  | 24   | 2453       |
| Grand Total | 0                      | 1659 | 304  | 0    | 0                       | 0    | 0    | 38   | 60                     | 516  | 0    | 63   | 155                     | 1149 | 252  | 40   | 4236       |
| Apprch %    | 0                      | 84.5 | 15.5 | 0    | 0                       | 0    | 0    | 100  | 9.4                    | 80.8 | 0    | 9.9  | 9.7                     | 72   | 15.8 | 2.5  |            |
| Total %     | 0                      | 39.2 | 7.2  | 0    | 0                       | 0    | 0    | 0.9  | 1.4                    | 12.2 | 0    | 1.5  | 3.7                     | 27.1 | 5.9  | 0.9  |            |

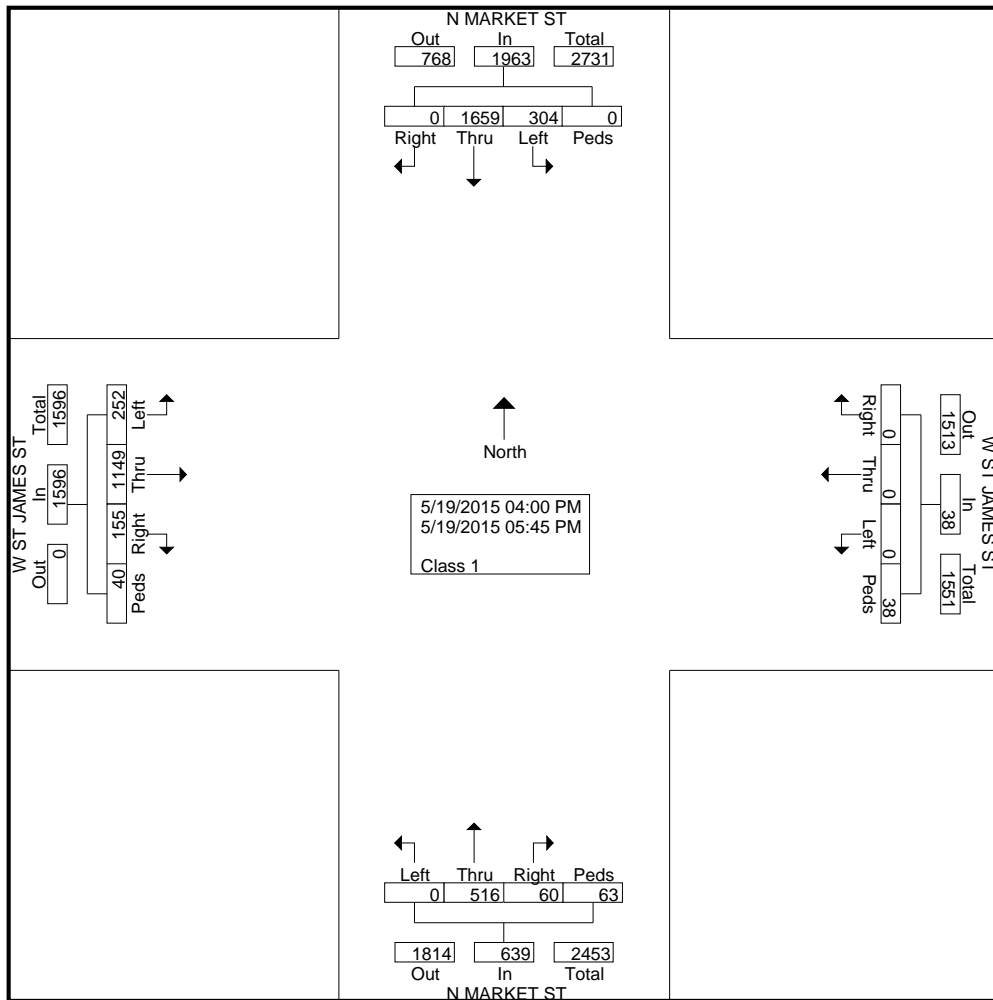

| Start Time  | N MARKET ST Southbound |      |      |      |            | W ST JAMES ST Westbound |      |      |      |            | N MARKET ST Northbound |      |      |      |            | W ST JAMES ST Eastbound |      |      |      |            | Int. Total |
|---|------------------------|------|------|------|------------|-------------------------|------|------|------|------------|------------------------|------|------|------|------------|-------------------------|------|------|------|------------|------------|
|   | Right                  | Thru | Left | Peds | App. Total | Right                   | Thru | Left | Peds | App. Total | Right                  | Thru | Left | Peds | App. Total | Right                   | Thru | Left | Peds | App. Total |            |
| <b>Peak Hour Analysis From 04:00 PM to 05:45 PM - Peak 1 of 1</b> |                        |      |      |      |            |                         |      |      |      |            |                        |      |      |      |            |                         |      |      |      |            |            |
| Peak Hour for Entire Intersection Begins at 05:00 PM              |                        |      |      |      |            |                         |      |      |      |            |                        |      |      |      |            |                         |      |      |      |            |            |
| 05:00 PM  | 0                      | 203  | 54   | 0    | 257        | 0                       | 0    | 0    | 2    | 2          | 12                     | 111  | 0    | 4    | 127        | 18                      | 144  | 44   | 5    | 211        | 597        |
| 05:15 PM  | 0                      | 233  | 47   | 0    | 280        | 0                       | 0    | 0    | 4    | 4          | 10                     | 93   | 0    | 9    | 112        | 33                      | 185  | 31   | 7    | 256        | 652        |
| 05:30 PM  | 0                      | 271  | 36   | 0    | 307        | 0                       | 0    | 0    | 4    | 4          | 8                      | 81   | 0    | 5    | 94         | 25                      | 131  | 32   | 5    | 193        | 598        |
| 05:45 PM  | 0                      | 242  | 64   | 0    | 306        | 0                       | 0    | 0    | 9    | 9          | 9                      | 55   | 0    | 8    | 72         | 28                      | 158  | 26   | 7    | 219        | 606        |
| Total Volume  | 0                      | 949  | 201  | 0    | 1150       | 0                       | 0    | 0    | 19   | 19         | 39                     | 340  | 0    | 26   | 405        | 104                     | 618  | 133  | 24   | 879        | 2453       |
| % App. Total  | 0                      | 82.5 | 17.5 | 0    |            | 0                       | 0    | 0    | 100  |            | 9.6                    | 84   | 0    | 6.4  |            | 11.8                    | 70.3 | 15.1 | 2.7  |            |            |
| PHF   | .000                   | .875 | .785 | .000 | .936       | .000                    | .000 | .000 | .528 | .528       | .813                   | .766 | .000 | .722 | .797       | .788                    | .835 | .756 | .857 | .858       | .941       |

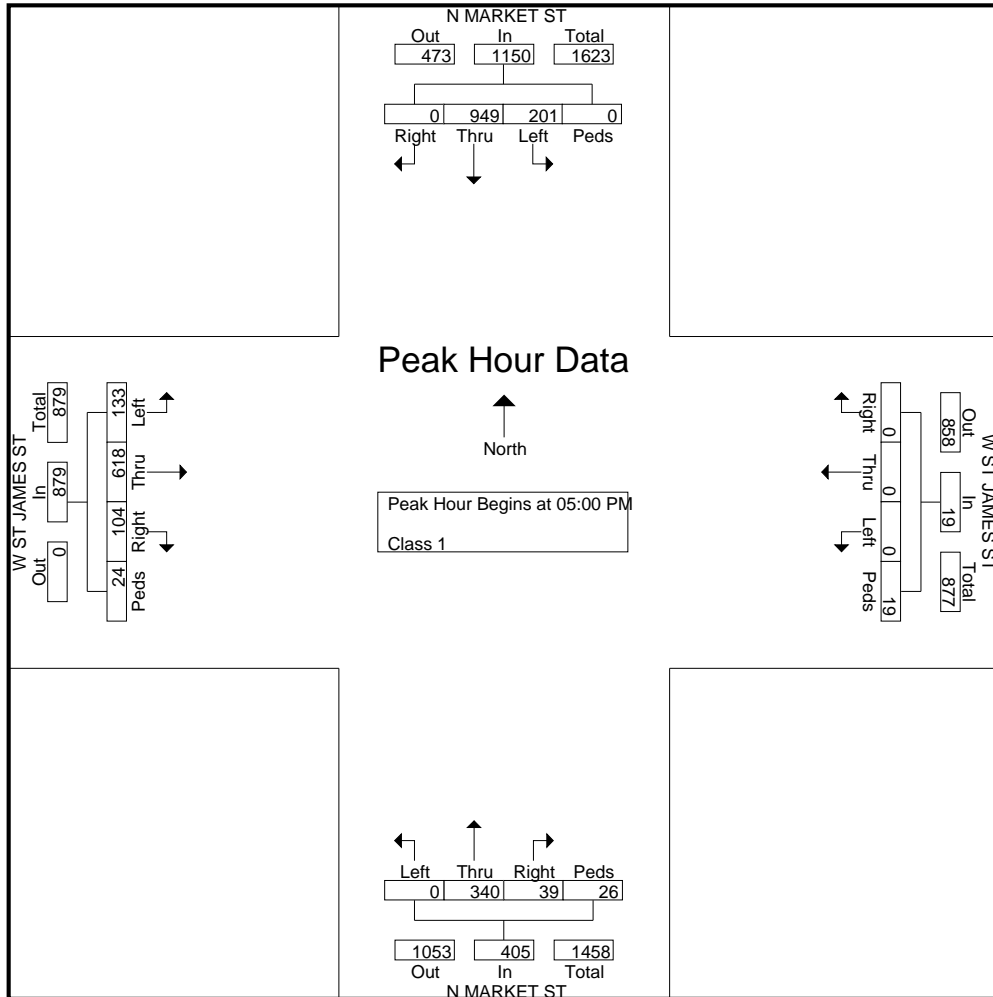

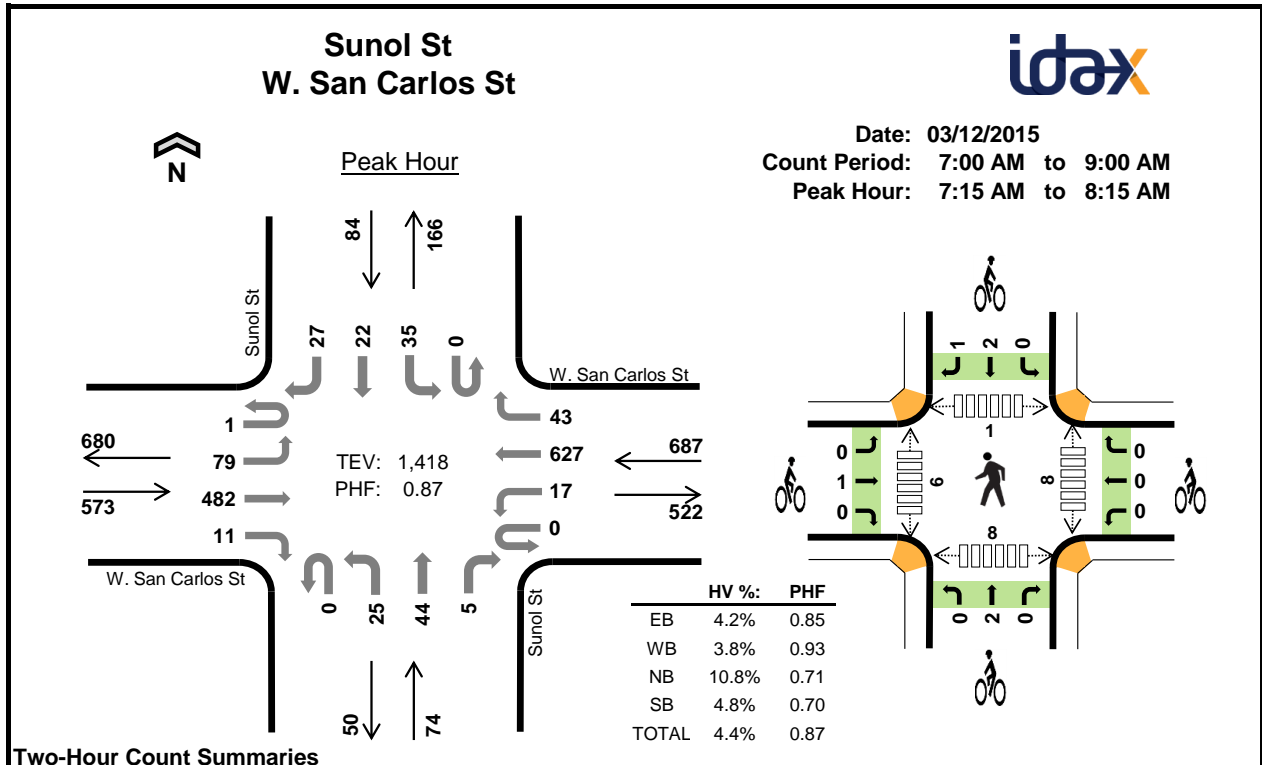

**Two-Hour Count Summaries**

| Interval Start | W. San Carlos St Eastbound |     |     |     | W. San Carlos St Westbound |    |       |     | Sunol St Northbound |    |     |    | Sunol St Southbound |    |    |     | 15-min Total | Rolling One Hour |   |
|----------------|----------------------------|-----|-----|-----|----------------------------|----|-------|-----|---------------------|----|-----|----|---------------------|----|----|-----|--------------|------------------|---|
|                | UT                         | LT  | TH  | RT  | UT                         | LT | TH    | RT  | UT                  | LT | TH  | RT | UT                  | LT | TH | RT  |              |                  |   |
| 7:00 AM        | 0                          | 4   | 53  | 4   | 0                          | 1  | 106   | 10  | 0                   | 1  | 7   | 2  | 0                   | 3  | 2  | 7   | 200          | 0                |   |
| 7:15 AM        | 0                          | 9   | 84  | 2   | 0                          | 1  | 172   | 12  | 0                   | 7  | 9   | 0  | 0                   | 8  | 3  | 6   | 313          | 0                |   |
| 7:30 AM        | 0                          | 25  | 117 | 3   | 0                          | 3  | 143   | 7   | 0                   | 2  | 8   | 1  | 0                   | 10 | 2  | 4   | 325          | 0                |   |
| 7:45 AM        | 0                          | 25  | 140 | 3   | 0                          | 5  | 163   | 14  | 0                   | 7  | 18  | 1  | 0                   | 11 | 8  | 11  | 406          | 1,244            |   |
| 8:00 AM        | 1                          | 20  | 141 | 3   | 0                          | 8  | 149   | 10  | 0                   | 9  | 9   | 3  | 0                   | 6  | 9  | 6   | 374          | 1,418            |   |
| 8:15 AM        | 0                          | 14  | 126 | 5   | 0                          | 1  | 113   | 8   | 0                   | 1  | 9   | 4  | 0                   | 8  | 4  | 4   | 297          | 1,402            |   |
| 8:30 AM        | 0                          | 13  | 133 | 2   | 0                          | 2  | 98    | 7   | 0                   | 8  | 6   | 6  | 0                   | 8  | 3  | 3   | 289          | 1,366            |   |
| 8:45 AM        | 0                          | 15  | 106 | 5   | 1                          | 2  | 103   | 10  | 0                   | 5  | 13  | 2  | 0                   | 9  | 3  | 6   | 280          | 1,240            |   |
| Count Total    | 1                          | 125 | 900 | 27  | 1                          | 23 | 1,047 | 78  | 0                   | 40 | 79  | 19 | 0                   | 63 | 34 | 47  | 2,484        | 0                |   |
| Peak Hour      | All                        | 1   | 79  | 482 | 11                         | 0  | 17    | 627 | 43                  | 0  | 25  | 44 | 5                   | 0  | 35 | 22  | 27           | 1,418            | 0 |
|                | HV                         | 0   | 1   | 19  | 4                          | 0  | 1     | 25  | 0                   | 0  | 5   | 2  | 1                   | 0  | 0  | 3   | 1            | 62               | 0 |
|                | HV%                        | 0%  | 1%  | 4%  | 36%                        | -  | 6%    | 4%  | 0%                  | -  | 20% | 5% | 20%                 | -  | 0% | 14% | 4%           | 4%               | 0 |

Note: Two-hour count summary volumes include heavy vehicles but exclude bicycles in overall count.

| Interval Start | Heavy Vehicle Totals |    |    |    |       | Bicycles |    |    |    |       | Pedestrians (Crossing Leg) |      |       |       |       |
|----------------|----------------------|----|----|----|-------|----------|----|----|----|-------|----------------------------|------|-------|-------|-------|
|                | EB                   | WB | NB | SB | Total | EB       | WB | NB | SB | Total | East                       | West | North | South | Total |
| 7:00 AM        | 3                    | 9  | 3  | 0  | 15    | 0        | 0  | 0  | 0  | 0     | 1                          | 1    | 0     | 1     | 3     |
| 7:15 AM        | 4                    | 7  | 0  | 1  | 12    | 0        | 0  | 1  | 0  | 1     | 2                          | 1    | 1     | 1     | 5     |
| 7:30 AM        | 5                    | 7  | 0  | 0  | 12    | 0        | 0  | 0  | 2  | 2     | 4                          | 4    | 0     | 1     | 9     |
| 7:45 AM        | 5                    | 5  | 3  | 1  | 14    | 0        | 0  | 0  | 0  | 0     | 1                          | 1    | 0     | 3     | 5     |
| 8:00 AM        | 10                   | 7  | 5  | 2  | 24    | 1        | 0  | 1  | 1  | 3     | 1                          | 0    | 0     | 3     | 4     |
| 8:15 AM        | 7                    | 6  | 2  | 0  | 15    | 2        | 0  | 0  | 1  | 3     | 2                          | 0    | 1     | 1     | 4     |
| 8:30 AM        | 5                    | 4  | 7  | 0  | 16    | 0        | 0  | 0  | 0  | 0     | 0                          | 0    | 1     | 1     | 2     |
| 8:45 AM        | 8                    | 8  | 2  | 1  | 19    | 1        | 0  | 0  | 1  | 2     | 1                          | 0    | 0     | 3     | 4     |
| Count Total    | 47                   | 53 | 22 | 5  | 127   | 4        | 0  | 2  | 5  | 11    | 12                         | 7    | 3     | 14    | 36    |
| Peak Hour      | 24                   | 26 | 8  | 4  | 62    | 1        | 0  | 2  | 3  | 6     | 8                          | 6    | 1     | 8     | 23    |

| <b>Two-Hour Count Summaries - Heavy Vehicles</b> |                  |    |    |    |                  |    |    |    |            |    |    |    |            |    |    |    |              |                  |
|--|------------------|----|----|----|------------------|----|----|----|------------|----|----|----|------------|----|----|----|--------------|------------------|
| Interval Start                                   | W. San Carlos St |    |    |    | W. San Carlos St |    |    |    | Sunol St   |    |    |    | Sunol St   |    |    |    | 15-min Total | Rolling One Hour |
|  | Eastbound        |    |    |    | Westbound        |    |    |    | Northbound |    |    |    | Southbound |    |    |    |              |                  |
|  | UT               | LT | TH | RT | UT               | LT | TH | RT | UT         | LT | TH | RT | UT         | LT | TH | RT |              |                  |
| 7:00 AM  | 0                | 0  | 3  | 0  | 0                | 0  | 8  | 1  | 0          | 0  | 2  | 1  | 0          | 0  | 0  | 0  | 15           | 0                |
| 7:15 AM  | 0                | 0  | 4  | 0  | 0                | 0  | 7  | 0  | 0          | 0  | 0  | 0  | 0          | 0  | 1  | 0  | 12           | 0                |
| 7:30 AM  | 0                | 0  | 4  | 1  | 0                | 0  | 7  | 0  | 0          | 0  | 0  | 0  | 0          | 0  | 0  | 0  | 12           | 0                |
| 7:45 AM  | 0                | 1  | 2  | 2  | 0                | 0  | 5  | 0  | 0          | 1  | 2  | 0  | 0          | 0  | 1  | 0  | 14           | 53               |
| 8:00 AM  | 0                | 0  | 9  | 1  | 0                | 1  | 6  | 0  | 0          | 4  | 0  | 1  | 0          | 0  | 1  | 1  | 24           | 62               |
| 8:15 AM  | 0                | 0  | 5  | 2  | 0                | 0  | 6  | 0  | 0          | 1  | 0  | 1  | 0          | 0  | 0  | 0  | 15           | 65               |
| 8:30 AM  | 0                | 0  | 4  | 1  | 0                | 1  | 3  | 0  | 0          | 4  | 0  | 3  | 0          | 0  | 0  | 0  | 16           | 69               |
| 8:45 AM  | 0                | 0  | 6  | 2  | 0                | 2  | 6  | 0  | 0          | 1  | 0  | 1  | 0          | 0  | 1  | 0  | 19           | 74               |
| Count Total                                      | 0                | 1  | 37 | 9  | 0                | 4  | 48 | 1  | 0          | 11 | 4  | 7  | 0          | 0  | 4  | 1  | 127          | 0                |
| Peak Hour  | 0                | 1  | 19 | 4  | 0                | 1  | 25 | 0  | 0          | 5  | 2  | 1  | 0          | 0  | 3  | 1  | 62           | 0                |

| <b>Two-Hour Count Summaries - Bikes</b> |                  |    |    |                  |    |    |            |    |    |            |    |    |              |                  |
|---|------------------|----|----|------------------|----|----|------------|----|----|------------|----|----|--------------|------------------|
| Interval Start                          | W. San Carlos St |    |    | W. San Carlos St |    |    | Sunol St   |    |    | Sunol St   |    |    | 15-min Total | Rolling One Hour |
|   | Eastbound        |    |    | Westbound        |    |    | Northbound |    |    | Southbound |    |    |              |                  |
|   | LT               | TH | RT | LT               | TH | RT | LT         | TH | RT | LT         | TH | RT |              |                  |
| 7:00 AM                                 | 0                | 0  | 0  | 0                | 0  | 0  | 0          | 0  | 0  | 0          | 0  | 0  | 0            | 0                |
| 7:15 AM                                 | 0                | 0  | 0  | 0                | 0  | 0  | 0          | 1  | 0  | 0          | 0  | 0  | 1            | 0                |
| 7:30 AM                                 | 0                | 0  | 0  | 0                | 0  | 0  | 0          | 0  | 0  | 0          | 1  | 1  | 2            | 0                |
| 7:45 AM                                 | 0                | 0  | 0  | 0                | 0  | 0  | 0          | 0  | 0  | 0          | 0  | 0  | 0            | 3                |
| 8:00 AM                                 | 0                | 1  | 0  | 0                | 0  | 0  | 0          | 1  | 0  | 0          | 1  | 0  | 3            | 6                |
| 8:15 AM                                 | 2                | 0  | 0  | 0                | 0  | 0  | 0          | 0  | 0  | 0          | 1  | 0  | 3            | 8                |
| 8:30 AM                                 | 0                | 0  | 0  | 0                | 0  | 0  | 0          | 0  | 0  | 0          | 0  | 0  | 0            | 6                |
| 8:45 AM                                 | 0                | 1  | 0  | 0                | 0  | 0  | 0          | 0  | 0  | 0          | 0  | 1  | 2            | 8                |
| Count Total                             | 2                | 2  | 0  | 0                | 0  | 0  | 0          | 2  | 0  | 0          | 3  | 2  | 11           | 0                |
| Peak Hour                               | 0                | 1  | 0  | 0                | 0  | 0  | 0          | 2  | 0  | 0          | 2  | 1  | 6            | 0                |

Note: U-Turn volumes for bikes are included in Left-Turn, if any.

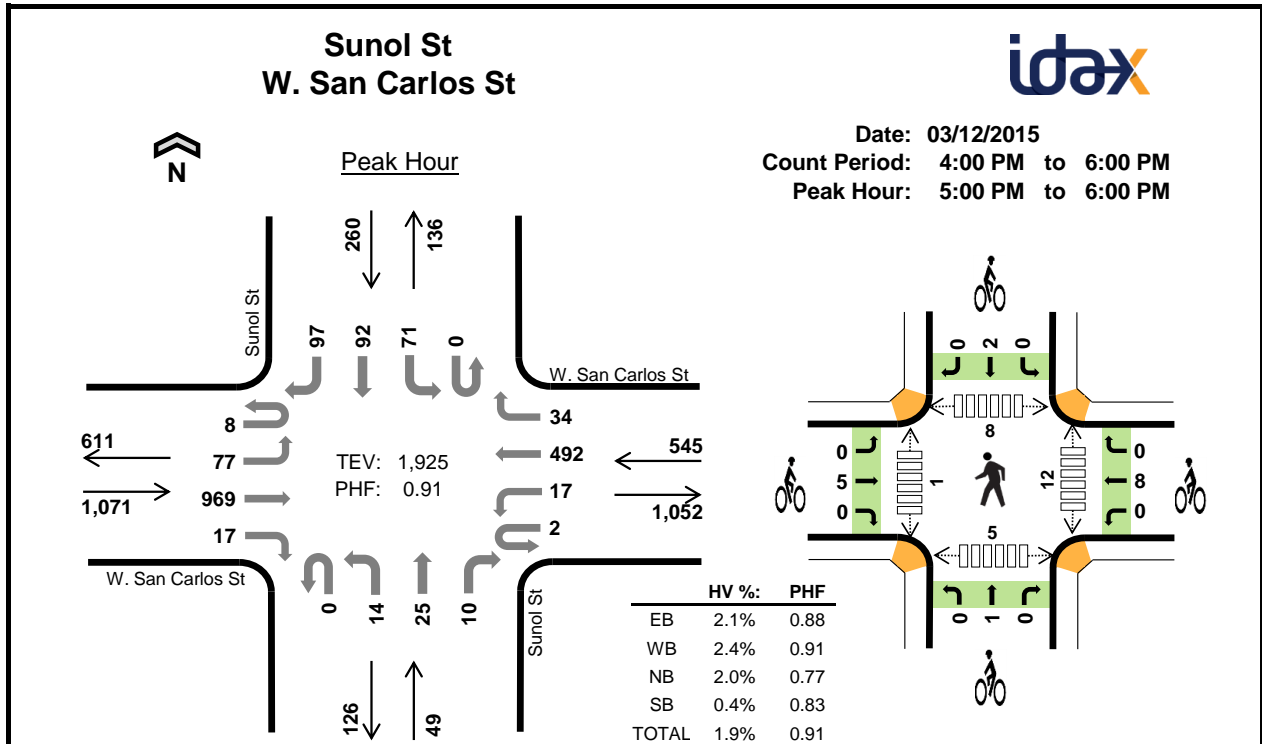

**Two-Hour Count Summaries**

| Interval Start | W. San Carlos St Eastbound |     |       |     | W. San Carlos St Westbound |    |     |     | Sunol St Northbound |    |    |    | Sunol St Southbound |     |     |     | 15-min Total | Rolling One Hour |   |
|----------------|----------------------------|-----|-------|-----|----------------------------|----|-----|-----|---------------------|----|----|----|---------------------|-----|-----|-----|--------------|------------------|---|
|                | UT                         | LT  | TH    | RT  | UT                         | LT | TH  | RT  | UT                  | LT | TH | RT | UT                  | LT  | TH  | RT  |              |                  |   |
| 4:00 PM        | 0                          | 10  | 184   | 4   | 1                          | 3  | 87  | 7   | 0                   | 2  | 3  | 5  | 0                   | 11  | 13  | 14  | 344          | 0                |   |
| 4:15 PM        | 3                          | 6   | 215   | 5   | 1                          | 5  | 98  | 5   | 0                   | 1  | 1  | 1  | 0                   | 11  | 10  | 13  | 375          | 0                |   |
| 4:30 PM        | 1                          | 19  | 211   | 3   | 0                          | 7  | 104 | 5   | 0                   | 6  | 12 | 2  | 0                   | 18  | 11  | 21  | 420          | 0                |   |
| 4:45 PM        | 1                          | 23  | 203   | 2   | 0                          | 1  | 116 | 5   | 0                   | 0  | 10 | 1  | 0                   | 15  | 19  | 17  | 413          | 1,552            |   |
| 5:00 PM        | 2                          | 23  | 254   | 7   | 0                          | 4  | 116 | 9   | 0                   | 5  | 4  | 2  | 0                   | 17  | 27  | 22  | 492          | 1,700            |   |
| 5:15 PM        | 1                          | 22  | 279   | 3   | 0                          | 3  | 141 | 6   | 0                   | 4  | 7  | 2  | 0                   | 18  | 14  | 28  | 528          | 1,853            |   |
| 5:30 PM        | 1                          | 12  | 233   | 3   | 2                          | 4  | 132 | 9   | 0                   | 3  | 9  | 4  | 0                   | 19  | 31  | 28  | 490          | 1,923            |   |
| 5:45 PM        | 4                          | 20  | 203   | 4   | 0                          | 6  | 103 | 10  | 0                   | 2  | 5  | 2  | 0                   | 17  | 20  | 19  | 415          | 1,925            |   |
| Count Total    | 13                         | 135 | 1,782 | 31  | 4                          | 33 | 897 | 56  | 0                   | 23 | 51 | 19 | 0                   | 126 | 145 | 162 | 3,477        | 0                |   |
| Peak Hour      | All                        | 8   | 77    | 969 | 17                         | 2  | 17  | 492 | 34                  | 0  | 14 | 25 | 10                  | 0   | 71  | 92  | 97           | 1,925            | 0 |
|                | HV                         | 0   | 3     | 19  | 0                          | 0  | 0   | 13  | 0                   | 0  | 0  | 0  | 1                   | 0   | 0   | 1   | 0            | 37               | 0 |
|                | HV%                        | 0%  | 4%    | 2%  | 0%                         | 0% | 0%  | 3%  | 0%                  | -  | 0% | 0% | 10%                 | -   | 0%  | 1%  | 0%           | 2%               | 0 |

Note: Two-hour count summary volumes include heavy vehicles but exclude bicycles in overall count.

| Interval Start | Heavy Vehicle Totals |    |    |    |       | Bicycles |    |    |    |       | Pedestrians (Crossing Leg) |      |       |       |       |
|----------------|----------------------|----|----|----|-------|----------|----|----|----|-------|----------------------------|------|-------|-------|-------|
|                | EB                   | WB | NB | SB | Total | EB       | WB | NB | SB | Total | East                       | West | North | South | Total |
| 4:00 PM        | 9                    | 2  | 1  | 0  | 12    | 4        | 0  | 1  | 0  | 5     | 1                          | 1    | 0     | 0     | 2     |
| 4:15 PM        | 4                    | 4  | 0  | 2  | 10    | 1        | 1  | 1  | 0  | 3     | 2                          | 0    | 0     | 1     | 3     |
| 4:30 PM        | 6                    | 3  | 0  | 2  | 11    | 0        | 1  | 1  | 1  | 3     | 2                          | 2    | 1     | 2     | 7     |
| 4:45 PM        | 6                    | 6  | 0  | 0  | 12    | 1        | 0  | 2  | 1  | 4     | 0                          | 1    | 3     | 3     | 7     |
| 5:00 PM        | 6                    | 3  | 1  | 0  | 10    | 1        | 3  | 0  | 1  | 5     | 3                          | 0    | 2     | 1     | 6     |
| 5:15 PM        | 7                    | 3  | 0  | 0  | 10    | 1        | 2  | 0  | 1  | 4     | 4                          | 0    | 0     | 0     | 4     |
| 5:30 PM        | 4                    | 4  | 0  | 1  | 9     | 1        | 3  | 0  | 0  | 4     | 0                          | 1    | 3     | 3     | 7     |
| 5:45 PM        | 5                    | 3  | 0  | 0  | 8     | 2        | 0  | 1  | 0  | 3     | 5                          | 0    | 3     | 1     | 9     |
| Count Total    | 47                   | 28 | 2  | 5  | 82    | 11       | 10 | 6  | 4  | 31    | 17                         | 5    | 12    | 11    | 45    |
| Peak Hour      | 22                   | 13 | 1  | 1  | 37    | 5        | 8  | 1  | 2  | 16    | 12                         | 1    | 8     | 5     | 26    |

| <b>Two-Hour Count Summaries - Heavy Vehicles</b>                         |                  |    |    |                  |                  |    |            |    |            |            |    |    |              |                  |    |    |              |                  |
|--|------------------|----|----|------------------|------------------|----|------------|----|------------|------------|----|----|--------------|------------------|----|----|--------------|------------------|
| Interval Start   | W. San Carlos St |    |    |                  | W. San Carlos St |    |            |    | Sunol St   |            |    |    | Sunol St     |                  |    |    | 15-min Total | Rolling One Hour |
|  | Eastbound        |    |    |                  | Westbound        |    |            |    | Northbound |            |    |    | Southbound   |                  |    |    |              |                  |
|  | UT               | LT | TH | RT               | UT               | LT | TH         | RT | UT         | LT         | TH | RT | UT           | LT               | TH | RT |              |                  |
| 4:00 PM  | 0                | 1  | 7  | 1                | 0                | 0  | 2          | 0  | 0          | 1          | 0  | 0  | 0            | 0                | 0  | 0  | 12           | 0                |
| 4:15 PM  | 0                | 0  | 4  | 0                | 0                | 0  | 4          | 0  | 0          | 0          | 0  | 0  | 0            | 0                | 0  | 0  | 10           | 0                |
| 4:30 PM  | 0                | 0  | 6  | 0                | 0                | 0  | 3          | 0  | 0          | 0          | 0  | 0  | 0            | 0                | 0  | 2  | 11           | 0                |
| 4:45 PM  | 0                | 0  | 6  | 0                | 0                | 0  | 5          | 1  | 0          | 0          | 0  | 0  | 0            | 0                | 0  | 0  | 12           | 45               |
| 5:00 PM  | 0                | 1  | 5  | 0                | 0                | 0  | 3          | 0  | 0          | 0          | 0  | 1  | 0            | 0                | 0  | 0  | 10           | 43               |
| 5:15 PM  | 0                | 1  | 6  | 0                | 0                | 0  | 3          | 0  | 0          | 0          | 0  | 0  | 0            | 0                | 0  | 0  | 10           | 43               |
| 5:30 PM  | 0                | 0  | 4  | 0                | 0                | 0  | 4          | 0  | 0          | 0          | 0  | 0  | 0            | 0                | 1  | 0  | 9            | 41               |
| 5:45 PM  | 0                | 1  | 4  | 0                | 0                | 0  | 3          | 0  | 0          | 0          | 0  | 0  | 0            | 0                | 0  | 0  | 8            | 37               |
| Count Total  | 0                | 4  | 42 | 1                | 0                | 0  | 27         | 1  | 0          | 1          | 0  | 1  | 0            | 0                | 3  | 2  | 82           | 0                |
| Peak Hour  | 0                | 3  | 19 | 0                | 0                | 0  | 13         | 0  | 0          | 0          | 0  | 1  | 0            | 0                | 1  | 0  | 37           | 0                |
| <b>Two-Hour Count Summaries - Bikes</b>                                  |                  |    |    |                  |                  |    |            |    |            |            |    |    |              |                  |    |    |              |                  |
| Interval Start   | W. San Carlos St |    |    | W. San Carlos St |                  |    | Sunol St   |    |            | Sunol St   |    |    | 15-min Total | Rolling One Hour |    |    |              |                  |
|  | Eastbound        |    |    | Westbound        |                  |    | Northbound |    |            | Southbound |    |    |              |                  |    |    |              |                  |
|  | LT               | TH | RT | LT               | TH               | RT | LT         | TH | RT         | LT         | TH | RT |              |                  |    |    |              |                  |
| 4:00 PM  | 1                | 3  | 0  | 0                | 0                | 0  | 1          | 0  | 0          | 0          | 0  | 0  | 0            | 5                | 0  |    |              |                  |
| 4:15 PM  | 0                | 0  | 1  | 0                | 1                | 0  | 0          | 1  | 0          | 0          | 0  | 0  | 0            | 3                | 0  |    |              |                  |
| 4:30 PM  | 0                | 0  | 0  | 0                | 1                | 0  | 0          | 1  | 0          | 0          | 1  | 0  | 0            | 3                | 0  |    |              |                  |
| 4:45 PM  | 0                | 1  | 0  | 0                | 0                | 0  | 0          | 2  | 0          | 0          | 1  | 0  | 0            | 4                | 15 |    |              |                  |
| 5:00 PM  | 0                | 1  | 0  | 0                | 3                | 0  | 0          | 0  | 0          | 0          | 1  | 0  | 0            | 5                | 15 |    |              |                  |
| 5:15 PM  | 0                | 1  | 0  | 0                | 2                | 0  | 0          | 0  | 0          | 0          | 1  | 0  | 0            | 4                | 16 |    |              |                  |
| 5:30 PM  | 0                | 1  | 0  | 0                | 3                | 0  | 0          | 0  | 0          | 0          | 0  | 0  | 0            | 4                | 17 |    |              |                  |
| 5:45 PM  | 0                | 2  | 0  | 0                | 0                | 0  | 0          | 1  | 0          | 0          | 0  | 0  | 0            | 3                | 16 |    |              |                  |
| Count Total  | 1                | 9  | 1  | 0                | 10               | 0  | 1          | 5  | 0          | 0          | 4  | 0  | 0            | 31               | 0  |    |              |                  |
| Peak Hour  | 0                | 5  | 0  | 0                | 8                | 0  | 0          | 1  | 0          | 0          | 2  | 0  | 0            | 16               | 0  |    |              |                  |
| <i>Note: U-Turn volumes for bikes are included in Left-Turn, if any.</i> |                  |    |    |                  |                  |    |            |    |            |            |    |    |              |                  |    |    |              |                  |

## **Appendix C**

**City of San Jose Approved Trips Inventory**  
**City of Santa Clara List of Approved Projects**

**AM APPROVED TRIPS**

07/22/2015

*Intersection of: 101/ALUM ROCK*

Page No: 1

Traffic Node Number: 3016

| Permit No. / Description / Location                           | M09 | M08 | M07 | M03 | M02 | M01 | M12 | M11 | M10 | M06 | M05 | M04 |
|---|-----|-----|-----|-----|-----|-----|-----|-----|-----|-----|-----|-----|
|   | NBL | NBT | NBR | SBL | SBT | SBR | EBL | EBT | EBR | WBL | WBT | WBR |
| NSJ<br>NORTH SAN JOSE   | 0   | 0   | 0   | 0   | 0   | 0   | 4   | 16  | 0   | 0   | 4   | 1   |
| -----   |     |     |     |     |     |     |     |     |     |     |     |     |
| PDA97-01-004<br>SJ MED CENTR<br>MCKEE RD & JACKSON AV (SW/C)  | 0   | 0   | 0   | 0   | 0   | 0   | 0   | 0   | 0   | 0   | 0   | 0   |
| -----   |     |     |     |     |     |     |     |     |     |     |     |     |
| PDC02-082<br>BLACKWELL HOUSING<br>ALUM ROCK & MCCREERY (SW/C) | 0   | 0   | 3   | 0   | 0   | 0   | 0   | 6   | 0   | 0   | 11  | 5   |
| -----   |     |     |     |     |     |     |     |     |     |     |     |     |
| <b>TOTAL:</b>   | 0   | 0   | 3   | 0   | 0   | 0   | 4   | 22  | 0   | 0   | 15  | 6   |

|       | LEFT | THRU | RIGHT |
|-------|------|------|-------|
| NORTH | 0    | 0    | 0     |
| EAST  | 0    | 15   | 6     |
| SOUTH | 0    | 0    | 3     |
| WEST  | 4    | 22   | 0     |



**PM APPROVED TRIPS**

07/22/2015

*Intersection of: 101/ALUM ROCK*

Page No: 2

Traffic Node Number: 3016

| Permit No. / Description / Location                           | M09 | M08 | M07 | M03 | M02 | M01 | M12 | M11 | M10 | M06 | M05 | M04 |
|---|-----|-----|-----|-----|-----|-----|-----|-----|-----|-----|-----|-----|
|   | NBL | NBT | NBR | SBL | SBT | SBR | EBL | EBT | EBR | WBL | WBT | WBR |
| NSJ<br>NORTH SAN JOSE   | 0   | 0   | 0   | 0   | 0   | 0   | 1   | 9   | 0   | 0   | 23  | 8   |
| -----   |     |     |     |     |     |     |     |     |     |     |     |     |
| PDA97-01-004<br>SJ MED CENTR<br>MCKEE RD & JACKSON AV (SW/C)  | 0   | 0   | 0   | 0   | 0   | 0   | 0   | 0   | 0   | 0   | 0   | 0   |
| -----   |     |     |     |     |     |     |     |     |     |     |     |     |
| PDC02-082<br>BLACKWELL HOUSING<br>ALUM ROCK & MCCREERY (SW/C) | 0   | 0   | 5   | 0   | 0   | 0   | 0   | 11  | 0   | 0   | 6   | 3   |
| -----   |     |     |     |     |     |     |     |     |     |     |     |     |
| <b>TOTAL:</b>   | 0   | 0   | 5   | 0   | 0   | 0   | 1   | 20  | 0   | 0   | 29  | 11  |

|       | LEFT | THRU | RIGHT |
|-------|------|------|-------|
| NORTH | 0    | 0    | 0     |
| EAST  | 0    | 29   | 11    |
| SOUTH | 0    | 0    | 5     |
| WEST  | 1    | 20   | 0     |

**AM APPROVED TRIPS**

07/22/2015

*Intersection of: 101/SANTA CLARA*

Page No: 1

Traffic Node Number: 3023

| Permit No. / Description / Location                                    | M09      | M08      | M07      | M03       | M02      | M01      | M12      | M11      | M10      | M06      | M05      | M04      |
|--|----------|----------|----------|-----------|----------|----------|----------|----------|----------|----------|----------|----------|
|  | NBL      | NBT      | NBR      | SBL       | SBT      | SBR      | EBL      | EBT      | EBR      | WBL      | WBT      | WBR      |
| NSJ<br>NORTH SAN JOSE  | 0        | 0        | 0        | 11        | 0        | 8        | 0        | 5        | 3        | 0        | 0        | 0        |
| -----<br>PDC02-082<br>BLACKWELL HOUSING<br>ALUM ROCK & MCCREERY (SW/C) | 0        | 0        | 0        | 3         | 0        | 0        | 0        | 3        | 0        | 5        | 5        | 0        |
| <b>TOTAL:</b>  | <b>0</b> | <b>0</b> | <b>0</b> | <b>14</b> | <b>0</b> | <b>8</b> | <b>0</b> | <b>8</b> | <b>3</b> | <b>5</b> | <b>5</b> | <b>0</b> |

|       | LEFT | THRU | RIGHT |
|-------|------|------|-------|
| NORTH | 14   | 0    | 8     |
| EAST  | 5    | 5    | 0     |
| SOUTH | 0    | 0    | 0     |
| WEST  | 0    | 8    | 3     |

**PM APPROVED TRIPS**

07/22/2015

*Intersection of: 101/SANTA CLARA*

Page No: 2

Traffic Node Number: 3023

| Permit No. / Description / Location                                    | M09      | M08      | M07      | M03       | M02      | M01      | M12      | M11       | M10      | M06      | M05      | M04      |
|--|----------|----------|----------|-----------|----------|----------|----------|-----------|----------|----------|----------|----------|
|  | NBL      | NBT      | NBR      | SBL       | SBT      | SBR      | EBL      | EBT       | EBR      | WBL      | WBT      | WBR      |
| NSJ<br>NORTH SAN JOSE  | 0        | 0        | 0        | 8         | 0        | 4        | 0        | 5         | 2        | 1        | 3        | 0        |
| -----<br>PDC02-082<br>BLACKWELL HOUSING<br>ALUM ROCK & MCCREERY (SW/C) | 0        | 0        | 0        | 5         | 0        | 0        | 0        | 5         | 0        | 3        | 3        | 0        |
| <b>TOTAL:</b>  | <b>0</b> | <b>0</b> | <b>0</b> | <b>13</b> | <b>0</b> | <b>4</b> | <b>0</b> | <b>10</b> | <b>2</b> | <b>4</b> | <b>6</b> | <b>0</b> |

|       | LEFT | THRU | RIGHT |
|-------|------|------|-------|
| NORTH | 13   | 0    | 4     |
| EAST  | 4    | 6    | 0     |
| SOUTH | 0    | 0    | 0     |
| WEST  | 0    | 10   | 2     |

**AM APPROVED TRIPS**

07/22/2015

*Intersection of: 280/MCLAUGHLIN*

Page No: 1

Traffic Node Number: 3036

| Permit No. / Description / Location  | M09      | M08       | M07      | M03      | M02       | M01      | M12      | M11      | M10       | M06      | M05      | M04      |
|--|----------|-----------|----------|----------|-----------|----------|----------|----------|-----------|----------|----------|----------|
|  | NBL      | NBT       | NBR      | SBL      | SBT       | SBR      | EBL      | EBT      | EBR       | WBL      | WBT      | WBR      |
| DOWNTOWN<br>DOWNTOWN STRATEGY PLAN 2000<br>DOWNTOWN CORE   | 0        | 5         | 0        | 0        | 1         | 0        | 0        | 0        | 0         | 0        | 0        | 0        |
| -----  |          |           |          |          |           |          |          |          |           |          |          |          |
| NSJ<br>NORTH SAN JOSE  | 0        | 8         | 0        | 0        | 0         | 0        | 0        | 0        | 0         | 0        | 0        | 0        |
| -----  |          |           |          |          |           |          |          |          |           |          |          |          |
| PDC03-108 OFF<br>BERRYESSA FLEA MKT (OFFICE)<br>BOTH SIDES OF BERRYESSA RD WEST OF UNION PACIFIC       | 0        | 0         | 0        | 0        | 0         | 0        | 2        | 0        | 0         | 0        | 0        | 0        |
| -----  |          |           |          |          |           |          |          |          |           |          |          |          |
| PDC03-108 RES<br>BERRYESSA FLEA MKT (RESIDENTIAL)<br>BOTH SIDES OF BERRYESSA, WEST OF UNION PACIFIC RR | 0        | 0         | 0        | 0        | 0         | 0        | 4        | 0        | 0         | 0        | 0        | 0        |
| -----  |          |           |          |          |           |          |          |          |           |          |          |          |
| PDC03-108 RET<br>BERRYESSA FLEA MKT (RETAIL)<br>BOTH SIDES OF BERRYESSA, WEST OF UNION PACIFIC RR      | 0        | 0         | 0        | 0        | 0         | 0        | 0        | 0        | 0         | 0        | 0        | 0        |
| -----  |          |           |          |          |           |          |          |          |           |          |          |          |
| PDC04-045<br>VIETNAMTOWN<br>N/S STORY ROAD, 720' SW OF MCLAUGHLIN                                      | 0        | 36        | 0        | 0        | 19        | 0        | 0        | 0        | 37        | 0        | 0        | 0        |
| <b>TOTAL:</b>  | <b>0</b> | <b>49</b> | <b>0</b> | <b>0</b> | <b>20</b> | <b>0</b> | <b>6</b> | <b>0</b> | <b>37</b> | <b>0</b> | <b>0</b> | <b>0</b> |
|  |          |           |          | LEFT     | THRU      | RIGHT    |          |          |           |          |          |          |
|  |          |           |          | NORTH    | 0         | 20       | 0        |          |           |          |          |          |
|  |          |           |          | EAST     | 0         | 0        | 0        |          |           |          |          |          |
|  |          |           |          | SOUTH    | 0         | 49       | 0        |          |           |          |          |          |
|  |          |           |          | WEST     | 6         | 0        | 37       |          |           |          |          |          |

**PM APPROVED TRIPS**

07/22/2015

*Intersection of: 280/MCLAUGHLIN*

Page No: 2

Traffic Node Number: 3036

| Permit No. / Description / Location  | M09      | M08        | M07      | M03      | M02       | M01      | M12       | M11      | M10        | M06      | M05      | M04      |
|--|----------|------------|----------|----------|-----------|----------|-----------|----------|------------|----------|----------|----------|
|  | NBL      | NBT        | NBR      | SBL      | SBT       | SBR      | EBL       | EBT      | EBR        | WBL      | WBT      | WBR      |
| DOWNTOWN<br>DOWNTOWN STRATEGY PLAN 2000<br>DOWNTOWN CORE   | 0        | 27         | 0        | 0        | 20        | 0        | 10        | 0        | 24         | 0        | 0        | 0        |
| -----  |          |            |          |          |           |          |           |          |            |          |          |          |
| NSJ<br>NORTH SAN JOSE  | 0        | 0          | 0        | 0        | 5         | 0        | 0         | 0        | 0          | 0        | 0        | 0        |
| -----  |          |            |          |          |           |          |           |          |            |          |          |          |
| PDC03-108 OFF<br>BERRYESSA FLEA MKT (OFFICE)<br>BOTH SIDES OF BERRYESSA RD WEST OF UNION PACIFIC       | 0        | 0          | 0        | 0        | 0         | 0        | 0         | 0        | 0          | 0        | 0        | 0        |
| -----  |          |            |          |          |           |          |           |          |            |          |          |          |
| PDC03-108 RES<br>BERRYESSA FLEA MKT (RESIDENTIAL)<br>BOTH SIDES OF BERRYESSA, WEST OF UNION PACIFIC RR | 0        | 0          | 0        | 0        | 0         | 0        | 8         | 0        | 0          | 0        | 0        | 0        |
| -----  |          |            |          |          |           |          |           |          |            |          |          |          |
| PDC03-108 RET<br>BERRYESSA FLEA MKT (RETAIL)<br>BOTH SIDES OF BERRYESSA, WEST OF UNION PACIFIC RR      | 0        | 0          | 0        | 0        | 0         | 0        | 0         | 0        | 0          | 0        | 0        | 0        |
| -----  |          |            |          |          |           |          |           |          |            |          |          |          |
| PDC04-045<br>VIETNAMTOWN<br>N/S STORY ROAD, 720' SW OF MCLAUGHLIN                                      | 0        | 115        | 0        | 0        | 39        | 0        | 0         | 0        | 78         | 0        | 0        | 0        |
| <b>TOTAL:</b>  | <b>0</b> | <b>142</b> | <b>0</b> | <b>0</b> | <b>64</b> | <b>0</b> | <b>18</b> | <b>0</b> | <b>102</b> | <b>0</b> | <b>0</b> | <b>0</b> |
|  |          |            |          | LEFT     | THRU      | RIGHT    |           |          |            |          |          |          |
|  |          |            |          | NORTH    | 0         | 64       | 0         |          |            |          |          |          |
|  |          |            |          | EAST     | 0         | 0        | 0         |          |            |          |          |          |
|  |          |            |          | SOUTH    | 0         | 142      | 0         |          |            |          |          |          |
|  |          |            |          | WEST     | 18        | 0        | 102       |          |            |          |          |          |

**AM APPROVED TRIPS**

07/22/2015

*Intersection of: 680/ALUM ROCK (E)*

Page No: 1

Traffic Node Number: 3042

| Permit No. / Description / Location                             | M09 | M08 | M07 | M03 | M02 | M01 | M12 | M11 | M10 | M06 | M05 | M04 |
|---|-----|-----|-----|-----|-----|-----|-----|-----|-----|-----|-----|-----|
|   | NBL | NBT | NBR | SBL | SBT | SBR | EBL | EBT | EBR | WBL | WBT | WBR |
| H13-032<br>ROCKETSHIP SCHOOL JACKSON AVENUE<br>70 S JACKSON AVE | 0   | 0   | 0   | 0   | 0   | 0   | 0   | 37  | 19  | 0   | 53  | 0   |
| NSJ<br>NORTH SAN JOSE   | 3   | 0   | 9   | 0   | 0   | 0   | 0   | 4   | 2   | 0   | 7   | 3   |
| PDA97-01-004<br>SJ MED CENTR<br>MCKEE RD & JACKSON AV (SW/C)    | 0   | 0   | 0   | 0   | 0   | 0   | 0   | 0   | 0   | 0   | 0   | 0   |
| PDC02-082<br>BLACKWELL HOUSING<br>ALUM ROCK & MCCREERY (SW/C)   | 0   | 0   | 0   | 0   | 0   | 0   | 0   | 2   | 5   | 0   | 1   | 0   |

**TOTAL: 3 0 9 0 0 0 0 43 26 0 61 3**

|       | LEFT | THRU | RIGHT |
|-------|------|------|-------|
| NORTH | 0    | 0    | 0     |
| EAST  | 0    | 61   | 3     |
| SOUTH | 3    | 0    | 9     |
| WEST  | 0    | 43   | 26    |

**PM APPROVED TRIPS**

07/22/2015

*Intersection of: 680/ALUM ROCK (E)*

Page No: 2

Traffic Node Number: 3042

| Permit No. / Description / Location                             | M09<br>NBL | M08<br>NBT | M07<br>NBR | M03<br>SBL | M02<br>SBT | M01<br>SBR | M12<br>EBL | M11<br>EBT | M10<br>EBR | M06<br>WBL | M05<br>WBT | M04<br>WBR |
|---|------------|------------|------------|------------|------------|------------|------------|------------|------------|------------|------------|------------|
| H13-032<br>ROCKETSHIP SCHOOL JACKSON AVENUE<br>70 S JACKSON AVE | 0          | 0          | 0          | 0          | 0          | 0          | 0          | 26         | 5          | 0          | 14         | 0          |
| NSJ<br>NORTH SAN JOSE   | 0          | 0          | 0          | 0          | 0          | 0          | 0          | 5          | 0          | 0          | 21         | 4          |
| PDA97-01-004<br>SJ MED CENTR<br>MCKEE RD & JACKSON AV (SW/C)    | 0          | 0          | 0          | 0          | 0          | 0          | 0          | 0          | 0          | 0          | 0          | 0          |
| PDC02-082<br>BLACKWELL HOUSING<br>ALUM ROCK & MCCREERY (SW/C)   | 0          | 0          | 0          | 0          | 0          | 0          | 0          | 1          | 3          | 0          | 2          | 0          |

**TOTAL:** 0 0 0 0 0 0 0 0 32 8 0 37 4

|       | LEFT | THRU | RIGHT |
|-------|------|------|-------|
| NORTH | 0    | 0    | 0     |
| EAST  | 0    | 37   | 4     |
| SOUTH | 0    | 0    | 0     |
| WEST  | 0    | 32   | 8     |

**AM APPROVED TRIPS**

07/22/2015

*Intersection of: 680/ALUM ROCK (W)*

Page No: 1

Traffic Node Number: 3043

| Permit No. / Description / Location                             | M09      | M08      | M07      | M03      | M02      | M01      | M12      | M11       | M10      | M06      | M05       | M04      |
|---|----------|----------|----------|----------|----------|----------|----------|-----------|----------|----------|-----------|----------|
|   | NBL      | NBT      | NBR      | SBL      | SBT      | SBR      | EBL      | EBT       | EBR      | WBL      | WBT       | WBR      |
| H13-032<br>ROCKETSHIP SCHOOL JACKSON AVENUE<br>70 S JACKSON AVE | 0        | 0        | 0        | 0        | 0        | 5        | 0        | 56        | 0        | 0        | 53        | 0        |
| PDA97-01-004<br>SJ MED CENTR<br>MCKEE RD & JACKSON AV (SW/C)    | 0        | 0        | 0        | 0        | 0        | 0        | 0        | 0         | 0        | 0        | 0         | 0        |
| PDC02-082<br>BLACKWELL HOUSING<br>ALUM ROCK & MCCREERY (SW/C)   | 0        | 0        | 0        | 0        | 0        | 3        | 0        | 7         | 0        | 0        | 1         | 0        |
| <b>TOTAL:</b>   | <b>0</b> | <b>0</b> | <b>0</b> | <b>0</b> | <b>0</b> | <b>8</b> | <b>0</b> | <b>63</b> | <b>0</b> | <b>0</b> | <b>54</b> | <b>0</b> |
|   |          |          |          | LEFT     | THRU     | RIGHT    |          |           |          |          |           |          |
|   |          |          |          | NORTH    | 0        | 0        | 8        |           |          |          |           |          |
|   |          |          |          | EAST     | 0        | 54       | 0        |           |          |          |           |          |
|   |          |          |          | SOUTH    | 0        | 0        | 0        |           |          |          |           |          |
|   |          |          |          | WEST     | 0        | 63       | 0        |           |          |          |           |          |



**PM APPROVED TRIPS**

07/22/2015

*Intersection of: 680/ALUM ROCK (W)*

Page No: 2

Traffic Node Number: 3043

| Permit No. / Description / Location                             | M09      | M08      | M07      | M03      | M02      | M01       | M12      | M11       | M10      | M06      | M05       | M04      |
|---|----------|----------|----------|----------|----------|-----------|----------|-----------|----------|----------|-----------|----------|
|   | NBL      | NBT      | NBR      | SBL      | SBT      | SBR       | EBL      | EBT       | EBR      | WBL      | WBT       | WBR      |
| H13-032<br>ROCKETSHIP SCHOOL JACKSON AVENUE<br>70 S JACKSON AVE | 0        | 0        | 0        | 0        | 0        | 7         | 0        | 31        | 0        | 0        | 14        | 0        |
| PDA97-01-004<br>SJ MED CENTR<br>MCKEE RD & JACKSON AV (SW/C)    | 0        | 0        | 0        | 0        | 0        | 0         | 0        | 0         | 0        | 0        | 0         | 0        |
| PDC02-082<br>BLACKWELL HOUSING<br>ALUM ROCK & MCCREERY (SW/C)   | 0        | 0        | 0        | 0        | 0        | 5         | 0        | 4         | 0        | 0        | 2         | 0        |
| <b>TOTAL:</b>   | <b>0</b> | <b>0</b> | <b>0</b> | <b>0</b> | <b>0</b> | <b>12</b> | <b>0</b> | <b>35</b> | <b>0</b> | <b>0</b> | <b>16</b> | <b>0</b> |
|   |          |          |          | LEFT     | THRU     | RIGHT     |          |           |          |          |           |          |
|   |          |          |          | NORTH    | 0        | 0         | 12       |           |          |          |           |          |
|   |          |          |          | EAST     | 0        | 16        | 0        |           |          |          |           |          |
|   |          |          |          | SOUTH    | 0        | 0         | 0        |           |          |          |           |          |
|   |          |          |          | WEST     | 0        | 35        | 0        |           |          |          |           |          |

**AM APPROVED TRIPS**

07/22/2015

Intersection of: ALUM ROCK/JACKSON

Page No: 1

Traffic Node Number: 3063

| Permit No. / Description / Location                                  | M09 | M08 | M07 | M03 | M02 | M01 | M12 | M11 | M10 | M06 | M05 | M04 |
|--|-----|-----|-----|-----|-----|-----|-----|-----|-----|-----|-----|-----|
|  | NBL | NBT | NBR | SBL | SBT | SBR | EBL | EBT | EBR | WBL | WBT | WBR |
| EEHDP (RES)<br>EEHDP (RESIDENTIAL)<br>EVERGREEN                      | 0   | 4   | 0   | 0   | 2   | 0   | 0   | 0   | 0   | 0   | 0   | 0   |
| EEHDP (RETAIL)<br>EEHDP (RETAIL)<br>EVERGREEN                        | 0   | 1   | 0   | 1   | 1   | 0   | 0   | 0   | 0   | 0   | 0   | 1   |
| H13-032<br>ROCKETSHIP SCHOOL JACKSON AVENUE<br>70 S JACKSON AVE      | 119 | 57  | 56  | 0   | 81  | 0   | 0   | 0   | 135 | 59  | 0   | 0   |
| NSJ<br>NORTH SAN JOSE  | 0   | 4   | 1   | 0   | 0   | 0   | 0   | 0   | 0   | 0   | 1   | 0   |
| PDA97-01-004<br>SJ MED CENTR<br>MCKEE RD & JACKSON AV (SW/C)         | 0   | 0   | 0   | 0   | 0   | 0   | 0   | 0   | 0   | 0   | 0   | 0   |
| PDC02-082<br>BLACKWELL HOUSING<br>ALUM ROCK & MCCREERY (SW/C)        | 0   | 0   | 0   | 0   | 0   | 1   | 1   | 7   | 1   | 0   | 4   | 0   |
| PDC03-093<br>SJ REGIONAL MEDICAL CENTER<br>MCKEE RD AND N JACKSON AV | 8   | 47  | 0   | 16  | 35  | 11  | 12  | 1   | 2   | 0   | 4   | 22  |

**TOTAL: 127 113 57 17 119 12 13 8 138 59 9 23**

|       | LEFT | THRU | RIGHT |
|-------|------|------|-------|
| NORTH | 17   | 119  | 12    |
| EAST  | 59   | 9    | 23    |
| SOUTH | 127  | 113  | 57    |
| WEST  | 13   | 8    | 138   |

**PM APPROVED TRIPS**

07/22/2015

Intersection of: ALUM ROCK/JACKSON

Page No: 2

Traffic Node Number: 3063

| Permit No. / Description / Location                                  | M09 | M08 | M07 | M03 | M02 | M01 | M12 | M11 | M10 | M06 | M05 | M04 |
|--|-----|-----|-----|-----|-----|-----|-----|-----|-----|-----|-----|-----|
|  | NBL | NBT | NBR | SBL | SBT | SBR | EBL | EBT | EBR | WBL | WBT | WBR |
| EEHDP (RES)<br>EEHDP (RESIDENTIAL)<br>EVERGREEN                      | 0   | 1   | 0   | 0   | 1   | 0   | 0   | 0   | 0   | 0   | 0   | 0   |
| EEHDP (RETAIL)<br>EEHDP (RETAIL)<br>EVERGREEN                        | 0   | 3   | 0   | 3   | 3   | 0   | 0   | 0   | 0   | 0   | 0   | 3   |
| H13-032<br>ROCKETSHIP SCHOOL JACKSON AVENUE<br>70 S JACKSON AVE      | 71  | 37  | 31  | 0   | 23  | 0   | 0   | 0   | 59  | 21  | 0   | 0   |
| NSJ<br>NORTH SAN JOSE  | 0   | 0   | 0   | 0   | 0   | 0   | 0   | 1   | 0   | 4   | 13  | 3   |
| PDA97-01-004<br>SJ MED CENTR<br>MCKEE RD & JACKSON AV (SW/C)         | 0   | 0   | 0   | 0   | 0   | 0   | 0   | 0   | 0   | 0   | 0   | 0   |
| PDC02-082<br>BLACKWELL HOUSING<br>ALUM ROCK & MCCREERY (SW/C)        | 1   | 0   | 0   | 0   | 0   | 1   | 1   | 4   | 0   | 0   | 7   | 0   |
| PDC03-093<br>SJ REGIONAL MEDICAL CENTER<br>MCKEE RD AND N JACKSON AV | 3   | 20  | 0   | 27  | 58  | 18  | 5   | 2   | 3   | 0   | 1   | 9   |

**TOTAL: 75 61 31 30 85 19 6 7 62 25 21 15**

|       | LEFT | THRU | RIGHT |
|-------|------|------|-------|
| NORTH | 30   | 85   | 19    |
| EAST  | 25   | 21   | 15    |
| SOUTH | 75   | 61   | 31    |
| WEST  | 6    | 7    | 62    |

**AM APPROVED TRIPS**

07/22/2015

Intersection of: ALUM ROCK/KING

Page No: 1

Traffic Node Number: 3064

| Permit No. / Description / Location  | M09 | M08 | M07 | M03 | M02 | M01 | M12 | M11 | M10 | M06 | M05 | M04 |
|--|-----|-----|-----|-----|-----|-----|-----|-----|-----|-----|-----|-----|
|  | NBL | NBT | NBR | SBL | SBT | SBR | EBL | EBT | EBR | WBL | WBT | WBR |
| DOWNTOWN<br>DOWNTOWN STRATEGY PLAN 2000<br>DOWNTOWN CORE   | 0   | 0   | 0   | 0   | 0   | 0   | 0   | 0   | 0   | 0   | 0   | 0   |
| H90-07-086<br>RETAIL OFC 13,540SF<br>SANTA CLARA (N/S) W/O KING  | 3   | 0   | 0   | 0   | 0   | 2   | 1   | 1   | 1   | 0   | 2   | 0   |
| NSJ<br>NORTH SAN JOSE  | 3   | 11  | 1   | 0   | 1   | 0   | 1   | 7   | 1   | 0   | 1   | 0   |
| PDA97-01-004<br>SJ MED CENTR<br>MCKEE RD & JACKSON AV (SW/C)   | 0   | 0   | 0   | 0   | 0   | 0   | 0   | 0   | 0   | 0   | 0   | 0   |
| PDC02-082<br>BLACKWELL HOUSING<br>ALUM ROCK & MCCREERY (SW/C)  | 1   | 0   | 0   | 2   | 0   | 0   | 0   | 9   | 0   | 16  | 3   | 0   |
| PDC03-093<br>SJ REGIONAL MEDICAL CENTER<br>MCKEE RD AND N JACKSON AV                                   | 0   | 0   | 18  | 0   | 0   | 0   | 0   | 5   | 0   | 11  | 3   | 0   |
| PDC03-108 OFF<br>BERRYESSA FLEA MKT (OFFICE)<br>BOTH SIDES OF BERRYESSA RD WEST OF UNION PACIFIC       | 0   | 6   | 0   | 0   | 1   | 1   | 5   | 0   | 0   | 0   | 0   | 1   |
| PDC03-108 RES<br>BERRYESSA FLEA MKT (RESIDENTIAL)<br>BOTH SIDES OF BERRYESSA, WEST OF UNION PACIFIC RR | 0   | 20  | 0   | 3   | 36  | 17  | 9   | 0   | 0   | 0   | 0   | 2   |
| PDC03-108 RET<br>BERRYESSA FLEA MKT (RETAIL)<br>BOTH SIDES OF BERRYESSA, WEST OF UNION PACIFIC RR      | 0   | 0   | 0   | 0   | 0   | 0   | 0   | 0   | 0   | 0   | 0   | 0   |

**TOTAL:** 7 37 19 5 38 20 16 22 2 27 9 3

|       | LEFT | THRU | RIGHT |
|-------|------|------|-------|
| NORTH | 5    | 38   | 20    |
| EAST  | 27   | 9    | 3     |
| SOUTH | 7    | 37   | 19    |
| WEST  | 16   | 22   | 2     |



TOTAL: 8 44 13 10 47 26 41 41 8 31 31 4

LEFT THRU RIGHT

|       |    |    |    |
|-------|----|----|----|
| NORTH | 10 | 47 | 26 |
| EAST  | 31 | 31 | 4  |
| SOUTH | 8  | 44 | 13 |
| WEST  | 41 | 41 | 8  |

**AM APPROVED TRIPS**

07/22/2015

Intersection of: 101/JULIAN

Page No: 1

Traffic Node Number: 3210

| Permit No. / Description / Location  | M09 | M08 | M07 | M03 | M02 | M01 | M12 | M11 | M10 | M06 | M05 | M04 |
|--|-----|-----|-----|-----|-----|-----|-----|-----|-----|-----|-----|-----|
|  | NBL | NBT | NBR | SBL | SBT | SBR | EBL | EBT | EBR | WBL | WBT | WBR |
| NSJ<br>NORTH SAN JOSE  | 6   | 0   | 18  | 0   | 0   | 0   | 0   | 2   | 1   | 0   | 0   | 0   |
| PDC03-093<br>SJ REGIONAL MEDICAL CENTER<br>MCKEE RD AND N JACKSON AV                                   | 0   | 0   | 17  | 0   | 0   | 0   | 0   | 7   | 0   | 8   | 5   | 0   |
| PDC03-108 OFF<br>BERRYESSA FLEA MKT (OFFICE)<br>BOTH SIDES OF BERRYESSA RD WEST OF UNION PACIFIC       | 0   | 0   | 0   | 0   | 0   | 0   | 0   | 1   | 0   | 3   | 0   | 0   |
| PDC03-108 RES<br>BERRYESSA FLEA MKT (RESIDENTIAL)<br>BOTH SIDES OF BERRYESSA, WEST OF UNION PACIFIC RR | 0   | 0   | 0   | 0   | 0   | 0   | 0   | 2   | 0   | 81  | 3   | 0   |
| PDC03-108 RET<br>BERRYESSA FLEA MKT (RETAIL)<br>BOTH SIDES OF BERRYESSA, WEST OF UNION PACIFIC RR      | 0   | 0   | 0   | 0   | 0   | 0   | 0   | 0   | 0   | 0   | 0   | 0   |
| PDC07-015 RES<br>KING AND DOBBIN<br>NE/C OF KING RD AND DOBBIN DR                                      | 0   | 0   | 31  | 0   | 0   | 0   | 0   | 0   | 0   | 116 | 0   | 0   |
| PDC07-015 RET<br>KING AND DOBBIN<br>NE/C OF KING RD AND DOBBIN DR                                      | 0   | 0   | 0   | 0   | 0   | 0   | 0   | 0   | 0   | 0   | 0   | 0   |
| PRE05-430 COMM<br>PEPPER LANE<br>S/W CORNER BERRYESSA RD & JACKSON AVE                                 | 0   | 0   | 0   | 0   | 0   | 0   | 0   | 6   | 0   | 0   | 5   | 0   |
| PRE05-430 RES<br>PEPPER LANE<br>SW/C OF BERRYESSA AND JACKSON  | 0   | 0   | 0   | 0   | 0   | 0   | 0   | 4   | 0   | 0   | 8   | 0   |

**TOTAL:** 6 0 66 0 0 0 0 22 1 208 21 0

|       | LEFT | THRU | RIGHT |
|-------|------|------|-------|
| NORTH | 0    | 0    | 0     |
| EAST  | 208  | 21   | 0     |
| SOUTH | 6    | 0    | 66    |
| WEST  | 0    | 22   | 1     |

**PM APPROVED TRIPS**

07/22/2015

Intersection of: 101/JULIAN

Page No: 2

Traffic Node Number: 3210

| Permit No. / Description / Location  | M09 | M08 | M07 | M03 | M02 | M01 | M12 | M11 | M10 | M06 | M05 | M04 |
|--|-----|-----|-----|-----|-----|-----|-----|-----|-----|-----|-----|-----|
|  | NBL | NBT | NBR | SBL | SBT | SBR | EBL | EBT | EBR | WBL | WBT | WBR |
| NSJ<br>NORTH SAN JOSE  | 2   | 0   | 10  | 0   | 0   | 0   | 0   | 1   | 0   | 5   | 8   | 0   |
| PDC03-093<br>SJ REGIONAL MEDICAL CENTER<br>MCKEE RD AND N JACKSON AV                                   | 0   | 0   | 7   | 0   | 0   | 0   | 0   | 3   | 0   | 14  | 8   | 0   |
| PDC03-108 OFF<br>BERRYESSA FLEA MKT (OFFICE)<br>BOTH SIDES OF BERRYESSA RD WEST OF UNION PACIFIC       | 0   | 0   | 0   | 0   | 0   | 0   | 0   | 0   | 0   | 20  | 1   | 0   |
| PDC03-108 RES<br>BERRYESSA FLEA MKT (RESIDENTIAL)<br>BOTH SIDES OF BERRYESSA, WEST OF UNION PACIFIC RR | 0   | 0   | 0   | 0   | 0   | 0   | 0   | 3   | 0   | 42  | 2   | 0   |
| PDC03-108 RET<br>BERRYESSA FLEA MKT (RETAIL)<br>BOTH SIDES OF BERRYESSA, WEST OF UNION PACIFIC RR      | 0   | 0   | 0   | 0   | 0   | 0   | 0   | 0   | 0   | 0   | 0   | 0   |
| PDC07-015 RES<br>KING AND DOBBIN<br>NE/C OF KING RD AND DOBBIN DR                                      | 0   | 0   | 57  | 0   | 0   | 0   | 0   | 0   | 0   | 61  | 0   | 0   |
| PDC07-015 RET<br>KING AND DOBBIN<br>NE/C OF KING RD AND DOBBIN DR                                      | 0   | 0   | 0   | 0   | 0   | 0   | 0   | 0   | 0   | 0   | 0   | 0   |
| PRE05-430 COMM<br>PEPPER LANE<br>S/W CORNER BERRYESSA RD & JACKSON AVE                                 | 0   | 0   | 0   | 0   | 0   | 0   | 0   | 10  | 0   | 0   | 6   | 0   |
| PRE05-430 RES<br>PEPPER LANE<br>SW/C OF BERRYESSA AND JACKSON  | 0   | 0   | 0   | 0   | 0   | 0   | 0   | 7   | 0   | 0   | 4   | 0   |

**TOTAL:** 2 0 74 0 0 0 0 24 0 142 29 0

|       | LEFT | THRU | RIGHT |
|-------|------|------|-------|
| NORTH | 0    | 0    | 0     |
| EAST  | 142  | 29   | 0     |
| SOUTH | 2    | 0    | 74    |
| WEST  | 0    | 24   | 0     |



**AM APPROVED TRIPS**

07/22/2015

*Intersection of: 101/MCKEE*

Page No: 1

Traffic Node Number: 3211

| Permit No. / Description / Location  | M09 | M08 | M07 | M03 | M02 | M01 | M12 | M11 | M10 | M06 | M05 | M04 |
|--|-----|-----|-----|-----|-----|-----|-----|-----|-----|-----|-----|-----|
|  | NBL | NBT | NBR | SBL | SBT | SBR | EBL | EBT | EBR | WBL | WBT | WBR |
| NSJ<br>NORTH SAN JOSE  | 13  | 0   | 22  | 0   | 0   | 0   | 4   | 22  | 0   | 0   | 4   | 2   |
| -----  |     |     |     |     |     |     |     |     |     |     |     |     |
| PDA97-01-004<br>SJ MED CENTR<br>MCKEE RD & JACKSON AV (SW/C)   | 0   | 0   | 0   | 0   | 0   | 0   | 0   | 0   | 0   | 0   | 0   | 0   |
| -----  |     |     |     |     |     |     |     |     |     |     |     |     |
| PDC03-093<br>SJ REGIONAL MEDICAL CENTER<br>MCKEE RD AND N JACKSON AV                                   | 0   | 0   | 12  | 0   | 0   | 0   | 0   | 25  | 0   | 0   | 14  | 12  |
| -----  |     |     |     |     |     |     |     |     |     |     |     |     |
| PDC03-108 OFF<br>BERRYESSA FLEA MKT (OFFICE)<br>BOTH SIDES OF BERRYESSA RD WEST OF UNION PACIFIC       | 0   | 0   | 23  | 0   | 0   | 0   | 0   | 1   | 0   | 0   | 3   | 0   |
| -----  |     |     |     |     |     |     |     |     |     |     |     |     |
| PDC03-108 RES<br>BERRYESSA FLEA MKT (RESIDENTIAL)<br>BOTH SIDES OF BERRYESSA, WEST OF UNION PACIFIC RR | 0   | 0   | 44  | 0   | 0   | 0   | 0   | 2   | 0   | 0   | 84  | 0   |
| -----  |     |     |     |     |     |     |     |     |     |     |     |     |
| PDC03-108 RET<br>BERRYESSA FLEA MKT (RETAIL)<br>BOTH SIDES OF BERRYESSA, WEST OF UNION PACIFIC RR      | 0   | 0   | 0   | 0   | 0   | 0   | 0   | 0   | 0   | 0   | 0   | 0   |
| -----  |     |     |     |     |     |     |     |     |     |     |     |     |
| PDC07-015 RES<br>KING AND DOBBIN<br>NE/C OF KING RD AND DOBBIN DR                                      | 0   | 0   | 62  | 0   | 0   | 0   | 0   | 31  | 0   | 0   | 116 | 36  |
| -----  |     |     |     |     |     |     |     |     |     |     |     |     |
| PDC07-015 RET<br>KING AND DOBBIN<br>NE/C OF KING RD AND DOBBIN DR                                      | 0   | 0   | 0   | 0   | 0   | 0   | 0   | 0   | 0   | 0   | 0   | 0   |
| -----  |     |     |     |     |     |     |     |     |     |     |     |     |
| PRE05-430 COMM<br>PEPPER LANE<br>S/W CORNER BERRYESSA RD & JACKSON AVE                                 | 0   | 0   | 0   | 0   | 0   | 0   | 0   | 6   | 0   | 0   | 5   | 0   |
| -----  |     |     |     |     |     |     |     |     |     |     |     |     |
| PRE05-430 RES<br>PEPPER LANE<br>SW/C OF BERRYESSA AND JACKSON  | 0   | 0   | 0   | 0   | 0   | 0   | 0   | 4   | 0   | 0   | 8   | 0   |
| -----  |     |     |     |     |     |     |     |     |     |     |     |     |

TOTAL: 13 0 163 0 0 0 4 91 0 0 234 50

LEFT THRU RIGHT

NORTH 0 0 0  
 EAST 0 234 50  
 SOUTH 13 0 163  
 WEST 4 91 0

**PM APPROVED TRIPS**

07/22/2015

*Intersection of: 101/MCKEE*

Page No: 2

Traffic Node Number: 3211

| Permit No. / Description / Location  | M09<br>NBL | M08<br>NBT | M07<br>NBR | M03<br>SBL | M02<br>SBT | M01<br>SBR | M12<br>EBL | M11<br>EBT | M10<br>EBR | M06<br>WBL | M05<br>WBT | M04<br>WBR |
|--|------------|------------|------------|------------|------------|------------|------------|------------|------------|------------|------------|------------|
| NSJ<br>NORTH SAN JOSE  | 0          | 0          | 1          | 0          | 0          | 0          | 0          | 6          | 0          | 0          | 26         | 13         |
| PDA97-01-004<br>SJ MED CENTR<br>MCKEE RD & JACKSON AV (SW/C)   | 0          | 0          | 0          | 0          | 0          | 0          | 0          | 0          | 0          | 0          | 0          | 0          |
| PDC03-093<br>SJ REGIONAL MEDICAL CENTER<br>MCKEE RD AND N JACKSON AV                                   | 0          | 0          | 5          | 0          | 0          | 0          | 0          | 11         | 0          | 0          | 23         | 19         |
| PDC03-108 OFF<br>BERRYESSA FLEA MKT (OFFICE)<br>BOTH SIDES OF BERRYESSA RD WEST OF UNION PACIFIC       | 0          | 0          | 4          | 0          | 0          | 0          | 0          | 0          | 0          | 0          | 21         | 0          |
| PDC03-108 RES<br>BERRYESSA FLEA MKT (RESIDENTIAL)<br>BOTH SIDES OF BERRYESSA, WEST OF UNION PACIFIC RR | 0          | 0          | 79         | 0          | 0          | 0          | 0          | 3          | 0          | 0          | 44         | 0          |
| PDC03-108 RET<br>BERRYESSA FLEA MKT (RETAIL)<br>BOTH SIDES OF BERRYESSA, WEST OF UNION PACIFIC RR      | 0          | 0          | 0          | 0          | 0          | 0          | 0          | 0          | 0          | 0          | 0          | 0          |
| PDC07-015 RES<br>KING AND DOBBIN<br>NE/C OF KING RD AND DOBBIN DR                                      | 0          | 0          | 115        | 0          | 0          | 0          | 0          | 57         | 0          | 0          | 61         | 19         |
| PDC07-015 RET<br>KING AND DOBBIN<br>NE/C OF KING RD AND DOBBIN DR                                      | 0          | 0          | 0          | 0          | 0          | 0          | 0          | 0          | 0          | 0          | 0          | 0          |
| PRE05-430 COMM<br>PEPPER LANE<br>S/W CORNER BERRYESSA RD & JACKSON AVE                                 | 0          | 0          | 0          | 0          | 0          | 0          | 0          | 10         | 0          | 0          | 6          | 0          |

**PM APPROVED TRIPS**

07/22/2015

*Intersection of: 101/MCKEE*

Page No: 3

Traffic Node Number: 3211

| Permit No. / Description / Location                           | M09<br>NBL | M08<br>NBT | M07<br>NBR | M03<br>SBL | M02<br>SBT | M01<br>SBR | M12<br>EBL | M11<br>EBT | M10<br>EBR | M06<br>WBL | M05<br>WBT | M04<br>WBR |
|---|------------|------------|------------|------------|------------|------------|------------|------------|------------|------------|------------|------------|
| PRE05-430 RES<br>PEPPER LANE<br>SW/C OF BERRYESSA AND JACKSON | 0          | 0          | 0          | 0          | 0          | 0          | 0          | 7          | 0          | 0          | 4          | 0          |
| <b>TOTAL:</b>   | <b>0</b>   | <b>0</b>   | <b>204</b> | <b>0</b>   | <b>0</b>   | <b>0</b>   | <b>0</b>   | <b>94</b>  | <b>0</b>   | <b>0</b>   | <b>185</b> | <b>51</b>  |

|       | LEFT | THRU | RIGHT |
|-------|------|------|-------|
| NORTH | 0    | 0    | 0     |
| EAST  | 0    | 185  | 51    |
| SOUTH | 0    | 0    | 204   |
| WEST  | 0    | 94   | 0     |

**AM APPROVED TRIPS**

07/22/2015

Intersection of: *CAPITOL/JACKSON*

Page No: 1

Traffic Node Number: 3384

| Permit No. / Description / Location  | M09 | M08 | M07 | M03 | M02 | M01 | M12 | M11 | M10 | M06 | M05 | M04 |
|--|-----|-----|-----|-----|-----|-----|-----|-----|-----|-----|-----|-----|
|  | NBL | NBT | NBR | SBL | SBT | SBR | EBL | EBT | EBR | WBL | WBT | WBR |
| EEHDP (RES)<br>EEHDP (RESIDENTIAL)<br>EVERGREEN  | 0   | 0   | 0   | 2   | 0   | 0   | 0   | 1   | 0   | 0   | 2   | 4   |
| EEHDP (RETAIL)<br>EEHDP (RETAIL)<br>EVERGREEN  | 0   | 0   | 0   | 1   | 0   | 0   | 0   | 1   | 0   | 0   | 1   | 1   |
| H13-032<br>ROCKETSHIP SCHOOL JACKSON AVENUE<br>70 S JACKSON AVE  | 0   | 38  | 0   | 42  | 52  | 20  | 36  | 0   | 0   | 0   | 0   | 47  |
| NSJ<br>NORTH SAN JOSE  | 0   | 1   | 0   | 0   | 0   | 0   | 0   | 0   | 0   | 0   | 2   | 2   |
| PDC02-082<br>BLACKWELL HOUSING<br>ALUM ROCK & MCCREERY (SW/C)  | 0   | 0   | 0   | 0   | 1   | 0   | 0   | 2   | 1   | 0   | 1   | 0   |
| PDC03-093<br>SJ REGIONAL MEDICAL CENTER<br>MCKEE RD AND N JACKSON AV                                   | 0   | 28  | 0   | 12  | 19  | 5   | 7   | 0   | 0   | 0   | 0   | 18  |
| PDC03-108 OFF<br>BERRYESSA FLEA MKT (OFFICE)<br>BOTH SIDES OF BERRYESSA RD WEST OF UNION PACIFIC       | 0   | 1   | 0   | 1   | 0   | 0   | 0   | 0   | 0   | 0   | 1   | 4   |
| PDC03-108 RES<br>BERRYESSA FLEA MKT (RESIDENTIAL)<br>BOTH SIDES OF BERRYESSA, WEST OF UNION PACIFIC RR | 0   | 2   | 0   | 8   | 4   | 0   | 0   | 1   | 0   | 0   | 1   | 4   |
| PDC03-108 RET<br>BERRYESSA FLEA MKT (RETAIL)<br>BOTH SIDES OF BERRYESSA, WEST OF UNION PACIFIC RR      | 0   | 0   | 0   | 0   | 0   | 0   | 0   | 0   | 0   | 0   | 0   | 0   |

**TOTAL:** 0 70 0 66 76 25 43 5 1 0 8 80

|       | LEFT | THRU | RIGHT |
|-------|------|------|-------|
| NORTH | 66   | 76   | 25    |
| EAST  | 0    | 8    | 80    |
| SOUTH | 0    | 70   | 0     |
| WEST  | 43   | 5    | 1     |

**PM APPROVED TRIPS**

07/22/2015

Intersection of: *CAPITOL/JACKSON*

Page No: 2

Traffic Node Number: 3384

| Permit No. / Description / Location  | M09 | M08 | M07 | M03 | M02 | M01 | M12 | M11 | M10 | M06 | M05 | M04 |
|--|-----|-----|-----|-----|-----|-----|-----|-----|-----|-----|-----|-----|
|  | NBL | NBT | NBR | SBL | SBT | SBR | EBL | EBT | EBR | WBL | WBT | WBR |
| EEHDP (RES)<br>EEHDP (RESIDENTIAL)<br>EVERGREEN  | 0   | 0   | 0   | 1   | 0   | 0   | 0   | 1   | 0   | 0   | 0   | 1   |
| EEHDP (RETAIL)<br>EEHDP (RETAIL)<br>EVERGREEN  | 0   | 0   | 0   | 3   | 0   | 0   | 0   | 3   | 0   | 0   | 3   | 3   |
| H13-032<br>ROCKETSHIP SCHOOL JACKSON AVENUE<br>70 S JACKSON AVE  | 0   | 20  | 0   | 22  | 22  | 17  | 8   | 0   | 0   | 0   | 0   | 15  |
| NSJ<br>NORTH SAN JOSE  | 0   | 0   | 0   | 2   | 7   | 1   | 0   | 0   | 0   | 0   | 1   | 0   |
| PDC02-082<br>BLACKWELL HOUSING<br>ALUM ROCK & MCCREERY (SW/C)  | 1   | 1   | 0   | 0   | 0   | 0   | 0   | 1   | 0   | 0   | 2   | 0   |
| PDC03-093<br>SJ REGIONAL MEDICAL CENTER<br>MCKEE RD AND N JACKSON AV                                   | 0   | 12  | 0   | 21  | 31  | 8   | 3   | 0   | 0   | 0   | 0   | 8   |
| PDC03-108 OFF<br>BERRYESSA FLEA MKT (OFFICE)<br>BOTH SIDES OF BERRYESSA RD WEST OF UNION PACIFIC       | 0   | 0   | 0   | 4   | 1   | 0   | 0   | 0   | 0   | 0   | 0   | 1   |
| PDC03-108 RES<br>BERRYESSA FLEA MKT (RESIDENTIAL)<br>BOTH SIDES OF BERRYESSA, WEST OF UNION PACIFIC RR | 0   | 4   | 0   | 4   | 2   | 0   | 0   | 0   | 0   | 0   | 1   | 8   |
| PDC03-108 RET<br>BERRYESSA FLEA MKT (RETAIL)<br>BOTH SIDES OF BERRYESSA, WEST OF UNION PACIFIC RR      | 0   | 0   | 0   | 0   | 0   | 0   | 0   | 0   | 0   | 0   | 0   | 0   |

**TOTAL:** 1 37 0 57 63 26 11 5 0 0 7 36

|       | LEFT | THRU | RIGHT |
|-------|------|------|-------|
| NORTH | 57   | 63   | 26    |
| EAST  | 0    | 7    | 36    |
| SOUTH | 1    | 37   | 0     |
| WEST  | 11   | 5    | 0     |

**AM APPROVED TRIPS**

07/22/2015

*Intersection of: JACKSON/MCKEE*

Page No: 1

Traffic Node Number: 3596

| Permit No. / Description / Location  | M09<br>NBL | M08<br>NBT | M07<br>NBR | M03<br>SBL | M02<br>SBT | M01<br>SBR | M12<br>EBL | M11<br>EBT | M10<br>EBR | M06<br>WBL | M05<br>WBT | M04<br>WBR |
|--|------------|------------|------------|------------|------------|------------|------------|------------|------------|------------|------------|------------|
| H13-032<br>ROCKETSHIP SCHOOL JACKSON AVENUE<br>70 S JACKSON AVE  | 20         | 24         | 13         | 0          | 46         | 0          | 0          | 0          | 24         | 11         | 0          | 0          |
| NSJ<br>NORTH SAN JOSE  | 0          | 2          | 1          | 0          | 0          | 0          | 1          | 4          | 0          | 0          | 2          | 0          |
| PDA97-01-004<br>SJ MED CENTR<br>MCKEE RD & JACKSON AV (SW/C)   | 0          | 0          | 0          | 0          | 0          | 0          | 0          | 0          | 0          | 0          | 0          | 0          |
| PDC03-093<br>SJ REGIONAL MEDICAL CENTER<br>MCKEE RD AND N JACKSON AV                                   | 12         | 3          | 26         | 0          | 8          | 2          | 4          | 36         | 21         | 69         | 24         | 0          |
| PDC03-108 OFF<br>BERRYESSA FLEA MKT (OFFICE)<br>BOTH SIDES OF BERRYESSA RD WEST OF UNION PACIFIC       | 1          | 5          | 0          | 1          | 1          | 0          | 0          | 0          | 0          | 0          | 3          | 4          |
| PDC03-108 RES<br>BERRYESSA FLEA MKT (RESIDENTIAL)<br>BOTH SIDES OF BERRYESSA, WEST OF UNION PACIFIC RR | 2          | 7          | 0          | 13         | 12         | 0          | 0          | 9          | 3          | 0          | 5          | 7          |
| PDC03-108 RET<br>BERRYESSA FLEA MKT (RETAIL)<br>BOTH SIDES OF BERRYESSA, WEST OF UNION PACIFIC RR      | 0          | 0          | 0          | 0          | 0          | 0          | 0          | 0          | 0          | 0          | 0          | 0          |
| PDC07-015 RES<br>KING AND DOBBIN<br>NE/C OF KING RD AND DOBBIN DR                                      | 2          | 0          | 0          | 0          | 0          | 0          | 0          | 13         | 4          | 0          | 7          | 0          |
| PDC07-015 RET<br>KING AND DOBBIN<br>NE/C OF KING RD AND DOBBIN DR                                      | 0          | 0          | 0          | 0          | 0          | 0          | 0          | 0          | 0          | 0          | 0          | 0          |
| PP08-024<br>EDUCATIONAL PARK BRANCH LIBRARY<br>1776 EDUCATIONAL PARK DRIVE (INDEPENDENCE HIGH          | 0          | 0          | 0          | 0          | 0          | 0          | 0          | 0          | 0          | 0          | 0          | 0          |
| PRE05-430 COMM<br>PEPPER LANE<br>S/W CORNER BERRYESSA RD & JACKSON AVE                                 | 0          | 0          | 0          | 0          | 0          | 5          | 6          | 0          | 0          | 0          | 0          | 0          |

**AM APPROVED TRIPS**

07/22/2015

*Intersection of: JACKSON/MCKEE*

Page No: 2

Traffic Node Number: 3596

| Permit No. / Description / Location                           | M09<br>NBL | M08<br>NBT | M07<br>NBR | M03<br>SBL | M02<br>SBT | M01<br>SBR | M12<br>EBL | M11<br>EBT | M10<br>EBR | M06<br>WBL | M05<br>WBT | M04<br>WBR |
|---|------------|------------|------------|------------|------------|------------|------------|------------|------------|------------|------------|------------|
| PRE05-430 RES<br>PEPPER LANE<br>SW/C OF BERRYESSA AND JACKSON | 0          | 1          | 0          | 0          | 3          | 12         | 6          | 0          | 0          | 0          | 0          | 0          |
| <b>TOTAL:</b>   | <b>37</b>  | <b>42</b>  | <b>40</b>  | <b>14</b>  | <b>70</b>  | <b>19</b>  | <b>17</b>  | <b>62</b>  | <b>52</b>  | <b>80</b>  | <b>41</b>  | <b>11</b>  |

|       | LEFT | THRU | RIGHT |
|-------|------|------|-------|
| NORTH | 14   | 70   | 19    |
| EAST  | 80   | 41   | 11    |
| SOUTH | 37   | 42   | 40    |
| WEST  | 17   | 62   | 52    |

**PM APPROVED TRIPS**

07/22/2015

*Intersection of: JACKSON/MCKEE*

Page No: 3

Traffic Node Number: 3596

| Permit No. / Description / Location  | M09<br>NBL | M08<br>NBT | M07<br>NBR | M03<br>SBL | M02<br>SBT | M01<br>SBR | M12<br>EBL | M11<br>EBT | M10<br>EBR | M06<br>WBL | M05<br>WBT | M04<br>WBR |
|--|------------|------------|------------|------------|------------|------------|------------|------------|------------|------------|------------|------------|
| H13-032<br>ROCKETSHIP SCHOOL JACKSON AVENUE<br>70 S JACKSON AVE  | 12         | 20         | 5          | 0          | 9          | 0          | 0          | 0          | 8          | 6          | 0          | 0          |
| NSJ<br>NORTH SAN JOSE  | 1          | 2          | 0          | 0          | 0          | 0          | 0          | 1          | 0          | 2          | 10         | 2          |
| PDA97-01-004<br>SJ MED CENTR<br>MCKEE RD & JACKSON AV (SW/C)   | 0          | 0          | 0          | 0          | 0          | 0          | 0          | 0          | 0          | 0          | 0          | 0          |
| PDC03-093<br>SJ REGIONAL MEDICAL CENTER<br>MCKEE RD AND N JACKSON AV                                   | 19         | 5          | 43         | 0          | 3          | 1          | 7          | 60         | 10         | 30         | 10         | 0          |
| PDC03-108 OFF<br>BERRYESSA FLEA MKT (OFFICE)<br>BOTH SIDES OF BERRYESSA RD WEST OF UNION PACIFIC       | 0          | 1          | 0          | 3          | 4          | 0          | 0          | 2          | 1          | 0          | 0          | 1          |
| PDC03-108 RES<br>BERRYESSA FLEA MKT (RESIDENTIAL)<br>BOTH SIDES OF BERRYESSA, WEST OF UNION PACIFIC RR | 3          | 12         | 0          | 7          | 6          | 0          | 0          | 5          | 2          | 0          | 9          | 13         |
| PDC03-108 RET<br>BERRYESSA FLEA MKT (RETAIL)<br>BOTH SIDES OF BERRYESSA, WEST OF UNION PACIFIC RR      | 0          | 0          | 0          | 0          | 0          | 0          | 0          | 0          | 0          | 0          | 0          | 0          |
| PDC07-015 RES<br>KING AND DOBBIN<br>NE/C OF KING RD AND DOBBIN DR                                      | 4          | 0          | 0          | 0          | 0          | 0          | 0          | 7          | 2          | 0          | 13         | 0          |
| PDC07-015 RET<br>KING AND DOBBIN<br>NE/C OF KING RD AND DOBBIN DR                                      | 0          | 0          | 0          | 0          | 0          | 0          | 0          | 0          | 0          | 0          | 0          | 0          |
| PP08-024<br>EDUCATIONAL PARK BRANCH LIBRARY<br>1776 EDUCATIONAL PARK DRIVE (INDEPENDENCE HIGH          | 1          | 0          | 0          | 0          | 0          | 0          | 1          | 10         | 1          | 0          | 10         | 0          |
| PRE05-430 COMM<br>PEPPER LANE<br>S/W CORNER BERRYESSA RD & JACKSON AVE                                 | 0          | 0          | 0          | 0          | 0          | 6          | 10         | 0          | 0          | 0          | 0          | 0          |



**PM APPROVED TRIPS**

07/22/2015

*Intersection of: JACKSON/MCKEE*

Page No: 4

Traffic Node Number: 3596

| Permit No. / Description / Location                           | M09<br>NBL | M08<br>NBT | M07<br>NBR | M03<br>SBL | M02<br>SBT | M01<br>SBR | M12<br>EBL | M11<br>EBT | M10<br>EBR | M06<br>WBL | M05<br>WBT | M04<br>WBR |
|---|------------|------------|------------|------------|------------|------------|------------|------------|------------|------------|------------|------------|
| PRE05-430 RES<br>PEPPER LANE<br>SW/C OF BERRYESSA AND JACKSON | 0          | 3          | 0          | 0          | 1          | 6          | 12         | 0          | 0          | 0          | 0          | 0          |

**TOTAL: 40 43 48 10 23 13 30 85 24 38 52 16**

|       | LEFT | THRU | RIGHT |
|-------|------|------|-------|
| NORTH | 10   | 23   | 13    |
| EAST  | 38   | 52   | 16    |
| SOUTH | 40   | 43   | 48    |
| WEST  | 30   | 85   | 24    |

**AM APPROVED TRIPS**

07/22/2015

*Intersection of: JULIAN/TWENTY FIRST*

Page No: 1

Traffic Node Number: 3612

| Permit No. / Description / Location | M09<br>NBL | M08<br>NBT | M07<br>NBR | M03<br>SBL | M02<br>SBT | M01<br>SBR | M12<br>EBL | M11<br>EBT | M10<br>EBR | M06<br>WBL | M05<br>WBT | M04<br>WBR |
|-------------------------------------|------------|------------|------------|------------|------------|------------|------------|------------|------------|------------|------------|------------|
| NSJ<br>NORTH SAN JOSE               | 0          | 0          | 0          | 0          | 0          | 0          | 0          | 0          | 0          | 0          | 7          | 1          |

**TOTAL:** 0 0 0 0 0 0 0 0 0 0 0 7 1

|       | LEFT | THRU | RIGHT |
|-------|------|------|-------|
| NORTH | 0    | 0    | 0     |
| EAST  | 0    | 7    | 1     |
| SOUTH | 0    | 0    | 0     |
| WEST  | 0    | 0    | 0     |

**PM APPROVED TRIPS**

07/22/2015

*Intersection of: JULIAN/TWENTY FIRST*

Page No: 2

Traffic Node Number: 3612

| Permit No. / Description / Location | M09<br>NBL | M08<br>NBT | M07<br>NBR | M03<br>SBL | M02<br>SBT | M01<br>SBR | M12<br>EBL | M11<br>EBT | M10<br>EBR | M06<br>WBL | M05<br>WBT | M04<br>WBR |
|-------------------------------------|------------|------------|------------|------------|------------|------------|------------|------------|------------|------------|------------|------------|
| NSJ<br>NORTH SAN JOSE               | 0          | 0          | 0          | 0          | 0          | 0          | 0          | 2          | 0          | 0          | 6          | 1          |

|               |          |          |          |          |          |          |          |          |          |          |          |          |
|---------------|----------|----------|----------|----------|----------|----------|----------|----------|----------|----------|----------|----------|
| <b>TOTAL:</b> | <b>0</b> | <b>0</b> | <b>0</b> | <b>0</b> | <b>0</b> | <b>0</b> | <b>0</b> | <b>2</b> | <b>0</b> | <b>0</b> | <b>6</b> | <b>1</b> |
|---------------|----------|----------|----------|----------|----------|----------|----------|----------|----------|----------|----------|----------|

|       | LEFT | THRU | RIGHT |
|-------|------|------|-------|
| NORTH | 0    | 0    | 0     |
| EAST  | 0    | 6    | 1     |
| SOUTH | 0    | 0    | 0     |
| WEST  | 0    | 2    | 0     |

**AM APPROVED TRIPS**

07/22/2015

*Intersection of: JULIAN/TWENTY FOURTH*

Page No: 1

Traffic Node Number: 3613

| Permit No. / Description / Location   | M09 | M08 | M07 | M03 | M02 | M01 | M12 | M11 | M10 | M06 | M05 | M04 |
|---|-----|-----|-----|-----|-----|-----|-----|-----|-----|-----|-----|-----|
|   | NBL | NBT | NBR | SBL | SBT | SBR | EBL | EBT | EBR | WBL | WBT | WBR |
| NSJ<br>NORTH SAN JOSE   | 5   | 0   | 2   | 0   | 0   | 0   | 0   | 0   | 0   | 0   | 2   | 0   |
| -----<br>PDC03-108 OFF<br>BERRYESSA FLEA MKT (OFFICE)<br>BOTH SIDES OF BERRYESSA RD WEST OF UNION PACIFIC       | 0   | 0   | 1   | 0   | 0   | 0   | 0   | 0   | 0   | 0   | 0   | 0   |
| -----<br>PDC03-108 RES<br>BERRYESSA FLEA MKT (RESIDENTIAL)<br>BOTH SIDES OF BERRYESSA, WEST OF UNION PACIFIC RR | 0   | 0   | 2   | 0   | 0   | 0   | 0   | 0   | 0   | 3   | 0   | 0   |
| -----<br>PDC03-108 RET<br>BERRYESSA FLEA MKT (RETAIL)<br>BOTH SIDES OF BERRYESSA, WEST OF UNION PACIFIC RR      | 0   | 0   | 0   | 0   | 0   | 0   | 0   | 0   | 0   | 0   | 0   | 0   |

**TOTAL:** 5 0 5 0 0 0 0 0 0 3 2 0

|       | LEFT | THRU | RIGHT |
|-------|------|------|-------|
| NORTH | 0    | 0    | 0     |
| EAST  | 3    | 2    | 0     |
| SOUTH | 5    | 0    | 5     |
| WEST  | 0    | 0    | 0     |

**PM APPROVED TRIPS**

07/22/2015

*Intersection of: JULIAN/TWENTY FOURTH*

Page No: 2

Traffic Node Number: 3613

| Permit No. / Description / Location  | M09      | M08      | M07      | M03      | M02      | M01      | M12      | M11      | M10      | M06      | M05       | M04      |
|--|----------|----------|----------|----------|----------|----------|----------|----------|----------|----------|-----------|----------|
|  | NBL      | NBT      | NBR      | SBL      | SBT      | SBR      | EBL      | EBT      | EBR      | WBL      | WBT       | WBR      |
| NSJ<br>NORTH SAN JOSE  | 1        | 0        | 1        | 0        | 0        | 0        | 0        | 2        | 0        | 2        | 11        | 0        |
| -----  |          |          |          |          |          |          |          |          |          |          |           |          |
| PDC03-108 OFF<br>BERRYESSA FLEA MKT (OFFICE)<br>BOTH SIDES OF BERRYESSA RD WEST OF UNION PACIFIC       | 0        | 0        | 0        | 0        | 0        | 0        | 0        | 0        | 0        | 1        | 0         | 0        |
| -----  |          |          |          |          |          |          |          |          |          |          |           |          |
| PDC03-108 RES<br>BERRYESSA FLEA MKT (RESIDENTIAL)<br>BOTH SIDES OF BERRYESSA, WEST OF UNION PACIFIC RR | 0        | 0        | 3        | 0        | 0        | 0        | 0        | 0        | 0        | 2        | 0         | 0        |
| -----  |          |          |          |          |          |          |          |          |          |          |           |          |
| PDC03-108 RET<br>BERRYESSA FLEA MKT (RETAIL)<br>BOTH SIDES OF BERRYESSA, WEST OF UNION PACIFIC RR      | 0        | 0        | 0        | 0        | 0        | 0        | 0        | 0        | 0        | 0        | 0         | 0        |
| -----  |          |          |          |          |          |          |          |          |          |          |           |          |
| <b>TOTAL:</b>  | <b>1</b> | <b>0</b> | <b>4</b> | <b>0</b> | <b>0</b> | <b>0</b> | <b>0</b> | <b>2</b> | <b>0</b> | <b>5</b> | <b>11</b> | <b>0</b> |

|       | LEFT | THRU | RIGHT |
|-------|------|------|-------|
| NORTH | 0    | 0    | 0     |
| EAST  | 5    | 11   | 0     |
| SOUTH | 1    | 0    | 4     |
| WEST  | 0    | 2    | 0     |



TOTAL: 160 290 15 25 236 31 43 43 125 9 35 21

LEFT THRU RIGHT

NORTH 25 236 31  
 EAST 9 35 21  
 SOUTH 160 290 15  
 WEST 43 43 125

**PM APPROVED TRIPS**

07/22/2015

*Intersection of: KING/MABURY*

Page No: 2

Traffic Node Number: 3623

| Permit No. / Description / Location  | M09<br>NBL | M08<br>NBT | M07<br>NBR | M03<br>SBL | M02<br>SBT | M01<br>SBR | M12<br>EBL | M11<br>EBT | M10<br>EBR | M06<br>WBL | M05<br>WBT | M04<br>WBR |
|--|------------|------------|------------|------------|------------|------------|------------|------------|------------|------------|------------|------------|
| DOWNTOWN<br>DOWNTOWN STRATEGY PLAN 2000<br>DOWNTOWN CORE   | 2          | 6          | 0          | 1          | 13         | 5          | 3          | 15         | 3          | 1          | 4          | 1          |
| NSJ<br>NORTH SAN JOSE  | 3          | 11         | 1          | 9          | 20         | 2          | 1          | 6          | 1          | 1          | 5          | 2          |
| PDA97-01-004<br>SJ MED CENTR<br>MCKEE RD & JACKSON AV (SW/C)   | 0          | 0          | 0          | 0          | 0          | 0          | 0          | 0          | 0          | 0          | 0          | 0          |
| PDC03-093<br>SJ REGIONAL MEDICAL CENTER<br>MCKEE RD AND N JACKSON AV                                   | 0          | 2          | 0          | 0          | 1          | 0          | 0          | 0          | 0          | 0          | 0          | 0          |
| PDC03-108 OFF<br>BERRYESSA FLEA MKT (OFFICE)<br>BOTH SIDES OF BERRYESSA RD WEST OF UNION PACIFIC       | 2          | 5          | 0          | 5          | 26         | 1          | 7          | 9          | 12         | 0          | 2          | 1          |
| PDC03-108 RES<br>BERRYESSA FLEA MKT (RESIDENTIAL)<br>BOTH SIDES OF BERRYESSA, WEST OF UNION PACIFIC RR | 66         | 147        | 0          | 12         | 78         | 35         | 18         | 15         | 35         | 0          | 28         | 22         |
| PDC03-108 RET<br>BERRYESSA FLEA MKT (RETAIL)<br>BOTH SIDES OF BERRYESSA, WEST OF UNION PACIFIC RR      | 10         | 23         | 0          | 9          | 23         | 12         | 12         | 13         | 10         | 0          | 13         | 9          |
| PDC07-015 RES<br>KING AND DOBBIN<br>NE/C OF KING RD AND DOBBIN DR                                      | 50         | 79         | 6          | 0          | 136        | 0          | 0          | 0          | 88         | 9          | 0          | 0          |
| PDC07-015 RET<br>KING AND DOBBIN<br>NE/C OF KING RD AND DOBBIN DR                                      | 4          | 6          | 11         | 0          | 8          | 0          | 0          | 0          | 4          | 8          | 0          | 0          |

**PM APPROVED TRIPS**

07/22/2015

*Intersection of: KING/MABURY*

Page No: 3

Traffic Node Number: 3623

| Permit No. / Description / Location   | M09<br>NBL | M08<br>NBT | M07<br>NBR | M03<br>SBL | M02<br>SBT | M01<br>SBR | M12<br>EBL | M11<br>EBT | M10<br>EBR | M06<br>WBL | M05<br>WBT | M04<br>WBR |
|---|------------|------------|------------|------------|------------|------------|------------|------------|------------|------------|------------|------------|
| PP08-024<br>EDUCATIONAL PARK BRANCH LIBRARY<br>1776 EDUCATIONAL PARK DRIVE (INDEPENDENCE HIGH | 0          | 0          | 0          | 12         | 0          | 0          | 0          | 3          | 0          | 0          | 3          | 12         |

**TOTAL: 137 279 18 48 305 55 41 61 153 19 55 47**

|       | LEFT | THRU | RIGHT |
|-------|------|------|-------|
| NORTH | 48   | 305  | 55    |
| EAST  | 19   | 55   | 47    |
| SOUTH | 137  | 279  | 18    |
| WEST  | 41   | 61   | 153   |



**AM APPROVED TRIPS**

07/22/2015

*Intersection of: KING/MCKEE*

Page No: 1

Traffic Node Number: 3625

| Permit No. / Description / Location  | M09<br>NBL | M08<br>NBT | M07<br>NBR | M03<br>SBL | M02<br>SBT | M01<br>SBR | M12<br>EBL | M11<br>EBT | M10<br>EBR | M06<br>WBL | M05<br>WBT | M04<br>WBR |
|--|------------|------------|------------|------------|------------|------------|------------|------------|------------|------------|------------|------------|
| DOWNTOWN<br>DOWNTOWN STRATEGY PLAN 2000<br>DOWNTOWN CORE   | 0          | 2          | 0          | 0          | 0          | 0          | 1          | 1          | 0          | 0          | 2          | 0          |
| H90-07-086<br>RETAIL OFC 13,540SF<br>SANTA CLARA (N/S) W/O KING  | 1          | 0          | 0          | 0          | 1          | 0          | 0          | 0          | 0          | 0          | 0          | 0          |
| NSJ<br>NORTH SAN JOSE  | 2          | 13         | 2          | 0          | 0          | 1          | 16         | 18         | 2          | 0          | 1          | 0          |
| PDA97-01-004<br>SJ MED CENTR<br>MCKEE RD & JACKSON AV (SW/C)   | 0          | 0          | 0          | 0          | 0          | 0          | 0          | 0          | 0          | 0          | 0          | 0          |
| PDC03-093<br>SJ REGIONAL MEDICAL CENTER<br>MCKEE RD AND N JACKSON AV                                   | 0          | 0          | 0          | 7          | 0          | 0          | 0          | 38         | 0          | 0          | 26         | 5          |
| PDC03-108 OFF<br>BERRYESSA FLEA MKT (OFFICE)<br>BOTH SIDES OF BERRYESSA RD WEST OF UNION PACIFIC       | 0          | 13         | 0          | 1          | 2          | 3          | 24         | 0          | 0          | 0          | 0          | 7          |
| PDC03-108 RES<br>BERRYESSA FLEA MKT (RESIDENTIAL)<br>BOTH SIDES OF BERRYESSA, WEST OF UNION PACIFIC RR | 0          | 38         | 0          | 44         | 70         | 84         | 46         | 0          | 0          | 0          | 0          | 24         |
| PDC03-108 RET<br>BERRYESSA FLEA MKT (RETAIL)<br>BOTH SIDES OF BERRYESSA, WEST OF UNION PACIFIC RR      | 0          | 1          | 0          | 2          | 1          | 0          | 0          | 0          | 0          | 0          | 0          | 5          |
| PDC07-015 RES<br>KING AND DOBBIN<br>NE/C OF KING RD AND DOBBIN DR                                      | 0          | 5          | 0          | 28         | 9          | 152        | 93         | 0          | 0          | 0          | 0          | 15         |
| PDC07-015 RET<br>KING AND DOBBIN<br>NE/C OF KING RD AND DOBBIN DR                                      | 0          | 0          | 0          | 0          | 0          | 0          | 0          | 0          | 0          | 0          | 0          | 1          |
| PRE05-430 COMM<br>PEPPER LANE<br>S/W CORNER BERRYESSA RD & JACKSON AVE                                 | 0          | 0          | 0          | 0          | 0          | 0          | 0          | 6          | 0          | 0          | 5          | 0          |

**AM APPROVED TRIPS**

07/22/2015

*Intersection of: KING/MCKEE*

Page No: 2

Traffic Node Number: 3625

| Permit No. / Description / Location                           | M09      | M08       | M07      | M03       | M02       | M01        | M12        | M11       | M10      | M06      | M05       | M04       |
|---|----------|-----------|----------|-----------|-----------|------------|------------|-----------|----------|----------|-----------|-----------|
|   | NBL      | NBT       | NBR      | SBL       | SBT       | SBR        | EBL        | EBT       | EBR      | WBL      | WBT       | WBR       |
| PRE05-430 RES<br>PEPPER LANE<br>SW/C OF BERRYESSA AND JACKSON | 0        | 0         | 0        | 0         | 0         | 0          | 0          | 4         | 0        | 0        | 8         | 0         |
| <b>TOTAL:</b>   | <b>3</b> | <b>72</b> | <b>2</b> | <b>82</b> | <b>83</b> | <b>240</b> | <b>180</b> | <b>67</b> | <b>2</b> | <b>0</b> | <b>42</b> | <b>57</b> |

|       | LEFT | THRU | RIGHT |
|-------|------|------|-------|
| NORTH | 82   | 83   | 240   |
| EAST  | 0    | 42   | 57    |
| SOUTH | 3    | 72   | 2     |
| WEST  | 180  | 67   | 2     |



**PM APPROVED TRIPS**

07/22/2015

*Intersection of: KING/MCKEE*

Page No: 4

Traffic Node Number: 3625

| Permit No. / Description / Location                                    | M09      | M08       | M07      | M03       | M02       | M01        | M12        | M11       | M10      | M06      | M05       | M04       |
|--|----------|-----------|----------|-----------|-----------|------------|------------|-----------|----------|----------|-----------|-----------|
|  | NBL      | NBT       | NBR      | SBL       | SBT       | SBR        | EBL        | EBT       | EBR      | WBL      | WBT       | WBR       |
| PRE05-430 COMM<br>PEPPER LANE<br>S/W CORNER BERRYESSA RD & JACKSON AVE | 0        | 0         | 0        | 0         | 0         | 0          | 0          | 10        | 0        | 0        | 6         | 0         |
| PRE05-430 RES<br>PEPPER LANE<br>SW/C OF BERRYESSA AND JACKSON          | 0        | 0         | 0        | 0         | 0         | 0          | 0          | 7         | 0        | 0        | 4         | 0         |
| <b>TOTAL:</b>  | <b>4</b> | <b>97</b> | <b>6</b> | <b>77</b> | <b>84</b> | <b>160</b> | <b>266</b> | <b>62</b> | <b>9</b> | <b>7</b> | <b>88</b> | <b>99</b> |

|       | LEFT | THRU | RIGHT |
|-------|------|------|-------|
| NORTH | 77   | 84   | 160   |
| EAST  | 7    | 88   | 99    |
| SOUTH | 4    | 97   | 6     |
| WEST  | 266  | 62   | 9     |

**AM APPROVED TRIPS**

07/22/2015

*Intersection of: KING/SAN ANTONIO*

Page No: 1

Traffic Node Number: 3627

| Permit No. / Description / Location  | M09      | M08       | M07      | M03      | M02       | M01      | M12      | M11      | M10      | M06      | M05      | M04      |
|--|----------|-----------|----------|----------|-----------|----------|----------|----------|----------|----------|----------|----------|
|  | NBL      | NBT       | NBR      | SBL      | SBT       | SBR      | EBL      | EBT      | EBR      | WBL      | WBT      | WBR      |
| H90-07-086<br>RETAIL OFC 13,540SF<br>SANTA CLARA (N/S) W/O KING  | 0        | 3         | 0        | 0        | 1         | 0        | 0        | 0        | 0        | 0        | 0        | 0        |
| -----  |          |           |          |          |           |          |          |          |          |          |          |          |
| NSJ<br>NORTH SAN JOSE  | 1        | 10        | 0        | 1        | 6         | 0        | 0        | 0        | 0        | 0        | 0        | 0        |
| -----  |          |           |          |          |           |          |          |          |          |          |          |          |
| PDC03-093<br>SJ REGIONAL MEDICAL CENTER<br>MCKEE RD AND N JACKSON AV                                   | 0        | 16        | 0        | 0        | 10        | 1        | 2        | 2        | 0        | 0        | 1        | 0        |
| -----  |          |           |          |          |           |          |          |          |          |          |          |          |
| PDC03-108 OFF<br>BERRYESSA FLEA MKT (OFFICE)<br>BOTH SIDES OF BERRYESSA RD WEST OF UNION PACIFIC       | 0        | 5         | 0        | 0        | 1         | 0        | 0        | 0        | 0        | 0        | 0        | 1        |
| -----  |          |           |          |          |           |          |          |          |          |          |          |          |
| PDC03-108 RES<br>BERRYESSA FLEA MKT (RESIDENTIAL)<br>BOTH SIDES OF BERRYESSA, WEST OF UNION PACIFIC RR | 0        | 19        | 0        | 1        | 35        | 0        | 0        | 0        | 0        | 0        | 0        | 1        |
| -----  |          |           |          |          |           |          |          |          |          |          |          |          |
| PDC03-108 RET<br>BERRYESSA FLEA MKT (RETAIL)<br>BOTH SIDES OF BERRYESSA, WEST OF UNION PACIFIC RR      | 0        | 0         | 0        | 0        | 0         | 0        | 0        | 0        | 0        | 0        | 0        | 0        |
| <b>TOTAL:</b>  | <b>1</b> | <b>53</b> | <b>0</b> | <b>2</b> | <b>53</b> | <b>1</b> | <b>2</b> | <b>2</b> | <b>0</b> | <b>0</b> | <b>1</b> | <b>2</b> |
|  |          |           |          | LEFT     | THRU      | RIGHT    |          |          |          |          |          |          |
|  |          |           |          | NORTH    | 2         | 53       | 1        |          |          |          |          |          |
|  |          |           |          | EAST     | 0         | 1        | 2        |          |          |          |          |          |
|  |          |           |          | SOUTH    | 1         | 53       | 0        |          |          |          |          |          |
|  |          |           |          | WEST     | 2         | 2        | 0        |          |          |          |          |          |

**PM APPROVED TRIPS**

07/22/2015

Intersection of: KING/SAN ANTONIO

Page No: 2

Traffic Node Number: 3627

| Permit No. / Description / Location  | M09 | M08 | M07 | M03 | M02 | M01 | M12 | M11 | M10 | M06 | M05 | M04 |
|--|-----|-----|-----|-----|-----|-----|-----|-----|-----|-----|-----|-----|
|  | NBL | NBT | NBR | SBL | SBT | SBR | EBL | EBT | EBR | WBL | WBT | WBR |
| H90-07-086<br>RETAIL OFC 13,540SF<br>SANTA CLARA (N/S) W/O KING  | 0   | 1   | 0   | 0   | 3   | 0   | 0   | 0   | 0   | 0   | 0   | 0   |
| H90-07-086C<br>RETAIL OFC<br>SANTA CLARA (N/S) W/O KING  | 0   | 2   | 0   | 0   | 2   | 0   | 0   | 0   | 0   | 0   | 0   | 0   |
| NSJ<br>NORTH SAN JOSE  | 1   | 6   | 1   | 2   | 10  | 0   | 0   | 0   | 0   | 0   | 0   | 0   |
| PDC03-093<br>SJ REGIONAL MEDICAL CENTER<br>MCKEE RD AND N JACKSON AV                                   | 0   | 7   | 0   | 0   | 16  | 2   | 1   | 1   | 0   | 0   | 2   | 0   |
| PDC03-108 OFF<br>BERRYESSA FLEA MKT (OFFICE)<br>BOTH SIDES OF BERRYESSA RD WEST OF UNION PACIFIC       | 0   | 1   | 0   | 0   | 5   | 0   | 0   | 0   | 0   | 0   | 0   | 0   |
| PDC03-108 RES<br>BERRYESSA FLEA MKT (RESIDENTIAL)<br>BOTH SIDES OF BERRYESSA, WEST OF UNION PACIFIC RR | 0   | 35  | 0   | 0   | 18  | 0   | 0   | 0   | 0   | 0   | 0   | 1   |
| PDC03-108 RET<br>BERRYESSA FLEA MKT (RETAIL)<br>BOTH SIDES OF BERRYESSA, WEST OF UNION PACIFIC RR      | 0   | 0   | 0   | 0   | 0   | 0   | 0   | 0   | 0   | 0   | 0   | 0   |

**TOTAL: 1 52 1 2 54 2 1 1 0 0 2 1**

|       | LEFT | THRU | RIGHT |
|-------|------|------|-------|
| NORTH | 2    | 54   | 2     |
| EAST  | 0    | 2    | 1     |
| SOUTH | 1    | 52   | 1     |
| WEST  | 1    | 1    | 0     |

**AM APPROVED TRIPS**

07/22/2015

*Intersection of: MCLAUGHLIN/STORY*

Page No: 1

Traffic Node Number: 3683

| Permit No. / Description / Location                               | M09 | M08 | M07 | M03 | M02 | M01 | M12 | M11 | M10 | M06 | M05 | M04 |
|---|-----|-----|-----|-----|-----|-----|-----|-----|-----|-----|-----|-----|
|   | NBL | NBT | NBR | SBL | SBT | SBR | EBL | EBT | EBR | WBL | WBT | WBR |
| DOWNTOWN<br>DOWNTOWN STRATEGY PLAN 2000<br>DOWNTOWN CORE          | 0   | 2   | 0   | 0   | 0   | 0   | 1   | 1   | 0   | 0   | 2   | 1   |
| -----   |     |     |     |     |     |     |     |     |     |     |     |     |
| EEHDP (RES)<br>EEHDP (RESIDENTIAL)<br>EVERGREEN                   | 0   | 2   | 0   | 0   | 0   | 0   | 0   | 0   | 1   | 0   | 0   | 0   |
| -----   |     |     |     |     |     |     |     |     |     |     |     |     |
| EEHDP (RETAIL)<br>EEHDP (RETAIL)<br>EVERGREEN                     | 0   | 1   | 0   | 0   | 0   | 0   | 0   | 0   | 1   | 0   | 0   | 0   |
| -----   |     |     |     |     |     |     |     |     |     |     |     |     |
| PDC04-045<br>VIETNAMTOWN<br>N/S STORY ROAD, 720' SW OF MCLAUGHLIN | 32  | 0   | 0   | 0   | 0   | 55  | 36  | 125 | 22  | 0   | 189 | 0   |

**TOTAL: 32 5 0 0 0 55 37 126 24 0 191 1**

|       | LEFT | THRU | RIGHT |
|-------|------|------|-------|
| NORTH | 0    | 0    | 55    |
| EAST  | 0    | 191  | 1     |
| SOUTH | 32   | 5    | 0     |
| WEST  | 37   | 126  | 24    |

**PM APPROVED TRIPS**

07/22/2015

*Intersection of: MCLAUGHLIN/STORY*

Page No: 2

Traffic Node Number: 3683

| Permit No. / Description / Location                               | M09 | M08 | M07 | M03 | M02 | M01 | M12 | M11 | M10 | M06 | M05 | M04 |
|---|-----|-----|-----|-----|-----|-----|-----|-----|-----|-----|-----|-----|
|   | NBL | NBT | NBR | SBL | SBT | SBR | EBL | EBT | EBR | WBL | WBT | WBR |
| DOWNTOWN<br>DOWNTOWN STRATEGY PLAN 2000<br>DOWNTOWN CORE          | 2   | 6   | 5   | 3   | 17  | 5   | 5   | 19  | 2   | 11  | 17  | 5   |
| -----   |     |     |     |     |     |     |     |     |     |     |     |     |
| EEHDP (RES)<br>EEHDP (RESIDENTIAL)<br>EVERGREEN                   | 0   | 1   | 0   | 0   | 0   | 0   | 0   | 0   | 1   | 0   | 0   | 0   |
| -----   |     |     |     |     |     |     |     |     |     |     |     |     |
| EEHDP (RETAIL)<br>EEHDP (RETAIL)<br>EVERGREEN                     | 1   | 7   | 0   | 0   | 0   | 0   | 0   | 0   | 3   | 0   | 0   | 0   |
| -----   |     |     |     |     |     |     |     |     |     |     |     |     |
| PDC04-045<br>VIETNAMTOWN<br>N/S STORY ROAD, 720' SW OF MCLAUGHLIN | 68  | 0   | 0   | 0   | 0   | 115 | 115 | 392 | 67  | 0   | 393 | 0   |

**TOTAL: 71 14 5 3 17 120 120 411 73 11 410 5**

|       | LEFT | THRU | RIGHT |
|-------|------|------|-------|
| NORTH | 3    | 17   | 120   |
| EAST  | 11   | 410  | 5     |
| SOUTH | 71   | 14   | 5     |
| WEST  | 120  | 411  | 73    |



**AM APPROVED TRIPS**

07/22/2015

*Intersection of: SAN ANTONIO/TWENTY-FOURTH*

Page No: 1

Traffic Node Number: 3762

| Permit No. / Description / Location | M09<br>NBL | M08<br>NBT | M07<br>NBR | M03<br>SBL | M02<br>SBT | M01<br>SBR | M12<br>EBL | M11<br>EBT | M10<br>EBR | M06<br>WBL | M05<br>WBT | M04<br>WBR |
|-------------------------------------|------------|------------|------------|------------|------------|------------|------------|------------|------------|------------|------------|------------|
| NSJ<br>NORTH SAN JOSE               | 0          | 10         | 1          | 0          | 3          | 0          | 0          | 0          | 0          | 0          | 0          | 0          |

**TOTAL:**      0    10    1      0    3    0      0    0    0      0    0    0

|       | LEFT | THRU | RIGHT |
|-------|------|------|-------|
| NORTH | 0    | 3    | 0     |
| EAST  | 0    | 0    | 0     |
| SOUTH | 0    | 10   | 1     |
| WEST  | 0    | 0    | 0     |

**PM APPROVED TRIPS**

07/22/2015

*Intersection of: SAN ANTONIO/TWENTY-FOURTH*

Page No: 2

Traffic Node Number: 3762

| Permit No. / Description / Location | M09<br>NBL | M08<br>NBT | M07<br>NBR | M03<br>SBL | M02<br>SBT | M01<br>SBR | M12<br>EBL | M11<br>EBT | M10<br>EBR | M06<br>WBL | M05<br>WBT | M04<br>WBR |
|-------------------------------------|------------|------------|------------|------------|------------|------------|------------|------------|------------|------------|------------|------------|
| NSJ<br>NORTH SAN JOSE               | 0          | 3          | 1          | 1          | 10         | 0          | 0          | 0          | 0          | 0          | 0          | 0          |

**TOTAL:**      0      3      1      1      10      0      0      0      0      0      0      0

|       | LEFT | THRU | RIGHT |
|-------|------|------|-------|
| NORTH | 1    | 10   | 0     |
| EAST  | 0    | 0    | 0     |
| SOUTH | 0    | 3    | 1     |
| WEST  | 0    | 0    | 0     |

**AM APPROVED TRIPS**

07/22/2015

*Intersection of: SANTA CLARA/SEVENTEENTH*

Page No: 1

Traffic Node Number: 3783

| Permit No. / Description / Location | M09<br>NBL | M08<br>NBT | M07<br>NBR | M03<br>SBL | M02<br>SBT | M01<br>SBR | M12<br>EBL | M11<br>EBT | M10<br>EBR | M06<br>WBL | M05<br>WBT | M04<br>WBR |
|-------------------------------------|------------|------------|------------|------------|------------|------------|------------|------------|------------|------------|------------|------------|
| NSJ<br>NORTH SAN JOSE               | 0          | 0          | 0          | 0          | 0          | 0          | 0          | 0          | 0          | 0          | 6          | 1          |

**TOTAL:** 0 0 0 0 0 0 0 0 0 0 0 6 1

|       | LEFT | THRU | RIGHT |
|-------|------|------|-------|
| NORTH | 0    | 0    | 0     |
| EAST  | 0    | 6    | 1     |
| SOUTH | 0    | 0    | 0     |
| WEST  | 0    | 0    | 0     |

**PM APPROVED TRIPS**

07/22/2015

*Intersection of: SANTA CLARA/SEVENTEENTH*

Page No: 2

Traffic Node Number: 3783

| Permit No. / Description / Location | M09<br>NBL | M08<br>NBT | M07<br>NBR | M03<br>SBL | M02<br>SBT | M01<br>SBR | M12<br>EBL | M11<br>EBT | M10<br>EBR | M06<br>WBL | M05<br>WBT | M04<br>WBR |
|-------------------------------------|------------|------------|------------|------------|------------|------------|------------|------------|------------|------------|------------|------------|
| NSJ<br>NORTH SAN JOSE               | 0          | 0          | 0          | 0          | 0          | 0          | 0          | 3          | 0          | 0          | 1          | 0          |

|               |          |          |          |          |          |          |          |          |          |          |          |          |
|---------------|----------|----------|----------|----------|----------|----------|----------|----------|----------|----------|----------|----------|
| <b>TOTAL:</b> | <b>0</b> | <b>0</b> | <b>0</b> | <b>0</b> | <b>0</b> | <b>0</b> | <b>0</b> | <b>3</b> | <b>0</b> | <b>0</b> | <b>1</b> | <b>0</b> |
|---------------|----------|----------|----------|----------|----------|----------|----------|----------|----------|----------|----------|----------|

|       | LEFT | THRU | RIGHT |
|-------|------|------|-------|
| NORTH | 0    | 0    | 0     |
| EAST  | 0    | 1    | 0     |
| SOUTH | 0    | 0    | 0     |
| WEST  | 0    | 3    | 0     |

**AM APPROVED TRIPS**

07/22/2015

*Intersection of: SANTA CLARA/TWENTY-EIGHTH*

Page No: 1

Traffic Node Number: 3788

| Permit No. / Description / Location | M09<br>NBL | M08<br>NBT | M07<br>NBR | M03<br>SBL | M02<br>SBT | M01<br>SBR | M12<br>EBL | M11<br>EBT | M10<br>EBR | M06<br>WBL | M05<br>WBT | M04<br>WBR |
|-------------------------------------|------------|------------|------------|------------|------------|------------|------------|------------|------------|------------|------------|------------|
| NSJ<br>NORTH SAN JOSE               | 0          | 0          | 0          | 0          | 0          | 0          | 0          | 8          | 0          | 0          | 7          | 0          |

**TOTAL:** 0 0 0 0 0 0 0 8 0 0 7 0

|       | LEFT | THRU | RIGHT |
|-------|------|------|-------|
| NORTH | 0    | 0    | 0     |
| EAST  | 0    | 7    | 0     |
| SOUTH | 0    | 0    | 0     |
| WEST  | 0    | 8    | 0     |

**PM APPROVED TRIPS**

07/22/2015

*Intersection of: SANTA CLARA/TWENTY-EIGHTH*

Page No: 2

Traffic Node Number: 3788

| Permit No. / Description / Location | M09<br>NBL | M08<br>NBT | M07<br>NBR | M03<br>SBL | M02<br>SBT | M01<br>SBR | M12<br>EBL | M11<br>EBT | M10<br>EBR | M06<br>WBL | M05<br>WBT | M04<br>WBR |
|-------------------------------------|------------|------------|------------|------------|------------|------------|------------|------------|------------|------------|------------|------------|
| NSJ<br>NORTH SAN JOSE               | 0          | 0          | 0          | 0          | 0          | 0          | 0          | 7          | 0          | 1          | 9          | 0          |

**TOTAL:** 0 0 0 0 0 0 0 7 0 1 9 0

|       | LEFT | THRU | RIGHT |
|-------|------|------|-------|
| NORTH | 0    | 0    | 0     |
| EAST  | 1    | 9    | 0     |
| SOUTH | 0    | 0    | 0     |
| WEST  | 0    | 7    | 0     |

**AM APPROVED TRIPS**

07/22/2015

*Intersection of: SANTA CLARA/TWENTY-FIRST*

Page No: 1

Traffic Node Number: 3789

| Permit No. / Description / Location | M09<br>NBL | M08<br>NBT | M07<br>NBR | M03<br>SBL | M02<br>SBT | M01<br>SBR | M12<br>EBL | M11<br>EBT | M10<br>EBR | M06<br>WBL | M05<br>WBT | M04<br>WBR |
|-------------------------------------|------------|------------|------------|------------|------------|------------|------------|------------|------------|------------|------------|------------|
| NSJ<br>NORTH SAN JOSE               | 0          | 0          | 0          | 0          | 0          | 0          | 0          | 1          | 0          | 0          | 8          | 0          |

**TOTAL:** 0 0 0 0 0 0 0 1 0 0 8 0

|       | LEFT | THRU | RIGHT |
|-------|------|------|-------|
| NORTH | 0    | 0    | 0     |
| EAST  | 0    | 8    | 0     |
| SOUTH | 0    | 0    | 0     |
| WEST  | 0    | 1    | 0     |

**PM APPROVED TRIPS**

07/22/2015

*Intersection of: SANTA CLARA/TWENTY-FIRST*

Page No: 2

Traffic Node Number: 3789

| Permit No. / Description / Location | M09<br>NBL | M08<br>NBT | M07<br>NBR | M03<br>SBL | M02<br>SBT | M01<br>SBR | M12<br>EBL | M11<br>EBT | M10<br>EBR | M06<br>WBL | M05<br>WBT | M04<br>WBR |
|-------------------------------------|------------|------------|------------|------------|------------|------------|------------|------------|------------|------------|------------|------------|
| NSJ<br>NORTH SAN JOSE               | 0          | 0          | 0          | 0          | 0          | 0          | 0          | 4          | 0          | 0          | 2          | 0          |

**TOTAL:** 0 0 0 0 0 0 0 4 0 0 2 0

|       | LEFT | THRU | RIGHT |
|-------|------|------|-------|
| NORTH | 0    | 0    | 0     |
| EAST  | 0    | 2    | 0     |
| SOUTH | 0    | 0    | 0     |
| WEST  | 0    | 4    | 0     |



**AM APPROVED TRIPS**

07/22/2015

*Intersection of: SANTA CLARA/TWENTY-FOURTH*

Page No: 1

Traffic Node Number: 3790

| Permit No. / Description / Location   | M09 | M08 | M07 | M03 | M02 | M01 | M12 | M11 | M10 | M06 | M05 | M04 |
|---|-----|-----|-----|-----|-----|-----|-----|-----|-----|-----|-----|-----|
|   | NBL | NBT | NBR | SBL | SBT | SBR | EBL | EBT | EBR | WBL | WBT | WBR |
| NSJ<br>NORTH SAN JOSE   | 4   | 9   | 2   | 0   | 0   | 0   | 0   | 0   | 0   | 0   | 5   | 0   |
| -----<br>PDC03-108 OFF<br>BERRYESSA FLEA MKT (OFFICE)<br>BOTH SIDES OF BERRYESSA RD WEST OF UNION PACIFIC       | 0   | 1   | 1   | 0   | 0   | 0   | 0   | 0   | 0   | 0   | 0   | 0   |
| -----<br>PDC03-108 RES<br>BERRYESSA FLEA MKT (RESIDENTIAL)<br>BOTH SIDES OF BERRYESSA, WEST OF UNION PACIFIC RR | 0   | 2   | 3   | 0   | 3   | 0   | 0   | 0   | 0   | 5   | 0   | 0   |
| -----<br>PDC03-108 RET<br>BERRYESSA FLEA MKT (RETAIL)<br>BOTH SIDES OF BERRYESSA, WEST OF UNION PACIFIC RR      | 0   | 0   | 0   | 0   | 0   | 0   | 0   | 0   | 0   | 0   | 0   | 0   |

**TOTAL: 4 12 6 0 3 0 0 0 0 5 5 0**

|       | LEFT | THRU | RIGHT |
|-------|------|------|-------|
| NORTH | 0    | 3    | 0     |
| EAST  | 5    | 5    | 0     |
| SOUTH | 4    | 12   | 6     |
| WEST  | 0    | 0    | 0     |

**PM APPROVED TRIPS**

07/22/2015

*Intersection of: SANTA CLARA/TWENTY-FOURTH*

Page No: 2

Traffic Node Number: 3790

| Permit No. / Description / Location   | M09 | M08 | M07 | M03 | M02 | M01 | M12 | M11 | M10 | M06 | M05 | M04 |
|---|-----|-----|-----|-----|-----|-----|-----|-----|-----|-----|-----|-----|
|   | NBL | NBT | NBR | SBL | SBT | SBR | EBL | EBT | EBR | WBL | WBT | WBR |
| NSJ<br>NORTH SAN JOSE   | 0   | 2   | 1   | 1   | 7   | 1   | 0   | 4   | 0   | 0   | 2   | 0   |
| -----<br>PDC03-108 OFF<br>BERRYESSA FLEA MKT (OFFICE)<br>BOTH SIDES OF BERRYESSA RD WEST OF UNION PACIFIC       | 0   | 0   | 0   | 0   | 1   | 0   | 0   | 0   | 0   | 1   | 0   | 0   |
| -----<br>PDC03-108 RES<br>BERRYESSA FLEA MKT (RESIDENTIAL)<br>BOTH SIDES OF BERRYESSA, WEST OF UNION PACIFIC RR | 0   | 3   | 5   | 0   | 2   | 0   | 0   | 0   | 0   | 3   | 0   | 0   |
| -----<br>PDC03-108 RET<br>BERRYESSA FLEA MKT (RETAIL)<br>BOTH SIDES OF BERRYESSA, WEST OF UNION PACIFIC RR      | 0   | 0   | 0   | 0   | 0   | 0   | 0   | 0   | 0   | 0   | 0   | 0   |

**TOTAL: 0 5 6 1 10 1 0 4 0 4 2 0**

|       | LEFT | THRU | RIGHT |
|-------|------|------|-------|
| NORTH | 1    | 10   | 1     |
| EAST  | 4    | 2    | 0     |
| SOUTH | 0    | 5    | 6     |
| WEST  | 0    | 4    | 0     |

**AM APPROVED TRIPS**

07/22/2015

*Intersection of: TWENTY-FOURTH/WILLIAM*

Page No: 1

Traffic Node Number: 3832

| Permit No. / Description / Location | M09<br>NBL | M08<br>NBT | M07<br>NBR | M03<br>SBL | M02<br>SBT | M01<br>SBR | M12<br>EBL | M11<br>EBT | M10<br>EBR | M06<br>WBL | M05<br>WBT | M04<br>WBR |
|-------------------------------------|------------|------------|------------|------------|------------|------------|------------|------------|------------|------------|------------|------------|
| NSJ<br>NORTH SAN JOSE               | 1          | 5          | 0          | 0          | 2          | 0          | 0          | 0          | 0          | 5          | 2          | 0          |

**TOTAL:** 1 5 0 0 2 0 0 0 0 5 2 0

|       | LEFT | THRU | RIGHT |
|-------|------|------|-------|
| NORTH | 0    | 2    | 0     |
| EAST  | 5    | 2    | 0     |
| SOUTH | 1    | 5    | 0     |
| WEST  | 0    | 0    | 0     |

**PM APPROVED TRIPS**

07/22/2015

*Intersection of: TWENTY-FOURTH/WILLIAM*

Page No: 2

Traffic Node Number: 3832

| Permit No. / Description / Location | M09<br>NBL | M08<br>NBT | M07<br>NBR | M03<br>SBL | M02<br>SBT | M01<br>SBR | M12<br>EBL | M11<br>EBT | M10<br>EBR | M06<br>WBL | M05<br>WBT | M04<br>WBR |
|-------------------------------------|------------|------------|------------|------------|------------|------------|------------|------------|------------|------------|------------|------------|
| NSJ<br>NORTH SAN JOSE               | 0          | 0          | 0          | 0          | 10         | 0          | 0          | 0          | 0          | 2          | 1          | 0          |

|               |          |          |          |          |           |          |          |          |          |          |          |          |
|---------------|----------|----------|----------|----------|-----------|----------|----------|----------|----------|----------|----------|----------|
| <b>TOTAL:</b> | <b>0</b> | <b>0</b> | <b>0</b> | <b>0</b> | <b>10</b> | <b>0</b> | <b>0</b> | <b>0</b> | <b>0</b> | <b>2</b> | <b>1</b> | <b>0</b> |
|---------------|----------|----------|----------|----------|-----------|----------|----------|----------|----------|----------|----------|----------|

|       | LEFT | THRU | RIGHT |
|-------|------|------|-------|
| NORTH | 0    | 10   | 0     |
| EAST  | 2    | 1    | 0     |
| SOUTH | 0    | 0    | 0     |
| WEST  | 0    | 0    | 0     |

**AM APPROVED TRIPS**

07/22/2015

*Intersection of: 28TH/JULIAN*

Page No: 1

Traffic Node Number: 4005

| Permit No. / Description / Location | M09<br>NBL | M08<br>NBT | M07<br>NBR | M03<br>SBL | M02<br>SBT | M01<br>SBR | M12<br>EBL | M11<br>EBT | M10<br>EBR | M06<br>WBL | M05<br>WBT | M04<br>WBR |
|-------------------------------------|------------|------------|------------|------------|------------|------------|------------|------------|------------|------------|------------|------------|
| NSJ<br>NORTH SAN JOSE               | 0          | 0          | 0          | 0          | 0          | 0          | 0          | 0          | 0          | 0          | 0          | 0          |

**TOTAL:** 0 0 0 0 0 0 0 0 0 0 0 0 0

|       | LEFT | THRU | RIGHT |
|-------|------|------|-------|
| NORTH | 0    | 0    | 0     |
| EAST  | 0    | 0    | 0     |
| SOUTH | 0    | 0    | 0     |
| WEST  | 0    | 0    | 0     |

**PM APPROVED TRIPS**

07/22/2015

*Intersection of: 28TH/JULIAN*

Page No: 2

Traffic Node Number: 4005

| Permit No. / Description / Location | M09<br>NBL | M08<br>NBT | M07<br>NBR | M03<br>SBL | M02<br>SBT | M01<br>SBR | M12<br>EBL | M11<br>EBT | M10<br>EBR | M06<br>WBL | M05<br>WBT | M04<br>WBR |
|-------------------------------------|------------|------------|------------|------------|------------|------------|------------|------------|------------|------------|------------|------------|
| NSJ<br>NORTH SAN JOSE               | 0          | 0          | 0          | 0          | 0          | 0          | 0          | 0          | 0          | 0          | 0          | 0          |

|               |   |   |   |   |   |   |   |   |   |   |   |   |
|---------------|---|---|---|---|---|---|---|---|---|---|---|---|
| <b>TOTAL:</b> | 0 | 0 | 0 | 0 | 0 | 0 | 0 | 0 | 0 | 0 | 0 | 0 |
|---------------|---|---|---|---|---|---|---|---|---|---|---|---|

|       | LEFT | THRU | RIGHT |
|-------|------|------|-------|
| NORTH | 0    | 0    | 0     |
| EAST  | 0    | 0    | 0     |
| SOUTH | 0    | 0    | 0     |
| WEST  | 0    | 0    | 0     |

**AM APPROVED TRIPS**

07/22/2015

*Intersection of: 26TH/SANTA CLARA*

Page No: 1

Traffic Node Number: 4022

| Permit No. / Description / Location | M09<br>NBL | M08<br>NBT | M07<br>NBR | M03<br>SBL | M02<br>SBT | M01<br>SBR | M12<br>EBL | M11<br>EBT | M10<br>EBR | M06<br>WBL | M05<br>WBT | M04<br>WBR |
|-------------------------------------|------------|------------|------------|------------|------------|------------|------------|------------|------------|------------|------------|------------|
| NSJ<br>NORTH SAN JOSE               | 0          | 0          | 0          | 0          | 0          | 0          | 0          | 4          | 0          | 0          | 5          | 0          |

**TOTAL:** 0 0 0 0 0 0 0 4 0 0 5 0

|       | LEFT | THRU | RIGHT |
|-------|------|------|-------|
| NORTH | 0    | 0    | 0     |
| EAST  | 0    | 5    | 0     |
| SOUTH | 0    | 0    | 0     |
| WEST  | 0    | 4    | 0     |

**PM APPROVED TRIPS**

07/22/2015

*Intersection of: 26TH/SANTA CLARA*

Page No: 2

Traffic Node Number: 4022

| Permit No. / Description / Location | M09<br>NBL | M08<br>NBT | M07<br>NBR | M03<br>SBL | M02<br>SBT | M01<br>SBR | M12<br>EBL | M11<br>EBT | M10<br>EBR | M06<br>WBL | M05<br>WBT | M04<br>WBR |
|-------------------------------------|------------|------------|------------|------------|------------|------------|------------|------------|------------|------------|------------|------------|
| NSJ<br>NORTH SAN JOSE               | 0          | 0          | 0          | 0          | 0          | 0          | 0          | 4          | 0          | 0          | 3          | 0          |

|               |          |          |          |          |          |          |          |          |          |          |          |          |
|---------------|----------|----------|----------|----------|----------|----------|----------|----------|----------|----------|----------|----------|
| <b>TOTAL:</b> | <b>0</b> | <b>0</b> | <b>0</b> | <b>0</b> | <b>0</b> | <b>0</b> | <b>0</b> | <b>4</b> | <b>0</b> | <b>0</b> | <b>3</b> | <b>0</b> |
|---------------|----------|----------|----------|----------|----------|----------|----------|----------|----------|----------|----------|----------|

|       | LEFT | THRU | RIGHT |
|-------|------|------|-------|
| NORTH | 0    | 0    | 0     |
| EAST  | 0    | 3    | 0     |
| SOUTH | 0    | 0    | 0     |
| WEST  | 0    | 4    | 0     |







**PM APPROVED TRIPS**

09/18/2015

*Intersection of: MCKEE/THIRTY THIRD*

Page No: 3

Traffic Node Number: 3678

| Permit No. / Description / Location                               | M09      | M08      | M07      | M03      | M02      | M01      | M12      | M11        | M10      | M06      | M05        | M04      |
|---|----------|----------|----------|----------|----------|----------|----------|------------|----------|----------|------------|----------|
|   | NBL      | NBT      | NBR      | SBL      | SBT      | SBR      | EBL      | EBT        | EBR      | WBL      | WBT        | WBR      |
| PDC07-015 RES<br>KING AND DOBBIN<br>NE/C OF KING RD AND DOBBIN DR | 0        | 0        | 0        | 0        | 0        | 0        | 0        | 172        | 0        | 0        | 80         | 0        |
| -----   |          |          |          |          |          |          |          |            |          |          |            |          |
| PDC07-015 RET<br>KING AND DOBBIN<br>NE/C OF KING RD AND DOBBIN DR | 0        | 0        | 0        | 0        | 0        | 0        | 0        | 0          | 0        | 0        | 0          | 0        |
| <b>TOTAL:</b>   | <b>4</b> | <b>3</b> | <b>1</b> | <b>2</b> | <b>0</b> | <b>0</b> | <b>0</b> | <b>288</b> | <b>1</b> | <b>4</b> | <b>221</b> | <b>0</b> |

|       | LEFT | THRU | RIGHT |
|-------|------|------|-------|
| NORTH | 2    | 0    | 0     |
| EAST  | 4    | 221  | 0     |
| SOUTH | 4    | 3    | 1     |
| WEST  | 0    | 288  | 1     |

**AM APPROVED TRIPS**

09/18/2015

*Intersection of: ALUM ROCK/THIRTY THIRD*

Page No: 1

Traffic Node Number: 3260

| Permit No. / Description / Location                             | M09      | M08      | M07      | M03      | M02      | M01      | M12      | M11       | M10      | M06      | M05      | M04      |
|---|----------|----------|----------|----------|----------|----------|----------|-----------|----------|----------|----------|----------|
|   | NBL      | NBT      | NBR      | SBL      | SBT      | SBR      | EBL      | EBT       | EBR      | WBL      | WBT      | WBR      |
| H90-07-086<br>RETAIL OFC 13,540SF<br>SANTA CLARA (N/S) W/O KING | 0        | 0        | 6        | 0        | 0        | 0        | 0        | 6         | 0        | 0        | 1        | 0        |
| -----   |          |          |          |          |          |          |          |           |          |          |          |          |
| NSJ<br>NORTH SAN JOSE   | 0        | 0        | 0        | 0        | 0        | 0        | 0        | 10        | 0        | 0        | 5        | 0        |
| -----   |          |          |          |          |          |          |          |           |          |          |          |          |
| PDA97-01-004<br>SJ MED CENTR<br>MCKEE RD & JACKSON AV (SW/C)    | 0        | 0        | 0        | 0        | 0        | 0        | 0        | 0         | 0        | 0        | 0        | 0        |
| <b>TOTAL:</b>   | <b>0</b> | <b>0</b> | <b>6</b> | <b>0</b> | <b>0</b> | <b>0</b> | <b>0</b> | <b>16</b> | <b>0</b> | <b>0</b> | <b>6</b> | <b>0</b> |
|   |          |          |          | LEFT     | THRU     | RIGHT    |          |           |          |          |          |          |
|   |          |          |          | NORTH    | 0        | 0        | 0        |           |          |          |          |          |
|   |          |          |          | EAST     | 0        | 6        | 0        |           |          |          |          |          |
|   |          |          |          | SOUTH    | 0        | 0        | 6        |           |          |          |          |          |
|   |          |          |          | WEST     | 0        | 16       | 0        |           |          |          |          |          |

**PM APPROVED TRIPS**

09/18/2015

*Intersection of: ALUM ROCK/THIRTY THIRD*

Page No: 2

Traffic Node Number: 3260

| Permit No. / Description / Location                             | M09 | M08 | M07 | M03 | M02 | M01 | M12 | M11 | M10 | M06 | M05 | M04 |
|---|-----|-----|-----|-----|-----|-----|-----|-----|-----|-----|-----|-----|
|   | NBL | NBT | NBR | SBL | SBT | SBR | EBL | EBT | EBR | WBL | WBT | WBR |
| H90-07-086<br>RETAIL OFC 13,540SF<br>SANTA CLARA (N/S) W/O KING | 0   | 0   | 0   | 0   | 0   | 0   | 0   | 1   | 0   | 6   | 6   | 0   |
| H90-07-086C<br>RETAIL OFC<br>SANTA CLARA (N/S) W/O KING         | 0   | 0   | 4   | 0   | 0   | 0   | 0   | 13  | 0   | 16  | 16  | 1   |
| NSJ<br>NORTH SAN JOSE   | 1   | 0   | 0   | 0   | 0   | 0   | 0   | 4   | 0   | 1   | 23  | 1   |
| PDA97-01-004<br>SJ MED CENTR<br>MCKEE RD & JACKSON AV (SW/C)    | 0   | 0   | 0   | 0   | 0   | 0   | 0   | 0   | 0   | 0   | 0   | 0   |

**TOTAL: 1 0 4 0 0 0 0 18 0 23 45 2**

|       | LEFT | THRU | RIGHT |
|-------|------|------|-------|
| NORTH | 0    | 0    | 0     |
| EAST  | 23   | 45   | 2     |
| SOUTH | 1    | 0    | 4     |
| WEST  | 0    | 18   | 0     |

**AM APPROVED TRIPS**

09/22/2015

*Intersection of: 880/ALAMEDA (N)*

Page No: 1

Traffic Node Number: 3046

| Permit No. / Description / Location | M09 | M08 | M07 | M03 | M02 | M01 | M12 | M11 | M10 | M06 | M05 | M04 |
|-------------------------------------|-----|-----|-----|-----|-----|-----|-----|-----|-----|-----|-----|-----|
|                                     | NBL | NBT | NBR | SBL | SBT | SBR | EBL | EBT | EBR | WBL | WBT | WBR |
| NSJ<br>NORTH SAN JOSE               | 0   | 0   | 0   | 0   | 0   | 0   | 0   | 0   | 0   | 0   | 0   | 0   |

---

|   |   |   |   |   |   |   |   |   |   |    |   |   |
|---|---|---|---|---|---|---|---|---|---|----|---|---|
| NSJ - R<br>NORTH SAN JOSE REVISED 880/ALAMEDA (N) | 0 | 3 | 5 | 0 | 1 | 1 | 0 | 0 | 0 | 15 | 0 | 6 |
|---|---|---|---|---|---|---|---|---|---|----|---|---|

---

**TOTAL:**            0     3     5            0     1     1            0     0     0            15     0     6

|       | LEFT | THRU | RIGHT |
|-------|------|------|-------|
| NORTH | 0    | 1    | 1     |
| EAST  | 15   | 0    | 6     |
| SOUTH | 0    | 3    | 5     |
| WEST  | 0    | 0    | 0     |

**PM APPROVED TRIPS**

09/22/2015

*Intersection of: 880/ALAMEDA (N)*

Page No: 2

Traffic Node Number: 3046

| Permit No. / Description / Location                        | M09 | M08 | M07 | M03 | M02 | M01 | M12 | M11 | M10 | M06 | M05 | M04 |
|--|-----|-----|-----|-----|-----|-----|-----|-----|-----|-----|-----|-----|
|  | NBL | NBT | NBR | SBL | SBT | SBR | EBL | EBT | EBR | WBL | WBT | WBR |
| NSJ<br>NORTH SAN JOSE                                      | 0   | 0   | 0   | 0   | 0   | 0   | 0   | 0   | 0   | 0   | 0   | 0   |
| -----<br>NSJ - R<br>NORTH SAN JOSE REVISED 880/ALAMEDA (N) | 0   | 1   | 5   | 0   | 2   | 2   | 0   | 0   | 0   | 9   | 0   | 1   |

**TOTAL:            0    1    5            0    2    2            0    0    0            9    0    1**

|       | LEFT | THRU | RIGHT |
|-------|------|------|-------|
| NORTH | 0    | 2    | 2     |
| EAST  | 9    | 0    | 1     |
| SOUTH | 0    | 1    | 5     |
| WEST  | 0    | 0    | 0     |

**AM APPROVED TRIPS**

09/22/2015

*Intersection of: 880/ALAMEDA (S)*

Page No: 1

Traffic Node Number: 3047

| Permit No. / Description / Location | M09<br>NBL | M08<br>NBT | M07<br>NBR | M03<br>SBL | M02<br>SBT | M01<br>SBR | M12<br>EBL | M11<br>EBT | M10<br>EBR | M06<br>WBL | M05<br>WBT | M04<br>WBR |
|-------------------------------------|------------|------------|------------|------------|------------|------------|------------|------------|------------|------------|------------|------------|
| NSJ<br>NORTH SAN JOSE               | 0          | 2          | 0          | 0          | 8          | 2          | 3          | 0          | 3          | 0          | 0          | 0          |

**TOTAL:**      0      2      0      0      8      2      3      0      3      0      0      0

|       | LEFT | THRU | RIGHT |
|-------|------|------|-------|
| NORTH | 0    | 8    | 2     |
| EAST  | 0    | 0    | 0     |
| SOUTH | 0    | 2    | 0     |
| WEST  | 3    | 0    | 3     |



**PM APPROVED TRIPS**

09/22/2015

*Intersection of: 880/ALAMEDA (S)*

Page No: 2

Traffic Node Number: 3047

| Permit No. / Description / Location | M09<br>NBL | M08<br>NBT | M07<br>NBR | M03<br>SBL | M02<br>SBT | M01<br>SBR | M12<br>EBL | M11<br>EBT | M10<br>EBR | M06<br>WBL | M05<br>WBT | M04<br>WBR |
|-------------------------------------|------------|------------|------------|------------|------------|------------|------------|------------|------------|------------|------------|------------|
| NSJ<br>NORTH SAN JOSE               | 0          | 4          | 1          | 0          | 12         | 3          | 3          | 0          | 2          | 0          | 0          | 0          |

|               |          |          |          |          |           |          |          |          |          |          |          |          |
|---------------|----------|----------|----------|----------|-----------|----------|----------|----------|----------|----------|----------|----------|
| <b>TOTAL:</b> | <b>0</b> | <b>4</b> | <b>1</b> | <b>0</b> | <b>12</b> | <b>3</b> | <b>3</b> | <b>0</b> | <b>2</b> | <b>0</b> | <b>0</b> | <b>0</b> |
|---------------|----------|----------|----------|----------|-----------|----------|----------|----------|----------|----------|----------|----------|

|       | LEFT | THRU | RIGHT |
|-------|------|------|-------|
| NORTH | 0    | 12   | 3     |
| EAST  | 0    | 0    | 0     |
| SOUTH | 0    | 4    | 1     |
| WEST  | 3    | 0    | 2     |

**AM APPROVED TRIPS**

09/22/2015

*Intersection of: 880/COLEMAN (N)*

Page No: 1

Traffic Node Number: 3052

| Permit No. / Description / Location                          | M09 | M08 | M07 | M03 | M02 | M01 | M12 | M11 | M10 | M06 | M05 | M04 |
|--|-----|-----|-----|-----|-----|-----|-----|-----|-----|-----|-----|-----|
|  | NBL | NBT | NBR | SBL | SBT | SBR | EBL | EBT | EBR | WBL | WBT | WBR |
| AIRPORT<br>EXPANSION OF AIRPORT<br>SAN JOSE INTL AIRPORT     | 0   | 18  | 0   | 0   | 19  | 0   | 0   | 0   | 0   | 0   | 0   | 3   |
| CIM-BLOCK3<br>BLOCK 3<br>DOWNTOWN                            | 0   | 16  | 0   | 0   | 14  | 0   | 0   | 0   | 0   | 4   | 0   | 0   |
| CIM-FOUNTAIN<br>FOUNTAIN ALLEY<br>DOWNTOWN                   | 0   | 8   | 0   | 0   | 4   | 0   | 0   | 0   | 0   | 1   | 0   | 0   |
| DOWNTOWN<br>DOWNTOWN STRATEGY PLAN 2000<br>DOWNTOWN CORE     | 0   | 36  | 0   | 0   | 4   | 0   | 0   | 0   | 0   | 2   | 0   | 4   |
| NSJ<br>NORTH SAN JOSE  | 0   | 52  | 1   | 0   | 54  | 0   | 0   | 0   | 0   | 14  | 0   | 27  |
| PDC84-07-059<br>RIVER PARK II<br>PARK & WOZ (SE/C)           | 0   | 0   | 0   | 0   | 0   | 0   | 0   | 0   | 0   | 0   | 0   | 0   |
| PDC98-12-104HOT<br>FMC<br>W/S COLEMAN BET NEWHALL AND BROKAW | 0   | 53  | 0   | 0   | 51  | 0   | 0   | 0   | 0   | 0   | 0   | 9   |
| PDC98-12-104OFF<br>FMC<br>W/S COLEMAN BET NEWHALL AND BROKAW | 0   | 693 | 0   | 0   | 114 | 0   | 0   | 0   | 0   | 0   | 0   | 241 |
| PDC98-12-104RET<br>FMC<br>W/S COLEMAN BET NEWHALL AND BROKAW | 0   | 16  | 0   | 0   | 28  | 0   | 0   | 0   | 0   | 0   | 0   | 3   |
| RH00-05-005<br>BOSTON PROP<br>ALMADEN BLVD/WOZ WAY (NW/C)    | 0   | 2   | 0   | 0   | 26  | 0   | 0   | 0   | 0   | 0   | 0   | 0   |
| RH98-04-001<br>OPUS WEST<br>SANTA CLARA/ALMADEN              | 0   | 0   | 0   | 0   | 4   | 0   | 0   | 0   | 0   | 0   | 0   | 0   |

TOTAL: 0 894 1 0 318 0 0 0 0 21 0 287

LEFT THRU RIGHT

NORTH 0 318 0  
 EAST 21 0 287  
 SOUTH 0 894 1  
 WEST 0 0 0

**PM APPROVED TRIPS**

09/22/2015

*Intersection of: 880/COLEMAN (N)*

Page No: 2

Traffic Node Number: 3052

| Permit No. / Description / Location                          | M09<br>NBL | M08<br>NBT | M07<br>NBR | M03<br>SBL | M02<br>SBT | M01<br>SBR | M12<br>EBL | M11<br>EBT | M10<br>EBR | M06<br>WBL | M05<br>WBT | M04<br>WBR |
|--|------------|------------|------------|------------|------------|------------|------------|------------|------------|------------|------------|------------|
| AIRPORT<br>EXPANSION OF AIRPORT<br>SAN JOSE INTL AIRPORT     | 0          | 20         | 0          | 0          | 30         | 0          | 0          | 0          | 0          | 0          | 0          | 3          |
| CIM-BLOCK3<br>BLOCK 3<br>DOWNTOWN                            | 0          | 15         | 6          | 0          | 18         | 0          | 0          | 0          | 0          | 2          | 0          | 0          |
| CIM-FOUNTAIN<br>FOUNTAIN ALLEY<br>DOWNTOWN                   | 0          | 6          | 1          | 0          | 5          | 0          | 0          | 0          | 0          | 1          | 0          | 0          |
| DOWNTOWN<br>DOWNTOWN STRATEGY PLAN 2000<br>DOWNTOWN CORE     | 0          | 8          | 0          | 0          | 17         | 0          | 0          | 0          | 0          | 1          | 0          | 1          |
| NSJ<br>NORTH SAN JOSE  | 0          | 14         | 3          | 0          | 47         | 0          | 0          | 0          | 0          | 35         | 4          | 61         |
| PDC84-07-059<br>RIVER PARK II<br>PARK & WOZ (SE/C)           | 0          | 0          | 0          | 0          | 0          | 0          | 0          | 0          | 0          | 0          | 0          | 0          |
| PDC98-12-104HOT<br>FMC<br>W/S COLEMAN BET NEWHALL AND BROKAW | 0          | 53         | 0          | 0          | 51         | 0          | 0          | 0          | 0          | 0          | 0          | 9          |
| PDC98-12-104OFF<br>FMC<br>W/S COLEMAN BET NEWHALL AND BROKAW | 0          | 109        | 0          | 0          | 591        | 0          | 0          | 0          | 0          | 0          | 0          | 38         |
| PDC98-12-104RET<br>FMC<br>W/S COLEMAN BET NEWHALL AND BROKAW | 0          | 106        | 0          | 0          | 85         | 0          | 0          | 0          | 0          | 0          | 0          | 22         |

**PM APPROVED TRIPS**

09/22/2015

*Intersection of: 880/COLEMAN (N)*

Page No: 3

Traffic Node Number: 3052

| Permit No. / Description / Location                       | M09 | M08 | M07 | M03 | M02 | M01 | M12 | M11 | M10 | M06 | M05 | M04 |
|---|-----|-----|-----|-----|-----|-----|-----|-----|-----|-----|-----|-----|
|   | NBL | NBT | NBR | SBL | SBT | SBR | EBL | EBT | EBR | WBL | WBT | WBR |
| PP10-155<br>COLEMAN SOCCER COMPLEX<br>TERMINUS            | 0   | 23  | 0   | 5   | 10  | 0   | 0   | 0   | 0   | 0   | 0   | 11  |
| RH00-05-005<br>BOSTON PROP<br>ALMADEN BLVD/WOZ WAY (NW/C) | 0   | 23  | 0   | 0   | 3   | 0   | 0   | 0   | 0   | 0   | 0   | 0   |
| RH98-04-001<br>OPUS WEST<br>SANTA CLARA/ALMADEN           | 0   | 3   | 0   | 0   | 0   | 0   | 0   | 0   | 0   | 0   | 0   | 0   |

**TOTAL: 0 380 10 5 857 0 0 0 0 39 4 145**

|       | LEFT | THRU | RIGHT |
|-------|------|------|-------|
| NORTH | 5    | 857  | 0     |
| EAST  | 39   | 4    | 145   |
| SOUTH | 0    | 380  | 10    |
| WEST  | 0    | 0    | 0     |

**AM APPROVED TRIPS**

09/22/2015

*Intersection of: 880/COLEMAN (S)*

Page No: 1

Traffic Node Number: 3053

| Permit No. / Description / Location                          | M09 | M08 | M07 | M03 | M02 | M01 | M12 | M11 | M10 | M06 | M05 | M04 |
|--|-----|-----|-----|-----|-----|-----|-----|-----|-----|-----|-----|-----|
|  | NBL | NBT | NBR | SBL | SBT | SBR | EBL | EBT | EBR | WBL | WBT | WBR |
| AIRPORT<br>EXPANSION OF AIRPORT<br>SAN JOSE INTL AIRPORT     | 0   | 3   | 0   | 2   | 2   | 0   | 0   | 0   | 0   | 0   | 0   | 14  |
| CIM-BLOCK3<br>BLOCK 3<br>DOWNTOWN                            | 0   | 16  | 0   | 0   | 18  | 0   | 0   | 0   | 0   | 5   | 0   | 0   |
| CIM-FOUNTAIN<br>FOUNTAIN ALLEY<br>DOWNTOWN                   | 0   | 7   | 0   | 0   | 5   | 0   | 0   | 0   | 0   | 1   | 0   | 0   |
| DOWNTOWN<br>DOWNTOWN STRATEGY PLAN 2000<br>DOWNTOWN CORE     | 0   | 9   | 0   | 0   | 2   | 0   | 0   | 0   | 0   | 0   | 0   | 4   |
| NSJ<br>NORTH SAN JOSE  | 0   | 26  | 2   | 0   | 6   | 0   | 0   | 0   | 0   | 1   | 0   | 19  |
| PDC84-07-059<br>RIVER PARK II<br>PARK & WOZ (SE/C)           | 0   | 0   | 0   | 0   | 0   | 0   | 0   | 0   | 0   | 0   | 0   | 0   |
| PDC98-12-104HOT<br>FMC<br>W/S COLEMAN BET NEWHALL AND BROKAW | 0   | 54  | 0   | 8   | 43  | 0   | 0   | 0   | 0   | 0   | 0   | 12  |
| PDC98-12-104OFF<br>FMC<br>W/S COLEMAN BET NEWHALL AND BROKAW | 0   | 346 | 0   | 46  | 67  | 0   | 0   | 0   | 0   | 0   | 0   | 346 |
| PDC98-12-104RET<br>FMC<br>W/S COLEMAN BET NEWHALL AND BROKAW | 0   | 13  | 0   | 3   | 8   | 0   | 0   | 0   | 0   | 0   | 0   | 3   |
| RH00-05-005<br>BOSTON PROP<br>ALMADEN BLVD/WOZ WAY (NW/C)    | 0   | 2   | 0   | 0   | 26  | 0   | 0   | 0   | 0   | 0   | 0   | 0   |
| RH98-04-001<br>OPUS WEST<br>SANTA CLARA/ALMADEN              | 0   | 0   | 0   | 0   | 4   | 0   | 0   | 0   | 0   | 0   | 0   | 0   |

TOTAL: 0 476 2 59 181 0 0 0 0 7 0 398

LEFT THRU RIGHT

NORTH 59 181 0  
 EAST 7 0 398  
 SOUTH 0 476 2  
 WEST 0 0 0

**PM APPROVED TRIPS**

09/22/2015

*Intersection of: 880/COLEMAN (S)*

Page No: 2

Traffic Node Number: 3053

| Permit No. / Description / Location                          | M09<br>NBL | M08<br>NBT | M07<br>NBR | M03<br>SBL | M02<br>SBT | M01<br>SBR | M12<br>EBL | M11<br>EBT | M10<br>EBR | M06<br>WBL | M05<br>WBT | M04<br>WBR |
|--|------------|------------|------------|------------|------------|------------|------------|------------|------------|------------|------------|------------|
| AIRPORT<br>EXPANSION OF AIRPORT<br>SAN JOSE INTL AIRPORT     | 0          | 3          | 0          | 5          | 4          | 0          | 0          | 0          | 0          | 0          | 0          | 16         |
| CIM-BLOCK3<br>BLOCK 3<br>DOWNTOWN                            | 0          | 22         | 4          | 0          | 20         | 0          | 0          | 0          | 0          | 2          | 0          | 0          |
| CIM-FOUNTAIN<br>FOUNTAIN ALLEY<br>DOWNTOWN                   | 0          | 7          | 1          | 0          | 6          | 0          | 0          | 0          | 0          | 1          | 0          | 0          |
| DOWNTOWN<br>DOWNTOWN STRATEGY PLAN 2000<br>DOWNTOWN CORE     | 0          | 36         | 0          | 20         | 91         | 0          | 0          | 0          | 0          | 4          | 0          | 22         |
| NSJ<br>NORTH SAN JOSE  | 0          | 5          | 1          | 2          | 12         | 0          | 0          | 0          | 0          | 0          | 0          | 4          |
| PDC84-07-059<br>RIVER PARK II<br>PARK & WOZ (SE/C)           | 0          | 0          | 0          | 0          | 0          | 0          | 0          | 0          | 0          | 0          | 0          | 0          |
| PDC98-12-104HOT<br>FMC<br>W/S COLEMAN BET NEWHALL AND BROKAW | 0          | 54         | 0          | 8          | 43         | 0          | 0          | 0          | 0          | 0          | 0          | 12         |
| PDC98-12-104OFF<br>FMC<br>W/S COLEMAN BET NEWHALL AND BROKAW | 0          | 54         | 0          | 242        | 348        | 0          | 0          | 0          | 0          | 0          | 0          | 54         |
| PDC98-12-104RET<br>FMC<br>W/S COLEMAN BET NEWHALL AND BROKAW | 0          | 84         | 0          | 15         | 57         | 0          | 0          | 0          | 0          | 0          | 0          | 44         |

**PM APPROVED TRIPS**

09/22/2015

*Intersection of: 880/COLEMAN (S)*

Page No: 3

Traffic Node Number: 3053

| Permit No. / Description / Location                       | M09 | M08 | M07 | M03 | M02 | M01 | M12 | M11 | M10 | M06 | M05 | M04 |
|---|-----|-----|-----|-----|-----|-----|-----|-----|-----|-----|-----|-----|
|   | NBL | NBT | NBR | SBL | SBT | SBR | EBL | EBT | EBR | WBL | WBT | WBR |
| PP10-155<br>COLEMAN SOCCER COMPLEX<br>TERMINUS            | 0   | 0   | 0   | 0   | 0   | 0   | 0   | 0   | 0   | 0   | 0   | 0   |
| RH00-05-005<br>BOSTON PROP<br>ALMADEN BLVD/WOZ WAY (NW/C) | 0   | 23  | 0   | 0   | 3   | 0   | 0   | 0   | 0   | 0   | 0   | 0   |
| RH98-04-001<br>OPUS WEST<br>SANTA CLARA/ALMADEN           | 0   | 3   | 0   | 0   | 0   | 0   | 0   | 0   | 0   | 0   | 0   | 0   |

**TOTAL: 0 291 6 292 584 0 0 0 0 7 0 152**

|       | LEFT | THRU | RIGHT |
|-------|------|------|-------|
| NORTH | 292  | 584  | 0     |
| EAST  | 7    | 0    | 152   |
| SOUTH | 0    | 291  | 6     |
| WEST  | 0    | 0    | 0     |

**AM APPROVED TRIPS**

09/22/2015

*Intersection of: ALAMEDA/HEDDING*

Page No: 1

Traffic Node Number: 3057

| Permit No. / Description / Location                                    | M09 | M08 | M07 | M03 | M02 | M01 | M12 | M11 | M10 | M06 | M05 | M04 |
|--|-----|-----|-----|-----|-----|-----|-----|-----|-----|-----|-----|-----|
|  | NBL | NBT | NBR | SBL | SBT | SBR | EBL | EBT | EBR | WBL | WBT | WBR |
| DOWNTOWN<br>DOWNTOWN STRATEGY PLAN 2000<br>DOWNTOWN CORE               | 0   | 0   | 0   | 0   | 0   | 0   | 0   | 0   | 0   | 0   | 0   | 0   |
| -----  |     |     |     |     |     |     |     |     |     |     |     |     |
| NSJ<br>NORTH SAN JOSE  | 0   | 0   | 0   | 1   | 5   | 0   | 10  | 23  | 7   | 0   | 1   | 1   |
| -----  |     |     |     |     |     |     |     |     |     |     |     |     |
| PDC02-046<br>SJ WATER CO.<br>DELMAS & SAN FERNANDO                     | 4   | 12  | 0   | 0   | 25  | 0   | 0   | 0   | 11  | 0   | 0   | 0   |
| -----  |     |     |     |     |     |     |     |     |     |     |     |     |
| PDC07-072<br>BELLARMINE COLLEGE PREPARATORY SCHOOL<br>960 W HEDDING ST | 0   | 0   | 13  | 22  | 0   | 0   | 0   | 9   | 0   | 8   | 6   | 14  |
| -----  |     |     |     |     |     |     |     |     |     |     |     |     |
| PDC84-07-059<br>RIVER PARK II<br>PARK & WOZ (SE/C)                     | 0   | 0   | 0   | 0   | 0   | 0   | 0   | 0   | 0   | 0   | 0   | 0   |
| -----  |     |     |     |     |     |     |     |     |     |     |     |     |
| PDC98-12-104OFF<br>FMC<br>W/S COLEMAN BET NEWHALL AND BROKAW           | 0   | 0   | 0   | 0   | 0   | 0   | 0   | 30  | 0   | 0   | 6   | 0   |
| -----  |     |     |     |     |     |     |     |     |     |     |     |     |
| RH00-05-005<br>BOSTON PROP<br>ALMADEN BLVD/WOZ WAY (NW/C)              | 0   | 1   | 0   | 0   | 17  | 0   | 0   | 0   | 0   | 0   | 0   | 0   |
| -----  |     |     |     |     |     |     |     |     |     |     |     |     |
| RH98-04-001<br>OPUS WEST<br>SANTA CLARA/ALMADEN                        | 0   | 0   | 0   | 0   | 2   | 0   | 0   | 0   | 0   | 0   | 0   | 0   |

**TOTAL: 4 13 13 23 49 0 10 62 18 8 13 15**

|       | LEFT | THRU | RIGHT |
|-------|------|------|-------|
| NORTH | 23   | 49   | 0     |
| EAST  | 8    | 13   | 15    |
| SOUTH | 4    | 13   | 13    |
| WEST  | 10   | 62   | 18    |



**PM APPROVED TRIPS**

09/22/2015

*Intersection of: ALAMEDA/HEDDING*

Page No: 2

Traffic Node Number: 3057

| Permit No. / Description / Location                                    | M09 | M08 | M07 | M03 | M02 | M01 | M12 | M11 | M10 | M06 | M05 | M04 |
|--|-----|-----|-----|-----|-----|-----|-----|-----|-----|-----|-----|-----|
|  | NBL | NBT | NBR | SBL | SBT | SBR | EBL | EBT | EBR | WBL | WBT | WBR |
| DOWNTOWN<br>DOWNTOWN STRATEGY PLAN 2000<br>DOWNTOWN CORE               | 3   | 32  | 1   | 2   | 37  | 5   | 3   | 6   | 2   | 4   | 11  | 5   |
| -----  |     |     |     |     |     |     |     |     |     |     |     |     |
| NSJ<br>NORTH SAN JOSE  | 0   | 0   | 0   | 0   | 7   | 0   | 4   | 8   | 2   | 4   | 12  | 6   |
| -----  |     |     |     |     |     |     |     |     |     |     |     |     |
| PDC02-046<br>SJ WATER CO.<br>DELMAS & SAN FERNANDO                     | 11  | 25  | 0   | 0   | 14  | 0   | 0   | 0   | 5   | 0   | 0   | 0   |
| -----  |     |     |     |     |     |     |     |     |     |     |     |     |
| PDC07-072<br>BELLARMINE COLLEGE PREPARATORY SCHOOL<br>960 W HEDDING ST | 0   | 0   | 2   | 4   | 0   | 0   | 0   | 1   | 0   | 3   | 2   | 4   |
| -----  |     |     |     |     |     |     |     |     |     |     |     |     |
| PDC84-07-059<br>RIVER PARK II<br>PARK & WOZ (SE/C)                     | 0   | 0   | 0   | 0   | 0   | 0   | 0   | 0   | 0   | 0   | 0   | 0   |
| -----  |     |     |     |     |     |     |     |     |     |     |     |     |
| PDC98-12-104OFF<br>FMC<br>W/S COLEMAN BET NEWHALL AND BROKAW           | 0   | 0   | 0   | 0   | 0   | 0   | 0   | 4   | 0   | 0   | 30  | 0   |
| -----  |     |     |     |     |     |     |     |     |     |     |     |     |
| RH00-05-005<br>BOSTON PROP<br>ALMADEN BLVD/WOZ WAY (NW/C)              | 0   | 16  | 0   | 0   | 2   | 0   | 0   | 0   | 0   | 0   | 0   | 0   |
| -----  |     |     |     |     |     |     |     |     |     |     |     |     |
| RH98-04-001<br>OPUS WEST<br>SANTA CLARA/ALMADEN                        | 0   | 2   | 0   | 0   | 0   | 0   | 0   | 0   | 0   | 0   | 0   | 0   |

**TOTAL: 14 75 3 6 60 5 7 19 9 11 55 15**

|       | LEFT | THRU | RIGHT |
|-------|------|------|-------|
| NORTH | 6    | 60   | 5     |
| EAST  | 11   | 55   | 15    |
| SOUTH | 14   | 75   | 3     |
| WEST  | 7    | 19   | 9     |

**AM APPROVED TRIPS**

09/22/2015

*Intersection of: ALAMEDA/NEWHALL*

Page No: 1

Traffic Node Number: 3229

| Permit No. / Description / Location | M09<br>NBL | M08<br>NBT | M07<br>NBR | M03<br>SBL | M02<br>SBT | M01<br>SBR | M12<br>EBL | M11<br>EBT | M10<br>EBR | M06<br>WBL | M05<br>WBT | M04<br>WBR |
|-------------------------------------|------------|------------|------------|------------|------------|------------|------------|------------|------------|------------|------------|------------|
| NSJ<br>NORTH SAN JOSE               | 0          | 1          | 0          | 0          | 0          | 0          | 3          | 1          | 2          | 0          | 0          | 0          |

**TOTAL:**      0      1      0      0      0      0      3      1      2      0      0      0

|       | LEFT | THRU | RIGHT |
|-------|------|------|-------|
| NORTH | 0    | 0    | 0     |
| EAST  | 0    | 0    | 0     |
| SOUTH | 0    | 1    | 0     |
| WEST  | 3    | 1    | 2     |

**PM APPROVED TRIPS**

09/22/2015

*Intersection of: ALAMEDA/NEWHALL*

Page No: 2

Traffic Node Number: 3229

| Permit No. / Description / Location | M09<br>NBL | M08<br>NBT | M07<br>NBR | M03<br>SBL | M02<br>SBT | M01<br>SBR | M12<br>EBL | M11<br>EBT | M10<br>EBR | M06<br>WBL | M05<br>WBT | M04<br>WBR |
|-------------------------------------|------------|------------|------------|------------|------------|------------|------------|------------|------------|------------|------------|------------|
| NSJ<br>NORTH SAN JOSE               | 0          | 7          | 0          | 0          | 0          | 0          | 0          | 0          | 1          | 0          | 0          | 0          |

|               |          |          |          |          |          |          |          |          |          |          |          |          |
|---------------|----------|----------|----------|----------|----------|----------|----------|----------|----------|----------|----------|----------|
| <b>TOTAL:</b> | <b>0</b> | <b>7</b> | <b>0</b> | <b>0</b> | <b>0</b> | <b>0</b> | <b>0</b> | <b>0</b> | <b>1</b> | <b>0</b> | <b>0</b> | <b>0</b> |
|---------------|----------|----------|----------|----------|----------|----------|----------|----------|----------|----------|----------|----------|

|       | LEFT | THRU | RIGHT |
|-------|------|------|-------|
| NORTH | 0    | 0    | 0     |
| EAST  | 0    | 0    | 0     |
| SOUTH | 0    | 7    | 0     |
| WEST  | 0    | 0    | 1     |

**AM APPROVED TRIPS**

09/22/2015

*Intersection of: COLEMAN/FMC DRWY*

Page No: 1

Traffic Node Number: 3411

| Permit No. / Description / Location                          | M09<br>NBL | M08<br>NBT | M07<br>NBR | M03<br>SBL | M02<br>SBT | M01<br>SBR | M12<br>EBL | M11<br>EBT | M10<br>EBR | M06<br>WBL | M05<br>WBT | M04<br>WBR |
|--|------------|------------|------------|------------|------------|------------|------------|------------|------------|------------|------------|------------|
| NSJ<br>NORTH SAN JOSE  | 0          | 38         | 6          | 2          | 48         | 0          | 5          | 0          | 4          | 0          | 0          | 0          |
| -----  |            |            |            |            |            |            |            |            |            |            |            |            |
| PDC98-12-104HOT<br>FMC<br>W/S COLEMAN BET NEWHALL AND BROKAW | 44         | 12         | 0          | 0          | 19         | 19         | 13         | 0          | 30         | 0          | 0          | 0          |
| -----  |            |            |            |            |            |            |            |            |            |            |            |            |
| PDC98-12-104OFF<br>FMC<br>W/S COLEMAN BET NEWHALL AND BROKAW | 301        | 53         | 0          | 0          | 271        | 224        | 44         | 0          | 59         | 0          | 0          | 0          |
| -----  |            |            |            |            |            |            |            |            |            |            |            |            |
| PDC98-12-104RET<br>FMC<br>W/S COLEMAN BET NEWHALL AND BROKAW | 0          | 0          | 0          | 0          | 0          | 3          | 0          | 4          | 0          | 0          | 0          | 0          |
| -----  |            |            |            |            |            |            |            |            |            |            |            |            |
| <b>TOTAL:</b>  | <b>345</b> | <b>103</b> | <b>6</b>   | <b>2</b>   | <b>338</b> | <b>246</b> | <b>62</b>  | <b>4</b>   | <b>93</b>  | <b>0</b>   | <b>0</b>   | <b>0</b>   |

|       | LEFT | THRU | RIGHT |
|-------|------|------|-------|
| NORTH | 2    | 338  | 246   |
| EAST  | 0    | 0    | 0     |
| SOUTH | 345  | 103  | 6     |
| WEST  | 62   | 4    | 93    |

**PM APPROVED TRIPS**

09/22/2015

*Intersection of: COLEMAN/FMC DRWY*

Page No: 2

Traffic Node Number: 3411

| Permit No. / Description / Location                                   | M09 | M08 | M07 | M03 | M02 | M01 | M12 | M11 | M10 | M06 | M05 | M04 |
|---|-----|-----|-----|-----|-----|-----|-----|-----|-----|-----|-----|-----|
|   | NBL | NBT | NBR | SBL | SBT | SBR | EBL | EBT | EBR | WBL | WBT | WBR |
| NSJ<br>NORTH SAN JOSE   | 0   | 51  | 1   | 0   | 46  | 0   | 3   | 0   | 1   | 0   | 0   | 0   |
| -----<br>PDC98-12-104HOT<br>FMC<br>W/S COLEMAN BET NEWHALL AND BROKAW | 46  | 113 | 0   | 0   | 20  | 20  | 13  | 0   | 30  | 0   | 0   | 0   |
| -----<br>PDC98-12-104OFF<br>FMC<br>W/S COLEMAN BET NEWHALL AND BROKAW | 47  | 272 | 0   | 0   | 42  | 35  | 227 | 0   | 303 | 0   | 0   | 0   |
| -----<br>PDC98-12-104RET<br>FMC<br>W/S COLEMAN BET NEWHALL AND BROKAW | 0   | 0   | 0   | 0   | 18  | 12  | 0   | 12  | 0   | 0   | 0   | 0   |
| -----<br>PP10-155<br>COLEMAN SOCCER COMPLEX<br>TERMINUS               | 0   | 21  | 0   | 8   | 22  | 0   | 0   | 0   | 0   | 0   | 0   | 8   |

**TOTAL: 93 457 1 8 148 67 243 12 334 0 0 8**

LEFT THRU RIGHT

|       |     |     |     |
|-------|-----|-----|-----|
| NORTH | 8   | 148 | 67  |
| EAST  | 0   | 0   | 8   |
| SOUTH | 93  | 457 | 1   |
| WEST  | 243 | 12  | 334 |

**AM APPROVED TRIPS**

09/22/2015

Intersection of: COLEMAN/HEDDING

Page No: 1

Traffic Node Number: 3413

| Permit No. / Description / Location                                    | M09 | M08 | M07 | M03 | M02 | M01 | M12 | M11 | M10 | M06 | M05 | M04 |
|--|-----|-----|-----|-----|-----|-----|-----|-----|-----|-----|-----|-----|
|  | NBL | NBT | NBR | SBL | SBT | SBR | EBL | EBT | EBR | WBL | WBT | WBR |
| AIRPORT<br>EXPANSION OF AIRPORT<br>SAN JOSE INTL AIRPORT               | 0   | 2   | 0   | 0   | 1   | 0   | 0   | 0   | 0   | 0   | 0   | 1   |
| CIM-BLOCK3<br>BLOCK 3<br>DOWNTOWN                                      | 0   | 16  | 0   | 0   | 9   | 0   | 0   | 0   | 0   | 0   | 0   | 0   |
| CIM-FOUNTAIN<br>FOUNTAIN ALLEY<br>DOWNTOWN                             | 0   | 6   | 0   | 0   | 3   | 0   | 0   | 0   | 0   | 0   | 0   | 0   |
| DOWNTOWN<br>DOWNTOWN STRATEGY PLAN 2000<br>DOWNTOWN CORE               | 0   | 6   | 0   | 0   | 2   | 0   | 2   | 3   | 0   | 0   | 1   | 1   |
| NSJ<br>NORTH SAN JOSE  | 0   | 13  | 0   | 1   | 6   | 1   | 21  | 33  | 4   | 0   | 1   | 1   |
| PDC07-072<br>BELLARMINE COLLEGE PREPARATORY SCHOOL<br>960 W HEDDING ST | 39  | 0   | 0   | 0   | 0   | 0   | 0   | 2   | 25  | 0   | 4   | 0   |
| PDC84-07-059<br>RIVER PARK II<br>PARK & WOZ (SE/C)                     | 0   | 0   | 0   | 0   | 0   | 0   | 0   | 0   | 0   | 0   | 0   | 0   |
| PDC98-12-104HOT<br>FMC<br>W/S COLEMAN BET NEWHALL AND BROKAW           | 0   | 2   | 0   | 8   | 8   | 6   | 0   | 0   | 0   | 0   | 0   | 0   |
| PDC98-12-104OFF<br>FMC<br>W/S COLEMAN BET NEWHALL AND BROKAW           | 0   | 271 | 0   | 8   | 53  | 6   | 30  | 0   | 0   | 0   | 0   | 45  |
| PDC98-12-104RET<br>FMC<br>W/S COLEMAN BET NEWHALL AND BROKAW           | 0   | 2   | 0   | 8   | 8   | 6   | 0   | 0   | 0   | 0   | 0   | 0   |
| RH00-05-005<br>BOSTON PROP<br>ALMADEN BLVD/WOZ WAY (NW/C)              | 0   | 1   | 0   | 0   | 25  | 0   | 0   | 0   | 0   | 0   | 0   | 0   |

**AM APPROVED TRIPS**

09/22/2015

*Intersection of: COLEMAN/HEDDING*

Page No: 2

Traffic Node Number: 3413

| Permit No. / Description / Location             | M09<br>NBL | M08<br>NBT | M07<br>NBR | M03<br>SBL | M02<br>SBT | M01<br>SBR | M12<br>EBL | M11<br>EBT | M10<br>EBR | M06<br>WBL | M05<br>WBT | M04<br>WBR |
|---|------------|------------|------------|------------|------------|------------|------------|------------|------------|------------|------------|------------|
| RH98-04-001<br>OPUS WEST<br>SANTA CLARA/ALMADEN | 0          | 0          | 0          | 0          | 4          | 0          | 0          | 0          | 0          | 0          | 0          | 0          |
| <b>TOTAL:</b>                                   | <b>39</b>  | <b>319</b> | <b>0</b>   | <b>25</b>  | <b>119</b> | <b>19</b>  | <b>53</b>  | <b>38</b>  | <b>29</b>  | <b>0</b>   | <b>6</b>   | <b>48</b>  |

|       | LEFT | THRU | RIGHT |
|-------|------|------|-------|
| NORTH | 25   | 119  | 19    |
| EAST  | 0    | 6    | 48    |
| SOUTH | 39   | 319  | 0     |
| WEST  | 53   | 38   | 29    |

**PM APPROVED TRIPS**

09/22/2015

*Intersection of: COLEMAN/HEDDING*

Page No: 3

Traffic Node Number: 3413

| Permit No. / Description / Location                                    | M09<br>NBL | M08<br>NBT | M07<br>NBR | M03<br>SBL | M02<br>SBT | M01<br>SBR | M12<br>EBL | M11<br>EBT | M10<br>EBR | M06<br>WBL | M05<br>WBT | M04<br>WBR |
|--|------------|------------|------------|------------|------------|------------|------------|------------|------------|------------|------------|------------|
| AIRPORT<br>EXPANSION OF AIRPORT<br>SAN JOSE INTL AIRPORT               | 0          | 2          | 0          | 1          | 3          | 0          | 0          | 0          | 0          | 0          | 0          | 1          |
| CIM-BLOCK3<br>BLOCK 3<br>DOWNTOWN                                      | 0          | 13         | 0          | 0          | 17         | 0          | 0          | 0          | 0          | 0          | 0          | 0          |
| CIM-FOUNTAIN<br>FOUNTAIN ALLEY<br>DOWNTOWN                             | 0          | 5          | 0          | 0          | 7          | 0          | 0          | 0          | 0          | 0          | 0          | 0          |
| DOWNTOWN<br>DOWNTOWN STRATEGY PLAN 2000<br>DOWNTOWN CORE               | 5          | 38         | 1          | 11         | 102        | 13         | 5          | 14         | 6          | 3          | 30         | 11         |
| NSJ<br>NORTH SAN JOSE  | 0          | 5          | 0          | 1          | 10         | 1          | 3          | 8          | 3          | 2          | 20         | 8          |
| PDC07-072<br>BELLARMINI COLLEGE PREPARATORY SCHOOL<br>960 W HEDDING ST | 5          | 0          | 0          | 0          | 0          | 0          | 0          | 1          | 7          | 0          | 1          | 0          |
| PDC84-07-059<br>RIVER PARK II<br>PARK & WOZ (SE/C)                     | 0          | 0          | 0          | 0          | 0          | 0          | 0          | 0          | 0          | 0          | 0          | 0          |
| PDC98-12-104HOT<br>FMC<br>W/S COLEMAN BET NEWHALL AND BROKAW           | 0          | 37         | 0          | 16         | 24         | 16         | 0          | 0          | 0          | 0          | 0          | 0          |
| PDC98-12-104OFF<br>FMC<br>W/S COLEMAN BET NEWHALL AND BROKAW           | 0          | 42         | 0          | 45         | 272        | 30         | 4          | 0          | 0          | 0          | 0          | 7          |
| PDC98-12-104RET<br>FMC<br>W/S COLEMAN BET NEWHALL AND BROKAW           | 0          | 37         | 0          | 16         | 24         | 16         | 0          | 0          | 0          | 0          | 0          | 0          |
| PP10-155<br>COLEMAN SOCCER COMPLEX<br>TERMINUS                         | 0          | 23         | 0          | 0          | 10         | 0          | 0          | 0          | 0          | 0          | 0          | 0          |



**PM APPROVED TRIPS**

09/22/2015

*Intersection of: COLEMAN/HEDDING*

Page No: 4

Traffic Node Number: 3413

| Permit No. / Description / Location                       | M09       | M08        | M07      | M03       | M02        | M01       | M12       | M11       | M10       | M06      | M05       | M04       |
|---|-----------|------------|----------|-----------|------------|-----------|-----------|-----------|-----------|----------|-----------|-----------|
|   | NBL       | NBT        | NBR      | SBL       | SBT        | SBR       | EBL       | EBT       | EBR       | WBL      | WBT       | WBR       |
| RH00-05-005<br>BOSTON PROP<br>ALMADEN BLVD/WOZ WAY (NW/C) | 0         | 18         | 0        | 0         | 3          | 0         | 0         | 0         | 0         | 0        | 0         | 0         |
| RH98-04-001<br>OPUS WEST<br>SANTA CLARA/ALMADEN           | 0         | 3          | 0        | 0         | 0          | 0         | 0         | 0         | 0         | 0        | 0         | 0         |
| <b>TOTAL:</b>   | <b>10</b> | <b>223</b> | <b>1</b> | <b>90</b> | <b>472</b> | <b>76</b> | <b>12</b> | <b>23</b> | <b>16</b> | <b>5</b> | <b>51</b> | <b>27</b> |

|       | LEFT | THRU | RIGHT |
|-------|------|------|-------|
| NORTH | 90   | 472  | 76    |
| EAST  | 5    | 51   | 27    |
| SOUTH | 10   | 223  | 1     |
| WEST  | 12   | 23   | 16    |

**AM APPROVED TRIPS**

09/22/2015

*Intersection of: COLEMAN/TAYLOR*

Page No: 1

Traffic Node Number: 3417

| Permit No. / Description / Location                          | M09 | M08 | M07 | M03 | M02 | M01 | M12 | M11 | M10 | M06 | M05 | M04 |
|--|-----|-----|-----|-----|-----|-----|-----|-----|-----|-----|-----|-----|
|  | NBL | NBT | NBR | SBL | SBT | SBR | EBL | EBT | EBR | WBL | WBT | WBR |
| AIRPORT<br>EXPANSION OF AIRPORT<br>SAN JOSE INTL AIRPORT     | 0   | 0   | 0   | 0   | 0   | 0   | 0   | 0   | 0   | 0   | 0   | 2   |
| CIM-BLOCK3<br>BLOCK 3<br>DOWNTOWN                            | 0   | 16  | 0   | 0   | 9   | 0   | 0   | 0   | 0   | 0   | 0   | 0   |
| CIM-FOUNTAIN<br>FOUNTAIN ALLEY<br>DOWNTOWN                   | 0   | 6   | 0   | 0   | 3   | 0   | 0   | 0   | 0   | 0   | 0   | 0   |
| DOWNTOWN<br>DOWNTOWN STRATEGY PLAN 2000<br>DOWNTOWN CORE     | 17  | 0   | 11  | 15  | 0   | 19  | 88  | 22  | 74  | 0   | 9   | 105 |
| NSJ<br>NORTH SAN JOSE  | 0   | 1   | 0   | 2   | 5   | 1   | 19  | 43  | 3   | 0   | 8   | 6   |
| PDC00-09-086<br>TAYLOR TOWERS<br>N 1ST ST & TAYLOR ST (NW/C) | 0   | 0   | 0   | 0   | 0   | 0   | 0   | 1   | 0   | 0   | 6   | 0   |
| PDC84-07-059<br>RIVER PARK II<br>PARK & WOZ (SE/C)           | 0   | 0   | 0   | 0   | 0   | 0   | 0   | 0   | 0   | 0   | 0   | 0   |
| PDC98-12-104HOT<br>FMC<br>W/S COLEMAN BET NEWHALL AND BROKAW | 0   | 2   | 0   | 0   | 8   | 0   | 0   | 0   | 0   | 0   | 0   | 0   |
| PDC98-12-104OFF<br>FMC<br>W/S COLEMAN BET NEWHALL AND BROKAW | 0   | 105 | 0   | 76  | 2   | 6   | 30  | 0   | 0   | 0   | 0   | 135 |
| PDC98-12-104RET<br>FMC<br>W/S COLEMAN BET NEWHALL AND BROKAW | 0   | 2   | 0   | 0   | 8   | 0   | 0   | 0   | 0   | 0   | 0   | 0   |
| RH00-05-005<br>BOSTON PROP<br>ALMADEN BLVD/WOZ WAY (NW/C)    | 0   | 0   | 0   | 19  | 6   | 0   | 0   | 0   | 0   | 0   | 0   | 1   |

**AM APPROVED TRIPS**

09/22/2015

*Intersection of: COLEMAN/TAYLOR*

Page No: 2

Traffic Node Number: 3417

| Permit No. / Description / Location             | M09<br>NBL | M08<br>NBT | M07<br>NBR | M03<br>SBL | M02<br>SBT | M01<br>SBR | M12<br>EBL | M11<br>EBT | M10<br>EBR | M06<br>WBL | M05<br>WBT | M04<br>WBR |
|---|------------|------------|------------|------------|------------|------------|------------|------------|------------|------------|------------|------------|
| RH98-04-001<br>OPUS WEST<br>SANTA CLARA/ALMADEN | 0          | 0          | 0          | 0          | 4          | 0          | 0          | 0          | 0          | 0          | 0          | 0          |
| <b>TOTAL:</b>                                   | <b>17</b>  | <b>132</b> | <b>11</b>  | <b>112</b> | <b>45</b>  | <b>26</b>  | <b>137</b> | <b>66</b>  | <b>77</b>  | <b>0</b>   | <b>23</b>  | <b>249</b> |

|       | LEFT | THRU | RIGHT |
|-------|------|------|-------|
| NORTH | 112  | 45   | 26    |
| EAST  | 0    | 23   | 249   |
| SOUTH | 17   | 132  | 11    |
| WEST  | 137  | 66   | 77    |

**PM APPROVED TRIPS**

09/22/2015

*Intersection of: COLEMAN/TAYLOR*

Page No: 3

Traffic Node Number: 3417

| Permit No. / Description / Location                          | M09 | M08 | M07 | M03 | M02 | M01 | M12 | M11 | M10 | M06 | M05 | M04 |
|--|-----|-----|-----|-----|-----|-----|-----|-----|-----|-----|-----|-----|
|  | NBL | NBT | NBR | SBL | SBT | SBR | EBL | EBT | EBR | WBL | WBT | WBR |
| AIRPORT<br>EXPANSION OF AIRPORT<br>SAN JOSE INTL AIRPORT     | 0   | 1   | 0   | 1   | 1   | 0   | 0   | 0   | 0   | 0   | 0   | 2   |
| CIM-BLOCK3<br>BLOCK 3<br>DOWNTOWN                            | 0   | 13  | 0   | 0   | 17  | 0   | 0   | 0   | 0   | 0   | 0   | 0   |
| CIM-FOUNTAIN<br>FOUNTAIN ALLEY<br>DOWNTOWN                   | 0   | 5   | 0   | 0   | 7   | 0   | 0   | 0   | 0   | 0   | 0   | 0   |
| DOWNTOWN<br>DOWNTOWN STRATEGY PLAN 2000<br>DOWNTOWN CORE     | 80  | 9   | 68  | 110 | 0   | 110 | 24  | 36  | 19  | 2   | 51  | 29  |
| NSJ<br>NORTH SAN JOSE  | 1   | 6   | 0   | 1   | 6   | 1   | 8   | 28  | 5   | 1   | 32  | 8   |
| PDC00-09-086<br>TAYLOR TOWERS<br>N 1ST ST & TAYLOR ST (NW/C) | 0   | 0   | 0   | 0   | 0   | 0   | 0   | 6   | 0   | 0   | 2   | 0   |
| PDC84-07-059<br>RIVER PARK II<br>PARK & WOZ (SE/C)           | 0   | 0   | 0   | 0   | 0   | 0   | 0   | 0   | 0   | 0   | 0   | 0   |
| PDC98-12-104HOT<br>FMC<br>W/S COLEMAN BET NEWHALL AND BROKAW | 0   | 37  | 0   | 0   | 24  | 0   | 0   | 0   | 0   | 0   | 0   | 0   |
| PDC98-12-104OFF<br>FMC<br>W/S COLEMAN BET NEWHALL AND BROKAW | 0   | 16  | 0   | 136 | 106 | 30  | 4   | 0   | 0   | 0   | 0   | 21  |
| PDC98-12-104RET<br>FMC<br>W/S COLEMAN BET NEWHALL AND BROKAW | 0   | 37  | 0   | 0   | 24  | 0   | 0   | 0   | 0   | 0   | 0   | 0   |
| RH00-05-005<br>BOSTON PROP<br>ALMADEN BLVD/WOZ WAY (NW/C)    | 0   | 6   | 0   | 2   | 1   | 0   | 0   | 0   | 0   | 0   | 0   | 18  |

**PM APPROVED TRIPS**

09/22/2015

*Intersection of: COLEMAN/TAYLOR*

Page No: 4

Traffic Node Number: 3417

| Permit No. / Description / Location             | M09<br>NBL | M08<br>NBT | M07<br>NBR | M03<br>SBL | M02<br>SBT | M01<br>SBR | M12<br>EBL | M11<br>EBT | M10<br>EBR | M06<br>WBL | M05<br>WBT | M04<br>WBR |
|---|------------|------------|------------|------------|------------|------------|------------|------------|------------|------------|------------|------------|
| RH98-04-001<br>OPUS WEST<br>SANTA CLARA/ALMADEN | 0          | 3          | 0          | 0          | 0          | 0          | 0          | 0          | 0          | 0          | 0          | 0          |

|               |           |            |           |            |            |            |           |           |           |          |           |           |
|---------------|-----------|------------|-----------|------------|------------|------------|-----------|-----------|-----------|----------|-----------|-----------|
| <b>TOTAL:</b> | <b>81</b> | <b>133</b> | <b>68</b> | <b>250</b> | <b>186</b> | <b>141</b> | <b>36</b> | <b>70</b> | <b>24</b> | <b>3</b> | <b>85</b> | <b>78</b> |
|---------------|-----------|------------|-----------|------------|------------|------------|-----------|-----------|-----------|----------|-----------|-----------|

|       | LEFT | THRU | RIGHT |
|-------|------|------|-------|
| NORTH | 250  | 186  | 141   |
| EAST  | 3    | 85   | 78    |
| SOUTH | 81   | 133  | 68    |
| WEST  | 36   | 70   | 24    |



**AM APPROVED TRIPS**

09/22/2015

*Intersection of: 87/TAYLOR*

Page No: 2

Traffic Node Number: 4038

| Permit No. / Description / Location                          | M09 | M08 | M07 | M03 | M02 | M01 | M12 | M11 | M10 | M06 | M05 | M04 |
|--|-----|-----|-----|-----|-----|-----|-----|-----|-----|-----|-----|-----|
|  | NBL | NBT | NBR | SBL | SBT | SBR | EBL | EBT | EBR | WBL | WBT | WBR |
| PDC08-036SEN<br>CANNERY PARK<br>NW CORNER E. 10TH ST.        | 0   | 0   | 2   | 1   | 0   | 0   | 0   | 0   | 0   | 3   | 0   | 1   |
| PDC98-12-104OFF<br>FMC<br>W/S COLEMAN BET NEWHALL AND BROKAW | 90  | 0   | 0   | 0   | 0   | 0   | 0   | 8   | 17  | 0   | 0   | 0   |
| PP14-006 C A S<br>JAPANTOWN CORP YARD<br>696 N 6TH ST        | 0   | 0   | 0   | 0   | 0   | 0   | 0   | 0   | 0   | 0   | 0   | 0   |
| PP14-006 RES<br>JAPANTOWN CORP YARD<br>696 N 6TH ST          | 0   | 0   | 20  | 20  | 0   | 0   | 0   | 3   | 0   | 38  | 5   | 38  |
| PP14-006 RET<br>JAPANTOWN CORP YARD<br>696 N 6TH ST          | 0   | 0   | 0   | 0   | 0   | 0   | 0   | 0   | 0   | 0   | 0   | 0   |

**TOTAL: 91 0 74 38 0 0 0 29 18 101 31 74**

|       | LEFT | THRU | RIGHT |
|-------|------|------|-------|
| NORTH | 38   | 0    | 0     |
| EAST  | 101  | 31   | 74    |
| SOUTH | 91   | 0    | 74    |
| WEST  | 0    | 29   | 18    |





**PM APPROVED TRIPS**

09/22/2015

*Intersection of: 87/TAYLOR*

Page No: 4

Traffic Node Number: 4038

| Permit No. / Description / Location                          | M09 | M08 | M07 | M03 | M02 | M01 | M12 | M11 | M10 | M06 | M05 | M04 |
|--|-----|-----|-----|-----|-----|-----|-----|-----|-----|-----|-----|-----|
|  | NBL | NBT | NBR | SBL | SBT | SBR | EBL | EBT | EBR | WBL | WBT | WBR |
| PDC08-036SEN<br>CANNERY PARK<br>NW CORNER E. 10TH ST.        | 0   | 0   | 3   | 1   | 0   | 0   | 0   | 0   | 0   | 2   | 0   | 1   |
| PDC98-12-104OFF<br>FMC<br>W/S COLEMAN BET NEWHALL AND BROKAW | 14  | 0   | 0   | 0   | 0   | 0   | 0   | 45  | 90  | 0   | 7   | 0   |
| PP14-006 C A S<br>JAPANTOWN CORP YARD<br>696 N 6TH ST        | 0   | 0   | 0   | 0   | 0   | 0   | 0   | 0   | 0   | 0   | 0   | 0   |
| PP14-006 RES<br>JAPANTOWN CORP YARD<br>696 N 6TH ST          | 0   | 0   | 37  | 37  | 0   | 0   | 0   | 5   | 0   | 19  | 2   | 19  |
| PP14-006 RET<br>JAPANTOWN CORP YARD<br>696 N 6TH ST          | 0   | 0   | 0   | 0   | 0   | 0   | 0   | 0   | 0   | 0   | 0   | 0   |

**TOTAL: 15 0 119 69 0 0 0 75 92 69 27 36**

|       | LEFT | THRU | RIGHT |
|-------|------|------|-------|
| NORTH | 69   | 0    | 0     |
| EAST  | 69   | 27   | 36    |
| SOUTH | 15   | 0    | 119   |
| WEST  | 0    | 75   | 92    |

**AM APPROVED TRIPS**

09/22/2015

*Intersection of: COLEMAN/NEWHALL*

Page No: 1

Traffic Node Number: 4047

| Permit No. / Description / Location                          | M09       | M08        | M07      | M03      | M02        | M01       | M12        | M11      | M10        | M06      | M05      | M04      |
|--|-----------|------------|----------|----------|------------|-----------|------------|----------|------------|----------|----------|----------|
|  | NBL       | NBT        | NBR      | SBL      | SBT        | SBR       | EBL        | EBT      | EBR        | WBL      | WBT      | WBR      |
| PDC98-12-104HOT<br>FMC<br>W/S COLEMAN BET NEWHALL AND BROKAW | 0         | 88         | 0        | 0        | 60         | 0         | 0          | 0        | 0          | 0        | 0        | 0        |
| PDC98-12-104OFF<br>FMC<br>W/S COLEMAN BET NEWHALL AND BROKAW | 64        | 47         | 0        | 0        | 101        | 21        | 113        | 0        | 282        | 0        | 0        | 0        |
| PDC98-12-104RET<br>FMC<br>W/S COLEMAN BET NEWHALL AND BROKAW | 10        | 9          | 0        | 0        | 0          | 14        | 0          | 0        | 14         | 0        | 0        | 0        |
| <b>TOTAL:</b>  | <b>74</b> | <b>144</b> | <b>0</b> | <b>0</b> | <b>161</b> | <b>35</b> | <b>113</b> | <b>0</b> | <b>296</b> | <b>0</b> | <b>0</b> | <b>0</b> |
|  |           |            |          | LEFT     | THRU       | RIGHT     |            |          |            |          |          |          |
|  |           |            |          | NORTH    | 0          | 161       | 35         |          |            |          |          |          |
|  |           |            |          | EAST     | 0          | 0         | 0          |          |            |          |          |          |
|  |           |            |          | SOUTH    | 74         | 144       | 0          |          |            |          |          |          |
|  |           |            |          | WEST     | 113        | 0         | 296        |          |            |          |          |          |

**PM APPROVED TRIPS**

09/22/2015

*Intersection of: COLEMAN/NEWHALL*

Page No: 2

Traffic Node Number: 4047

| Permit No. / Description / Location                          | M09 | M08 | M07 | M03 | M02 | M01 | M12 | M11 | M10 | M06 | M05 | M04 |
|--|-----|-----|-----|-----|-----|-----|-----|-----|-----|-----|-----|-----|
|  | NBL | NBT | NBR | SBL | SBT | SBR | EBL | EBT | EBR | WBL | WBT | WBR |
| PDC98-12-104HOT<br>FMC<br>W/S COLEMAN BET NEWHALL AND BROKAW | 0   | 91  | 0   | 0   | 60  | 0   | 0   | 0   | 0   | 0   | 0   | 0   |
| PDC98-12-104OFF<br>FMC<br>W/S COLEMAN BET NEWHALL AND BROKAW | 111 | 111 | 0   | 0   | 387 | 21  | 159 | 0   | 282 | 0   | 0   | 0   |
| PDC98-12-104RET<br>FMC<br>W/S COLEMAN BET NEWHALL AND BROKAW | 64  | 64  | 0   | 0   | 0   | 43  | 0   | 0   | 42  | 0   | 0   | 0   |
| PP10-155<br>COLEMAN SOCCER COMPLEX<br>TERMINUS               | 0   | 45  | 0   | 0   | 20  | 0   | 0   | 0   | 0   | 0   | 0   | 0   |

**TOTAL: 175 311 0 0 467 64 159 0 324 0 0 0**

|       | LEFT | THRU | RIGHT |
|-------|------|------|-------|
| NORTH | 0    | 467  | 64    |
| EAST  | 0    | 0    | 0     |
| SOUTH | 175  | 311  | 0     |
| WEST  | 159  | 0    | 324   |

City of Santa Clara Approved and Pending Projects List for Traffic Impact Analysis

| PLN File No.   | Project Planner                            | Approval Date                                     | Project  | Location and APN   | Description   | Affordable units?                                      | Anticipated year built (for TIA purposes)        | Existing Square footage   | Current Zoning | Current GP                     | Proposed Entitlements (i.e. Rezoning/Variance/CUP/D.A./Map etc.)   | Environmental Review (i.e. EIR, MND) | Proposed Maximum Building Height                           | Proposed Maximum Building Coverage | Status of Project (i.e. ADEIR under review, PC scheduled for _____ etc.)                                     |
|--|--|---|--|--|---|--|--|---|----------------|--------------------------------|--|--------------------------------------|--|------------------------------------|--|
| <b>Approved Projects- Last updated 8-27-15</b>   |  |   |  |  |   |  |  |   |                |                                |  |                                      |  |                                    |  |
| Z.1576   | Debby Fernandez (408) 615-2457             |   | Intel SC-13  | 2250 Mission College Boulevard 104-39-021  | 100,000 sf of office land use   | N/A  | 2-5 years  | Existing industrial use 568,055                                 | PD             |                                | Amend PD Zoning, Mit Neg Dec   | MND                                  | 625'   | 42%                                | Approved   |
| PLN2003-03744 (Rezoned from "A" Agriculture to PD Planned Development for 110 units of SF) PLN2003-03745 (General Plan Amendment) PLN2003-03958 (Rezoning of Senior parcel to PD(R3-18D)) PLN2007-06295 (Tentative Subdivision Map creating 110+ parcels) PLN2007-06327 (Rezoning application from "A" Agriculture to "B" Public park) PLN2007-06329 (Development Agreement) | Gloria Sciarra (408) 615-2453 408-615-2453 | Apr-09  | Former BAREC site/ Summerhill and Charlies Housing | 90 Winchester Boulevard 303-17-047   | 165 apartment units REMAINING TO BE BUILT-- 110 small lot single family homes ALL OCCUPIED; Street improvements DONE/Winchester between Stevens Creek and Forest Ave  | 165  |  |   | PD             |                                | PD rezoning, GP amendment, DA, EIR   | FEIR, RAW, MMRP                      | 3-4 stories for Senior housing 2 1/2 stories for SF and TH |                                    | 80% of single family Constructed /Senior housing yet to be constructed                                       |
| PLN2004-04317  | Yen Chen (408) 615-2455                    | 7/12/2005- extension of DA requested in June 2015 | Hewlett-Packard/Agilent Technologies               | 5301 Stevens Creek at Lawrence 316-17-018  | PD rezone, Development Agreement for redevelopment of existing industrial use to become 727,500 sf of office and research & development; Development agreement to allow extension of time for Agilent Technologies campus (related:CEQ2015-01192) | N/A  | 10 years   | 30,633  | PD             |                                | DA extension- payment of 300K for terms of DA--future campus redevelopment still pending   |                                      |  |                                    |  |
| PLN2007-06310  | Jeff Schwilk (408) 615-2456                | 5/22/2007 (time extension approval date)          | 3 Corn/Cogniac Great America                       | 5402 Great American Parkway at Yerba Buena APN 216-31-075                          | Existing office use redeveloped to 278,000 sf of office/research & development  | N/A  | 2-5 years  | 144,000   | PD             | Light Industrial               | Extension of DA (2007); Previous approvals-GPA #40, Rezone from B to PD; DA  | EIR                                  | 165'   | 47% approx                         | Approved   |
| PLN2007-06433/PLN2010-08487; PLN2013-09743 (renewal of PD)   | Debby Fernandez (408) 615-2457             | 4/21/2009; 9/24/13 Approved 2 year extension      | 2350 Mission College Boulevard Office Retail       | 104-13-097, 098 & 099  | 300,000 sf of office in two buildings and a 6 story parking garage; 6,000 square feet of retail   | N/A  | 1-3 years  | Existing industrial use 235,523                                 | PD             | High Intensity Office/R&D      | Approved Rezone from PD to PD, Tentative Parcel Map & Architectural Review   | Certified EIR                        | 6-stories  | 52% 1.5 FAR                        | Time Extension filed for 2-year extension PC 2/9/11 & CC 3/15/11   |
| PLN2007-06715, CEQ2007-01051   | Debby Fernandez (408) 615-2457             | 4/15/2008   | Sobrato Office Development                         | 4301, 4401 & 4551 Great America Parkway 104-42-009 & 020                           | Rezone from PD & PD[ML] to construct (2) 12-story office buildings totaling 718,000 sq.ft. & (1) four-story parking garage on a developed property w/ (2) 300,000 sq.ft. existing office buildings that are to remain                             | N/A  | 10 years   | (2) 300,000 sq.ft. office buildings                             | PD             | High Intensity Office/R&D      | Rezone from PD[ML] to PD, Development Agreement, Tentative Map & Architectural Review  | EIR                                  | 190'   | N/A                                | Application on hold per applicant request  |
| PLN2007-06802, PLN2008-06920, CEQ2008-01057  | Gloria Sciarra (408) 615-2453 408-615-2453 | 9/18/2009   | Fairfield Development                              | 900 Kiely Boulevard 290-26-022   | 781 housing units, 57 SFD, 68 row houses, 116 townhouses/ 552 apartments (Modification to current PD-MC approval allowing additional 21 apartment units   | 23 units (TO VERIFY) and 5.6M contribution to City AHF |  |   |                |                                | PD-MC rezoning, DA, EIR  |                                      |  |                                    | demolition complete, on-site and internal streets and infrastructure backbone improvement nearly constructed |
| PLN2008-06858 thru 06860   | Yen Chen (408) 615-2455                    | Re-approved July 2013 by CC                       | Augustine Bowers Industrial Campus / Equity Office | 2620-2727 Augustine Drive (includes properties on Bowers Avenue & Scott Boulevard) | 1,969,600 sf of office and up to 35,000 sf of retail  | N/A  | 2-5 years  | 444,752 sq. ft office/5,290 sq. ft restaurant                   | PD             | Office/ Research & Development | General Plan Amendment, Rezone ML to PD, Subdivision Map, Development Agreement  | Certified EIR                        | 244 feet subject to FAA Reg Part 77                        | 45%                                | Approved   |
| PLN2008-07176 thru 07180   | Shaun Lacey                                | Approved Revised Project on 7/16/2013             | NVIDIA   | 2600, 2800 San Tomas Expressway & 2400 Condensa Street                             | 1,200,000 sf of office and high-tech lab buildings replacing approx. 690,000 sf of office space. Revised DA   | N/A  | 2-5 years  | Existing 690,550 sf of office/ industrial use                   | PD             | Office/ Research & Development | Amendment to PD. Prior approval included General Plan Amendment, Rezone ML to PD, Parcel Map or Lot Line Adjustment, Development Agreement | Certified EIR                        | 133'   | 39%                                | Approved   |
| Mission College  | Yen Chen (408) 615-2455                    | 4/21/2009   | Mission College Master Plan                        | Mission College Boulevard & Great America Parkway                                  | 427,000 sq. ft.   | N/A  | 2-5 years  | Demo of 235,000 sq. ft.   |                |                                | Existing college campus  |                                      |  |                                    |  |
| PLN2008-07218, PLN2008-07220, PLN2008-07221, CEQ2008-01068   | Debby Fernandez (408) 615-2457             | 5/11/2010   | Yahoo!   | 5010 Old Ironsides Drive 104-04-064, 065, 111, 112, 113, 142, 143, 150 & 151       | Phased development of a 3,060,000 sq.ft. office/R&D campus consisting of 13 six-story buildings, three commons buildings, surface parking & two levels of below grade parking   | N/A  | 20 years   | 10 low-rise office/industrial buildings totaling 675,150 sq.ft. | PD             | High Intensity Office/R&D      | Approved Rezone from ML to PD, Development Agreement, Vesting Tentative Parcel Map, Architectural Review                                   | Certified EIR                        | 13-stories   | 27% lot coverage 1.5 FAR           | Buildings south of Democracy Way demolished Jan - Feb 2011   |
| PLN2010-08051, CEQ2010-01098   | Payal Bhagat (408) 615-2458                | 5/10/2011   | Marriot Townplace Suites                           | 2875 Lakeside Drive 216-30-056   | Rezone from Commercial Park (CP) to Planned Development (PD) to facilitate the development of a 107 room extended stay hotel with at-grade podium parking   | N/A  | completed and open                               | demolition of an existing 9,843 sq.ft. building                 | CP             | Regional Commercial            | Rezone from CP to PD   | MND                                  | 67' (5 stories)  | 32                                 | Continued from PC March 2, 2011 to March 23, 2011 PC   |
| PLN2011-08759  | Payal Bhagat (408) 615-2458                | 5/22/2012   | Menlo Equities Office Park                         | 3333 Scott Boulevard   | Lot Line Adjustment and Architectural Review to facilitate the development of 735,000 square foot (5 buildings) office space  | N/A  | some phases complete more construction to follow | n/a   | ML             | Low Intensity Office R&D       | Lot Line Adjustment and Architectural Review   | Focus EIR                            | 69'  | 14%                                | Work in progress, environmental work has initiated.  |

City of Santa Clara Approved and Pending Projects List for Traffic Impact Analysis

| PLN File No.                 | Project Planner   | Approval Date  | Project  | Location and APN   | Description  | Affordable units?        | Anticipated year built (for TIA purposes)                                | Existing Square footage   | Current Zoning | Current GP                   | Proposed Entitlements (i.e. Rezoning/Variance/CUP/D.A./Map etc.)  | Environmental Review (i.e. EIR, MND)         | Proposed Maximum Building Height | Proposed Maximum Building Coverage | Status of Project (i.e. ADEIR under review, PC scheduled for _____ etc.)  |
|------------------------------|---|--|--|--|--|--------------------------|--|---|----------------|------------------------------|---|--|----------------------------------|------------------------------------|---|
| PLN2011-08896                | Debby Fernandez (408) 615-2457                                  | Approved by CC on July 17, 2012  | Mellon Bank /Perry Airellaga   | 5403 Stevens Creek   | General Plan Amendment from Low Intensity Office R&D to High Intensity Office R&D. Rezone from CT to PD & Architectural Review to construct (2) 8-story office buildings totalling 375,000 sq.ft. & (1) parking structure w/1281 spaces (2 below & 4 above) & 38 surface parking spaces in conjunction w/ demo of existing one-story commercial building (IHOP Restaurant) | N/A                      | one building completed -   | under construction  | Ct             | Regional Commercial          | GPA, Rezone, AC approval  | TBD  |                                  |                                    |   |
| PLN2012-09341                | Debby Fernandez (408) 615-2457 w/interns Greg Qwan and Steve Le | Staff level approval signed off on 8/21/2012   | Patrick Duran  | 4888 Patrick Henry   | 13,000 square foot addition to existing industrial/office  | N/A                      | 2-3 years  |   |                |                              | Staff level Arch. Approval  |  |                                  |                                    |   |
| PLN2010-08087, CEQ2010-01109 | Payal Bhagat (408) 615-2458                                     | UP approved by PC on 9-26-12 w/AC referral for design  | Calvary Southern Baptist Church  | 3137 Forbes Avenue 293-13-002  | Use Permit Amendment to U.417 to allow Sunday School classrooms and a weekday day care in the existing church facility in conjunction with construction of a new 2-story building, 14,000+ sq.ft. and parking, landscaping improvements  | N/A                      | 1-5 years  | Demolition of the existing 7,000 sq.ft. building  | B              | Very Low Density Residential | Use Permit Amendment to U.417 to allow Sunday School classrooms and a weekday day care in the existing church facility in conjunction with construction of a new 2-story building, 14,000+ sq.ft. and parking, landscaping improvements | MND  | 29'                              |                                    | Work in progress  |
| PLN2011-08955                | Debby Fernandez (408) 615-2457                                  | submitted 12/1/2011- Approved by CC on Sept 25, 2012 recommended approval of revised project/save Larder House and restore in vicinity- relocated w/in SC two other historic homes | Santa Clara University   | 1043 Alviso St. (Project Address) APN: 269-23-076, 038, 039, 040, 041, 042, 061, 044, 045, 046, 047, 034, 071, 066 | Rezone properties from CT & B to PD to construct a 4-story parking garage and 3-story Art & Art History building in conjunction with removal/demo/relocation of (e) structures on the project site (CEQ2011-01129) including historically significant structures.  | N/A                      | Garage completed Art building now under construction                     |   | CC, PD and B   |                              | Rezone to PD  |  |                                  |                                    | PC Rec approval to modified project 8-29-12: Relocate Larder house nearby and save two QA cottages by relocating into City HLC review rec City rec alternative to relocate historic structures onsite |
| PLN2012-09064                | Debby Fernandez (408) 615-2457                                  | Approved by CC on 11/13/2012   | Rezone and Redevelopment of site                                       | 3175 El Camino Real (former Kar town site)   | New four-story 133 unit multi-family apartment building with associated parking, landscaping and site improvements   | None (rental units only) | completed and occupied   | Existing commercial property involving the demolition of all existing on-site structures                                    |                |                              | Rezone from CT to PD & Architectural review   | EIR  |                                  |                                    |   |
| PLN2012-09176                | Payal Bhagat (408) 615-2458                                     | Council approval on 11/2012 (appeal pending on AC issues)  | 6 Single family project (formerly 9 unit townhome condominium project) | 3499 The Alameda 269-16-069  | Rezoning to PD from ML to facilitate development of six single family homes  | None                     | under construction   | vacant site with a slab on it   | ML             | Santa Clara Station Area     | ML to PD rezoning   | Initial Study and MND                        | 27'                              | 2 stories                          | Changes are being made to the product layout and site plan. Environmental work has not begun yet.   |
| PLN2012-09360                | Payal Bhagat (408) 615-2458                                     | Approved by CC on 2-12-13  | James Redfield   | 4306 Filmore Street 104-11-92  | Rezoning single family property to PD to allow lot split and building of second new SFD on smaller lots. Tentative parcel map application  | N/A                      | under construction   |   |                |                              | Rezoning to PD  |  |                                  |                                    | following PCC meeting of 9-11-12, project requires redesign to be compatible with the older homes adjacent  |
| PLN2012-09486                | Debby Fernandez   | 10/24/2012   | SCU Steve Brodie   | 1079 Alviso  | Rezoning of one parcel to allow Larder House relocation  | N/A                      | 2013   | SFD   |                | Low Density Residential      | PD rezone   | Cat Ex                                       | 2 stories                        |                                    | NA  |
| PLN2012-09224                | Debby Fernandez (408) 615-2457                                  | 5/23/2012 Approved by CC on 4-23-13  | Sobrato  | 2200 Lawson Lane   | Amend PD zoning (PLN2007-06379) and Development Agreement (PLN2008-06880) for approved office R&D campus to increase building sq.ft. of allowable office space from 516,000 to 613,800 sq.ft.  | N/A                      | 1-2 years for new permit. Previously approved project under construction | Approved prior PD to 516K square feet   | PD             | High Intensity Office/R&D    | Amendment to PD   | Addendum to EIR SCH#2007042165 CEQ2012-01146 | five stories                     |                                    | PC meeting scheduled for 11/28  |
| PLN2011-08990                | Debby Fernandez (408) 615-2457                                  | Approved by City Council and EIR adoption on March 26, 2013  | Byer Properties  | 2000 El Camino Real  | (Old Mervyn's Plaza @ Scott and El Camino Real) Architectural review of shopping center remodel and build new Target anchor store w/ demo of previous Mervyn's retail building (CEQ2011-01128 Initial Study)   | N/A                      | complete and Target now open as of 10/8/14                               | Gross floor area of 283,917 square feet and result in a net increase of 11,346 square feet (4.2%) over existing conditions. | CC             | Regional Mixed Use           | Architectural Approval and CEQA review/approval   | IS/MND possible TIA                          | 35 feet                          | As allowed by Zoning Code          | EIR still pending; Arch design upgrade for western side of property and buildings approved for facade remodel   |
| PLN2012-09162                | Debby Fernandez (408) 615-2457                                  | 4/12/2012 Approved by City Council 3-26-13   | Office Building  | 3000 Bowers  | New (2) 5-story 150,000 sq.ft. office buildings, (1) 2-story 17,400 sq.ft. amenity building, and 6 story parking structure with a total of 1,200 parking spaces in conjunction with demolition of an existing 100,042 sq.ft. 2-story office building   | N/A                      | under construction   | 102,600   | ML             | High Intensity Office/R&D    | Architectural Review  | TBD  | 75 feet                          |                                    | Under review by staff   |

City of Santa Clara Approved and Pending Projects List for Traffic Impact Analysis

| PLN File No.                          | Project Planner                   | Approval Date  | Project                            | Location and APN  | Description   | Affordable units?          | Anticipated year built (for TIA purposes) | Existing Square footage  | Current Zoning | Current GP             | Proposed Entitlements (i.e. Rezoning/Variance/CUP/D.A./Map etc.) | Environmental Review (i.e. EIR, MND) | Proposed Maximum Building Height | Proposed Maximum Building Coverage | Status of Project (i.e. ADEIR under review, PC scheduled for _____ etc.) |
|---------------------------------------|-----------------------------------|--|------------------------------------|---|---|----------------------------|---|--|----------------|------------------------|--|--------------------------------------|----------------------------------|------------------------------------|--|
| PLN2012-09203                         | Payal Bhagat (408) 615-2458       | APPROVED BY CC ON 4-9-13   | DATA CENTER                        | 2805 and 2807 Mission College Boulevard   | Rezoning (PD Amendment) to allow a free standing data center and office space   | N/A                        | constructed                               |  |                | MEDIUM Density R and D | Rezone   |                                      |                                  |                                    |  |
| PLN2013-09805                         | Payal Bhagat (408) 615-2458       | Submitted 4/26/2013 Approved by CC 8/27/2013   | Silicon Valley Builders            | 2585 ECR  | GPA #76 from Community Mixed Use to High Density Residential. 3,300 sq. ft of retail (CEQ2013-01157)  | 6                          | under construction                        | former Wheels and Deals site - parking lot and temp buildings  | CT             | Community Mixed Use    | GPA, rezone, CEQA  | TBD                                  |                                  |                                    |  |
| PLN2012-09148                         | Shaun Lacey                       | 9/14/2012- CC pending approval with architectural changes; CC approval of revised 4-9-13 | Silicon Valley Builders            | 555 Saratoga Avenue 269-39-101  | 3-story condominium project with 13 units   | 1 plus partial in-lieu fee | 2 years                                   | gas station turned into service station  | CN             | Community Mixed Use    | Rezoning to PD   | MND likely                           | 4 stories                        | approx 70%                         | TBD  |
| PLN2013-09721                         | Yen Chen                          | 3/5/13 PCC 3/19/13   | Brad Krouskup                      | 4800 GAP  | New 171,000 sq. ft. office building and new site improvements and two level parking garage  | N/A                        | 2013-14                                   | 71K  | ML             | Industrial             | Architectural Review   | possible MND                         |                                  |                                    |  |
| PLN2012-09203                         | Payal Bhagat (408) 615-2458       | 5/10/2012 CC approval 4-9-13   | SVP                                | 2805 and 2807 Mission College Boulevard APNs: 104-16-118 and 104-16-119               | data center retrofit in existing office building  | N/A                        | 1 -2 years                                | office building-72,000 sq. ft  |                |                        | Rezoning to PD to allow free-standing data center                |                                      |                                  |                                    |  |
| PLN2013-09744,09752,09753,09754       | Yen Chen (408) 615-2455/Greg Owan | 3/26/2013; Circ of MND Sept 15 2013  | Elaine Breeze/Urban Planning Group | 2635, 2645, 2611, 2621, 2655 El Camino Real (project will be referred to as 2645 ECR) | Application to allow development of a multi-family residential project (183 units) on 5 parcels including former Russels Furniture property and El Real Nursery site  | None (rental units only)   | under construction                        | 2611 ECR- 664 sq ft<br>2621 ECR- no record of building sq ft<br>2635 ECR- 6,480 sq ft<br>2645 ECR- 21,635 sq ft<br>2655 ECR- 10,686 sq ft<br>Total building sq ft = 39,465 sq ft | CT             | Regional Mixed Use     | Rezoning   | MND                                  | 5 stories                        | TBD                                | Pre-Application  |
| PLN2013-09665 (Extreme Networks Site) | Yen Chen (408) 615-2455           | 2/7/2013   | Irvine Co.                         | 3515-3585 Monroe St Corner of Lawrence Exp. And Monroe                                | New project submitted by Irvine Co. 825 housing units and 40,000 square feet of retail  | None (rental units only)   | under construction                        | Existing One and Two-story Industrial Office Buildings   | MP             | Regional Mixed Use     | PD Rezone, D.A., Map, Architectural Review, potential GPA        | EIR                                  |                                  |                                    | Trumark/Extreme Networks /property in escrow to Irvine co. 9-12          |
| PLN2014-10256 et al                   | Yen Chen (408) 615-2455           | 5/7/2014   | Irvine Co.                         | 2620 Augustine Drive  | General Plan Amendment #80 from High Intensity Office/R&D to Community Commercial [Retail Center] and Light Industrial to High Intensity Office/R&D [Office Phase II & III]; Rezone from Planned Development (PD) to Planned Development (PD) [Retail Center], and from Light Industrial (ML) to Commercial Park (CP) [Office Phase II & III] to allow the construction of up to 1,243,300 square feet of office space and up to 125,000 square feet of retail space for a total (inclusive of Office Phase I) of up to 2,000,100 square feet of development; Approval of Development Agreement Amendment No. 2 | N/A                        | under construction                        |  |                |                        | PD Rezone, D.A., Map, Architectural Review, potential GPA        |                                      |                                  |                                    |  |
| PLN2014-10201                         | Payal Bhagat (408) 615-2458       | 2/5/2014   | Applied Materials                  | 3303 Scott Blvd.  | New three-story office building at approximately 78,000 square feet. Design review and initial study required.  | N/A                        |   |  |                |                        |  |                                      |                                  |                                    |  |
| PLN2012-09113                         | Payal Bhagat (408) 615-2458       | 3/11/2012- Revisions needed, Arch design and site planning deficiencies                  | Silicon Sage Builders              | 1460 Monroe Avenue 269-03-067, 068, 142 & 143   | Rezone from CT to PD to construct a 4-story mixed use development with 1,800 sq.ft. of ground floor retail and 18 residential units above; 43 surface parking spaces  | 3                          | under construction                        | 2,500  | CT             | Community Mixed Use    | Rezoning to PD   | MND                                  | 35                               | TBD                                | submitted/CEQA review TBD  |

City of Santa Clara Approved and Pending Projects List for Traffic Impact Analysis

| PLN File No.   | Project Planner                | Approval Date  | Project                      | Location and APN   | Description  | Affordable units?         | Anticipated year built (for TIA purposes)   | Existing Square footage   | Current Zoning | Current GP                              | Proposed Entitlements (i.e. Rezoning/Variance/CUP/D.A./Map etc.)                                  | Environmental Review (i.e. EIR, MND) | Proposed Maximum Building Height | Proposed Maximum Building Coverage | Status of Project (i.e. ADEIR under review, PC scheduled for _____ etc.)                             |
|--|--------------------------------|--|------------------------------|--|--|---------------------------|---|---|----------------|---|---|--------------------------------------|----------------------------------|------------------------------------|--|
| PLN2013-09799  | Debby Fernandez (408) 615-2457 | 5/2/2013- continued from CC meeting of Dec. 2013 due to potential litigation | Prometheus                   | 45 Buckingham and 66 Saratoga  | GPA #76 from Community Mixed Use to High Density Residential & Rezone from CT to PD to construct a four-story 222 unit multi-family residential development with wrap parking structure w/ 375 on-site parking spaces in conjunction w/ demo of (e) commercial building (CEQ2013-01157)  | None                      | site work commenced   |   | CT             | neighborhood mixed use                  | GPA, rezone, EIR  | TBD                                  | 4 stories                        | PER GPA                            | ADEIR UNDER PREP   |
| PLN2012-09096; (CEQ2012-01138 MND)   | Debby Fernandez (408) 615-2457 | 6/1/2013 PC rec approval on Jan 15, 2014                                     | U-Haul and Self Storage      | 2121 Laurelwood APN 104-14-153   | Rescind PD and Rezone from ML to allow U-Haul facility and self storage business   | N/A                       | under construction  | remodel and expansion of an existing 100,000 sq.ft. furniture retail/warehouse building | PD             | Low Intensity Office R&D                | Rezone  | EIR and TIA                          | 8 stories                        | TBD                                | Second admin draft of EIR w/comments due on Oct. 12 by staff   |
| PLN2010-08137  | Jeff Schwik                    | Filed June 2013  | David Tymn for Mozart Dev.   | 3051 Homestead Road APN: 290-24-001  | Application for Rezone from A to PD for the demolition of an existing s.f. residence, and replacement with 8 detached homes  | None                      | under construction  | n/a   | A              | Low Density Residential                 | PD Rezoning, Map, Arch. Review for 8 detached homes   | tbd (Cat Ex?)                        | 2 Stories                        |                                    | Pre-Application  |
| PLN2007-06715, CEQ2007-01051   | Debby Fernandez                | refiled in 2013 and revised and continued in 2014- approved 9-14             | SOBRATO                      | 4301 GAP   | Rezone from PD & PD[ML] to PD to construct two high rise office buildings and one parking structure (CEQ2007-01051)construct up to 718,000 square feet of new office space in up to 1,018,000 square feet of office development; up to two, five-level parking structures with up to 3,360 total parking spaces;   | N/A                       | 1-3 years   |   |                |   |   |                                      |                                  |                                    |  |
| PLN2012-09027  | Gloria Sciarra (408) 615-2453  | Application submitted 6-5-13   | Dennis Chargin               | 865 Pomeroy Ave  | Rezoning application to allow an additional 20-1 bedroom apartment units within an existing apartment complex with 51 current units  | None (rental units only)  | under construction  |   | R3-25D         | Medium Density Residential (19-36 UPGA) | PD rezone   | TBD                                  |                                  |                                    | Meeting with owner and developer on Sept 20th to review final design for submittal of PD application |
| PLN2013-10107  | Payal Bhagat (408) 615-2458    | 11/7/2013  | Tiemo Mehner/coresite        | 3001 Coronado  | Architectural review to amend the previously approved CoreSite Campus master plan with two three story 92147 square foot buildings and other improvements such as bio-swales, parking, and landscaping   | N/A                       | under construction  |   |                |   | AC approval   |                                      |                                  |                                    |  |
| PLN2012-09349  | Payal Bhagat (408) 615-2458    | 8/9/2012   | Tiemo Mehner/                | 2920 Coronado 216-46-020   | New Data Center  | N/A                       | built   |   |                |   | Rezoning from ML to PD/ rezoning application is being processed on behalf of Silicon Valley Power |                                      |                                  |                                    |  |
| PLN2014-10381  | Yen Chen (408) 615-2455        | May-14   | Irvine Co.                   | 2820 Augustine Drive   | 125,000 square foot retail center (adjustment to PD with office campus)  | N/A                       | under construction  |   | PD             |   | Rezoning to PD - readjustment of Office campus  | addendum to EIR                      |                                  |                                    |  |
| PLN2013-10184  | Debby Fernandez (408) 615-2457 | Filed 12/20/2013 Approved May 2014   | BNP Leasing Corp             | 5450 Great America Parkway   | Architectural review for Phase 2 of approved 6-story office building on an existing office/R&D site with 3 office buildings subgrade and surface parking (certified EIR).  | N/A                       | 2015  |   |                |   | AC approval   |                                      |                                  |                                    |  |
| PLN2013-09965  | Shaun Lacey                    | Filed 2013 Approved by CC Dec 2014   | Charles McKeag               | 166 Saratoga Ave   | Submittal for GPA, Rezone and AC to allow 33 unit residential project (phase I) on 1.74 acre site. Total building area 54K sq. ft.   | 3 plus partial in-leu fee | permits submitted   | Single family residence & accessory buildings   | CT??           | Medium Density Residential (19-36 UPGA) | PD rezone   | MND                                  | 3 stories                        | TBD                                | preapplication   |
| PLN2014-10577 (GP) PLN2014-10578(REZONE) PLN2014-10579(VTM) PLN2014-10580 (3rd AM to DA) CEQ2014-01181 (Addendum to EIR) | Yen Chen (408) 615-2455        | 8/14/2014  | Irvine Co. Carlene Matchniff | 2520 Augustine Drive; 3393 and 3333 Octavius Drive APNs 216-45-036, 37, 38, 024, 025 | Santa Clara Square Office Project (Phase II and III- see a. Two additional parcels are proposed to be added to the recently approved SCSQ Project. Addendum to the EIR and Amendment to Development Agreement is part of this proposal. The Office Sites proposed will not exceed the 2009 Project. Office Phase II and III are proposed to consist of 6-8 story office buildings with associated surface and structured parking at a ratio of 3.3/1000. Vesting Tentative Parcel Map proposal combines 6 parcels to create 3 parcels (See Drawings). Street bulb at Augustine Drive and Octavius Drive is proposed to be replaced with standard curb. | N/A                       | individual buildings completed with additional campus structures under construction |   |                |   | PD Rezone, D.A. Amendment, Map, Architectural Review, GPA, VTM                                    | Addendum to previously adopted EIR   |                                  |                                    |  |

City of Santa Clara Approved and Pending Projects List for Traffic Impact Analysis

| PLN File No.           | Project Planner                | Approval Date   | Project                            | Location and APN                            | Description   | Affordable units?          | Anticipated year built (for TIA purposes) | Existing Square footage | Current Zoning | Current GP          | Proposed Entitlements (i.e. Rezoning/Variance/CUP/D.A./Map etc.)   | Environmental Review (i.e. EIR, MND)  | Proposed Maximum Building Height | Proposed Maximum Building Coverage | Status of Project (i.e. ADEIR under review, PC scheduled for _____ etc.)  |
|------------------------|--------------------------------|---|------------------------------------|---|---|----------------------------|---|-------------------------|----------------|---------------------|--|---------------------------------------|----------------------------------|------------------------------------|---|
| PLN2012-09391          | Payal Bhagat (408) 615-2458    | PC recd for approval 10/22/14 CC scheduled for January 2015 | Silicon Valley Builders            | 1313 Franklin Street                        | Multifamily Residential project with 46 units and 16K or retail space and 4 stories   | 4 plus partial in-lieu fee | permits submitted                         |                         |                | TBD                 | Rezoning or AC: depending upon development design and access   | TBD                                   |                                  |                                    | Multiple revision needed to Arch design and utility accommodation 8-22-12/ CC Presentation for concept on 9-25-12. Outreach meeting held on 9-29-12 hv. |
| PLN2013-09881          | Payal Bhagat (408) 615-2458    | 6/18/2013 Approved by AC on 10-1-2014                       | Tiemo Mehner                       | 3001 and 3032 Coronado 216-26-040           | AC and DA for two new data centers along with vacation of a portion of Coronado Drive   | N/A                        | under construction                        | 50,400                  | ML             | Light Industrial    | Architectural Approval   |                                       |                                  |                                    |   |
| PLN2014-10754          | Shaun Lacey                    | 14-Oct  | DH family Partnership              | 750 Walsh                                   | New 57K industrial warehouse building and surface parking and site improvements   | N/A                        | under construction                        |                         |                |                     |  |                                       |                                  |                                    |   |
| PLN2013-10046          | Jeff Schwik                    | Submitted 9/25/2013 Approved 11/19/2014                     | TI and ARC                         | 2930 Corvin Drive                           | Architectural Review to convert an existing industrial building into a data center [2.5MW energy use]   | N/A                        | TBD                                       | 20,000                  | ML             | Light Industrial    | ARC and TI approval. Proposed 2.5 or less MW of power requested- Cat Ex  |                                       |                                  |                                    |   |
| PLN2014-10628          | Yen Chen (408) 615-2455        | Approved 9-24-14  | Oracle                             | 4090 Network Circle and 4100 Network Circle | Construction of one new 3-story building and one new single story building with associated site improvements to an existing office campus.  | N/A                        | under construction                        | 100,000                 | PD             | R and D/PD          | Architectural approval   |                                       |                                  |                                    |   |
| PLN2015-10900          | Steve Le                       | 3/3/2015 Approved 4-8-15                                    | WTCCA                              | 2981 Mead                                   | Indoor Table Tennis Academy   | N/A                        | TI only, done and operating               | 5,000 tenant space      | ML             | Industrial          | Use Permit   |                                       |                                  |                                    |   |
| PLN2013-09688          | Shaun Lacey                    | submitted 2/22/2013 Approved 6-25-14                        | Applied Materials                  | 3303 Scott                                  | 78,000 square foot building with underground parking/Replaced with proposal for service commercial use in existing building (10-1-13)   | N/A                        | under construction                        | 36,340                  | ML             | Light Industrial    | Architertural approval or PD rezoning  |                                       |                                  |                                    |   |
| PLN2014-10770          | Yen Chen (408) 615-2455        | Submitted on 11/1/2014 Approved by PC 2/10/15               | Cogswell College                   | 5302 Betsy Ross Drive                       | Cogswell Polytechnical College - private educational institution  | N/A                        | 2015                                      | 44K (existing)          |                |                     | Use Permit   |                                       |                                  |                                    |   |
| PLN2014-10765          | Jeff Schwik                    | CC approval 4-21-15   | Mehdi Shemirizi                    | 1480 Main Street                            | Rezoning to PD to allow a mixed use project with 12 residential apartments and 1,000 sq ft of retail on a approx. 15,000 square foot lot  | None (rental units only)   | 2015-2016                                 | vacant site             | CC             | Community Mixed Use | Rezoning   | Cat exemp/Infill project              |                                  |                                    |   |
| PLN2013-09730          | Payal Bhagat (408) 615-2458    | 3/12/2013   | Jane Vaughn                        | 3333 Scott Blvd                             | Expansion of previous approval from to allow 581,000 additional sq ft of office buildings for a total of 1.316m sq ft   | N/A                        | under construction                        |                         |                | PD                  | Supplemental EIR to allow the development of 1,316,000 square foot office/rd space. The project was approved to develop 735,000 sq ft. office/rd space spread over five buildings (PLN2011-08759 and CEQ2011-01125). |                                       |                                  |                                    |   |
| PLN2014-10320          | Debby Fernandez (408) 615-2457 | Jul-14  | JOMA Studio architects             | 1701 Lawrence Road                          | Rezoning from PD (R3-18D) to PD to redevelopment of an existing developed parcel with 9 attached sfr (CEQA to be determined)  | None                       | 2015-16                                   | two sflds               |                |                     |  |                                       |                                  |                                    |   |
| PLN File No.2014-10183 | Shaun Lacey                    | Dec-14  | Eli Engleman                       | 990 Wren                                    | Rezoning from R1-6L to PD to construct 5 new detached 2-story single family residences w/attached garage in conjunction with demo of existing sfr (PLN2014-10385 Map & CEQ2014-01177) | None                       | 2015-16                                   |                         |                |                     |  |                                       |                                  |                                    |   |
| PLN2012-09542          | Gloria Sciarra (408) 615-2453  | PC meeting for 12/10/14 (Recc CC approval) CC in February   | Rezoning and Redevelopment of site | 3700 El Camino Real                         | Gateway Santa Clara (formerly Kohls Site) Mixed use development- Redevelopment of entire site 87K retail/commercial and 476 housing units (apartments)                                | None                       | Fall 2015-Spring 2016                     | 100,000 -Kohls store    |                |                     | Rezoning/Subdivision Map/AC approval 475 rental dwelling units and 86,000 square feet of retail space  | EIR                                   |                                  |                                    | EIR not started yet/final design to be submitted with development applications. One community meeting held to date                                      |
| PLN2014-10487          | Payal Bhagat (408) 615-2458    | 6/1/2014 Approved   | SCU Steve Brodie                   | 455 El Camino Real                          | Re-use of existing office building for SCU for graduate studies off-campus instruction/occupation   | N/A                        | 2015-16                                   | 75,000                  |                |                     | UP   | Cat Exemp- Reuse of existing building |                                  |                                    |   |



City of Santa Clara Approved and Pending Projects List for Traffic Impact Analysis

| PLN File No.                                  | Project Planner                | Approval Date   | Project                        | Location and APN  | Description   | Affordable units? | Anticipated year built (for TIA purposes) | Existing Square footage | Current Zoning | Current GP               | Proposed Entitlements (i.e. Rezoning/Variance/CUP/D.A./Map etc.)  | Environmental Review (i.e. EIR, MND) | Proposed Maximum Building Height | Proposed Maximum Building Coverage | Status of Project (i.e. ADEIR under review, PC scheduled for ____ etc.) |
|---|--------------------------------|---|--------------------------------|---|---|-------------------|---|-------------------------|----------------|--------------------------|---|--------------------------------------|----------------------------------|------------------------------------|---|
| 2014-10840                                    | Payal Bhagat (408) 615-2458    | 4/22/2015   | Menlo Equities                 | 3345 Scott Blvd   | Amendment to approved project - Modification to site plan and building height of to be constructed 6-story Building D.  | N/A               | 2015-16                                   |                         |                |                          |   |                                      |                                  |                                    |   |
| PLN2014-10437                                 | Jeff Schwik                    | 6/1/2014 Approved by CC on June 23, 2015  | Michael Fischer                | 820 Civic Center Drive APN 224-29-022                                 | application for a 3 unit Townhome development (retention of one historic home- total of four units)   | N/A               | 2015-16                                   | 15,100 sq. ft lot       | ML             |                          |   |                                      |                                  |                                    |   |
| PLN2015-10898                                 | John Davidson                  | Jan-15  | Westfield Valley Fair          | 2855 Stevens Creek Blvd portion of the existing Westfield Valley Fair | 15K Chase bank bldg. near SCB and Winchester intersection   | N/A               | 2016                                      | 77K                     |                | Regional Commercial      | Use Permit for a new movie theater, and Variance to allowable building height, Shopping Mall, and the new construction of 102,210 square foot of commercial building area | Addendum to EIR?                     |                                  |                                    |   |
| PLN2013-09854                                 | Debby Fernandez (408) 615-2457 | submitted 6/3/2013 Approved 11/13   | James Salata                   | 2680 Scott Blvd./224-10-110   | New 20,000 square foot office building new landscape and parking improvements   | N/A               | 2014                                      |                         | MH             | Low Intensity Office R&D | Architural approval   |                                      |                                  |                                    |   |
| <b>Pending Projects- Last updated 9-27-15</b> |                                |   |                                |   |   |                   |   |                         |                |                          |   |                                      |                                  |                                    |   |
| PLN File No.                                  | Project Planner                | submittal date and status   | Applicant                      | Location and APN  | Description   | Affordable units  | Anticipated year built (for TIA purposes) | Existing Square footage | Current Zoning | Current GP               | Proposed Entitlements (i.e. Rezoning/Variance/CUP/D.A./Map etc.)  | Environmental Review (i.e. EIR, MND) | Proposed Maximum Building Height | Proposed Maximum Building Coverage | Status of Project (i.e. ADEIR under review, PC scheduled for ____ etc.) |
| PLN2015-11031                                 | Payal Bhagat (408) 615-2458    | 2/20/2015   | Scott Menard                   | <b>3305 Kifer</b>   | Development of 48 attached townhomes and stacked flats with 109 parking spaces and open space as part of the Lawrence Station Area Plan 7.5 acre site project. The environmental review for this project will be covered under the LSAP EIR | 10% of units      | 2017/18                                   | 7.5 acres               |                |                          | Rezone  |                                      |                                  |                                    |   |
| PLN2016-11320                                 | Steve Le                       | 8/3/2015  | Jeff Guinta                    | <b>2580 Lafayette</b>   | Adult gymnasium   | N/A               | 2017                                      | 11,000                  | ML             | Light Industrial         | Use Permit  |                                      |                                  |                                    |   |
| PLN2015-11111                                 | Debby Fernandez                | 8/27/2015   | Mehdi Sadri                    | <b>1055 Helen Ave</b>   | Rezone from R1-6L to PD & Architectural Review to construct a 4 unit townhome project w/ private street (Tentative Parcel Map PLN2015-11358)  |                   |   |                         |                |                          |   |                                      |                                  |                                    |   |
| PLN2015-11231                                 | Yen Chen                       | 7/1/2015  | Mehdi Sadri                    | <b>100 N. Winchester</b>  | GPA and PD rezone for market rate senior housing project with 92 units  | None              | 2016/17                                   |                         |                |                          |   |                                      |                                  |                                    |   |
| PLN2015-11263                                 | Yen Chen (408) 615-2455        | 7/1/2015 City Council study session on 8/25/15 - CC did not support residential uses resubmittal not determined | Daniel Diebel for Greystar Inc | <del>3901-3913 Freedom Circle</del>                                   | <del>Per Application for mixed use (residential up to 120 units, office, 200K and supporting retail 10,000) on 13.3 acre</del>  | <del>120</del>    | <del>unknown</del>                        | <del>none</del>         | <del>ML</del>  | <del></del>              | <del>GPA and Rezone will be required.</del>   | <del>EIR</del>                       |                                  |                                    |   |

City of Santa Clara Approved and Pending Projects List for Traffic Impact Analysis

| PLN File No.                                     | Project Planner                | Approval Date     | Project                                     | Location and APN   | Description   | Affordable units?   | Anticipated year built (for TIA purposes) | Existing Square footage  | Current Zoning | Current GP  | Proposed Entitlements (i.e. Rezoning/Variance/CUP/D.A./Map etc.)  | Environmental Review (i.e. EIR, MND) | Proposed Maximum Building Height | Proposed Maximum Building Coverage | Status of Project (i.e. ADEIR under review, PC scheduled for ____ etc.)                                  |
|--|--------------------------------|-------------------|---|--|---|---|---|--|----------------|---|---|--------------------------------------|----------------------------------|------------------------------------|--|
| PLN2015-11247                                    | Debby Fernandez (408) 615-2457 | 7/1/2015          | Sobrato                                     | 3000 Bowers  | Amend Architectural Review approval for construction of (2) 5-story 150,000 sq.ft. office buildings, (1) 2-story 17,400 sq.ft. amenity building with Modification to increase maximum building height to 85 feet, and 6 story parking structure with a total of 1,200 parking spaces in conjunction with demolition of an existing 100,042 sq.ft. 2-story office building to allow construction of (2) 165,000 sq.ft. 5-story office buildings and (1) 5-story parking structure and surface parking totaling 991 parking spaces (amended project does not include an amenity building) | N/A   | 2016-17                                   | 100,000  | ML             |   |   |                                      |                                  |                                    |  |
| PLN2015-11236                                    | Yen Chen                       | 6/1/2015          | Ray Hashimoto /HMH for River of Life Church | 1177 Laurelwood  | New 35K sanctuary structure adjacent to existing building to allow full congregation to attend one service.   | N/A   | 2016                                      |  |                |   |   |                                      |                                  |                                    |  |
| PLN2015-10980                                    | Yen Chen                       | Submitted 2-27-15 | Irvine Company                              | 575 Benton Street multiple parcels   | Mission Towne Center Mission Town Center- 5-story mixed use project consisting ground floor 25,942 sf commercial space and 417 apartments on approximately 6.42 acres   | None  | 2016-2020                                 | varies- SFD, commercial etc  | varies         | Station Area Plan   | General Plan Amendment, Rezoning, parcel map  | EIR                                  |                                  |                                    |  |
| PLN2015-11053                                    | Debby Fernandez                | 4/2/2015          | Lennar Commercial                           | 3607 Kifer Rd  | Use Permit to construct off-site 5-level parking structure at 3697 Tahoe Way and 5-story 199,460 sq.ft. office building at 3607 Kifer Rd as part of an existing off campus in conjunction with a Modification to increase maximum building height of the proposed office building to 87.5 and Architectural Review of the project   |   |   |  |                |   |   |                                      |                                  |                                    |  |
| PLN2015-11361                                    | Yen Chen (408) 615-2455        | 8/27/2015         | Pinn Bros                                   | 1890 El Camino Real APN 269-01-081, 82 Corner of Pierce and ECR  | Rezone from CT to PD; Architectural Review for new four story mixed use development consisting of 60 for sale units, 5,820 sq. ft. of commercial, wrapped parking garage, and amenities.  | 3 to 4  | 2017-18                                   | Small office area with open used car lot   | CT             | Community Mixed Use   | Rezone, ARC review, TSM   | EIR                                  |                                  |                                    |  |
| PLN2015-10937                                    | Payal Bhagat (408) 615-2458    | Feb-15            | Johnathon Fearn/Summerhill Homes            | 3505 Kiefer Road APN 216-34-070  | Development of 996 residential units with 37,000 square foot retail and associated open space, landscaping, parking and other improvements as part of the Lawrence Station Area Plan.   | Up to 50% of units may be for sale product. 10% required. Possible 40-50 affordable units | 2-5 years                                 | TBD site is 3.89 acres   | ML             | Light Industrial  | Rezone, Possible DA, Specific plan approval, ARC review   | EIR                                  |                                  |                                    |  |
| PLN2015-10898                                    | John Davidson                  | Jan-15            | Westfield Valley Fair                       | 2855 Stevens Creek Blvd portion of the existing Westfield Valley Fair                                    | New Movie Theater complex and new retail tenant space   | N/A   | 2016                                      | 77K  |                | Regional Commercial   | Use Permit for a new movie theater, and Variance to allowable building height, Shopping Mall, and the new construction of 102,210 square foot of commercial building area | Addendum to EIR?                     |                                  |                                    |  |
| PLN2015-10899, 10900, 10901, 10902, 10903, 10904 | Yen Chen                       | Jan-15            | Irvine                                      | 3265 Scott Blv (2600 Augustine) APN APNs: 216-45-011 - 022-024 -025 -028; 216-29-053 -112 and 216-46-003 | Santa Clara Square Mixed Use Project - - phased project 100+ acres 2,000 rental housing units 40,000 sf retail added 30 acres parks/open  | None  |   | 3283 Scott Blvd (216-45-011); 2600-2610 Augustine Dr, 3300-3380 Montgomery Dr & 3265 Scott Blvd (216-45-023); 3255 Scott Blvd & 2500 Augustine Dr (216-45-011) |                | 2025-35 Phase III General Plan<br>High Density Residential (37-50 du/ac) Service, Parks, Public | GPA, rezone, subdivision map  |                                      |                                  |                                    |  |
| PLN2015-11152                                    | Jeff Schwik                    | 15-May            | City Ventures                               | 1525 Alivso Street   | Application for 40 unit townhouse project- 3 stories (next to Mission Inn motel)- application following preapplication  | 4   | 2-3 yrs                                   | n/a  | ML             | Community Mixed Use   | Rezone  | MND/TBD                              | 3 Stories                        |                                    | 10/14/2014- PCC done, and CMO office review, redesign project to allow open space and better site design |
| PLN2014-10828                                    | Shaun Lacey                    | 14-Dec            | Summerhill                                  | 2230 El Camino Real  | Pre-Application for the proposed demolition of existing commercial buildings, and the development of 164 apartment units  | None  | 2 years                                   | tbd- demolition of   | CC             | Regional Mixed Use  | Rezone and GPA possible for no commercial   | MND                                  |                                  |                                    |  |

City of Santa Clara Approved and Pending Projects List for Traffic Impact Analysis

| PLN File No.  | Project Planner             | Approval Date | Project                            | Location and APN  | Description  | Affordable units? | Anticipated year built (for TIA purposes) | Existing Square footage  | Current Zoning  | Current GP               | Proposed Entitlements (i.e. Rezoning/Variance/CUP/D.A./Map etc.)  | Environmental Review (i.e. EIR, MND) | Proposed Maximum Building Height                  | Proposed Maximum Building Coverage | Status of Project (i.e. ADEIR under review, PC scheduled for _____ etc.) |
|---------------|-----------------------------|---------------|------------------------------------|---|--|-------------------|---|--|-----------------|--------------------------|---|--------------------------------------|---|------------------------------------|--|
| PLN2014-10744 | Yen Chen                    | 15-Jun        | Santana Atrium Professional Center | 100 N. Winchester   | General Plan Amendment, rezoning and Architectural Review for 92 unit senior apartment home community with onsite clubhouse and recreational amenities. Fees include Initial Study/Negative Declaration and Stormwater Management Plan Review.   | None              | 1-2 years                                 | 3 story building over podium approx. 84,000  | OA              | Regional Mixed Use       | rezoning and GPA  | MND OR EIR                           |   |                                    |  |
| PLN2014-10664 | Yen Chen                    | Sep-14        | Jon Shank                          | 1220 Memorex  | Parcel Map and Arch review for self storage facility   | N/A               | 2016                                      | lot split for this development proposed/vacant                                       | ML              | light industrial         | Parcel Map and Architectural approval   |                                      |   |                                    |  |
| PLN2014-10683 | Payal Bhagat (408) 615-2458 | Sep-14        | Sobrato                            | 2250 El Camino Real   | Pre-application for 48 apartments- 3 floors over podium parking (Western Motel site)   | None              | 2017                                      | .98 acre   | PD/Multi family | High Density Residential | Rezoning/ARC approval   |                                      |   |                                    |  |
| PLN2014-10554 | Dobby Fernandez             | Sep-14        | Reland                             | 5155 Stars and Stripes Drive 104-03-036 & 037, 104-03-102, 097-01-039 & 097-01-073; 5120 Stars and Stripes Drive APN: 104-03-036, 038 and 039 | City Place-Related Go project for redevelopment of five parcels that include Santa Clara Golf & Tennis Club, BMX track, Fire Station #10, and former City landfill and two parcels on other side of Stars and Stripes (formerly for Montana Lowe project) directly across from Levi's Stadium. Master Development totals of 9.2M square feet and proposes 5.7M sq ft office; 1.1M sq ft retail; 1,300 mixed density residential units; 700 hotel rooms; 250K restaurant uses; 190K entertainment space | TBD               | Start 2017 phased over 20 years           |  | P               | Public Quasi Public      | EIR, General Plan Amendment, Rezoning to PD or PD-MK, Tentative Map and/or Young Tentative Map, Development Agreement and/or Disposition Development Agreement, Ground Lease, and Architectural Review. |                                      |   |                                    |  |
| PLN2014-10614 | Jeff Schwilk                | Sep-14        | Kurt Anderson                      | 2891 Homestead Rd. APN 290-39-080   | Pre-Application review of the proposed replacement of a single family residence and detached garage with a thirteen-unit two- and three-story townhome development on a podium over at-grade parking   | 1                 | 2015-16                                   |  |                 |                          |   |                                      |   |                                    |  |
| PLN2015-11275 | Payal Bhagat (408) 615-2458 | Jul-15        | Xeres Dupont Fabros                | 555 Reed Street   | 111,000 sq data center (addon) Architectural Review and Mitigated Negative Declaration to allow a new data center building on 2020-2070 and 2100-2160 De La Cruz Boulevard (this   | 69,000            | ML  |  | AC approval     | MND                      | 48'   | 43%                                  | Project resubmitted after 1 year hiatus following |                                    |  |
| PLN2015-      | Jeff Schwilk (408) 615-2456 | Jul-15        | Lour Mariani                       | 2570 El Camino Real APN 290-46-001  | Preliminary application: for 1.5 acre site w/315 dwelling units  | TBD               |   | China China restaurant building site next to SCVWD facility running parallel to Bowe |                 |                          |   |                                      |   |                                    |  |
| PLN2013-09887 | Shaun Lacey                 | 6/20/2013     | Jerry Mangono                      | 2255 The Alameda  | pre-application for rezoning of small parcel to include one living unit and office   | N/A               |   |  | CT              | Community Mixed Use      | Rezoning to PD  | MND                                  | no change   | no change                          | pre-Application/more detail needed                                       |
| PLN2015-11204 | Yen Chen                    | 6/23/2015     | Rashik Patel T2                    | 2950 Lakeside Drive   | New 7 story hotel with 188 rooms   |                   |   |  |                 |                          |   |                                      |   |                                    |  |
| PLN2015-10939 | Parks and Recreation Dept   | Feb-15        | Swim Center at Central Park        | 909 Kiely Boulevard   | International Swim Center (ISC) PRELIMINARY proposal at Central Park<br>CIP project #3172: project includes the following components: ISC, Community Recreation Center, Swimming Hall of Fame  | N/A               | 4-10 years                                | TBD  |                 |                          | Existing swim center with bleachers and accessory   |                                      |   |                                    |  |

## **Appendix D**

### **Volume Summary Tables**

Intersection Number: **1**  
 Trafix Node Number: 3612  
 Intersection Name: 21st St & E. Julian St  
 Peak Hour: AM  
 Count Date: 10/09/14  
 Scenario: BART Extension Phase II  
 Date of Analysis: 09/02/15

| Scenario:                     | Movements      |    |     |               |     |    |                |    |    |               |     |    | Total |
|-------------------------------|----------------|----|-----|---------------|-----|----|----------------|----|----|---------------|-----|----|-------|
|                               | North Approach |    |     | East Approach |     |    | South Approach |    |    | West Approach |     |    |       |
|                               | RT             | TH | LT  | RT            | TH  | LT | RT             | TH | LT | RT            | TH  | LT |       |
| Existing Conditions           | 25             | 0  | 287 | 414           | 802 | 0  | 0              | 0  | 0  | 0             | 409 | 2  | 1939  |
| <b>Approved Project Trips</b> |                |    |     |               |     |    |                |    |    |               |     |    |       |
| San Jose ATI                  | 0              | 0  | 0   | 1             | 7   | 0  | 0              | 0  | 0  | 0             | 0   | 0  | 8     |
| Santa Clara ATI               | 0              | 0  | 0   | 0             | 0   | 0  | 0              | 0  | 0  | 0             | 0   | 0  | 0     |
| Total Approved Trips          | 0              | 0  | 0   | 1             | 7   | 0  | 0              | 0  | 0  | 0             | 0   | 0  | 8     |
| Background Conditions         | 25             | 0  | 287 | 415           | 809 | 0  | 0              | 0  | 0  | 0             | 409 | 2  | 1947  |
| <b>2015 Project Trips</b>     |                |    |     |               |     |    |                |    |    |               |     |    |       |
| BART                          | 0              | 0  | 1   | -1            | -20 | 0  | 0              | 0  | 0  | 0             | 20  | -1 | -1    |
| Joint Development             | 0              | 0  | 10  | 7             | 14  | 0  | 0              | 0  | 0  | 0             | 48  | 0  | 79    |
| Net 2015 Trips                | 0              | 0  | 11  | 6             | -6  | 0  | 0              | 0  | 0  | 0             | 68  | -1 | 78    |
| Existing + Project            | 25             | 0  | 298 | 420           | 796 | 0  | 0              | 0  | 0  | 0             | 477 | 1  | 2017  |
| <b>2025 Project Trips</b>     |                |    |     |               |     |    |                |    |    |               |     |    |       |
| BART                          | 0              | 0  | 2   | -3            | -31 | 0  | 0              | 0  | 0  | 0             | 54  | -1 | 21    |
| Joint Development             | 0              | 0  | 15  | 4             | 20  | 0  | 0              | 0  | 0  | 0             | 44  | 0  | 83    |
| Net 2025 Trips                | 0              | 0  | 17  | 1             | -11 | 0  | 0              | 0  | 0  | 0             | 98  | -1 | 104   |
| Background + Project          | 25             | 0  | 304 | 416           | 798 | 0  | 0              | 0  | 0  | 0             | 507 | 1  | 2051  |
| Cumulative No Project         | 25             | 0  | 287 | 415           | 834 | 0  | 0              | 0  | 0  | 0             | 428 | 4  | 1989  |
| <b>2035 Project Trips</b>     |                |    |     |               |     |    |                |    |    |               |     |    |       |
| BART                          | -1             | 0  | 4   | -3            | -32 | 0  | 0              | 0  | 0  | 0             | 74  | -1 | 41    |
| Joint Development             | 0              | 0  | 2   | 4             | 12  | 0  | 0              | 0  | 0  | 0             | 22  | 0  | 40    |
| Net 2035 Trips                | -1             | 0  | 6   | 1             | -20 | 0  | 0              | 0  | 0  | 0             | 96  | -1 | 81    |
| Cumulative                    | 24             | 0  | 293 | 416           | 814 | 0  | 0              | 0  | 0  | 0             | 524 | 3  | 2074  |

Intersection Number: **2**  
 Trafix Node Number: 3613  
 Intersection Name: 24th St & E. Julian St  
 Peak Hour: AM  
 Count Date: 10/09/14  
 Scenario: BART Extension Phase II  
 Date of Analysis: 09/02/15

| Scenario:                     | Movements      |    |    |               |      |     |                |    |     |               |     |    | Total |
|-------------------------------|----------------|----|----|---------------|------|-----|----------------|----|-----|---------------|-----|----|-------|
|                               | North Approach |    |    | East Approach |      |     | South Approach |    |     | West Approach |     |    |       |
|                               | RT             | TH | LT | RT            | TH   | LT  | RT             | TH | LT  | RT            | TH  | LT |       |
| Existing Conditions           | 0              | 0  | 0  | 0             | 1042 | 121 | 134            | 0  | 242 | 166           | 495 | 0  | 2200  |
| <b>Approved Project Trips</b> |                |    |    |               |      |     |                |    |     |               |     |    |       |
| San Jose ATI                  | 0              | 0  | 0  | 0             | 2    | 3   | 5              | 0  | 5   | 0             | 0   | 0  | 15    |
| Santa Clara ATI               | 0              | 0  | 0  | 0             | 0    | 0   | 0              | 0  | 0   | 0             | 0   | 0  | 0     |
| Total Approved Trips          | 0              | 0  | 0  | 0             | 2    | 3   | 5              | 0  | 5   | 0             | 0   | 0  | 15    |
| Background Conditions         | 0              | 0  | 0  | 0             | 1044 | 124 | 139            | 0  | 247 | 166           | 495 | 0  | 2215  |
| <b>2015 Project Trips</b>     |                |    |    |               |      |     |                |    |     |               |     |    |       |
| BART                          | 0              | 0  | 0  | 0             | -19  | -17 | -3             | 0  | -2  | 0             | 20  | 0  | -21   |
| Joint Development             | 0              | 0  | 0  | 0             | 18   | 9   | 5              | 0  | 2   | 0             | 58  | 0  | 92    |
| Net 2015 Trips                | 0              | 0  | 0  | 0             | -1   | -8  | 2              | 0  | 0   | 0             | 78  | 0  | 71    |
| Existing + Project            | 0              | 0  | 0  | 0             | 1041 | 113 | 136            | 0  | 242 | 166           | 573 | 0  | 2271  |
| <b>2025 Project Trips</b>     |                |    |    |               |      |     |                |    |     |               |     |    |       |
| BART                          | 0              | 0  | 0  | 0             | -28  | -25 | -10            | 0  | -4  | 0             | 55  | 0  | -12   |
| Joint Development             | 0              | 0  | 0  | 0             | 21   | 6   | 5              | 0  | 3   | 0             | 59  | 0  | 94    |
| Net 2025 Trips                | 0              | 0  | 0  | 0             | -7   | -19 | -5             | 0  | -1  | 0             | 114 | 0  | 82    |
| Background + Project          | 0              | 0  | 0  | 0             | 1037 | 105 | 134            | 0  | 246 | 166           | 609 | 0  | 2297  |
| Cumulative No Project         | 0              | 0  | 0  | 0             | 1044 | 210 | 139            | 0  | 601 | 198           | 495 | 0  | 2687  |
| <b>2035 Project Trips</b>     |                |    |    |               |      |     |                |    |     |               |     |    |       |
| BART                          | 0              | 0  | 0  | 0             | -28  | -34 | -6             | 0  | -7  | -1            | 79  | 0  | 3     |
| Joint Development             | 0              | 0  | 0  | 0             | 14   | 19  | 1              | 0  | 3   | 1             | 23  | 0  | 61    |
| Net 2035 Trips                | 0              | 0  | 0  | 0             | -14  | -15 | -5             | 0  | -4  | 0             | 102 | 0  | 64    |
| Cumulative                    | 0              | 0  | 0  | 0             | 1030 | 195 | 134            | 0  | 597 | 198           | 597 | 0  | 2751  |

Intersection Number: **3**  
 Traffic Node Number: 4005  
 Intersection Name: N. 28th St & E. Julian St  
 Peak Hour: AM  
 Count Date: 04/09/15  
 Scenario: BART Extension Phase II  
 Date of Analysis: 09/02/15

| Scenario:                     | Movements      |    |     |               |     |     |                |    |     |               |     |    | Total |
|-------------------------------|----------------|----|-----|---------------|-----|-----|----------------|----|-----|---------------|-----|----|-------|
|                               | North Approach |    |     | East Approach |     |     | South Approach |    |     | West Approach |     |    |       |
|                               | RT             | TH | LT  | RT            | TH  | LT  | RT             | TH | LT  | RT            | TH  | LT |       |
| Existing Conditions           | 2              | 24 | 182 | 142           | 798 | 36  | 100            | 42 | 71  | 21            | 591 | 2  | 2011  |
| <b>Approved Project Trips</b> |                |    |     |               |     |     |                |    |     |               |     |    |       |
| San Jose ATI                  | 0              | 0  | 0   | 0             | 0   | 0   | 0              | 0  | 0   | 0             | 0   | 0  | 0     |
| Santa Clara ATI               | 0              | 0  | 0   | 0             | 0   | 0   | 0              | 0  | 0   | 0             | 0   | 0  | 0     |
| Total Approved Trips          | 0              | 0  | 0   | 0             | 0   | 0   | 0              | 0  | 0   | 0             | 0   | 0  | 0     |
| Background Conditions         | 2              | 24 | 182 | 142           | 798 | 36  | 100            | 42 | 71  | 21            | 591 | 2  | 2011  |
| <b>2015 Project Trips</b>     |                |    |     |               |     |     |                |    |     |               |     |    |       |
| BART                          | -1             | 0  | -1  | -1            | -35 | 33  | 18             | 0  | 1   | 30            | -16 | -1 | 27    |
| Joint Development             | 0              | 1  | 0   | 0             | 2   | 280 | 82             | 1  | 27  | 64            | 0   | 0  | 457   |
| Net 2015 Trips                | -1             | 1  | -1  | -1            | -33 | 313 | 100            | 1  | 28  | 94            | -16 | -1 | 484   |
| Existing + Project            | 1              | 25 | 181 | 141           | 765 | 349 | 200            | 43 | 99  | 115           | 575 | 1  | 2495  |
| <b>2025 Project Trips</b>     |                |    |     |               |     |     |                |    |     |               |     |    |       |
| BART                          | -2             | 0  | -1  | -1            | -50 | 123 | 29             | 0  | 2   | 66            | -27 | -1 | 138   |
| Joint Development             | 0              | 1  | 0   | 0             | 1   | 238 | 81             | 1  | 26  | 66            | 0   | 0  | 414   |
| Net 2025 Trips                | -2             | 1  | -1  | -1            | -49 | 361 | 110            | 1  | 28  | 132           | -27 | -1 | 552   |
| Background + Project          | 0              | 25 | 181 | 141           | 749 | 397 | 210            | 43 | 99  | 153           | 564 | 1  | 2563  |
| Cumulative No Project         | 7              | 27 | 195 | 142           | 798 | 340 | 100            | 48 | 117 | 36            | 591 | 6  | 2401  |
| <b>2035 Project Trips</b>     |                |    |     |               |     |     |                |    |     |               |     |    |       |
| BART                          | -3             | 1  | -3  | -2            | -62 | 144 | 33             | 0  | 5   | 96            | -28 | -1 | 180   |
| Joint Development             | 0              | 1  | 0   | 0             | 8   | 214 | 74             | 1  | 23  | 27            | 0   | 0  | 348   |
| Net 2035 Trips                | -3             | 2  | -3  | -2            | -54 | 358 | 107            | 1  | 28  | 123           | -28 | -1 | 528   |
| Cumulative                    | 4              | 29 | 192 | 140           | 744 | 698 | 207            | 49 | 145 | 159           | 563 | 5  | 2935  |

Intersection Number: **4**  
 Traffic Node Number: 3210  
 Intersection Name: US 101 SB ramps & E. Julian St  
 Peak Hour: AM  
 Count Date: 10/09/14  
 Scenario: BART Extension Phase II  
 Date of Analysis: 09/02/15

| Scenario:                     | Movements      |    |    |               |      |     |                |    |     |               |     |    | Total |
|-------------------------------|----------------|----|----|---------------|------|-----|----------------|----|-----|---------------|-----|----|-------|
|                               | North Approach |    |    | East Approach |      |     | South Approach |    |     | West Approach |     |    |       |
|                               | RT             | TH | LT | RT            | TH   | LT  | RT             | TH | LT  | RT            | TH  | LT |       |
| Existing Conditions           | 0              | 0  | 0  | 0             | 938  | 513 | 320            | 0  | 106 | 408           | 549 | 0  | 2834  |
| <b>Approved Project Trips</b> |                |    |    |               |      |     |                |    |     |               |     |    |       |
| San Jose ATI                  | 0              | 0  | 0  | 0             | 21   | 208 | 66             | 0  | 6   | 1             | 22  | 0  | 324   |
| Santa Clara ATI               | 0              | 0  | 0  | 0             | 0    | 0   | 0              | 0  | 0   | 0             | 0   | 0  | 0     |
| Total Approved Trips          | 0              | 0  | 0  | 0             | 21   | 208 | 66             | 0  | 6   | 1             | 22  | 0  | 324   |
| Background Conditions         | 0              | 0  | 0  | 0             | 959  | 721 | 386            | 0  | 112 | 409           | 571 | 0  | 3158  |
| <b>2015 Project Trips</b>     |                |    |    |               |      |     |                |    |     |               |     |    |       |
| BART                          | 0              | 0  | 0  | 0             | 0    | -1  | -5             | 0  | -3  | 18            | -17 | 0  | -8    |
| Joint Development             | 0              | 0  | 0  | 0             | 173  | 0   | 1              | 0  | 109 | 33            | 50  | 0  | 366   |
| Net 2015 Trips                | 0              | 0  | 0  | 0             | 173  | -1  | -4             | 0  | 106 | 51            | 33  | 0  | 358   |
| Existing + Project            | 0              | 0  | 0  | 0             | 1111 | 512 | 316            | 0  | 212 | 459           | 582 | 0  | 3192  |
| <b>2025 Project Trips</b>     |                |    |    |               |      |     |                |    |     |               |     |    |       |
| BART                          | 0              | 0  | 0  | 0             | 33   | -9  | 0              | 0  | 36  | 23            | -23 | 0  | 60    |
| Joint Development             | 0              | 0  | 0  | 0             | 133  | 0   | 0              | 0  | 106 | 32            | 51  | 0  | 322   |
| Net 2025 Trips                | 0              | 0  | 0  | 0             | 166  | -9  | 0              | 0  | 142 | 55            | 28  | 0  | 382   |
| Background + Project          | 0              | 0  | 0  | 0             | 1125 | 712 | 386            | 0  | 254 | 464           | 599 | 0  | 3540  |
| Cumulative No Project         | 0              | 0  | 0  | 0             | 1040 | 914 | 473            | 0  | 112 | 409           | 571 | 0  | 3519  |
| <b>2035 Project Trips</b>     |                |    |    |               |      |     |                |    |     |               |     |    |       |
| BART                          | 0              | 0  | 0  | 0             | 30   | -13 | 0              | 0  | 52  | 23            | -21 | 0  | 71    |
| Joint Development             | 0              | 0  | 0  | 0             | 116  | 0   | 0              | 0  | 107 | 26            | 48  | 0  | 297   |
| Net 2035 Trips                | 0              | 0  | 0  | 0             | 146  | -13 | 0              | 0  | 159 | 49            | 27  | 0  | 368   |
| Cumulative                    | 0              | 0  | 0  | 0             | 1186 | 901 | 473            | 0  | 271 | 458           | 598 | 0  | 3887  |

Intersection Number: **5**  
 Traffic Node Number: 3211  
 Intersection Name: US 101 NB ramps & McKee Rd  
 Peak Hour: AM  
 Count Date: 10/09/14  
 Scenario: BART Extension Phase II  
 Date of Analysis: 09/02/15

| Scenario:                     | Movements      |    |    |               |      |    |                |    |     |               |     |     | Total |
|-------------------------------|----------------|----|----|---------------|------|----|----------------|----|-----|---------------|-----|-----|-------|
|                               | North Approach |    |    | East Approach |      |    | South Approach |    |     | West Approach |     |     |       |
|                               | RT             | TH | LT | RT            | TH   | LT | RT             | TH | LT  | RT            | TH  | LT  |       |
| Existing Conditions           | 0              | 0  | 0  | 376           | 1181 | 0  | 241            | 6  | 240 | 0             | 761 | 114 | 2919  |
| <b>Approved Project Trips</b> |                |    |    |               |      |    |                |    |     |               |     |     |       |
| San Jose ATI                  | 0              | 0  | 0  | 50            | 234  | 0  | 163            | 0  | 13  | 0             | 91  | 4   | 555   |
| Santa Clara ATI               | 0              | 0  | 0  | 0             | 0    | 0  | 0              | 0  | 0   | 0             | 0   | 0   | 0     |
| Total Approved Trips          | 0              | 0  | 0  | 50            | 234  | 0  | 163            | 0  | 13  | 0             | 91  | 4   | 555   |
| Background Conditions         | 0              | 0  | 0  | 426           | 1415 | 0  | 404            | 6  | 253 | 0             | 852 | 118 | 3474  |
| <b>2015 Project Trips</b>     |                |    |    |               |      |    |                |    |     |               |     |     |       |
| BART                          | 0              | 0  | 0  | -7            | -21  | 0  | -1             | 0  | 20  | 0             | -15 | -8  | -32   |
| Joint Development             | 0              | 0  | 0  | 1             | 93   | 0  | 0              | 0  | 81  | 0             | 35  | 15  | 225   |
| Net 2015 Trips                | 0              | 0  | 0  | -6            | 72   | 0  | -1             | 0  | 101 | 0             | 20  | 7   | 193   |
| Existing + Project            | 0              | 0  | 0  | 370           | 1253 | 0  | 240            | 6  | 341 | 0             | 781 | 121 | 3112  |
| <b>2025 Project Trips</b>     |                |    |    |               |      |    |                |    |     |               |     |     |       |
| BART                          | 0              | 0  | 0  | -23           | -31  | 0  | -74            | 0  | 18  | 0             | -22 | -6  | -138  |
| Joint Development             | 0              | 0  | 0  | 2             | 101  | 0  | 0              | 0  | 30  | 0             | 40  | 11  | 184   |
| Net 2025 Trips                | 0              | 0  | 0  | -21           | 70   | 0  | -74            | 0  | 48  | 0             | 18  | 5   | 46    |
| Background + Project          | 0              | 0  | 0  | 405           | 1485 | 0  | 330            | 6  | 301 | 0             | 870 | 123 | 3520  |
| Cumulative No Project         | 0              | 0  | 0  | 471           | 1815 | 0  | 404            | 6  | 253 | 0             | 884 | 118 | 3833  |
| <b>2035 Project Trips</b>     |                |    |    |               |      |    |                |    |     |               |     |     |       |
| BART                          | 0              | 0  | 0  | -11           | -30  | 0  | -70            | 0  | 26  | 0             | -23 | -5  | -113  |
| Joint Development             | 0              | 0  | 0  | 1             | 87   | 0  | 0              | 0  | 29  | 0             | 35  | 14  | 166   |
| Net 2035 Trips                | 0              | 0  | 0  | -10           | 57   | 0  | -70            | 0  | 55  | 0             | 12  | 9   | 53    |
| Cumulative                    | 0              | 0  | 0  | 461           | 1872 | 0  | 334            | 6  | 308 | 0             | 896 | 127 | 4004  |

Intersection Number: **6**  
 Traffic Node Number: 3678  
 Intersection Name: 33rd St & McKee Rd  
 Peak Hour: AM  
 Count Date: 05/21/15  
 Scenario: BART Extension Phase II  
 Date of Analysis: 09/02/15

| Scenario:                     | Movements      |    |    |               |      |    |                |     |     |               |      |     | Total |
|-------------------------------|----------------|----|----|---------------|------|----|----------------|-----|-----|---------------|------|-----|-------|
|                               | North Approach |    |    | East Approach |      |    | South Approach |     |     | West Approach |      |     |       |
|                               | RT             | TH | LT | RT            | TH   | LT | RT             | TH  | LT  | RT            | TH   | LT  |       |
| Existing Conditions           | 149            | 60 | 76 | 20            | 1102 | 26 | 37             | 94  | 132 | 47            | 898  | 109 | 2750  |
| <b>Approved Project Trips</b> |                |    |    |               |      |    |                |     |     |               |      |     |       |
| San Jose ATI                  | 0              | 0  | 0  | 0             | 272  | 0  | 0              | 0   | 0   | 1             | 235  | 5   | 513   |
| Santa Clara ATI               | 0              | 0  | 0  | 0             | 0    | 0  | 0              | 0   | 0   | 0             | 0    | 0   | 0     |
| Total Approved Trips          | 0              | 0  | 0  | 0             | 272  | 0  | 0              | 0   | 0   | 1             | 235  | 5   | 513   |
| Background Conditions         | 149            | 60 | 76 | 20            | 1374 | 26 | 37             | 94  | 132 | 48            | 1133 | 114 | 3263  |
| <b>2015 Project Trips</b>     |                |    |    |               |      |    |                |     |     |               |      |     |       |
| BART                          | -2             | 0  | 0  | 0             | -29  | 0  | 1              | 0   | 4   | 0             | -12  | -4  | -42   |
| Joint Development             | 3              | 1  | 0  | 0             | 80   | 0  | 0              | 0   | 8   | 0             | 31   | 3   | 126   |
| Net 2015 Trips                | 1              | 1  | 0  | 0             | 51   | 0  | 1              | 0   | 12  | 0             | 19   | -1  | 84    |
| Existing + Project            | 150            | 61 | 76 | 20            | 1153 | 26 | 38             | 94  | 144 | 47            | 917  | 108 | 2834  |
| <b>2025 Project Trips</b>     |                |    |    |               |      |    |                |     |     |               |      |     |       |
| BART                          | -1             | 0  | 0  | -1            | -63  | -1 | -1             | 0   | 6   | 0             | -78  | -3  | -142  |
| Joint Development             | 2              | 1  | 0  | 0             | 97   | 0  | 0              | 0   | 4   | 0             | 36   | 3   | 143   |
| Net 2025 Trips                | 1              | 1  | 0  | -1            | 34   | -1 | -1             | 0   | 10  | 0             | -42  | 0   | 1     |
| Background + Project          | 150            | 61 | 76 | 19            | 1408 | 25 | 36             | 94  | 142 | 48            | 1091 | 114 | 3264  |
| Cumulative No Project         | 149            | 80 | 89 | 48            | 1770 | 81 | 75             | 107 | 212 | 104           | 1133 | 114 | 3848  |
| <b>2035 Project Trips</b>     |                |    |    |               |      |    |                |     |     |               |      |     |       |
| BART                          | -1             | 0  | 0  | 0             | -44  | -1 | -3             | 0   | 4   | 1             | -99  | -2  | -145  |
| Joint Development             | 1              | 0  | 1  | 0             | 75   | 0  | 0              | 0   | 10  | 0             | 32   | 3   | 122   |
| Net 2035 Trips                | 0              | 0  | 1  | 0             | 31   | -1 | -3             | 0   | 14  | 1             | -67  | 1   | -23   |
| Cumulative                    | 149            | 80 | 90 | 48            | 1801 | 80 | 72             | 107 | 226 | 105           | 1066 | 115 | 3939  |

Intersection Number: **7**  
 Traffic Node Number: 3625  
 Intersection Name: King Rd & McKee Rd  
 Peak Hour: AM  
 Count Date: 10/09/14  
 Scenario: BART Extension Phase II  
 Date of Analysis: 09/02/15

| Scenario:                     | Movements      |     |     |               |     |     |                |      |     |               |     |     | Total |
|-------------------------------|----------------|-----|-----|---------------|-----|-----|----------------|------|-----|---------------|-----|-----|-------|
|                               | North Approach |     |     | East Approach |     |     | South Approach |      |     | West Approach |     |     |       |
|                               | RT             | TH  | LT  | RT            | TH  | LT  | RT             | TH   | LT  | RT            | TH  | LT  |       |
| Existing Conditions           | 326            | 259 | 80  | 287           | 754 | 122 | 162            | 645  | 167 | 82            | 537 | 331 | 3752  |
| <b>Approved Project Trips</b> |                |     |     |               |     |     |                |      |     |               |     |     |       |
| San Jose ATI                  | 240            | 83  | 82  | 57            | 43  | 0   | 2              | 72   | 3   | 2             | 67  | 180 | 831   |
| Santa Clara ATI               | 0              | 0   | 0   | 0             | 0   | 0   | 0              | 0    | 0   | 0             | 0   | 0   | 0     |
| Total Approved Trips          | 240            | 83  | 82  | 57            | 43  | 0   | 2              | 72   | 3   | 2             | 67  | 180 | 831   |
| Background Conditions         | 566            | 342 | 162 | 344           | 797 | 122 | 164            | 717  | 170 | 84            | 604 | 511 | 4583  |
| <b>2015 Project Trips</b>     |                |     |     |               |     |     |                |      |     |               |     |     |       |
| BART                          | -3             | 5   | 1   | 4             | -24 | -5  | -1             | 11   | 1   | 0             | -9  | -2  | -22   |
| Joint Development             | 13             | 5   | 0   | 0             | 63  | 11  | 0              | 1    | 4   | 0             | 21  | 9   | 127   |
| Net 2015 Trips                | 10             | 10  | 1   | 4             | 39  | 6   | -1             | 12   | 5   | 0             | 12  | 7   | 105   |
| Existing + Project            | 336            | 269 | 81  | 291           | 793 | 128 | 161            | 657  | 172 | 82            | 549 | 338 | 3857  |
| <b>2025 Project Trips</b>     |                |     |     |               |     |     |                |      |     |               |     |     |       |
| BART                          | -23            | -22 | 0   | -1            | -31 | -7  | 0              | -82  | 4   | 0             | -10 | -82 | -254  |
| Joint Development             | 15             | 7   | 0   | 0             | 67  | 18  | 0              | 0    | 14  | 1             | 20  | 14  | 156   |
| Net 2025 Trips                | -8             | -15 | 0   | -1            | 36  | 11  | 0              | -82  | 18  | 1             | 10  | -68 | -98   |
| Background + Project          | 558            | 327 | 162 | 343           | 833 | 133 | 164            | 635  | 188 | 85            | 614 | 443 | 4485  |
| Cumulative No Project         | 756            | 509 | 162 | 405           | 891 | 127 | 172            | 804  | 348 | 123           | 724 | 511 | 5021  |
| <b>2035 Project Trips</b>     |                |     |     |               |     |     |                |      |     |               |     |     |       |
| BART                          | -35            | -37 | 0   | -2            | -18 | -7  | 0              | -105 | 10  | 1             | -14 | -80 | -287  |
| Joint Development             | 10             | 5   | 0   | 0             | 52  | 18  | 0              | 0    | 14  | 2             | 22  | 9   | 132   |
| Net 2035 Trips                | -25            | -32 | 0   | -2            | 34  | 11  | 0              | -105 | 24  | 3             | 8   | -71 | -155  |
| Cumulative                    | 731            | 477 | 162 | 403           | 925 | 138 | 172            | 699  | 372 | 126           | 732 | 440 | 5377  |

Intersection Number: **8**  
 Traffic Node Number: 3596  
 Intersection Name: Jackson Ave & McKee Rd  
 Peak Hour: AM  
 Count Date: 05/21/15  
 Scenario: BART Extension Phase II  
 Date of Analysis: 09/02/15

| Scenario:                     | Movements      |     |     |               |      |     |                |     |     |               |      |     | Total |
|-------------------------------|----------------|-----|-----|---------------|------|-----|----------------|-----|-----|---------------|------|-----|-------|
|                               | North Approach |     |     | East Approach |      |     | South Approach |     |     | West Approach |      |     |       |
|                               | RT             | TH  | LT  | RT            | TH   | LT  | RT             | TH  | LT  | RT            | TH   | LT  |       |
| Existing Conditions           | 126            | 209 | 334 | 296           | 872  | 253 | 262            | 357 | 257 | 96            | 806  | 175 | 4043  |
| <b>Approved Project Trips</b> |                |     |     |               |      |     |                |     |     |               |      |     |       |
| San Jose ATI                  | 19             | 70  | 14  | 11            | 41   | 80  | 40             | 43  | 37  | 52            | 62   | 17  | 486   |
| Santa Clara ATI               | 0              | 0   | 0   | 0             | 0    | 0   | 0              | 0   | 0   | 0             | 0    | 0   | 0     |
| Total Approved Trips          | 19             | 70  | 14  | 11            | 41   | 80  | 40             | 43  | 37  | 52            | 62   | 17  | 486   |
| Background Conditions         | 145            | 279 | 348 | 307           | 913  | 333 | 302            | 400 | 294 | 148           | 868  | 192 | 4529  |
| <b>2015 Project Trips</b>     |                |     |     |               |      |     |                |     |     |               |      |     |       |
| BART                          | 0              | 0   | 0   | 5             | -27  | 0   | -3             | 8   | 0   | 0             | -14  | 0   | -31   |
| Joint Development             | 2              | 0   | 0   | 1             | 59   | 0   | 0              | 0   | 4   | 0             | 16   | 1   | 83    |
| Net 2015 Trips                | 2              | 0   | 0   | 6             | 32   | 0   | -3             | 8   | 4   | 0             | 2    | 1   | 52    |
| Existing + Project            | 128            | 209 | 334 | 302           | 904  | 253 | 259            | 365 | 261 | 96            | 808  | 176 | 4095  |
| <b>2025 Project Trips</b>     |                |     |     |               |      |     |                |     |     |               |      |     |       |
| BART                          | 0              | 0   | -1  | -10           | -30  | -2  | -4             | -8  | -1  | -1            | -13  | 0   | -70   |
| Joint Development             | 5              | 0   | 0   | 2             | 64   | 0   | 0              | 0   | 5   | 0             | 15   | 1   | 92    |
| Net 2025 Trips                | 5              | 0   | -1  | -8            | 34   | -2  | -4             | -8  | 4   | -1            | 2    | 1   | 22    |
| Background + Project          | 150            | 279 | 347 | 299           | 947  | 331 | 298            | 392 | 298 | 147           | 870  | 193 | 4551  |
| Cumulative No Project         | 232            | 319 | 482 | 371           | 1132 | 364 | 354            | 400 | 296 | 148           | 1225 | 198 | 5323  |
| <b>2035 Project Trips</b>     |                |     |     |               |      |     |                |     |     |               |      |     |       |
| BART                          | -2             | 0   | -5  | -7            | -26  | -2  | -4             | -4  | 0   | -1            | -19  | 0   | -70   |
| Joint Development             | 6              | 0   | 0   | 1             | 50   | 0   | 0              | 0   | 6   | 0             | 17   | 0   | 80    |
| Net 2035 Trips                | 4              | 0   | -5  | -6            | 24   | -2  | -4             | -4  | 6   | -1            | -2   | 0   | 10    |
| Cumulative                    | 236            | 319 | 477 | 365           | 1156 | 362 | 350            | 396 | 302 | 147           | 1223 | 198 | 5531  |



Intersection Number: **9**  
 Trafix Node Number: 3783  
 Intersection Name: 17th St & E. Santa Clara St  
 Peak Hour: AM  
 Count Date: 10/09/14  
 Scenario: BART Extension Phase II  
 Date of Analysis: 09/02/15

| Scenario:                     | Movements      |    |     |               |     |    |                |    |     |               |     |     | Total |
|-------------------------------|----------------|----|-----|---------------|-----|----|----------------|----|-----|---------------|-----|-----|-------|
|                               | North Approach |    |     | East Approach |     |    | South Approach |    |     | West Approach |     |     |       |
|                               | RT             | TH | LT  | RT            | TH  | LT | RT             | TH | LT  | RT            | TH  | LT  |       |
| Existing Conditions           | 23             | 37 | 59  | 92            | 734 | 8  | 4              | 3  | 7   | 4             | 311 | 16  | 1298  |
| <b>Approved Project Trips</b> |                |    |     |               |     |    |                |    |     |               |     |     |       |
| San Jose ATI                  | 0              | 0  | 0   | 1             | 6   | 0  | 0              | 0  | 0   | 0             | 0   | 0   | 7     |
| Santa Clara ATI               | 0              | 0  | 0   | 0             | 0   | 0  | 0              | 0  | 0   | 0             | 0   | 0   | 0     |
| Total Approved Trips          | 0              | 0  | 0   | 1             | 6   | 0  | 0              | 0  | 0   | 0             | 0   | 0   | 7     |
| Background Conditions         | 23             | 37 | 59  | 93            | 740 | 8  | 4              | 3  | 7   | 4             | 311 | 16  | 1305  |
| <b>2015 Project Trips</b>     |                |    |     |               |     |    |                |    |     |               |     |     |       |
| BART                          | 0              | 0  | 0   | -1            | -26 | 0  | 1              | -1 | -1  | 0             | 28  | 0   | 0     |
| Joint Development             | 0              | 0  | 0   | 7             | 17  | 0  | 3              | 2  | 0   | 0             | 67  | 0   | 96    |
| Net 2015 Trips                | 0              | 0  | 0   | 6             | -9  | 0  | 4              | 1  | -1  | 0             | 95  | 0   | 96    |
| Existing + Project            | 23             | 37 | 59  | 98            | 725 | 8  | 8              | 4  | 6   | 4             | 406 | 16  | 1394  |
| <b>2025 Project Trips</b>     |                |    |     |               |     |    |                |    |     |               |     |     |       |
| BART                          | 0              | 0  | 0   | -12           | -33 | 0  | 1              | -3 | -5  | 0             | 24  | -1  | -29   |
| Joint Development             | 0              | 0  | 1   | 8             | 11  | 0  | 3              | 2  | 0   | 0             | 81  | 0   | 106   |
| Net 2025 Trips                | 0              | 0  | 1   | -4            | -22 | 0  | 4              | -1 | -5  | 0             | 105 | -1  | 77    |
| Background + Project          | 23             | 37 | 60  | 89            | 718 | 8  | 8              | 2  | 2   | 4             | 416 | 15  | 1382  |
| Cumulative No Project         | 34             | 76 | 201 | 391           | 740 | 8  | 4              | 22 | 250 | 9             | 492 | 116 | 2227  |
| <b>2035 Project Trips</b>     |                |    |     |               |     |    |                |    |     |               |     |     |       |
| BART                          | 0              | 0  | 0   | -9            | -48 | 0  | 3              | -6 | -4  | 0             | 43  | -2  | -23   |
| Joint Development             | 0              | 0  | 12  | 10            | 7   | 0  | 2              | 0  | 2   | 0             | 109 | 0   | 142   |
| Net 2035 Trips                | 0              | 0  | 12  | 1             | -41 | 0  | 5              | -6 | -2  | 0             | 152 | -2  | 119   |
| Cumulative                    | 34             | 76 | 213 | 392           | 699 | 8  | 9              | 16 | 248 | 9             | 644 | 114 | 2462  |

Intersection Number: **10**  
 Trafix Node Number: 3789  
 Intersection Name: 21st St & E. Santa Clara St  
 Peak Hour: AM  
 Count Date: 10/09/14  
 Scenario: BART Extension Phase II  
 Date of Analysis: 09/02/15

| Scenario:                     | Movements      |    |    |               |     |    |                |    |    |               |     |    | Total |
|-------------------------------|----------------|----|----|---------------|-----|----|----------------|----|----|---------------|-----|----|-------|
|                               | North Approach |    |    | East Approach |     |    | South Approach |    |    | West Approach |     |    |       |
|                               | RT             | TH | LT | RT            | TH  | LT | RT             | TH | LT | RT            | TH  | LT |       |
| Existing Conditions           | 7              | 1  | 6  | 10            | 634 | 5  | 27             | 3  | 76 | 9             | 369 | 5  | 1152  |
| <b>Approved Project Trips</b> |                |    |    |               |     |    |                |    |    |               |     |    |       |
| San Jose ATI                  | 0              | 0  | 0  | 0             | 8   | 0  | 0              | 0  | 0  | 0             | 1   | 0  | 9     |
| Santa Clara ATI               | 0              | 0  | 0  | 0             | 0   | 0  | 0              | 0  | 0  | 0             | 0   | 0  | 0     |
| Total Approved Trips          | 0              | 0  | 0  | 0             | 8   | 0  | 0              | 0  | 0  | 0             | 1   | 0  | 9     |
| Background Conditions         | 7              | 1  | 6  | 10            | 642 | 5  | 27             | 3  | 76 | 9             | 370 | 5  | 1161  |
| <b>2015 Project Trips</b>     |                |    |    |               |     |    |                |    |    |               |     |    |       |
| BART                          | 0              | 0  | 0  | 0             | -28 | 0  | 0              | 0  | 0  | 0             | 30  | -1 | 1     |
| Joint Development             | 0              | 0  | 1  | 1             | 25  | 0  | 0              | 0  | 0  | 0             | 70  | 0  | 97    |
| Net 2015 Trips                | 0              | 0  | 1  | 1             | -3  | 0  | 0              | 0  | 0  | 0             | 100 | -1 | 98    |
| Existing + Project            | 7              | 1  | 7  | 11            | 631 | 5  | 27             | 3  | 76 | 9             | 469 | 4  | 1250  |
| <b>2025 Project Trips</b>     |                |    |    |               |     |    |                |    |    |               |     |    |       |
| BART                          | 0              | 0  | 0  | 0             | -44 | 0  | 0              | 0  | 0  | 0             | 27  | -1 | -18   |
| Joint Development             | 0              | 0  | 3  | 1             | 19  | 0  | 0              | 0  | 0  | 0             | 86  | 1  | 110   |
| Net 2025 Trips                | 0              | 0  | 3  | 1             | -25 | 0  | 0              | 0  | 0  | 0             | 113 | 0  | 92    |
| Background + Project          | 7              | 1  | 9  | 11            | 617 | 5  | 27             | 3  | 76 | 9             | 483 | 5  | 1253  |
| Cumulative No Project         | 32             | 4  | 24 | 47            | 642 | 5  | 27             | 7  | 76 | 9             | 571 | 84 | 1444  |
| <b>2035 Project Trips</b>     |                |    |    |               |     |    |                |    |    |               |     |    |       |
| BART                          | -1             | 0  | 0  | 0             | -54 | 0  | 0              | 0  | 0  | 0             | 48  | -2 | -9    |
| Joint Development             | 0              | 0  | 2  | 1             | 17  | 0  | 0              | 0  | 0  | 0             | 123 | 1  | 144   |
| Net 2035 Trips                | -1             | 0  | 2  | 1             | -37 | 0  | 0              | 0  | 0  | 0             | 171 | -1 | 135   |
| Cumulative                    | 31             | 4  | 26 | 48            | 605 | 5  | 27             | 7  | 76 | 9             | 742 | 83 | 1663  |

Intersection Number: 11  
 Traffic Node Number: 3790  
 Intersection Name: 24th St & E. Santa Clara St  
 Peak Hour: AM  
 Count Date: 11/05/13  
 Scenario: BART Extension Phase II  
 Date of Analysis: 09/02/15

| Scenario:                     | Movements      |     |     |               |     |    |                |     |     |               |     |    | Total |
|-------------------------------|----------------|-----|-----|---------------|-----|----|----------------|-----|-----|---------------|-----|----|-------|
|                               | North Approach |     |     | East Approach |     |    | South Approach |     |     | West Approach |     |    |       |
|                               | RT             | TH  | LT  | RT            | TH  | LT | RT             | TH  | LT  | RT            | TH  | LT |       |
| Existing Conditions           | 78             | 141 | 23  | 39            | 822 | 67 | 117            | 265 | 86  | 38            | 354 | 51 | 2081  |
| <b>Approved Project Trips</b> |                |     |     |               |     |    |                |     |     |               |     |    |       |
| San Jose ATI                  | 0              | 3   | 0   | 0             | 5   | 5  | 6              | 12  | 4   | 0             | 0   | 0  | 35    |
| Santa Clara ATI               | 0              | 0   | 0   | 0             | 0   | 0  | 0              | 0   | 0   | 0             | 0   | 0  | 0     |
| Total Approved Trips          | 0              | 3   | 0   | 0             | 5   | 5  | 6              | 12  | 4   | 0             | 0   | 0  | 35    |
| Background Conditions         | 78             | 144 | 23  | 39            | 827 | 72 | 123            | 277 | 90  | 38            | 354 | 51 | 2116  |
| <b>2015 Project Trips</b>     |                |     |     |               |     |    |                |     |     |               |     |    |       |
| BART                          | -14            | -3  | 0   | -1            | -9  | 1  | 32             | -4  | -5  | -1            | 33  | -2 | 27    |
| Joint Development             | 5              | 0   | 2   | 2             | 16  | 3  | 48             | 0   | 5   | 0             | 72  | 0  | 153   |
| Net 2015 Trips                | -9             | -3  | 2   | 1             | 7   | 4  | 80             | -4  | 0   | -1            | 105 | -2 | 180   |
| Existing + Project            | 69             | 138 | 25  | 40            | 829 | 71 | 197            | 261 | 86  | 37            | 459 | 49 | 2261  |
| <b>2025 Project Trips</b>     |                |     |     |               |     |    |                |     |     |               |     |    |       |
| BART                          | -19            | -8  | 0   | -5            | -15 | -2 | 46             | -13 | -11 | -2            | 30  | -2 | -1    |
| Joint Development             | 3              | 0   | 2   | 5             | 12  | 3  | 27             | 0   | 5   | 0             | 89  | 0  | 146   |
| Net 2025 Trips                | -16            | -8  | 2   | 0             | -3  | 1  | 73             | -13 | -6  | -2            | 119 | -2 | 145   |
| Background + Project          | 62             | 136 | 25  | 39            | 824 | 73 | 196            | 264 | 84  | 36            | 473 | 49 | 2261  |
| Cumulative No Project         | 217            | 144 | 90  | 398           | 827 | 72 | 277            | 277 | 165 | 155           | 466 | 51 | 3088  |
| <b>2035 Project Trips</b>     |                |     |     |               |     |    |                |     |     |               |     |    |       |
| BART                          | -29            | -6  | 0   | -3            | -14 | -1 | 58             | -12 | -10 | -4            | 53  | -2 | 30    |
| Joint Development             | 5              | 0   | 16  | 3             | 8   | 0  | 29             | 0   | 5   | 0             | 125 | 0  | 191   |
| Net 2035 Trips                | -24            | -6  | 16  | 0             | -6  | -1 | 87             | -12 | -5  | -4            | 178 | -2 | 221   |
| Cumulative                    | 193            | 138 | 106 | 398           | 821 | 71 | 364            | 265 | 160 | 151           | 644 | 49 | 3360  |

Intersection Number: 12  
 Traffic Node Number: 4022  
 Intersection Name: 26th St & E. Santa Clara St  
 Peak Hour: AM  
 Count Date: 10/09/14  
 Scenario: BART Extension Phase II  
 Date of Analysis: 09/02/15

| Scenario:                     | Movements      |    |    |               |     |    |                |    |    |               |      |    | Total |
|-------------------------------|----------------|----|----|---------------|-----|----|----------------|----|----|---------------|------|----|-------|
|                               | North Approach |    |    | East Approach |     |    | South Approach |    |    | West Approach |      |    |       |
|                               | RT             | TH | LT | RT            | TH  | LT | RT             | TH | LT | RT            | TH   | LT |       |
| Existing Conditions           | 26             | 58 | 40 | 37            | 587 | 22 | 67             | 80 | 12 | 9             | 415  | 16 | 1369  |
| <b>Approved Project Trips</b> |                |    |    |               |     |    |                |    |    |               |      |    |       |
| San Jose ATI                  | 0              | 0  | 0  | 0             | 5   | 0  | 0              | 0  | 0  | 0             | 4    | 0  | 9     |
| Santa Clara ATI               | 0              | 0  | 0  | 0             | 0   | 0  | 0              | 0  | 0  | 0             | 0    | 0  | 0     |
| Total Approved Trips          | 0              | 0  | 0  | 0             | 5   | 0  | 0              | 0  | 0  | 0             | 4    | 0  | 9     |
| Background Conditions         | 26             | 58 | 40 | 37            | 592 | 22 | 67             | 80 | 12 | 9             | 419  | 16 | 1378  |
| <b>2015 Project Trips</b>     |                |    |    |               |     |    |                |    |    |               |      |    |       |
| BART                          | 0              | 0  | 0  | 0             | -9  | 0  | 0              | 0  | 0  | 0             | 63   | 0  | 54    |
| Joint Development             | 0              | 0  | 0  | 0             | 22  | 0  | 0              | 0  | 0  | 0             | 122  | 0  | 144   |
| Net 2015 Trips                | 0              | 0  | 0  | 0             | 13  | 0  | 0              | 0  | 0  | 0             | 185  | 0  | 198   |
| Existing + Project            | 26             | 58 | 40 | 37            | 600 | 22 | 67             | 80 | 12 | 9             | 600  | 16 | 1567  |
| <b>2025 Project Trips</b>     |                |    |    |               |     |    |                |    |    |               |      |    |       |
| BART                          | 0              | 0  | 0  | 0             | -20 | 0  | 0              | 0  | 0  | 0             | 76   | 0  | 56    |
| Joint Development             | 0              | 0  | 0  | 0             | 22  | 0  | 0              | 0  | 0  | 0             | 119  | 0  | 141   |
| Net 2025 Trips                | 0              | 0  | 0  | 0             | 2   | 0  | 0              | 0  | 0  | 0             | 195  | 0  | 197   |
| Background + Project          | 26             | 58 | 40 | 37            | 594 | 22 | 67             | 80 | 12 | 9             | 614  | 16 | 1575  |
| Cumulative No Project         | 26             | 58 | 40 | 37            | 716 | 22 | 67             | 80 | 12 | 9             | 754  | 16 | 1821  |
| <b>2035 Project Trips</b>     |                |    |    |               |     |    |                |    |    |               |      |    |       |
| BART                          | 0              | 0  | 0  | 0             | -17 | 0  | 0              | 0  | 0  | 0             | 112  | 0  | 95    |
| Joint Development             | 0              | 0  | 0  | 0             | 10  | 0  | 0              | 0  | 0  | 0             | 171  | 0  | 181   |
| Net 2035 Trips                | 0              | 0  | 0  | 0             | -7  | 0  | 0              | 0  | 0  | 0             | 283  | 0  | 276   |
| Cumulative                    | 26             | 58 | 40 | 37            | 709 | 22 | 67             | 80 | 12 | 9             | 1037 | 16 | 2113  |

Intersection Number: **13**  
 Traffic Node Number: 3788  
 Intersection Name: N. 28th St & E. Santa Clara St  
 Peak Hour: AM  
 Count Date: 10/09/14  
 Scenario: BART Extension Phase II  
 Date of Analysis: 09/02/15

| Scenario:                     | Movements      |     |     |               |     |    |                |     |    |               |     |     | Total |
|-------------------------------|----------------|-----|-----|---------------|-----|----|----------------|-----|----|---------------|-----|-----|-------|
|                               | North Approach |     |     | East Approach |     |    | South Approach |     |    | West Approach |     |     |       |
|                               | RT             | TH  | LT  | RT            | TH  | LT | RT             | TH  | LT | RT            | TH  | LT  |       |
| Existing Conditions           | 35             | 51  | 71  | 124           | 606 | 46 | 196            | 147 | 47 | 24            | 474 | 37  | 1858  |
| <b>Approved Project Trips</b> |                |     |     |               |     |    |                |     |    |               |     |     |       |
| San Jose ATI                  | 0              | 0   | 0   | 0             | 7   | 0  | 0              | 0   | 0  | 0             | 8   | 0   | 15    |
| Santa Clara ATI               | 0              | 0   | 0   | 0             | 0   | 0  | 0              | 0   | 0  | 0             | 0   | 0   | 0     |
| Total Approved Trips          | 0              | 0   | 0   | 0             | 7   | 0  | 0              | 0   | 0  | 0             | 8   | 0   | 15    |
| Background Conditions         | 35             | 51  | 71  | 124           | 613 | 46 | 196            | 147 | 47 | 24            | 482 | 37  | 1873  |
| <b>2015 Project Trips</b>     |                |     |     |               |     |    |                |     |    |               |     |     |       |
| BART                          | 1              | 0   | 3   | 74            | -11 | -2 | -7             | 7   | 0  | 0             | -2  | 66  | 129   |
| Joint Development             | 19             | 9   | 42  | 97            | 3   | 0  | 0              | 24  | 0  | 0             | 0   | 122 | 316   |
| Net 2015 Trips                | 20             | 9   | 45  | 171           | -8  | -2 | -7             | 31  | 0  | 0             | -2  | 188 | 445   |
| Existing + Project            | 55             | 60  | 116 | 295           | 598 | 44 | 189            | 178 | 47 | 24            | 472 | 225 | 2303  |
| <b>2025 Project Trips</b>     |                |     |     |               |     |    |                |     |    |               |     |     |       |
| BART                          | 3              | -3  | 15  | 98            | -22 | -3 | -10            | 21  | 0  | 0             | -7  | 81  | 173   |
| Joint Development             | 18             | 11  | 43  | 104           | 3   | 0  | 0              | 62  | 0  | 0             | 0   | 119 | 360   |
| Net 2025 Trips                | 21             | 8   | 58  | 202           | -19 | -3 | -10            | 83  | 0  | 0             | -7  | 200 | 533   |
| Background + Project          | 56             | 59  | 129 | 326           | 594 | 43 | 186            | 230 | 47 | 24            | 475 | 237 | 2406  |
| Cumulative No Project         | 90             | 316 | 73  | 128           | 709 | 46 | 196            | 147 | 47 | 24            | 770 | 80  | 2546  |
| <b>2035 Project Trips</b>     |                |     |     |               |     |    |                |     |    |               |     |     |       |
| BART                          | 4              | -2  | 18  | 105           | -22 | -3 | -14            | 33  | -1 | 0             | -13 | 123 | 228   |
| Joint Development             | 7              | 12  | 44  | 57            | 3   | 0  | 0              | 57  | 0  | 0             | 0   | 171 | 351   |
| Net 2035 Trips                | 11             | 10  | 62  | 162           | -19 | -3 | -14            | 90  | -1 | 0             | -13 | 294 | 579   |
| Cumulative                    | 101            | 326 | 135 | 290           | 690 | 43 | 182            | 237 | 46 | 24            | 757 | 374 | 3205  |

Intersection Number: **14**  
 Traffic Node Number: 3023  
 Intersection Name: US 101 & E. Santa Clara St  
 Peak Hour: AM  
 Count Date: 10/09/14  
 Scenario: BART Extension Phase II  
 Date of Analysis: 09/02/15

| Scenario:                     | Movements      |    |     |               |     |     |                |    |    |               |     |    | Total |
|-------------------------------|----------------|----|-----|---------------|-----|-----|----------------|----|----|---------------|-----|----|-------|
|                               | North Approach |    |     | East Approach |     |     | South Approach |    |    | West Approach |     |    |       |
|                               | RT             | TH | LT  | RT            | TH  | LT  | RT             | TH | LT | RT            | TH  | LT |       |
| Existing Conditions           | 123            | 0  | 161 | 0             | 647 | 288 | 0              | 0  | 0  | 350           | 442 | 0  | 2011  |
| <b>Approved Project Trips</b> |                |    |     |               |     |     |                |    |    |               |     |    |       |
| San Jose ATI                  | 8              | 0  | 14  | 0             | 5   | 5   | 0              | 0  | 0  | 3             | 8   | 0  | 43    |
| Santa Clara ATI               | 0              | 0  | 0   | 0             | 0   | 0   | 0              | 0  | 0  | 0             | 0   | 0  | 0     |
| Total Approved Trips          | 8              | 0  | 14  | 0             | 5   | 5   | 0              | 0  | 0  | 3             | 8   | 0  | 43    |
| Background Conditions         | 131            | 0  | 175 | 0             | 652 | 293 | 0              | 0  | 0  | 353           | 450 | 0  | 2054  |
| <b>2015 Project Trips</b>     |                |    |     |               |     |     |                |    |    |               |     |    |       |
| BART                          | -2             | 0  | -2  | 0             | 63  | -2  | 0              | 0  | 0  | 0             | -6  | 0  | 51    |
| Joint Development             | 5              | 0  | 1   | 0             | 94  | 0   | 0              | 0  | 0  | 33            | 9   | 0  | 142   |
| Net 2015 Trips                | 3              | 0  | -1  | 0             | 157 | -2  | 0              | 0  | 0  | 33            | 3   | 0  | 193   |
| Existing + Project            | 126            | 0  | 160 | 0             | 804 | 286 | 0              | 0  | 0  | 383           | 445 | 0  | 2204  |
| <b>2025 Project Trips</b>     |                |    |     |               |     |     |                |    |    |               |     |    |       |
| BART                          | 3              | 0  | -2  | 0             | 70  | -15 | 0              | 0  | 0  | 11            | -13 | 0  | 54    |
| Joint Development             | 0              | 0  | 0   | 0             | 107 | 0   | 0              | 0  | 0  | 36            | 7   | 0  | 150   |
| Net 2025 Trips                | 3              | 0  | -2  | 0             | 177 | -15 | 0              | 0  | 0  | 47            | -6  | 0  | 204   |
| Background + Project          | 134            | 0  | 173 | 0             | 829 | 278 | 0              | 0  | 0  | 400           | 444 | 0  | 2258  |
| Cumulative No Project         | 131            | 0  | 244 | 0             | 736 | 293 | 0              | 0  | 0  | 410           | 661 | 0  | 2475  |
| <b>2035 Project Trips</b>     |                |    |     |               |     |     |                |    |    |               |     |    |       |
| BART                          | -1             | 0  | -3  | 0             | 82  | -17 | 0              | 0  | 0  | 10            | -19 | 0  | 52    |
| Joint Development             | 0              | 0  | 0   | 0             | 60  | 0   | 0              | 0  | 0  | 38            | 6   | 0  | 104   |
| Net 2035 Trips                | -1             | 0  | -3  | 0             | 142 | -17 | 0              | 0  | 0  | 48            | -13 | 0  | 156   |
| Cumulative                    | 130            | 0  | 241 | 0             | 878 | 276 | 0              | 0  | 0  | 458           | 648 | 0  | 2631  |

Intersection Number: 15  
 Traffic Node Number: 3016  
 Intersection Name: US 101 & Alum Rock Ave  
 Peak Hour: AM  
 Count Date: 10/09/14  
 Scenario: BART Extension Phase II  
 Date of Analysis: 09/02/15

| Scenario:                     | Movements      |    |    |               |      |    |                |    |     |               |     |     | Total |
|-------------------------------|----------------|----|----|---------------|------|----|----------------|----|-----|---------------|-----|-----|-------|
|                               | North Approach |    |    | East Approach |      |    | South Approach |    |     | West Approach |     |     |       |
|                               | RT             | TH | LT | RT            | TH   | LT | RT             | TH | LT  | RT            | TH  | LT  |       |
| Existing Conditions           | 0              | 0  | 0  | 278           | 704  | 0  | 45             | 1  | 198 | 0             | 375 | 197 | 1798  |
| <b>Approved Project Trips</b> |                |    |    |               |      |    |                |    |     |               |     |     |       |
| San Jose ATI                  | 0              | 0  | 0  | 6             | 15   | 0  | 3              | 0  | 0   | 0             | 22  | 4   | 50    |
| Santa Clara ATI               | 0              | 0  | 0  | 0             | 0    | 0  | 0              | 0  | 0   | 0             | 0   | 0   | 0     |
| Total Approved Trips          | 0              | 0  | 0  | 6             | 15   | 0  | 3              | 0  | 0   | 0             | 22  | 4   | 50    |
| Background Conditions         | 0              | 0  | 0  | 284           | 719  | 0  | 48             | 1  | 198 | 0             | 397 | 201 | 1848  |
| <b>2015 Project Trips</b>     |                |    |    |               |      |    |                |    |     |               |     |     |       |
| BART                          | 0              | 0  | 0  | -2            | -7   | 0  | 3              | 0  | 69  | 0             | -2  | -6  | 55    |
| Joint Development             | 0              | 0  | 0  | 21            | 49   | 0  | 7              | 0  | 46  | 0             | 10  | 0   | 133   |
| Net 2015 Trips                | 0              | 0  | 0  | 19            | 42   | 0  | 10             | 0  | 115 | 0             | 8   | -6  | 188   |
| Existing + Project            | 0              | 0  | 0  | 297           | 746  | 0  | 55             | 1  | 313 | 0             | 383 | 191 | 1986  |
| <b>2025 Project Trips</b>     |                |    |    |               |      |    |                |    |     |               |     |     |       |
| BART                          | 0              | 0  | 0  | -9            | -17  | 0  | -9             | 0  | 72  | 0             | -3  | -10 | 24    |
| Joint Development             | 0              | 0  | 0  | 1             | 53   | 0  | 3              | 0  | 55  | 0             | 7   | 0   | 119   |
| Net 2025 Trips                | 0              | 0  | 0  | -8            | 36   | 0  | -6             | 0  | 127 | 0             | 4   | -10 | 143   |
| Background + Project          | 0              | 0  | 0  | 276           | 755  | 0  | 42             | 1  | 325 | 0             | 401 | 191 | 1991  |
| Cumulative No Project         | 0              | 0  | 0  | 284           | 1133 | 0  | 378            | 1  | 198 | 0             | 527 | 348 | 2521  |
| <b>2035 Project Trips</b>     |                |    |    |               |      |    |                |    |     |               |     |     |       |
| BART                          | 0              | 0  | 0  | -3            | -14  | 0  | -24            | 0  | 80  | 0             | -4  | -16 | 19    |
| Joint Development             | 0              | 0  | 0  | 0             | 32   | 0  | 19             | 0  | 26  | 0             | 6   | 0   | 83    |
| Net 2035 Trips                | 0              | 0  | 0  | -3            | 18   | 0  | -5             | 0  | 106 | 0             | 2   | -16 | 102   |
| Cumulative                    | 0              | 0  | 0  | 281           | 1151 | 0  | 373            | 1  | 304 | 0             | 529 | 332 | 2971  |

Intersection Number: 16  
 Traffic Node Number: 3260  
 Intersection Name: 33rd St & Alum Rock Rd  
 Peak Hour: AM  
 Count Date: 05/21/15  
 Scenario: BART Extension Phase II  
 Date of Analysis: 09/02/15

| Scenario:                     | Movements      |    |     |               |     |    |                |    |     |               |     |    | Total |
|-------------------------------|----------------|----|-----|---------------|-----|----|----------------|----|-----|---------------|-----|----|-------|
|                               | North Approach |    |     | East Approach |     |    | South Approach |    |     | West Approach |     |    |       |
|                               | RT             | TH | LT  | RT            | TH  | LT | RT             | TH | LT  | RT            | TH  | LT |       |
| Existing Conditions           | 127            | 64 | 16  | 20            | 600 | 12 | 18             | 77 | 141 | 53            | 362 | 24 | 1514  |
| <b>Approved Project Trips</b> |                |    |     |               |     |    |                |    |     |               |     |    |       |
| San Jose ATI                  | 0              | 0  | 0   | 0             | 6   | 0  | 6              | 0  | 0   | 0             | 15  | 0  | 27    |
| Santa Clara ATI               | 0              | 0  | 0   | 0             | 0   | 0  | 0              | 0  | 0   | 0             | 0   | 0  | 0     |
| Total Approved Trips          | 0              | 0  | 0   | 0             | 6   | 0  | 6              | 0  | 0   | 0             | 15  | 0  | 27    |
| Background Conditions         | 127            | 64 | 16  | 20            | 606 | 12 | 24             | 77 | 141 | 53            | 377 | 24 | 1541  |
| <b>2015 Project Trips</b>     |                |    |     |               |     |    |                |    |     |               |     |    |       |
| BART                          | -1             | 0  | 0   | 0             | -9  | 0  | 0              | 0  | 1   | 0             | -2  | 4  | -7    |
| Joint Development             | 1              | 0  | 0   | 0             | 67  | 0  | 0              | 0  | 1   | 0             | 9   | 7  | 85    |
| Net 2015 Trips                | 0              | 0  | 0   | 0             | 58  | 0  | 0              | 0  | 2   | 0             | 7   | 11 | 78    |
| Existing + Project            | 127            | 64 | 16  | 20            | 658 | 12 | 18             | 77 | 143 | 53            | 369 | 35 | 1592  |
| <b>2025 Project Trips</b>     |                |    |     |               |     |    |                |    |     |               |     |    |       |
| BART                          | 0              | 0  | 0   | 0             | -30 | 0  | 0              | 0  | 1   | 0             | -20 | 6  | -43   |
| Joint Development             | 1              | 0  | 0   | 0             | 52  | 0  | 0              | 0  | 1   | 0             | 7   | 3  | 64    |
| Net 2025 Trips                | 1              | 0  | 0   | 0             | 22  | 0  | 0              | 0  | 2   | 0             | -13 | 9  | 21    |
| Background + Project          | 128            | 64 | 16  | 20            | 628 | 12 | 24             | 77 | 143 | 53            | 364 | 33 | 1562  |
| Cumulative No Project         | 133            | 94 | 112 | 20            | 612 | 24 | 44             | 98 | 141 | 80            | 765 | 79 | 2123  |
| <b>2035 Project Trips</b>     |                |    |     |               |     |    |                |    |     |               |     |    |       |
| BART                          | -1             | 0  | -1  | 0             | -15 | 0  | -1             | 0  | 1   | 1             | -25 | 5  | -36   |
| Joint Development             | 1              | 0  | 1   | 0             | 32  | 0  | 0              | 0  | 0   | 0             | 15  | 9  | 58    |
| Net 2035 Trips                | 0              | 0  | 0   | 0             | 17  | 0  | -1             | 0  | 1   | 1             | -10 | 14 | 22    |
| Cumulative                    | 133            | 94 | 112 | 20            | 629 | 24 | 43             | 98 | 142 | 81            | 755 | 93 | 2224  |

Intersection Number: 17  
 Traffix Node Number: 3064  
 Intersection Name: King Rd & Alum Rock Ave  
 Peak Hour: AM  
 Count Date: 05/19/15  
 Scenario: BART Extension Phase II  
 Date of Analysis: 09/02/15

| Scenario:                     | Movements      |     |    |               |     |     |                |     |     |               |     |     | Total |
|-------------------------------|----------------|-----|----|---------------|-----|-----|----------------|-----|-----|---------------|-----|-----|-------|
|                               | North Approach |     |    | East Approach |     |     | South Approach |     |     | West Approach |     |     |       |
|                               | RT             | TH  | LT | RT            | TH  | LT  | RT             | TH  | LT  | RT            | TH  | LT  |       |
| Existing Conditions           | 50             | 292 | 45 | 67            | 560 | 81  | 118            | 608 | 173 | 95            | 241 | 49  | 2379  |
| <b>Approved Project Trips</b> |                |     |    |               |     |     |                |     |     |               |     |     |       |
| San Jose ATI                  | 20             | 38  | 5  | 3             | 9   | 27  | 19             | 37  | 7   | 2             | 22  | 16  | 205   |
| Santa Clara ATI               | 0              | 0   | 0  | 0             | 0   | 0   | 0              | 0   | 0   | 0             | 0   | 0   | 0     |
| Total Approved Trips          | 20             | 38  | 5  | 3             | 9   | 27  | 19             | 37  | 7   | 2             | 22  | 16  | 205   |
| Background Conditions         | 70             | 330 | 50 | 70            | 569 | 108 | 137            | 645 | 180 | 97            | 263 | 65  | 2584  |
| <b>2015 Project Trips</b>     |                |     |    |               |     |     |                |     |     |               |     |     |       |
| BART                          | -5             | 0   | 7  | 14            | -6  | -1  | 0              | 10  | 0   | 0             | -2  | 0   | 17    |
| Joint Development             | 17             | 1   | 0  | 2             | 29  | 0   | 0              | 0   | 19  | 2             | 5   | 1   | 76    |
| Net 2015 Trips                | 12             | 1   | 7  | 16            | 23  | -1  | 0              | 10  | 19  | 2             | 3   | 1   | 93    |
| Existing + Project            | 62             | 293 | 52 | 83            | 583 | 80  | 118            | 618 | 192 | 97            | 244 | 50  | 2472  |
| <b>2025 Project Trips</b>     |                |     |    |               |     |     |                |     |     |               |     |     |       |
| BART                          | -20            | -8  | -6 | -18           | -8  | -4  | -1             | -50 | -4  | 0             | -4  | -16 | -139  |
| Joint Development             | 15             | 12  | 0  | 4             | 27  | 5   | 0              | 8   | 10  | 4             | 4   | 0   | 89    |
| Net 2025 Trips                | -5             | 4   | -6 | -14           | 19  | 1   | -1             | -42 | 6   | 4             | 0   | -16 | -50   |
| Background + Project          | 65             | 334 | 44 | 56            | 588 | 109 | 136            | 603 | 186 | 101           | 263 | 49  | 2534  |
| Cumulative No Project         | 70             | 547 | 96 | 70            | 651 | 108 | 137            | 734 | 180 | 217           | 478 | 213 | 3288  |
| <b>2035 Project Trips</b>     |                |     |    |               |     |     |                |     |     |               |     |     |       |
| BART                          | -23            | -11 | -8 | -23           | 8   | -3  | -2             | -57 | 2   | 0             | -4  | -23 | -144  |
| Joint Development             | 8              | 16  | 0  | 9             | 18  | 1   | 0              | 3   | 6   | 13            | 4   | 0   | 78    |
| Net 2035 Trips                | -15            | 5   | -8 | -14           | 26  | -2  | -2             | -54 | 8   | 13            | 0   | -23 | -66   |
| Cumulative                    | 55             | 552 | 88 | 56            | 677 | 106 | 135            | 680 | 188 | 230           | 478 | 190 | 3435  |

Intersection Number: 18  
 Traffix Node Number: 3063  
 Intersection Name: Jackson Ave & Alum Rock Ave  
 Peak Hour: AM  
 Count Date: 05/21/15  
 Scenario: BART Extension Phase II  
 Date of Analysis: 09/02/15

| Scenario:                     | Movements      |     |     |               |     |     |                |     |     |               |     |     | Total |
|-------------------------------|----------------|-----|-----|---------------|-----|-----|----------------|-----|-----|---------------|-----|-----|-------|
|                               | North Approach |     |     | East Approach |     |     | South Approach |     |     | West Approach |     |     |       |
|                               | RT             | TH  | LT  | RT            | TH  | LT  | RT             | TH  | LT  | RT            | TH  | LT  |       |
| Existing Conditions           | 59             | 425 | 90  | 187           | 359 | 172 | 261            | 751 | 92  | 112           | 360 | 87  | 2955  |
| <b>Approved Project Trips</b> |                |     |     |               |     |     |                |     |     |               |     |     |       |
| San Jose ATI                  | 12             | 119 | 17  | 23            | 9   | 59  | 57             | 113 | 127 | 138           | 8   | 13  | 695   |
| Santa Clara ATI               | 0              | 0   | 0   | 0             | 0   | 0   | 0              | 0   | 0   | 0             | 0   | 0   | 0     |
| Total Approved Trips          | 12             | 119 | 17  | 23            | 9   | 59  | 57             | 113 | 127 | 138           | 8   | 13  | 695   |
| Background Conditions         | 71             | 544 | 107 | 210           | 368 | 231 | 318            | 864 | 219 | 250           | 368 | 100 | 3650  |
| <b>2015 Project Trips</b>     |                |     |     |               |     |     |                |     |     |               |     |     |       |
| BART                          | 0              | 0   | 0   | 1             | -6  | -2  | -7             | 6   | 13  | 5             | -3  | 0   | 7     |
| Joint Development             | 1              | 0   | 0   | 3             | 12  | 0   | 0              | 0   | 14  | 0             | 4   | 0   | 34    |
| Net 2015 Trips                | 1              | 0   | 0   | 4             | 6   | -2  | -7             | 6   | 27  | 5             | 1   | 0   | 41    |
| Existing + Project            | 60             | 425 | 90  | 191           | 365 | 170 | 254            | 757 | 119 | 117           | 361 | 87  | 2996  |
| <b>2025 Project Trips</b>     |                |     |     |               |     |     |                |     |     |               |     |     |       |
| BART                          | -1             | -2  | 0   | -3            | -5  | -1  | -6             | -7  | -12 | -6            | -2  | 0   | -45   |
| Joint Development             | 1              | 0   | 0   | 4             | 14  | 0   | 0              | 0   | 17  | 0             | 2   | 0   | 38    |
| Net 2025 Trips                | 0              | -2  | 0   | 1             | 9   | -1  | -6             | -7  | 5   | -6            | 0   | 0   | -7    |
| Background + Project          | 71             | 542 | 107 | 211           | 377 | 230 | 312            | 857 | 224 | 244           | 368 | 100 | 3643  |
| Cumulative No Project         | 71             | 603 | 107 | 271           | 368 | 699 | 340            | 864 | 357 | 250           | 594 | 157 | 4524  |
| <b>2035 Project Trips</b>     |                |     |     |               |     |     |                |     |     |               |     |     |       |
| BART                          | 0              | -2  | 0   | 0             | -3  | -1  | -1             | -3  | -9  | -11           | -4  | 0   | -34   |
| Joint Development             | 1              | 0   | 0   | 5             | 10  | 1   | 0              | 0   | 12  | 1             | 2   | 0   | 32    |
| Net 2035 Trips                | 1              | -2  | 0   | 5             | 7   | 0   | -1             | -3  | 3   | -10           | -2  | 0   | -2    |
| Cumulative                    | 72             | 601 | 107 | 276           | 375 | 699 | 339            | 861 | 360 | 240           | 592 | 157 | 4679  |

Intersection Number: **19**  
 Trafix Node Number: 3043  
 Intersection Name: I-680 S & Alum Rock Ave (West)  
 Peak Hour: AM  
 Count Date: 05/21/15  
 Scenario: BART Extension Phase II  
 Date of Analysis: 09/02/15

| Scenario:                     | Movements      |    |     |               |     |    |                |    |    |               |     |    | Total |
|-------------------------------|----------------|----|-----|---------------|-----|----|----------------|----|----|---------------|-----|----|-------|
|                               | North Approach |    |     | East Approach |     |    | South Approach |    |    | West Approach |     |    |       |
|                               | RT             | TH | LT  | RT            | TH  | LT | RT             | TH | LT | RT            | TH  | LT |       |
| Existing Conditions           | 151            | 8  | 168 | 0             | 615 | 32 | 22             | 0  | 30 | 13            | 704 | 0  | 1743  |
| <b>Approved Project Trips</b> |                |    |     |               |     |    |                |    |    |               |     |    |       |
| San Jose ATI                  | 8              | 0  | 0   | 0             | 54  | 0  | 0              | 0  | 0  | 0             | 63  | 0  | 125   |
| Santa Clara ATI               | 0              | 0  | 0   | 0             | 0   | 0  | 0              | 0  | 0  | 0             | 0   | 0  | 0     |
| Total Approved Trips          | 8              | 0  | 0   | 0             | 54  | 0  | 0              | 0  | 0  | 0             | 63  | 0  | 125   |
| Background Conditions         | 159            | 8  | 168 | 0             | 669 | 32 | 22             | 0  | 30 | 13            | 767 | 0  | 1868  |
| <b>2015 Project Trips</b>     |                |    |     |               |     |    |                |    |    |               |     |    |       |
| BART                          | -9             | 0  | -1  | 0             | 2   | 0  | 0              | 0  | 0  | 0             | -11 | 0  | -19   |
| Joint Development             | 5              | 0  | 0   | 0             | 10  | 0  | 0              | 0  | 0  | 0             | 3   | 0  | 18    |
| Net 2015 Trips                | -4             | 0  | -1  | 0             | 12  | 0  | 0              | 0  | 0  | 0             | -8  | 0  | -1    |
| Existing + Project            | 147            | 8  | 167 | 0             | 627 | 32 | 22             | 0  | 30 | 13            | 696 | 0  | 1742  |
| <b>2025 Project Trips</b>     |                |    |     |               |     |    |                |    |    |               |     |    |       |
| BART                          | -3             | 0  | 0   | 0             | -6  | 0  | 0              | 0  | 0  | 0             | -9  | 0  | -18   |
| Joint Development             | 4              | 0  | 0   | 0             | 12  | 0  | 0              | 0  | 0  | 0             | 2   | 0  | 18    |
| Net 2025 Trips                | 1              | 0  | 0   | 0             | 6   | 0  | 0              | 0  | 0  | 0             | -7  | 0  | 0     |
| Background + Project          | 160            | 8  | 168 | 0             | 675 | 32 | 22             | 0  | 30 | 13            | 760 | 0  | 1868  |
| Cumulative No Project         | 451            | 16 | 219 | 0             | 669 | 32 | 31             | 0  | 45 | 50            | 993 | 0  | 2506  |
| <b>2035 Project Trips</b>     |                |    |     |               |     |    |                |    |    |               |     |    |       |
| BART                          | -4             | 0  | 0   | 0             | 0   | 0  | 0              | 0  | 0  | 0             | -5  | 0  | -9    |
| Joint Development             | 3              | 0  | 0   | 0             | 12  | 0  | 0              | 0  | 0  | 0             | 2   | 0  | 17    |
| Net 2035 Trips                | -1             | 0  | 0   | 0             | 12  | 0  | 0              | 0  | 0  | 0             | -3  | 0  | 8     |
| Cumulative                    | 450            | 16 | 219 | 0             | 681 | 32 | 31             | 0  | 45 | 50            | 990 | 0  | 2514  |

Intersection Number: **20**  
 Trafix Node Number: 3042  
 Intersection Name: I-680 N & Alum Rock Ave (East)  
 Peak Hour: AM  
 Count Date: 05/21/15  
 Scenario: BART Extension Phase II  
 Date of Analysis: 09/02/15

| Scenario:                     | Movements      |    |    |               |      |    |                |    |     |               |     |    | Total |
|-------------------------------|----------------|----|----|---------------|------|----|----------------|----|-----|---------------|-----|----|-------|
|                               | North Approach |    |    | East Approach |      |    | South Approach |    |     | West Approach |     |    |       |
|                               | RT             | TH | LT | RT            | TH   | LT | RT             | TH | LT  | RT            | TH  | LT |       |
| Existing Conditions           | 0              | 0  | 0  | 663           | 1458 | 0  | 591            | 0  | 191 | 335           | 563 | 0  | 3801  |
| <b>Approved Project Trips</b> |                |    |    |               |      |    |                |    |     |               |     |    |       |
| San Jose ATI                  | 0              | 0  | 0  | 3             | 61   | 0  | 9              | 0  | 3   | 26            | 43  | 0  | 145   |
| Santa Clara ATI               | 0              | 0  | 0  | 0             | 0    | 0  | 0              | 0  | 0   | 0             | 0   | 0  | 0     |
| Total Approved Trips          | 0              | 0  | 0  | 3             | 61   | 0  | 9              | 0  | 3   | 26            | 43  | 0  | 145   |
| Background Conditions         | 0              | 0  | 0  | 666           | 1519 | 0  | 600            | 0  | 194 | 361           | 606 | 0  | 3946  |
| <b>2015 Project Trips</b>     |                |    |    |               |      |    |                |    |     |               |     |    |       |
| BART                          | 0              | 0  | 0  | 0             | -4   | 0  | 0              | 0  | -1  | 0             | -1  | 0  | -6    |
| Joint Development             | 0              | 0  | 0  | 0             | 11   | 0  | 0              | 0  | 0   | 0             | 2   | 0  | 13    |
| Net 2015 Trips                | 0              | 0  | 0  | 0             | 7    | 0  | 0              | 0  | -1  | 0             | 1   | 0  | 7     |
| Existing + Project            | 0              | 0  | 0  | 663           | 1465 | 0  | 591            | 0  | 190 | 335           | 564 | 0  | 3808  |
| <b>2025 Project Trips</b>     |                |    |    |               |      |    |                |    |     |               |     |    |       |
| BART                          | 0              | 0  | 0  | 0             | -21  | 0  | -5             | 0  | -2  | 0             | -2  | 0  | -30   |
| Joint Development             | 0              | 0  | 0  | 0             | 14   | 0  | 0              | 0  | 0   | 0             | 2   | 0  | 16    |
| Net 2025 Trips                | 0              | 0  | 0  | 0             | -7   | 0  | -5             | 0  | -2  | 0             | 0   | 0  | -14   |
| Background + Project          | 0              | 0  | 0  | 666           | 1512 | 0  | 595            | 0  | 192 | 361           | 606 | 0  | 3932  |
| Cumulative No Project         | 0              | 0  | 0  | 666           | 1601 | 0  | 600            | 0  | 194 | 361           | 766 | 0  | 4188  |
| <b>2035 Project Trips</b>     |                |    |    |               |      |    |                |    |     |               |     |    |       |
| BART                          | 0              | 0  | 0  | 0             | -13  | 0  | -4             | 0  | 0   | 0             | -3  | 0  | -20   |
| Joint Development             | 0              | 0  | 0  | 0             | 13   | 0  | 0              | 0  | 0   | 0             | 2   | 0  | 15    |
| Net 2035 Trips                | 0              | 0  | 0  | 0             | 0    | 0  | -4             | 0  | 0   | 0             | -1  | 0  | -5    |
| Cumulative                    | 0              | 0  | 0  | 666           | 1601 | 0  | 596            | 0  | 194 | 361           | 765 | 0  | 4183  |

Intersection Number: **21**  
 Traffic Node Number: 3762  
 Intersection Name: 24th St & San Antonio St  
 Peak Hour: AM  
 Count Date: 10/09/14  
 Scenario: BART Extension Phase II  
 Date of Analysis: 09/02/15

| Scenario:                     | Movements      |     |    |               |     |     |                |     |     |               |    |    | Total |
|-------------------------------|----------------|-----|----|---------------|-----|-----|----------------|-----|-----|---------------|----|----|-------|
|                               | North Approach |     |    | East Approach |     |     | South Approach |     |     | West Approach |    |    |       |
|                               | RT             | TH  | LT | RT            | TH  | LT  | RT             | TH  | LT  | RT            | TH | LT |       |
| Existing Conditions           | 27             | 146 | 9  | 36            | 253 | 117 | 110            | 438 | 65  | 22            | 89 | 5  | 1317  |
| <b>Approved Project Trips</b> |                |     |    |               |     |     |                |     |     |               |    |    |       |
| San Jose ATI                  | 0              | 3   | 0  | 0             | 0   | 0   | 1              | 10  | 0   | 0             | 0  | 0  | 14    |
| Santa Clara ATI               | 0              | 0   | 0  | 0             | 0   | 0   | 0              | 0   | 0   | 0             | 0  | 0  | 0     |
| Total Approved Trips          | 0              | 3   | 0  | 0             | 0   | 0   | 1              | 10  | 0   | 0             | 0  | 0  | 14    |
| Background Conditions         | 27             | 149 | 9  | 36            | 253 | 117 | 111            | 448 | 65  | 22            | 89 | 5  | 1331  |
| <b>2015 Project Trips</b>     |                |     |    |               |     |     |                |     |     |               |    |    |       |
| BART                          | -2             | -2  | 0  | -1            | 0   | 0   | 2              | 24  | 0   | 0             | 0  | 1  | 22    |
| Joint Development             | 2              | 1   | 0  | 4             | 3   | 0   | 1              | 47  | 0   | 0             | 0  | 1  | 59    |
| Net 2015 Trips                | 0              | -1  | 0  | 3             | 3   | 0   | 3              | 71  | 0   | 0             | 0  | 2  | 81    |
| Existing + Project            | 27             | 145 | 9  | 39            | 256 | 117 | 113            | 509 | 65  | 22            | 89 | 7  | 1398  |
| <b>2025 Project Trips</b>     |                |     |    |               |     |     |                |     |     |               |    |    |       |
| BART                          | -3             | -3  | 0  | -3            | -3  | 0   | 0              | 25  | -3  | 0             | 0  | 0  | 10    |
| Joint Development             | 1              | 2   | 0  | 4             | 4   | 0   | 7              | 26  | 0   | 0             | 0  | 1  | 45    |
| Net 2025 Trips                | -2             | -1  | 0  | 1             | 1   | 0   | 7              | 51  | -3  | 0             | 0  | 1  | 55    |
| Background + Project          | 25             | 148 | 9  | 37            | 254 | 117 | 118            | 499 | 62  | 22            | 89 | 6  | 1386  |
| Cumulative No Project         | 27             | 255 | 12 | 36            | 410 | 219 | 133            | 448 | 234 | 27            | 93 | 67 | 1894  |
| <b>2035 Project Trips</b>     |                |     |    |               |     |     |                |     |     |               |    |    |       |
| BART                          | -2             | -6  | 0  | -1            | -7  | 0   | 0              | 38  | -2  | 0             | 0  | 1  | 21    |
| Joint Development             | 0              | 0   | 0  | 5             | 3   | 2   | 3              | 27  | 0   | 0             | 0  | 2  | 42    |
| Net 2035 Trips                | -2             | -6  | 0  | 4             | -4  | 2   | 3              | 65  | -2  | 0             | 0  | 3  | 63    |
| Cumulative                    | 25             | 249 | 12 | 40            | 406 | 221 | 136            | 513 | 232 | 27            | 93 | 70 | 2024  |

Intersection Number: **22**  
 Traffic Node Number: 3627  
 Intersection Name: King Rd & E. San Antonio St.  
 Peak Hour: AM  
 Count Date: 05/21/15  
 Scenario: BART Extension Phase II  
 Date of Analysis: 09/02/15

| Scenario:                     | Movements      |     |     |               |     |     |                |     |     |               |     |    | Total |
|-------------------------------|----------------|-----|-----|---------------|-----|-----|----------------|-----|-----|---------------|-----|----|-------|
|                               | North Approach |     |     | East Approach |     |     | South Approach |     |     | West Approach |     |    |       |
|                               | RT             | TH  | LT  | RT            | TH  | LT  | RT             | TH  | LT  | RT            | TH  | LT |       |
| Existing Conditions           | 61             | 339 | 136 | 116           | 232 | 122 | 149            | 635 | 133 | 129           | 192 | 53 | 2297  |
| <b>Approved Project Trips</b> |                |     |     |               |     |     |                |     |     |               |     |    |       |
| San Jose ATI                  | 1              | 53  | 2   | 2             | 1   | 0   | 0              | 53  | 1   | 0             | 2   | 2  | 117   |
| Santa Clara ATI               | 0              | 0   | 0   | 0             | 0   | 0   | 0              | 0   | 0   | 0             | 0   | 0  | 0     |
| Total Approved Trips          | 1              | 53  | 2   | 2             | 1   | 0   | 0              | 53  | 1   | 0             | 2   | 2  | 117   |
| Background Conditions         | 62             | 392 | 138 | 118           | 233 | 122 | 149            | 688 | 134 | 129           | 194 | 55 | 2414  |
| <b>2015 Project Trips</b>     |                |     |     |               |     |     |                |     |     |               |     |    |       |
| BART                          | -2             | 0   | 0   | 0             | 0   | 0   | 0              | 10  | 1   | 0             | 0   | 0  | 9     |
| Joint Development             | 1              | 2   | 0   | 0             | 1   | 0   | 0              | 19  | 17  | 0             | 0   | 0  | 40    |
| Net 2015 Trips                | -1             | 2   | 0   | 0             | 1   | 0   | 0              | 29  | 18  | 0             | 0   | 0  | 49    |
| Existing + Project            | 60             | 341 | 136 | 116           | 233 | 122 | 149            | 664 | 151 | 129           | 192 | 53 | 2346  |
| <b>2025 Project Trips</b>     |                |     |     |               |     |     |                |     |     |               |     |    |       |
| BART                          | -1             | -10 | 0   | 0             | -1  | -4  | -1             | -54 | -2  | -2            | 0   | 0  | -75   |
| Joint Development             | 18             | 5   | 0   | 0             | 8   | 0   | 0              | 17  | 23  | 0             | 0   | 0  | 71    |
| Net 2025 Trips                | 17             | -5  | 0   | 0             | 7   | -4  | -1             | -37 | 21  | -2            | 0   | 0  | -4    |
| Background + Project          | 79             | 387 | 138 | 118           | 240 | 118 | 148            | 651 | 155 | 127           | 194 | 55 | 2410  |
| Cumulative No Project         | 92             | 578 | 138 | 154           | 233 | 122 | 149            | 688 | 141 | 157           | 219 | 78 | 2671  |
| <b>2035 Project Trips</b>     |                |     |     |               |     |     |                |     |     |               |     |    |       |
| BART                          | -1             | -12 | 0   | 0             | 5   | -3  | -2             | -59 | -1  | -2            | 0   | 0  | -75   |
| Joint Development             | 26             | 2   | 0   | 0             | 2   | 0   | 0              | 10  | 20  | 0             | 0   | 0  | 60    |
| Net 2035 Trips                | 25             | -10 | 0   | 0             | 7   | -3  | -2             | -49 | 19  | -2            | 0   | 0  | -15   |
| Cumulative                    | 117            | 568 | 138 | 154           | 240 | 119 | 147            | 639 | 160 | 155           | 219 | 78 | 2734  |

Intersection Number: **23**  
 Trafix Node Number: 3384  
 Intersection Name: Jackson Ave & E. San Antonio St/Capitol Expy  
 Peak Hour: AM  
 Count Date: 05/21/15  
 Scenario: BART Extension Phase II  
 Date of Analysis: 09/02/15

| Scenario:                     | Movements      |     |     |               |     |     |                |     |     |               |     |     | Total |
|-------------------------------|----------------|-----|-----|---------------|-----|-----|----------------|-----|-----|---------------|-----|-----|-------|
|                               | North Approach |     |     | East Approach |     |     | South Approach |     |     | West Approach |     |     |       |
|                               | RT             | TH  | LT  | RT            | TH  | LT  | RT             | TH  | LT  | RT            | TH  | LT  |       |
| Existing Conditions           | 157            | 488 | 190 | 418           | 317 | 96  | 42             | 647 | 179 | 254           | 230 | 143 | 3161  |
| <b>Approved Project Trips</b> |                |     |     |               |     |     |                |     |     |               |     |     |       |
| San Jose ATI                  | 25             | 76  | 66  | 80            | 8   | 0   | 0              | 70  | 0   | 1             | 5   | 43  | 374   |
| Santa Clara ATI               | 0              | 0   | 0   | 0             | 0   | 0   | 0              | 0   | 0   | 0             | 0   | 0   | 0     |
| Total Approved Trips          | 25             | 76  | 66  | 80            | 8   | 0   | 0              | 70  | 0   | 1             | 5   | 43  | 374   |
| Background Conditions         | 182            | 564 | 256 | 498           | 325 | 96  | 42             | 717 | 179 | 255           | 235 | 186 | 3535  |
| <b>2015 Project Trips</b>     |                |     |     |               |     |     |                |     |     |               |     |     |       |
| BART                          | 0              | -2  | 5   | 8             | 0   | 0   | 0              | 3   | 0   | 0             | 0   | 0   | 14    |
| Joint Development             | 0              | 1   | 0   | 6             | 0   | 4   | 0              | 7   | 0   | 0             | 0   | 0   | 18    |
| Net 2015 Trips                | 0              | -1  | 5   | 14            | 0   | 4   | 0              | 10  | 0   | 0             | 0   | 0   | 32    |
| Existing + Project            | 157            | 487 | 195 | 432           | 317 | 100 | 42             | 657 | 179 | 254           | 230 | 143 | 3193  |
| <b>2025 Project Trips</b>     |                |     |     |               |     |     |                |     |     |               |     |     |       |
| BART                          | 0              | -6  | -8  | -10           | 0   | -2  | 0              | -17 | 1   | 0             | 0   | 0   | -42   |
| Joint Development             | 0              | 1   | 0   | 9             | 2   | 0   | 0              | 7   | 5   | 0             | 0   | 0   | 24    |
| Net 2025 Trips                | 0              | -5  | -8  | -1            | 2   | -2  | 0              | -10 | 6   | 0             | 0   | 0   | -18   |
| Background + Project          | 182            | 559 | 248 | 497           | 327 | 94  | 42             | 707 | 185 | 255           | 235 | 186 | 3517  |
| Cumulative No Project         | 211            | 815 | 639 | 717           | 325 | 96  | 358            | 717 | 207 | 323           | 245 | 186 | 4653  |
| <b>2035 Project Trips</b>     |                |     |     |               |     |     |                |     |     |               |     |     |       |
| BART                          | 0              | -5  | -10 | -8            | 2   | 0   | 0              | -6  | 4   | 0             | 0   | 0   | -23   |
| Joint Development             | 0              | 1   | 0   | 8             | 0   | 0   | 0              | 4   | 0   | 0             | 0   | 0   | 13    |
| Net 2035 Trips                | 0              | -4  | -10 | 0             | 2   | 0   | 0              | -2  | 4   | 0             | 0   | 0   | -10   |
| Cumulative                    | 211            | 811 | 629 | 717           | 327 | 96  | 358            | 715 | 211 | 323           | 245 | 186 | 4829  |

Intersection Number: **24**  
 Trafix Node Number: 3832  
 Intersection Name: 24th St & E. William St.  
 Peak Hour: AM  
 Count Date: 10/09/14  
 Scenario: BART Extension Phase II  
 Date of Analysis: 09/02/15

| Scenario:                     | Movements      |     |    |               |     |    |                |     |     |               |    |    | Total |
|-------------------------------|----------------|-----|----|---------------|-----|----|----------------|-----|-----|---------------|----|----|-------|
|                               | North Approach |     |    | East Approach |     |    | South Approach |     |     | West Approach |    |    |       |
|                               | RT             | TH  | LT | RT            | TH  | LT | RT             | TH  | LT  | RT            | TH | LT |       |
| Existing Conditions           | 49             | 273 | 3  | 5             | 34  | 45 | 38             | 566 | 112 | 123           | 22 | 51 | 1321  |
| <b>Approved Project Trips</b> |                |     |    |               |     |    |                |     |     |               |    |    |       |
| San Jose ATI                  | 0              | 2   | 0  | 0             | 2   | 5  | 0              | 5   | 1   | 0             | 0  | 0  | 15    |
| Santa Clara ATI               | 0              | 0   | 0  | 0             | 0   | 0  | 0              | 0   | 0   | 0             | 0  | 0  | 0     |
| Total Approved Trips          | 0              | 2   | 0  | 0             | 2   | 5  | 0              | 5   | 1   | 0             | 0  | 0  | 15    |
| Background Conditions         | 49             | 275 | 3  | 5             | 36  | 50 | 38             | 571 | 113 | 123           | 22 | 51 | 1336  |
| <b>2015 Project Trips</b>     |                |     |    |               |     |    |                |     |     |               |    |    |       |
| BART                          | 0              | -1  | 0  | -5            | 0   | -2 | -1             | 30  | 0   | 0             | 0  | 0  | 21    |
| Joint Development             | 0              | 2   | 0  | 0             | 0   | 0  | 0              | 46  | 0   | 0             | 0  | 0  | 48    |
| Net 2015 Trips                | 0              | 1   | 0  | -5            | 0   | -2 | -1             | 76  | 0   | 0             | 0  | 0  | 69    |
| Existing + Project            | 49             | 274 | 3  | 0             | 34  | 43 | 37             | 642 | 112 | 123           | 22 | 51 | 1390  |
| <b>2025 Project Trips</b>     |                |     |    |               |     |    |                |     |     |               |    |    |       |
| BART                          | -1             | -2  | -1 | -5            | -1  | -4 | -3             | 28  | 0   | 0             | -1 | 0  | 10    |
| Joint Development             | 2              | 2   | 0  | 0             | 0   | 0  | 0              | 33  | 0   | 0             | 0  | 0  | 37    |
| Net 2025 Trips                | 1              | 0   | -1 | -5            | -1  | -4 | -3             | 61  | 0   | 0             | -1 | 0  | 47    |
| Background + Project          | 50             | 275 | 2  | 0             | 35  | 46 | 35             | 632 | 113 | 123           | 21 | 51 | 1383  |
| Cumulative No Project         | 121            | 370 | 50 | 37            | 138 | 50 | 38             | 583 | 187 | 139           | 65 | 51 | 1778  |
| <b>2035 Project Trips</b>     |                |     |    |               |     |    |                |     |     |               |    |    |       |
| BART                          | -2             | -4  | -2 | -6            | -3  | -4 | -1             | 43  | 0   | 0             | -1 | 0  | 20    |
| Joint Development             | 2              | 0   | 0  | 0             | 0   | 0  | 0              | 30  | 0   | 0             | 0  | 0  | 32    |
| Net 2035 Trips                | 0              | -4  | -2 | -6            | -3  | -4 | -1             | 73  | 0   | 0             | -1 | 0  | 52    |
| Cumulative                    | 121            | 366 | 48 | 31            | 135 | 46 | 37             | 656 | 187 | 139           | 64 | 51 | 1881  |



Intersection Number: **25**  
 Trafix Node Number: 3036  
 Intersection Name: McLaughlin Ave & I-280 SB Ramp  
 Peak Hour: AM  
 Count Date: 10/09/14  
 Scenario: BART Extension Phase II  
 Date of Analysis: 09/02/15

| Scenario:                     | Movements      |     |    |               |    |    |                |      |    |               |    |     | Total |
|-------------------------------|----------------|-----|----|---------------|----|----|----------------|------|----|---------------|----|-----|-------|
|                               | North Approach |     |    | East Approach |    |    | South Approach |      |    | West Approach |    |     |       |
|                               | RT             | TH  | LT | RT            | TH | LT | RT             | TH   | LT | RT            | TH | LT  |       |
| Existing Conditions           | 0              | 542 | 0  | 0             | 0  | 0  | 0              | 1453 | 0  | 234           | 0  | 193 | 2422  |
| <b>Approved Project Trips</b> |                |     |    |               |    |    |                |      |    |               |    |     |       |
| San Jose ATI                  | 0              | 20  | 0  | 0             | 0  | 0  | 0              | 49   | 0  | 37            | 0  | 6   | 112   |
| Santa Clara ATI               | 0              | 0   | 0  | 0             | 0  | 0  | 0              | 0    | 0  | 0             | 0  | 0   | 0     |
| Total Approved Trips          | 0              | 20  | 0  | 0             | 0  | 0  | 0              | 49   | 0  | 37            | 0  | 6   | 112   |
| Background Conditions         | 0              | 562 | 0  | 0             | 0  | 0  | 0              | 1502 | 0  | 271           | 0  | 199 | 2534  |
| <b>2015 Project Trips</b>     |                |     |    |               |    |    |                |      |    |               |    |     |       |
| BART                          | 0              | 0   | 0  | 0             | 0  | 0  | 0              | 14   | 0  | -1            | 0  | 11  | 24    |
| Joint Development             | 0              | 0   | 0  | 0             | 0  | 0  | 0              | 28   | 0  | 0             | 0  | 16  | 44    |
| Net 2015 Trips                | 0              | 0   | 0  | 0             | 0  | 0  | 0              | 42   | 0  | -1            | 0  | 27  | 68    |
| Existing + Project            | 0              | 542 | 0  | 0             | 0  | 0  | 0              | 1495 | 0  | 233           | 0  | 220 | 2490  |
| <b>2025 Project Trips</b>     |                |     |    |               |    |    |                |      |    |               |    |     |       |
| BART                          | 0              | -1  | 0  | 0             | 0  | 0  | 0              | -4   | 0  | -3            | 0  | 6   | -2    |
| Joint Development             | 0              | 0   | 0  | 0             | 0  | 0  | 0              | 22   | 0  | 0             | 0  | 10  | 32    |
| Net 2025 Trips                | 0              | -1  | 0  | 0             | 0  | 0  | 0              | 18   | 0  | -3            | 0  | 16  | 30    |
| Background + Project          | 0              | 561 | 0  | 0             | 0  | 0  | 0              | 1520 | 0  | 268           | 0  | 215 | 2564  |
| Cumulative No Project         | 0              | 587 | 0  | 0             | 0  | 0  | 0              | 1508 | 0  | 271           | 0  | 199 | 2366  |
| <b>2035 Project Trips</b>     |                |     |    |               |    |    |                |      |    |               |    |     |       |
| BART                          | 0              | -1  | 0  | 0             | 0  | 0  | 0              | 27   | 0  | -3            | 0  | 6   | 29    |
| Joint Development             | 0              | 0   | 0  | 0             | 0  | 0  | 0              | 21   | 0  | 0             | 0  | 10  | 31    |
| Net 2035 Trips                | 0              | -1  | 0  | 0             | 0  | 0  | 0              | 48   | 0  | -3            | 0  | 16  | 60    |
| Cumulative                    | 0              | 586 | 0  | 0             | 0  | 0  | 0              | 1556 | 0  | 268           | 0  | 215 | 2625  |

Intersection Number: **26**  
 Trafix Node Number: 3683  
 Intersection Name: McLaughlin Ave & Story Rd  
 Peak Hour: AM  
 Count Date: 10/09/14  
 Scenario: BART Extension Phase II  
 Date of Analysis: 09/02/15

| Scenario:                     | Movements      |     |     |               |      |     |                |      |     |               |     |     | Total |
|-------------------------------|----------------|-----|-----|---------------|------|-----|----------------|------|-----|---------------|-----|-----|-------|
|                               | North Approach |     |     | East Approach |      |     | South Approach |      |     | West Approach |     |     |       |
|                               | RT             | TH  | LT  | RT            | TH   | LT  | RT             | TH   | LT  | RT            | TH  | LT  |       |
| Existing Conditions           | 229            | 359 | 159 | 318           | 1229 | 240 | 189            | 843  | 165 | 44            | 666 | 325 | 4766  |
| <b>Approved Project Trips</b> |                |     |     |               |      |     |                |      |     |               |     |     |       |
| San Jose ATI                  | 55             | 0   | 0   | 1             | 191  | 0   | 0              | 5    | 32  | 24            | 126 | 37  | 471   |
| Santa Clara ATI               | 0              | 0   | 0   | 0             | 0    | 0   | 0              | 0    | 0   | 0             | 0   | 0   | 0     |
| Total Approved Trips          | 55             | 0   | 0   | 1             | 191  | 0   | 0              | 5    | 32  | 24            | 126 | 37  | 471   |
| Background Conditions         | 284            | 359 | 159 | 319           | 1420 | 240 | 189            | 848  | 197 | 68            | 792 | 362 | 5237  |
| <b>2015 Project Trips</b>     |                |     |     |               |      |     |                |      |     |               |     |     |       |
| BART                          | 0              | 0   | 0   | -1            | -2   | 0   | -6             | 9    | 0   | 0             | 0   | 6   | 6     |
| Joint Development             | 0              | 0   | 0   | 4             | 4    | 2   | 5              | 9    | 0   | 0             | 4   | 13  | 41    |
| Net 2015 Trips                | 0              | 0   | 0   | 3             | 2    | 2   | -1             | 18   | 0   | 0             | 4   | 19  | 47    |
| Existing + Project            | 229            | 359 | 159 | 321           | 1231 | 242 | 188            | 861  | 165 | 44            | 670 | 344 | 4813  |
| <b>2025 Project Trips</b>     |                |     |     |               |      |     |                |      |     |               |     |     |       |
| BART                          | 0              | -2  | 0   | -12           | -24  | -3  | -12            | -3   | -3  | 0             | -5  | 11  | -53   |
| Joint Development             | 0              | 0   | 0   | 5             | 6    | 1   | 5              | 9    | 0   | 0             | 7   | 6   | 39    |
| Net 2025 Trips                | 0              | -2  | 0   | -7            | -18  | -2  | -7             | 6    | -3  | 0             | 2   | 17  | -14   |
| Background + Project          | 284            | 357 | 159 | 312           | 1402 | 238 | 182            | 854  | 194 | 68            | 794 | 379 | 5223  |
| Cumulative No Project         | 284            | 359 | 271 | 319           | 1878 | 259 | 189            | 1003 | 197 | 72            | 985 | 463 | 5816  |
| <b>2035 Project Trips</b>     |                |     |     |               |      |     |                |      |     |               |     |     |       |
| BART                          | -1             | -2  | -1  | -4            | -19  | -1  | -15            | 16   | -2  | 0             | -3  | 17  | -15   |
| Joint Development             | 0              | 0   | 0   | 1             | 5    | 1   | 3              | 10   | 0   | 0             | 4   | 8   | 32    |
| Net 2035 Trips                | -1             | -2  | -1  | -3            | -14  | 0   | -12            | 26   | -2  | 0             | 1   | 25  | 17    |
| Cumulative                    | 283            | 357 | 270 | 316           | 1864 | 259 | 177            | 1029 | 195 | 72            | 986 | 488 | 6296  |

Intersection Number: 27  
 Traffic Node Number: 3623  
 Intersection Name: King Rd & Mabury Rd  
 Peak Hour: AM  
 Count Date: 10/08/14  
 Scenario: BART Extension Phase II  
 Date of Analysis: 09/02/15

| Scenario:                     | Movements      |     |     |               |     |     |                |     |      |               |     |     | Total |
|-------------------------------|----------------|-----|-----|---------------|-----|-----|----------------|-----|------|---------------|-----|-----|-------|
|                               | North Approach |     |     | East Approach |     |     | South Approach |     |      | West Approach |     |     |       |
|                               | RT             | TH  | LT  | RT            | TH  | LT  | RT             | TH  | LT   | RT            | TH  | LT  |       |
| Existing Conditions           | 120            | 240 | 147 | 344           | 628 | 112 | 94             | 630 | 268  | 78            | 157 | 79  | 2897  |
| <b>Approved Project Trips</b> |                |     |     |               |     |     |                |     |      |               |     |     |       |
| San Jose ATI                  | 31             | 236 | 25  | 21            | 35  | 9   | 16             | 290 | 160  | 125           | 43  | 43  | 1034  |
| Santa Clara ATI               | 0              | 0   | 0   | 0             | 0   | 0   | 0              | 0   | 0    | 0             | 0   | 0   | 0     |
| Total Approved Trips          | 31             | 236 | 25  | 21            | 35  | 9   | 16             | 290 | 160  | 125           | 43  | 43  | 1034  |
| Background Conditions         | 151            | 476 | 172 | 365           | 663 | 121 | 110            | 920 | 428  | 203           | 200 | 122 | 3931  |
| <b>2015 Project Trips</b>     |                |     |     |               |     |     |                |     |      |               |     |     |       |
| BART                          | 0              | -7  | 0   | -1            | 42  | 0   | 0              | -12 | 22   | 11            | 2   | -5  | 52    |
| Joint Development             | 3              | 13  | 0   | 0             | 3   | 5   | 0              | 11  | 1    | 0             | 1   | 0   | 37    |
| Net 2015 Trips                | 3              | 6   | 0   | -1            | 45  | 5   | 0              | -1  | 23   | 11            | 3   | -5  | 89    |
| Existing + Project            | 123            | 246 | 147 | 343           | 673 | 117 | 94             | 629 | 291  | 89            | 160 | 74  | 2986  |
| <b>2025 Project Trips</b>     |                |     |     |               |     |     |                |     |      |               |     |     |       |
| BART                          | -11            | -22 | 0   | -1            | -24 | -1  | 0              | -23 | -146 | -21           | -2  | -6  | -257  |
| Joint Development             | 2              | 18  | 0   | 0             | 4   | 1   | 0              | 15  | 3    | 5             | 2   | 0   | 50    |
| Net 2025 Trips                | -9             | -4  | 0   | -1            | -20 | 0   | 0              | -8  | -143 | -16           | 0   | -6  | -207  |
| Background + Project          | 142            | 472 | 172 | 364           | 643 | 121 | 110            | 912 | 285  | 187           | 200 | 116 | 3724  |
| Cumulative No Project         | 787            | 528 | 172 | 368           | 663 | 121 | 110            | 920 | 428  | 526           | 294 | 191 | 4917  |
| <b>2035 Project Trips</b>     |                |     |     |               |     |     |                |     |      |               |     |     |       |
| BART                          | 0              | -36 | 0   | 0             | -23 | -1  | 0              | -23 | -167 | -38           | -2  | -5  | -295  |
| Joint Development             | 5              | 10  | 0   | 0             | 2   | 0   | 0              | 9   | 3    | 4             | 1   | 0   | 34    |
| Net 2035 Trips                | 5              | -26 | 0   | 0             | -21 | -1  | 0              | -14 | -164 | -34           | -1  | -5  | -261  |
| Cumulative                    | 792            | 502 | 172 | 368           | 642 | 120 | 110            | 906 | 264  | 492           | 293 | 186 | 4847  |

Intersection Number: 28  
 Traffic Node Number: 5332  
 Intersection Name: Scott Blvd & Central Expy  
 Peak Hour: AM  
 Count Date: 05/21/15  
 Scenario: BART Extension Phase II  
 Date of Analysis: 09/02/15

| Scenario:                     | Movements      |     |     |               |      |     |                |     |     |               |      |     | Total |
|-------------------------------|----------------|-----|-----|---------------|------|-----|----------------|-----|-----|---------------|------|-----|-------|
|                               | North Approach |     |     | East Approach |      |     | South Approach |     |     | West Approach |      |     |       |
|                               | RT             | TH  | LT  | RT            | TH   | LT  | RT             | TH  | LT  | RT            | TH   | LT  |       |
| Existing Conditions           | 36             | 153 | 34  | 332           | 2156 | 246 | 267            | 403 | 422 | 170           | 785  | 111 | 5115  |
| <b>Approved Project Trips</b> |                |     |     |               |      |     |                |     |     |               |      |     |       |
| San Jose ATI                  | 0              | 0   | 0   | 0             | 0    | 0   | 0              | 0   | 0   | 0             | 0    | 0   | 0     |
| Santa Clara ATI               | 0              | 16  | 20  | 94            | 360  | 5   | 1              | 68  | 94  | 15            | 58   | 0   | 731   |
| Total Approved Trips          | 0              | 16  | 20  | 94            | 360  | 5   | 1              | 68  | 94  | 15            | 58   | 0   | 731   |
| Background Conditions         | 36             | 169 | 54  | 426           | 2516 | 251 | 268            | 471 | 516 | 185           | 843  | 111 | 5846  |
| <b>2015 Project Trips</b>     |                |     |     |               |      |     |                |     |     |               |      |     |       |
| BART                          | 0              | 0   | 0   | 0             | -3   | -1  | -1             | -1  | 0   | 0             | -3   | 0   | -9    |
| Joint Development             | 0              | 0   | 0   | 2             | 14   | 0   | 1              | 0   | 1   | 0             | 13   | 0   | 31    |
| Net 2015 Trips                | 0              | 0   | 0   | 2             | 11   | -1  | 0              | -1  | 1   | 0             | 10   | 0   | 22    |
| Existing + Project            | 36             | 153 | 34  | 334           | 2167 | 245 | 267            | 402 | 423 | 170           | 795  | 111 | 5137  |
| <b>2025 Project Trips</b>     |                |     |     |               |      |     |                |     |     |               |      |     |       |
| BART                          | 0              | -2  | 0   | -5            | -20  | -4  | -1             | -2  | -4  | 0             | -8   | 0   | -46   |
| Joint Development             | 0              | 0   | 2   | 3             | 17   | 0   | 1              | 0   | 0   | 0             | 26   | 0   | 49    |
| Net 2025 Trips                | 0              | -2  | 2   | -2            | -3   | -4  | 0              | -2  | -4  | 0             | 18   | 0   | 3     |
| Background + Project          | 36             | 167 | 56  | 424           | 2513 | 247 | 268            | 469 | 512 | 185           | 861  | 111 | 5849  |
| Cumulative No Project         | 48             | 169 | 200 | 516           | 2516 | 356 | 469            | 471 | 618 | 185           | 2053 | 188 | 7601  |
| <b>2035 Project Trips</b>     |                |     |     |               |      |     |                |     |     |               |      |     |       |
| BART                          | 0              | -1  | -1  | -2            | -9   | -1  | -2             | -2  | 0   | 0             | -10  | 0   | -28   |
| Joint Development             | 0              | 0   | 2   | 2             | 16   | 0   | 0              | 0   | 0   | 0             | 20   | 0   | 40    |
| Net 2035 Trips                | 0              | -1  | 1   | 0             | 7    | -1  | -2             | -2  | 0   | 0             | 10   | 0   | 12    |
| Cumulative                    | 48             | 168 | 201 | 516           | 2523 | 355 | 467            | 469 | 618 | 185           | 2063 | 188 | 7801  |

Intersection Number: **29**  
 Trafix Node Number: 5334  
 Intersection Name: Lafayette St & Central Expy  
 Peak Hour: AM  
 Count Date: 05/21/15  
 Scenario: BART Extension Phase II  
 Date of Analysis: 09/02/15

| Scenario:                     | Movements      |     |     |               |      |     |                |     |     |               |      |     | Total |
|-------------------------------|----------------|-----|-----|---------------|------|-----|----------------|-----|-----|---------------|------|-----|-------|
|                               | North Approach |     |     | East Approach |      |     | South Approach |     |     | West Approach |      |     |       |
|                               | RT             | TH  | LT  | RT            | TH   | LT  | RT             | TH  | LT  | RT            | TH   | LT  |       |
| Existing Conditions           | 153            | 342 | 154 | 348           | 2041 | 252 | 193            | 686 | 399 | 134           | 791  | 207 | 5700  |
| <b>Approved Project Trips</b> |                |     |     |               |      |     |                |     |     |               |      |     |       |
| San Jose ATI                  | 0              | 0   | 0   | 0             | 0    | 0   | 0              | 0   | 0   | 0             | 0    | 0   | 0     |
| Santa Clara ATI               | 13             | 13  | 0   | 0             | 341  | 6   | 16             | 26  | 104 | 18            | 56   | 1   | 594   |
| Total Approved Trips          | 13             | 13  | 0   | 0             | 341  | 6   | 16             | 26  | 104 | 18            | 56   | 1   | 594   |
| Background Conditions         | 166            | 355 | 154 | 348           | 2382 | 258 | 209            | 712 | 503 | 152           | 847  | 208 | 6294  |
| <b>2015 Project Trips</b>     |                |     |     |               |      |     |                |     |     |               |      |     |       |
| BART                          | 0              | 0   | -1  | 0             | -5   | 0   | 0              | 0   | 0   | 0             | -3   | 0   | -9    |
| Joint Development             | 0              | 1   | 15  | 3             | 15   | 0   | 0              | 2   | 2   | 0             | 15   | 0   | 53    |
| Net 2015 Trips                | 0              | 1   | 14  | 3             | 10   | 0   | 0              | 2   | 2   | 0             | 12   | 0   | 44    |
| Existing + Project            | 153            | 343 | 168 | 351           | 2051 | 252 | 193            | 688 | 401 | 134           | 803  | 207 | 5744  |
| <b>2025 Project Trips</b>     |                |     |     |               |      |     |                |     |     |               |      |     |       |
| BART                          | -1             | -2  | -2  | -6            | -27  | 0   | 0              | -3  | -3  | 0             | -8   | 0   | -52   |
| Joint Development             | 0              | 1   | 37  | 4             | 17   | 0   | 0              | 6   | 4   | 0             | 30   | 0   | 99    |
| Net 2025 Trips                | -1             | -1  | 35  | -2            | -10  | 0   | 0              | 3   | 1   | 0             | 22   | 0   | 47    |
| Background + Project          | 165            | 354 | 189 | 346           | 2372 | 258 | 209            | 715 | 504 | 152           | 869  | 208 | 6341  |
| Cumulative No Project         | 411            | 638 | 154 | 579           | 2382 | 322 | 273            | 712 | 503 | 271           | 1611 | 845 | 7856  |
| <b>2035 Project Trips</b>     |                |     |     |               |      |     |                |     |     |               |      |     |       |
| BART                          | 0              | -4  | -3  | -1            | -12  | 0   | 0              | -2  | -1  | 0             | -12  | 0   | -35   |
| Joint Development             | 0              | 6   | 25  | 3             | 14   | 0   | 2              | 5   | 5   | 0             | 23   | 0   | 83    |
| Net 2035 Trips                | 0              | 2   | 22  | 2             | 2    | 0   | 2              | 3   | 4   | 0             | 11   | 0   | 48    |
| Cumulative                    | 411            | 640 | 176 | 581           | 2384 | 322 | 275            | 715 | 507 | 271           | 1622 | 845 | 8749  |

Intersection Number: **30**  
 Trafix Node Number: 5335  
 Intersection Name: De La Cruz Blvd & Central Expy  
 Peak Hour: AM  
 Count Date: 10/08/14  
 Scenario: BART Extension Phase II  
 Date of Analysis: 09/02/15

| Scenario:                     | Movements      |     |    |               |    |    |                |      |      |               |    |      | Total |
|-------------------------------|----------------|-----|----|---------------|----|----|----------------|------|------|---------------|----|------|-------|
|                               | North Approach |     |    | East Approach |    |    | South Approach |      |      | West Approach |    |      |       |
|                               | RT             | TH  | LT | RT            | TH | LT | RT             | TH   | LT   | RT            | TH | LT   |       |
| Existing Conditions           | 1815           | 621 | 0  | 0             | 0  | 0  | 0              | 1129 | 1055 | 137           | 0  | 1054 | 5811  |
| <b>Approved Project Trips</b> |                |     |    |               |    |    |                |      |      |               |    |      |       |
| San Jose ATI                  | 0              | 0   | 0  | 0             | 0  | 0  | 0              | 0    | 0    | 0             | 0  | 0    | 0     |
| Santa Clara ATI               | 194            | 2   | 0  | 0             | 0  | 0  | 0              | 6    | 116  | 29            | 0  | 43   | 390   |
| Total Approved Trips          | 194            | 2   | 0  | 0             | 0  | 0  | 0              | 6    | 116  | 29            | 0  | 43   | 390   |
| Background Conditions         | 2009           | 623 | 0  | 0             | 0  | 0  | 0              | 1135 | 1171 | 166           | 0  | 1097 | 6201  |
| <b>2015 Project Trips</b>     |                |     |    |               |    |    |                |      |      |               |    |      |       |
| BART                          | -4             | -8  | 0  | 0             | 0  | 0  | 0              | -6   | -2   | -2            | 0  | -7   | -29   |
| Joint Development             | 1              | 125 | 0  | 0             | 0  | 0  | 0              | 28   | 17   | 23            | 0  | 7    | 201   |
| Net 2015 Trips                | -3             | 117 | 0  | 0             | 0  | 0  | 0              | 22   | 15   | 21            | 0  | 0    | 172   |
| Existing + Project            | 1812           | 738 | 0  | 0             | 0  | 0  | 0              | 1151 | 1070 | 158           | 0  | 1054 | 5983  |
| <b>2025 Project Trips</b>     |                |     |    |               |    |    |                |      |      |               |    |      |       |
| BART                          | -21            | -17 | 0  | 0             | 0  | 0  | 0              | -13  | -15  | -4            | 0  | -10  | -80   |
| Joint Development             | 1              | 97  | 0  | 0             | 0  | 0  | 0              | 17   | 20   | 59            | 0  | 9    | 203   |
| Net 2025 Trips                | -20            | 80  | 0  | 0             | 0  | 0  | 0              | 4    | 5    | 55            | 0  | -1   | 123   |
| Background + Project          | 1989           | 703 | 0  | 0             | 0  | 0  | 0              | 1139 | 1176 | 221           | 0  | 1096 | 6324  |
| Cumulative No Project         | 2009           | 623 | 0  | 0             | 0  | 0  | 0              | 1135 | 1537 | 684           | 0  | 1403 | 5988  |
| <b>2035 Project Trips</b>     |                |     |    |               |    |    |                |      |      |               |    |      |       |
| BART                          | -5             | -14 | 0  | 0             | 0  | 0  | 0              | -13  | -10  | -6            | 0  | -12  | -60   |
| Joint Development             | 1              | 84  | 0  | 0             | 0  | 0  | 0              | 10   | 15   | 43            | 0  | 7    | 160   |
| Net 2035 Trips                | -4             | 70  | 0  | 0             | 0  | 0  | 0              | -3   | 5    | 37            | 0  | -5   | 100   |
| Cumulative                    | 2005           | 693 | 0  | 0             | 0  | 0  | 0              | 1132 | 1542 | 721           | 0  | 1398 | 7491  |

Intersection Number: **31**  
 Trafix Node Number: 6  
 Intersection Name: De La Cruz Blvd & Martin Ave  
 Peak Hour: AM  
 Count Date: 10/08/14  
 Scenario: BART Extension Phase II  
 Date of Analysis: 09/02/15

| Scenario:                     | Movements      |      |     |               |     |    |                |      |     |               |    |     | Total |
|-------------------------------|----------------|------|-----|---------------|-----|----|----------------|------|-----|---------------|----|-----|-------|
|                               | North Approach |      |     | East Approach |     |    | South Approach |      |     | West Approach |    |     |       |
|                               | RT             | TH   | LT  | RT            | TH  | LT | RT             | TH   | LT  | RT            | TH | LT  |       |
| Existing Conditions           | 169            | 458  | 65  | 207           | 113 | 11 | 8              | 1831 | 334 | 80            | 0  | 113 | 3389  |
| <b>Approved Project Trips</b> |                |      |     |               |     |    |                |      |     |               |    |     |       |
| San Jose ATI                  | 0              | 0    | 0   | 0             | 0   | 0  | 0              | 0    | 0   | 0             | 0  | 0   | 0     |
| Santa Clara ATI               | 1              | 42   | 0   | 0             | 0   | 0  | 0              | 171  | 40  | 4             | 0  | 0   | 258   |
| Total Approved Trips          | 1              | 42   | 0   | 0             | 0   | 0  | 0              | 171  | 40  | 4             | 0  | 0   | 258   |
| Background Conditions         | 170            | 500  | 65  | 207           | 113 | 11 | 8              | 2002 | 374 | 84            | 0  | 113 | 3647  |
| <b>2015 Project Trips</b>     |                |      |     |               |     |    |                |      |     |               |    |     |       |
| BART                          | 0              | -9   | 0   | 0             | 0   | 0  | 0              | -8   | -1  | -2            | 0  | 0   | -20   |
| Joint Development             | 0              | 148  | 0   | 0             | 5   | 2  | 0              | 46   | 2   | 8             | 0  | 0   | 211   |
| Net 2015 Trips                | 0              | 139  | 0   | 0             | 5   | 2  | 0              | 38   | 1   | 6             | 0  | 0   | 191   |
| Existing + Project            | 169            | 597  | 65  | 207           | 118 | 13 | 8              | 1869 | 335 | 86            | 0  | 113 | 3580  |
| <b>2025 Project Trips</b>     |                |      |     |               |     |    |                |      |     |               |    |     |       |
| BART                          | -1             | -16  | 0   | 0             | 0   | 0  | 0              | -29  | -6  | -4            | 0  | 0   | -56   |
| Joint Development             | 0              | 147  | 9   | 2             | 16  | 7  | 0              | 34   | 2   | 7             | 1  | 0   | 225   |
| Net 2025 Trips                | -1             | 131  | 9   | 2             | 16  | 7  | 0              | 5    | -4  | 3             | 1  | 0   | 169   |
| Background + Project          | 169            | 631  | 74  | 209           | 129 | 18 | 8              | 2007 | 370 | 87            | 1  | 113 | 3816  |
| Cumulative No Project         | 170            | 946  | 92  | 208           | 135 | 14 | 8              | 2080 | 374 | 119           | 34 | 121 | 4180  |
| <b>2035 Project Trips</b>     |                |      |     |               |     |    |                |      |     |               |    |     |       |
| BART                          | -1             | -20  | 0   | 0             | 0   | 0  | 0              | -23  | -2  | -4            | 0  | 0   | -50   |
| Joint Development             | 0              | 116  | 10  | 0             | 26  | 4  | 0              | 27   | 2   | 5             | 18 | 0   | 208   |
| Net 2035 Trips                | -1             | 96   | 10  | 0             | 26  | 4  | 0              | 4    | 0   | 1             | 18 | 0   | 158   |
| Cumulative                    | 169            | 1042 | 102 | 208           | 161 | 18 | 8              | 2084 | 374 | 120           | 52 | 121 | 4459  |

Intersection Number: **32**  
 Trafix Node Number: 175  
 Intersection Name: De La Cruz Blvd & Reed St  
 Peak Hour: AM  
 Count Date: 10/08/14  
 Scenario: BART Extension Phase II  
 Date of Analysis: 09/02/15

| Scenario:                     | Movements      |      |    |               |    |    |                |      |     |               |    |    | Total |
|-------------------------------|----------------|------|----|---------------|----|----|----------------|------|-----|---------------|----|----|-------|
|                               | North Approach |      |    | East Approach |    |    | South Approach |      |     | West Approach |    |    |       |
|                               | RT             | TH   | LT | RT            | TH | LT | RT             | TH   | LT  | RT            | TH | LT |       |
| Existing Conditions           | 50             | 437  | 7  | 6             | 3  | 31 | 33             | 1919 | 122 | 54            | 22 | 35 | 2719  |
| <b>Approved Project Trips</b> |                |      |    |               |    |    |                |      |     |               |    |    |       |
| San Jose ATI                  | 0              | 0    | 0  | 0             | 0  | 0  | 0              | 0    | 0   | 0             | 0  | 0  | 0     |
| Santa Clara ATI               | 0              | 45   | 0  | 0             | 0  | 0  | 0              | 211  | 0   | 2             | 0  | 0  | 258   |
| Total Approved Trips          | 0              | 45   | 0  | 0             | 0  | 0  | 0              | 211  | 0   | 2             | 0  | 0  | 258   |
| Background Conditions         | 50             | 482  | 7  | 6             | 3  | 31 | 33             | 2130 | 122 | 56            | 22 | 35 | 2977  |
| <b>2015 Project Trips</b>     |                |      |    |               |    |    |                |      |     |               |    |    |       |
| BART                          | 0              | -11  | -1 | 0             | 0  | 0  | -2             | -9   | 0   | 2             | 0  | -2 | -23   |
| Joint Development             | 0              | 159  | 0  | 0             | 0  | 2  | 0              | 48   | 0   | 4             | 0  | 0  | 213   |
| Net 2015 Trips                | 0              | 148  | -1 | 0             | 0  | 2  | -2             | 39   | 0   | 6             | 0  | -2 | 190   |
| Existing + Project            | 50             | 585  | 6  | 6             | 3  | 33 | 31             | 1958 | 122 | 60            | 22 | 33 | 2909  |
| <b>2025 Project Trips</b>     |                |      |    |               |    |    |                |      |     |               |    |    |       |
| BART                          | 0              | -19  | -1 | 0             | 0  | 0  | -4             | -32  | -1  | 4             | 0  | -2 | -55   |
| Joint Development             | 0              | 163  | 0  | 0             | 0  | 2  | 0              | 37   | 0   | 14            | 0  | 0  | 216   |
| Net 2025 Trips                | 0              | 144  | -1 | 0             | 0  | 2  | -4             | 5    | -1  | 18            | 0  | -2 | 161   |
| Background + Project          | 50             | 626  | 6  | 6             | 3  | 33 | 29             | 2135 | 121 | 74            | 22 | 33 | 3138  |
| Cumulative No Project         | 58             | 926  | 18 | 6             | 7  | 34 | 33             | 2181 | 147 | 73            | 60 | 35 | 3543  |
| <b>2035 Project Trips</b>     |                |      |    |               |    |    |                |      |     |               |    |    |       |
| BART                          | 0              | -23  | -1 | 0             | 0  | -1 | -3             | -23  | -1  | 11            | 0  | -2 | -43   |
| Joint Development             | 0              | 126  | 0  | 0             | 0  | 1  | 0              | 29   | 0   | 7             | 0  | 0  | 163   |
| Net 2035 Trips                | 0              | 103  | -1 | 0             | 0  | 0  | -3             | 6    | -1  | 18            | 0  | -2 | 120   |
| Cumulative                    | 58             | 1029 | 17 | 6             | 7  | 34 | 30             | 2187 | 146 | 91            | 60 | 33 | 3698  |

Intersection Number: **33**  
 Trafix Node Number: 9  
 Intersection Name: Coleman Ave & Brokaw Rd  
 Peak Hour: AM  
 Count Date: 10/08/14  
 Scenario: BART Extension Phase II  
 Date of Analysis: 09/02/15

| Scenario:                     | Movements      |      |    |               |    |    |                |      |     |               |    |     | Total |
|-------------------------------|----------------|------|----|---------------|----|----|----------------|------|-----|---------------|----|-----|-------|
|                               | North Approach |      |    | East Approach |    |    | South Approach |      |     | West Approach |    |     |       |
|                               | RT             | TH   | LT | RT            | TH | LT | RT             | TH   | LT  | RT            | TH | LT  |       |
| Existing Conditions           | 52             | 470  | 17 | 30            | 7  | 43 | 388            | 2060 | 140 | 72            | 24 | 131 | 3434  |
| <b>Approved Project Trips</b> |                |      |    |               |    |    |                |      |     |               |    |     |       |
| San Jose ATI                  | 0              | 566  | 0  | 0             | 0  | 0  | 0              | 142  | 0   | 0             | 0  | 0   | 708   |
| Santa Clara ATI               | 0              | 32   | 0  | 0             | 0  | 0  | 0              | 192  | 0   | 0             | 0  | 0   | 224   |
| Total Approved Trips          | 0              | 598  | 0  | 0             | 0  | 0  | 0              | 334  | 0   | 0             | 0  | 0   | 932   |
| Background Conditions         | 52             | 1068 | 17 | 30            | 7  | 43 | 388            | 2394 | 140 | 72            | 24 | 131 | 4366  |
| <b>2015 Project Trips</b>     |                |      |    |               |    |    |                |      |     |               |    |     |       |
| BART                          | 37             | -19  | 0  | 0             | 0  | 0  | 0              | -16  | -1  | 0             | 0  | 1   | 2     |
| Joint Development             | 401            | 1    | 0  | 0             | 0  | 0  | 0              | 4    | 187 | 77            | 8  | 79  | 757   |
| Net 2015 Trips                | 438            | -18  | 0  | 0             | 0  | 0  | 0              | -12  | 186 | 77            | 8  | 80  | 759   |
| Existing + Project            | 490            | 452  | 17 | 30            | 7  | 43 | 388            | 2048 | 326 | 149           | 32 | 211 | 4193  |
| <b>2025 Project Trips</b>     |                |      |    |               |    |    |                |      |     |               |    |     |       |
| BART                          | 53             | -28  | 0  | 0             | 0  | 0  | 0              | -47  | 5   | 1             | 0  | 2   | -14   |
| Joint Development             | 405            | 4    | 0  | 0             | 11 | 0  | 0              | 4    | 174 | 65            | 28 | 72  | 763   |
| Net 2025 Trips                | 458            | -24  | 0  | 0             | 11 | 0  | 0              | -43  | 179 | 66            | 28 | 74  | 749   |
| Background + Project          | 510            | 1044 | 17 | 30            | 18 | 43 | 388            | 2351 | 319 | 138           | 52 | 205 | 5115  |
| Cumulative No Project         | 100            | 1239 | 44 | 30            | 16 | 89 | 425            | 2405 | 140 | 74            | 30 | 131 | 4592  |
| <b>2035 Project Trips</b>     |                |      |    |               |    |    |                |      |     |               |    |     |       |
| BART                          | 100            | -32  | 0  | 0             | 0  | 0  | 0              | -35  | 14  | 3             | 0  | 3   | 53    |
| Joint Development             | 335            | 4    | 0  | 0             | 28 | 0  | 0              | 3    | 113 | 49            | 31 | 60  | 623   |
| Net 2035 Trips                | 435            | -28  | 0  | 0             | 28 | 0  | 0              | -32  | 127 | 52            | 31 | 63  | 676   |
| Cumulative                    | 535            | 1211 | 44 | 30            | 44 | 89 | 425            | 2373 | 267 | 126           | 61 | 194 | 5399  |

Intersection Number: **34**  
 Trafix Node Number: 3411  
 Intersection Name: Coleman Ave & Aviation Ave  
 Peak Hour: AM  
 Count Date: 10/08/14  
 Scenario: BART Extension Phase II  
 Date of Analysis: 09/02/15

| Scenario:                     | Movements      |      |    |               |    |    |                |      |     |               |    |    | Total |
|-------------------------------|----------------|------|----|---------------|----|----|----------------|------|-----|---------------|----|----|-------|
|                               | North Approach |      |    | East Approach |    |    | South Approach |      |     | West Approach |    |    |       |
|                               | RT             | TH   | LT | RT            | TH | LT | RT             | TH   | LT  | RT            | TH | LT |       |
| Existing Conditions           | 4              | 596  | 8  | 5             | 1  | 19 | 53             | 2690 | 25  | 8             | 1  | 0  | 3410  |
| <b>Approved Project Trips</b> |                |      |    |               |    |    |                |      |     |               |    |    |       |
| San Jose ATI                  | 111            | 453  | 2  | 0             | 0  | 0  | 6              | 100  | 310 | 52            | 4  | 42 | 1080  |
| Santa Clara ATI               | 0              | 32   | 0  | 0             | 0  | 0  | 0              | 192  | 0   | 0             | 0  | 0  | 224   |
| Total Approved Trips          | 111            | 485  | 2  | 0             | 0  | 0  | 6              | 292  | 310 | 52            | 4  | 42 | 1304  |
| Background Conditions         | 115            | 1081 | 10 | 5             | 1  | 19 | 59             | 2982 | 335 | 60            | 5  | 42 | 4714  |
| <b>2015 Project Trips</b>     |                |      |    |               |    |    |                |      |     |               |    |    |       |
| BART                          | 0              | -20  | 0  | 0             | 0  | 0  | 0              | -17  | 0   | 0             | 0  | 0  | -37   |
| Joint Development             | 0              | 78   | 0  | 0             | 0  | 0  | 0              | 191  | 0   | 0             | 0  | 0  | 269   |
| Net 2015 Trips                | 0              | 58   | 0  | 0             | 0  | 0  | 0              | 174  | 0   | 0             | 0  | 0  | 232   |
| Existing + Project            | 4              | 654  | 8  | 5             | 1  | 19 | 53             | 2864 | 25  | 8             | 1  | 0  | 3642  |
| <b>2025 Project Trips</b>     |                |      |    |               |    |    |                |      |     |               |    |    |       |
| BART                          | 0              | -28  | 0  | 0             | 0  | 0  | 0              | -45  | 0   | 0             | 0  | 0  | -73   |
| Joint Development             | 0              | 69   | 0  | 0             | 0  | 0  | 0              | 178  | 0   | 0             | 0  | 0  | 247   |
| Net 2025 Trips                | 0              | 41   | 0  | 0             | 0  | 0  | 0              | 133  | 0   | 0             | 0  | 0  | 174   |
| Background + Project          | 115            | 1122 | 10 | 5             | 1  | 19 | 59             | 3115 | 335 | 60            | 5  | 42 | 4888  |
| Cumulative No Project         | 115            | 1414 | 10 | 5             | 1  | 19 | 59             | 3052 | 335 | 60            | 5  | 42 | 5075  |
| <b>2035 Project Trips</b>     |                |      |    |               |    |    |                |      |     |               |    |    |       |
| BART                          | 0              | -30  | 0  | 0             | 0  | 0  | 0              | -21  | 0   | 0             | 0  | 0  | -51   |
| Joint Development             | 0              | 53   | 0  | 0             | 0  | 0  | 0              | 116  | 0   | 0             | 0  | 0  | 169   |
| Net 2035 Trips                | 0              | 23   | 0  | 0             | 0  | 0  | 0              | 95   | 0   | 0             | 0  | 0  | 118   |
| Cumulative                    | 115            | 1437 | 10 | 5             | 1  | 19 | 59             | 3147 | 335 | 60            | 5  | 42 | 5235  |

Intersection Number: **35**  
 Trafix Node Number: 4047  
 Intersection Name: Coleman Ave & Newhall Dr  
 Peak Hour: AM  
 Count Date: 10/08/14  
 Scenario: BART Extension Phase II  
 Date of Analysis: 09/02/15

| Scenario:                     | Movements      |     |    |               |    |    |                |      |     |               |    |     | Total |
|-------------------------------|----------------|-----|----|---------------|----|----|----------------|------|-----|---------------|----|-----|-------|
|                               | North Approach |     |    | East Approach |    |    | South Approach |      |     | West Approach |    |     |       |
|                               | RT             | TH  | LT | RT            | TH | LT | RT             | TH   | LT  | RT            | TH | LT  |       |
| Existing Conditions           | 73             | 552 | 1  | 0             | 0  | 0  | 0              | 2566 | 266 | 202           | 0  | 115 | 3775  |
| <b>Approved Project Trips</b> |                |     |    |               |    |    |                |      |     |               |    |     |       |
| San Jose ATI                  | 14             | 172 | 0  | 0             | 0  | 0  | 0              | 916  | 10  | 14            | 0  | 0   | 1126  |
| Santa Clara ATI               | 0              | 32  | 0  | 0             | 0  | 0  | 0              | 192  | 0   | 0             | 0  | 0   | 224   |
| Total Approved Trips          | 14             | 204 | 0  | 0             | 0  | 0  | 0              | 1108 | 10  | 14            | 0  | 0   | 1350  |
| Background Conditions         | 87             | 756 | 1  | 0             | 0  | 0  | 0              | 3674 | 276 | 216           | 0  | 115 | 5125  |
| <b>2015 Project Trips</b>     |                |     |    |               |    |    |                |      |     |               |    |     |       |
| BART                          | 0              | -19 | 0  | 0             | 0  | 0  | 0              | -18  | 0   | -1            | 0  | 0   | -38   |
| Joint Development             | 0              | 77  | 0  | 0             | 0  | 0  | 0              | 189  | 0   | 0             | 0  | 0   | 266   |
| Net 2015 Trips                | 0              | 58  | 0  | 0             | 0  | 0  | 0              | 171  | 0   | -1            | 0  | 0   | 228   |
| Existing + Project            | 73             | 610 | 1  | 0             | 0  | 0  | 0              | 2737 | 266 | 201           | 0  | 115 | 4003  |
| <b>2025 Project Trips</b>     |                |     |    |               |    |    |                |      |     |               |    |     |       |
| BART                          | 0              | -26 | 0  | 0             | 0  | 0  | 0              | -49  | -10 | -6            | 0  | 0   | -91   |
| Joint Development             | 0              | 68  | 0  | 0             | 0  | 0  | 0              | 172  | 0   | 1             | 0  | 0   | 241   |
| Net 2025 Trips                | 0              | 42  | 0  | 0             | 0  | 0  | 0              | 123  | -10 | -5            | 0  | 0   | 150   |
| Background + Project          | 87             | 798 | 1  | 0             | 0  | 0  | 0              | 3797 | 266 | 211           | 0  | 115 | 5275  |
| Cumulative No Project         | 177            | 934 | 1  | 0             | 0  | 0  | 0              | 3674 | 439 | 539           | 0  | 115 | 5764  |
| <b>2035 Project Trips</b>     |                |     |    |               |    |    |                |      |     |               |    |     |       |
| BART                          | 0              | -30 | 0  | 0             | 0  | 0  | 0              | -34  | -11 | -16           | 0  | 0   | -91   |
| Joint Development             | 0              | 51  | 0  | 0             | 0  | 0  | 0              | 112  | 0   | 3             | 0  | 0   | 166   |
| Net 2035 Trips                | 0              | 21  | 0  | 0             | 0  | 0  | 0              | 78   | -11 | -13           | 0  | 0   | 75    |
| Cumulative                    | 177            | 955 | 1  | 0             | 0  | 0  | 0              | 3752 | 428 | 526           | 0  | 115 | 5954  |

Intersection Number: **36**  
 Trafix Node Number: 3052  
 Intersection Name: Coleman Ave & I-880 SB Ramps  
 Peak Hour: AM  
 Count Date: 05/12/15  
 Scenario: BART Extension Phase II  
 Date of Analysis: 09/02/15

| Scenario:                     | Movements      |      |    |               |    |     |                |      |    |               |    |    | Total |
|-------------------------------|----------------|------|----|---------------|----|-----|----------------|------|----|---------------|----|----|-------|
|                               | North Approach |      |    | East Approach |    |     | South Approach |      |    | West Approach |    |    |       |
|                               | RT             | TH   | LT | RT            | TH | LT  | RT             | TH   | LT | RT            | TH | LT |       |
| Existing Conditions           | 183            | 564  | 0  | 459           | 0  | 310 | 178            | 3143 | 0  | 0             | 0  | 0  | 4837  |
| <b>Approved Project Trips</b> |                |      |    |               |    |     |                |      |    |               |    |    |       |
| San Jose ATI                  | 0              | 316  | 0  | 250           | 0  | 21  | 1              | 815  | 0  | 0             | 0  | 0  | 1403  |
| Santa Clara ATI               | 10             | 22   | 0  | 64            | 0  | 0   | 0              | 128  | 0  | 0             | 0  | 0  | 224   |
| Total Approved Trips          | 10             | 338  | 0  | 314           | 0  | 21  | 1              | 943  | 0  | 0             | 0  | 0  | 1627  |
| Background Conditions         | 193            | 902  | 0  | 773           | 0  | 331 | 179            | 4086 | 0  | 0             | 0  | 0  | 6464  |
| <b>2015 Project Trips</b>     |                |      |    |               |    |     |                |      |    |               |    |    |       |
| BART                          | 0              | -20  | 0  | -5            | 0  | -4  | 0              | -16  | 0  | 0             | 0  | 0  | -45   |
| Joint Development             | 0              | 51   | 0  | 45            | 0  | 0   | 0              | 142  | 0  | 0             | 0  | 0  | 238   |
| Net 2015 Trips                | 0              | 31   | 0  | 40            | 0  | -4  | 0              | 126  | 0  | 0             | 0  | 0  | 193   |
| Existing + Project            | 183            | 595  | 0  | 499           | 0  | 306 | 178            | 3269 | 0  | 0             | 0  | 0  | 5030  |
| <b>2025 Project Trips</b>     |                |      |    |               |    |     |                |      |    |               |    |    |       |
| BART                          | 0              | -32  | 0  | -17           | 0  | -18 | 0              | -51  | 0  | 0             | 0  | 0  | -118  |
| Joint Development             | 0              | 52   | 0  | 54            | 0  | 1   | 0              | 106  | 0  | 0             | 0  | 0  | 213   |
| Net 2025 Trips                | 0              | 20   | 0  | 37            | 0  | -17 | 0              | 55   | 0  | 0             | 0  | 0  | 95    |
| Background + Project          | 193            | 922  | 0  | 810           | 0  | 314 | 179            | 4141 | 0  | 0             | 0  | 0  | 6559  |
| Cumulative No Project         | 193            | 1140 | 0  | 773           | 0  | 577 | 179            | 4086 | 0  | 0             | 0  | 0  | 6948  |
| <b>2035 Project Trips</b>     |                |      |    |               |    |     |                |      |    |               |    |    |       |
| BART                          | 0              | -43  | 0  | -16           | 0  | -20 | 0              | -34  | 0  | 0             | 0  | 0  | -113  |
| Joint Development             | 0              | 42   | 0  | 35            | 0  | 0   | 0              | 74   | 0  | 0             | 0  | 0  | 151   |
| Net 2035 Trips                | 0              | -1   | 0  | 19            | 0  | -20 | 0              | 40   | 0  | 0             | 0  | 0  | 38    |
| Cumulative                    | 193            | 1139 | 0  | 792           | 0  | 557 | 179            | 4126 | 0  | 0             | 0  | 0  | 6986  |

Intersection Number: **37**  
 Trafix Node Number: 3053  
 Intersection Name: Coleman Ave & I-880 NB Ramps  
 Peak Hour: AM  
 Count Date: 05/12/15  
 Scenario: BART Extension Phase II  
 Date of Analysis: 09/02/15

| Scenario:                     | Movements      |      |     |               |    |     |                |      |    |               |    |    | Total |
|-------------------------------|----------------|------|-----|---------------|----|-----|----------------|------|----|---------------|----|----|-------|
|                               | North Approach |      |     | East Approach |    |     | South Approach |      |    | West Approach |    |    |       |
|                               | RT             | TH   | LT  | RT            | TH | LT  | RT             | TH   | LT | RT            | TH | LT |       |
| Existing Conditions           | 29             | 692  | 177 | 1081          | 0  | 146 | 334            | 2165 | 0  | 13            | 0  | 0  | 4637  |
| <b>Approved Project Trips</b> |                |      |     |               |    |     |                |      |    |               |    |    |       |
| San Jose ATI                  | 0              | 181  | 58  | 359           | 0  | 7   | 2              | 437  | 0  | 0             | 0  | 0  | 1044  |
| Santa Clara ATI               | 0              | 11   | 11  | 64            | 0  | 0   | 0              | 64   | 0  | 0             | 0  | 0  | 150   |
| Total Approved Trips          | 0              | 192  | 69  | 423           | 0  | 7   | 2              | 501  | 0  | 0             | 0  | 0  | 1194  |
| Background Conditions         | 29             | 884  | 246 | 1504          | 0  | 153 | 336            | 2666 | 0  | 13            | 0  | 0  | 5831  |
| <b>2015 Project Trips</b>     |                |      |     |               |    |     |                |      |    |               |    |    |       |
| BART                          | 0              | -23  | -1  | 0             | 0  | -7  | -8             | -35  | 0  | 0             | 0  | 0  | -74   |
| Joint Development             | 0              | 33   | 18  | 24            | 0  | 1   | 0              | 119  | 0  | 0             | 0  | 0  | 195   |
| Net 2015 Trips                | 0              | 10   | 17  | 24            | 0  | -6  | -8             | 84   | 0  | 0             | 0  | 0  | 121   |
| Existing + Project            | 29             | 702  | 194 | 1105          | 0  | 140 | 326            | 2249 | 0  | 13            | 0  | 0  | 4758  |
| <b>2025 Project Trips</b>     |                |      |     |               |    |     |                |      |    |               |    |    |       |
| BART                          | 0              | -44  | -5  | -8            | 0  | -10 | -14            | -67  | 0  | 0             | 0  | 0  | -148  |
| Joint Development             | 0              | 36   | 16  | 16            | 0  | 2   | 0              | 91   | 0  | 0             | 0  | 0  | 161   |
| Net 2025 Trips                | 0              | -8   | 11  | 8             | 0  | -8  | -14            | 24   | 0  | 0             | 0  | 0  | 13    |
| Background + Project          | 29             | 876  | 257 | 1512          | 0  | 145 | 322            | 2690 | 0  | 13            | 0  | 0  | 5844  |
| Cumulative No Project         | 29             | 1431 | 281 | 1504          | 0  | 153 | 345            | 2666 | 0  | 13            | 0  | 0  | 6422  |
| <b>2035 Project Trips</b>     |                |      |     |               |    |     |                |      |    |               |    |    |       |
| BART                          | 0              | -56  | -7  | 0             | 0  | -5  | -16            | -51  | 0  | 0             | 0  | 0  | -135  |
| Joint Development             | 0              | 27   | 15  | 11            | 0  | 2   | 0              | 64   | 0  | 0             | 0  | 0  | 119   |
| Net 2035 Trips                | 0              | -29  | 8   | 11            | 0  | -3  | -16            | 13   | 0  | 0             | 0  | 0  | -16   |
| Cumulative                    | 29             | 1402 | 289 | 1515          | 0  | 150 | 329            | 2679 | 0  | 13            | 0  | 0  | 6406  |

Intersection Number: **38**  
 Trafix Node Number: 3413  
 Intersection Name: Coleman Ave & W. Hedding St  
 Peak Hour: AM  
 Count Date: 05/12/15  
 Scenario: BART Extension Phase II  
 Date of Analysis: 09/02/15

| Scenario:                     | Movements      |     |     |               |     |    |                |      |     |               |     |     | Total |
|-------------------------------|----------------|-----|-----|---------------|-----|----|----------------|------|-----|---------------|-----|-----|-------|
|                               | North Approach |     |     | East Approach |     |    | South Approach |      |     | West Approach |     |     |       |
|                               | RT             | TH  | LT  | RT            | TH  | LT | RT             | TH   | LT  | RT            | TH  | LT  |       |
| Existing Conditions           | 139            | 492 | 165 | 746           | 376 | 45 | 21             | 1579 | 98  | 101           | 296 | 249 | 4307  |
| <b>Approved Project Trips</b> |                |     |     |               |     |    |                |      |     |               |     |     |       |
| San Jose ATI                  | 19             | 119 | 25  | 43            | 6   | 0  | 0              | 287  | 39  | 29            | 38  | 51  | 656   |
| Santa Clara ATI               | 0              | 11  | 0   | 0             | 0   | 0  | 0              | 64   | 0   | 0             | 0   | 0   | 75    |
| Total Approved Trips          | 19             | 130 | 25  | 43            | 6   | 0  | 0              | 351  | 39  | 29            | 38  | 51  | 731   |
| Background Conditions         | 158            | 622 | 190 | 789           | 382 | 45 | 21             | 1930 | 137 | 130           | 334 | 300 | 5038  |
| <b>2015 Project Trips</b>     |                |     |     |               |     |    |                |      |     |               |     |     |       |
| BART                          | -1             | -27 | -2  | -11           | -2  | 0  | 0              | -25  | 0   | 0             | 8   | -8  | -68   |
| Joint Development             | 5              | 21  | 9   | 25            | 1   | 0  | 0              | 71   | 0   | 0             | 1   | 23  | 156   |
| Net 2015 Trips                | 4              | -6  | 7   | 14            | -1  | 0  | 0              | 46   | 0   | 0             | 9   | 15  | 88    |
| Existing + Project            | 143            | 486 | 172 | 760           | 375 | 45 | 21             | 1625 | 98  | 101           | 305 | 264 | 4395  |
| <b>2025 Project Trips</b>     |                |     |     |               |     |    |                |      |     |               |     |     |       |
| BART                          | -4             | -47 | -4  | -18           | -15 | -1 | 0              | -58  | 0   | 0             | -2  | -6  | -155  |
| Joint Development             | 5              | 21  | 11  | 21            | 1   | 0  | 0              | 61   | 0   | 0             | 3   | 9   | 132   |
| Net 2025 Trips                | 1              | -26 | 7   | 3             | -14 | -1 | 0              | 3    | 0   | 0             | 1   | 3   | -23   |
| Background + Project          | 159            | 596 | 197 | 792           | 368 | 44 | 21             | 1933 | 137 | 130           | 335 | 303 | 5015  |
| Cumulative No Project         | 366            | 992 | 190 | 1001          | 767 | 81 | 63             | 1930 | 137 | 130           | 963 | 300 | 6620  |
| <b>2035 Project Trips</b>     |                |     |     |               |     |    |                |      |     |               |     |     |       |
| BART                          | -10            | -46 | -7  | -18           | -13 | 0  | 0              | -40  | -1  | 0             | -4  | -9  | -148  |
| Joint Development             | 3              | 16  | 9   | 17            | 0   | 0  | 0              | 33   | 0   | 1             | 2   | 14  | 95    |
| Net 2035 Trips                | -7             | -30 | 2   | -1            | -13 | 0  | 0              | -7   | -1  | 1             | -2  | 5   | -53   |
| Cumulative                    | 359            | 962 | 192 | 1000          | 754 | 81 | 63             | 1923 | 136 | 131           | 961 | 305 | 6867  |

Intersection Number: **39**  
 Traffic Node Number: 3417  
 Intersection Name: Coleman Ave & W. Taylor St  
 Peak Hour: AM  
 Count Date: 05/12/15  
 Scenario: BART Extension Phase II  
 Date of Analysis: 09/02/15

| Scenario:                     | Movements      |     |     |               |      |     |                |      |     |               |     |     | Total |
|-------------------------------|----------------|-----|-----|---------------|------|-----|----------------|------|-----|---------------|-----|-----|-------|
|                               | North Approach |     |     | East Approach |      |     | South Approach |      |     | West Approach |     |     |       |
|                               | RT             | TH  | LT  | RT            | TH   | LT  | RT             | TH   | LT  | RT            | TH  | LT  |       |
| Existing Conditions           | 154            | 339 | 183 | 288           | 554  | 99  | 23             | 1029 | 204 | 151           | 543 | 335 | 3902  |
| <b>Approved Project Trips</b> |                |     |     |               |      |     |                |      |     |               |     |     |       |
| San Jose ATI                  | 26             | 45  | 112 | 249           | 23   | 0   | 11             | 132  | 17  | 77            | 66  | 137 | 895   |
| Santa Clara ATI               | 0              | 11  | 0   | 0             | 0    | 0   | 0              | 64   | 0   | 0             | 0   | 0   | 75    |
| Total Approved Trips          | 26             | 56  | 112 | 249           | 23   | 0   | 11             | 196  | 17  | 77            | 66  | 137 | 970   |
| Background Conditions         | 180            | 395 | 295 | 537           | 577  | 99  | 34             | 1225 | 221 | 228           | 609 | 472 | 4872  |
| <b>2015 Project Trips</b>     |                |     |     |               |      |     |                |      |     |               |     |     |       |
| BART                          | -1             | -25 | -1  | -4            | -3   | 0   | 0              | -21  | -5  | -3            | 1   | 0   | -62   |
| Joint Development             | 2              | 15  | 3   | 34            | 3    | 0   | 0              | 33   | 3   | 1             | 0   | 4   | 98    |
| Net 2015 Trips                | 1              | -10 | 2   | 30            | 0    | 0   | 0              | 12   | -2  | -2            | 1   | 4   | 36    |
| Existing + Project            | 155            | 329 | 185 | 318           | 554  | 99  | 23             | 1041 | 202 | 149           | 544 | 339 | 3938  |
| <b>2025 Project Trips</b>     |                |     |     |               |      |     |                |      |     |               |     |     |       |
| BART                          | -4             | -41 | -3  | -19           | -10  | -1  | -1             | -39  | -8  | -9            | -5  | -3  | -143  |
| Joint Development             | 0              | 17  | 3   | 21            | 8    | 0   | 0              | 31   | 3   | 3             | 3   | 8   | 97    |
| Net 2025 Trips                | -4             | -24 | 0   | 2             | -2   | -1  | -1             | -8   | -5  | -6            | -2  | 5   | -46   |
| Background + Project          | 176            | 371 | 295 | 539           | 575  | 98  | 33             | 1217 | 216 | 222           | 607 | 477 | 4826  |
| Cumulative No Project         | 180            | 875 | 295 | 537           | 1064 | 249 | 50             | 1329 | 221 | 353           | 852 | 472 | 6005  |
| <b>2035 Project Trips</b>     |                |     |     |               |      |     |                |      |     |               |     |     |       |
| BART                          | 0              | -45 | -2  | -8            | -15  | -3  | 0              | -33  | -9  | -18           | -4  | 0   | -137  |
| Joint Development             | 0              | 13  | 3   | 8             | 10   | 0   | 0              | 25   | 1   | 4             | 1   | 1   | 66    |
| Net 2035 Trips                | 0              | -32 | 1   | 0             | -5   | -3  | 0              | -8   | -8  | -14           | -3  | 1   | -71   |
| Cumulative                    | 180            | 843 | 296 | 537           | 1059 | 246 | 50             | 1321 | 213 | 339           | 849 | 473 | 6406  |

Intersection Number: **40**  
 Traffic Node Number: 4038  
 Intersection Name: SR 87 & W. Taylor St  
 Peak Hour: AM  
 Count Date: 05/12/15  
 Scenario: BART Extension Phase II  
 Date of Analysis: 09/02/15

| Scenario:                     | Movements      |    |     |               |     |     |                |    |     |               |     |     | Total |
|-------------------------------|----------------|----|-----|---------------|-----|-----|----------------|----|-----|---------------|-----|-----|-------|
|                               | North Approach |    |     | East Approach |     |     | South Approach |    |     | West Approach |     |     |       |
|                               | RT             | TH | LT  | RT            | TH  | LT  | RT             | TH | LT  | RT            | TH  | LT  |       |
| Existing Conditions           | 146            | 0  | 135 | 120           | 402 | 573 | 1100           | 0  | 722 | 397           | 269 | 143 | 4007  |
| <b>Approved Project Trips</b> |                |    |     |               |     |     |                |    |     |               |     |     |       |
| San Jose ATI                  | 0              | 0  | 38  | 74            | 31  | 101 | 74             | 0  | 121 | 35            | 35  | 0   | 509   |
| Santa Clara ATI               | 0              | 0  | 0   | 0             | 0   | 0   | 0              | 0  | 0   | 0             | 0   | 0   | 0     |
| Total Approved Trips          | 0              | 0  | 38  | 74            | 31  | 101 | 74             | 0  | 121 | 35            | 35  | 0   | 509   |
| Background Conditions         | 146            | 0  | 173 | 194           | 433 | 674 | 1174           | 0  | 843 | 432           | 304 | 143 | 4516  |
| <b>2015 Project Trips</b>     |                |    |     |               |     |     |                |    |     |               |     |     |       |
| BART                          | -1             | 0  | -5  | -2            | -3  | -22 | -8             | 0  | -3  | -1            | 1   | -1  | -45   |
| Joint Development             | 0              | 0  | 0   | 5             | 6   | 0   | 0              | 0  | 33  | 2             | 1   | 0   | 47    |
| Net 2015 Trips                | -1             | 0  | -5  | 3             | 3   | -22 | -8             | 0  | 30  | 1             | 2   | -1  | 2     |
| Existing + Project            | 145            | 0  | 130 | 123           | 405 | 551 | 1092           | 0  | 752 | 398           | 271 | 142 | 4009  |
| <b>2025 Project Trips</b>     |                |    |     |               |     |     |                |    |     |               |     |     |       |
| BART                          | -3             | 0  | -8  | -7            | -13 | -23 | -25            | 0  | -15 | -1            | -1  | -6  | -102  |
| Joint Development             | 0              | 0  | 0   | 4             | 10  | 1   | 2              | 0  | 20  | 3             | 4   | 1   | 45    |
| Net 2025 Trips                | -3             | 0  | -8  | -3            | -3  | -22 | -23            | 0  | 5   | 2             | 3   | -5  | -57   |
| Background + Project          | 143            | 0  | 165 | 191           | 430 | 652 | 1151           | 0  | 848 | 434           | 307 | 138 | 4459  |
| Cumulative No Project         | 319            | 0  | 238 | 513           | 463 | 674 | 1174           | 0  | 848 | 436           | 412 | 387 | 5077  |
| <b>2035 Project Trips</b>     |                |    |     |               |     |     |                |    |     |               |     |     |       |
| BART                          | -7             | 0  | -11 | -3            | -12 | -27 | -24            | 0  | -8  | -1            | -2  | -2  | -97   |
| Joint Development             | 0              | 0  | 2   | 2             | 9   | 0   | 3              | 0  | 9   | 3             | 1   | 0   | 29    |
| Net 2035 Trips                | -7             | 0  | -9  | -1            | -3  | -27 | -21            | 0  | 1   | 2             | -1  | -2  | -68   |
| Cumulative                    | 312            | 0  | 229 | 512           | 460 | 647 | 1153           | 0  | 849 | 438           | 411 | 385 | 5396  |



Intersection Number: 41  
 Traffic Node Number: 5416  
 Intersection Name: San Tomas Expy & El Camino Real  
 Peak Hour: AM  
 Count Date: 10/08/14  
 Scenario: BART Extension Phase II  
 Date of Analysis: 09/02/15

| Scenario:                     | Movements      |      |    |               |      |     |                |      |     |               |     |     | Total |
|-------------------------------|----------------|------|----|---------------|------|-----|----------------|------|-----|---------------|-----|-----|-------|
|                               | North Approach |      |    | East Approach |      |     | South Approach |      |     | West Approach |     |     |       |
|                               | RT             | TH   | LT | RT            | TH   | LT  | RT             | TH   | LT  | RT            | TH  | LT  |       |
| Existing Conditions           | 372            | 1020 | 75 | 410           | 755  | 163 | 96             | 2779 | 173 | 127           | 657 | 263 | 6890  |
| <b>Approved Project Trips</b> |                |      |    |               |      |     |                |      |     |               |     |     |       |
| San Jose ATI                  | 0              | 0    | 0  | 0             | 0    | 0   | 0              | 0    | 0   | 0             | 0   | 0   | 0     |
| Santa Clara ATI               | 37             | 133  | 11 | 39            | 25   | 2   | 6              | 905  | 12  | 40            | 61  | 169 | 1440  |
| Total Approved Trips          | 37             | 133  | 11 | 39            | 25   | 2   | 6              | 905  | 12  | 40            | 61  | 169 | 1440  |
| Background Conditions         | 409            | 1153 | 86 | 449           | 780  | 165 | 102            | 3684 | 185 | 167           | 718 | 432 | 8330  |
| <b>2015 Project Trips</b>     |                |      |    |               |      |     |                |      |     |               |     |     |       |
| BART                          | 1              | -2   | 0  | 0             | -3   | 0   | 1              | -4   | 0   | 0             | -2  | 1   | -8    |
| Joint Development             | 0              | 0    | 0  | 0             | 8    | 7   | 16             | 3    | 0   | 0             | 22  | 2   | 58    |
| Net 2015 Trips                | 1              | -2   | 0  | 0             | 5    | 7   | 17             | -1   | 0   | 0             | 20  | 3   | 50    |
| Existing + Project            | 373            | 1018 | 75 | 410           | 760  | 170 | 113            | 2778 | 173 | 127           | 677 | 266 | 6940  |
| <b>2025 Project Trips</b>     |                |      |    |               |      |     |                |      |     |               |     |     |       |
| BART                          | -2             | -9   | 0  | -2            | -12  | -2  | 0              | -18  | -1  | 0             | -4  | -3  | -53   |
| Joint Development             | 0              | 0    | 0  | 0             | 9    | 2   | 24             | 3    | 0   | 0             | 24  | 2   | 64    |
| Net 2025 Trips                | -2             | -9   | 0  | -2            | -3   | 0   | 24             | -15  | -1  | 0             | 20  | -1  | 11    |
| Background + Project          | 407            | 1144 | 86 | 447           | 777  | 165 | 126            | 3669 | 184 | 167           | 738 | 431 | 8341  |
| Cumulative No Project         | 451            | 1284 | 95 | 547           | 1154 | 165 | 194            | 3684 | 328 | 167           | 953 | 451 | 9022  |
| <b>2035 Project Trips</b>     |                |      |    |               |      |     |                |      |     |               |     |     |       |
| BART                          | -2             | -10  | 0  | -3            | -6   | 0   | 1              | -22  | 0   | 0             | -5  | -4  | -51   |
| Joint Development             | 0              | 0    | 0  | 0             | 7    | 2   | 14             | 2    | 0   | 0             | 20  | 3   | 48    |
| Net 2035 Trips                | -2             | -10  | 0  | -3            | 1    | 2   | 15             | -20  | 0   | 0             | 15  | -1  | -3    |
| Cumulative                    | 449            | 1274 | 95 | 544           | 1155 | 167 | 209            | 3664 | 328 | 167           | 968 | 450 | 9470  |

Intersection Number: 42  
 Traffic Node Number: 1205  
 Intersection Name: Scott Blvd & El Camino Real  
 Peak Hour: AM  
 Count Date: 10/08/14  
 Scenario: BART Extension Phase II  
 Date of Analysis: 09/02/15

| Scenario:                     | Movements      |     |     |               |     |     |                |     |     |               |     |     | Total |
|-------------------------------|----------------|-----|-----|---------------|-----|-----|----------------|-----|-----|---------------|-----|-----|-------|
|                               | North Approach |     |     | East Approach |     |     | South Approach |     |     | West Approach |     |     |       |
|                               | RT             | TH  | LT  | RT            | TH  | LT  | RT             | TH  | LT  | RT            | TH  | LT  |       |
| Existing Conditions           | 92             | 218 | 87  | 96            | 672 | 129 | 118            | 750 | 147 | 68            | 420 | 102 | 2899  |
| <b>Approved Project Trips</b> |                |     |     |               |     |     |                |     |     |               |     |     |       |
| San Jose ATI                  | 0              | 0   | 0   | 0             | 0   | 0   | 0              | 0   | 0   | 0             | 0   | 0   | 0     |
| Santa Clara ATI               | 1              | 19  | 1   | 29            | 34  | 0   | 0              | 154 | 32  | 5             | 71  | 3   | 349   |
| Total Approved Trips          | 1              | 19  | 1   | 29            | 34  | 0   | 0              | 154 | 32  | 5             | 71  | 3   | 349   |
| Background Conditions         | 93             | 237 | 88  | 125           | 706 | 129 | 118            | 904 | 179 | 73            | 491 | 105 | 3248  |
| <b>2015 Project Trips</b>     |                |     |     |               |     |     |                |     |     |               |     |     |       |
| BART                          | 0              | 0   | 0   | 0             | -3  | 0   | 3              | -1  | 0   | 0             | -2  | 0   | -3    |
| Joint Development             | 0              | 0   | 1   | 0             | 15  | 0   | 45             | 0   | 0   | 0             | 38  | 0   | 99    |
| Net 2015 Trips                | 0              | 0   | 1   | 0             | 12  | 0   | 48             | -1  | 0   | 0             | 36  | 0   | 96    |
| Existing + Project            | 92             | 218 | 88  | 96            | 684 | 129 | 166            | 749 | 147 | 68            | 456 | 102 | 2995  |
| <b>2025 Project Trips</b>     |                |     |     |               |     |     |                |     |     |               |     |     |       |
| BART                          | 0              | 0   | 0   | -1            | -11 | -1  | 1              | -6  | -1  | 0             | -3  | 0   | -22   |
| Joint Development             | 0              | 0   | 1   | 0             | 12  | 4   | 24             | 0   | 0   | 0             | 50  | 0   | 91    |
| Net 2025 Trips                | 0              | 0   | 1   | -1            | 1   | 3   | 25             | -6  | -1  | 0             | 47  | 0   | 69    |
| Background + Project          | 93             | 237 | 89  | 124           | 707 | 132 | 143            | 898 | 178 | 73            | 538 | 105 | 3317  |
| Cumulative No Project         | 93             | 422 | 109 | 311           | 936 | 265 | 118            | 981 | 255 | 130           | 758 | 106 | 4378  |
| <b>2035 Project Trips</b>     |                |     |     |               |     |     |                |     |     |               |     |     |       |
| BART                          | 0              | -1  | 0   | 0             | -6  | -1  | 8              | -3  | -1  | 0             | -3  | -1  | -8    |
| Joint Development             | 0              | 0   | 0   | 0             | 7   | 4   | 22             | 2   | 0   | 0             | 35  | 1   | 71    |
| Net 2035 Trips                | 0              | -1  | 0   | 0             | 1   | 3   | 30             | -1  | -1  | 0             | 32  | 0   | 63    |
| Cumulative                    | 93             | 421 | 109 | 311           | 937 | 268 | 148            | 980 | 254 | 130           | 790 | 106 | 4547  |

Intersection Number: **43**  
 Trafix Node Number: 1203  
 Intersection Name: Lincoln St & El Camino Real  
 Peak Hour: AM  
 Count Date: 05/21/15  
 Scenario: BART Extension Phase II  
 Date of Analysis: 09/02/15

| Scenario:                     | Movements      |    |    |               |      |    |                |    |     |               |     |    | Total |
|-------------------------------|----------------|----|----|---------------|------|----|----------------|----|-----|---------------|-----|----|-------|
|                               | North Approach |    |    | East Approach |      |    | South Approach |    |     | West Approach |     |    |       |
|                               | RT             | TH | LT | RT            | TH   | LT | RT             | TH | LT  | RT            | TH  | LT |       |
| Existing Conditions           | 28             | 24 | 26 | 40            | 921  | 44 | 98             | 65 | 124 | 36            | 600 | 19 | 2025  |
| <b>Approved Project Trips</b> |                |    |    |               |      |    |                |    |     |               |     |    |       |
| San Jose ATI                  | 0              | 0  | 0  | 0             | 0    | 0  | 0              | 0  | 0   | 0             | 0   | 0  | 0     |
| Santa Clara ATI               | 0              | 0  | 0  | 0             | 61   | 30 | 0              | 0  | 3   | 2             | 38  | 0  | 134   |
| Total Approved Trips          | 0              | 0  | 0  | 0             | 61   | 30 | 0              | 0  | 3   | 2             | 38  | 0  | 134   |
| Background Conditions         | 28             | 24 | 26 | 40            | 982  | 74 | 98             | 65 | 127 | 38            | 638 | 19 | 2159  |
| <b>2015 Project Trips</b>     |                |    |    |               |      |    |                |    |     |               |     |    |       |
| BART                          | 0              | 0  | 1  | 0             | -2   | 0  | 3              | 0  | 0   | 0             | 2   | 0  | 4     |
| Joint Development             | 0              | 0  | 0  | 0             | 16   | 0  | 23             | 0  | 0   | 0             | 84  | 0  | 123   |
| Net 2015 Trips                | 0              | 0  | 1  | 0             | 14   | 0  | 26             | 0  | 0   | 0             | 86  | 0  | 127   |
| Existing + Project            | 28             | 24 | 27 | 40            | 935  | 44 | 124            | 65 | 124 | 36            | 686 | 19 | 2152  |
| <b>2025 Project Trips</b>     |                |    |    |               |      |    |                |    |     |               |     |    |       |
| BART                          | -1             | 0  | 1  | 0             | -12  | 0  | 3              | 0  | -1  | 0             | -1  | 0  | -11   |
| Joint Development             | 0              | 0  | 0  | 0             | 17   | 0  | 18             | 0  | 0   | 0             | 74  | 0  | 109   |
| Net 2025 Trips                | -1             | 0  | 1  | 0             | 5    | 0  | 21             | 0  | -1  | 0             | 73  | 0  | 98    |
| Background + Project          | 27             | 24 | 27 | 40            | 987  | 74 | 119            | 65 | 126 | 38            | 711 | 19 | 2257  |
| Cumulative No Project         | 33             | 41 | 33 | 49            | 1232 | 74 | 187            | 74 | 422 | 64            | 832 | 56 | 3041  |
| <b>2035 Project Trips</b>     |                |    |    |               |      |    |                |    |     |               |     |    |       |
| BART                          | 0              | 0  | 0  | 1             | -7   | 0  | 9              | 0  | 0   | 0             | 4   | 0  | 7     |
| Joint Development             | 0              | 0  | 0  | 0             | 12   | 0  | 6              | 0  | 0   | 0             | 58  | 0  | 76    |
| Net 2035 Trips                | 0              | 0  | 0  | 1             | 5    | 0  | 15             | 0  | 0   | 0             | 62  | 0  | 83    |
| Cumulative                    | 33             | 41 | 33 | 50            | 1237 | 74 | 202            | 74 | 422 | 64            | 894 | 56 | 3180  |

Intersection Number: **44**  
 Trafix Node Number: 1204  
 Intersection Name: Monroe St & El Camino Real  
 Peak Hour: AM  
 Count Date: 10/08/14  
 Scenario: BART Extension Phase II  
 Date of Analysis: 09/02/15

| Scenario:                     | Movements      |     |     |               |      |    |                |     |    |               |      |    | Total |
|-------------------------------|----------------|-----|-----|---------------|------|----|----------------|-----|----|---------------|------|----|-------|
|                               | North Approach |     |     | East Approach |      |    | South Approach |     |    | West Approach |      |    |       |
|                               | RT             | TH  | LT  | RT            | TH   | LT | RT             | TH  | LT | RT            | TH   | LT |       |
| Existing Conditions           | 46             | 163 | 118 | 211           | 790  | 40 | 33             | 371 | 71 | 43            | 648  | 48 | 2582  |
| <b>Approved Project Trips</b> |                |     |     |               |      |    |                |     |    |               |      |    |       |
| San Jose ATI                  | 0              | 0   | 0   | 0             | 0    | 0  | 0              | 0   | 0  | 0             | 0    | 0  | 0     |
| Santa Clara ATI               | 0              | 4   | 6   | 31            | 57   | 4  | 0              | 24  | 3  | 0             | 68   | 0  | 197   |
| Total Approved Trips          | 0              | 4   | 6   | 31            | 57   | 4  | 0              | 24  | 3  | 0             | 68   | 0  | 197   |
| Background Conditions         | 46             | 167 | 124 | 242           | 847  | 44 | 33             | 395 | 74 | 43            | 716  | 48 | 2779  |
| <b>2015 Project Trips</b>     |                |     |     |               |      |    |                |     |    |               |      |    |       |
| BART                          | 0              | 0   | 1   | -4            | -2   | 0  | 1              | 0   | 0  | 0             | 6    | 0  | 2     |
| Joint Development             | 0              | 0   | 2   | 2             | 16   | 0  | 0              | 0   | 0  | 0             | 110  | 0  | 130   |
| Net 2015 Trips                | 0              | 0   | 3   | -2            | 14   | 0  | 1              | 0   | 0  | 0             | 116  | 0  | 132   |
| Existing + Project            | 46             | 163 | 121 | 209           | 804  | 40 | 34             | 371 | 71 | 43            | 764  | 48 | 2714  |
| <b>2025 Project Trips</b>     |                |     |     |               |      |    |                |     |    |               |      |    |       |
| BART                          | -1             | 0   | 1   | -8            | -12  | 0  | 2              | 0   | 0  | 0             | 1    | 0  | -17   |
| Joint Development             | 0              | 0   | 2   | 1             | 18   | 0  | 5              | 0   | 0  | 0             | 92   | 0  | 118   |
| Net 2025 Trips                | -1             | 0   | 3   | -7            | 6    | 0  | 7              | 0   | 0  | 0             | 93   | 0  | 101   |
| Background + Project          | 45             | 167 | 127 | 235           | 853  | 44 | 40             | 395 | 74 | 43            | 809  | 48 | 2880  |
| Cumulative No Project         | 64             | 167 | 201 | 305           | 1064 | 44 | 48             | 417 | 99 | 43            | 989  | 48 | 3441  |
| <b>2035 Project Trips</b>     |                |     |     |               |      |    |                |     |    |               |      |    |       |
| BART                          | 0              | 0   | 1   | -7            | -5   | 0  | 2              | 0   | 0  | 0             | 14   | 1  | 6     |
| Joint Development             | 0              | 0   | 2   | 1             | 13   | 0  | 4              | 0   | 0  | 0             | 66   | 0  | 86    |
| Net 2035 Trips                | 0              | 0   | 3   | -6            | 8    | 0  | 6              | 0   | 0  | 0             | 80   | 1  | 92    |
| Cumulative                    | 64             | 167 | 204 | 299           | 1072 | 44 | 54             | 417 | 99 | 43            | 1069 | 49 | 3581  |

Intersection Number: **45**  
 Traffic Node Number: 7  
 Intersection Name: Lafayette St & Reed St  
 Peak Hour: AM  
 Count Date: 01/01/13  
 Scenario: BART Extension Phase II  
 Date of Analysis: 09/02/15

| Scenario:                     | Movements      |     |    |               |    |    |                |      |    |               |    |    | Total |
|-------------------------------|----------------|-----|----|---------------|----|----|----------------|------|----|---------------|----|----|-------|
|                               | North Approach |     |    | East Approach |    |    | South Approach |      |    | West Approach |    |    |       |
|                               | RT             | TH  | LT | RT            | TH | LT | RT             | TH   | LT | RT            | TH | LT |       |
| Existing Conditions           | 20             | 409 | 19 | 35            | 4  | 25 | 73             | 1606 | 0  | 4             | 0  | 4  | 2199  |
| <b>Approved Project Trips</b> |                |     |    |               |    |    |                |      |    |               |    |    |       |
| San Jose ATI                  | 0              | 0   | 0  | 0             | 0  | 0  | 0              | 0    | 0  | 0             | 0  | 0  | 0     |
| Santa Clara ATI               | 0              | 31  | 2  | 0             | 0  | 0  | 0              | 183  | 0  | 0             | 0  | 0  | 216   |
| Total Approved Trips          | 0              | 31  | 2  | 0             | 0  | 0  | 0              | 183  | 0  | 0             | 0  | 0  | 216   |
| Background Conditions         | 20             | 440 | 21 | 35            | 4  | 25 | 73             | 1789 | 0  | 4             | 0  | 4  | 2415  |
| <b>2015 Project Trips</b>     |                |     |    |               |    |    |                |      |    |               |    |    |       |
| BART                          | 0              | 0   | 0  | 0             | 0  | 0  | 0              | -2   | 0  | 0             | 0  | 0  | -2    |
| Joint Development             | 0              | 0   | 2  | 0             | 0  | 0  | 2              | 2    | 0  | 0             | 0  | 0  | 6     |
| Net 2015 Trips                | 0              | 0   | 2  | 0             | 0  | 0  | 2              | 0    | 0  | 0             | 0  | 0  | 4     |
| Existing + Project            | 20             | 409 | 21 | 35            | 4  | 25 | 75             | 1606 | 0  | 4             | 0  | 4  | 2203  |
| <b>2025 Project Trips</b>     |                |     |    |               |    |    |                |      |    |               |    |    |       |
| BART                          | 0              | -2  | 0  | -1            | 0  | 0  | 2              | -13  | 0  | 0             | 0  | 0  | -14   |
| Joint Development             | 0              | 2   | 2  | 0             | 0  | 0  | 12             | 1    | 0  | 0             | 0  | 0  | 17    |
| Net 2025 Trips                | 0              | 0   | 2  | -1            | 0  | 0  | 14             | -12  | 0  | 0             | 0  | 0  | 3     |
| Background + Project          | 20             | 440 | 23 | 34            | 4  | 25 | 87             | 1777 | 0  | 4             | 0  | 4  | 2418  |
| Cumulative No Project         | 20             | 794 | 23 | 57            | 4  | 40 | 88             | 1789 | 0  | 4             | 0  | 4  | 2819  |
| <b>2035 Project Trips</b>     |                |     |    |               |    |    |                |      |    |               |    |    |       |
| BART                          | 0              | -2  | 1  | -1            | 0  | 0  | 10             | -6   | 0  | 0             | 0  | 0  | 2     |
| Joint Development             | 0              | 6   | 2  | 0             | 0  | 0  | 6              | 7    | 0  | 0             | 0  | 0  | 21    |
| Cumulative                    | 20             | 798 | 26 | 56            | 4  | 40 | 104            | 1790 | 0  | 4             | 0  | 4  | 2846  |

Intersection Number: **46**  
 Traffic Node Number: 1202  
 Intersection Name: Lafayette St & El Camino Real  
 Peak Hour: AM  
 Count Date: 10/08/14  
 Scenario: BART Extension Phase II  
 Date of Analysis: 09/02/15

| Scenario:                     | Movements      |     |     |               |      |    |                |      |     |               |     |     | Total |
|-------------------------------|----------------|-----|-----|---------------|------|----|----------------|------|-----|---------------|-----|-----|-------|
|                               | North Approach |     |     | East Approach |      |    | South Approach |      |     | West Approach |     |     |       |
|                               | RT             | TH  | LT  | RT            | TH   | LT | RT             | TH   | LT  | RT            | TH  | LT  |       |
| Existing Conditions           | 153            | 246 | 88  | 480           | 833  | 9  | 96             | 942  | 132 | 119           | 401 | 264 | 3763  |
| <b>Approved Project Trips</b> |                |     |     |               |      |    |                |      |     |               |     |     |       |
| San Jose ATI                  | 0              | 0   | 0   | 0             | 0    | 0  | 0              | 0    | 0   | 0             | 0   | 0   | 0     |
| Santa Clara ATI               | 7              | 19  | 5   | 5             | 80   | 0  | 0              | 146  | 7   | 9             | 50  | 32  | 360   |
| Total Approved Trips          | 7              | 19  | 5   | 5             | 80   | 0  | 0              | 146  | 7   | 9             | 50  | 32  | 360   |
| Background Conditions         | 160            | 265 | 93  | 485           | 913  | 9  | 96             | 1088 | 139 | 128           | 451 | 296 | 4123  |
| <b>2015 Project Trips</b>     |                |     |     |               |      |    |                |      |     |               |     |     |       |
| BART                          | 0              | 0   | 1   | -1            | -6   | 0  | 5              | -1   | 0   | 0             | 9   | 0   | 7     |
| Joint Development             | 0              | 0   | 2   | 3             | 19   | 0  | 32             | 0    | 0   | 0             | 112 | 0   | 168   |
| Net 2015 Trips                | 0              | 0   | 3   | 2             | 13   | 0  | 37             | -1   | 0   | 0             | 121 | 0   | 175   |
| Existing + Project            | 153            | 246 | 91  | 482           | 846  | 9  | 133            | 941  | 132 | 119           | 522 | 264 | 3938  |
| <b>2025 Project Trips</b>     |                |     |     |               |      |    |                |      |     |               |     |     |       |
| BART                          | 0              | -2  | -2  | -6            | -18  | 0  | 4              | -5   | -1  | 0             | 3   | 1   | -26   |
| Joint Development             | 0              | 2   | 2   | 3             | 18   | 0  | 41             | 8    | 2   | 0             | 99  | 1   | 176   |
| Net 2025 Trips                | 0              | 0   | 0   | -3            | 0    | 0  | 45             | 3    | 1   | 0             | 102 | 2   | 150   |
| Background + Project          | 160            | 265 | 93  | 482           | 913  | 9  | 141            | 1091 | 140 | 128           | 553 | 298 | 4273  |
| Cumulative No Project         | 165            | 479 | 275 | 601           | 997  | 13 | 96             | 1088 | 326 | 151           | 671 | 400 | 4862  |
| <b>2035 Project Trips</b>     |                |     |     |               |      |    |                |      |     |               |     |     |       |
| BART                          | 0              | -2  | -1  | 0             | -12  | 0  | 4              | -1   | -1  | 0             | 16  | 2   | 5     |
| Joint Development             | 0              | 4   | 4   | 2             | 15   | 0  | 42             | 4    | 0   | 0             | 69  | 3   | 143   |
| Net 2035 Trips                | 0              | 2   | 3   | 2             | 3    | 0  | 46             | 3    | -1  | 0             | 85  | 5   | 148   |
| Cumulative                    | 165            | 481 | 278 | 603           | 1000 | 13 | 142            | 1091 | 325 | 151           | 756 | 405 | 5410  |

Intersection Number: 47  
 Trafix Node Number: 5444  
 Intersection Name: Lafayette St & Lewis St  
 Peak Hour: AM  
 Count Date: 10/08/14  
 Scenario: BART Extension Phase II  
 Date of Analysis: 09/02/15

| Scenario:                     | Movements      |     |    |               |    |     |                |      |    |               |    |    | Total |
|-------------------------------|----------------|-----|----|---------------|----|-----|----------------|------|----|---------------|----|----|-------|
|                               | North Approach |     |    | East Approach |    |     | South Approach |      |    | West Approach |    |    |       |
|                               | RT             | TH  | LT | RT            | TH | LT  | RT             | TH   | LT | RT            | TH | LT |       |
| Existing Conditions           | 5              | 391 | 0  | 97            | 63 | 121 | 0              | 1069 | 5  | 0             | 0  | 0  | 1751  |
| <b>Approved Project Trips</b> |                |     |    |               |    |     |                |      |    |               |    |    |       |
| San Jose ATI                  | 0              | 0   | 0  | 0             | 0  | 0   | 0              | 0    | 0  | 0             | 0  | 0  | 0     |
| Santa Clara ATI               | 0              | 28  | 0  | 0             | 0  | 0   | 0              | 152  | 0  | 0             | 0  | 0  | 180   |
| Total Approved Trips          | 0              | 28  | 0  | 0             | 0  | 0   | 0              | 152  | 0  | 0             | 0  | 0  | 180   |
| Background Conditions         | 5              | 419 | 0  | 97            | 63 | 121 | 0              | 1221 | 5  | 0             | 0  | 0  | 1931  |
| <b>2015 Project Trips</b>     |                |     |    |               |    |     |                |      |    |               |    |    |       |
| BART                          | 0              | 0   | 0  | 0             | 1  | -1  | 0              | 3    | 0  | 0             | 0  | 0  | 3     |
| Joint Development             | 0              | 0   | 0  | 0             | 0  | 11  | 0              | 32   | 0  | 0             | 0  | 0  | 43    |
| Net 2015 Trips                | 0              | 0   | 0  | 0             | 1  | 10  | 0              | 35   | 0  | 0             | 0  | 0  | 46    |
| Existing + Project            | 5              | 391 | 0  | 97            | 64 | 131 | 0              | 1104 | 5  | 0             | 0  | 0  | 1797  |
| <b>2025 Project Trips</b>     |                |     |    |               |    |     |                |      |    |               |    |    |       |
| BART                          | 0              | -2  | 0  | 0             | -1 | -4  | 0              | -4   | 0  | 0             | 0  | 0  | -11   |
| Joint Development             | 0              | 2   | 0  | 2             | 0  | 18  | 0              | 49   | 0  | 0             | 0  | 0  | 71    |
| Net 2025 Trips                | 0              | 0   | 0  | 2             | -1 | 14  | 0              | 45   | 0  | 0             | 0  | 0  | 60    |
| Background + Project          | 5              | 419 | 0  | 99            | 62 | 135 | 0              | 1266 | 5  | 0             | 0  | 0  | 1991  |
| Cumulative No Project         | 16             | 649 | 0  | 159           | 68 | 121 | 0              | 1221 | 11 | 0             | 0  | 0  | 2245  |
| <b>2035 Project Trips</b>     |                |     |    |               |    |     |                |      |    |               |    |    |       |
| BART                          | 0              | -2  | 0  | -1            | 0  | -2  | 0              | 3    | 0  | 0             | 0  | 0  | -2    |
| Joint Development             | 0              | 4   | 0  | 0             | 0  | 16  | 0              | 48   | 0  | 0             | 0  | 0  | 68    |
| Net 2035 Trips                | 0              | 2   | 0  | -1            | 0  | 14  | 0              | 51   | 0  | 0             | 0  | 0  | 66    |
| Cumulative                    | 16             | 651 | 0  | 158           | 68 | 135 | 0              | 1272 | 11 | 0             | 0  | 0  | 2311  |

Intersection Number: 48  
 Trafix Node Number: 1008  
 Intersection Name: Lafayette St & Harrison St  
 Peak Hour: AM  
 Count Date: 10/08/14  
 Scenario: BART Extension Phase II  
 Date of Analysis: 09/02/15

| Scenario:                     | Movements      |     |     |               |    |    |                |      |    |               |    |    | Total |
|-------------------------------|----------------|-----|-----|---------------|----|----|----------------|------|----|---------------|----|----|-------|
|                               | North Approach |     |     | East Approach |    |    | South Approach |      |    | West Approach |    |    |       |
|                               | RT             | TH  | LT  | RT            | TH | LT | RT             | TH   | LT | RT            | TH | LT |       |
| Existing Conditions           | 0              | 405 | 78  | 8             | 1  | 4  | 61             | 1088 | 2  | 14            | 23 | 3  | 1687  |
| <b>Approved Project Trips</b> |                |     |     |               |    |    |                |      |    |               |    |    |       |
| San Jose ATI                  | 0              | 0   | 0   | 0             | 0  | 0  | 0              | 0    | 0  | 0             | 0  | 0  | 0     |
| Santa Clara ATI               | 0              | 28  | 0   | 0             | 0  | 0  | 0              | 152  | 0  | 0             | 0  | 0  | 180   |
| Total Approved Trips          | 0              | 28  | 0   | 0             | 0  | 0  | 0              | 152  | 0  | 0             | 0  | 0  | 180   |
| Background Conditions         | 0              | 433 | 78  | 8             | 1  | 4  | 61             | 1240 | 2  | 14            | 23 | 3  | 1867  |
| <b>2015 Project Trips</b>     |                |     |     |               |    |    |                |      |    |               |    |    |       |
| BART                          | 0              | -2  | 0   | 0             | 0  | 0  | 0              | 5    | 0  | 0             | 0  | 0  | 3     |
| Joint Development             | 0              | 11  | 0   | 0             | 0  | 0  | 14             | 31   | 0  | 0             | 0  | 0  | 56    |
| Net 2015 Trips                | 0              | 9   | 0   | 0             | 0  | 0  | 14             | 36   | 0  | 0             | 0  | 0  | 59    |
| Existing + Project            | 0              | 414 | 78  | 8             | 1  | 4  | 75             | 1124 | 2  | 14            | 23 | 3  | 1746  |
| <b>2025 Project Trips</b>     |                |     |     |               |    |    |                |      |    |               |    |    |       |
| BART                          | 0              | -5  | 0   | 0             | 0  | 0  | 3              | -4   | 0  | 0             | 1  | 0  | -5    |
| Joint Development             | 0              | 20  | 0   | 0             | 0  | 0  | 32             | 49   | 0  | 0             | 0  | 0  | 101   |
| Net 2025 Trips                | 0              | 15  | 0   | 0             | 0  | 0  | 35             | 45   | 0  | 0             | 1  | 0  | 96    |
| Background + Project          | 0              | 448 | 78  | 8             | 1  | 4  | 96             | 1285 | 2  | 14            | 24 | 3  | 1963  |
| Cumulative No Project         | 0              | 590 | 115 | 8             | 1  | 58 | 131            | 1240 | 2  | 14            | 34 | 3  | 2193  |
| <b>2035 Project Trips</b>     |                |     |     |               |    |    |                |      |    |               |    |    |       |
| BART                          | 0              | -4  | 0   | 0             | 0  | 0  | 13             | 2    | 0  | 0             | 2  | 1  | 14    |
| Joint Development             | 0              | 20  | 0   | 0             | 0  | 0  | 28             | 47   | 0  | 0             | 3  | 0  | 98    |
| Net 2035 Trips                | 0              | 16  | 0   | 0             | 0  | 0  | 41             | 49   | 0  | 0             | 5  | 1  | 112   |
| Cumulative                    | 0              | 606 | 115 | 8             | 1  | 58 | 172            | 1289 | 2  | 14            | 39 | 4  | 2308  |

Intersection Number: **49**  
 Trafix Node Number: 107  
 Intersection Name: Lafayette St & Benton St  
 Peak Hour: AM  
 Count Date: 10/08/14  
 Scenario: BART Extension Phase II  
 Date of Analysis: 09/02/15

| Scenario:                     | Movements      |     |    |               |    |    |                |      |    |               |     |     | Total |
|-------------------------------|----------------|-----|----|---------------|----|----|----------------|------|----|---------------|-----|-----|-------|
|                               | North Approach |     |    | East Approach |    |    | South Approach |      |    | West Approach |     |     |       |
|                               | RT             | TH  | LT | RT            | TH | LT | RT             | TH   | LT | RT            | TH  | LT  |       |
| Existing Conditions           | 28             | 371 | 7  | 7             | 59 | 19 | 171            | 1113 | 19 | 50            | 282 | 33  | 2159  |
| <b>Approved Project Trips</b> |                |     |    |               |    |    |                |      |    |               |     |     |       |
| San Jose ATI                  | 0              | 0   | 0  | 0             | 0  | 0  | 0              | 0    | 0  | 0             | 0   | 0   | 0     |
| Santa Clara ATI               | 0              | 24  | 4  | 27            | 1  | 0  | 0              | 125  | 0  | 0             | 7   | 0   | 188   |
| Total Approved Trips          | 0              | 24  | 4  | 27            | 1  | 0  | 0              | 125  | 0  | 0             | 7   | 0   | 188   |
| Background Conditions         | 28             | 395 | 11 | 34            | 60 | 19 | 171            | 1238 | 19 | 50            | 289 | 33  | 2347  |
| <b>2015 Project Trips</b>     |                |     |    |               |    |    |                |      |    |               |     |     |       |
| BART                          | 0              | -1  | 0  | 0             | 1  | 1  | 0              | 5    | 0  | 0             | 1   | 1   | 8     |
| Joint Development             | 0              | 11  | 0  | 0             | 0  | 0  | 0              | 43   | 0  | 0             | 0   | 3   | 57    |
| Net 2015 Trips                | 0              | 10  | 0  | 0             | 1  | 1  | 0              | 48   | 0  | 0             | 1   | 4   | 65    |
| Existing + Project            | 28             | 381 | 7  | 7             | 60 | 20 | 171            | 1161 | 19 | 50            | 283 | 37  | 2224  |
| <b>2025 Project Trips</b>     |                |     |    |               |    |    |                |      |    |               |     |     |       |
| BART                          | -1             | -3  | 0  | 0             | 1  | 1  | 0              | -2   | 0  | -1            | 1   | 1   | -3    |
| Joint Development             | 0              | 19  | 0  | 0             | 0  | 0  | 0              | 67   | 0  | 0             | 0   | 13  | 99    |
| Net 2025 Trips                | -1             | 16  | 0  | 0             | 1  | 1  | 0              | 65   | 0  | -1            | 1   | 14  | 96    |
| Background + Project          | 27             | 411 | 11 | 34            | 61 | 20 | 171            | 1303 | 19 | 49            | 290 | 47  | 2443  |
| Cumulative No Project         | 48             | 568 | 27 | 34            | 65 | 37 | 171            | 1238 | 19 | 79            | 334 | 80  | 2620  |
| <b>2035 Project Trips</b>     |                |     |    |               |    |    |                |      |    |               |     |     |       |
| BART                          | -1             | -2  | 0  | 0             | 4  | 1  | -2             | 10   | 0  | -3            | 1   | 5   | 13    |
| Joint Development             | 0              | 20  | 0  | 0             | 0  | 0  | 0              | 58   | 0  | 0             | 0   | 17  | 95    |
| Net 2035 Trips                | -1             | 18  | 0  | 0             | 4  | 1  | -2             | 68   | 0  | -3            | 1   | 22  | 108   |
| Cumulative                    | 47             | 586 | 27 | 34            | 69 | 38 | 169            | 1306 | 19 | 76            | 335 | 102 | 2808  |

Intersection Number: **50**  
 Trafix Node Number: 128  
 Intersection Name: Lafayette St & Homestead Rd  
 Peak Hour: AM  
 Count Date: 05/21/15  
 Scenario: BART Extension Phase II  
 Date of Analysis: 09/02/15

| Scenario:                     | Movements      |     |    |               |    |    |                |      |     |               |    |     | Total |
|-------------------------------|----------------|-----|----|---------------|----|----|----------------|------|-----|---------------|----|-----|-------|
|                               | North Approach |     |    | East Approach |    |    | South Approach |      |     | West Approach |    |     |       |
|                               | RT             | TH  | LT | RT            | TH | LT | RT             | TH   | LT  | RT            | TH | LT  |       |
| Existing Conditions           | 86             | 372 | 0  | 0             | 0  | 0  | 0              | 1180 | 120 | 85            | 0  | 168 | 2011  |
| <b>Approved Project Trips</b> |                |     |    |               |    |    |                |      |     |               |    |     |       |
| San Jose ATI                  | 0              | 0   | 0  | 0             | 0  | 0  | 0              | 0    | 0   | 0             | 0  | 0   | 0     |
| Santa Clara ATI               | 0              | 24  | 0  | 0             | 0  | 0  | 0              | 125  | 0   | 0             | 0  | 0   | 149   |
| Total Approved Trips          | 0              | 24  | 0  | 0             | 0  | 0  | 0              | 125  | 0   | 0             | 0  | 0   | 149   |
| Background Conditions         | 86             | 396 | 0  | 0             | 0  | 0  | 0              | 1305 | 120 | 85            | 0  | 168 | 2160  |
| <b>2015 Project Trips</b>     |                |     |    |               |    |    |                |      |     |               |    |     |       |
| BART                          | 0              | 0   | 0  | 0             | 0  | 0  | 0              | -1   | -4  | -2            | 0  | 2   | -5    |
| Joint Development             | 0              | 10  | 0  | 0             | 0  | 0  | 0              | 42   | 0   | 0             | 0  | 0   | 52    |
| Net 2015 Trips                | 0              | 10  | 0  | 0             | 0  | 0  | 0              | 41   | -4  | -2            | 0  | 2   | 47    |
| Existing + Project            | 86             | 382 | 0  | 0             | 0  | 0  | 0              | 1221 | 116 | 83            | 0  | 170 | 2058  |
| <b>2025 Project Trips</b>     |                |     |    |               |    |    |                |      |     |               |    |     |       |
| BART                          | 0              | -5  | 0  | 0             | 0  | 0  | 0              | -7   | -6  | -2            | 0  | 3   | -17   |
| Joint Development             | 0              | 19  | 0  | 0             | 0  | 0  | 0              | 67   | 0   | 0             | 0  | 0   | 86    |
| Net 2025 Trips                | 0              | 14  | 0  | 0             | 0  | 0  | 0              | 60   | -6  | -2            | 0  | 3   | 69    |
| Background + Project          | 86             | 410 | 0  | 0             | 0  | 0  | 0              | 1365 | 114 | 83            | 0  | 171 | 2229  |
| Cumulative No Project         | 96             | 587 | 0  | 0             | 0  | 0  | 0              | 1305 | 120 | 85            | 0  | 168 | 2193  |
| <b>2035 Project Trips</b>     |                |     |    |               |    |    |                |      |     |               |    |     |       |
| BART                          | 1              | -5  | 0  | 0             | 0  | 0  | 0              | 1    | -5  | -3            | 0  | 4   | -7    |
| Joint Development             | 0              | 19  | 0  | 0             | 0  | 0  | 0              | 58   | 0   | 0             | 0  | 0   | 77    |
| Net 2035 Trips                | 1              | 14  | 0  | 0             | 0  | 0  | 0              | 59   | -5  | -3            | 0  | 4   | 70    |
| Cumulative                    | 97             | 601 | 0  | 0             | 0  | 0  | 0              | 1364 | 115 | 82            | 0  | 172 | 2431  |

Intersection Number: **51**  
 Trafix Node Number: 121  
 Intersection Name: Lafayette St & Market St  
 Peak Hour: AM  
 Count Date: 05/21/15  
 Scenario: BART Extension Phase II  
 Date of Analysis: 09/02/15

| Scenario:                     | Movements      |     |     |               |     |    |                |      |    |               |     |    | Total |
|-------------------------------|----------------|-----|-----|---------------|-----|----|----------------|------|----|---------------|-----|----|-------|
|                               | North Approach |     |     | East Approach |     |    | South Approach |      |    | West Approach |     |    |       |
|                               | RT             | TH  | LT  | RT            | TH  | LT | RT             | TH   | LT | RT            | TH  | LT |       |
| Existing Conditions           | 85             | 262 | 123 | 256           | 54  | 7  | 9              | 1043 | 78 | 15            | 59  | 73 | 2064  |
| <b>Approved Project Trips</b> |                |     |     |               |     |    |                |      |    |               |     |    |       |
| San Jose ATI                  | 0              | 0   | 0   | 0             | 0   | 0  | 0              | 0    | 0  | 0             | 0   | 0  | 0     |
| Santa Clara ATI               | 0              | 24  | 0   | 0             | 0   | 0  | 0              | 125  | 0  | 0             | 0   | 0  | 149   |
| Total Approved Trips          | 0              | 24  | 0   | 0             | 0   | 0  | 0              | 125  | 0  | 0             | 0   | 0  | 149   |
| Background Conditions         | 85             | 286 | 123 | 256           | 54  | 7  | 9              | 1168 | 78 | 15            | 59  | 73 | 2213  |
| <b>2015 Project Trips</b>     |                |     |     |               |     |    |                |      |    |               |     |    |       |
| BART                          | 1              | -1  | -2  | -6            | -2  | 0  | 0              | 0    | 0  | 0             | -3  | 1  | -12   |
| Joint Development             | 7              | 3   | 0   | 0             | 0   | 0  | 0              | 25   | 0  | 0             | 0   | 17 | 52    |
| Net 2015 Trips                | 8              | 2   | -2  | -6            | -2  | 0  | 0              | 25   | 0  | 0             | -3  | 18 | 40    |
| Existing + Project            | 93             | 264 | 121 | 250           | 52  | 7  | 9              | 1068 | 78 | 15            | 56  | 91 | 2104  |
| <b>2025 Project Trips</b>     |                |     |     |               |     |    |                |      |    |               |     |    |       |
| BART                          | 0              | -1  | -4  | -5            | -2  | 0  | 0              | -7   | -1 | 0             | -6  | 1  | -25   |
| Joint Development             | 10             | 9   | 0   | 0             | 0   | 0  | 0              | 48   | 0  | 0             | 0   | 19 | 86    |
| Net 2025 Trips                | 10             | 8   | -4  | -5            | -2  | 0  | 0              | 41   | -1 | 0             | -6  | 20 | 61    |
| Background + Project          | 95             | 294 | 119 | 251           | 52  | 7  | 9              | 1209 | 77 | 15            | 53  | 93 | 2274  |
| Cumulative No Project         | 182            | 338 | 149 | 256           | 185 | 8  | 9              | 1168 | 94 | 23            | 176 | 73 | 2588  |
| <b>2035 Project Trips</b>     |                |     |     |               |     |    |                |      |    |               |     |    |       |
| BART                          | 2              | -1  | -6  | -6            | -2  | 0  | 0              | -4   | -3 | 0             | -7  | 5  | -22   |
| Joint Development             | 9              | 10  | 0   | 0             | 0   | 0  | 0              | 44   | 0  | 0             | 1   | 15 | 79    |
| Net 2035 Trips                | 11             | 9   | -6  | -6            | -2  | 0  | 0              | 40   | -3 | 0             | -6  | 20 | 57    |
| Cumulative                    | 193            | 347 | 143 | 250           | 183 | 8  | 9              | 1208 | 91 | 23            | 170 | 93 | 2718  |

Intersection Number: **52**  
 Trafix Node Number: 106  
 Intersection Name: El Camino Real & Benton St  
 Peak Hour: AM  
 Count Date: 10/08/14  
 Scenario: BART Extension Phase II  
 Date of Analysis: 09/02/15

| Scenario:                     | Movements      |     |    |               |    |    |                |      |     |               |    |    | Total |
|-------------------------------|----------------|-----|----|---------------|----|----|----------------|------|-----|---------------|----|----|-------|
|                               | North Approach |     |    | East Approach |    |    | South Approach |      |     | West Approach |    |    |       |
|                               | RT             | TH  | LT | RT            | TH | LT | RT             | TH   | LT  | RT            | TH | LT |       |
| Existing Conditions           | 19             | 391 | 71 | 39            | 19 | 3  | 9              | 1194 | 92  | 128           | 37 | 22 | 2024  |
| <b>Approved Project Trips</b> |                |     |    |               |    |    |                |      |     |               |    |    |       |
| San Jose ATI                  | 0              | 0   | 0  | 0             | 0  | 0  | 0              | 0    | 0   | 0             | 0  | 0  | 0     |
| Santa Clara ATI               | 0              | 56  | 0  | 0             | 0  | 4  | 27             | 86   | 1   | 4             | 0  | 1  | 179   |
| Total Approved Trips          | 0              | 56  | 0  | 0             | 0  | 4  | 27             | 86   | 1   | 4             | 0  | 1  | 179   |
| Background Conditions         | 19             | 447 | 71 | 39            | 19 | 7  | 36             | 1280 | 93  | 132           | 37 | 23 | 2203  |
| <b>2015 Project Trips</b>     |                |     |    |               |    |    |                |      |     |               |    |    |       |
| BART                          | 0              | -3  | 1  | 3             | 2  | 0  | 0              | 4    | -9  | 0             | 2  | 0  | 0     |
| Joint Development             | 0              | 1   | 0  | 0             | 0  | 0  | 0              | 73   | 0   | 0             | 0  | 0  | 74    |
| Net 2015 Trips                | 0              | -2  | 1  | 3             | 2  | 0  | 0              | 77   | -9  | 0             | 2  | 0  | 74    |
| Existing + Project            | 19             | 389 | 72 | 42            | 21 | 3  | 9              | 1271 | 83  | 128           | 39 | 22 | 2098  |
| <b>2025 Project Trips</b>     |                |     |    |               |    |    |                |      |     |               |    |    |       |
| BART                          | 0              | -6  | 1  | 4             | 3  | 0  | 0              | -2   | -9  | -2            | 3  | 0  | -8    |
| Joint Development             | 0              | 4   | 0  | 0             | 0  | 0  | 0              | 60   | 0   | 0             | 0  | 0  | 64    |
| Net 2025 Trips                | 0              | -2  | 1  | 4             | 3  | 0  | 0              | 58   | -9  | -2            | 3  | 0  | 56    |
| Background + Project          | 19             | 445 | 72 | 43            | 22 | 7  | 36             | 1338 | 84  | 130           | 40 | 23 | 2259  |
| Cumulative No Project         | 19             | 892 | 71 | 39            | 19 | 7  | 36             | 1707 | 93  | 194           | 37 | 23 | 3114  |
| <b>2035 Project Trips</b>     |                |     |    |               |    |    |                |      |     |               |    |    |       |
| BART                          | 0              | -10 | 1  | 5             | 6  | 0  | 0              | 11   | -11 | -5            | 3  | 0  | 0     |
| Joint Development             | 0              | 5   | 0  | 0             | 0  | 0  | 0              | 61   | 0   | 0             | 0  | 0  | 66    |
| Net 2035 Trips                | 0              | -5  | 1  | 5             | 6  | 0  | 0              | 72   | -11 | -5            | 3  | 0  | 66    |
| Cumulative                    | 19             | 887 | 72 | 44            | 25 | 7  | 36             | 1779 | 82  | 189           | 40 | 23 | 3203  |

Intersection Number: **53**  
 Trafix Node Number: 1012  
 Intersection Name: El Camino Real & Railroad Ave  
 Peak Hour: AM  
 Count Date: 10/08/14  
 Scenario: BART Extension Phase II  
 Date of Analysis: 09/02/15

| Scenario:                     | Movements      |     |    |               |    |    |                |      |     |               |    |    | Total |
|-------------------------------|----------------|-----|----|---------------|----|----|----------------|------|-----|---------------|----|----|-------|
|                               | North Approach |     |    | East Approach |    |    | South Approach |      |     | West Approach |    |    |       |
|                               | RT             | TH  | LT | RT            | TH | LT | RT             | TH   | LT  | RT            | TH | LT |       |
| Existing Conditions           | 90             | 372 | 55 | 57            | 10 | 38 | 52             | 1228 | 175 | 21            | 0  | 11 | 2109  |
| <b>Approved Project Trips</b> |                |     |    |               |    |    |                |      |     |               |    |    |       |
| San Jose ATI                  | 0              | 0   | 0  | 0             | 0  | 0  | 0              | 0    | 0   | 0             | 0  | 0  | 0     |
| Santa Clara ATI               | 0              | 64  | 0  | 0             | 0  | 0  | 0              | 114  | 0   | 0             | 0  | 0  | 178   |
| Total Approved Trips          | 0              | 64  | 0  | 0             | 0  | 0  | 0              | 114  | 0   | 0             | 0  | 0  | 178   |
| Background Conditions         | 90             | 436 | 55 | 57            | 10 | 38 | 52             | 1342 | 175 | 21            | 0  | 11 | 2287  |
| <b>2015 Project Trips</b>     |                |     |    |               |    |    |                |      |     |               |    |    |       |
| BART                          | -2             | -1  | 0  | 0             | 0  | 2  | 1              | -3   | -11 | -2            | 0  | -1 | -17   |
| Joint Development             | 0              | 0   | 0  | 0             | 0  | 0  | 0              | 74   | 0   | 0             | 0  | 0  | 74    |
| Net 2015 Trips                | -2             | -1  | 0  | 0             | 0  | 2  | 1              | 71   | -11 | -2            | 0  | -1 | 57    |
| Existing + Project            | 88             | 371 | 55 | 57            | 10 | 40 | 53             | 1299 | 164 | 19            | 0  | 10 | 2166  |
| <b>2025 Project Trips</b>     |                |     |    |               |    |    |                |      |     |               |    |    |       |
| BART                          | -3             | -4  | 0  | 0             | 0  | 2  | 0              | -10  | -11 | -4            | 0  | -1 | -31   |
| Joint Development             | 0              | 3   | 0  | 0             | 0  | 0  | 0              | 60   | 0   | 0             | 0  | 0  | 63    |
| Net 2025 Trips                | -3             | -1  | 0  | 0             | 0  | 2  | 0              | 50   | -11 | -4            | 0  | -1 | 32    |
| Background + Project          | 87             | 435 | 55 | 57            | 10 | 40 | 52             | 1392 | 164 | 17            | 0  | 10 | 2319  |
| Cumulative No Project         | 149            | 879 | 55 | 57            | 10 | 38 | 52             | 1711 | 175 | 24            | 0  | 16 | 3150  |
| <b>2035 Project Trips</b>     |                |     |    |               |    |    |                |      |     |               |    |    |       |
| BART                          | -5             | -10 | 0  | 0             | 0  | 4  | -1             | 1    | -13 | -5            | 0  | -1 | -30   |
| Joint Development             | 0              | 5   | 0  | 0             | 0  | 0  | 0              | 61   | 0   | 0             | 0  | 0  | 66    |
| Net 2035 Trips                | -5             | -5  | 0  | 0             | 0  | 4  | -1             | 62   | -13 | -5            | 0  | -1 | 36    |
| Cumulative                    | 144            | 874 | 55 | 57            | 10 | 42 | 51             | 1773 | 162 | 19            | 0  | 15 | 3202  |

Intersection Number: **54**  
 Trafix Node Number: 1213  
 Intersection Name: El Camino Real & The Alameda  
 Peak Hour: AM  
 Count Date: 10/08/14  
 Scenario: BART Extension Phase II  
 Date of Analysis: 09/02/15

| Scenario:                     | Movements      |     |    |               |    |    |                |      |     |               |    |     | Total |
|-------------------------------|----------------|-----|----|---------------|----|----|----------------|------|-----|---------------|----|-----|-------|
|                               | North Approach |     |    | East Approach |    |    | South Approach |      |     | West Approach |    |     |       |
|                               | RT             | TH  | LT | RT            | TH | LT | RT             | TH   | LT  | RT            | TH | LT  |       |
| Existing Conditions           | 49             | 418 | 10 | 3             | 1  | 1  | 18             | 1458 | 176 | 108           | 6  | 105 | 2353  |
| <b>Approved Project Trips</b> |                |     |    |               |    |    |                |      |     |               |    |     |       |
| San Jose ATI                  | 0              | 0   | 0  | 0             | 0  | 0  | 0              | 0    | 0   | 0             | 0  | 0   | 0     |
| Santa Clara ATI               | 0              | 64  | 0  | 0             | 0  | 0  | 0              | 113  | 0   | 0             | 0  | 0   | 177   |
| Total Approved Trips          | 0              | 64  | 0  | 0             | 0  | 0  | 0              | 113  | 0   | 0             | 0  | 0   | 177   |
| Background Conditions         | 49             | 482 | 10 | 3             | 1  | 1  | 18             | 1571 | 176 | 108           | 6  | 105 | 2530  |
| <b>2015 Project Trips</b>     |                |     |    |               |    |    |                |      |     |               |    |     |       |
| BART                          | 1              | -5  | 0  | 0             | 0  | 0  | 0              | -27  | -10 | -8            | 0  | 2   | -47   |
| Joint Development             | 0              | 0   | 0  | 0             | 0  | 0  | 0              | 69   | 0   | 0             | 0  | 1   | 70    |
| Net 2015 Trips                | 1              | -5  | 0  | 0             | 0  | 0  | 0              | 42   | -10 | -8            | 0  | 3   | 23    |
| Existing + Project            | 50             | 413 | 10 | 3             | 1  | 1  | 18             | 1500 | 166 | 100           | 6  | 108 | 2376  |
| <b>2025 Project Trips</b>     |                |     |    |               |    |    |                |      |     |               |    |     |       |
| BART                          | 1              | -10 | 0  | 0             | 0  | 0  | 0              | -39  | -11 | -12           | 0  | 2   | -69   |
| Joint Development             | 0              | 2   | 0  | 0             | 0  | 0  | 0              | 54   | 0   | 1             | 0  | 2   | 59    |
| Net 2025 Trips                | 1              | -8  | 0  | 0             | 0  | 0  | 0              | 15   | -11 | -11           | 0  | 4   | -10   |
| Background + Project          | 50             | 474 | 10 | 3             | 1  | 1  | 18             | 1586 | 165 | 97            | 6  | 109 | 2520  |
| Cumulative No Project         | 52             | 935 | 10 | 3             | 1  | 1  | 18             | 1641 | 176 | 232           | 6  | 246 | 3075  |
| <b>2035 Project Trips</b>     |                |     |    |               |    |    |                |      |     |               |    |     |       |
| BART                          | 1              | -19 | 0  | 0             | 0  | 0  | 0              | -37  | -8  | -18           | 0  | 1   | -80   |
| Joint Development             | 0              | 3   | 0  | 0             | 0  | 0  | 0              | 54   | 0   | 1             | 0  | 4   | 62    |
| Net 2035 Trips                | 1              | -16 | 0  | 0             | 0  | 0  | 0              | 17   | -8  | -17           | 0  | 5   | -18   |
| Cumulative                    | 53             | 919 | 10 | 3             | 1  | 1  | 18             | 1658 | 168 | 215           | 6  | 251 | 3303  |

Intersection Number: **55**  
 Traffic Node Number: 1214  
 Intersection Name: The Alameda & Newhall Dr  
 Peak Hour: AM  
 Count Date: 05/21/15  
 Scenario: BART Extension Phase II  
 Date of Analysis: 09/02/15

| Scenario:                     | Movements      |      |    |               |    |    |                |      |     |               |    |    | Total |
|-------------------------------|----------------|------|----|---------------|----|----|----------------|------|-----|---------------|----|----|-------|
|                               | North Approach |      |    | East Approach |    |    | South Approach |      |     | West Approach |    |    |       |
|                               | RT             | TH   | LT | RT            | TH | LT | RT             | TH   | LT  | RT            | TH | LT |       |
| Existing Conditions           | 21             | 601  | 10 | 28            | 18 | 82 | 32             | 1451 | 54  | 90            | 13 | 61 | 2461  |
| <b>Approved Project Trips</b> |                |      |    |               |    |    |                |      |     |               |    |    |       |
| San Jose ATI                  | 0              | 64   | 0  | 0             | 0  | 0  | 0              | 114  | 0   | 2             | 1  | 3  | 184   |
| Santa Clara ATI               | 0              | 0    | 0  | 0             | 0  | 0  | 0              | 0    | 0   | 0             | 0  | 0  | 0     |
| Total Approved Trips          | 0              | 64   | 0  | 0             | 0  | 0  | 0              | 114  | 0   | 2             | 1  | 3  | 184   |
| Background Conditions         | 21             | 665  | 10 | 28            | 18 | 82 | 32             | 1565 | 54  | 92            | 14 | 64 | 2645  |
| <b>2015 Project Trips</b>     |                |      |    |               |    |    |                |      |     |               |    |    |       |
| BART                          | 0              | -14  | 0  | 0             | 0  | -3 | -1             | -38  | 0   | -6            | 0  | 0  | -62   |
| Joint Development             | 0              | 0    | 0  | 0             | 0  | 1  | 0              | 58   | 0   | 2             | 0  | 12 | 73    |
| Net 2015 Trips                | 0              | -14  | 0  | 0             | 0  | -2 | -1             | 20   | 0   | -4            | 0  | 12 | 11    |
| Existing + Project            | 21             | 587  | 10 | 28            | 18 | 80 | 31             | 1471 | 54  | 86            | 13 | 73 | 2472  |
| <b>2025 Project Trips</b>     |                |      |    |               |    |    |                |      |     |               |    |    |       |
| BART                          | 0              | -23  | 0  | 0             | -1 | -6 | -3             | -48  | -3  | -8            | -1 | -1 | -94   |
| Joint Development             | 0              | 3    | 0  | 0             | 0  | 1  | 0              | 39   | 0   | 3             | 0  | 14 | 60    |
| Net 2025 Trips                | 0              | -20  | 0  | 0             | -1 | -5 | -3             | -9   | -3  | -5            | -1 | 13 | -34   |
| Background + Project          | 21             | 645  | 10 | 28            | 17 | 77 | 29             | 1556 | 51  | 87            | 13 | 77 | 2611  |
| Cumulative No Project         | 67             | 1174 | 33 | 28            | 77 | 82 | 32             | 1642 | 113 | 109           | 55 | 64 | 3412  |
| <b>2035 Project Trips</b>     |                |      |    |               |    |    |                |      |     |               |    |    |       |
| BART                          | 1              | -37  | 0  | 0             | 0  | -8 | -2             | -42  | -2  | -7            | -1 | 0  | -98   |
| Joint Development             | 0              | 4    | 0  | 0             | 0  | 1  | 0              | 39   | 0   | 3             | 0  | 14 | 61    |
| Net 2035 Trips                | 1              | -33  | 0  | 0             | 0  | -7 | -2             | -3   | -2  | -4            | -1 | 14 | -37   |
| Cumulative                    | 68             | 1141 | 33 | 28            | 77 | 75 | 30             | 1639 | 111 | 105           | 54 | 78 | 3439  |

Intersection Number: **56**  
 Traffic Node Number: 3046  
 Intersection Name: The Alameda & I-880 (South)  
 Peak Hour: AM  
 Count Date: 05/07/15  
 Scenario: BART Extension Phase II  
 Date of Analysis: 09/02/15

| Scenario:                     | Movements      |      |    |               |    |     |                |      |    |               |    |    | Total |
|-------------------------------|----------------|------|----|---------------|----|-----|----------------|------|----|---------------|----|----|-------|
|                               | North Approach |      |    | East Approach |    |     | South Approach |      |    | West Approach |    |    |       |
|                               | RT             | TH   | LT | RT            | TH | LT  | RT             | TH   | LT | RT            | TH | LT |       |
| Existing Conditions           | 176            | 670  | 0  | 300           | 0  | 200 | 308            | 1332 | 0  | 0             | 0  | 0  | 2986  |
| <b>Approved Project Trips</b> |                |      |    |               |    |     |                |      |    |               |    |    |       |
| San Jose ATI                  | 17             | 49   | 0  | 39            | 0  | 15  | 5              | 83   | 0  | 0             | 0  | 0  | 208   |
| Santa Clara ATI               | 0              | 0    | 0  | 0             | 0  | 0   | 0              | 0    | 0  | 0             | 0  | 0  | 0     |
| Total Approved Trips          | 17             | 49   | 0  | 39            | 0  | 15  | 5              | 83   | 0  | 0             | 0  | 0  | 208   |
| Background Conditions         | 193            | 719  | 0  | 339           | 0  | 215 | 313            | 1415 | 0  | 0             | 0  | 0  | 3194  |
| <b>2015 Project Trips</b>     |                |      |    |               |    |     |                |      |    |               |    |    |       |
| BART                          | 0              | -22  | 0  | -30           | 0  | 0   | 0              | -10  | 0  | 0             | 0  | 0  | -62   |
| Joint Development             | 0              | 3    | 0  | 21            | 0  | 0   | 0              | 38   | 0  | 0             | 0  | 0  | 62    |
| Net 2015 Trips                | 0              | -19  | 0  | -9            | 0  | 0   | 0              | 28   | 0  | 0             | 0  | 0  | 0     |
| Existing + Project            | 176            | 651  | 0  | 291           | 0  | 200 | 308            | 1360 | 0  | 0             | 0  | 0  | 2986  |
| <b>2025 Project Trips</b>     |                |      |    |               |    |     |                |      |    |               |    |    |       |
| BART                          | 0              | -37  | 0  | -33           | 0  | -3  | 0              | -21  | 0  | 0             | 0  | 0  | -94   |
| Joint Development             | 0              | 7    | 0  | 2             | 0  | 3   | 0              | 37   | 0  | 0             | 0  | 0  | 49    |
| Net 2025 Trips                | 0              | -30  | 0  | -31           | 0  | 0   | 0              | 16   | 0  | 0             | 0  | 0  | -45   |
| Background + Project          | 193            | 689  | 0  | 308           | 0  | 215 | 313            | 1431 | 0  | 0             | 0  | 0  | 3149  |
| Cumulative No Project         | 193            | 1252 | 0  | 339           | 0  | 231 | 313            | 1492 | 0  | 0             | 0  | 0  | 3820  |
| <b>2035 Project Trips</b>     |                |      |    |               |    |     |                |      |    |               |    |    |       |
| BART                          | 0              | -54  | 0  | -31           | 0  | 0   | 0              | -14  | 0  | 0             | 0  | 0  | -99   |
| Joint Development             | 0              | 7    | 0  | 7             | 0  | 2   | 0              | 32   | 0  | 0             | 0  | 0  | 48    |
| Net 2035 Trips                | 0              | -47  | 0  | -24           | 0  | 2   | 0              | 18   | 0  | 0             | 0  | 0  | -51   |
| Cumulative                    | 193            | 1205 | 0  | 315           | 0  | 233 | 313            | 1510 | 0  | 0             | 0  | 0  | 3769  |



Intersection Number: **57**  
 Trafix Node Number: 3047  
 Intersection Name: The Alameda & I-880 (North)  
 Peak Hour: AM  
 Count Date: 05/07/15  
 Scenario: BART Extension Phase II  
 Date of Analysis: 09/02/15

| Scenario:                     | Movements      |      |    |               |    |    |                |      |    |               |    |     | Total |
|-------------------------------|----------------|------|----|---------------|----|----|----------------|------|----|---------------|----|-----|-------|
|                               | North Approach |      |    | East Approach |    |    | South Approach |      |    | West Approach |    |     |       |
|                               | RT             | TH   | LT | RT            | TH | LT | RT             | TH   | LT | RT            | TH | LT  |       |
| Existing Conditions           | 250            | 610  | 0  | 0             | 0  | 0  | 469            | 1440 | 0  | 406           | 13 | 209 | 3397  |
| <b>Approved Project Trips</b> |                |      |    |               |    |    |                |      |    |               |    |     |       |
| San Jose ATI                  | 19             | 39   | 0  | 0             | 0  | 0  | 0              | 48   | 0  | 37            | 0  | 3   | 146   |
| Santa Clara ATI               | 0              | 0    | 0  | 0             | 0  | 0  | 0              | 0    | 0  | 0             | 0  | 0   | 0     |
| Total Approved Trips          | 19             | 39   | 0  | 0             | 0  | 0  | 0              | 48   | 0  | 37            | 0  | 3   | 146   |
| Background Conditions         | 269            | 649  | 0  | 0             | 0  | 0  | 469            | 1488 | 0  | 443           | 13 | 212 | 3543  |
| <b>2015 Project Trips</b>     |                |      |    |               |    |    |                |      |    |               |    |     |       |
| BART                          | 0              | -4   | 0  | 0             | 0  | 0  | 0              | -14  | 0  | 4             | 0  | -2  | -16   |
| Joint Development             | 0              | 1    | 0  | 0             | 0  | 0  | 0              | 25   | 0  | 0             | 0  | 15  | 41    |
| Net 2015 Trips                | 0              | -3   | 0  | 0             | 0  | 0  | 0              | 11   | 0  | 4             | 0  | 13  | 25    |
| Existing + Project            | 250            | 607  | 0  | 0             | 0  | 0  | 469            | 1451 | 0  | 410           | 13 | 222 | 3422  |
| <b>2025 Project Trips</b>     |                |      |    |               |    |    |                |      |    |               |    |     |       |
| BART                          | 0              | -18  | 0  | 0             | 0  | 0  | 0              | -30  | 0  | -6            | 0  | -2  | -56   |
| Joint Development             | 0              | 6    | 0  | 0             | 0  | 0  | 0              | 30   | 0  | 2             | 0  | 8   | 46    |
| Net 2025 Trips                | 0              | -12  | 0  | 0             | 0  | 0  | 0              | 0    | 0  | -4            | 0  | 6   | -10   |
| Background + Project          | 269            | 637  | 0  | 0             | 0  | 0  | 469            | 1488 | 0  | 439           | 13 | 218 | 3533  |
| Cumulative No Project         | 269            | 1045 | 0  | 0             | 0  | 0  | 469            | 1488 | 0  | 841           | 13 | 212 | 4125  |
| <b>2035 Project Trips</b>     |                |      |    |               |    |    |                |      |    |               |    |     |       |
| BART                          | 0              | -32  | 0  | 0             | 0  | 0  | 0              | -24  | 0  | -4            | 0  | -2  | -62   |
| Joint Development             | 0              | 5    | 0  | 0             | 0  | 0  | 0              | 31   | 0  | 3             | 0  | 3   | 42    |
| Net 2035 Trips                | 0              | -27  | 0  | 0             | 0  | 0  | 0              | 7    | 0  | -1            | 0  | 1   | -20   |
| Cumulative                    | 269            | 1018 | 0  | 0             | 0  | 0  | 469            | 1495 | 0  | 840           | 13 | 213 | 4317  |

Intersection Number: **58**  
 Trafix Node Number: 3057  
 Intersection Name: The Alameda & W. Hedding St  
 Peak Hour: AM  
 Count Date: 05/21/15  
 Scenario: BART Extension Phase II  
 Date of Analysis: 09/02/15

| Scenario:                     | Movements      |      |     |               |     |    |                |      |    |               |     |     | Total |
|-------------------------------|----------------|------|-----|---------------|-----|----|----------------|------|----|---------------|-----|-----|-------|
|                               | North Approach |      |     | East Approach |     |    | South Approach |      |    | West Approach |     |     |       |
|                               | RT             | TH   | LT  | RT            | TH  | LT | RT             | TH   | LT | RT            | TH  | LT  |       |
| Existing Conditions           | 49             | 615  | 106 | 120           | 222 | 23 | 92             | 1320 | 40 | 95            | 356 | 190 | 3228  |
| <b>Approved Project Trips</b> |                |      |     |               |     |    |                |      |    |               |     |     |       |
| San Jose ATI                  | 0              | 49   | 23  | 15            | 13  | 8  | 13             | 13   | 4  | 18            | 60  | 10  | 226   |
| Santa Clara ATI               | 0              | 0    | 0   | 0             | 0   | 0  | 0              | 0    | 0  | 0             | 0   | 0   | 0     |
| Total Approved Trips          | 0              | 49   | 23  | 15            | 13  | 8  | 13             | 13   | 4  | 18            | 60  | 10  | 226   |
| Background Conditions         | 49             | 664  | 129 | 135           | 235 | 31 | 105            | 1333 | 44 | 113           | 416 | 200 | 3454  |
| <b>2015 Project Trips</b>     |                |      |     |               |     |    |                |      |    |               |     |     |       |
| BART                          | 0              | -5   | 6   | 0             | -1  | -1 | -3             | -15  | -1 | 0             | 4   | 0   | -16   |
| Joint Development             | 0              | 1    | 0   | 5             | 2   | 2  | 10             | 17   | 7  | 0             | 5   | 1   | 50    |
| Net 2015 Trips                | 0              | -4   | 6   | 5             | 1   | 1  | 7              | 2    | 6  | 0             | 9   | 1   | 34    |
| Existing + Project            | 49             | 611  | 112 | 125           | 223 | 24 | 99             | 1322 | 46 | 95            | 365 | 191 | 3262  |
| <b>2025 Project Trips</b>     |                |      |     |               |     |    |                |      |    |               |     |     |       |
| BART                          | 0              | -22  | -2  | -6            | -15 | -2 | -3             | -25  | -2 | -1            | 2   | 1   | -75   |
| Joint Development             | 3              | 4    | 0   | 8             | 10  | 0  | 4              | 21   | 2  | 0             | 5   | 1   | 58    |
| Net 2025 Trips                | 3              | -18  | -2  | 2             | -5  | -2 | 1              | -4   | 0  | -1            | 7   | 2   | -17   |
| Background + Project          | 52             | 646  | 127 | 137           | 230 | 29 | 106            | 1329 | 44 | 112           | 423 | 202 | 3437  |
| Cumulative No Project         | 92             | 1131 | 419 | 135           | 884 | 31 | 171            | 1333 | 47 | 178           | 770 | 245 | 5191  |
| <b>2035 Project Trips</b>     |                |      |     |               |     |    |                |      |    |               |     |     |       |
| BART                          | 0              | -34  | -2  | -4            | -12 | -3 | -3             | -19  | -3 | -2            | -1  | 0   | -83   |
| Joint Development             | 3              | 2    | 1   | 7             | 9   | 0  | 2              | 23   | 1  | 1             | 4   | 1   | 54    |
| Net 2035 Trips                | 3              | -32  | -1  | 3             | -3  | -3 | -1             | 4    | -2 | -1            | 3   | 1   | -29   |
| Cumulative                    | 95             | 1099 | 418 | 138           | 881 | 28 | 170            | 1337 | 45 | 177           | 773 | 246 | 5407  |

Intersection Number: **59**  
 Traffic Node Number: 3058  
 Intersection Name: The Alameda & W. Taylor St/Naglee Ave  
 Peak Hour: AM  
 Count Date: 05/21/15  
 Scenario: BART Extension Phase II  
 Date of Analysis: 09/02/15

| Scenario:                     | Movements      |     |     |               |     |    |                |      |     |               |     |     | Total |
|-------------------------------|----------------|-----|-----|---------------|-----|----|----------------|------|-----|---------------|-----|-----|-------|
|                               | North Approach |     |     | East Approach |     |    | South Approach |      |     | West Approach |     |     |       |
|                               | RT             | TH  | LT  | RT            | TH  | LT | RT             | TH   | LT  | RT            | TH  | LT  |       |
| Existing Conditions           | 46             | 478 | 107 | 130           | 359 | 51 | 16             | 1144 | 114 | 93            | 403 | 153 | 3094  |
| <b>Approved Project Trips</b> |                |     |     |               |     |    |                |      |     |               |     |     |       |
| San Jose ATI                  | 0              | 72  | 0   | 2             | 9   | 0  | 1              | 67   | 8   | 20            | 45  | 7   | 231   |
| Santa Clara ATI               | 0              | 0   | 0   | 0             | 0   | 0  | 0              | 0    | 0   | 0             | 0   | 0   | 0     |
| Total Approved Trips          | 0              | 72  | 0   | 2             | 9   | 0  | 1              | 67   | 8   | 20            | 45  | 7   | 231   |
| Background Conditions         | 46             | 550 | 107 | 132           | 368 | 51 | 17             | 1211 | 122 | 113           | 448 | 160 | 3325  |
| <b>2015 Project Trips</b>     |                |     |     |               |     |    |                |      |     |               |     |     |       |
| BART                          | 0              | -3  | -3  | -6            | -1  | 0  | 0              | -15  | 3   | 0             | 2   | -1  | -24   |
| Joint Development             | 0              | 2   | 0   | 5             | 1   | 0  | 1              | 28   | 0   | 0             | 1   | 1   | 39    |
| Net 2015 Trips                | 0              | -1  | -3  | -1            | 0   | 0  | 1              | 13   | 3   | 0             | 3   | 0   | 15    |
| Existing + Project            | 46             | 477 | 104 | 129           | 359 | 51 | 17             | 1157 | 117 | 93            | 406 | 153 | 3109  |
| <b>2025 Project Trips</b>     |                |     |     |               |     |    |                |      |     |               |     |     |       |
| BART                          | 0              | -13 | -12 | -7            | -11 | 0  | 0              | -23  | 1   | 4             | -3  | -1  | -65   |
| Joint Development             | 0              | 2   | 1   | 3             | 2   | 0  | 0              | 19   | 2   | 0             | 5   | 4   | 38    |
| Net 2025 Trips                | 0              | -11 | -11 | -4            | -9  | 0  | 0              | -4   | 3   | 4             | 2   | 3   | -27   |
| Background + Project          | 46             | 539 | 96  | 128           | 359 | 51 | 17             | 1207 | 125 | 117           | 450 | 163 | 3298  |
| Cumulative No Project         | 46             | 744 | 471 | 132           | 936 | 74 | 17             | 1211 | 198 | 175           | 662 | 222 | 4666  |
| <b>2035 Project Trips</b>     |                |     |     |               |     |    |                |      |     |               |     |     |       |
| BART                          | 0              | -19 | -19 | -5            | -9  | 0  | 0              | -18  | 2   | 6             | -2  | -2  | -66   |
| Joint Development             | 0              | 2   | 1   | 1             | 4   | 0  | 0              | 23   | 0   | 0             | 5   | 1   | 37    |
| Net 2035 Trips                | 0              | -17 | -18 | -4            | -5  | 0  | 0              | 5    | 2   | 6             | 3   | -1  | -29   |
| Cumulative                    | 46             | 727 | 453 | 128           | 931 | 74 | 17             | 1216 | 200 | 181           | 665 | 221 | 4859  |

Intersection Number: **60**  
 Traffic Node Number: 127  
 Intersection Name: Homestead Rd & Lincoln St/Winchester Blvd  
 Peak Hour: AM  
 Count Date: 05/21/15  
 Scenario: BART Extension Phase II  
 Date of Analysis: 09/02/15

| Scenario:                     | Movements      |     |    |               |     |    |                |     |    |               |     |    | Total |
|-------------------------------|----------------|-----|----|---------------|-----|----|----------------|-----|----|---------------|-----|----|-------|
|                               | North Approach |     |    | East Approach |     |    | South Approach |     |    | West Approach |     |    |       |
|                               | RT             | TH  | LT | RT            | TH  | LT | RT             | TH  | LT | RT            | TH  | LT |       |
| Existing Conditions           | 49             | 123 | 30 | 18            | 151 | 18 | 44             | 352 | 40 | 3             | 205 | 45 | 1078  |
| <b>Approved Project Trips</b> |                |     |    |               |     |    |                |     |    |               |     |    |       |
| San Jose ATI                  | 0              | 0   | 0  | 0             | 0   | 0  | 0              | 0   | 0  | 0             | 0   | 0  | 0     |
| Santa Clara ATI               | 0              | 0   | 5  | 7             | 22  | 5  | 16             | 0   | 0  | 0             | 21  | 0  | 76    |
| Total Approved Trips          | 0              | 0   | 5  | 7             | 22  | 5  | 16             | 0   | 0  | 0             | 21  | 0  | 76    |
| Background Conditions         | 49             | 123 | 35 | 25            | 173 | 23 | 60             | 352 | 40 | 3             | 226 | 45 | 1154  |
| <b>2015 Project Trips</b>     |                |     |    |               |     |    |                |     |    |               |     |    |       |
| BART                          | 0              | 0   | 0  | 0             | 0   | 0  | 0              | 2   | 0  | 0             | 0   | 1  | 3     |
| Joint Development             | 0              | 0   | 0  | 0             | 0   | 0  | 0              | 22  | 0  | 0             | 0   | 1  | 23    |
| Net 2015 Trips                | 0              | 0   | 0  | 0             | 0   | 0  | 0              | 24  | 0  | 0             | 0   | 2  | 26    |
| Existing + Project            | 49             | 123 | 30 | 18            | 151 | 18 | 44             | 376 | 40 | 3             | 205 | 47 | 1104  |
| <b>2025 Project Trips</b>     |                |     |    |               |     |    |                |     |    |               |     |    |       |
| BART                          | 0              | -1  | 0  | 0             | 0   | 0  | 0              | 0   | 0  | 0             | 0   | 1  | 0     |
| Joint Development             | 0              | 0   | 0  | 0             | 0   | 0  | 0              | 28  | 0  | 0             | 0   | 1  | 29    |
| Net 2025 Trips                | 0              | -1  | 0  | 0             | 0   | 0  | 0              | 28  | 0  | 0             | 0   | 2  | 29    |
| Background + Project          | 49             | 122 | 35 | 25            | 173 | 23 | 60             | 380 | 40 | 3             | 226 | 47 | 1183  |
| Cumulative No Project         | 50             | 159 | 35 | 25            | 173 | 23 | 60             | 783 | 40 | 3             | 251 | 55 | 1602  |
| <b>2035 Project Trips</b>     |                |     |    |               |     |    |                |     |    |               |     |    |       |
| BART                          | 0              | 0   | 0  | 0             | 0   | 0  | 0              | 7   | 0  | 0             | 0   | 2  | 9     |
| Joint Development             | 0              | 0   | 0  | 0             | 0   | 0  | 0              | 20  | 0  | 0             | 0   | 2  | 22    |
| Net 2035 Trips                | 0              | 0   | 0  | 0             | 0   | 0  | 0              | 27  | 0  | 0             | 0   | 4  | 31    |
| Cumulative                    | 50             | 159 | 35 | 25            | 173 | 23 | 60             | 810 | 40 | 3             | 251 | 59 | 1688  |

Intersection Number: **61**  
 Trafix Node Number: 123  
 Intersection Name: Homestead Rd & Monroe St  
 Peak Hour: AM  
 Count Date: 05/21/15  
 Scenario: BART Extension Phase II  
 Date of Analysis: 09/02/15

| Scenario:                     | Movements      |     |    |               |    |    |                |     |    |               |     |    | Total |
|-------------------------------|----------------|-----|----|---------------|----|----|----------------|-----|----|---------------|-----|----|-------|
|                               | North Approach |     |    | East Approach |    |    | South Approach |     |    | West Approach |     |    |       |
|                               | RT             | TH  | LT | RT            | TH | LT | RT             | TH  | LT | RT            | TH  | LT |       |
| Existing Conditions           | 8              | 308 | 32 | 37            | 86 | 16 | 40             | 514 | 74 | 58            | 194 | 17 | 1384  |
| <b>Approved Project Trips</b> |                |     |    |               |    |    |                |     |    |               |     |    |       |
| San Jose ATI                  | 0              | 0   | 0  | 0             | 0  | 0  | 0              | 0   | 0  | 0             | 0   | 0  | 0     |
| Santa Clara ATI               | 3              | 8   | 0  | 0             | 0  | 0  | 0              | 21  | 0  | 0             | 0   | 4  | 36    |
| Total Approved Trips          | 3              | 8   | 0  | 0             | 0  | 0  | 0              | 21  | 0  | 0             | 0   | 4  | 36    |
| Background Conditions         | 11             | 316 | 32 | 37            | 86 | 16 | 40             | 535 | 74 | 58            | 194 | 21 | 1420  |
| <b>2015 Project Trips</b>     |                |     |    |               |    |    |                |     |    |               |     |    |       |
| BART                          | 0              | 0   | 0  | 0             | 0  | 0  | 0              | 0   | 0  | 0             | 0   | 1  | 1     |
| Joint Development             | 0              | 0   | 0  | 0             | 0  | 0  | 0              | 0   | 0  | 0             | 0   | 0  | 0     |
| Net 2015 Trips                | 0              | 0   | 0  | 0             | 0  | 0  | 0              | 0   | 0  | 0             | 0   | 1  | 1     |
| Existing + Project            | 8              | 308 | 32 | 37            | 86 | 16 | 40             | 514 | 74 | 58            | 194 | 18 | 1385  |
| <b>2025 Project Trips</b>     |                |     |    |               |    |    |                |     |    |               |     |    |       |
| BART                          | 0              | 0   | 0  | 0             | 0  | 0  | 0              | 0   | 0  | -1            | 1   | 1  | 1     |
| Joint Development             | 0              | 0   | 0  | 0             | 0  | 0  | 0              | 5   | 0  | 0             | 0   | 0  | 5     |
| Net 2025 Trips                | 0              | 0   | 0  | 0             | 0  | 0  | 0              | 5   | 0  | -1            | 1   | 1  | 6     |
| Background + Project          | 11             | 316 | 32 | 37            | 86 | 16 | 40             | 540 | 74 | 57            | 195 | 22 | 1426  |
| Cumulative No Project         | 11             | 316 | 32 | 39            | 86 | 17 | 89             | 614 | 97 | 86            | 194 | 21 | 1581  |
| <b>2035 Project Trips</b>     |                |     |    |               |    |    |                |     |    |               |     |    |       |
| BART                          | 0              | 0   | 0  | 0             | 0  | 0  | -1             | 0   | -1 | -1            | 0   | 1  | -2    |
| Joint Development             | 0              | 0   | 0  | 0             | 0  | 0  | 0              | 4   | 0  | 0             | 0   | 0  | 4     |
| Net 2035 Trips                | 0              | 0   | 0  | 0             | 0  | 0  | -1             | 4   | -1 | -1            | 0   | 1  | 2     |
| Cumulative                    | 11             | 316 | 32 | 39            | 86 | 17 | 88             | 618 | 96 | 85            | 194 | 22 | 1604  |

Intersection Number: **62**  
 Trafix Node Number: 4069  
 Intersection Name: US 101 & Trimble  
 Peak Hour: AM  
 Count Date: 10/07/14  
 Scenario: BART Extension Phase II  
 Date of Analysis: 09/02/15

| Scenario:                     | Movements      |    |    |               |      |    |                |    |      |               |      |    | Total |
|-------------------------------|----------------|----|----|---------------|------|----|----------------|----|------|---------------|------|----|-------|
|                               | North Approach |    |    | East Approach |      |    | South Approach |    |      | West Approach |      |    |       |
|                               | RT             | TH | LT | RT            | TH   | LT | RT             | TH | LT   | RT            | TH   | LT |       |
| Existing Conditions           | 0              | 0  | 0  | 320           | 1124 | 0  | 566            | 0  | 1201 | 397           | 1405 | 0  | 5013  |
| <b>Approved Project Trips</b> |                |    |    |               |      |    |                |    |      |               |      |    |       |
| San Jose ATI                  | 0              | 0  | 0  | 0             | 0    | 0  | 0              | 0  | 0    | 0             | 0    | 0  | 0     |
| Santa Clara ATI               | 0              | 0  | 0  | 0             | 99   | 0  | 0              | 0  | 82   | 0             | 19   | 0  | 200   |
| Total Approved Trips          | 0              | 0  | 0  | 0             | 99   | 0  | 0              | 0  | 82   | 0             | 19   | 0  | 200   |
| Background Conditions         | 0              | 0  | 0  | 320           | 1223 | 0  | 566            | 0  | 1283 | 397           | 1424 | 0  | 5213  |
| <b>2015 Project Trips</b>     |                |    |    |               |      |    |                |    |      |               |      |    |       |
| BART                          | 0              | 0  | 0  | 0             | -6   | 0  | -3             | 0  | -4   | 0             | -4   | 0  | -17   |
| Joint Development             | 0              | 0  | 0  | 0             | 36   | 0  | 1              | 0  | 47   | 0             | 10   | 0  | 94    |
| Net 2015 Trips                | 0              | 0  | 0  | 0             | 30   | 0  | -2             | 0  | 43   | 0             | 6    | 0  | 77    |
| Existing + Project            | 0              | 0  | 0  | 320           | 1154 | 0  | 564            | 0  | 1244 | 397           | 1411 | 0  | 5090  |
| <b>2025 Project Trips</b>     |                |    |    |               |      |    |                |    |      |               |      |    |       |
| BART                          | 0              | 0  | 0  | 0             | -13  | 0  | -17            | 0  | -21  | 0             | -15  | 0  | -66   |
| Joint Development             | 0              | 0  | 0  | 0             | 35   | 0  | 1              | 0  | 32   | 0             | 8    | 0  | 76    |
| Net 2025 Trips                | 0              | 0  | 0  | 0             | 22   | 0  | -16            | 0  | 11   | 0             | -7   | 0  | 10    |
| Background + Project          | 0              | 0  | 0  | 320           | 1245 | 0  | 550            | 0  | 1294 | 397           | 1417 | 0  | 5223  |
| Cumulative No Project         | 0              | 0  | 0  | 320           | 1596 | 0  | 672            | 0  | 1283 | 397           | 1518 | 0  | 5786  |
| <b>2035 Project Trips</b>     |                |    |    |               |      |    |                |    |      |               |      |    |       |
| BART                          | 0              | 0  | 0  | 0             | -10  | 0  | -4             | 0  | -7   | 0             | -17  | 0  | -38   |
| Joint Development             | 0              | 0  | 0  | 0             | 22   | 0  | 1              | 0  | 36   | 0             | 6    | 0  | 65    |
| Net 2035 Trips                | 0              | 0  | 0  | 0             | 12   | 0  | -3             | 0  | 29   | 0             | -11  | 0  | 27    |
| Cumulative                    | 0              | 0  | 0  | 320           | 1608 | 0  | 669            | 0  | 1312 | 397           | 1507 | 0  | 5813  |

Intersection Number: **1**  
 Traffic Node Number: 3612  
 Intersection Name: 21st St & E. Julian St  
 Peak Hour: PM  
 Count Date: 10/09/14  
 Scenario: BART Extension Phase II  
 Date of Analysis: 09/02/15

| Scenario:                       | Movements      |    |     |               |     |    |                |    |    |               |    |    | Total |
|---------------------------------|----------------|----|-----|---------------|-----|----|----------------|----|----|---------------|----|----|-------|
|                                 | North Approach |    |     | East Approach |     |    | South Approach |    |    | West Approach |    |    |       |
|                                 | RT             | TH | LT  | RT            | TH  | LT | RT             | TH | LT | RT            | TH | LT |       |
| Existing Conditions             | 20             | 0  | 393 | 158           | 406 | 0  | 0              | 0  | 0  | 597           | 8  |    | 1582  |
| <b>Approved Project Trips</b>   |                |    |     |               |     |    |                |    |    |               |    |    |       |
| San Jose ATI                    | 0              | 0  | 0   | 1             | 6   | 0  | 0              | 0  | 0  | 2             | 0  | 0  | 9     |
| Santa Clara ATI                 | 0              | 0  | 0   | 0             | 0   | 0  | 0              | 0  | 0  | 0             | 0  | 0  | 0     |
| Total Approved Trips            | 0              | 0  | 0   | 1             | 6   | 0  | 0              | 0  | 0  | 2             | 0  | 0  | 9     |
| Background Conditions           | 20             | 0  | 393 | 159           | 412 | 0  | 0              | 0  | 0  | 599           | 8  |    | 1591  |
| <b>2015 Project Trips</b>       |                |    |     |               |     |    |                |    |    |               |    |    |       |
| BART                            | 0              | 0  | -1  | 0             | 1   | 0  | 0              | 0  | 0  | -10           | 0  | 0  | -10   |
| Joint Development               | 0              | 0  | 3   | 7             | 67  | 0  | 0              | 0  | 0  | 23            | 0  | 0  | 100   |
| Net 2015 Trips                  | 0              | 0  | 2   | 7             | 68  | 0  | 0              | 0  | 0  | 13            | 0  | 0  | 90    |
| Existing + Project              | 20             | 0  | 395 | 165           | 474 | 0  | 0              | 0  | 0  | 610           | 8  |    | 1672  |
| <b>2025 Project Trips</b>       |                |    |     |               |     |    |                |    |    |               |    |    |       |
| BART                            | 0              | 0  | -1  | 0             | 17  | 0  | 0              | 0  | 0  | -13           | 0  | 0  | 3     |
| Joint Development               | 0              | 0  | 4   | 14            | 65  | 0  | 0              | 0  | 0  | 15            | 0  | 0  | 98    |
| Net 2025 Trips                  | 0              | 0  | 3   | 14            | 82  | 0  | 0              | 0  | 0  | 2             | 0  | 0  | 101   |
| Background + Project            | 20             | 0  | 396 | 173           | 494 | 0  | 0              | 0  | 0  | 601           | 8  |    | 1692  |
| Cumulative No Project           | 20             | 0  | 393 | 197           | 477 | 0  | 0              | 0  | 0  | 685           | 18 |    | 1772  |
| <b>Cumulative Project Trips</b> |                |    |     |               |     |    |                |    |    |               |    |    |       |
| BART                            | 0              | 0  | 0   | 0             | 19  | 0  | 0              | 0  | 0  | -18           | 0  | 0  | 1     |
| Joint Development               | 0              | 0  | 5   | 15            | 68  | 0  | 0              | 0  | 0  | 23            | 0  | 0  | 111   |
| Net 2035 Trips                  | 0              | 0  | 5   | 15            | 87  | 0  | 0              | 0  | 0  | 5             | 0  | 0  | 112   |
| Cumulative With Project         | 20             | 0  | 398 | 212           | 564 | 0  | 0              | 0  | 0  | 690           | 18 |    | 1902  |

Intersection Number: **2**  
 Traffic Node Number: 3613  
 Intersection Name: 24th St & E. Julian St  
 Peak Hour: PM  
 Count Date: 10/09/14  
 Scenario: BART Extension Phase II  
 Date of Analysis: 09/02/15

| Scenario:                       | Movements      |    |    |               |     |     |                |    |     |               |     |    | Total |
|---------------------------------|----------------|----|----|---------------|-----|-----|----------------|----|-----|---------------|-----|----|-------|
|                                 | North Approach |    |    | East Approach |     |     | South Approach |    |     | West Approach |     |    |       |
|                                 | RT             | TH | LT | RT            | TH  | LT  | RT             | TH | LT  | RT            | TH  | LT |       |
| Existing Conditions             | 0              | 0  | 0  | 0             | 443 | 179 | 155            | 0  | 118 | 239           | 757 | 0  | 1891  |
| <b>Approved Project Trips</b>   |                |    |    |               |     |     |                |    |     |               |     |    |       |
| San Jose ATI                    | 0              | 0  | 0  | 0             | 11  | 5   | 4              | 0  | 1   | 0             | 2   | 0  | 23    |
| Santa Clara ATI                 | 0              | 0  | 0  | 0             | 0   | 0   | 0              | 0  | 0   | 0             | 0   | 0  | 0     |
| Total Approved Trips            | 0              | 0  | 0  | 0             | 11  | 5   | 4              | 0  | 1   | 0             | 2   | 0  | 23    |
| Background Conditions           | 0              | 0  | 0  | 0             | 454 | 184 | 159            | 0  | 119 | 239           | 759 | 0  | 1914  |
| <b>2015 Project Trips</b>       |                |    |    |               |     |     |                |    |     |               |     |    |       |
| BART                            | 0              | 0  | 0  | 0             | 2   | -3  | -10            | 0  | -1  | -1            | -10 | 0  | -23   |
| Joint Development               | 0              | 0  | 0  | 0             | 74  | 20  | 12             | 0  | 0   | 0             | 26  | 0  | 132   |
| Net 2015 Trips                  | 0              | 0  | 0  | 0             | 76  | 17  | 2              | 0  | -1  | -1            | 16  | 0  | 109   |
| Existing + Project              | 0              | 0  | 0  | 0             | 519 | 196 | 157            | 0  | 117 | 238           | 773 | 0  | 2000  |
| <b>2025 Project Trips</b>       |                |    |    |               |     |     |                |    |     |               |     |    |       |
| BART                            | 0              | 0  | 0  | 0             | 19  | -11 | -10            | 0  | -2  | -2            | -11 | 0  | -17   |
| Joint Development               | 0              | 0  | 0  | 0             | 79  | 23  | 11             | 0  | 0   | 0             | 19  | 0  | 132   |
| Net 2025 Trips                  | 0              | 0  | 0  | 0             | 98  | 12  | 1              | 0  | -2  | -2            | 8   | 0  | 115   |
| Background + Project            | 0              | 0  | 0  | 0             | 552 | 196 | 160            | 0  | 117 | 237           | 767 | 0  | 2029  |
| Cumulative No Project           | 0              | 0  | 0  | 0             | 506 | 184 | 159            | 0  | 167 | 367           | 759 | 0  | 2142  |
| <b>Cumulative Project Trips</b> |                |    |    |               |     |     |                |    |     |               |     |    |       |
| BART                            | 0              | 0  | 0  | 0             | 22  | -7  | -13            | 0  | -4  | -1            | -17 | 0  | -20   |
| Joint Development               | 0              | 0  | 0  | 0             | 82  | 20  | 20             | 0  | 0   | 1             | 28  | 0  | 151   |
| Net 2035 Trips                  | 0              | 0  | 0  | 0             | 104 | 13  | 7              | 0  | -4  | 0             | 11  | 0  | 131   |
| Cumulative With Project         | 0              | 0  | 0  | 0             | 610 | 197 | 166            | 0  | 163 | 367           | 770 | 0  | 2273  |

Intersection Number: **3**  
 Traffic Node Number: 4005  
 Intersection Name: N. 28th St & E. Julian St  
 Peak Hour: PM  
 Count Date: 04/09/15  
 Scenario: BART Extension Phase II  
 Date of Analysis: 09/02/15

| Scenario:                       | Movements      |    |     |               |     |     |                |    |     |               |     |    | Total |
|---------------------------------|----------------|----|-----|---------------|-----|-----|----------------|----|-----|---------------|-----|----|-------|
|                                 | North Approach |    |     | East Approach |     |     | South Approach |    |     | West Approach |     |    |       |
|                                 | RT             | TH | LT  | RT            | TH  | LT  | RT             | TH | LT  | RT            | TH  | LT |       |
| Existing Conditions             | 0              | 20 | 121 | 93            | 640 | 31  | 57             | 20 | 21  | 34            | 907 | 5  | 1949  |
| <b>Approved Project Trips</b>   |                |    |     |               |     |     |                |    |     |               |     |    |       |
| San Jose ATI                    | 0              | 0  | 0   | 0             | 0   | 0   | 0              | 0  | 0   | 0             | 0   | 0  | 0     |
| Santa Clara ATI                 | 0              | 0  | 0   | 0             | 0   | 0   | 0              | 0  | 0   | 0             | 0   | 0  | 0     |
| Total Approved Trips            | 0              | 0  | 0   | 0             | 0   | 0   | 0              | 0  | 0   | 0             | 0   | 0  | 0     |
| Background Conditions           | 0              | 20 | 121 | 93            | 640 | 31  | 57             | 20 | 21  | 34            | 907 | 5  | 1949  |
| <b>2015 Project Trips</b>       |                |    |     |               |     |     |                |    |     |               |     |    |       |
| BART                            | 0              | 0  | -1  | -1            | -16 | 3   | 63             | 0  | 14  | 3             | -21 | -1 | 43    |
| Joint Development               | 0              | 5  | 0   | 0             | 0   | 76  | 242            | 5  | 96  | 37            | 3   | 0  | 464   |
| Net 2015 Trips                  | 0              | 5  | -1  | -1            | -16 | 79  | 305            | 5  | 110 | 40            | -18 | -1 | 507   |
| Existing + Project              | 0              | 25 | 120 | 92            | 624 | 110 | 362            | 25 | 131 | 74            | 889 | 4  | 2456  |
| <b>2025 Project Trips</b>       |                |    |     |               |     |     |                |    |     |               |     |    |       |
| BART                            | -1             | 0  | -1  | -1            | -28 | 10  | 75             | 0  | 33  | 9             | -28 | -1 | 67    |
| Joint Development               | 0              | 5  | 0   | 0             | 0   | 73  | 220            | 4  | 102 | 31            | 0   | 0  | 435   |
| Net 2025 Trips                  | -1             | 5  | -1  | -1            | -28 | 83  | 295            | 4  | 135 | 40            | -28 | -1 | 502   |
| Background + Project            | -1             | 25 | 120 | 92            | 612 | 114 | 352            | 24 | 156 | 74            | 879 | 4  | 2451  |
| Cumulative No Project           | 16             | 20 | 121 | 97            | 711 | 50  | 123            | 21 | 28  | 51            | 907 | 20 | 2145  |
| <b>Cumulative Project Trips</b> |                |    |     |               |     |     |                |    |     |               |     |    |       |
| BART                            | -1             | 0  | -1  | -2            | -32 | 6   | 120            | 0  | 43  | 17            | -42 | -1 | 107   |
| Joint Development               | 0              | 6  | 0   | 0             | 0   | 70  | 177            | 6  | 103 | 46            | 3   | 0  | 411   |
| Net 2035 Trips                  | -1             | 6  | -1  | -2            | -32 | 76  | 297            | 6  | 146 | 63            | -39 | -1 | 518   |
| Cumulative With Project         | 15             | 26 | 120 | 95            | 679 | 126 | 420            | 27 | 174 | 114           | 868 | 19 | 2683  |

Intersection Number: **4**  
 Traffic Node Number: 3210  
 Intersection Name: US 101 SB ramps & E. Julian St  
 Peak Hour: PM  
 Count Date: 10/09/14  
 Scenario: BART Extension Phase II  
 Date of Analysis: 09/02/15

| Scenario:                       | Movements      |    |    |               |     |     |                |    |     |               |     |    | Total |
|---------------------------------|----------------|----|----|---------------|-----|-----|----------------|----|-----|---------------|-----|----|-------|
|                                 | North Approach |    |    | East Approach |     |     | South Approach |    |     | West Approach |     |    |       |
|                                 | RT             | TH | LT | RT            | TH  | LT  | RT             | TH | LT  | RT            | TH  | LT |       |
| Existing Conditions             | 0              | 0  | 0  | 0             | 756 | 591 | 396            | 0  | 53  | 540           | 646 | 0  | 2982  |
| <b>Approved Project Trips</b>   |                |    |    |               |     |     |                |    |     |               |     |    |       |
| San Jose ATI                    | 0              | 0  | 0  | 0             | 29  | 142 | 74             | 0  | 2   | 0             | 24  | 0  | 271   |
| Santa Clara ATI                 | 0              | 0  | 0  | 0             | 0   | 0   | 0              | 0  | 0   | 0             | 0   | 0  | 0     |
| Total Approved Trips            | 0              | 0  | 0  | 0             | 29  | 142 | 74             | 0  | 2   | 0             | 24  | 0  | 271   |
| Background Conditions           | 0              | 0  | 0  | 0             | 785 | 733 | 470            | 0  | 55  | 540           | 670 | 0  | 3253  |
| <b>2015 Project Trips</b>       |                |    |    |               |     |     |                |    |     |               |     |    |       |
| BART                            | 0              | 0  | 0  | 0             | -7  | 0   | -4             | 0  | -6  | 56            | -15 | 0  | 24    |
| Joint Development               | 0              | 0  | 0  | 0             | 38  | 0   | 2              | 0  | 38  | 109           | 137 | 0  | 324   |
| Net 2015 Trips                  | 0              | 0  | 0  | 0             | 31  | 0   | -2             | 0  | 32  | 165           | 122 | 0  | 348   |
| Existing + Project              | 0              | 0  | 0  | 0             | 787 | 591 | 394            | 0  | 85  | 705           | 768 | 0  | 3330  |
| <b>2025 Project Trips</b>       |                |    |    |               |     |     |                |    |     |               |     |    |       |
| BART                            | 0              | 0  | 0  | 0             | -11 | -29 | 0              | 0  | -11 | 63            | -19 | 0  | -7    |
| Joint Development               | 0              | 0  | 0  | 0             | 43  | 0   | 3              | 0  | 30  | 84            | 136 | 0  | 296   |
| Net 2025 Trips                  | 0              | 0  | 0  | 0             | 32  | -29 | 3              | 0  | 19  | 147           | 117 | 0  | 289   |
| Background + Project            | 0              | 0  | 0  | 0             | 817 | 704 | 473            | 0  | 74  | 687           | 787 | 0  | 3542  |
| Cumulative No Project           | 0              | 0  | 0  | 0             | 841 | 733 | 765            | 0  | 63  | 549           | 670 | 0  | 3621  |
| <b>Cumulative Project Trips</b> |                |    |    |               |     |     |                |    |     |               |     |    |       |
| BART                            | 0              | 0  | 0  | 0             | -17 | -18 | 0              | 0  | -9  | 100           | -23 | 0  | 33    |
| Joint Development               | 0              | 0  | 0  | 0             | 39  | 0   | 2              | 0  | 32  | 102           | 77  | 0  | 252   |
| Net 2035 Trips                  | 0              | 0  | 0  | 0             | 22  | -18 | 2              | 0  | 23  | 202           | 54  | 0  | 285   |
| Cumulative With Project         | 0              | 0  | 0  | 0             | 863 | 715 | 767            | 0  | 86  | 751           | 724 | 0  | 3906  |

Intersection Number: **5**  
 Traffic Node Number: 3211  
 Intersection Name: US 101 NB ramps & McKee Rd  
 Peak Hour: PM  
 Count Date: 10/09/14  
 Scenario: BART Extension Phase II  
 Date of Analysis: 09/02/15

| Scenario:                       | Movements      |    |    |               |      |    |                |    |     |               |      |     | Total |
|---------------------------------|----------------|----|----|---------------|------|----|----------------|----|-----|---------------|------|-----|-------|
|                                 | North Approach |    |    | East Approach |      |    | South Approach |    |     | West Approach |      |     |       |
|                                 | RT             | TH | LT | RT            | TH   | LT | RT             | TH | LT  | RT            | TH   | LT  |       |
| Existing Conditions             | 0              | 0  | 0  | 334           | 1006 | 0  | 573            | 0  | 310 | 0             | 1013 | 96  | 3332  |
| <b>Approved Project Trips</b>   |                |    |    |               |      |    |                |    |     |               |      |     |       |
| San Jose ATI                    | 0              | 0  | 0  | 51            | 185  | 0  | 204            | 0  | 0   | 0             | 94   | 0   | 534   |
| Santa Clara ATI                 | 0              | 0  | 0  | 0             | 0    | 0  | 0              | 0  | 0   | 0             | 0    | 0   | 0     |
| Total Approved Trips            | 0              | 0  | 0  | 51            | 185  | 0  | 204            | 0  | 0   | 0             | 94   | 0   | 534   |
| Background Conditions           | 0              | 0  | 0  | 385           | 1191 | 0  | 777            | 0  | 310 | 0             | 1107 | 96  | 3866  |
| <b>2015 Project Trips</b>       |                |    |    |               |      |    |                |    |     |               |      |     |       |
| BART                            | 0              | 0  | 0  | -5            | -13  | 0  | 0              | 0  | 6   | 0             | -14  | -5  | -31   |
| Joint Development               | 0              | 0  | 0  | 1             | 38   | 0  | 0              | 0  | 0   | 0             | 87   | 51  | 177   |
| Net 2015 Trips                  | 0              | 0  | 0  | -4            | 25   | 0  | 0              | 0  | 6   | 0             | 73   | 46  | 146   |
| Existing + Project              | 0              | 0  | 0  | 330           | 1031 | 0  | 573            | 0  | 316 | 0             | 1086 | 142 | 3478  |
| <b>2025 Project Trips</b>       |                |    |    |               |      |    |                |    |     |               |      |     |       |
| BART                            | 0              | 0  | 0  | -4            | -16  | 0  | -8             | 0  | 2   | 0             | -23  | -1  | -50   |
| Joint Development               | 0              | 0  | 0  | 0             | 43   | 0  | 0              | 0  | 0   | 0             | 100  | 39  | 182   |
| Net 2025 Trips                  | 0              | 0  | 0  | -4            | 27   | 0  | -8             | 0  | 2   | 0             | 77   | 38  | 132   |
| Background + Project            | 0              | 0  | 0  | 381           | 1218 | 0  | 769            | 0  | 312 | 0             | 1184 | 134 | 3998  |
| Cumulative No Project           | 0              | 0  | 0  | 385           | 1191 | 0  | 917            | 0  | 310 | 0             | 1416 | 96  | 4219  |
| <b>Cumulative Project Trips</b> |                |    |    |               |      |    |                |    |     |               |      |     |       |
| BART                            | 0              | 0  | 0  | -3            | -17  | 0  | -34            | 0  | 3   | 0             | -30  | 0   | -81   |
| Joint Development               | 0              | 0  | 0  | 0             | 39   | 0  | 8              | 0  | 0   | 0             | 61   | 19  | 127   |
| Net 2035 Trips                  | 0              | 0  | 0  | -3            | 22   | 0  | -26            | 0  | 3   | 0             | 31   | 19  | 46    |
| Cumulative With Project         | 0              | 0  | 0  | 382           | 1213 | 0  | 891            | 0  | 313 | 0             | 1447 | 115 | 4361  |

Intersection Number: **6**  
 Traffic Node Number: 3678  
 Intersection Name: 33rd St & McKee Rd  
 Peak Hour: PM  
 Count Date: 05/20/15  
 Scenario: BART Extension Phase II  
 Date of Analysis: 09/02/15

| Scenario:                       | Movements      |    |     |               |      |    |                |    |     |               |      |     | Total |
|---------------------------------|----------------|----|-----|---------------|------|----|----------------|----|-----|---------------|------|-----|-------|
|                                 | North Approach |    |     | East Approach |      |    | South Approach |    |     | West Approach |      |     |       |
|                                 | RT             | TH | LT  | RT            | TH   | LT | RT             | TH | LT  | RT            | TH   | LT  |       |
| Existing Conditions             | 113            | 11 | 72  | 22            | 1209 | 50 | 49             | 28 | 117 | 88            | 1036 | 109 | 2904  |
| <b>Approved Project Trips</b>   |                |    |     |               |      |    |                |    |     |               |      |     |       |
| San Jose ATI                    | 0              | 0  | 2   | 0             | 221  | 4  | 1              | 3  | 4   | 1             | 288  | 0   | 524   |
| Santa Clara ATI                 | 0              | 0  | 0   | 0             | 0    | 0  | 0              | 0  | 0   | 0             | 0    | 0   | 0     |
| Total Approved Trips            | 0              | 0  | 2   | 0             | 221  | 4  | 1              | 3  | 4   | 1             | 288  | 0   | 524   |
| Background Conditions           | 113            | 11 | 74  | 22            | 1430 | 54 | 50             | 31 | 121 | 89            | 1324 | 109 | 3428  |
| <b>2015 Project Trips</b>       |                |    |     |               |      |    |                |    |     |               |      |     |       |
| BART                            | -4             | -1 | 0   | 0             | -14  | 0  | 0              | 0  | 0   | 0             | -13  | -2  | -34   |
| Joint Development               | 3              | 0  | 0   | 0             | 35   | 0  | 0              | 1  | 0   | 7             | 76   | 4   | 126   |
| Net 2015 Trips                  | -1             | -1 | 0   | 0             | 21   | 0  | 0              | 1  | 0   | 7             | 63   | 2   | 92    |
| Existing + Project              | 112            | 10 | 72  | 22            | 1230 | 50 | 49             | 29 | 117 | 95            | 1099 | 111 | 2996  |
| <b>2025 Project Trips</b>       |                |    |     |               |      |    |                |    |     |               |      |     |       |
| BART                            | -2             | 0  | 0   | 0             | -67  | -1 | 0              | 0  | 0   | 4             | -56  | 0   | -122  |
| Joint Development               | 3              | 0  | 0   | 0             | 39   | 0  | 0              | 0  | 0   | 3             | 93   | 4   | 142   |
| Net 2025 Trips                  | 1              | 0  | 0   | 0             | -28  | -1 | 0              | 0  | 0   | 7             | 37   | 4   | 20    |
| Background + Project            | 114            | 11 | 74  | 22            | 1402 | 53 | 50             | 31 | 121 | 96            | 1361 | 113 | 3448  |
| Cumulative No Project           | 113            | 41 | 127 | 32            | 1430 | 90 | 82             | 93 | 154 | 125           | 1779 | 109 | 4066  |
| <b>Cumulative Project Trips</b> |                |    |     |               |      |    |                |    |     |               |      |     |       |
| BART                            | -1             | 0  | 0   | 0             | -21  | -2 | 0              | 0  | 1   | 3             | -74  | 0   | -94   |
| Joint Development               | 2              | 0  | 0   | 0             | 34   | 0  | 0              | 1  | 0   | 1             | 66   | 3   | 107   |
| Net 2035 Trips                  | 1              | 0  | 0   | 0             | 13   | -2 | 0              | 1  | 1   | 4             | -8   | 3   | 13    |
| Cumulative With Project         | 114            | 41 | 127 | 32            | 1443 | 88 | 82             | 94 | 155 | 129           | 1771 | 112 | 4188  |

Intersection Number: **7**  
 Traffix Node Number: 3625  
 Intersection Name: King Rd & McKee Rd  
 Peak Hour: PM  
 Count Date: 10/08/14  
 Scenario: BART Extension Phase II  
 Date of Analysis: 09/02/15

| Scenario:                       | Movements      |      |     |               |     |     |                |     |     |               |      |     | Total |
|---------------------------------|----------------|------|-----|---------------|-----|-----|----------------|-----|-----|---------------|------|-----|-------|
|                                 | North Approach |      |     | East Approach |     |     | South Approach |     |     | West Approach |      |     |       |
|                                 | RT             | TH   | LT  | RT            | TH  | LT  | RT             | TH  | LT  | RT            | TH   | LT  |       |
| Existing Conditions             | 358            | 500  | 120 | 111           | 788 | 117 | 98             | 202 | 95  | 123           | 805  | 330 | 3647  |
| <b>Approved Project Trips</b>   |                |      |     |               |     |     |                |     |     |               |      |     |       |
| San Jose ATI                    | 160            | 84   | 77  | 99            | 88  | 7   | 6              | 97  | 4   | 9             | 62   | 266 | 959   |
| Santa Clara ATI                 | 0              | 0    | 0   | 0             | 0   | 0   | 0              | 0   | 0   | 0             | 0    | 0   | 0     |
| Total Approved Trips            | 160            | 84   | 77  | 99            | 88  | 7   | 6              | 97  | 4   | 9             | 62   | 266 | 959   |
| Background Conditions           | 518            | 584  | 197 | 210           | 876 | 124 | 104            | 299 | 99  | 132           | 867  | 596 | 4606  |
| <b>2015 Project Trips</b>       |                |      |     |               |     |     |                |     |     |               |      |     |       |
| BART                            | -1             | 12   | 3   | 1             | -13 | -1  | 0              | 9   | 0   | 0             | -14  | 1   | -3    |
| Joint Development               | 9              | 0    | 1   | 0             | 25  | 0   | 6              | 4   | 0   | 4             | 59   | 13  | 121   |
| Net 2015 Trips                  | 8              | 12   | 4   | 1             | 12  | -1  | 6              | 13  | 0   | 4             | 45   | 14  | 118   |
| Existing + Project              | 366            | 512  | 124 | 112           | 800 | 116 | 104            | 215 | 95  | 127           | 850  | 344 | 3765  |
| <b>2025 Project Trips</b>       |                |      |     |               |     |     |                |     |     |               |      |     |       |
| BART                            | -9             | -149 | -2  | 0             | -11 | -1  | 0              | -14 | 0   | 0             | -17  | -13 | -216  |
| Joint Development               | 14             | 0    | 1   | 0             | 25  | 0   | 6              | 4   | 1   | 6             | 67   | 21  | 145   |
| Net 2025 Trips                  | 5              | -149 | -1  | 0             | 14  | -1  | 6              | -10 | 1   | 6             | 50   | 8   | -71   |
| Background + Project            | 523            | 435  | 196 | 210           | 890 | 123 | 110            | 289 | 100 | 138           | 917  | 604 | 4535  |
| Cumulative No Project           | 518            | 676  | 197 | 210           | 876 | 240 | 301            | 466 | 126 | 373           | 1026 | 689 | 5009  |
| <b>Cumulative Project Trips</b> |                |      |     |               |     |     |                |     |     |               |      |     |       |
| BART                            | -10            | -167 | -1  | 0             | -13 | -1  | 0              | -36 | 1   | 3             | -17  | -51 | -292  |
| Joint Development               | 10             | 0    | 0   | 0             | 24  | 0   | 7              | 5   | 1   | 5             | 47   | 13  | 112   |
| Net 2035 Trips                  | 0              | -167 | -1  | 0             | 11  | -1  | 7              | -31 | 2   | 8             | 30   | -38 | -180  |
| Cumulative With Project         | 518            | 509  | 196 | 210           | 887 | 239 | 308            | 435 | 128 | 381           | 1056 | 651 | 5518  |

Intersection Number: **8**  
 Traffix Node Number: 3596  
 Intersection Name: Jackson Ave & McKee Rd  
 Peak Hour: PM  
 Count Date: 05/20/15  
 Scenario: BART Extension Phase II  
 Date of Analysis: 09/02/15

| Scenario:                       | Movements      |     |     |               |     |     |                |     |     |               |      |     | Total |
|---------------------------------|----------------|-----|-----|---------------|-----|-----|----------------|-----|-----|---------------|------|-----|-------|
|                                 | North Approach |     |     | East Approach |     |     | South Approach |     |     | West Approach |      |     |       |
|                                 | RT             | TH  | LT  | RT            | TH  | LT  | RT             | TH  | LT  | RT            | TH   | LT  |       |
| Existing Conditions             | 217            | 378 | 337 | 200           | 773 | 284 | 266            | 215 | 189 | 158           | 793  | 161 | 3971  |
| <b>Approved Project Trips</b>   |                |     |     |               |     |     |                |     |     |               |      |     |       |
| San Jose ATI                    | 13             | 23  | 10  | 16            | 52  | 38  | 48             | 43  | 40  | 24            | 85   | 30  | 422   |
| Santa Clara ATI                 | 0              | 0   | 0   | 0             | 0   | 0   | 0              | 0   | 0   | 0             | 0    | 0   | 0     |
| Total Approved Trips            | 13             | 23  | 10  | 16            | 52  | 38  | 48             | 43  | 40  | 24            | 85   | 30  | 422   |
| Background Conditions           | 230            | 401 | 347 | 216           | 825 | 322 | 314            | 258 | 229 | 182           | 878  | 191 | 4393  |
| <b>2015 Project Trips</b>       |                |     |     |               |     |     |                |     |     |               |      |     |       |
| BART                            | 0              | 16  | 4   | 0             | -18 | -3  | 0              | 0   | 0   | 0             | -14  | 0   | -15   |
| Joint Development               | 1              | 0   | 0   | 0             | 17  | 0   | 0              | 0   | 1   | 1             | 50   | 3   | 73    |
| Net 2015 Trips                  | 1              | 16  | 4   | 0             | -1  | -3  | 0              | 0   | 1   | 1             | 36   | 3   | 58    |
| Existing + Project              | 218            | 394 | 341 | 200           | 772 | 281 | 266            | 215 | 190 | 159           | 829  | 164 | 4029  |
| <b>2025 Project Trips</b>       |                |     |     |               |     |     |                |     |     |               |      |     |       |
| BART                            | 0              | -6  | -5  | -1            | -16 | -1  | 0              | 0   | 0   | 0             | -16  | -1  | -46   |
| Joint Development               | 1              | 1   | 0   | 0             | 19  | 0   | 0              | 0   | 0   | 1             | 59   | 2   | 83    |
| Net 2025 Trips                  | 1              | -5  | -5  | -1            | 3   | -1  | 0              | 0   | 0   | 1             | 43   | 1   | 37    |
| Background + Project            | 231            | 396 | 342 | 215           | 828 | 321 | 314            | 258 | 229 | 183           | 921  | 192 | 4430  |
| Cumulative No Project           | 230            | 401 | 451 | 216           | 917 | 385 | 314            | 370 | 229 | 182           | 1126 | 274 | 4821  |
| <b>Cumulative Project Trips</b> |                |     |     |               |     |     |                |     |     |               |      |     |       |
| BART                            | 0              | -13 | -3  | -1            | -17 | -1  | -1             | -1  | 0   | 0             | -19  | -1  | -57   |
| Joint Development               | 0              | 0   | 0   | 0             | 18  | 0   | 0              | 0   | 0   | 1             | 39   | 4   | 62    |
| Net 2035 Trips                  | 0              | -13 | -3  | -1            | 1   | -1  | -1             | -1  | 0   | 1             | 20   | 3   | 5     |
| Cumulative With Project         | 230            | 388 | 448 | 215           | 918 | 384 | 313            | 369 | 229 | 183           | 1146 | 277 | 5100  |

Intersection Number: **9**  
 Traffic Node Number: 3783  
 Intersection Name: 17th St & E. Santa Clara St  
 Peak Hour: PM  
 Count Date: 10/09/14  
 Scenario: BART Extension Phase II  
 Date of Analysis: 09/02/15

| Scenario:                       | Movements      |    |     |               |     |    |                |    |    |               |     |    | Total |
|---------------------------------|----------------|----|-----|---------------|-----|----|----------------|----|----|---------------|-----|----|-------|
|                                 | North Approach |    |     | East Approach |     |    | South Approach |    |    | West Approach |     |    |       |
|                                 | RT             | TH | LT  | RT            | TH  | LT | RT             | TH | LT | RT            | TH  | LT |       |
| Existing Conditions             | 3              | 54 | 143 | 38            | 346 | 5  | 22             | 27 | 9  | 17            | 916 | 16 | 1596  |
| <b>Approved Project Trips</b>   |                |    |     |               |     |    |                |    |    |               |     |    |       |
| San Jose ATI                    | 0              | 0  | 0   | 0             | 1   | 0  | 0              | 0  | 0  | 0             | 3   | 0  | 4     |
| Santa Clara ATI                 | 0              | 0  | 0   | 0             | 0   | 0  | 0              | 0  | 0  | 0             | 0   | 0  | 0     |
| Total Approved Trips            | 0              | 0  | 0   | 0             | 1   | 0  | 0              | 0  | 0  | 0             | 3   | 0  | 4     |
| Background Conditions           | 3              | 54 | 143 | 38            | 347 | 5  | 22             | 27 | 9  | 17            | 919 | 16 | 1600  |
| <b>2015 Project Trips</b>       |                |    |     |               |     |    |                |    |    |               |     |    |       |
| BART                            | 0              | 0  | 0   | 0             | -2  | 1  | 0              | 0  | 0  | 0             | -14 | 0  | -15   |
| Joint Development               | 0              | 2  | 4   | 0             | 28  | 2  | 0              | 0  | 0  | 0             | 28  | 0  | 64    |
| Net 2015 Trips                  | 0              | 2  | 4   | 0             | 26  | 3  | 0              | 0  | 0  | 0             | 14  | 0  | 49    |
| Existing + Project              | 3              | 56 | 147 | 38            | 372 | 8  | 22             | 27 | 9  | 17            | 930 | 16 | 1645  |
| <b>2025 Project Trips</b>       |                |    |     |               |     |    |                |    |    |               |     |    |       |
| BART                            | 0              | -1 | 0   | 0             | -1  | 1  | 0              | 0  | 0  | 0             | -17 | 0  | -18   |
| Joint Development               | 0              | 4  | 3   | 1             | 42  | 3  | 0              | 0  | 0  | 0             | 26  | 0  | 79    |
| Net 2025 Trips                  | 0              | 3  | 3   | 1             | 41  | 4  | 0              | 0  | 0  | 0             | 9   | 0  | 61    |
| Background + Project            | 3              | 57 | 146 | 39            | 388 | 9  | 22             | 27 | 9  | 17            | 928 | 16 | 1661  |
| Cumulative No Project           | 3              | 83 | 336 | 120           | 782 | 13 | 22             | 65 | 21 | 158           | 919 | 18 | 2522  |
| <b>Cumulative Project Trips</b> |                |    |     |               |     |    |                |    |    |               |     |    |       |
| BART                            | 0              | -1 | -1  | 0             | 15  | 2  | 1              | 0  | 0  | -2            | -30 | 0  | -16   |
| Joint Development               | 0              | 0  | 5   | 6             | 51  | 2  | 0              | 0  | 0  | 2             | 17  | 0  | 83    |
| Net 2035 Trips                  | 0              | -1 | 4   | 6             | 66  | 4  | 1              | 0  | 0  | 0             | -13 | 0  | 67    |
| Cumulative With Project         | 3              | 82 | 340 | 126           | 848 | 17 | 23             | 65 | 21 | 158           | 906 | 18 | 2607  |

Intersection Number: **10**  
 Traffic Node Number: 3789  
 Intersection Name: 21st St & E. Santa Clara St  
 Peak Hour: PM  
 Count Date: 10/09/14  
 Scenario: BART Extension Phase II  
 Date of Analysis: 09/02/15

| Scenario:                       | Movements      |    |    |               |     |    |                |    |    |               |     |    | Total |
|---------------------------------|----------------|----|----|---------------|-----|----|----------------|----|----|---------------|-----|----|-------|
|                                 | North Approach |    |    | East Approach |     |    | South Approach |    |    | West Approach |     |    |       |
|                                 | RT             | TH | LT | RT            | TH  | LT | RT             | TH | LT | RT            | TH  | LT |       |
| Existing Conditions             | 20             | 12 | 41 | 35            | 331 | 22 | 25             | 3  | 25 | 64            | 948 | 28 | 1554  |
| <b>Approved Project Trips</b>   |                |    |    |               |     |    |                |    |    |               |     |    |       |
| San Jose ATI                    | 0              | 0  | 0  | 0             | 2   | 0  | 0              | 0  | 0  | 0             | 4   | 0  | 6     |
| Santa Clara ATI                 | 0              | 0  | 0  | 0             | 0   | 0  | 0              | 0  | 0  | 0             | 0   | 0  | 0     |
| Total Approved Trips            | 0              | 0  | 0  | 0             | 2   | 0  | 0              | 0  | 0  | 0             | 4   | 0  | 6     |
| Background Conditions           | 20             | 12 | 41 | 35            | 333 | 22 | 25             | 3  | 25 | 64            | 952 | 28 | 1560  |
| <b>2015 Project Trips</b>       |                |    |    |               |     |    |                |    |    |               |     |    |       |
| BART                            | 0              | 0  | 0  | 0             | 0   | 0  | 0              | 0  | 0  | 0             | -12 | 0  | -12   |
| Joint Development               | 0              | 0  | 0  | 0             | 30  | 0  | 0              | 0  | 0  | 0             | 33  | 0  | 63    |
| Net 2015 Trips                  | 0              | 0  | 0  | 0             | 30  | 0  | 0              | 0  | 0  | 0             | 21  | 0  | 51    |
| Existing + Project              | 20             | 12 | 41 | 35            | 361 | 22 | 25             | 3  | 25 | 64            | 969 | 28 | 1605  |
| <b>2025 Project Trips</b>       |                |    |    |               |     |    |                |    |    |               |     |    |       |
| BART                            | -1             | 0  | 0  | 0             | 1   | 0  | 0              | 0  | 0  | 0             | -16 | 0  | -16   |
| Joint Development               | 0              | 0  | 0  | 0             | 47  | 0  | 0              | 0  | 0  | 0             | 29  | 0  | 76    |
| Net 2025 Trips                  | -1             | 0  | 0  | 0             | 48  | 0  | 0              | 0  | 0  | 0             | 13  | 0  | 60    |
| Background + Project            | 19             | 12 | 41 | 35            | 381 | 22 | 25             | 3  | 25 | 64            | 965 | 28 | 1620  |
| Cumulative No Project           | 90             | 17 | 46 | 46            | 763 | 33 | 25             | 10 | 25 | 64            | 966 | 32 | 2085  |
| <b>Cumulative Project Trips</b> |                |    |    |               |     |    |                |    |    |               |     |    |       |
| BART                            | -2             | 0  | 0  | 0             | 21  | 0  | 0              | 0  | 0  | 0             | -28 | 0  | -9    |
| Joint Development               | 0              | 0  | 0  | 2             | 58  | 0  | 0              | 0  | 0  | 0             | 23  | 0  | 83    |
| Net 2035 Trips                  | -2             | 0  | 0  | 2             | 79  | 0  | 0              | 0  | 0  | 0             | -5  | 0  | 74    |
| Cumulative With Project         | 88             | 17 | 46 | 48            | 842 | 33 | 25             | 10 | 25 | 64            | 961 | 32 | 2191  |



Intersection Number: 11  
 Traffic Node Number: 3790  
 Intersection Name: 24th St & E. Santa Clara St  
 Peak Hour: PM  
 Count Date: 11/05/13  
 Scenario: BART Extension Phase II  
 Date of Analysis: 09/02/15

| Scenario:                       | Movements      |     |     |               |     |     |                |     |     |               |     |     | Total |
|---------------------------------|----------------|-----|-----|---------------|-----|-----|----------------|-----|-----|---------------|-----|-----|-------|
|                                 | North Approach |     |     | East Approach |     |     | South Approach |     |     | West Approach |     |     |       |
|                                 | RT             | TH  | LT  | RT            | TH  | LT  | RT             | TH  | LT  | RT            | TH  | LT  |       |
| Existing Conditions             | 42             | 254 | 40  | 36            | 389 | 140 | 102            | 123 | 44  | 123           | 883 | 68  | 2244  |
| <b>Approved Project Trips</b>   |                |     |     |               |     |     |                |     |     |               |     |     |       |
| San Jose ATI                    | 1              | 10  | 1   | 0             | 2   | 4   | 6              | 5   | 0   | 0             | 4   | 0   | 33    |
| Santa Clara ATI                 | 0              | 0   | 0   | 0             | 0   | 0   | 0              | 0   | 0   | 0             | 0   | 0   | 0     |
| Total Approved Trips            | 1              | 10  | 1   | 0             | 2   | 4   | 6              | 5   | 0   | 0             | 4   | 0   | 33    |
| Background Conditions           | 43             | 264 | 41  | 36            | 391 | 144 | 108            | 128 | 44  | 123           | 887 | 68  | 2277  |
| <b>2015 Project Trips</b>       |                |     |     |               |     |     |                |     |     |               |     |     |       |
| BART                            | 0              | -4  | 0   | 0             | 1   | 12  | 8              | -2  | -1  | -3            | -2  | -7  | 2     |
| Joint Development               | 0              | 0   | 1   | 0             | 30  | 37  | 14             | 0   | 0   | 1             | 32  | 0   | 115   |
| Net 2015 Trips                  | 0              | -4  | 1   | 0             | 31  | 49  | 22             | -2  | -1  | -2            | 30  | -7  | 117   |
| Existing + Project              | 42             | 250 | 41  | 36            | 420 | 189 | 124            | 121 | 43  | 121           | 913 | 61  | 2361  |
| <b>2025 Project Trips</b>       |                |     |     |               |     |     |                |     |     |               |     |     |       |
| BART                            | -1             | -11 | -1  | 0             | 5   | 25  | 15             | -3  | -1  | -4            | -3  | -8  | 13    |
| Joint Development               | 0              | 0   | 6   | 3             | 47  | 40  | 11             | 0   | 0   | 0             | 28  | 0   | 135   |
| Net 2025 Trips                  | -1             | -11 | 5   | 3             | 52  | 65  | 26             | -3  | -1  | -4            | 25  | -8  | 148   |
| Background + Project            | 42             | 253 | 46  | 39            | 443 | 209 | 134            | 125 | 43  | 119           | 912 | 60  | 2425  |
| Cumulative No Project           | 131            | 264 | 176 | 77            | 623 | 158 | 120            | 182 | 172 | 253           | 887 | 132 | 3043  |
| <b>Cumulative Project Trips</b> |                |     |     |               |     |     |                |     |     |               |     |     |       |
| BART                            | -1             | -8  | -1  | 0             | 24  | 29  | 14             | -4  | -2  | -6            | -9  | -13 | 23    |
| Joint Development               | 0              | 0   | 3   | 3             | 60  | 25  | 14             | 0   | 0   | 2             | 19  | 2   | 128   |
| Net 2035 Trips                  | -1             | -8  | 2   | 3             | 84  | 54  | 28             | -4  | -2  | -4            | 10  | -11 | 151   |
| Cumulative With Project         | 130            | 256 | 178 | 80            | 707 | 212 | 148            | 178 | 170 | 249           | 897 | 121 | 3326  |

Intersection Number: 12  
 Traffic Node Number: 4022  
 Intersection Name: 26th St & E. Santa Clara St  
 Peak Hour: PM  
 Count Date: 10/09/14  
 Scenario: BART Extension Phase II  
 Date of Analysis: 09/02/15

| Scenario:                       | Movements      |    |    |               |     |    |                |    |    |               |     |    | Total |
|---------------------------------|----------------|----|----|---------------|-----|----|----------------|----|----|---------------|-----|----|-------|
|                                 | North Approach |    |    | East Approach |     |    | South Approach |    |    | West Approach |     |    |       |
|                                 | RT             | TH | LT | RT            | TH  | LT | RT             | TH | LT | RT            | TH  | LT |       |
| Existing Conditions             | 39             | 52 | 51 | 41            | 467 | 46 | 41             | 16 | 6  | 25            | 847 | 28 | 1659  |
| <b>Approved Project Trips</b>   |                |    |    |               |     |    |                |    |    |               |     |    |       |
| San Jose ATI                    | 0              | 0  | 0  | 0             | 3   | 0  | 0              | 0  | 0  | 0             | 4   | 0  | 7     |
| Santa Clara ATI                 | 0              | 0  | 0  | 0             | 0   | 0  | 0              | 0  | 0  | 0             | 0   | 0  | 0     |
| Total Approved Trips            | 0              | 0  | 0  | 0             | 3   | 0  | 0              | 0  | 0  | 0             | 4   | 0  | 7     |
| Background Conditions           | 39             | 52 | 51 | 41            | 470 | 46 | 41             | 16 | 6  | 25            | 851 | 28 | 1666  |
| <b>2015 Project Trips</b>       |                |    |    |               |     |    |                |    |    |               |     |    |       |
| BART                            | 0              | 0  | 0  | 0             | 13  | 0  | 0              | 0  | 0  | 0             | 4   | 0  | 17    |
| Joint Development               | 0              | 0  | 0  | 0             | 68  | 0  | 0              | 0  | 0  | 0             | 49  | 0  | 117   |
| Net 2015 Trips                  | 0              | 0  | 0  | 0             | 81  | 0  | 0              | 0  | 0  | 0             | 53  | 0  | 134   |
| Existing + Project              | 39             | 52 | 51 | 41            | 548 | 46 | 41             | 16 | 6  | 25            | 900 | 28 | 1793  |
| <b>2025 Project Trips</b>       |                |    |    |               |     |    |                |    |    |               |     |    |       |
| BART                            | 0              | 0  | 0  | 0             | 29  | 0  | 0              | 0  | 0  | 0             | 9   | 0  | 38    |
| Joint Development               | 0              | 0  | 0  | 0             | 90  | 0  | 0              | 0  | 0  | 0             | 45  | 0  | 135   |
| Net 2025 Trips                  | 0              | 0  | 0  | 0             | 119 | 0  | 0              | 0  | 0  | 0             | 54  | 0  | 173   |
| Background + Project            | 39             | 52 | 51 | 41            | 589 | 46 | 41             | 16 | 6  | 25            | 905 | 28 | 1839  |
| Cumulative No Project           | 39             | 52 | 51 | 41            | 760 | 46 | 41             | 16 | 6  | 25            | 851 | 28 | 1928  |
| <b>Cumulative Project Trips</b> |                |    |    |               |     |    |                |    |    |               |     |    |       |
| BART                            | 0              | 0  | 0  | 0             | 52  | 0  | 0              | 0  | 0  | 0             | 4   | 0  | 56    |
| Joint Development               | 0              | 0  | 0  | 0             | 89  | 0  | 0              | 0  | 0  | 0             | 36  | 0  | 125   |
| Net 2035 Trips                  | 0              | 0  | 0  | 0             | 141 | 0  | 0              | 0  | 0  | 0             | 40  | 0  | 181   |
| Cumulative With Project         | 39             | 52 | 51 | 41            | 901 | 46 | 41             | 16 | 6  | 25            | 891 | 28 | 2137  |

Intersection Number: 13  
 Traffic Node Number: 3788  
 Intersection Name: N. 28th St & E. Santa Clara St  
 Peak Hour: PM  
 Count Date: 10/09/14  
 Scenario: BART Extension Phase II  
 Date of Analysis: 09/02/15

| Scenario:                       | Movements      |     |     |               |     |     |                |     |    |               |     |    | Total |
|---------------------------------|----------------|-----|-----|---------------|-----|-----|----------------|-----|----|---------------|-----|----|-------|
|                                 | North Approach |     |     | East Approach |     |     | South Approach |     |    | West Approach |     |    |       |
|                                 | RT             | TH  | LT  | RT            | TH  | LT  | RT             | TH  | LT | RT            | TH  | LT |       |
| Existing Conditions             | 19             | 61  | 74  | 65            | 513 | 143 | 141            | 36  | 23 | 40            | 863 | 18 | 1996  |
| <b>Approved Project Trips</b>   |                |     |     |               |     |     |                |     |    |               |     |    |       |
| San Jose ATI                    | 0              | 0   | 0   | 0             | 9   | 1   | 0              | 0   | 0  | 0             | 7   | 0  | 17    |
| Santa Clara ATI                 | 0              | 0   | 0   | 0             | 0   | 0   | 0              | 0   | 0  | 0             | 0   | 0  | 0     |
| Total Approved Trips            | 0              | 0   | 0   | 0             | 9   | 1   | 0              | 0   | 0  | 0             | 7   | 0  | 17    |
| Background Conditions           | 19             | 61  | 74  | 65            | 522 | 144 | 141            | 36  | 23 | 40            | 870 | 18 | 2013  |
| <b>2015 Project Trips</b>       |                |     |     |               |     |     |                |     |    |               |     |    |       |
| BART                            | 13             | 1   | 78  | 21            | 0   | 0   | -2             | 1   | 0  | 0             | -6  | 10 | 116   |
| Joint Development               | 68             | 21  | 124 | 45            | 0   | 0   | 0              | 7   | 0  | 0             | 2   | 47 | 314   |
| Net 2015 Trips                  | 81             | 22  | 202 | 66            | 0   | 0   | -2             | 8   | 0  | 0             | -4  | 57 | 430   |
| Existing + Project              | 100            | 83  | 276 | 131           | 513 | 143 | 139            | 44  | 23 | 40            | 859 | 75 | 2426  |
| <b>2025 Project Trips</b>       |                |     |     |               |     |     |                |     |    |               |     |    |       |
| BART                            | 31             | 3   | 173 | 34            | -3  | 0   | -2             | 2   | 0  | 0             | -11 | 18 | 245   |
| Joint Development               | 90             | 37  | 101 | 45            | 0   | 0   | 0              | 21  | 0  | 0             | 2   | 43 | 339   |
| Net 2025 Trips                  | 121            | 40  | 274 | 79            | -3  | 0   | -2             | 23  | 0  | 0             | -9  | 61 | 584   |
| Background + Project            | 140            | 101 | 348 | 144           | 519 | 144 | 139            | 59  | 23 | 40            | 861 | 79 | 2597  |
| Cumulative No Project           | 64             | 61  | 74  | 65            | 760 | 144 | 141            | 109 | 23 | 46            | 870 | 19 | 2357  |
| <b>Cumulative Project Trips</b> |                |     |     |               |     |     |                |     |    |               |     |    |       |
| BART                            | 56             | 17  | 169 | 39            | -4  | 0   | -2             | 5   | 0  | 0             | -19 | 20 | 281   |
| Joint Development               | 89             | 15  | 116 | 36            | 0   | 0   | 0              | 10  | 0  | 0             | 2   | 34 | 302   |
| Net 2035 Trips                  | 145            | 32  | 285 | 75            | -4  | 0   | -2             | 15  | 0  | 0             | -17 | 54 | 583   |
| Cumulative With Project         | 209            | 93  | 359 | 140           | 756 | 144 | 139            | 124 | 23 | 46            | 853 | 73 | 2959  |

Intersection Number: 14  
 Traffic Node Number: 3023  
 Intersection Name: US 101 & E. Santa Clara St  
 Peak Hour: PM  
 Count Date: 09/09/14  
 Scenario: BART Extension Phase II  
 Date of Analysis: 09/02/15

| Scenario:                       | Movements      |    |     |               |     |      |                |    |    |               |      |    | Total |
|---------------------------------|----------------|----|-----|---------------|-----|------|----------------|----|----|---------------|------|----|-------|
|                                 | North Approach |    |     | East Approach |     |      | South Approach |    |    | West Approach |      |    |       |
|                                 | RT             | TH | LT  | RT            | TH  | LT   | RT             | TH | LT | RT            | TH   | LT |       |
| Existing Conditions             | 200            | 4  | 247 | 0             | 630 | 453  | 0              | 0  | 0  | 492           | 696  | 0  | 2722  |
| <b>Approved Project Trips</b>   |                |    |     |               |     |      |                |    |    |               |      |    |       |
| San Jose ATI                    | 4              | 0  | 13  | 0             | 6   | 4    | 0              | 0  | 0  | 2             | 10   | 0  | 39    |
| Santa Clara ATI                 | 0              | 0  | 0   | 0             | 0   | 0    | 0              | 0  | 0  | 0             | 0    | 0  | 0     |
| Total Approved Trips            | 4              | 0  | 13  | 0             | 6   | 4    | 0              | 0  | 0  | 2             | 10   | 0  | 39    |
| Background Conditions           | 204            | 4  | 260 | 0             | 636 | 457  | 0              | 0  | 0  | 494           | 706  | 0  | 2761  |
| <b>2015 Project Trips</b>       |                |    |     |               |     |      |                |    |    |               |      |    |       |
| BART                            | 0              | 0  | -2  | 0             | 21  | -1   | 0              | 0  | 0  | 73            | -3   | 0  | 88    |
| Joint Development               | 0              | 0  | 25  | 0             | 45  | 6    | 0              | 0  | 0  | 86            | 40   | 0  | 202   |
| Net 2015 Trips                  | 0              | 0  | 23  | 0             | 66  | 5    | 0              | 0  | 0  | 159           | 37   | 0  | 290   |
| Existing + Project              | 200            | 4  | 270 | 0             | 696 | 458  | 0              | 0  | 0  | 651           | 733  | 0  | 3012  |
| <b>2025 Project Trips</b>       |                |    |     |               |     |      |                |    |    |               |      |    |       |
| BART                            | -1             | 0  | 0   | 0             | 31  | -92  | 0              | 0  | 0  | 164           | -4   | 0  | 98    |
| Joint Development               | 2              | 0  | 12  | 0             | 44  | 5    | 0              | 0  | 0  | 78            | 25   | 0  | 166   |
| Net 2025 Trips                  | 1              | 0  | 12  | 0             | 75  | -87  | 0              | 0  | 0  | 242           | 21   | 0  | 264   |
| Background + Project            | 205            | 4  | 272 | 0             | 711 | 370  | 0              | 0  | 0  | 736           | 727  | 0  | 3025  |
| Cumulative No Project           | 230            | 4  | 519 | 0             | 820 | 640  | 0              | 0  | 0  | 494           | 976  | 0  | 3683  |
| <b>Cumulative Project Trips</b> |                |    |     |               |     |      |                |    |    |               |      |    |       |
| BART                            | -1             | 0  | 2   | 0             | 35  | -103 | 0              | 0  | 0  | 159           | -12  | 0  | 80    |
| Joint Development               | 1              | 0  | 23  | 0             | 35  | 0    | 0              | 0  | 0  | 71            | 47   | 0  | 177   |
| Net 2035 Trips                  | 0              | 0  | 25  | 0             | 70  | -103 | 0              | 0  | 0  | 230           | 35   | 0  | 257   |
| Cumulative With Project         | 230            | 4  | 544 | 0             | 890 | 537  | 0              | 0  | 0  | 724           | 1011 | 0  | 3940  |

Intersection Number: 15  
 Traffix Node Number: 3016  
 Intersection Name: US 101 & Alum Rock Ave  
 Peak Hour: PM  
 Count Date: 09/09/14  
 Scenario: BART Extension Phase II  
 Date of Analysis: 09/02/15

| Scenario:                       | Movements      |    |    |               |      |    |                |    |     |               |      |     | Total |
|---------------------------------|----------------|----|----|---------------|------|----|----------------|----|-----|---------------|------|-----|-------|
|                                 | North Approach |    |    | East Approach |      |    | South Approach |    |     | West Approach |      |     |       |
|                                 | RT             | TH | LT | RT            | TH   | LT | RT             | TH | LT  | RT            | TH   | LT  |       |
| Existing Conditions             | 0              | 0  | 0  | 240           | 803  | 0  | 373            | 2  | 320 | 0             | 854  | 125 | 2717  |
| <b>Approved Project Trips</b>   |                |    |    |               |      |    |                |    |     |               |      |     |       |
| San Jose ATI                    | 0              | 0  | 0  | 11            | 29   | 0  | 5              | 0  | 0   | 0             | 20   | 1   | 66    |
| Santa Clara ATI                 | 0              | 0  | 0  | 0             | 0    | 0  | 0              | 0  | 0   | 0             | 0    | 0   | 0     |
| Total Approved Trips            | 0              | 0  | 0  | 11            | 29   | 0  | 5              | 0  | 0   | 0             | 20   | 1   | 66    |
| Background Conditions           | 0              | 0  | 0  | 251           | 832  | 0  | 378            | 2  | 320 | 0             | 874  | 126 | 2783  |
| <b>2015 Project Trips</b>       |                |    |    |               |      |    |                |    |     |               |      |     |       |
| BART                            | 0              | 0  | 0  | 0             | 0    | 0  | 0              | 0  | 21  | 0             | -3   | -2  | 16    |
| Joint Development               | 0              | 0  | 0  | 0             | 14   | 0  | 0              | 0  | 37  | 0             | 63   | 0   | 114   |
| Net 2015 Trips                  | 0              | 0  | 0  | 0             | 14   | 0  | 0              | 0  | 58  | 0             | 60   | -2  | 130   |
| Existing + Project              | 0              | 0  | 0  | 240           | 817  | 0  | 373            | 2  | 378 | 0             | 914  | 123 | 2847  |
| <b>2025 Project Trips</b>       |                |    |    |               |      |    |                |    |     |               |      |     |       |
| BART                            | 0              | 0  | 0  | 0             | -92  | 0  | -2             | 0  | 32  | 0             | -1   | -3  | -66   |
| Joint Development               | 0              | 0  | 0  | 0             | 14   | 0  | 0              | 0  | 35  | 0             | 38   | 0   | 87    |
| Net 2025 Trips                  | 0              | 0  | 0  | 0             | -78  | 0  | -2             | 0  | 67  | 0             | 37   | -3  | 21    |
| Background + Project            | 0              | 0  | 0  | 251           | 754  | 0  | 376            | 2  | 387 | 0             | 911  | 123 | 2804  |
| Cumulative No Project           | 0              | 0  | 0  | 251           | 1108 | 0  | 548            | 2  | 393 | 0             | 1316 | 214 | 3618  |
| <b>Cumulative Project Trips</b> |                |    |    |               |      |    |                |    |     |               |      |     |       |
| BART                            | 0              | 0  | 0  | 0             | -103 | 0  | -11            | 0  | 36  | 0             | 2    | -12 | -88   |
| Joint Development               | 0              | 0  | 0  | 0             | 8    | 0  | 0              | 0  | 27  | 0             | 58   | 11  | 104   |
| Net 2035 Trips                  | 0              | 0  | 0  | 0             | -95  | 0  | -11            | 0  | 63  | 0             | 60   | -1  | 16    |
| Cumulative With Project         | 0              | 0  | 0  | 251           | 1013 | 0  | 537            | 2  | 456 | 0             | 1376 | 213 | 3848  |

Intersection Number: 16  
 Traffix Node Number: 3260  
 Intersection Name: 33rd St & Alum Rock Rd  
 Peak Hour: PM  
 Count Date: 05/20/15  
 Scenario: BART Extension Phase II  
 Date of Analysis: 09/02/15

| Scenario:                       | Movements      |    |    |               |      |    |                |    |    |               |      |     | Total |
|---------------------------------|----------------|----|----|---------------|------|----|----------------|----|----|---------------|------|-----|-------|
|                                 | North Approach |    |    | East Approach |      |    | South Approach |    |    | West Approach |      |     |       |
|                                 | RT             | TH | LT | RT            | TH   | LT | RT             | TH | LT | RT            | TH   | LT  |       |
| Existing Conditions             | 109            | 37 | 47 | 29            | 543  | 19 | 28             | 41 | 95 | 128           | 710  | 61  | 1847  |
| <b>Approved Project Trips</b>   |                |    |    |               |      |    |                |    |    |               |      |     |       |
| San Jose ATI                    | 0              | 0  | 0  | 2             | 45   | 23 | 4              | 0  | 1  | 0             | 18   | 0   | 93    |
| Santa Clara ATI                 | 0              | 0  | 0  | 0             | 0    | 0  | 0              | 0  | 0  | 0             | 0    | 0   | 0     |
| Total Approved Trips            | 0              | 0  | 0  | 2             | 45   | 23 | 4              | 0  | 1  | 0             | 18   | 0   | 93    |
| Background Conditions           | 109            | 37 | 47 | 31            | 588  | 42 | 32             | 41 | 96 | 128           | 728  | 61  | 1940  |
| <b>2015 Project Trips</b>       |                |    |    |               |      |    |                |    |    |               |      |     |       |
| BART                            | 0              | 0  | 0  | 0             | -4   | 0  | 0              | 0  | 0  | 0             | -3   | 0   | -7    |
| Joint Development               | 7              | 0  | 0  | 0             | 8    | 0  | 0              | 0  | 0  | 1             | 61   | 2   | 79    |
| Net 2015 Trips                  | 7              | 0  | 0  | 0             | 4    | 0  | 0              | 0  | 0  | 1             | 58   | 2   | 72    |
| Existing + Project              | 116            | 37 | 47 | 29            | 547  | 19 | 28             | 41 | 95 | 129           | 768  | 63  | 1919  |
| <b>2025 Project Trips</b>       |                |    |    |               |      |    |                |    |    |               |      |     |       |
| BART                            | 2              | 0  | 0  | 0             | -79  | 0  | 0              | 0  | 0  | 1             | -4   | -1  | -81   |
| Joint Development               | 2              | 0  | 0  | 0             | 12   | 0  | 0              | 0  | 0  | 1             | 36   | 1   | 52    |
| Net 2025 Trips                  | 4              | 0  | 0  | 0             | -67  | 0  | 0              | 0  | 0  | 2             | 32   | 0   | -29   |
| Background + Project            | 113            | 37 | 47 | 31            | 521  | 42 | 32             | 41 | 96 | 130           | 760  | 61  | 1911  |
| Cumulative No Project           | 109            | 74 | 57 | 72            | 835  | 42 | 43             | 72 | 98 | 128           | 1290 | 138 | 2820  |
| <b>Cumulative Project Trips</b> |                |    |    |               |      |    |                |    |    |               |      |     |       |
| BART                            | -1             | 0  | 0  | 0             | -103 | -1 | 0              | 0  | 1  | 0             | -2   | 0   | -106  |
| Joint Development               | 0              | 0  | 0  | 0             | 7    | 0  | 0              | 0  | 0  | 1             | 53   | 2   | 63    |
| Net 2035 Trips                  | -1             | 0  | 0  | 0             | -96  | -1 | 0              | 0  | 1  | 1             | 51   | 2   | -43   |
| Cumulative With Project         | 108            | 74 | 57 | 72            | 739  | 41 | 43             | 72 | 99 | 129           | 1341 | 140 | 2915  |

|                                 |                         |     |     |               |     |     |                |     |     |               |     |     |       |
|---------------------------------|-------------------------|-----|-----|---------------|-----|-----|----------------|-----|-----|---------------|-----|-----|-------|
| Intersection Number:            | 17                      |     |     |               |     |     |                |     |     |               |     |     |       |
| Traffic Node Number:            | 3064                    |     |     |               |     |     |                |     |     |               |     |     |       |
| Intersection Name:              | King Rd & Alum Rock Ave |     |     |               |     |     |                |     |     |               |     |     |       |
| Peak Hour:                      | PM                      |     |     |               |     |     |                |     |     |               |     |     |       |
| Count Date:                     | 09/16/14                |     |     |               |     |     |                |     |     |               |     |     |       |
| Scenario:                       | BART Extension Phase II |     |     |               |     |     |                |     |     |               |     |     |       |
|                                 | Movements               |     |     |               |     |     |                |     |     |               |     |     |       |
|                                 | North Approach          |     |     | East Approach |     |     | South Approach |     |     | West Approach |     |     |       |
| Scenario:                       | RT                      | TH  | LT  | RT            | TH  | LT  | RT             | TH  | LT  | RT            | TH  | LT  | Total |
| Existing Conditions             | 113                     | 508 | 106 | 94            | 579 | 136 | 97             | 257 | 140 | 214           | 573 | 118 | 2935  |
| <b>Approved Project Trips</b>   |                         |     |     |               |     |     |                |     |     |               |     |     |       |
| San Jose ATI                    | 26                      | 47  | 10  | 4             | 31  | 31  | 13             | 44  | 8   | 8             | 41  | 41  | 304   |
| Santa Clara ATI                 | 0                       | 0   | 0   | 0             | 0   | 0   | 0              | 0   | 0   | 0             | 0   | 0   | 0     |
| Total Approved Trips            | 26                      | 47  | 10  | 4             | 31  | 31  | 13             | 44  | 8   | 8             | 41  | 41  | 304   |
| Background Conditions           | 139                     | 555 | 116 | 98            | 610 | 167 | 110            | 301 | 148 | 222           | 614 | 159 | 3239  |
| <b>2015 Project Trips</b>       |                         |     |     |               |     |     |                |     |     |               |     |     |       |
| BART                            | -2                      | 10  | 10  | 7             | 0   | 0   | -2             | 3   | 0   | 1             | -3  | -1  | 23    |
| Joint Development               | 1                       | 1   | 2   | 0             | 5   | 0   | 3              | 2   | 1   | 11            | 39  | 9   | 74    |
| Net 2015 Trips                  | -1                      | 11  | 12  | 7             | 5   | 0   | 1              | 5   | 1   | 12            | 36  | 8   | 97    |
| Existing + Project              | 112                     | 519 | 118 | 101           | 584 | 136 | 98             | 262 | 141 | 226           | 609 | 126 | 3032  |
| <b>2025 Project Trips</b>       |                         |     |     |               |     |     |                |     |     |               |     |     |       |
| BART                            | -79                     | -22 | -21 | -6            | -3  | -1  | -3             | -4  | 0   | 0             | 1   | -5  | -143  |
| Joint Development               | 0                       | 1   | 4   | 0             | 5   | 0   | 3              | 6   | 6   | 7             | 24  | 5   | 61    |
| Net 2025 Trips                  | -79                     | -21 | -17 | -6            | 2   | -1  | 0              | 2   | 6   | 7             | 25  | 0   | -82   |
| Background + Project            | 60                      | 534 | 99  | 92            | 612 | 166 | 110            | 303 | 154 | 229           | 639 | 159 | 3157  |
| Cumulative No Project           | 291                     | 771 | 205 | 131           | 674 | 173 | 204            | 464 | 211 | 314           | 816 | 378 | 4254  |
| <b>Cumulative Project Trips</b> |                         |     |     |               |     |     |                |     |     |               |     |     |       |
| BART                            | -102                    | -38 | -23 | -10           | -2  | -2  | -3             | -13 | 1   | 1             | 6   | -9  | -194  |
| Joint Development               | 0                       | 1   | 3   | 0             | 6   | 0   | 1              | 1   | 2   | 10            | 31  | 13  | 68    |
| Net 2035 Trips                  | -102                    | -37 | -20 | -10           | 4   | -2  | -2             | -12 | 3   | 11            | 37  | 4   | -126  |
| Cumulative With Project         | 189                     | 734 | 185 | 121           | 678 | 171 | 202            | 452 | 214 | 325           | 853 | 382 | 4506  |

|                                 |                             |     |     |               |     |     |                |     |     |               |     |     |       |
|---------------------------------|-----------------------------|-----|-----|---------------|-----|-----|----------------|-----|-----|---------------|-----|-----|-------|
| Intersection Number:            | 18                          |     |     |               |     |     |                |     |     |               |     |     |       |
| Traffic Node Number:            | 3063                        |     |     |               |     |     |                |     |     |               |     |     |       |
| Intersection Name:              | Jackson Ave & Alum Rock Ave |     |     |               |     |     |                |     |     |               |     |     |       |
| Peak Hour:                      | PM                          |     |     |               |     |     |                |     |     |               |     |     |       |
| Count Date:                     | 09/30/14                    |     |     |               |     |     |                |     |     |               |     |     |       |
| Scenario:                       | BART Extension Phase II     |     |     |               |     |     |                |     |     |               |     |     |       |
|                                 | Movements                   |     |     |               |     |     |                |     |     |               |     |     |       |
|                                 | North Approach              |     |     | East Approach |     |     | South Approach |     |     | West Approach |     |     |       |
| Scenario:                       | RT                          | TH  | LT  | RT            | TH  | LT  | RT             | TH  | LT  | RT            | TH  | LT  | Total |
| Existing Conditions             | 117                         | 867 | 120 | 156           | 479 | 238 | 168            | 385 | 127 | 105           | 454 | 213 | 3429  |
| <b>Approved Project Trips</b>   |                             |     |     |               |     |     |                |     |     |               |     |     |       |
| San Jose ATI                    | 9                           | 85  | 30  | 15            | 21  | 25  | 31             | 61  | 75  | 61            | 7   | 6   | 426   |
| Santa Clara ATI                 | 0                           | 0   | 0   | 0             | 0   | 0   | 0              | 0   | 0   | 0             | 0   | 0   | 0     |
| Total Approved Trips            | 9                           | 85  | 30  | 15            | 21  | 25  | 31             | 61  | 75  | 61            | 7   | 6   | 426   |
| Background Conditions           | 126                         | 952 | 150 | 171           | 500 | 263 | 199            | 446 | 202 | 166           | 461 | 219 | 3855  |
| <b>2015 Project Trips</b>       |                             |     |     |               |     |     |                |     |     |               |     |     |       |
| BART                            | 0                           | 13  | 0   | 0             | -2  | -10 | 0              | 0   | 6   | 9             | -4  | 0   | 12    |
| Joint Development               | 0                           | 0   | 0   | 0             | 3   | 0   | 0              | 0   | 0   | 13            | 27  | 1   | 44    |
| Net 2015 Trips                  | 0                           | 13  | 0   | 0             | 1   | -10 | 0              | 0   | 6   | 22            | 23  | 1   | 56    |
| Existing + Project              | 117                         | 880 | 120 | 156           | 480 | 228 | 168            | 385 | 133 | 127           | 477 | 214 | 3485  |
| <b>2025 Project Trips</b>       |                             |     |     |               |     |     |                |     |     |               |     |     |       |
| BART                            | 0                           | -9  | 0   | -1            | -3  | -5  | 0              | 0   | -7  | -16           | -3  | 0   | -44   |
| Joint Development               | 1                           | 0   | 0   | 0             | 2   | 1   | 0              | 0   | 0   | 8             | 16  | 1   | 29    |
| Net 2025 Trips                  | 1                           | -9  | 0   | -1            | -1  | -4  | 0              | 0   | -7  | -8            | 13  | 1   | -15   |
| Background + Project            | 127                         | 943 | 150 | 170           | 499 | 259 | 199            | 446 | 195 | 158           | 474 | 220 | 3840  |
| Cumulative No Project           | 181                         | 952 | 230 | 171           | 500 | 312 | 204            | 595 | 243 | 316           | 610 | 241 | 4314  |
| <b>Cumulative Project Trips</b> |                             |     |     |               |     |     |                |     |     |               |     |     |       |
| BART                            | 0                           | -15 | 0   | -2            | -4  | -2  | 0              | 0   | -10 | -7            | -5  | -1  | -46   |
| Joint Development               | 0                           | 0   | 1   | 0             | 2   | 0   | 0              | 0   | 2   | 12            | 20  | 1   | 38    |
| Net 2035 Trips                  | 0                           | -15 | 1   | -2            | -2  | -2  | 0              | 0   | -8  | 5             | 15  | 0   | -8    |
| Cumulative With Project         | 181                         | 937 | 231 | 169           | 498 | 310 | 204            | 595 | 235 | 321           | 625 | 241 | 4547  |

Intersection Number: 19  
 Traffic Node Number: 3043  
 Intersection Name: I-680 S & Alum Rock Ave (West)  
 Peak Hour: PM  
 Count Date: 09/25/14  
 Scenario: BART Extension Phase II  
 Date of Analysis: 09/02/15

| Scenario:                       | Movements      |    |     |               |     |    |                |    |    |               |     |    | Total |
|---------------------------------|----------------|----|-----|---------------|-----|----|----------------|----|----|---------------|-----|----|-------|
|                                 | North Approach |    |     | East Approach |     |    | South Approach |    |    | West Approach |     |    |       |
|                                 | RT             | TH | LT  | RT            | TH  | LT | RT             | TH | LT | RT            | TH  | LT |       |
| Existing Conditions             | 282            | 27 | 340 | 592           | 539 | 34 | 41             | 0  | 20 | 45            | 651 | 0  | 2571  |
| <b>Approved Project Trips</b>   |                |    |     |               |     |    |                |    |    |               |     |    |       |
| San Jose ATI                    | 12             | 0  | 0   | 0             | 16  | 0  | 0              | 0  | 0  | 0             | 35  | 0  | 63    |
| Santa Clara ATI                 | 0              | 0  | 0   | 0             | 0   | 0  | 0              | 0  | 0  | 0             | 0   | 0  | 0     |
| Total Approved Trips            | 12             | 0  | 0   | 0             | 16  | 0  | 0              | 0  | 0  | 0             | 35  | 0  | 63    |
| Background Conditions           | 294            | 27 | 340 | 592           | 555 | 34 | 41             | 0  | 20 | 45            | 686 | 0  | 2634  |
| <b>2015 Project Trips</b>       |                |    |     |               |     |    |                |    |    |               |     |    |       |
| BART                            | -11            | 0  | -2  | 0             | -1  | 0  | 0              | 0  | 0  | 0             | -4  | 0  | -18   |
| Joint Development               | 0              | 0  | 1   | 0             | 3   | 0  | 0              | 0  | 0  | 0             | 26  | 0  | 30    |
| Net 2015 Trips                  | -11            | 0  | -1  | 0             | 2   | 0  | 0              | 0  | 0  | 0             | 22  | 0  | 12    |
| Existing + Project              | 271            | 27 | 339 | 592           | 541 | 34 | 41             | 0  | 20 | 45            | 673 | 0  | 2583  |
| <b>2025 Project Trips</b>       |                |    |     |               |     |    |                |    |    |               |     |    |       |
| BART                            | -5             | 0  | -9  | 0             | -3  | 0  | 0              | 0  | 0  | 0             | -4  | 0  | -21   |
| Joint Development               | 1              | 0  | 1   | 0             | 2   | 0  | 0              | 0  | 0  | 0             | 15  | 0  | 19    |
| Net 2025 Trips                  | -4             | 0  | -8  | 0             | -1  | 0  | 0              | 0  | 0  | 0             | 11  | 0  | -2    |
| Background + Project            | 290            | 27 | 332 | 592           | 554 | 34 | 41             | 0  | 20 | 45            | 697 | 0  | 2632  |
| Cumulative No Project           | 476            | 35 | 340 | 592           | 555 | 34 | 59             | 0  | 32 | 57            | 943 | 0  | 3123  |
| <b>Cumulative Project Trips</b> |                |    |     |               |     |    |                |    |    |               |     |    |       |
| BART                            | -3             | 0  | -2  | 0             | -5  | 0  | 0              | 0  | 0  | 0             | -5  | 0  | -15   |
| Joint Development               | 0              | 0  | 2   | 0             | 2   | 0  | 0              | 0  | 0  | 0             | 20  | 0  | 24    |
| Net 2035 Trips                  | -3             | 0  | 0   | 0             | -3  | 0  | 0              | 0  | 0  | 0             | 15  | 0  | 9     |
| Cumulative With Project         | 473            | 35 | 340 | 592           | 552 | 34 | 59             | 0  | 32 | 57            | 958 | 0  | 3132  |

Intersection Number: 20  
 Traffic Node Number: 3042  
 Intersection Name: I-680 N & Alum Rock Ave (East)  
 Peak Hour: PM  
 Count Date: 09/25/14  
 Scenario: BART Extension Phase II  
 Date of Analysis: 09/02/15

| Scenario:                       | Movements      |    |    |               |      |    |                |    |     |               |     |    | Total |
|---------------------------------|----------------|----|----|---------------|------|----|----------------|----|-----|---------------|-----|----|-------|
|                                 | North Approach |    |    | East Approach |      |    | South Approach |    |     | West Approach |     |    |       |
|                                 | RT             | TH | LT | RT            | TH   | LT | RT             | TH | LT  | RT            | TH  | LT |       |
| Existing Conditions             | 0              | 0  | 0  | 240           | 1047 | 0  | 1038           | 0  | 154 | 0             | 873 | 0  | 3352  |
| <b>Approved Project Trips</b>   |                |    |    |               |      |    |                |    |     |               |     |    |       |
| San Jose ATI                    | 0              | 0  | 0  | 4             | 37   | 0  | 0              | 0  | 0   | 8             | 32  | 0  | 81    |
| Santa Clara ATI                 | 0              | 0  | 0  | 0             | 0    | 0  | 0              | 0  | 0   | 0             | 0   | 0  | 0     |
| Total Approved Trips            | 0              | 0  | 0  | 4             | 37   | 0  | 0              | 0  | 0   | 8             | 32  | 0  | 81    |
| Background Conditions           | 0              | 0  | 0  | 244           | 1084 | 0  | 1038           | 0  | 154 | 8             | 905 | 0  | 3433  |
| <b>2015 Project Trips</b>       |                |    |    |               |      |    |                |    |     |               |     |    |       |
| BART                            | 0              | 0  | 0  | 0             | -2   | 0  | -1             | 0  | 0   | 0             | -3  | 0  | -6    |
| Joint Development               | 0              | 0  | 0  | 0             | 3    | 0  | 0              | 0  | 0   | 0             | 13  | 0  | 16    |
| Net 2015 Trips                  | 0              | 0  | 0  | 0             | 1    | 0  | -1             | 0  | 0   | 0             | 10  | 0  | 10    |
| Existing + Project              | 0              | 0  | 0  | 240           | 1048 | 0  | 1037           | 0  | 154 | 0             | 883 | 0  | 3362  |
| <b>2025 Project Trips</b>       |                |    |    |               |      |    |                |    |     |               |     |    |       |
| BART                            | 0              | 0  | 0  | 0             | -8   | 0  | -6             | 0  | -3  | 0             | -9  | 0  | -26   |
| Joint Development               | 0              | 0  | 0  | 0             | 2    | 0  | 0              | 0  | 0   | 0             | 10  | 0  | 12    |
| Net 2025 Trips                  | 0              | 0  | 0  | 0             | -6   | 0  | -6             | 0  | -3  | 0             | 1   | 0  | -14   |
| Background + Project            | 0              | 0  | 0  | 244           | 1078 | 0  | 1032           | 0  | 151 | 8             | 906 | 0  | 3419  |
| Cumulative No Project           | 0              | 0  | 0  | 244           | 1214 | 0  | 1038           | 0  | 154 | 8             | 927 | 0  | 3585  |
| <b>Cumulative Project Trips</b> |                |    |    |               |      |    |                |    |     |               |     |    |       |
| BART                            | 0              | 0  | 0  | 0             | -7   | 0  | -7             | 0  | -5  | 0             | -4  | 0  | -23   |
| Joint Development               | 0              | 0  | 0  | 0             | 2    | 0  | 1              | 0  | 0   | 0             | 12  | 0  | 15    |
| Net 2035 Trips                  | 0              | 0  | 0  | 0             | -5   | 0  | -6             | 0  | -5  | 0             | 8   | 0  | -8    |
| Cumulative With Project         | 0              | 0  | 0  | 244           | 1209 | 0  | 1032           | 0  | 149 | 8             | 935 | 0  | 3577  |

Intersection Number: **21**  
 Traffix Node Number: 3762  
 Intersection Name: 24th St & San Antonio St  
 Peak Hour: PM  
 Count Date: 10/09/14  
 Scenario: BART Extension Phase II  
 Date of Analysis: 09/02/15

| Scenario:                       | Movements      |     |    |               |    |     |                |     |    |               |     |    | Total |
|---------------------------------|----------------|-----|----|---------------|----|-----|----------------|-----|----|---------------|-----|----|-------|
|                                 | North Approach |     |    | East Approach |    |     | South Approach |     |    | West Approach |     |    |       |
|                                 | RT             | TH  | LT | RT            | TH | LT  | RT             | TH  | LT | RT            | TH  | LT |       |
| Existing Conditions             | 20             | 329 | 20 | 29            | 80 | 87  | 102            | 270 | 41 | 38            | 143 | 7  | 1166  |
| <b>Approved Project Trips</b>   |                |     |    |               |    |     |                |     |    |               |     |    |       |
| San Jose ATI                    | 0              | 10  | 1  | 0             | 0  | 0   | 1              | 3   | 0  | 0             | 0   | 0  | 15    |
| Santa Clara ATI                 | 0              | 0   | 0  | 0             | 0  | 0   | 0              | 0   | 0  | 0             | 0   | 0  | 0     |
| Total Approved Trips            | 0              | 10  | 1  | 0             | 0  | 0   | 1              | 3   | 0  | 0             | 0   | 0  | 15    |
| Background Conditions           | 20             | 339 | 21 | 29            | 80 | 87  | 103            | 273 | 41 | 38            | 143 | 7  | 1181  |
| <b>2015 Project Trips</b>       |                |     |    |               |    |     |                |     |    |               |     |    |       |
| BART                            | 1              | 6   | 0  | 0             | 0  | 0   | 0              | 5   | 0  | 0             | 0   | 0  | 12    |
| Joint Development               | 1              | 36  | 0  | 0             | 0  | 0   | 2              | 14  | 0  | 0             | 3   | 1  | 57    |
| Net 2015 Trips                  | 2              | 42  | 0  | 0             | 0  | 0   | 2              | 19  | 0  | 0             | 3   | 1  | 69    |
| Existing + Project              | 22             | 371 | 20 | 29            | 80 | 87  | 104            | 289 | 41 | 38            | 146 | 8  | 1235  |
| <b>2025 Project Trips</b>       |                |     |    |               |    |     |                |     |    |               |     |    |       |
| BART                            | -3             | 12  | 0  | 0             | 0  | 0   | 0              | 10  | 0  | 0             | 0   | 1  | 20    |
| Joint Development               | 1              | 38  | 0  | 0             | 0  | 0   | 10             | 10  | 0  | 0             | 7   | 0  | 66    |
| Net 2025 Trips                  | -2             | 50  | 0  | 0             | 0  | 0   | 10             | 20  | 0  | 0             | 7   | 1  | 86    |
| Background + Project            | 18             | 389 | 21 | 29            | 80 | 87  | 113            | 293 | 41 | 38            | 150 | 8  | 1267  |
| Cumulative No Project           | 24             | 339 | 53 | 39            | 94 | 105 | 130            | 422 | 48 | 52            | 347 | 56 | 1653  |
| <b>Cumulative Project Trips</b> |                |     |    |               |    |     |                |     |    |               |     |    |       |
| BART                            | 1              | 14  | -1 | 0             | 0  | 0   | -1             | 9   | 0  | 0             | 0   | -2 | 20    |
| Joint Development               | 1              | 25  | 0  | 0             | 0  | 0   | 3              | 10  | 0  | 0             | 3   | 3  | 45    |
| Net 2035 Trips                  | 2              | 39  | -1 | 0             | 0  | 0   | 2              | 19  | 0  | 0             | 3   | 1  | 65    |
| Cumulative With Project         | 26             | 378 | 52 | 39            | 94 | 105 | 132            | 441 | 48 | 52            | 350 | 57 | 1774  |

Intersection Number: **22**  
 Traffix Node Number: 3627  
 Intersection Name: King Rd & E. San Antonio St.  
 Peak Hour: PM  
 Count Date: 05/20/15  
 Scenario: BART Extension Phase II  
 Date of Analysis: 09/02/15

| Scenario:                       | Movements      |     |     |               |     |     |                |     |     |               |     |     | Total |
|---------------------------------|----------------|-----|-----|---------------|-----|-----|----------------|-----|-----|---------------|-----|-----|-------|
|                                 | North Approach |     |     | East Approach |     |     | South Approach |     |     | West Approach |     |     |       |
|                                 | RT             | TH  | LT  | RT            | TH  | LT  | RT             | TH  | LT  | RT            | TH  | LT  |       |
| Existing Conditions             | 62             | 528 | 167 | 80            | 206 | 88  | 149            | 318 | 126 | 112           | 241 | 37  | 2114  |
| <b>Approved Project Trips</b>   |                |     |     |               |     |     |                |     |     |               |     |     |       |
| San Jose ATI                    | 2              | 54  | 2   | 1             | 2   | 0   | 1              | 52  | 1   | 0             | 1   | 1   | 117   |
| Santa Clara ATI                 | 0              | 0   | 0   | 0             | 0   | 0   | 0              | 0   | 0   | 0             | 0   | 0   | 0     |
| Total Approved Trips            | 2              | 54  | 2   | 1             | 2   | 0   | 1              | 52  | 1   | 0             | 1   | 1   | 117   |
| Background Conditions           | 64             | 582 | 169 | 81            | 208 | 88  | 150            | 370 | 127 | 112           | 242 | 38  | 2231  |
| <b>2015 Project Trips</b>       |                |     |     |               |     |     |                |     |     |               |     |     |       |
| BART                            | 0              | 10  | 0   | 0             | 0   | 0   | 0              | 2   | 0   | 2             | 1   | -2  | 13    |
| Joint Development               | 0              | 12  | 0   | 0             | 0   | 0   | 0              | 1   | 0   | 5             | 5   | 5   | 28    |
| Net 2015 Trips                  | 0              | 22  | 0   | 0             | 0   | 0   | 0              | 3   | 0   | 7             | 6   | 3   | 41    |
| Existing + Project              | 62             | 550 | 167 | 80            | 206 | 88  | 149            | 321 | 126 | 119           | 247 | 40  | 2155  |
| <b>2025 Project Trips</b>       |                |     |     |               |     |     |                |     |     |               |     |     |       |
| BART                            | -2             | -21 | 0   | 0             | 0   | -1  | -2             | -4  | 0   | -1            | 1   | -2  | -32   |
| Joint Development               | 0              | 8   | 0   | 0             | 0   | 0   | 0              | 2   | 0   | 8             | 11  | 12  | 41    |
| Net 2025 Trips                  | -2             | -13 | 0   | 0             | 0   | -1  | -2             | -2  | 0   | 7             | 12  | 10  | 9     |
| Background + Project            | 62             | 569 | 169 | 81            | 208 | 87  | 148            | 368 | 127 | 119           | 254 | 48  | 2240  |
| Cumulative No Project           | 128            | 810 | 220 | 81            | 222 | 106 | 173            | 544 | 150 | 112           | 315 | 197 | 2861  |
| <b>Cumulative Project Trips</b> |                |     |     |               |     |     |                |     |     |               |     |     |       |
| BART                            | -4             | -33 | -1  | 0             | 0   | -2  | -3             | -14 | 0   | 0             | 5   | -3  | -55   |
| Joint Development               | 0              | 11  | 0   | 0             | 0   | 0   | 0              | 2   | 2   | 3             | 4   | 2   | 24    |
| Net 2035 Trips                  | -4             | -22 | -1  | 0             | 0   | -2  | -3             | -12 | 2   | 3             | 9   | -1  | -31   |
| Cumulative With Project         | 124            | 788 | 219 | 81            | 222 | 104 | 170            | 532 | 152 | 115           | 324 | 196 | 3027  |

Intersection Number: **23**  
 Traffix Node Number: 3384  
 Intersection Name: Jackson Ave & E. San Antonio St/Capitol Expy  
 Peak Hour: PM  
 Count Date: 05/20/15  
 Scenario: BART Extension Phase II  
 Date of Analysis: 09/02/15

| Scenario:                       | Movements      |     |     |               |     |    |                |     |     |               |     |     | Total |
|---------------------------------|----------------|-----|-----|---------------|-----|----|----------------|-----|-----|---------------|-----|-----|-------|
|                                 | North Approach |     |     | East Approach |     |    | South Approach |     |     | West Approach |     |     |       |
|                                 | RT             | TH  | LT  | RT            | TH  | LT | RT             | TH  | LT  | RT            | TH  | LT  |       |
| Existing Conditions             | 186            | 762 | 350 | 222           | 249 | 39 | 84             | 339 | 167 | 223           | 323 | 133 | 3077  |
| <b>Approved Project Trips</b>   |                |     |     |               |     |    |                |     |     |               |     |     |       |
| San Jose ATI                    | 26             | 63  | 57  | 36            | 7   | 0  | 0              | 37  | 1   | 0             | 5   | 11  | 243   |
| Santa Clara ATI                 | 0              | 0   | 0   | 0             | 0   | 0  | 0              | 0   | 0   | 0             | 0   | 0   | 0     |
| Total Approved Trips            | 26             | 63  | 57  | 36            | 7   | 0  | 0              | 37  | 1   | 0             | 5   | 11  | 243   |
| Background Conditions           | 212            | 825 | 407 | 258           | 256 | 39 | 84             | 376 | 168 | 223           | 328 | 144 | 3320  |
| <b>2015 Project Trips</b>       |                |     |     |               |     |    |                |     |     |               |     |     |       |
| BART                            | 0              | -8  | 21  | 6             | 0   | 0  | 0              | 0   | 0   | 0             | 0   | 0   | 19    |
| Joint Development               | 0              | 1   | 12  | 0             | 0   | 0  | 0              | 0   | 0   | 3             | 3   | 0   | 19    |
| Net 2015 Trips                  | 0              | -7  | 33  | 6             | 0   | 0  | 0              | 0   | 0   | 3             | 3   | 0   | 38    |
| Existing + Project              | 186            | 755 | 383 | 228           | 249 | 39 | 84             | 339 | 167 | 226           | 326 | 133 | 3115  |
| <b>2025 Project Trips</b>       |                |     |     |               |     |    |                |     |     |               |     |     |       |
| BART                            | 0              | -11 | -20 | -6            | 0   | 0  | 0              | -1  | 0   | 0             | 0   | 0   | -38   |
| Joint Development               | 0              | 1   | 7   | 0             | 0   | 0  | 0              | 0   | 0   | 5             | 6   | 0   | 19    |
| Net 2025 Trips                  | 0              | -10 | -13 | -6            | 0   | 0  | 0              | -1  | 0   | 5             | 6   | 0   | -19   |
| Background + Project            | 212            | 815 | 394 | 252           | 256 | 39 | 84             | 375 | 168 | 228           | 334 | 144 | 3301  |
| Cumulative No Project           | 212            | 825 | 803 | 445           | 269 | 76 | 100            | 486 | 190 | 410           | 328 | 149 | 4144  |
| <b>Cumulative Project Trips</b> |                |     |     |               |     |    |                |     |     |               |     |     |       |
| BART                            | 0              | -9  | -14 | -9            | 0   | 0  | 0              | -1  | 0   | 1             | -2  | 0   | -34   |
| Joint Development               | 0              | 1   | 10  | 2             | 0   | 0  | 0              | 0   | 0   | 3             | 1   | 0   | 17    |
| Net 2035 Trips                  | 0              | -8  | -4  | -7            | 0   | 0  | 0              | -1  | 0   | 4             | -1  | 0   | -17   |
| Cumulative With Project         | 212            | 817 | 799 | 438           | 269 | 76 | 100            | 485 | 190 | 414           | 327 | 149 | 4276  |

Intersection Number: **24**  
 Traffix Node Number: 3832  
 Intersection Name: 24th St & E. William St.  
 Peak Hour: PM  
 Count Date: 10/09/14  
 Scenario: BART Extension Phase II  
 Date of Analysis: 09/02/15

| Scenario:                       | Movements      |     |    |               |    |    |                |     |     |               |     |    | Total |
|---------------------------------|----------------|-----|----|---------------|----|----|----------------|-----|-----|---------------|-----|----|-------|
|                                 | North Approach |     |    | East Approach |    |    | South Approach |     |     | West Approach |     |    |       |
|                                 | RT             | TH  | LT | RT            | TH | LT | RT             | TH  | LT  | RT            | TH  | LT |       |
| Existing Conditions             | 25             | 425 | 7  | 3             | 17 | 30 | 69             | 364 | 121 | 192           | 35  | 40 | 1328  |
| <b>Approved Project Trips</b>   |                |     |    |               |    |    |                |     |     |               |     |    |       |
| San Jose ATI                    | 0              | 10  | 0  | 0             | 1  | 2  | 0              | 0   | 0   | 0             | 0   | 0  | 13    |
| Santa Clara ATI                 | 0              | 0   | 0  | 0             | 0  | 0  | 0              | 0   | 0   | 0             | 0   | 0  | 0     |
| Total Approved Trips            | 0              | 10  | 0  | 0             | 1  | 2  | 0              | 0   | 0   | 0             | 0   | 0  | 13    |
| Background Conditions           | 25             | 435 | 7  | 3             | 18 | 32 | 69             | 364 | 121 | 192           | 35  | 40 | 1341  |
| <b>2015 Project Trips</b>       |                |     |    |               |    |    |                |     |     |               |     |    |       |
| BART                            | 0              | 8   | -4 | -1            | 0  | -1 | -1             | 7   | 0   | 0             | 0   | 0  | 8     |
| Joint Development               | 0              | 35  | 0  | 0             | 0  | 0  | 0              | 14  | 0   | 0             | 0   | 0  | 49    |
| Net 2015 Trips                  | 0              | 43  | -4 | -1            | 0  | -1 | -1             | 21  | 0   | 0             | 0   | 0  | 57    |
| Existing + Project              | 25             | 468 | 3  | 2             | 17 | 29 | 68             | 385 | 121 | 192           | 35  | 40 | 1385  |
| <b>2025 Project Trips</b>       |                |     |    |               |    |    |                |     |     |               |     |    |       |
| BART                            | 0              | 15  | -3 | -1            | 0  | -3 | -2             | 11  | 0   | 0             | 0   | 0  | 17    |
| Joint Development               | 0              | 38  | 0  | 0             | 0  | 0  | 0              | 15  | 0   | 0             | 0   | 4  | 57    |
| Net 2025 Trips                  | 0              | 53  | -3 | -1            | 0  | -3 | -2             | 26  | 0   | 0             | 0   | 4  | 74    |
| Background + Project            | 25             | 488 | 4  | 2             | 18 | 29 | 67             | 390 | 121 | 192           | 35  | 44 | 1415  |
| Cumulative No Project           | 25             | 459 | 7  | 59            | 84 | 32 | 69             | 477 | 149 | 252           | 119 | 58 | 1732  |
| <b>Cumulative Project Trips</b> |                |     |    |               |    |    |                |     |     |               |     |    |       |
| BART                            | 0              | 20  | -5 | -3            | 0  | -2 | -2             | 11  | 0   | 0             | -1  | 0  | 18    |
| Joint Development               | 0              | 24  | 0  | 0             | 0  | 0  | 0              | 12  | 0   | 0             | 0   | 2  | 38    |
| Net 2035 Trips                  | 0              | 44  | -5 | -3            | 0  | -2 | -2             | 23  | 0   | 0             | -1  | 2  | 56    |
| Cumulative With Project         | 25             | 503 | 2  | 56            | 84 | 30 | 67             | 500 | 149 | 252           | 118 | 60 | 1846  |

Intersection Number: **25**  
 Traffic Node Number: 3036  
 Intersection Name: McLaughlin Ave & I-280 SB Ramp  
 Peak Hour: PM  
 Count Date: 09/24/14  
 Scenario: BART Extension Phase II  
 Date of Analysis: 09/02/15

| Scenario:                       | Movements      |     |    |               |    |    |                |      |    |               |    |     | Total |
|---------------------------------|----------------|-----|----|---------------|----|----|----------------|------|----|---------------|----|-----|-------|
|                                 | North Approach |     |    | East Approach |    |    | South Approach |      |    | West Approach |    |     |       |
|                                 | RT             | TH  | LT | RT            | TH | LT | RT             | TH   | LT | RT            | TH | LT  |       |
| Existing Conditions             | 0              | 557 | 0  | 0             | 0  | 0  | 0              | 783  | 0  | 546           | 0  | 273 | 2159  |
| <b>Approved Project Trips</b>   |                |     |    |               |    |    |                |      |    |               |    |     |       |
| San Jose ATI                    | 0              | 64  | 0  | 0             | 0  | 0  | 0              | 142  | 0  | 102           | 0  | 18  | 326   |
| Santa Clara ATI                 | 0              | 0   | 0  | 0             | 0  | 0  | 0              | 0    | 0  | 0             | 0  | 0   | 0     |
| Total Approved Trips            | 0              | 64  | 0  | 0             | 0  | 0  | 0              | 142  | 0  | 102           | 0  | 18  | 326   |
| Background Conditions           | 0              | 621 | 0  | 0             | 0  | 0  | 0              | 925  | 0  | 648           | 0  | 291 | 2485  |
| <b>2015 Project Trips</b>       |                |     |    |               |    |    |                |      |    |               |    |     |       |
| BART                            | 0              | 4   | 0  | 0             | 0  | 0  | 0              | 6    | 0  | -2            | 0  | 0   | 8     |
| Joint Development               | 0              | 10  | 0  | 0             | 0  | 0  | 0              | 9    | 0  | 3             | 0  | 4   | 26    |
| Net 2015 Trips                  | 0              | 14  | 0  | 0             | 0  | 0  | 0              | 15   | 0  | 1             | 0  | 4   | 34    |
| Existing + Project              | 0              | 571 | 0  | 0             | 0  | 0  | 0              | 798  | 0  | 547           | 0  | 277 | 2193  |
| <b>2025 Project Trips</b>       |                |     |    |               |    |    |                |      |    |               |    |     |       |
| BART                            | 0              | 13  | 0  | 0             | 0  | 0  | 0              | 7    | 0  | -7            | 0  | 0   | 13    |
| Joint Development               | 0              | 15  | 0  | 0             | 0  | 0  | 0              | 9    | 0  | 1             | 0  | 5   | 30    |
| Net 2025 Trips                  | 0              | 28  | 0  | 0             | 0  | 0  | 0              | 16   | 0  | -6            | 0  | 5   | 43    |
| Background + Project            | 0              | 649 | 0  | 0             | 0  | 0  | 0              | 941  | 0  | 642           | 0  | 296 | 2528  |
| Cumulative No Project           | 0              | 640 | 0  | 0             | 0  | 0  | 0              | 1004 | 0  | 648           | 0  | 291 | 2292  |
| <b>Cumulative Project Trips</b> |                |     |    |               |    |    |                |      |    |               |    |     |       |
| BART                            | 0              | 14  | 0  | 0             | 0  | 0  | 0              | 7    | 0  | -9            | 0  | -1  | 11    |
| Joint Development               | 0              | 11  | 0  | 0             | 0  | 0  | 0              | 8    | 0  | 1             | 0  | 2   | 22    |
| Net 2035 Trips                  | 0              | 25  | 0  | 0             | 0  | 0  | 0              | 15   | 0  | -8            | 0  | 1   | 33    |
| Cumulative With Project         | 0              | 665 | 0  | 0             | 0  | 0  | 0              | 1019 | 0  | 640           | 0  | 292 | 2616  |

Intersection Number: **26**  
 Traffic Node Number: 3683  
 Intersection Name: McLaughlin Ave & Story Rd  
 Peak Hour: PM  
 Count Date: 10/09/14  
 Scenario: BART Extension Phase II  
 Date of Analysis: 09/02/15

| Scenario:                       | Movements      |     |     |               |      |     |                |     |     |               |      |     | Total |
|---------------------------------|----------------|-----|-----|---------------|------|-----|----------------|-----|-----|---------------|------|-----|-------|
|                                 | North Approach |     |     | East Approach |      |     | South Approach |     |     | West Approach |      |     |       |
|                                 | RT             | TH  | LT  | RT            | TH   | LT  | RT             | TH  | LT  | RT            | TH   | LT  |       |
| Existing Conditions             | 224            | 669 | 249 | 214           | 970  | 494 | 201            | 284 | 122 | 101           | 1112 | 284 | 4924  |
| <b>Approved Project Trips</b>   |                |     |     |               |      |     |                |     |     |               |      |     |       |
| San Jose ATI                    | 120            | 17  | 3   | 5             | 410  | 11  | 5              | 14  | 71  | 73            | 411  | 120 | 1260  |
| Santa Clara ATI                 | 0              | 0   | 0   | 0             | 0    | 0   | 0              | 0   | 0   | 0             | 0    | 0   | 0     |
| Total Approved Trips            | 120            | 17  | 3   | 5             | 410  | 11  | 5              | 14  | 71  | 73            | 411  | 120 | 1260  |
| Background Conditions           | 344            | 686 | 252 | 219           | 1380 | 505 | 206            | 298 | 193 | 174           | 1523 | 404 | 6184  |
| <b>2015 Project Trips</b>       |                |     |     |               |      |     |                |     |     |               |      |     |       |
| BART                            | 1              | 0   | 1   | 0             | 1    | 1   | -4             | 4   | 0   | 0             | -1   | 2   | 5     |
| Joint Development               | 5              | 4   | 2   | 0             | 7    | 5   | 0              | 3   | 0   | 1             | 3    | 5   | 35    |
| Net 2015 Trips                  | 6              | 4   | 3   | 0             | 8    | 6   | -4             | 7   | 0   | 1             | 2    | 7   | 40    |
| Existing + Project              | 230            | 673 | 252 | 214           | 978  | 500 | 197            | 291 | 122 | 102           | 1114 | 291 | 4964  |
| <b>2025 Project Trips</b>       |                |     |     |               |      |     |                |     |     |               |      |     |       |
| BART                            | 3              | 1   | 0   | 0             | -1   | -11 | -7             | 3   | 0   | 0             | -17  | 6   | -23   |
| Joint Development               | 8              | 9   | 0   | 0             | 9    | 4   | 0              | 2   | 0   | 1             | 4    | 6   | 43    |
| Net 2025 Trips                  | 11             | 10  | 0   | 0             | 8    | -7  | -7             | 5   | 0   | 1             | -13  | 12  | 20    |
| Background + Project            | 355            | 696 | 252 | 219           | 1388 | 498 | 199            | 303 | 193 | 175           | 1510 | 416 | 6204  |
| Cumulative No Project           | 344            | 686 | 252 | 425           | 1380 | 505 | 219            | 308 | 193 | 240           | 1773 | 404 | 6325  |
| <b>Cumulative Project Trips</b> |                |     |     |               |      |     |                |     |     |               |      |     |       |
| BART                            | 5              | 2   | -2  | 0             | -3   | -8  | -8             | 4   | 0   | -1            | -17  | 3   | -25   |
| Joint Development               | 2              | 4   | 4   | 0             | 7    | 4   | 0              | 2   | 0   | 0             | 1    | 5   | 29    |
| Net 2035 Trips                  | 7              | 6   | 2   | 0             | 4    | -4  | -8             | 6   | 0   | -1            | -16  | 8   | 4     |
| Cumulative With Project         | 351            | 692 | 254 | 425           | 1384 | 501 | 211            | 314 | 193 | 239           | 1757 | 412 | 6733  |



Intersection Number: **27**  
 Traffix Node Number: 3623  
 Intersection Name: King Rd & Mabury Rd  
 Peak Hour: PM  
 Count Date: 10/08/14  
 Scenario: BART Extension Phase II  
 Date of Analysis: 09/02/15

| Scenario:                       | Movements      |     |     |               |     |    |                |     |     |               |     |     | Total |
|---------------------------------|----------------|-----|-----|---------------|-----|----|----------------|-----|-----|---------------|-----|-----|-------|
|                                 | North Approach |     |     | East Approach |     |    | South Approach |     |     | West Approach |     |     |       |
|                                 | RT             | TH  | LT  | RT            | TH  | LT | RT             | TH  | LT  | RT            | TH  | LT  |       |
| Existing Conditions             | 81             | 657 | 219 | 98            | 208 | 79 | 94             | 292 | 112 | 173           | 417 | 92  | 2522  |
| <b>Approved Project Trips</b>   |                |     |     |               |     |    |                |     |     |               |     |     |       |
| San Jose ATI                    | 55             | 305 | 48  | 47            | 55  | 19 | 18             | 279 | 137 | 153           | 61  | 41  | 1218  |
| Santa Clara ATI                 | 0              | 0   | 0   | 0             | 0   | 0  | 0              | 0   | 0   | 0             | 0   | 0   | 0     |
| Total Approved Trips            | 55             | 305 | 48  | 47            | 55  | 19 | 18             | 279 | 137 | 153           | 61  | 41  | 1218  |
| Background Conditions           | 136            | 962 | 267 | 145           | 263 | 98 | 112            | 571 | 249 | 326           | 478 | 133 | 3740  |
| <b>2015 Project Trips</b>       |                |     |     |               |     |    |                |     |     |               |     |     |       |
| BART                            | -10            | -8  | 0   | 0             | 2   | 0  | 0              | -5  | 16  | 19            | 36  | 0   | 50    |
| Joint Development               | 0              | 11  | 0   | 0             | 1   | 0  | 0              | 16  | 0   | 1             | 2   | 0   | 31    |
| Net 2015 Trips                  | -10            | 3   | 0   | 0             | 3   | 0  | 0              | 11  | 16  | 20            | 38  | 0   | 81    |
| Existing + Project              | 71             | 660 | 219 | 98            | 211 | 79 | 94             | 303 | 128 | 193           | 455 | 92  | 2603  |
| <b>2025 Project Trips</b>       |                |     |     |               |     |    |                |     |     |               |     |     |       |
| BART                            | -8             | -14 | -1  | 0             | -1  | 0  | 0              | -8  | -21 | -150          | -8  | -7  | -218  |
| Joint Development               | 0              | 11  | 0   | 0             | 1   | 0  | 0              | 21  | 2   | 6             | 5   | 2   | 48    |
| Net 2025 Trips                  | -8             | -3  | -1  | 0             | 0   | 0  | 0              | 13  | -19 | -144          | -3  | -5  | -170  |
| Background + Project            | 128            | 959 | 266 | 145           | 263 | 98 | 112            | 584 | 230 | 182           | 475 | 128 | 3570  |
| Cumulative No Project           | 177            | 962 | 278 | 145           | 388 | 98 | 128            | 715 | 427 | 326           | 656 | 573 | 4300  |
| <b>Cumulative Project Trips</b> |                |     |     |               |     |    |                |     |     |               |     |     |       |
| BART                            | -6             | -15 | 0   | 0             | -1  | 0  | 0              | -29 | -58 | -164          | -14 | 7   | -280  |
| Joint Development               | 0              | 8   | 0   | 0             | 1   | 0  | 1              | 14  | 3   | 3             | 5   | 3   | 38    |
| Net 2035 Trips                  | -6             | -7  | 0   | 0             | 0   | 0  | 1              | -15 | -55 | -161          | -9  | 10  | -242  |
| Cumulative With Project         | 171            | 955 | 278 | 145           | 388 | 98 | 129            | 700 | 372 | 165           | 647 | 583 | 4631  |

Intersection Number: **28**  
 Traffix Node Number: 5332  
 Intersection Name: Scott Blvd & Central Expy  
 Peak Hour: PM  
 Count Date: 10/02/14  
 Scenario: BART Extension Phase II  
 Date of Analysis: 09/02/15

| Scenario:                       | Movements      |     |     |               |      |     |                |     |     |               |      |     | Total |
|---------------------------------|----------------|-----|-----|---------------|------|-----|----------------|-----|-----|---------------|------|-----|-------|
|                                 | North Approach |     |     | East Approach |      |     | South Approach |     |     | West Approach |      |     |       |
|                                 | RT             | TH  | LT  | RT            | TH   | LT  | RT             | TH  | LT  | RT            | TH   | LT  |       |
| Existing Conditions             | 77             | 510 | 328 | 53            | 646  | 315 | 203            | 161 | 142 | 407           | 1718 | 41  | 4601  |
| <b>Approved Project Trips</b>   |                |     |     |               |      |     |                |     |     |               |      |     |       |
| San Jose ATI                    | 0              | 0   | 0   | 0             | 0    | 0   | 0              | 0   | 0   | 0             | 0    | 0   | 0     |
| Santa Clara ATI                 | 0              | 67  | 91  | 36            | 99   | 1   | 4              | 23  | 24  | 105           | 347  | 0   | 797   |
| Total Approved Trips            | 0              | 67  | 91  | 36            | 99   | 1   | 4              | 23  | 24  | 105           | 347  | 0   | 797   |
| Background Conditions           | 77             | 577 | 419 | 89            | 745  | 316 | 207            | 184 | 166 | 512           | 2065 | 41  | 5398  |
| <b>2015 Project Trips</b>       |                |     |     |               |      |     |                |     |     |               |      |     |       |
| BART                            | 0              | 0   | -1  | 0             | -2   | -1  | 0              | 0   | 0   | 0             | -3   | 0   | -7    |
| Joint Development               | 0              | 0   | 2   | 7             | 22   | 0   | 0              | 0   | 0   | 0             | 11   | 0   | 42    |
| Net 2015 Trips                  | 0              | 0   | 1   | 7             | 20   | -1  | 0              | 0   | 0   | 0             | 8    | 0   | 35    |
| Existing + Project              | 77             | 510 | 329 | 60            | 666  | 314 | 203            | 161 | 142 | 407           | 1726 | 41  | 4636  |
| <b>2025 Project Trips</b>       |                |     |     |               |      |     |                |     |     |               |      |     |       |
| BART                            | 0              | -2  | -4  | -1            | -8   | -5  | -2             | -1  | 0   | 0             | -15  | 0   | -38   |
| Joint Development               | 0              | 0   | 4   | 11            | 32   | 0   | 0              | 0   | 0   | 0             | 13   | 0   | 60    |
| Net 2025 Trips                  | 0              | -2  | 0   | 10            | 24   | -5  | -2             | -1  | 0   | 0             | -2   | 0   | 22    |
| Background + Project            | 77             | 575 | 419 | 99            | 769  | 311 | 205            | 183 | 166 | 512           | 2063 | 41  | 5420  |
| Cumulative No Project           | 140            | 609 | 736 | 203           | 1466 | 736 | 207            | 184 | 329 | 512           | 2574 | 106 | 7696  |
| <b>Cumulative Project Trips</b> |                |     |     |               |      |     |                |     |     |               |      |     |       |
| BART                            | 0              | -2  | -2  | 0             | -5   | -6  | -1             | 0   | 0   | 0             | -10  | 0   | -26   |
| Joint Development               | 0              | 0   | 4   | 7             | 35   | 0   | 0              | 0   | 0   | 0             | 13   | 0   | 59    |
| Net 2035 Trips                  | 0              | -2  | 2   | 7             | 30   | -6  | -1             | 0   | 0   | 0             | 3    | 0   | 33    |
| Cumulative With Project         | 140            | 607 | 738 | 210           | 1496 | 730 | 206            | 184 | 329 | 512           | 2577 | 106 | 7835  |

Intersection Number: **29**  
 Traffic Node Number: 5334  
 Intersection Name: Lafayette St & Central Expy  
 Peak Hour: PM  
 Count Date: 09/24/14  
 Scenario: BART Extension Phase II  
 Date of Analysis: 09/02/15

| Scenario:                       | Movements      |     |     |               |      |     |                |     |     |               |      |     | Total |
|---------------------------------|----------------|-----|-----|---------------|------|-----|----------------|-----|-----|---------------|------|-----|-------|
|                                 | North Approach |     |     | East Approach |      |     | South Approach |     |     | West Approach |      |     |       |
|                                 | RT             | TH  | LT  | RT            | TH   | LT  | RT             | TH  | LT  | RT            | TH   | LT  |       |
| Existing Conditions             | 276            | 897 | 354 | 79            | 706  | 197 | 291            | 275 | 152 | 389           | 2478 | 97  | 6191  |
| <b>Approved Project Trips</b>   |                |     |     |               |      |     |                |     |     |               |      |     |       |
| San Jose ATI                    | 0              | 0   | 0   | 0             | 0    | 0   | 0              | 0   | 0   | 0             | 0    | 0   | 0     |
| Santa Clara ATI                 | 2              | 24  | 0   | 0             | 100  | 2   | 16             | 14  | 29  | 109           | 326  | 4   | 626   |
| Total Approved Trips            | 2              | 24  | 0   | 0             | 100  | 2   | 16             | 14  | 29  | 109           | 326  | 4   | 626   |
| Background Conditions           | 278            | 921 | 354 | 79            | 806  | 199 | 307            | 289 | 181 | 498           | 2804 | 101 | 6817  |
| <b>2015 Project Trips</b>       |                |     |     |               |      |     |                |     |     |               |      |     |       |
| BART                            | 0              | 0   | -1  | 0             | -3   | 0   | 0              | 0   | 0   | 0             | -4   | 0   | -8    |
| Joint Development               | 0              | 2   | 8   | 16            | 29   | 2   | 0              | 0   | 0   | 2             | 13   | 0   | 72    |
| Net 2015 Trips                  | 0              | 2   | 7   | 16            | 26   | 2   | 0              | 0   | 0   | 2             | 9    | 0   | 64    |
| Existing + Project              | 276            | 899 | 361 | 95            | 732  | 199 | 291            | 275 | 152 | 391           | 2487 | 97  | 6255  |
| <b>2025 Project Trips</b>       |                |     |     |               |      |     |                |     |     |               |      |     |       |
| BART                            | -2             | -3  | -5  | -1            | -12  | 0   | -1             | -1  | -1  | -3            | -18  | 0   | -47   |
| Joint Development               | 0              | 2   | 8   | 27            | 42   | 7   | 0              | 1   | 3   | 2             | 16   | 0   | 108   |
| Net 2025 Trips                  | -2             | -1  | 3   | 26            | 30   | 7   | -1             | 0   | 2   | -1            | -2   | 0   | 61    |
| Background + Project            | 276            | 920 | 357 | 105           | 836  | 206 | 306            | 289 | 183 | 497           | 2802 | 101 | 6878  |
| Cumulative No Project           | 919            | 921 | 425 | 260           | 1269 | 199 | 311            | 574 | 305 | 825           | 3083 | 271 | 9091  |
| <b>Cumulative Project Trips</b> |                |     |     |               |      |     |                |     |     |               |      |     |       |
| BART                            | -1             | -1  | -1  | -1            | -10  | -1  | 0              | -2  | 0   | -1            | -11  | 0   | -29   |
| Joint Development               | 0              | 2   | 4   | 21            | 39   | 4   | 0              | 4   | 3   | 4             | 14   | 0   | 95    |
| Net 2035 Trips                  | -1             | 1   | 3   | 20            | 29   | 3   | 0              | 2   | 3   | 3             | 3    | 0   | 66    |
| Cumulative With Project         | 918            | 922 | 428 | 280           | 1298 | 202 | 311            | 576 | 308 | 828           | 3086 | 271 | 9428  |

Intersection Number: **30**  
 Traffic Node Number: 5335  
 Intersection Name: De La Cruz Blvd & Central Expy  
 Peak Hour: PM  
 Count Date: 10/02/14  
 Scenario: BART Extension Phase II  
 Date of Analysis: 09/02/15

| Scenario:                       | Movements      |      |    |               |    |    |                |     |     |               |    |      | Total |
|---------------------------------|----------------|------|----|---------------|----|----|----------------|-----|-----|---------------|----|------|-------|
|                                 | North Approach |      |    | East Approach |    |    | South Approach |     |     | West Approach |    |      |       |
|                                 | RT             | TH   | LT | RT            | TH | LT | RT             | TH  | LT  | RT            | TH | LT   |       |
| Existing Conditions             | 817            | 1092 | 0  | 0             | 0  | 0  | 0              | 657 | 182 | 1026          | 0  | 2083 | 5857  |
| <b>Approved Project Trips</b>   |                |      |    |               |    |    |                |     |     |               |    |      |       |
| San Jose ATI                    | 0              | 0    | 0  | 0             | 0  | 0  | 0              | 0   | 0   | 0             | 0  | 0    | 0     |
| Santa Clara ATI                 | 62             | 5    | 0  | 0             | 0  | 0  | 0              | 3   | 52  | 162           | 0  | 180  | 464   |
| Total Approved Trips            | 62             | 5    | 0  | 0             | 0  | 0  | 0              | 3   | 52  | 162           | 0  | 180  | 464   |
| Background Conditions           | 879            | 1097 | 0  | 0             | 0  | 0  | 0              | 660 | 234 | 1188          | 0  | 2263 | 6321  |
| <b>2015 Project Trips</b>       |                |      |    |               |    |    |                |     |     |               |    |      |       |
| BART                            | -2             | -5   | 0  | 0             | 0  | 0  | 0              | -5  | -2  | -4            | 0  | -2   | -20   |
| Joint Development               | 4              | 21   | 0  | 0             | 0  | 0  | 0              | 104 | 46  | 19            | 0  | 2    | 196   |
| Net 2015 Trips                  | 2              | 16   | 0  | 0             | 0  | 0  | 0              | 99  | 44  | 15            | 0  | 0    | 176   |
| Existing + Project              | 819            | 1108 | 0  | 0             | 0  | 0  | 0              | 756 | 226 | 1041          | 0  | 2083 | 6033  |
| <b>2025 Project Trips</b>       |                |      |    |               |    |    |                |     |     |               |    |      |       |
| BART                            | -10            | -16  | 0  | 0             | 0  | 0  | 0              | -14 | -5  | -8            | 0  | -18  | -71   |
| Joint Development               | 9              | 18   | 0  | 0             | 0  | 0  | 0              | 73  | 66  | 20            | 0  | 3    | 189   |
| Net 2025 Trips                  | -1             | 2    | 0  | 0             | 0  | 0  | 0              | 59  | 61  | 12            | 0  | -15  | 118   |
| Background + Project            | 878            | 1099 | 0  | 0             | 0  | 0  | 0              | 719 | 295 | 1200          | 0  | 2248 | 6439  |
| Cumulative No Project           | 879            | 1097 | 0  | 0             | 0  | 0  | 0              | 660 | 917 | 1407          | 0  | 2399 | 4960  |
| <b>Cumulative Project Trips</b> |                |      |    |               |    |    |                |     |     |               |    |      |       |
| BART                            | -9             | -12  | 0  | 0             | 0  | 0  | 0              | -10 | -5  | -7            | 0  | -8   | -51   |
| Joint Development               | 5              | 13   | 0  | 0             | 0  | 0  | 0              | 43  | 60  | 15            | 0  | 3    | 139   |
| Net 2035 Trips                  | -4             | 1    | 0  | 0             | 0  | 0  | 0              | 33  | 55  | 8             | 0  | -5   | 88    |
| Cumulative With Project         | 875            | 1098 | 0  | 0             | 0  | 0  | 0              | 693 | 972 | 1415          | 0  | 2394 | 7447  |

Intersection Number: **31**  
 Traffic Node Number: 6  
 Intersection Name: De La Cruz Blvd & Martin Ave  
 Peak Hour: PM  
 Count Date: 10/08/14  
 Scenario: BART Extension Phase II  
 Date of Analysis: 09/02/15

| Scenario:                       | Movements      |      |     |               |     |    |                |     |     |               |     |     | Total |
|---------------------------------|----------------|------|-----|---------------|-----|----|----------------|-----|-----|---------------|-----|-----|-------|
|                                 | North Approach |      |     | East Approach |     |    | South Approach |     |     | West Approach |     |     |       |
|                                 | RT             | TH   | LT  | RT            | TH  | LT | RT             | TH  | LT  | RT            | TH  | LT  |       |
| Existing Conditions             | 46             | 1980 | 138 | 70            | 18  | 14 | 11             | 402 | 56  | 407           | 139 | 151 | 3432  |
| <b>Approved Project Trips</b>   |                |      |     |               |     |    |                |     |     |               |     |     |       |
| San Jose ATI                    | 0              | 0    | 0   | 0             | 0   | 0  | 0              | 0   | 0   | 0             | 0   | 0   | 0     |
| Santa Clara ATI                 | 0              | 179  | 0   | 0             | 0   | 0  | 0              | 54  | 9   | 24            | 0   | 1   | 267   |
| Total Approved Trips            | 0              | 179  | 0   | 0             | 0   | 0  | 0              | 54  | 9   | 24            | 0   | 1   | 267   |
| Background Conditions           | 46             | 2159 | 138 | 70            | 18  | 14 | 11             | 456 | 65  | 431           | 139 | 152 | 3699  |
| <b>2015 Project Trips</b>       |                |      |     |               |     |    |                |     |     |               |     |     |       |
| BART                            | 0              | -9   | 0   | 0             | 0   | 0  | 0              | -6  | -1  | -1            | 0   | -1  | -18   |
| Joint Development               | 0              | 41   | 0   | 0             | 0   | 0  | 4              | 150 | 8   | 2             | 8   | 0   | 213   |
| Net 2015 Trips                  | 0              | 32   | 0   | 0             | 0   | 0  | 4              | 144 | 7   | 1             | 8   | -1  | 195   |
| Existing + Project              | 46             | 2012 | 138 | 70            | 18  | 14 | 15             | 546 | 63  | 408           | 147 | 150 | 3627  |
| <b>2025 Project Trips</b>       |                |      |     |               |     |    |                |     |     |               |     |     |       |
| BART                            | 0              | -24  | 0   | 0             | 0   | 0  | 0              | -15 | -2  | -2            | 0   | -3  | -46   |
| Joint Development               | 0              | 39   | 0   | 5             | 21  | 0  | 6              | 135 | 9   | 2             | 20  | 0   | 237   |
| Net 2025 Trips                  | 0              | 15   | 0   | 5             | 21  | 0  | 6              | 120 | 7   | 0             | 20  | -3  | 191   |
| Background + Project            | 46             | 2174 | 138 | 75            | 39  | 14 | 17             | 576 | 72  | 431           | 159 | 149 | 3890  |
| Cumulative No Project           | 50             | 2159 | 138 | 75            | 83  | 14 | 17             | 880 | 136 | 431           | 160 | 152 | 4143  |
| <b>Cumulative Project Trips</b> |                |      |     |               |     |    |                |     |     |               |     |     |       |
| BART                            | 0              | -21  | 0   | 0             | 0   | 0  | 0              | -14 | -4  | -2            | 0   | -1  | -42   |
| Joint Development               | 0              | 30   | 0   | 1             | 26  | 0  | 8              | 103 | 6   | 2             | 20  | 0   | 196   |
| Net 2035 Trips                  | 0              | 9    | 0   | 1             | 26  | 0  | 8              | 89  | 2   | 0             | 20  | -1  | 154   |
| Cumulative With Project         | 50             | 2168 | 138 | 76            | 109 | 14 | 25             | 969 | 138 | 431           | 180 | 151 | 4449  |

Intersection Number: **32**  
 Traffic Node Number: 175  
 Intersection Name: De La Cruz Blvd & Reed St  
 Peak Hour: PM  
 Count Date: 10/08/14  
 Scenario: BART Extension Phase II  
 Date of Analysis: 09/02/15

| Scenario:                       | Movements      |      |    |               |    |    |                |      |     |               |    |    | Total |
|---------------------------------|----------------|------|----|---------------|----|----|----------------|------|-----|---------------|----|----|-------|
|                                 | North Approach |      |    | East Approach |    |    | South Approach |      |     | West Approach |    |    |       |
|                                 | RT             | TH   | LT | RT            | TH | LT | RT             | TH   | LT  | RT            | TH | LT |       |
| Existing Conditions             | 33             | 2440 | 26 | 17            | 5  | 78 | 10             | 398  | 54  | 231           | 10 | 15 | 3317  |
| <b>Approved Project Trips</b>   |                |      |    |               |    |    |                |      |     |               |    |    |       |
| San Jose ATI                    | 0              | 0    | 0  | 0             | 0  | 0  | 0              | 0    | 0   | 0             | 0  | 0  | 0     |
| Santa Clara ATI                 | 0              | 202  | 0  | 0             | 0  | 0  | 0              | 63   | 0   | 19            | 0  | 0  | 284   |
| Total Approved Trips            | 0              | 202  | 0  | 0             | 0  | 0  | 0              | 63   | 0   | 19            | 0  | 0  | 284   |
| Background Conditions           | 33             | 2642 | 26 | 17            | 5  | 78 | 10             | 461  | 54  | 250           | 10 | 15 | 3601  |
| <b>2015 Project Trips</b>       |                |      |    |               |    |    |                |      |     |               |    |    |       |
| BART                            | 0              | -11  | 0  | -1            | 0  | -2 | -1             | -7   | 0   | -1            | 0  | 0  | -23   |
| Joint Development               | 0              | 45   | 0  | 0             | 0  | 2  | 4              | 161  | 7   | 3             | 0  | 0  | 222   |
| Net 2015 Trips                  | 0              | 34   | 0  | -1            | 0  | 0  | 3              | 154  | 7   | 2             | 0  | 0  | 199   |
| Existing + Project              | 33             | 2474 | 26 | 16            | 5  | 78 | 13             | 552  | 61  | 233           | 10 | 15 | 3516  |
| <b>2025 Project Trips</b>       |                |      |    |               |    |    |                |      |     |               |    |    |       |
| BART                            | 0              | -25  | 0  | -1            | 0  | -5 | -1             | -15  | 0   | -2            | 0  | 0  | -49   |
| Joint Development               | 0              | 42   | 0  | 0             | 0  | 1  | 3              | 150  | 11  | 2             | 0  | 0  | 209   |
| Net 2025 Trips                  | 0              | 17   | 0  | -1            | 0  | -4 | 2              | 135  | 11  | 0             | 0  | 0  | 160   |
| Background + Project            | 33             | 2659 | 26 | 16            | 5  | 74 | 12             | 596  | 65  | 250           | 10 | 15 | 3761  |
| Cumulative No Project           | 33             | 2642 | 26 | 24            | 29 | 78 | 10             | 944  | 91  | 250           | 14 | 24 | 4141  |
| <b>Cumulative Project Trips</b> |                |      |    |               |    |    |                |      |     |               |    |    |       |
| BART                            | -1             | -20  | 0  | -1            | 0  | -3 | -1             | -17  | 4   | -1            | 0  | 0  | -40   |
| Joint Development               | 0              | 35   | 0  | 0             | 0  | 1  | 3              | 121  | 10  | 3             | 0  | 0  | 173   |
| Net 2035 Trips                  | -1             | 15   | 0  | -1            | 0  | -2 | 2              | 104  | 14  | 2             | 0  | 0  | 133   |
| Cumulative With Project         | 32             | 2657 | 26 | 23            | 29 | 76 | 12             | 1048 | 105 | 252           | 14 | 24 | 4298  |

|                                 |                         |      |    |               |    |     |                |      |     |               |    |     |       |
|---------------------------------|-------------------------|------|----|---------------|----|-----|----------------|------|-----|---------------|----|-----|-------|
| Intersection Number:            | 33                      |      |    |               |    |     |                |      |     |               |    |     |       |
| Traffic Node Number:            | 9                       |      |    |               |    |     |                |      |     |               |    |     |       |
| Intersection Name:              | Coleman Ave & Brokaw Rd |      |    |               |    |     |                |      |     |               |    |     |       |
| Peak Hour:                      | PM                      |      |    |               |    |     |                |      |     |               |    |     |       |
| Count Date:                     | 10/08/14                |      |    |               |    |     |                |      |     |               |    |     |       |
| Scenario:                       | BART Extension Phase II |      |    |               |    |     |                |      |     |               |    |     |       |
|                                 | Movements               |      |    |               |    |     |                |      |     |               |    |     |       |
|                                 | North Approach          |      |    | East Approach |    |     | South Approach |      |     | West Approach |    |     |       |
| Scenario:                       | RT                      | TH   | LT | RT            | TH | LT  | RT             | TH   | LT  | RT            | TH | LT  | Total |
| Existing Conditions             | 55                      | 1875 | 7  | 23            | 28 | 362 | 44             | 555  | 197 | 305           | 7  | 203 | 3661  |
| <b>Approved Project Trips</b>   |                         |      |    |               |    |     |                |      |     |               |    |     |       |
| San Jose ATI                    | 0                       | 352  | 0  | 0             | 0  | 0   | 0              | 704  | 0   | 0             | 0  | 0   | 1056  |
| Santa Clara ATI                 | 0                       | 190  | 0  | 0             | 0  | 0   | 0              | 54   | 0   | 0             | 0  | 0   | 244   |
| Total Approved Trips            | 0                       | 542  | 0  | 0             | 0  | 0   | 0              | 758  | 0   | 0             | 0  | 0   | 1300  |
| Background Conditions           | 55                      | 2417 | 7  | 23            | 28 | 362 | 44             | 1313 | 197 | 305           | 7  | 203 | 4961  |
| <b>2015 Project Trips</b>       |                         |      |    |               |    |     |                |      |     |               |    |     |       |
| BART                            | 3                       | -17  | 0  | 0             | 0  | 0   | 0              | -17  | -1  | 0             | 0  | 27  | -5    |
| Joint Development               | 96                      | 3    | 0  | 0             | 14 | 0   | 0              | 8    | 98  | 162           | 2  | 389 | 772   |
| Net 2015 Trips                  | 99                      | -14  | 0  | 0             | 14 | 0   | 0              | -9   | 97  | 162           | 2  | 416 | 767   |
| Existing + Project              | 154                     | 1861 | 7  | 23            | 42 | 362 | 44             | 546  | 294 | 467           | 9  | 619 | 4428  |
| <b>2025 Project Trips</b>       |                         |      |    |               |    |     |                |      |     |               |    |     |       |
| BART                            | 5                       | -30  | 0  | 0             | 0  | 0   | 0              | -23  | 1   | 5             | 0  | 40  | -2    |
| Joint Development               | 91                      | 2    | 0  | 0             | 29 | 0   | 0              | 8    | 86  | 154           | 30 | 368 | 768   |
| Net 2025 Trips                  | 96                      | -28  | 0  | 0             | 29 | 0   | 0              | -15  | 87  | 159           | 30 | 408 | 766   |
| Background + Project            | 151                     | 2389 | 7  | 23            | 57 | 362 | 44             | 1298 | 284 | 464           | 37 | 611 | 5727  |
| Cumulative No Project           | 61                      | 2417 | 7  | 38            | 35 | 376 | 108            | 1313 | 201 | 305           | 16 | 242 | 4877  |
| <b>Cumulative Project Trips</b> |                         |      |    |               |    |     |                |      |     |               |    |     |       |
| BART                            | 9                       | -25  | 0  | 0             | 0  | 0   | 0              | -27  | 4   | 13            | 0  | 77  | 51    |
| Joint Development               | 83                      | 2    | 0  | 0             | 31 | 0   | 0              | 9    | 73  | 124           | 31 | 309 | 662   |
| Net 2035 Trips                  | 92                      | -23  | 0  | 0             | 31 | 0   | 0              | -18  | 77  | 137           | 31 | 386 | 713   |
| Cumulative With Project         | 153                     | 2394 | 7  | 38            | 66 | 376 | 108            | 1295 | 278 | 442           | 47 | 628 | 5832  |

|                                 |                            |      |    |               |    |    |                |      |     |               |    |     |       |
|---------------------------------|----------------------------|------|----|---------------|----|----|----------------|------|-----|---------------|----|-----|-------|
| Intersection Number:            | 34                         |      |    |               |    |    |                |      |     |               |    |     |       |
| Traffic Node Number:            | 3411                       |      |    |               |    |    |                |      |     |               |    |     |       |
| Intersection Name:              | Coleman Ave & Aviation Ave |      |    |               |    |    |                |      |     |               |    |     |       |
| Peak Hour:                      | PM                         |      |    |               |    |    |                |      |     |               |    |     |       |
| Count Date:                     | 10/08/14                   |      |    |               |    |    |                |      |     |               |    |     |       |
| Scenario:                       | BART Extension Phase II    |      |    |               |    |    |                |      |     |               |    |     |       |
|                                 | Movements                  |      |    |               |    |    |                |      |     |               |    |     |       |
|                                 | North Approach             |      |    | East Approach |    |    | South Approach |      |     | West Approach |    |     |       |
| Scenario:                       | RT                         | TH   | LT | RT            | TH | LT | RT             | TH   | LT  | RT            | TH | LT  | Total |
| Existing Conditions             | 0                          | 2721 | 5  | 7             | 0  | 45 | 26             | 795  | 16  | 10            | 0  | 1   | 3626  |
| <b>Approved Project Trips</b>   |                            |      |    |               |    |    |                |      |     |               |    |     |       |
| San Jose ATI                    | 48                         | 296  | 8  | 8             | 0  | 0  | 1              | 519  | 95  | 152           | 12 | 177 | 1316  |
| Santa Clara ATI                 | 0                          | 190  | 0  | 0             | 0  | 0  | 0              | 54   | 0   | 0             | 0  | 0   | 244   |
| Total Approved Trips            | 48                         | 486  | 8  | 8             | 0  | 0  | 1              | 573  | 95  | 152           | 12 | 177 | 1560  |
| Background Conditions           | 48                         | 3207 | 13 | 15            | 0  | 45 | 27             | 1368 | 111 | 162           | 12 | 178 | 5186  |
| <b>2015 Project Trips</b>       |                            |      |    |               |    |    |                |      |     |               |    |     |       |
| BART                            | 0                          | -17  | 0  | 0             | 0  | 0  | 0              | -18  | 0   | 0             | 0  | 0   | -35   |
| Joint Development               | 0                          | 165  | 0  | 0             | 0  | 0  | 0              | 106  | 0   | 0             | 0  | 0   | 271   |
| Net 2015 Trips                  | 0                          | 148  | 0  | 0             | 0  | 0  | 0              | 88   | 0   | 0             | 0  | 0   | 236   |
| Existing + Project              | 0                          | 2869 | 5  | 7             | 0  | 45 | 26             | 883  | 16  | 10            | 0  | 1   | 3862  |
| <b>2025 Project Trips</b>       |                            |      |    |               |    |    |                |      |     |               |    |     |       |
| BART                            | 0                          | -26  | 0  | 0             | 0  | 0  | 0              | -22  | 0   | 0             | 0  | 0   | -48   |
| Joint Development               | 0                          | 156  | 0  | 0             | 0  | 0  | 0              | 94   | 0   | 0             | 0  | 0   | 250   |
| Net 2025 Trips                  | 0                          | 130  | 0  | 0             | 0  | 0  | 0              | 72   | 0   | 0             | 0  | 0   | 202   |
| Background + Project            | 48                         | 3337 | 13 | 15            | 0  | 45 | 27             | 1440 | 111 | 162           | 12 | 178 | 5388  |
| Cumulative No Project           | 48                         | 3207 | 13 | 15            | 0  | 45 | 27             | 1377 | 111 | 162           | 12 | 178 | 5017  |
| <b>Cumulative Project Trips</b> |                            |      |    |               |    |    |                |      |     |               |    |     |       |
| BART                            | 0                          | -13  | 0  | 0             | 0  | 0  | 0              | -24  | 0   | 0             | 0  | 0   | -37   |
| Joint Development               | 0                          | 126  | 0  | 0             | 0  | 0  | 0              | 82   | 0   | 0             | 0  | 0   | 208   |
| Net 2035 Trips                  | 0                          | 113  | 0  | 0             | 0  | 0  | 0              | 58   | 0   | 0             | 0  | 0   | 171   |
| Cumulative With Project         | 48                         | 3320 | 13 | 15            | 0  | 45 | 27             | 1435 | 111 | 162           | 12 | 178 | 5366  |

|                                 |                          |      |    |               |    |    |                |      |     |               |    |     |       |
|---------------------------------|--------------------------|------|----|---------------|----|----|----------------|------|-----|---------------|----|-----|-------|
| Intersection Number:            | 35                       |      |    |               |    |    |                |      |     |               |    |     |       |
| Traffic Node Number:            | 4047                     |      |    |               |    |    |                |      |     |               |    |     |       |
| Intersection Name:              | Coleman Ave & Newhall Dr |      |    |               |    |    |                |      |     |               |    |     |       |
| Peak Hour:                      | PM                       |      |    |               |    |    |                |      |     |               |    |     |       |
| Count Date:                     | 10/08/14                 |      |    |               |    |    |                |      |     |               |    |     |       |
| Scenario:                       | BART Extension Phase II  |      |    |               |    |    |                |      |     |               |    |     |       |
|                                 | Movements                |      |    |               |    |    |                |      |     |               |    |     |       |
|                                 | North Approach           |      |    | East Approach |    |    | South Approach |      |     | West Approach |    |     |       |
| Scenario:                       | RT                       | TH   | LT | RT            | TH | LT | RT             | TH   | LT  | RT            | TH | LT  | Total |
| Existing Conditions             | 182                      | 2578 | 0  | 0             | 0  | 0  | 0              | 729  | 335 | 362           | 0  | 73  | 4259  |
| <b>Approved Project Trips</b>   |                          |      |    |               |    |    |                |      |     |               |    |     |       |
| San Jose ATI                    | 43                       | 822  | 0  | 0             | 0  | 0  | 0              | 351  | 64  | 42            | 0  | 0   | 1322  |
| Santa Clara ATI                 | 0                        | 190  | 0  | 0             | 0  | 0  | 0              | 54   | 0   | 0             | 0  | 0   | 244   |
| Total Approved Trips            | 43                       | 1012 | 0  | 0             | 0  | 0  | 0              | 405  | 64  | 42            | 0  | 0   | 1566  |
| Background Conditions           | 225                      | 3590 | 0  | 0             | 0  | 0  | 0              | 1134 | 399 | 404           | 0  | 73  | 5825  |
| <b>2015 Project Trips</b>       |                          |      |    |               |    |    |                |      |     |               |    |     |       |
| BART                            | 0                        | -17  | 0  | 0             | 0  | 0  | 0              | -18  | -1  | -1            | 0  | 0   | -37   |
| Joint Development               | 0                        | 163  | 0  | 0             | 0  | 0  | 0              | 103  | 0   | 0             | 0  | 0   | 266   |
| Net 2015 Trips                  | 0                        | 146  | 0  | 0             | 0  | 0  | 0              | 85   | -1  | -1            | 0  | 0   | 229   |
| Existing + Project              | 182                      | 2724 | 0  | 0             | 0  | 0  | 0              | 814  | 334 | 361           | 0  | 73  | 4488  |
| <b>2025 Project Trips</b>       |                          |      |    |               |    |    |                |      |     |               |    |     |       |
| BART                            | 0                        | -29  | 0  | 0             | 0  | 0  | 0              | -22  | -5  | -12           | 0  | 0   | -68   |
| Joint Development               | 0                        | 150  | 0  | 0             | 0  | 0  | 0              | 86   | 3   | 0             | 0  | 0   | 239   |
| Net 2025 Trips                  | 0                        | 121  | 0  | 0             | 0  | 0  | 0              | 64   | -2  | -12           | 0  | 0   | 171   |
| Background + Project            | 225                      | 3711 | 0  | 0             | 0  | 0  | 0              | 1198 | 397 | 392           | 0  | 73  | 5996  |
| Cumulative No Project           | 225                      | 3590 | 0  | 0             | 0  | 0  | 0              | 1134 | 399 | 404           | 0  | 162 | 5752  |
|                                 | 246                      | 3235 | 0  | 0             | 0  | 0  | 0              | 1094 | 510 | 686           | 0  | 232 |       |
| <b>Cumulative Project Trips</b> |                          |      |    |               |    |    |                |      |     |               |    |     |       |
| BART                            | 0                        | -23  | 0  | 0             | 0  | 0  | 0              | -26  | -11 | -13           | 0  | 0   | -73   |
| Joint Development               | 0                        | 119  | 0  | 0             | 0  | 0  | 0              | 72   | 4   | 0             | 0  | 1   | 196   |
| Net 2035 Trips                  | 0                        | 96   | 0  | 0             | 0  | 0  | 0              | 46   | -7  | -13           | 0  | 1   | 123   |
| Cumulative With Project         | 225                      | 3686 | 0  | 0             | 0  | 0  | 0              | 1180 | 392 | 391           | 0  | 163 | 6037  |

|                                 |                              |      |    |               |    |     |                |      |    |               |    |    |       |
|---------------------------------|------------------------------|------|----|---------------|----|-----|----------------|------|----|---------------|----|----|-------|
| Intersection Number:            | 36                           |      |    |               |    |     |                |      |    |               |    |    |       |
| Traffic Node Number:            | 3052                         |      |    |               |    |     |                |      |    |               |    |    |       |
| Intersection Name:              | Coleman Ave & I-880 SB Ramps |      |    |               |    |     |                |      |    |               |    |    |       |
| Peak Hour:                      | PM                           |      |    |               |    |     |                |      |    |               |    |    |       |
| Count Date:                     | 09/25/14                     |      |    |               |    |     |                |      |    |               |    |    |       |
| Scenario:                       | BART Extension Phase II      |      |    |               |    |     |                |      |    |               |    |    |       |
|                                 | Movements                    |      |    |               |    |     |                |      |    |               |    |    |       |
|                                 | North Approach               |      |    | East Approach |    |     | South Approach |      |    | West Approach |    |    |       |
| Scenario:                       | RT                           | TH   | LT | RT            | TH | LT  | RT             | TH   | LT | RT            | TH | LT | Total |
| Existing Conditions             | 709                          | 2074 | 0  | 207           | 0  | 201 | 291            | 1033 | 0  | 0             | 0  | 0  | 4515  |
| <b>Approved Project Trips</b>   |                              |      |    |               |    |     |                |      |    |               |    |    |       |
| San Jose ATI                    | 0                            | 1008 | 5  | 145           | 4  | 39  | 10             | 384  | 0  | 0             | 0  | 0  | 1595  |
| Santa Clara ATI                 | 64                           | 126  | 0  | 18            | 0  | 0   | 0              | 36   | 0  | 0             | 0  | 0  | 244   |
| Total Approved Trips            | 64                           | 1134 | 5  | 163           | 4  | 39  | 10             | 420  | 0  | 0             | 0  | 0  | 1839  |
| Background Conditions           | 773                          | 3208 | 5  | 370           | 4  | 240 | 301            | 1453 | 0  | 0             | 0  | 0  | 6354  |
| <b>2015 Project Trips</b>       |                              |      |    |               |    |     |                |      |    |               |    |    |       |
| BART                            | 0                            | -22  | 0  | -5            | 0  | -6  | 0              | -17  | 0  | 0             | 0  | 0  | -50   |
| Joint Development               | 0                            | 128  | 0  | 33            | 0  | 0   | 0              | 68   | 0  | 0             | 0  | 0  | 229   |
| Net 2015 Trips                  | 0                            | 106  | 0  | 28            | 0  | -6  | 0              | 51   | 0  | 0             | 0  | 0  | 179   |
| Existing + Project              | 709                          | 2180 | 0  | 235           | 0  | 195 | 291            | 1084 | 0  | 0             | 0  | 0  | 4694  |
| <b>2025 Project Trips</b>       |                              |      |    |               |    |     |                |      |    |               |    |    |       |
| BART                            | 0                            | -39  | 0  | -6            | 0  | -11 | 0              | -24  | 0  | 0             | 0  | 0  | -80   |
| Joint Development               | 0                            | 128  | 0  | 25            | 0  | 0   | 0              | 61   | 0  | 0             | 0  | 0  | 214   |
| Net 2025 Trips                  | 0                            | 89   | 0  | 19            | 0  | -11 | 0              | 37   | 0  | 0             | 0  | 0  | 134   |
| Background + Project            | 773                          | 3297 | 5  | 389           | 4  | 229 | 301            | 1490 | 0  | 0             | 0  | 0  | 6488  |
| Cumulative No Project           | 773                          | 3208 | 5  | 428           | 4  | 351 | 301            | 1533 | 0  | 0             | 0  | 0  | 6603  |
|                                 | 773                          | 3266 | 5  | 443           | 4  | 337 | 301            | 1551 | 0  | 0             | 0  | 0  | 6680  |
| <b>Cumulative Project Trips</b> |                              |      |    |               |    |     |                |      |    |               |    |    |       |
| BART                            | 0                            | -39  | 0  | -9            | 0  | -14 | 0              | -31  | 0  | 0             | 0  | 0  | -93   |
| Joint Development               | 0                            | 97   | 0  | 24            | 0  | 0   | 0              | 49   | 0  | 0             | 0  | 0  | 170   |
| Net 2035 Trips                  | 0                            | 58   | 0  | 15            | 0  | -14 | 0              | 18   | 0  | 0             | 0  | 0  | 77    |
| Cumulative With Project         | 773                          | 3266 | 5  | 443           | 4  | 337 | 301            | 1551 | 0  | 0             | 0  | 0  | 6680  |

Intersection Number: **37**  
 Traffic Node Number: 3053  
 Intersection Name: Coleman Ave & I-880 NB Ramps  
 Peak Hour: PM  
 Count Date: 09/25/14  
 Scenario: BART Extension Phase II  
 Date of Analysis: 09/02/15

| Scenario:                       | Movements      |      |      |               |    |     |                |      |    |               |    |    | Total |
|---------------------------------|----------------|------|------|---------------|----|-----|----------------|------|----|---------------|----|----|-------|
|                                 | North Approach |      |      | East Approach |    |     | South Approach |      |    | West Approach |    |    |       |
|                                 | RT             | TH   | LT   | RT            | TH | LT  | RT             | TH   | LT | RT            | TH | LT |       |
| Existing Conditions             | 13             | 1713 | 644  | 443           | 0  | 208 | 419            | 832  | 0  | 10            | 0  | 0  | 4282  |
| <b>Approved Project Trips</b>   |                |      |      |               |    |     |                |      |    |               |    |    |       |
| San Jose ATI                    | 0              | 681  | 347  | 154           | 0  | 7   | 6              | 294  | 0  | 0             | 0  | 0  | 1489  |
| Santa Clara ATI                 | 0              | 63   | 63   | 18            | 0  | 0   | 0              | 18   | 0  | 0             | 0  | 0  | 162   |
| Total Approved Trips            | 0              | 744  | 410  | 172           | 0  | 7   | 6              | 312  | 0  | 0             | 0  | 0  | 1651  |
| Background Conditions           | 13             | 2457 | 1054 | 615           | 0  | 215 | 425            | 1144 | 0  | 10            | 0  | 0  | 5933  |
| <b>2015 Project Trips</b>       |                |      |      |               |    |     |                |      |    |               |    |    |       |
| BART                            | 0              | -24  | -4   | 0             | 0  | -6  | -7             | -9   | 0  | 0             | 0  | 0  | -50   |
| Joint Development               | 0              | 99   | 29   | 23            | 0  | 0   | 0              | 51   | 0  | 0             | 0  | 0  | 202   |
| Net 2015 Trips                  | 0              | 75   | 25   | 23            | 0  | -6  | -7             | 42   | 0  | 0             | 0  | 0  | 152   |
| Existing + Project              | 13             | 1788 | 669  | 466           | 0  | 202 | 412            | 874  | 0  | 10            | 0  | 0  | 4434  |
| <b>2025 Project Trips</b>       |                |      |      |               |    |     |                |      |    |               |    |    |       |
| BART                            | 0              | -39  | -10  | -1            | 0  | -6  | -18            | -48  | 0  | 0             | 0  | 0  | -122  |
| Joint Development               | 0              | 99   | 30   | 13            | 0  | 0   | 0              | 51   | 0  | 0             | 0  | 0  | 193   |
| Net 2025 Trips                  | 0              | 60   | 20   | 12            | 0  | -6  | -18            | 3    | 0  | 0             | 0  | 0  | 71    |
| Background + Project            | 13             | 2517 | 1074 | 627           | 0  | 209 | 407            | 1147 | 0  | 10            | 0  | 0  | 6004  |
| Cumulative No Project           | 13             | 2457 | 1054 | 615           | 0  | 215 | 496            | 1556 | 0  | 10            | 0  | 0  | 6416  |
| <b>Cumulative Project Trips</b> |                |      |      |               |    |     |                |      |    |               |    |    |       |
| BART                            | 0              | -44  | -8   | 0             | 0  | -6  | -21            | -51  | 0  | 0             | 0  | 0  | -130  |
| Joint Development               | 0              | 82   | 15   | 10            | 0  | 0   | 0              | 43   | 0  | 0             | 0  | 0  | 150   |
| Net 2035 Trips                  | 0              | 38   | 7    | 10            | 0  | -6  | -21            | -8   | 0  | 0             | 0  | 0  | 20    |
| Cumulative With Project         | 13             | 2495 | 1061 | 625           | 0  | 209 | 475            | 1548 | 0  | 10            | 0  | 0  | 6436  |

Intersection Number: **38**  
 Traffic Node Number: 3413  
 Intersection Name: Coleman Ave & W. Hedding St  
 Peak Hour: PM  
 Count Date: 05/12/15  
 Scenario: BART Extension Phase II  
 Date of Analysis: 09/02/15

| Scenario:                       | Movements      |      |     |               |     |     |                |      |     |               |      |     | Total |
|---------------------------------|----------------|------|-----|---------------|-----|-----|----------------|------|-----|---------------|------|-----|-------|
|                                 | North Approach |      |     | East Approach |     |     | South Approach |      |     | West Approach |      |     |       |
|                                 | RT             | TH   | LT  | RT            | TH  | LT  | RT             | TH   | LT  | RT            | TH   | LT  |       |
| Existing Conditions             | 288            | 1301 | 427 | 328           | 448 | 72  | 45             | 766  | 118 | 158           | 437  | 170 | 4558  |
| <b>Approved Project Trips</b>   |                |      |     |               |     |     |                |      |     |               |      |     |       |
| San Jose ATI                    | 86             | 552  | 98  | 28            | 51  | 5   | 1              | 225  | 10  | 16            | 23   | 13  | 1108  |
| Santa Clara ATI                 | 0              | 63   | 0   | 0             | 0   | 0   | 0              | 18   | 0   | 0             | 0    | 0   | 81    |
| Total Approved Trips            | 86             | 615  | 98  | 28            | 51  | 5   | 1              | 243  | 10  | 16            | 23   | 13  | 1189  |
| Background Conditions           | 374            | 1916 | 525 | 356           | 499 | 77  | 46             | 1009 | 128 | 174           | 460  | 183 | 5747  |
| <b>2015 Project Trips</b>       |                |      |     |               |     |     |                |      |     |               |      |     |       |
| BART                            | -5             | -18  | -7  | 10            | 18  | 0   | 0              | -26  | 0   | 0             | 0    | -1  | -29   |
| Joint Development               | 9              | 66   | 23  | 10            | 0   | 0   | 0              | 34   | 0   | 0             | 0    | 7   | 149   |
| Net 2015 Trips                  | 4              | 48   | 16  | 20            | 18  | 0   | 0              | 8    | 0   | 0             | 0    | 6   | 120   |
| Existing + Project              | 292            | 1349 | 443 | 348           | 466 | 72  | 45             | 774  | 118 | 158           | 437  | 176 | 4678  |
| <b>2025 Project Trips</b>       |                |      |     |               |     |     |                |      |     |               |      |     |       |
| BART                            | -3             | -31  | -12 | -20           | -3  | -1  | -2             | -45  | 0   | -1            | -4   | -1  | -123  |
| Joint Development               | 8              | 71   | 18  | 10            | 0   | 0   | 0              | 33   | 0   | 0             | 1    | 7   | 148   |
| Net 2025 Trips                  | 5              | 40   | 6   | -10           | -3  | -1  | -2             | -12  | 0   | -1            | -3   | 6   | 25    |
| Background + Project            | 379            | 1956 | 531 | 346           | 496 | 76  | 44             | 997  | 128 | 173           | 457  | 189 | 5772  |
| Cumulative No Project           | 400            | 1916 | 525 | 479           | 577 | 116 | 120            | 1251 | 163 | 327           | 1271 | 331 | 7145  |
| <b>Cumulative Project Trips</b> |                |      |     |               |     |     |                |      |     |               |      |     |       |
| BART                            | -7             | -31  | -11 | -10           | -6  | 0   | -1             | -53  | 0   | 0             | -14  | -7  | -140  |
| Joint Development               | 16             | 38   | 25  | 10            | 0   | 0   | 0              | 27   | 0   | 4             | 2    | 7   | 129   |
| Net 2035 Trips                  | 9              | 7    | 14  | 0             | -6  | 0   | -1             | -26  | 0   | 4             | -12  | 0   | -11   |
| Cumulative With Project         | 409            | 1923 | 539 | 479           | 571 | 116 | 119            | 1225 | 163 | 331           | 1259 | 331 | 7465  |

Intersection Number: **39**  
 Traffic Node Number: 3417  
 Intersection Name: Coleman Ave & W. Taylor St  
 Peak Hour: PM  
 Count Date: 05/12/15  
 Scenario: BART Extension Phase II  
 Date of Analysis: 09/02/15

| Scenario:                       | Movements      |      |     |               |     |     |                |     |     |               |     |     | Total |
|---------------------------------|----------------|------|-----|---------------|-----|-----|----------------|-----|-----|---------------|-----|-----|-------|
|                                 | North Approach |      |     | East Approach |     |     | South Approach |     |     | West Approach |     |     |       |
|                                 | RT             | TH   | LT  | RT            | TH  | LT  | RT             | TH  | LT  | RT            | TH  | LT  |       |
| Existing Conditions             | 191            | 1026 | 355 | 215           | 548 | 306 | 54             | 455 | 261 | 324           | 563 | 176 | 4474  |
| <b>Approved Project Trips</b>   |                |      |     |               |     |     |                |     |     |               |     |     |       |
| San Jose ATI                    | 146            | 221  | 290 | 79            | 85  | 3   | 68             | 135 | 81  | 24            | 70  | 36  | 1238  |
| Santa Clara ATI                 | 0              | 63   | 0   | 0             | 0   | 0   | 0              | 18  | 0   | 0             | 0   | 0   | 81    |
| Total Approved Trips            | 146            | 284  | 290 | 79            | 85  | 3   | 68             | 153 | 81  | 24            | 70  | 36  | 1319  |
| Background Conditions           | 337            | 1310 | 645 | 294           | 633 | 309 | 122            | 608 | 342 | 348           | 633 | 212 | 5793  |
| <b>2015 Project Trips</b>       |                |      |     |               |     |     |                |     |     |               |     |     |       |
| BART                            | -1             | -14  | -1  | -2            | 3   | 0   | -1             | -22 | -2  | -5            | -1  | -2  | -48   |
| Joint Development               | 3              | 42   | 21  | 10            | 0   | 0   | 0              | 21  | 6   | 3             | 0   | 2   | 108   |
| Net 2015 Trips                  | 2              | 28   | 20  | 8             | 3   | 0   | -1             | -1  | 4   | -2            | -1  | 0   | 60    |
| Existing + Project              | 193            | 1054 | 375 | 223           | 551 | 306 | 53             | 454 | 265 | 322           | 562 | 176 | 4534  |
| <b>2025 Project Trips</b>       |                |      |     |               |     |     |                |     |     |               |     |     |       |
| BART                            | -4             | -25  | -3  | -5            | -2  | -1  | -2             | -38 | 2   | -8            | -7  | -4  | -97   |
| Joint Development               | 5              | 47   | 18  | 10            | 3   | 0   | 0              | 23  | 9   | 2             | 3   | 1   | 121   |
| Net 2025 Trips                  | 1              | 22   | 15  | 5             | 1   | -1  | -2             | -15 | 11  | -6            | -4  | -3  | 24    |
| Background + Project            | 338            | 1332 | 660 | 299           | 634 | 308 | 120            | 593 | 353 | 342           | 629 | 209 | 5817  |
| Cumulative No Project           | 337            | 1310 | 645 | 366           | 863 | 485 | 142            | 971 | 435 | 420           | 935 | 212 | 6909  |
| <b>Cumulative Project Trips</b> |                |      |     |               |     |     |                |     |     |               |     |     |       |
| BART                            | -1             | -28  | -3  | -6            | -3  | -1  | -2             | -47 | -1  | -10           | -11 | 0   | -113  |
| Joint Development               | 0              | 34   | 10  | 6             | 1   | 0   | 0              | 19  | 11  | 2             | 4   | 2   | 89    |
| Net 2035 Trips                  | -1             | 6    | 7   | 0             | -2  | -1  | -2             | -28 | 10  | -8            | -7  | 2   | -24   |
| Cumulative With Project         | 336            | 1316 | 652 | 366           | 861 | 484 | 140            | 943 | 445 | 412           | 928 | 214 | 7097  |

Intersection Number: **40**  
 Traffic Node Number: 4038  
 Intersection Name: SR 87 & W. Taylor St  
 Peak Hour: PM  
 Count Date: 05/12/15  
 Scenario: BART Extension Phase II  
 Date of Analysis: 09/02/15

| Scenario:                       | Movements      |    |     |               |     |     |                |    |     |               |     |     | Total |
|---------------------------------|----------------|----|-----|---------------|-----|-----|----------------|----|-----|---------------|-----|-----|-------|
|                                 | North Approach |    |     | East Approach |     |     | South Approach |    |     | West Approach |     |     |       |
|                                 | RT             | TH | LT  | RT            | TH  | LT  | RT             | TH | LT  | RT            | TH  | LT  |       |
| Existing Conditions             | 155            | 0  | 65  | 150           | 369 | 812 | 711            | 0  | 603 | 637           | 468 | 113 | 4083  |
| <b>Approved Project Trips</b>   |                |    |     |               |     |     |                |    |     |               |     |     |       |
| San Jose ATI                    | 0              | 0  | 69  | 36            | 27  | 69  | 119            | 0  | 16  | 118           | 90  | 0   | 544   |
| Santa Clara ATI                 | 0              | 0  | 0   | 0             | 0   | 0   | 0              | 0  | 0   | 0             | 0   | 0   | 0     |
| Total Approved Trips            | 0              | 0  | 69  | 36            | 27  | 69  | 119            | 0  | 16  | 118           | 90  | 0   | 544   |
| Background Conditions           | 155            | 0  | 134 | 186           | 396 | 881 | 830            | 0  | 619 | 755           | 558 | 113 | 4627  |
| <b>2015 Project Trips</b>       |                |    |     |               |     |     |                |    |     |               |     |     |       |
| BART                            | -1             | 0  | -1  | -2            | 3   | -6  | -31            | 0  | -2  | -1            | -2  | -2  | -45   |
| Joint Development               | 0              | 0  | 5   | 1             | 0   | 0   | 0              | 0  | 10  | 18            | 3   | 0   | 37    |
| Net 2015 Trips                  | -1             | 0  | 4   | -1            | 3   | -6  | -31            | 0  | 8   | 17            | 1   | -2  | -8    |
| Existing + Project              | 154            | 0  | 69  | 149           | 372 | 806 | 680            | 0  | 611 | 654           | 469 | 111 | 4075  |
| <b>2025 Project Trips</b>       |                |    |     |               |     |     |                |    |     |               |     |     |       |
| BART                            | -4             | 0  | -6  | -7            | 0   | -21 | -41            | 0  | -3  | -5            | -3  | -7  | -97   |
| Joint Development               | 0              | 0  | 4   | 2             | 5   | 0   | 0              | 0  | 8   | 16            | 6   | 0   | 41    |
| Net 2025 Trips                  | -4             | 0  | -2  | -5            | 5   | -21 | -41            | 0  | 5   | 11            | 3   | -7  | -56   |
| Background + Project            | 151            | 0  | 132 | 181           | 401 | 860 | 789            | 0  | 624 | 766           | 561 | 106 | 4571  |
| Cumulative No Project           | 520            | 0  | 411 | 263           | 454 | 881 | 830            | 0  | 800 | 807           | 558 | 311 | 5524  |
| <b>Cumulative Project Trips</b> |                |    |     |               |     |     |                |    |     |               |     |     |       |
| BART                            | -3             | 0  | -4  | -5            | 0   | -16 | -37            | 0  | -5  | -2            | -5  | -9  | -86   |
| Joint Development               | 0              | 0  | 3   | 2             | 1   | 0   | 0              | 0  | 6   | 7             | 6   | 0   | 25    |
| Net 2035 Trips                  | -3             | 0  | -1  | -3            | 1   | -16 | -37            | 0  | 1   | 5             | 1   | -9  | -61   |
| Cumulative With Project         | 517            | 0  | 410 | 260           | 455 | 865 | 793            | 0  | 801 | 812           | 559 | 302 | 5774  |

Intersection Number: 41  
 Traffic Node Number: 5416  
 Intersection Name: San Tomas Expy & El Camino Real  
 Peak Hour: PM  
 Count Date: 09/23/14  
 Scenario: BART Extension Phase II  
 Date of Analysis: 09/02/15

| Scenario:                       | Movements      |      |     |               |     |     |                |      |     |               |      |     | Total |
|---------------------------------|----------------|------|-----|---------------|-----|-----|----------------|------|-----|---------------|------|-----|-------|
|                                 | North Approach |      |     | East Approach |     |     | South Approach |      |     | West Approach |      |     |       |
|                                 | RT             | TH   | LT  | RT            | TH  | LT  | RT             | TH   | LT  | RT            | TH   | LT  |       |
| Existing Conditions             | 491            | 2771 | 209 | 155           | 682 | 139 | 187            | 1054 | 171 | 312           | 1010 | 283 | 7464  |
| <b>Approved Project Trips</b>   |                |      |     |               |     |     |                |      |     |               |      |     |       |
| San Jose ATI                    | 0              | 0    | 0   | 0             | 0   | 0   | 0              | 0    | 0   | 0             | 0    | 0   | 0     |
| Santa Clara ATI                 | 162            | 938  | 46  | 12            | 57  | 2   | 2              | 219  | 40  | 24            | 37   | 94  | 1633  |
| Total Approved Trips            | 162            | 938  | 46  | 12            | 57  | 2   | 2              | 219  | 40  | 24            | 37   | 94  | 1633  |
| Background Conditions           | 653            | 3709 | 255 | 167           | 739 | 141 | 189            | 1273 | 211 | 336           | 1047 | 377 | 9097  |
| <b>2015 Project Trips</b>       |                |      |     |               |     |     |                |      |     |               |      |     |       |
| BART                            | 2              | -6   | 0   | 0             | -2  | 0   | 0              | 0    | 0   | 0             | -2   | 1   | -7    |
| Joint Development               | 0              | 0    | 0   | 0             | 26  | 13  | 9              | 0    | 0   | 0             | 6    | 0   | 54    |
| Net 2015 Trips                  | 2              | -6   | 0   | 0             | 24  | 13  | 9              | 0    | 0   | 0             | 4    | 1   | 47    |
| Existing + Project              | 493            | 2765 | 209 | 155           | 706 | 152 | 196            | 1054 | 171 | 312           | 1014 | 284 | 7511  |
| <b>2025 Project Trips</b>       |                |      |     |               |     |     |                |      |     |               |      |     |       |
| BART                            | -3             | -41  | 0   | 0             | -4  | 0   | 0              | -12  | 0   | 0             | -6   | -2  | -68   |
| Joint Development               | 0              | 0    | 0   | 0             | 28  | 13  | 3              | 0    | 0   | 0             | 7    | 0   | 51    |
| Net 2025 Trips                  | -3             | -41  | 0   | 0             | 24  | 13  | 3              | -12  | 0   | 0             | 1    | -2  | -17   |
| Background + Project            | 650            | 3668 | 255 | 167           | 763 | 154 | 192            | 1261 | 211 | 336           | 1048 | 375 | 9080  |
| Cumulative No Project           | 653            | 3709 | 340 | 169           | 897 | 196 | 189            | 1422 | 211 | 336           | 1253 | 389 | 9375  |
| <b>Cumulative Project Trips</b> |                |      |     |               |     |     |                |      |     |               |      |     |       |
| BART                            | -2             | -32  | 0   | 0             | -4  | 1   | 0              | -8   | 0   | 0             | -5   | -1  | -51   |
| Joint Development               | 1              | 0    | 0   | 0             | 21  | 12  | 2              | 0    | 0   | 0             | 6    | 0   | 42    |
| Net 2035 Trips                  | -1             | -32  | 0   | 0             | 17  | 13  | 2              | -8   | 0   | 0             | 1    | -1  | -9    |
| Cumulative With Project         | 652            | 3677 | 340 | 169           | 914 | 209 | 191            | 1414 | 211 | 336           | 1254 | 388 | 9755  |

Intersection Number: 42  
 Traffic Node Number: 1205  
 Intersection Name: Scott Blvd & El Camino Real  
 Peak Hour: PM  
 Count Date: 09/17/14  
 Scenario: BART Extension Phase II  
 Date of Analysis: 09/02/15

| Scenario:                       | Movements      |      |     |               |     |     |                |     |     |               |     |     | Total |
|---------------------------------|----------------|------|-----|---------------|-----|-----|----------------|-----|-----|---------------|-----|-----|-------|
|                                 | North Approach |      |     | East Approach |     |     | South Approach |     |     | West Approach |     |     |       |
|                                 | RT             | TH   | LT  | RT            | TH  | LT  | RT             | TH  | LT  | RT            | TH  | LT  |       |
| Existing Conditions             | 193            | 789  | 212 | 85            | 779 | 243 | 65             | 220 | 136 | 82            | 804 | 147 | 3755  |
| <b>Approved Project Trips</b>   |                |      |     |               |     |     |                |     |     |               |     |     |       |
| San Jose ATI                    | 0              | 0    | 0   | 0             | 0   | 0   | 0              | 0   | 0   | 0             | 0   | 0   | 0     |
| Santa Clara ATI                 | 2              | 142  | 5   | 6             | 62  | 0   | 0              | 39  | 7   | 40            | 44  | 1   | 348   |
| Total Approved Trips            | 2              | 142  | 5   | 6             | 62  | 0   | 0              | 39  | 7   | 40            | 44  | 1   | 348   |
| Background Conditions           | 195            | 931  | 217 | 91            | 841 | 243 | 65             | 259 | 143 | 122           | 848 | 148 | 4103  |
| <b>2015 Project Trips</b>       |                |      |     |               |     |     |                |     |     |               |     |     |       |
| BART                            | 0              | 0    | 0   | 0             | -2  | 2   | 1              | 0   | 0   | 0             | -1  | 0   | 0     |
| Joint Development               | 0              | 0    | 0   | 1             | 40  | 23  | 7              | 0   | 0   | 0             | 15  | 0   | 86    |
| Net 2015 Trips                  | 0              | 0    | 0   | 1             | 38  | 25  | 8              | 0   | 0   | 0             | 14  | 0   | 86    |
| Existing + Project              | 193            | 789  | 212 | 86            | 817 | 268 | 73             | 220 | 136 | 82            | 818 | 147 | 3841  |
| <b>2025 Project Trips</b>       |                |      |     |               |     |     |                |     |     |               |     |     |       |
| BART                            | 0              | -5   | 0   | 0             | -4  | 2   | 0              | -1  | 0   | 0             | -5  | 0   | -13   |
| Joint Development               | 1              | 2    | 0   | 1             | 42  | 17  | 12             | 0   | 0   | 0             | 10  | 0   | 85    |
| Net 2025 Trips                  | 1              | -3   | 0   | 1             | 38  | 19  | 12             | -1  | 0   | 0             | 5   | 0   | 72    |
| Background + Project            | 196            | 928  | 217 | 92            | 879 | 262 | 77             | 258 | 143 | 122           | 853 | 148 | 4175  |
| Cumulative No Project           | 220            | 1213 | 263 | 118           | 951 | 243 | 138            | 452 | 199 | 272           | 900 | 148 | 4969  |
| <b>Cumulative Project Trips</b> |                |      |     |               |     |     |                |     |     |               |     |     |       |
| BART                            | 0              | -1   | -1  | 0             | -2  | 5   | 2              | 0   | 0   | 0             | -5  | 0   | -2    |
| Joint Development               | 0              | 1    | 0   | 1             | 33  | 14  | 13             | 0   | 0   | 0             | 6   | 0   | 68    |
| Net 2035 Trips                  | 0              | 0    | -1  | 1             | 31  | 19  | 15             | 0   | 0   | 0             | 1   | 0   | 66    |
| Cumulative With Project         | 220            | 1213 | 262 | 119           | 982 | 262 | 153            | 452 | 199 | 272           | 901 | 148 | 5183  |



Intersection Number: **43**  
 Traffic Node Number: 1203  
 Intersection Name: Lincoln St & El Camino Real  
 Peak Hour: PM  
 Count Date: 09/17/14  
 Scenario: BART Extension Phase II  
 Date of Analysis: 09/02/15

| Scenario:                       | Movements      |     |    |               |     |     |                |    |    |               |      |    | Total |
|---------------------------------|----------------|-----|----|---------------|-----|-----|----------------|----|----|---------------|------|----|-------|
|                                 | North Approach |     |    | East Approach |     |     | South Approach |    |    | West Approach |      |    |       |
|                                 | RT             | TH  | LT | RT            | TH  | LT  | RT             | TH | LT | RT            | TH   | LT |       |
| Existing Conditions             | 59             | 66  | 74 | 48            | 846 | 101 | 60             | 31 | 48 | 87            | 982  | 47 | 2449  |
| <b>Approved Project Trips</b>   |                |     |    |               |     |     |                |    |    |               |      |    |       |
| San Jose ATI                    | 0              | 0   | 0  | 0             | 0   | 0   | 0              | 0  | 0  | 0             | 0    | 0  | 0     |
| Santa Clara ATI                 | 0              | 0   | 0  | 0             | 38  | 35  | 0              | 0  | 3  | 5             | 35   | 0  | 116   |
| Total Approved Trips            | 0              | 0   | 0  | 0             | 38  | 35  | 0              | 0  | 3  | 5             | 35   | 0  | 116   |
| Background Conditions           | 59             | 66  | 74 | 48            | 884 | 136 | 60             | 31 | 51 | 92            | 1017 | 47 | 2565  |
| <b>2015 Project Trips</b>       |                |     |    |               |     |     |                |    |    |               |      |    |       |
| BART                            | 0              | 0   | 0  | 1             | -1  | 0   | 0              | 0  | 0  | 0             | -2   | 0  | -2    |
| Joint Development               | 0              | 0   | 1  | 1             | 64  | 0   | 0              | 0  | 0  | 0             | 22   | 0  | 88    |
| Net 2015 Trips                  | 0              | 0   | 1  | 2             | 63  | 0   | 0              | 0  | 0  | 0             | 20   | 0  | 86    |
| Existing + Project              | 59             | 66  | 75 | 50            | 909 | 101 | 60             | 31 | 48 | 87            | 1002 | 47 | 2535  |
| <b>2025 Project Trips</b>       |                |     |    |               |     |     |                |    |    |               |      |    |       |
| BART                            | 0              | 0   | 0  | 1             | -1  | 0   | 0              | 0  | 0  | 0             | -6   | 0  | -6    |
| Joint Development               | 0              | 0   | 0  | 1             | 59  | 3   | 0              | 0  | 0  | 0             | 22   | 0  | 85    |
| Net 2025 Trips                  | 0              | 0   | 0  | 2             | 58  | 3   | 0              | 0  | 0  | 0             | 16   | 0  | 79    |
| Background + Project            | 59             | 66  | 74 | 50            | 942 | 139 | 60             | 31 | 51 | 92            | 1033 | 47 | 2644  |
| Cumulative No Project           | 59             | 124 | 80 | 49            | 929 | 136 | 63             | 43 | 73 | 139           | 1140 | 54 | 2835  |
| <b>Cumulative Project Trips</b> |                |     |    |               |     |     |                |    |    |               |      |    |       |
| BART                            | 0              | 0   | 1  | 0             | 0   | 0   | 1              | 0  | 0  | 0             | -3   | 0  | -1    |
| Joint Development               | 0              | 0   | 1  | 1             | 50  | 0   | 0              | 0  | 0  | 0             | 19   | 0  | 71    |
| Net 2035 Trips                  | 0              | 0   | 2  | 1             | 50  | 0   | 1              | 0  | 0  | 0             | 16   | 0  | 70    |
| Cumulative With Project         | 59             | 124 | 82 | 50            | 979 | 136 | 64             | 43 | 73 | 139           | 1156 | 54 | 2959  |

Intersection Number: **44**  
 Traffic Node Number: 1204  
 Intersection Name: Monroe St & El Camino Real  
 Peak Hour: PM  
 Count Date: 09/17/14  
 Scenario: BART Extension Phase II  
 Date of Analysis: 09/02/15

| Scenario:                       | Movements      |     |     |               |      |    |                |     |    |               |     |     | Total |
|---------------------------------|----------------|-----|-----|---------------|------|----|----------------|-----|----|---------------|-----|-----|-------|
|                                 | North Approach |     |     | East Approach |      |    | South Approach |     |    | West Approach |     |     |       |
|                                 | RT             | TH  | LT  | RT            | TH   | LT | RT             | TH  | LT | RT            | TH  | LT  |       |
| Existing Conditions             | 238            | 421 | 48  | 57            | 907  | 87 | 64             | 153 | 26 | 85            | 766 | 125 | 2977  |
| <b>Approved Project Trips</b>   |                |     |     |               |      |    |                |     |    |               |     |     |       |
| San Jose ATI                    | 0              | 0   | 0   | 0             | 0    | 0  | 0              | 0   | 0  | 0             | 0   | 0   | 0     |
| Santa Clara ATI                 | 0              | 28  | 46  | 7             | 64   | 4  | 0              | 6   | 1  | 2             | 41  | 0   | 199   |
| Total Approved Trips            | 0              | 28  | 46  | 7             | 64   | 4  | 0              | 6   | 1  | 2             | 41  | 0   | 199   |
| Background Conditions           | 238            | 449 | 94  | 64            | 971  | 91 | 64             | 159 | 27 | 87            | 807 | 125 | 3176  |
| <b>2015 Project Trips</b>       |                |     |     |               |      |    |                |     |    |               |     |     |       |
| BART                            | 0              | 0   | -3  | 2             | 1    | 0  | 0              | 0   | 0  | 0             | -1  | 0   | -1    |
| Joint Development               | 0              | 0   | 1   | 4             | 65   | 0  | 0              | 0   | 0  | 0             | 24  | 0   | 94    |
| Net 2015 Trips                  | 0              | 0   | -2  | 6             | 66   | 0  | 0              | 0   | 0  | 0             | 23  | 0   | 93    |
| Existing + Project              | 238            | 421 | 46  | 63            | 973  | 87 | 64             | 153 | 26 | 85            | 789 | 125 | 3070  |
| <b>2025 Project Trips</b>       |                |     |     |               |      |    |                |     |    |               |     |     |       |
| BART                            | 0              | 0   | -5  | 3             | -1   | 0  | 0              | 0   | 0  | 0             | -5  | 0   | -8    |
| Joint Development               | 0              | 0   | 1   | 4             | 63   | 0  | 0              | 0   | 0  | 0             | 24  | 0   | 92    |
| Net 2025 Trips                  | 0              | 0   | -4  | 7             | 62   | 0  | 0              | 0   | 0  | 0             | 19  | 0   | 84    |
| Background + Project            | 238            | 449 | 90  | 71            | 1033 | 91 | 64             | 159 | 27 | 87            | 826 | 125 | 3260  |
| Cumulative No Project           | 238            | 449 | 173 | 124           | 1039 | 91 | 70             | 159 | 27 | 93            | 899 | 144 | 3362  |
| <b>Cumulative Project Trips</b> |                |     |     |               |      |    |                |     |    |               |     |     |       |
| BART                            | 0              | 0   | -5  | 2             | 4    | 0  | 1              | 0   | 0  | 0             | -1  | 0   | 1     |
| Joint Development               | 0              | 0   | 1   | 5             | 51   | 0  | 0              | 0   | 0  | 0             | 20  | 0   | 77    |
| Net 2035 Trips                  | 0              | 0   | -4  | 7             | 55   | 0  | 1              | 0   | 0  | 0             | 19  | 0   | 78    |
| Cumulative With Project         | 238            | 449 | 169 | 131           | 1094 | 91 | 71             | 159 | 27 | 93            | 918 | 144 | 3584  |

|                                 |                         |      |    |               |    |    |                |     |    |               |    |    |       |
|---------------------------------|-------------------------|------|----|---------------|----|----|----------------|-----|----|---------------|----|----|-------|
| Intersection Number:            | 45                      |      |    |               |    |    |                |     |    |               |    |    |       |
| Traffic Node Number:            | 7                       |      |    |               |    |    |                |     |    |               |    |    |       |
| Intersection Name:              | Lafayette St & Reed St  |      |    |               |    |    |                |     |    |               |    |    |       |
| Peak Hour:                      | PM                      |      |    |               |    |    |                |     |    |               |    |    |       |
| Count Date:                     | 01/01/13                |      |    |               |    |    |                |     |    |               |    |    |       |
| Scenario:                       | BART Extension Phase II |      |    |               |    |    |                |     |    |               |    |    |       |
|                                 | Movements               |      |    |               |    |    |                |     |    |               |    |    |       |
|                                 | North Approach          |      |    | East Approach |    |    | South Approach |     |    | West Approach |    |    |       |
| Scenario:                       | RT                      | TH   | LT | RT            | TH | LT | RT             | TH  | LT | RT            | TH | LT | Total |
| Existing Conditions             | 9                       | 1631 | 53 | 22            | 3  | 53 | 50             | 443 | 0  | 6             | 4  | 6  | 2280  |
| <b>Approved Project Trips</b>   |                         |      |    |               |    |    |                |     |    |               |    |    |       |
| San Jose ATI                    | 0                       | 0    | 0  | 0             | 0  | 0  | 0              | 0   | 0  | 0             | 0  | 0  | 0     |
| Santa Clara ATI                 | 0                       | 200  | 19 | 0             | 0  | 0  | 0              | 50  | 0  | 0             | 0  | 0  | 269   |
| Total Approved Trips            | 0                       | 200  | 19 | 0             | 0  | 0  | 0              | 50  | 0  | 0             | 0  | 0  | 269   |
| Background Conditions           | 9                       | 1831 | 72 | 22            | 3  | 53 | 50             | 493 | 0  | 6             | 4  | 6  | 2549  |
| <b>2015 Project Trips</b>       |                         |      |    |               |    |    |                |     |    |               |    |    |       |
| BART                            | 0                       | -1   | -1 | 0             | 0  | 0  | 0              | 0   | 0  | 0             | 0  | 0  | -2    |
| Joint Development               | 0                       | 0    | 3  | 4             | 0  | 3  | 0              | 2   | 0  | 0             | 0  | 0  | 12    |
| Net 2015 Trips                  | 0                       | -1   | 2  | 4             | 0  | 3  | 0              | 2   | 0  | 0             | 0  | 0  | 10    |
| Existing + Project              | 9                       | 1630 | 55 | 26            | 3  | 56 | 50             | 445 | 0  | 6             | 4  | 6  | 2290  |
| <b>2025 Project Trips</b>       |                         |      |    |               |    |    |                |     |    |               |    |    |       |
| BART                            | 0                       | -10  | -2 | 0             | 0  | 1  | 0              | -1  | 0  | 0             | 0  | 0  | -12   |
| Joint Development               | 0                       | 15   | 2  | 3             | 0  | 6  | 0              | 5   | 0  | 0             | 0  | 0  | 31    |
| Net 2025 Trips                  | 0                       | 5    | 0  | 3             | 0  | 7  | 0              | 4   | 0  | 0             | 0  | 0  | 19    |
| Background + Project            | 9                       | 1836 | 72 | 25            | 3  | 60 | 50             | 497 | 0  | 6             | 4  | 6  | 2568  |
| Cumulative No Project           | 9                       | 1962 | 72 | 33            | 3  | 87 | 67             | 845 | 0  | 6             | 4  | 6  | 3088  |
| <b>Cumulative Project Trips</b> |                         |      |    |               |    |    |                |     |    |               |    |    |       |
| BART                            | 0                       | -5   | -1 | 0             | 0  | 2  | 0              | -1  | 0  | 0             | 0  | 0  | -5    |
| Joint Development               | 0                       | 15   | 3  | 4             | 0  | 5  | 0              | 6   | 0  | 0             | 0  | 0  | 33    |
| Net 2035 Trips                  | 0                       | 10   | 2  | 4             | 0  | 7  | 0              | 5   | 0  | 0             | 0  | 0  | 28    |
| Cumulative With Project         | 9                       | 1972 | 74 | 37            | 3  | 94 | 67             | 850 | 0  | 6             | 4  | 6  | 3122  |

|                                 |                               |      |     |               |     |    |                |     |     |               |      |     |       |
|---------------------------------|-------------------------------|------|-----|---------------|-----|----|----------------|-----|-----|---------------|------|-----|-------|
| Intersection Number:            | 46                            |      |     |               |     |    |                |     |     |               |      |     |       |
| Traffic Node Number:            | 1202                          |      |     |               |     |    |                |     |     |               |      |     |       |
| Intersection Name:              | Lafayette St & El Camino Real |      |     |               |     |    |                |     |     |               |      |     |       |
| Peak Hour:                      | PM                            |      |     |               |     |    |                |     |     |               |      |     |       |
| Count Date:                     | 09/17/14                      |      |     |               |     |    |                |     |     |               |      |     |       |
| Scenario:                       | BART Extension Phase II       |      |     |               |     |    |                |     |     |               |      |     |       |
|                                 | Movements                     |      |     |               |     |    |                |     |     |               |      |     |       |
|                                 | North Approach                |      |     | East Approach |     |    | South Approach |     |     | West Approach |      |     |       |
| Scenario:                       | RT                            | TH   | LT  | RT            | TH  | LT | RT             | TH  | LT  | RT            | TH   | LT  | Total |
| Existing Conditions             | 168                           | 947  | 285 | 37            | 640 | 50 | 194            | 255 | 152 | 195           | 870  | 232 | 4025  |
| <b>Approved Project Trips</b>   |                               |      |     |               |     |    |                |     |     |               |      |     |       |
| San Jose ATI                    | 0                             | 0    | 0   | 0             | 0   | 0  | 0              | 0   | 0   | 0             | 0    | 0   | 0     |
| Santa Clara ATI                 | 17                            | 152  | 31  | 0             | 65  | 0  | 0              | 31  | 6   | 21            | 50   | 18  | 391   |
| Total Approved Trips            | 17                            | 152  | 31  | 0             | 65  | 0  | 0              | 31  | 6   | 21            | 50   | 18  | 391   |
| Background Conditions           | 185                           | 1099 | 316 | 37            | 705 | 50 | 194            | 286 | 158 | 216           | 920  | 250 | 4416  |
| <b>2015 Project Trips</b>       |                               |      |     |               |     |    |                |     |     |               |      |     |       |
| BART                            | 0                             | -1   | 0   | 2             | 3   | 0  | 1              | 0   | 0   | -1            | -4   | 0   | 0     |
| Joint Development               | 3                             | 0    | 1   | 5             | 67  | 0  | 5              | 0   | 0   | 0             | 25   | 0   | 106   |
| Net 2015 Trips                  | 3                             | -1   | 1   | 7             | 70  | 0  | 6              | 0   | 0   | -1            | 21   | 0   | 106   |
| Existing + Project              | 171                           | 946  | 286 | 44            | 710 | 50 | 200            | 255 | 152 | 194           | 891  | 232 | 4131  |
| <b>2025 Project Trips</b>       |                               |      |     |               |     |    |                |     |     |               |      |     |       |
| BART                            | 0                             | -5   | -4  | 3             | 1   | 0  | 0              | -1  | 0   | -1            | -9   | 0   | -16   |
| Joint Development               | 5                             | 11   | 3   | 5             | 62  | 0  | 9              | 2   | 0   | 0             | 26   | 0   | 123   |
| Net 2025 Trips                  | 5                             | 6    | -1  | 8             | 63  | 0  | 9              | 1   | 0   | -1            | 17   | 0   | 107   |
| Background + Project            | 190                           | 1105 | 315 | 45            | 768 | 50 | 203            | 287 | 158 | 215           | 937  | 250 | 4523  |
| Cumulative No Project           | 185                           | 1191 | 426 | 174           | 814 | 50 | 194            | 534 | 174 | 216           | 1107 | 250 | 5065  |
| <b>Cumulative Project Trips</b> |                               |      |     |               |     |    |                |     |     |               |      |     |       |
| BART                            | 1                             | -1   | 0   | 1             | 6   | 0  | 1              | -1  | 0   | -1            | -6   | 0   | 0     |
| Joint Development               | 2                             | 12   | 5   | 5             | 53  | 0  | 9              | 2   | 0   | 0             | 23   | 0   | 111   |
| Net 2035 Trips                  | 3                             | 11   | 5   | 6             | 59  | 0  | 10             | 1   | 0   | -1            | 17   | 0   | 111   |
| Cumulative With Project         | 188                           | 1202 | 431 | 180           | 873 | 50 | 204            | 535 | 174 | 215           | 1124 | 250 | 5426  |

Intersection Number: 47  
 Traffic Node Number: 5444  
 Intersection Name: Lafayette St & Lewis St  
 Peak Hour: PM  
 Count Date: 10/08/14  
 Scenario: BART Extension Phase II  
 Date of Analysis: 09/02/15

| Scenario:                       | Movements      |      |    |               |     |     |                |     |    |               |    |    | Total |
|---------------------------------|----------------|------|----|---------------|-----|-----|----------------|-----|----|---------------|----|----|-------|
|                                 | North Approach |      |    | East Approach |     |     | South Approach |     |    | West Approach |    |    |       |
|                                 | RT             | TH   | LT | RT            | TH  | LT  | RT             | TH  | LT | RT            | TH | LT |       |
| Existing Conditions             | 22             | 1146 | 0  | 267           | 270 | 518 | 0              | 380 | 3  | 0             | 0  | 0  | 2606  |
| <b>Approved Project Trips</b>   |                |      |    |               |     |     |                |     |    |               |    |    |       |
| San Jose ATI                    | 0              | 0    | 0  | 0             | 0   | 0   | 0              | 0   | 0  | 0             | 0  | 0  | 0     |
| Santa Clara ATI                 | 0              | 172  | 0  | 0             | 0   | 0   | 0              | 37  | 0  | 0             | 0  | 0  | 209   |
| Total Approved Trips            | 0              | 172  | 0  | 0             | 0   | 0   | 0              | 37  | 0  | 0             | 0  | 0  | 209   |
| Background Conditions           | 22             | 1318 | 0  | 267           | 270 | 518 | 0              | 417 | 3  | 0             | 0  | 0  | 2815  |
| <b>2015 Project Trips</b>       |                |      |    |               |     |     |                |     |    |               |    |    |       |
| BART                            | 0              | -1   | 0  | 0             | 3   | 5   | 0              | 0   | 0  | 0             | 0  | 0  | 7     |
| Joint Development               | 0              | 0    | 0  | 0             | 13  | 87  | 0              | 5   | 0  | 0             | 0  | 0  | 105   |
| Net 2015 Trips                  | 0              | -1   | 0  | 0             | 16  | 92  | 0              | 5   | 0  | 0             | 0  | 0  | 112   |
| Existing + Project              | 22             | 1145 | 0  | 267           | 286 | 610 | 0              | 385 | 3  | 0             | 0  | 0  | 2718  |
| <b>2025 Project Trips</b>       |                |      |    |               |     |     |                |     |    |               |    |    |       |
| BART                            | 0              | -5   | 0  | 0             | 0   | 7   | 0              | -1  | 0  | 0             | 0  | 0  | 1     |
| Joint Development               | 0              | 11   | 0  | 0             | 28  | 72  | 0              | 11  | 0  | 0             | 0  | 0  | 122   |
| Net 2025 Trips                  | 0              | 6    | 0  | 0             | 28  | 79  | 0              | 10  | 0  | 0             | 0  | 0  | 123   |
| Background + Project            | 22             | 1324 | 0  | 267           | 298 | 597 | 0              | 427 | 3  | 0             | 0  | 0  | 2938  |
| Cumulative No Project           | 23             | 1401 | 0  | 311           | 426 | 518 | 0              | 633 | 5  | 0             | 0  | 0  | 3317  |
| <b>Cumulative Project Trips</b> |                |      |    |               |     |     |                |     |    |               |    |    |       |
| BART                            | 0              | -2   | 0  | 0             | 13  | 12  | 0              | -1  | 0  | 0             | 0  | 0  | 22    |
| Joint Development               | 0              | 12   | 0  | 0             | 30  | 52  | 0              | 10  | 0  | 0             | 0  | 0  | 104   |
| Net 2035 Trips                  | 0              | 10   | 0  | 0             | 43  | 64  | 0              | 9   | 0  | 0             | 0  | 0  | 126   |
| Cumulative With Project         | 23             | 1411 | 0  | 311           | 469 | 582 | 0              | 642 | 5  | 0             | 0  | 0  | 3443  |

Intersection Number: 48  
 Traffic Node Number: 1008  
 Intersection Name: Lafayette St & Harrison St  
 Peak Hour: PM  
 Count Date: 10/08/14  
 Scenario: BART Extension Phase II  
 Date of Analysis: 09/02/15

| Scenario:                       | Movements      |      |     |               |    |    |                |     |    |               |    |    | Total |
|---------------------------------|----------------|------|-----|---------------|----|----|----------------|-----|----|---------------|----|----|-------|
|                                 | North Approach |      |     | East Approach |    |    | South Approach |     |    | West Approach |    |    |       |
|                                 | RT             | TH   | LT  | RT            | TH | LT | RT             | TH  | LT | RT            | TH | LT |       |
| Existing Conditions             | 1              | 1519 | 145 | 7             | 4  | 4  | 40             | 372 | 4  | 9             | 20 | 3  | 2128  |
| <b>Approved Project Trips</b>   |                |      |     |               |    |    |                |     |    |               |    |    |       |
| San Jose ATI                    | 0              | 0    | 0   | 0             | 0  | 0  | 0              | 0   | 0  | 0             | 0  | 0  | 0     |
| Santa Clara ATI                 | 0              | 172  | 0   | 0             | 0  | 0  | 0              | 37  | 0  | 0             | 0  | 0  | 209   |
| Total Approved Trips            | 0              | 172  | 0   | 0             | 0  | 0  | 0              | 37  | 0  | 0             | 0  | 0  | 209   |
| Background Conditions           | 1              | 1691 | 145 | 7             | 4  | 4  | 40             | 409 | 4  | 9             | 20 | 3  | 2337  |
| <b>2015 Project Trips</b>       |                |      |     |               |    |    |                |     |    |               |    |    |       |
| BART                            | 0              | 4    | 0   | 0             | 0  | 0  | 0              | 0   | 0  | 0             | 0  | 0  | 4     |
| Joint Development               | 0              | 87   | 0   | 0             | 0  | 0  | 0              | 5   | 0  | 0             | 0  | 0  | 92    |
| Net 2015 Trips                  | 0              | 91   | 0   | 0             | 0  | 0  | 0              | 5   | 0  | 0             | 0  | 0  | 96    |
| Existing + Project              | 1              | 1610 | 145 | 7             | 4  | 4  | 40             | 377 | 4  | 9             | 20 | 3  | 2224  |
| <b>2025 Project Trips</b>       |                |      |     |               |    |    |                |     |    |               |    |    |       |
| BART                            | 0              | 0    | 0   | 0             | 0  | 0  | -1             | -1  | 0  | 0             | 0  | 0  | -2    |
| Joint Development               | 0              | 82   | 0   | 0             | 0  | 0  | 0              | 10  | 0  | 0             | 0  | 0  | 92    |
| Net 2025 Trips                  | 0              | 82   | 0   | 0             | 0  | 0  | -1             | 9   | 0  | 0             | 0  | 0  | 90    |
| Background + Project            | 1              | 1773 | 145 | 7             | 4  | 4  | 39             | 418 | 4  | 9             | 20 | 3  | 2427  |
| Cumulative No Project           | 1              | 1691 | 193 | 7             | 4  | 25 | 134            | 628 | 4  | 9             | 26 | 3  | 2722  |
| <b>Cumulative Project Trips</b> |                |      |     |               |    |    |                |     |    |               |    |    |       |
| BART                            | 0              | 7    | 0   | 0             | 0  | -1 | -1             | -1  | 0  | 0             | 1  | 0  | 5     |
| Joint Development               | 0              | 63   | 0   | 0             | 0  | 0  | 2              | 9   | 0  | 0             | 0  | 0  | 74    |
| Net 2035 Trips                  | 0              | 70   | 0   | 0             | 0  | -1 | 1              | 8   | 0  | 0             | 1  | 0  | 79    |
| Cumulative With Project         | 1              | 1761 | 193 | 7             | 4  | 24 | 135            | 636 | 4  | 9             | 27 | 3  | 2804  |

Intersection Number: **49**  
 Traffic Node Number: 107  
 Intersection Name: Lafayette St & Benton St  
 Peak Hour: PM  
 Count Date: 10/08/14  
 Scenario: BART Extension Phase II  
 Date of Analysis: 09/02/15

| Scenario:                       | Movements      |      |    |               |     |    |                |     |    |               |     |    | Total |
|---------------------------------|----------------|------|----|---------------|-----|----|----------------|-----|----|---------------|-----|----|-------|
|                                 | North Approach |      |    | East Approach |     |    | South Approach |     |    | West Approach |     |    |       |
|                                 | RT             | TH   | LT | RT            | TH  | LT | RT             | TH  | LT | RT            | TH  | LT |       |
| Existing Conditions             | 55             | 1420 | 16 | 8             | 149 | 59 | 75             | 387 | 1  | 73            | 201 | 41 | 2485  |
| <b>Approved Project Trips</b>   |                |      |    |               |     |    |                |     |    |               |     |    |       |
| San Jose ATI                    | 0              | 0    | 0  | 0             | 0   | 0  | 0              | 0   | 0  | 0             | 0   | 0  | 0     |
| Santa Clara ATI                 | 12             | 156  | 29 | 1             | 41  | 0  | 0              | 37  | 0  | 16            | 41  | 7  | 340   |
| Total Approved Trips            | 12             | 156  | 29 | 1             | 41  | 0  | 0              | 37  | 0  | 16            | 41  | 7  | 340   |
| Background Conditions           | 67             | 1576 | 45 | 9             | 190 | 59 | 75             | 424 | 1  | 89            | 242 | 48 | 2825  |
| <b>2015 Project Trips</b>       |                |      |    |               |     |    |                |     |    |               |     |    |       |
| BART                            | 1              | 3    | 0  | 0             | 1   | 1  | 2              | 0   | 0  | 0             | 1   | 0  | 9     |
| Joint Development               | 2              | 85   | 0  | 0             | 0   | 0  | 0              | 4   | 0  | 0             | 0   | 1  | 92    |
| Net 2015 Trips                  | 3              | 88   | 0  | 0             | 1   | 1  | 2              | 4   | 0  | 0             | 1   | 1  | 101   |
| Existing + Project              | 58             | 1508 | 16 | 8             | 150 | 60 | 77             | 391 | 1  | 73            | 202 | 42 | 2586  |
| <b>2025 Project Trips</b>       |                |      |    |               |     |    |                |     |    |               |     |    |       |
| BART                            | 1              | 0    | 0  | 0             | 1   | 1  | 2              | -1  | 0  | 0             | 1   | -1 | 4     |
| Joint Development               | 1              | 80   | 0  | 0             | 0   | 0  | 0              | 8   | 0  | 0             | 0   | 1  | 90    |
| Net 2025 Trips                  | 2              | 80   | 0  | 0             | 1   | 1  | 2              | 7   | 0  | 0             | 1   | 0  | 94    |
| Background + Project            | 69             | 1656 | 45 | 9             | 191 | 60 | 77             | 431 | 1  | 89            | 243 | 48 | 2919  |
| Cumulative No Project           | 67             | 1576 | 45 | 11            | 190 | 70 | 79             | 724 | 18 | 89            | 242 | 52 | 3111  |
| <b>Cumulative Project Trips</b> |                |      |    |               |     |    |                |     |    |               |     |    |       |
| BART                            | 1              | 5    | 0  | 0             | 4   | -2 | 5              | -1  | -1 | 0             | 1   | -1 | 11    |
| Joint Development               | 1              | 62   | 0  | 0             | 0   | 0  | 0              | 10  | 0  | 0             | 0   | 1  | 74    |
| Net 2035 Trips                  | 2              | 67   | 0  | 0             | 4   | -2 | 5              | 9   | -1 | 0             | 1   | 0  | 85    |
| Cumulative With Project         | 69             | 1643 | 45 | 11            | 194 | 68 | 84             | 733 | 17 | 89            | 243 | 52 | 3248  |

Intersection Number: **50**  
 Traffic Node Number: 128  
 Intersection Name: Lafayette St & Homestead Rd  
 Peak Hour: PM  
 Count Date: 05/20/15  
 Scenario: BART Extension Phase II  
 Date of Analysis: 09/02/15

| Scenario:                       | Movements      |      |    |               |    |    |                |     |    |               |    |     | Total |
|---------------------------------|----------------|------|----|---------------|----|----|----------------|-----|----|---------------|----|-----|-------|
|                                 | North Approach |      |    | East Approach |    |    | South Approach |     |    | West Approach |    |     |       |
|                                 | RT             | TH   | LT | RT            | TH | LT | RT             | TH  | LT | RT            | TH | LT  |       |
| Existing Conditions             | 176            | 1257 | 0  | 0             | 0  | 0  | 0              | 379 | 72 | 142           | 0  | 98  | 2124  |
| <b>Approved Project Trips</b>   |                |      |    |               |    |    |                |     |    |               |    |     |       |
| San Jose ATI                    | 0              | 0    | 0  | 0             | 0  | 0  | 0              | 0   | 0  | 0             | 0  | 0   | 0     |
| Santa Clara ATI                 | 0              | 141  | 0  | 0             | 0  | 0  | 0              | 31  | 0  | 0             | 0  | 0   | 172   |
| Total Approved Trips            | 0              | 141  | 0  | 0             | 0  | 0  | 0              | 31  | 0  | 0             | 0  | 0   | 172   |
| Background Conditions           | 176            | 1398 | 0  | 0             | 0  | 0  | 0              | 410 | 72 | 142           | 0  | 98  | 2296  |
| <b>2015 Project Trips</b>       |                |      |    |               |    |    |                |     |    |               |    |     |       |
| BART                            | 1              | 2    | 0  | 0             | 0  | 0  | 0              | 1   | -1 | -4            | 0  | 1   | 0     |
| Joint Development               | 0              | 83   | 0  | 0             | 0  | 0  | 0              | 4   | 0  | 0             | 0  | 0   | 87    |
| Net 2015 Trips                  | 1              | 85   | 0  | 0             | 0  | 0  | 0              | 5   | -1 | -4            | 0  | 1   | 87    |
| Existing + Project              | 177            | 1342 | 0  | 0             | 0  | 0  | 0              | 384 | 71 | 138           | 0  | 99  | 2211  |
| <b>2025 Project Trips</b>       |                |      |    |               |    |    |                |     |    |               |    |     |       |
| BART                            | 2              | -6   | 0  | 0             | 0  | 0  | 0              | -2  | -1 | -5            | 0  | 1   | -11   |
| Joint Development               | 0              | 80   | 0  | 0             | 0  | 0  | 0              | 8   | 0  | 0             | 0  | 0   | 88    |
| Net 2025 Trips                  | 2              | 74   | 0  | 0             | 0  | 0  | 0              | 6   | -1 | -5            | 0  | 1   | 77    |
| Background + Project            | 178            | 1472 | 0  | 0             | 0  | 0  | 0              | 416 | 71 | 137           | 0  | 99  | 2373  |
| Cumulative No Project           | 176            | 1398 | 0  | 0             | 0  | 0  | 0              | 725 | 76 | 142           | 0  | 103 | 2517  |
| <b>Cumulative Project Trips</b> |                |      |    |               |    |    |                |     |    |               |    |     |       |
| BART                            | 3              | 6    | 0  | 0             | 0  | 0  | 0              | 0   | -1 | -5            | 0  | 1   | 4     |
| Joint Development               | 0              | 62   | 0  | 0             | 0  | 0  | 0              | 10  | 0  | 0             | 0  | 0   | 72    |
| Net 2035 Trips                  | 3              | 68   | 0  | 0             | 0  | 0  | 0              | 10  | -1 | -5            | 0  | 1   | 76    |
| Cumulative With Project         | 179            | 1466 | 0  | 0             | 0  | 0  | 0              | 735 | 75 | 137           | 0  | 104 | 2696  |

Intersection Number: **51**  
 Traffic Node Number: 121  
 Intersection Name: Lafayette St & Market St  
 Peak Hour: PM  
 Count Date: 05/20/15  
 Scenario: BART Extension Phase II  
 Date of Analysis: 09/02/15

| Scenario:                       | Movements      |      |     |               |     |    |                |     |    |               |    |     | Total |
|---------------------------------|----------------|------|-----|---------------|-----|----|----------------|-----|----|---------------|----|-----|-------|
|                                 | North Approach |      |     | East Approach |     |    | South Approach |     |    | West Approach |    |     |       |
|                                 | RT             | TH   | LT  | RT            | TH  | LT | RT             | TH  | LT | RT            | TH | LT  |       |
| Existing Conditions             | 20             | 1094 | 316 | 126           | 93  | 19 | 22             | 341 | 49 | 10            | 59 | 13  | 2162  |
| <b>Approved Project Trips</b>   |                |      |     |               |     |    |                |     |    |               |    |     |       |
| San Jose ATI                    | 0              | 0    | 0   | 0             | 0   | 0  | 0              | 0   | 0  | 0             | 0  | 0   | 0     |
| Santa Clara ATI                 | 0              | 141  | 0   | 0             | 0   | 0  | 0              | 31  | 0  | 0             | 0  | 0   | 172   |
| Total Approved Trips            | 0              | 141  | 0   | 0             | 0   | 0  | 0              | 31  | 0  | 0             | 0  | 0   | 172   |
| Background Conditions           | 20             | 1235 | 316 | 126           | 93  | 19 | 22             | 372 | 49 | 10            | 59 | 13  | 2334  |
| <b>2015 Project Trips</b>       |                |      |     |               |     |    |                |     |    |               |    |     |       |
| BART                            | 3              | 1    | -5  | -1            | -2  | 0  | 0              | 0   | 0  | 0             | -1 | 1   | -4    |
| Joint Development               | 34             | 49   | 0   | 0             | 0   | 0  | 0              | 2   | 0  | 0             | 0  | 2   | 87    |
| Net 2015 Trips                  | 37             | 50   | -5  | -1            | -2  | 0  | 0              | 2   | 0  | 0             | -1 | 3   | 83    |
| Existing + Project              | 57             | 1144 | 311 | 125           | 91  | 19 | 22             | 343 | 49 | 10            | 58 | 16  | 2245  |
| <b>2025 Project Trips</b>       |                |      |     |               |     |    |                |     |    |               |    |     |       |
| BART                            | -1             | -4   | -5  | -3            | -4  | 0  | 0              | -1  | 0  | -1            | -1 | 1   | -19   |
| Joint Development               | 24             | 52   | 4   | 0             | 0   | 0  | 0              | 4   | 0  | 0             | 0  | 4   | 88    |
| Net 2025 Trips                  | 23             | 48   | -1  | -3            | -4  | 0  | 0              | 3   | 0  | -1            | -1 | 5   | 69    |
| Background + Project            | 43             | 1283 | 315 | 123           | 89  | 19 | 22             | 375 | 49 | 9             | 58 | 18  | 2403  |
| Cumulative No Project           | 20             | 1235 | 316 | 163           | 192 | 19 | 22             | 566 | 63 | 19            | 82 | 100 | 2697  |
| <b>Cumulative Project Trips</b> |                |      |     |               |     |    |                |     |    |               |    |     |       |
| BART                            | 5              | -1   | -4  | -4            | -5  | 0  | 0              | 0   | 0  | -1            | -2 | 1   | -11   |
| Joint Development               | 20             | 42   | 0   | 0             | 0   | 0  | 0              | 6   | 0  | 0             | 0  | 4   | 72    |
| Net 2035 Trips                  | 25             | 41   | -4  | -4            | -5  | 0  | 0              | 6   | 0  | -1            | -2 | 5   | 61    |
| Cumulative With Project         | 45             | 1276 | 312 | 159           | 187 | 19 | 22             | 572 | 63 | 18            | 80 | 105 | 2858  |

Intersection Number: **52**  
 Traffic Node Number: 106  
 Intersection Name: El Camino Real & Benton St  
 Peak Hour: PM  
 Count Date: 10/08/14  
 Scenario: BART Extension Phase II  
 Date of Analysis: 09/02/15

| Scenario:                       | Movements      |      |    |               |    |    |                |      |     |               |    |    | Total |
|---------------------------------|----------------|------|----|---------------|----|----|----------------|------|-----|---------------|----|----|-------|
|                                 | North Approach |      |    | East Approach |    |    | South Approach |      |     | West Approach |    |    |       |
|                                 | RT             | TH   | LT | RT            | TH | LT | RT             | TH   | LT  | RT            | TH | LT |       |
| Existing Conditions             | 29             | 1231 | 76 | 48            | 33 | 19 | 6              | 542  | 145 | 190           | 26 | 40 | 2385  |
| <b>Approved Project Trips</b>   |                |      |    |               |    |    |                |      |     |               |    |    |       |
| San Jose ATI                    | 0              | 0    | 0  | 0             | 0  | 0  | 0              | 0    | 0   | 0             | 0  | 0  | 0     |
| Santa Clara ATI                 | 0              | 92   | 0  | 0             | 0  | 31 | 6              | 58   | 4   | 2             | 0  | 1  | 194   |
| Total Approved Trips            | 0              | 92   | 0  | 0             | 0  | 31 | 6              | 58   | 4   | 2             | 0  | 1  | 194   |
| Background Conditions           | 29             | 1323 | 76 | 48            | 33 | 50 | 12             | 600  | 149 | 192           | 26 | 41 | 2579  |
| <b>2015 Project Trips</b>       |                |      |    |               |    |    |                |      |     |               |    |    |       |
| BART                            | 0              | 1    | 4  | 3             | 2  | 0  | 0              | 0    | -1  | -4            | 3  | 0  | 8     |
| Joint Development               | 0              | 40   | 0  | 0             | 0  | 0  | 0              | 5    | 0   | 0             | 0  | 0  | 45    |
| Net 2015 Trips                  | 0              | 41   | 4  | 3             | 2  | 0  | 0              | 5    | -1  | -4            | 3  | 0  | 53    |
| Existing + Project              | 29             | 1272 | 80 | 51            | 35 | 19 | 6              | 547  | 144 | 186           | 29 | 40 | 2438  |
| <b>2025 Project Trips</b>       |                |      |    |               |    |    |                |      |     |               |    |    |       |
| BART                            | 0              | -3   | 3  | 3             | 3  | 0  | 0              | -2   | -3  | -5            | 2  | 0  | -2    |
| Joint Development               | 0              | 40   | 0  | 0             | 0  | 0  | 0              | 7    | 0   | 0             | 0  | 0  | 47    |
| Net 2025 Trips                  | 0              | 37   | 3  | 3             | 3  | 0  | 0              | 5    | -3  | -5            | 2  | 0  | 45    |
| Background + Project            | 29             | 1360 | 79 | 51            | 36 | 50 | 12             | 605  | 146 | 187           | 28 | 41 | 2624  |
| Cumulative No Project           | 29             | 1786 | 76 | 48            | 33 | 50 | 12             | 1037 | 233 | 219           | 26 | 41 | 3549  |
| <b>Cumulative Project Trips</b> |                |      |    |               |    |    |                |      |     |               |    |    |       |
| BART                            | 0              | 1    | 5  | 2             | 4  | 0  | 0              | -3   | -5  | -6            | 6  | 0  | 4     |
| Joint Development               | 0              | 48   | 0  | 0             | 0  | 0  | 0              | 12   | 0   | 0             | 0  | 0  | 60    |
| Net 2035 Trips                  | 0              | 49   | 5  | 2             | 4  | 0  | 0              | 9    | -5  | -6            | 6  | 0  | 64    |
| Cumulative With Project         | 29             | 1835 | 81 | 50            | 37 | 50 | 12             | 1046 | 228 | 213           | 32 | 41 | 3654  |

Intersection Number: **53**  
 Traffic Node Number: 1012  
 Intersection Name: El Camino Real & Railroad Ave  
 Peak Hour: PM  
 Count Date: 10/08/14  
 Scenario: BART Extension Phase II  
 Date of Analysis: 09/02/15

| Scenario:                       | Movements      |      |    |               |    |    |                |      |     |               |    |    | Total |
|---------------------------------|----------------|------|----|---------------|----|----|----------------|------|-----|---------------|----|----|-------|
|                                 | North Approach |      |    | East Approach |    |    | South Approach |      |     | West Approach |    |    |       |
|                                 | RT             | TH   | LT | RT            | TH | LT | RT             | TH   | LT  | RT            | TH | LT |       |
| Existing Conditions             | 113            | 1085 | 51 | 36            | 4  | 58 | 24             | 580  | 143 | 146           | 3  | 59 | 2302  |
| <b>Approved Project Trips</b>   |                |      |    |               |    |    |                |      |     |               |    |    |       |
| San Jose ATI                    | 0              | 0    | 0  | 0             | 0  | 0  | 0              | 0    | 0   | 0             | 0  | 0  | 0     |
| Santa Clara ATI                 | 0              | 105  | 0  | 0             | 0  | 0  | 0              | 166  | 0   | 0             | 0  | 0  | 271   |
| Total Approved Trips            | 0              | 105  | 0  | 0             | 0  | 0  | 0              | 166  | 0   | 0             | 0  | 0  | 271   |
| Background Conditions           | 113            | 1190 | 51 | 36            | 4  | 58 | 24             | 746  | 143 | 146           | 3  | 59 | 2573  |
| <b>2015 Project Trips</b>       |                |      |    |               |    |    |                |      |     |               |    |    |       |
| BART                            | -1             | -3   | 0  | 0             | 0  | 2  | 2              | 0    | -3  | -4            | 0  | 0  | -7    |
| Joint Development               | 0              | 39   | 0  | 0             | 0  | 0  | 0              | 5    | 0   | 0             | 0  | 0  | 44    |
| Net 2015 Trips                  | -1             | 36   | 0  | 0             | 0  | 2  | 2              | 5    | -3  | -4            | 0  | 0  | 37    |
| Existing + Project              | 112            | 1121 | 51 | 36            | 4  | 60 | 26             | 585  | 140 | 142           | 3  | 59 | 2339  |
| <b>2025 Project Trips</b>       |                |      |    |               |    |    |                |      |     |               |    |    |       |
| BART                            | 0              | -7   | 0  | 0             | 0  | 1  | 3              | -3   | -3  | -4            | 0  | -1 | -14   |
| Joint Development               | 0              | 40   | 0  | 0             | 0  | 0  | 0              | 7    | 0   | 0             | 0  | 0  | 47    |
| Net 2025 Trips                  | 0              | 33   | 0  | 0             | 0  | 1  | 3              | 4    | -3  | -4            | 0  | -1 | 33    |
| Background + Project            | 113            | 1223 | 51 | 36            | 4  | 59 | 27             | 750  | 140 | 142           | 3  | 58 | 2606  |
| Cumulative No Project           | 116            | 1666 | 51 | 36            | 4  | 58 | 24             | 1135 | 143 | 146           | 3  | 87 | 3382  |
| <b>Cumulative Project Trips</b> |                |      |    |               |    |    |                |      |     |               |    |    |       |
| BART                            | 0              | -3   | 0  | 0             | 0  | 2  | 4              | -7   | -4  | -5            | 0  | -2 | -15   |
| Joint Development               | 0              | 48   | 0  | 0             | 0  | 0  | 0              | 12   | 0   | 0             | 0  | 0  | 60    |
| Net 2035 Trips                  | 0              | 45   | 0  | 0             | 0  | 2  | 4              | 5    | -4  | -5            | 0  | -2 | 45    |
| Cumulative With Project         | 116            | 1711 | 51 | 36            | 4  | 60 | 28             | 1140 | 139 | 141           | 3  | 85 | 3514  |

Intersection Number: **54**  
 Traffic Node Number: 1213  
 Intersection Name: El Camino Real & The Alameda  
 Peak Hour: PM  
 Count Date: 09/17/14  
 Scenario: BART Extension Phase II  
 Date of Analysis: 09/02/15

| Scenario:                       | Movements      |      |    |               |    |    |                |      |     |               |    |     | Total |
|---------------------------------|----------------|------|----|---------------|----|----|----------------|------|-----|---------------|----|-----|-------|
|                                 | North Approach |      |    | East Approach |    |    | South Approach |      |     | West Approach |    |     |       |
|                                 | RT             | TH   | LT | RT            | TH | LT | RT             | TH   | LT  | RT            | TH | LT  |       |
| Existing Conditions             | 155            | 1454 | 7  | 8             | 8  | 29 | 23             | 645  | 242 | 281           | 3  | 123 | 2978  |
| <b>Approved Project Trips</b>   |                |      |    |               |    |    |                |      |     |               |    |     |       |
| San Jose ATI                    | 0              | 0    | 0  | 0             | 0  | 0  | 0              | 0    | 0   | 0             | 0  | 0   | 0     |
| Santa Clara ATI                 | 0              | 125  | 0  | 0             | 0  | 0  | 0              | 69   | 0   | 0             | 0  | 0   | 194   |
| Total Approved Trips            | 0              | 125  | 0  | 0             | 0  | 0  | 0              | 69   | 0   | 0             | 0  | 0   | 194   |
| Background Conditions           | 155            | 1579 | 7  | 8             | 8  | 29 | 23             | 714  | 242 | 281           | 3  | 123 | 3172  |
| <b>2015 Project Trips</b>       |                |      |    |               |    |    |                |      |     |               |    |     |       |
| BART                            | 2              | -18  | 0  | 0             | 0  | 0  | 0              | -6   | -4  | -6            | 0  | 1   | -31   |
| Joint Development               | 0              | 34   | 0  | 0             | 0  | 0  | 0              | 1    | 0   | 0             | 0  | 1   | 36    |
| Net 2015 Trips                  | 2              | 16   | 0  | 0             | 0  | 0  | 0              | -5   | -4  | -6            | 0  | 2   | 5     |
| Existing + Project              | 157            | 1470 | 7  | 8             | 8  | 29 | 23             | 640  | 238 | 275           | 3  | 125 | 2983  |
| <b>2025 Project Trips</b>       |                |      |    |               |    |    |                |      |     |               |    |     |       |
| BART                            | 1              | -27  | 0  | 0             | 0  | 0  | 0              | -11  | -6  | -9            | 0  | 1   | -51   |
| Joint Development               | 0              | 35   | 0  | 0             | 0  | 0  | 0              | 3    | 1   | 0             | 0  | 1   | 40    |
| Net 2025 Trips                  | 1              | 8    | 0  | 0             | 0  | 0  | 0              | -8   | -5  | -9            | 0  | 2   | -11   |
| Background + Project            | 156            | 1587 | 7  | 8             | 8  | 29 | 23             | 706  | 237 | 272           | 3  | 125 | 3161  |
| Cumulative No Project           | 230            | 1882 | 7  | 8             | 8  | 29 | 23             | 1206 | 350 | 281           | 3  | 123 | 4027  |
| <b>Cumulative Project Trips</b> |                |      |    |               |    |    |                |      |     |               |    |     |       |
| BART                            | 1              | -27  | 0  | 0             | 0  | 0  | 0              | -19  | -9  | -9            | 0  | 2   | -61   |
| Joint Development               | 2              | 40   | 0  | 0             | 0  | 0  | 0              | 7    | 1   | 0             | 0  | 1   | 51    |
| Net 2035 Trips                  | 3              | 13   | 0  | 0             | 0  | 0  | 0              | -12  | -8  | -9            | 0  | 3   | -10   |
| Cumulative With Project         | 233            | 1895 | 7  | 8             | 8  | 29 | 23             | 1194 | 342 | 272           | 3  | 126 | 4140  |

Intersection Number: **55**  
 Traffic Node Number: 1214  
 Intersection Name: The Alameda & Newhall Dr  
 Peak Hour: PM  
 Count Date: 05/20/15  
 Scenario: BART Extension Phase II  
 Date of Analysis: 09/02/15

| Scenario:                       | Movements      |      |    |               |     |    |                |      |     |               |    |    | Total |
|---------------------------------|----------------|------|----|---------------|-----|----|----------------|------|-----|---------------|----|----|-------|
|                                 | North Approach |      |    | East Approach |     |    | South Approach |      |     | West Approach |    |    |       |
|                                 | RT             | TH   | LT | RT            | TH  | LT | RT             | TH   | LT  | RT            | TH | LT |       |
| Existing Conditions             | 53             | 1675 | 40 | 27            | 26  | 84 | 64             | 819  | 61  | 95            | 24 | 36 | 3004  |
| <b>Approved Project Trips</b>   |                |      |    |               |     |    |                |      |     |               |    |    |       |
| San Jose ATI                    | 0              | 125  | 0  | 0             | 0   | 0  | 0              | 76   | 0   | 1             | 0  | 0  | 202   |
| Santa Clara ATI                 | 0              | 0    | 0  | 0             | 0   | 0  | 0              | 0    | 0   | 0             | 0  | 0  | 0     |
| Total Approved Trips            | 0              | 125  | 0  | 0             | 0   | 0  | 0              | 76   | 0   | 1             | 0  | 0  | 202   |
| Background Conditions           | 53             | 1800 | 40 | 27            | 26  | 84 | 64             | 895  | 61  | 96            | 24 | 36 | 3206  |
| <b>2015 Project Trips</b>       |                |      |    |               |     |    |                |      |     |               |    |    |       |
| BART                            | 0              | -23  | 0  | 0             | 0   | -2 | -2             | -11  | 1   | -1            | 0  | 0  | -38   |
| Joint Development               | 2              | 32   | 0  | 0             | 0   | 0  | 1              | 2    | 3   | 0             | 0  | 0  | 40    |
| Net 2015 Trips                  | 2              | 9    | 0  | 0             | 0   | -2 | -1             | -9   | 4   | -1            | 0  | 0  | 2     |
| Existing + Project              | 55             | 1684 | 40 | 27            | 26  | 82 | 63             | 810  | 65  | 94            | 24 | 36 | 3006  |
| <b>2025 Project Trips</b>       |                |      |    |               |     |    |                |      |     |               |    |    |       |
| BART                            | 2              | -37  | 0  | 0             | 0   | -3 | -4             | -18  | -2  | -2            | 0  | 0  | -64   |
| Joint Development               | 5              | 30   | 0  | 0             | 0   | 0  | 1              | 3    | 2   | 0             | 0  | 0  | 41    |
| Net 2025 Trips                  | 7              | -7   | 0  | 0             | 0   | -3 | -3             | -15  | 0   | -2            | 0  | 0  | -23   |
| Background + Project            | 60             | 1793 | 40 | 27            | 26  | 81 | 61             | 880  | 61  | 94            | 24 | 36 | 3183  |
| Cumulative No Project           | 119            | 1961 | 40 | 30            | 128 | 84 | 64             | 1439 | 136 | 96            | 89 | 84 | 4186  |
| <b>Cumulative Project Trips</b> |                |      |    |               |     |    |                |      |     |               |    |    |       |
| BART                            | 3              | -37  | 0  | 0             | 0   | -3 | -6             | -31  | -2  | -1            | 0  | 0  | -77   |
| Joint Development               | 16             | 24   | 0  | 0             | 0   | 0  | 1              | 7    | 1   | 0             | 0  | 0  | 49    |
| Net 2035 Trips                  | 19             | -13  | 0  | 0             | 0   | -3 | -5             | -24  | -1  | -1            | 0  | 0  | -28   |
| Cumulative With Project         | 138            | 1948 | 40 | 30            | 128 | 81 | 59             | 1415 | 135 | 95            | 89 | 84 | 4242  |

Intersection Number: **56**  
 Traffic Node Number: 3046  
 Intersection Name: The Alameda & I-880 (South)  
 Peak Hour: PM  
 Count Date: 09/25/14  
 Scenario: BART Extension Phase II  
 Date of Analysis: 09/02/15

| Scenario:                       | Movements      |      |    |               |    |     |                |      |    |               |    |    | Total |
|---------------------------------|----------------|------|----|---------------|----|-----|----------------|------|----|---------------|----|----|-------|
|                                 | North Approach |      |    | East Approach |    |     | South Approach |      |    | West Approach |    |    |       |
|                                 | RT             | TH   | LT | RT            | TH | LT  | RT             | TH   | LT | RT            | TH | LT |       |
| Existing Conditions             | 322            | 1588 | 0  | 237           | 0  | 202 | 389            | 824  | 0  | 0             | 0  | 0  | 3562  |
| <b>Approved Project Trips</b>   |                |      |    |               |    |     |                |      |    |               |    |    |       |
| San Jose ATI                    | 40             | 89   | 0  | 20            | 0  | 9   | 5              | 51   | 0  | 0             | 0  | 0  | 214   |
| Santa Clara ATI                 | 0              | 0    | 0  | 0             | 0  | 0   | 0              | 0    | 0  | 0             | 0  | 0  | 0     |
| Total Approved Trips            | 40             | 89   | 0  | 20            | 0  | 9   | 5              | 51   | 0  | 0             | 0  | 0  | 214   |
| Background Conditions           | 362            | 1677 | 0  | 257           | 0  | 211 | 394            | 875  | 0  | 0             | 0  | 0  | 3776  |
| <b>2015 Project Trips</b>       |                |      |    |               |    |     |                |      |    |               |    |    |       |
| BART                            | 0              | -26  | 0  | -10           | 0  | 0   | 0              | -2   | 0  | 0             | 0  | 0  | -38   |
| Joint Development               | 0              | 26   | 0  | 5             | 0  | 17  | 0              | 1    | 0  | 0             | 0  | 0  | 49    |
| Net 2015 Trips                  | 0              | 0    | 0  | -5            | 0  | 17  | 0              | -1   | 0  | 0             | 0  | 0  | 11    |
| Existing + Project              | 322            | 1588 | 0  | 232           | 0  | 219 | 389            | 823  | 0  | 0             | 0  | 0  | 3573  |
| <b>2025 Project Trips</b>       |                |      |    |               |    |     |                |      |    |               |    |    |       |
| BART                            | 0              | -42  | 0  | -21           | 0  | -1  | 0              | -6   | 0  | 0             | 0  | 0  | -70   |
| Joint Development               | 0              | 19   | 0  | 3             | 0  | 9   | 0              | 3    | 0  | 0             | 0  | 0  | 34    |
| Net 2025 Trips                  | 0              | -23  | 0  | -18           | 0  | 8   | 0              | -3   | 0  | 0             | 0  | 0  | -36   |
| Background + Project            | 362            | 1654 | 0  | 239           | 0  | 219 | 394            | 872  | 0  | 0             | 0  | 0  | 3740  |
| Cumulative No Project           | 362            | 1680 | 0  | 530           | 0  | 213 | 394            | 1218 | 0  | 0             | 0  | 0  | 4397  |
| <b>Cumulative Project Trips</b> |                |      |    |               |    |     |                |      |    |               |    |    |       |
| BART                            | 0              | -43  | 0  | -28           | 0  | 0   | 0              | -11  | 0  | 0             | 0  | 0  | -82   |
| Joint Development               | 0              | 21   | 0  | 2             | 0  | 6   | 0              | 6    | 0  | 0             | 0  | 0  | 35    |
| Net 2035 Trips                  | 0              | -22  | 0  | -26           | 0  | 6   | 0              | -5   | 0  | 0             | 0  | 0  | -47   |
| Cumulative With Project         | 362            | 1658 | 0  | 504           | 0  | 219 | 394            | 1213 | 0  | 0             | 0  | 0  | 4350  |

Intersection Number: **57**  
 Traffic Node Number: 3047  
 Intersection Name: The Alameda & I-880 (North)  
 Peak Hour: PM  
 Count Date: 09/25/14  
 Scenario: BART Extension Phase II  
 Date of Analysis: 09/02/15

| Scenario:                       | Movements      |      |    |               |    |    |                |      |    |               |    |     | Total |
|---------------------------------|----------------|------|----|---------------|----|----|----------------|------|----|---------------|----|-----|-------|
|                                 | North Approach |      |    | East Approach |    |    | South Approach |      |    | West Approach |    |     |       |
|                                 | RT             | TH   | LT | RT            | TH | LT | RT             | TH   | LT | RT            | TH | LT  |       |
| Existing Conditions             | 424            | 1375 | 0  | 0             | 0  | 0  | 224            | 946  | 0  | 386           | 0  | 252 | 3607  |
| <b>Approved Project Trips</b>   |                |      |    |               |    |    |                |      |    |               |    |     |       |
| San Jose ATI                    | 42             | 60   | 0  | 0             | 0  | 0  | 1              | 35   | 0  | 2             | 0  | 22  | 162   |
| Santa Clara ATI                 | 0              | 0    | 0  | 0             | 0  | 0  | 0              | 0    | 0  | 0             | 0  | 0   | 0     |
| Total Approved Trips            | 42             | 60   | 0  | 0             | 0  | 0  | 1              | 35   | 0  | 2             | 0  | 22  | 162   |
| Background Conditions           | 466            | 1435 | 0  | 0             | 0  | 0  | 225            | 981  | 0  | 388           | 0  | 274 | 3769  |
| <b>2015 Project Trips</b>       |                |      |    |               |    |    |                |      |    |               |    |     |       |
| BART                            | 0              | -11  | 0  | 0             | 0  | 0  | 0              | -1   | 0  | 1             | 0  | -2  | -13   |
| Joint Development               | 0              | 35   | 0  | 0             | 0  | 0  | 0              | 3    | 0  | 1             | 0  | 0   | 39    |
| Net 2015 Trips                  | 0              | 24   | 0  | 0             | 0  | 0  | 0              | 2    | 0  | 2             | 0  | -2  | 26    |
| Existing + Project              | 424            | 1399 | 0  | 0             | 0  | 0  | 224            | 948  | 0  | 388           | 0  | 250 | 3633  |
| <b>2025 Project Trips</b>       |                |      |    |               |    |    |                |      |    |               |    |     |       |
| BART                            | 0              | -22  | 0  | 0             | 0  | 0  | 0              | -19  | 0  | -1            | 0  | -4  | -46   |
| Joint Development               | 0              | 22   | 0  | 0             | 0  | 0  | 0              | 6    | 0  | 4             | 0  | 0   | 32    |
| Net 2025 Trips                  | 0              | 0    | 0  | 0             | 0  | 0  | 0              | -13  | 0  | 3             | 0  | -4  | -14   |
| Background + Project            | 466            | 1435 | 0  | 0             | 0  | 0  | 225            | 968  | 0  | 391           | 0  | 270 | 3755  |
| Cumulative No Project           | 466            | 1476 | 0  | 0             | 0  | 0  | 225            | 1061 | 0  | 630           | 0  | 274 | 3858  |
| <b>Cumulative Project Trips</b> |                |      |    |               |    |    |                |      |    |               |    |     |       |
| BART                            | 0              | -22  | 0  | 0             | 0  | 0  | 0              | -23  | 0  | -1            | 0  | -3  | -49   |
| Joint Development               | 0              | 17   | 0  | 0             | 0  | 0  | 0              | 8    | 0  | 1             | 0  | 0   | 26    |
| Net 2035 Trips                  | 0              | -5   | 0  | 0             | 0  | 0  | 0              | -15  | 0  | 0             | 0  | -3  | -23   |
| Cumulative With Project         | 466            | 1471 | 0  | 0             | 0  | 0  | 225            | 1046 | 0  | 630           | 0  | 271 | 4109  |

Intersection Number: **58**  
 Traffic Node Number: 3057  
 Intersection Name: The Alameda & W. Hedding St  
 Peak Hour: PM  
 Count Date: 09/30/14  
 Scenario: BART Extension Phase II  
 Date of Analysis: 09/02/15

| Scenario:                       | Movements      |      |     |               |     |     |                |      |     |               |      |     | Total |
|---------------------------------|----------------|------|-----|---------------|-----|-----|----------------|------|-----|---------------|------|-----|-------|
|                                 | North Approach |      |     | East Approach |     |     | South Approach |      |     | West Approach |      |     |       |
|                                 | RT             | TH   | LT  | RT            | TH  | LT  | RT             | TH   | LT  | RT            | TH   | LT  |       |
| Existing Conditions             | 58             | 1297 | 189 | 169           | 459 | 158 | 49             | 738  | 65  | 73            | 343  | 77  | 3675  |
| <b>Approved Project Trips</b>   |                |      |     |               |     |     |                |      |     |               |      |     |       |
| San Jose ATI                    | 5              | 60   | 6   | 15            | 65  | 11  | 3              | 75   | 14  | 9             | 20   | 7   | 290   |
| Santa Clara ATI                 | 0              | 0    | 0   | 0             | 0   | 0   | 0              | 0    | 0   | 0             | 0    | 0   | 0     |
| Total Approved Trips            | 5              | 60   | 6   | 15            | 65  | 11  | 3              | 75   | 14  | 9             | 20   | 7   | 290   |
| Background Conditions           | 63             | 1357 | 195 | 184           | 524 | 169 | 52             | 813  | 79  | 82            | 363  | 84  | 3965  |
| <b>2015 Project Trips</b>       |                |      |     |               |     |     |                |      |     |               |      |     |       |
| BART                            | 0              | -11  | 0   | 6             | 10  | -3  | 0              | -7   | 0   | 0             | 0    | 0   | -5    |
| Joint Development               | 4              | 30   | 1   | 0             | 1   | 0   | 2              | 2    | 0   | 0             | 0    | 0   | 40    |
| Net 2015 Trips                  | 4              | 19   | 1   | 6             | 11  | -3  | 2              | -5   | 0   | 0             | 0    | 0   | 35    |
| Existing + Project              | 62             | 1316 | 190 | 175           | 470 | 155 | 51             | 733  | 65  | 73            | 343  | 77  | 3710  |
| <b>2025 Project Trips</b>       |                |      |     |               |     |     |                |      |     |               |      |     |       |
| BART                            | 1              | -22  | -2  | -1            | -2  | -3  | -1             | -16  | -2  | -1            | -5   | -2  | -56   |
| Joint Development               | 1              | 19   | 4   | 0             | 2   | 1   | 2              | 5    | 0   | 3             | 1    | 0   | 38    |
| Net 2025 Trips                  | 2              | -3   | 2   | -1            | 0   | -2  | 1              | -11  | -2  | 2             | -4   | -2  | -18   |
| Background + Project            | 65             | 1354 | 197 | 183           | 524 | 167 | 53             | 802  | 77  | 84            | 359  | 82  | 3947  |
| Cumulative No Project           | 63             | 1357 | 546 | 184           | 878 | 257 | 79             | 1004 | 103 | 82            | 1138 | 178 | 5691  |
| <b>Cumulative Project Trips</b> |                |      |     |               |     |     |                |      |     |               |      |     |       |
| BART                            | 1              | -21  | -5  | -1            | -3  | -4  | -1             | -21  | -1  | -1            | -6   | -2  | -65   |
| Joint Development               | 1              | 14   | 3   | 0             | 2   | 3   | 2              | 7    | 0   | 1             | 8    | 0   | 41    |
| Net 2035 Trips                  | 2              | -7   | -2  | -1            | -1  | -1  | 1              | -14  | -1  | 0             | 2    | -2  | -24   |
| Cumulative With Project         | 65             | 1350 | 544 | 183           | 877 | 256 | 80             | 990  | 102 | 82            | 1140 | 176 | 5845  |



Intersection Number: **59**  
 Traffic Node Number: 3058  
 Intersection Name: The Alameda & W. Taylor St/Naglee Ave  
 Peak Hour: PM  
 Count Date: 09/30/14  
 Scenario: BART Extension Phase II  
 Date of Analysis: 09/02/15

| Scenario:                       | Movements      |      |     |               |     |     |                |     |     |               |     |     | Total |
|---------------------------------|----------------|------|-----|---------------|-----|-----|----------------|-----|-----|---------------|-----|-----|-------|
|                                 | North Approach |      |     | East Approach |     |     | South Approach |     |     | West Approach |     |     |       |
|                                 | RT             | TH   | LT  | RT            | TH  | LT  | RT             | TH  | LT  | RT            | TH  | LT  |       |
| Existing Conditions             | 70             | 1124 | 297 | 166           | 413 | 114 | 35             | 540 | 150 | 79            | 432 | 88  | 3508  |
| <b>Approved Project Trips</b>   |                |      |     |               |     |     |                |     |     |               |     |     |       |
| San Jose ATI                    | 8              | 146  | 6   | 7             | 71  | 8   | 0              | 133 | 40  | 24            | 34  | 11  | 488   |
| Santa Clara ATI                 | 0              | 0    | 0   | 0             | 0   | 0   | 0              | 0   | 0   | 0             | 0   | 0   | 0     |
| Total Approved Trips            | 8              | 146  | 6   | 7             | 71  | 8   | 0              | 133 | 40  | 24            | 34  | 11  | 488   |
| Background Conditions           | 78             | 1270 | 303 | 173           | 484 | 122 | 35             | 673 | 190 | 103           | 466 | 99  | 3996  |
| <b>2015 Project Trips</b>       |                |      |     |               |     |     |                |     |     |               |     |     |       |
| BART                            | 0              | -7   | -8  | -1            | 1   | 0   | 0              | -6  | 0   | 3             | 0   | 0   | -18   |
| Joint Development               | 1              | 28   | 2   | 1             | 3   | 0   | 0              | 3   | 0   | 0             | 2   | 0   | 40    |
| Net 2015 Trips                  | 1              | 21   | -6  | 0             | 4   | 0   | 0              | -3  | 0   | 3             | 2   | 0   | 22    |
| Existing + Project              | 71             | 1145 | 291 | 166           | 417 | 114 | 35             | 537 | 150 | 82            | 434 | 88  | 3530  |
| <b>2025 Project Trips</b>       |                |      |     |               |     |     |                |     |     |               |     |     |       |
| BART                            | 0              | -14  | -13 | -2            | 4   | 0   | 0              | -15 | 4   | 6             | -3  | 0   | -33   |
| Joint Development               | 1              | 19   | 4   | 3             | 8   | 1   | 0              | 3   | 0   | 1             | 2   | 0   | 42    |
| Net 2025 Trips                  | 1              | 5    | -9  | 1             | 12  | 1   | 0              | -12 | 4   | 7             | -1  | 0   | 9     |
| Background + Project            | 79             | 1275 | 294 | 174           | 496 | 123 | 35             | 661 | 194 | 110           | 465 | 99  | 4005  |
| Cumulative No Project           | 78             | 1270 | 363 | 351           | 748 | 122 | 85             | 713 | 291 | 296           | 808 | 117 | 5125  |
| <b>Cumulative Project Trips</b> |                |      |     |               |     |     |                |     |     |               |     |     |       |
| BART                            | 0              | -15  | -9  | -5            | 4   | -1  | 0              | -19 | 7   | 8             | -4  | 0   | -34   |
| Joint Development               | 1              | 15   | 2   | 4             | 7   | 0   | 0              | 4   | 0   | 2             | 5   | 0   | 40    |
| Net 2035 Trips                  | 1              | 0    | -7  | -1            | 11  | -1  | 0              | -15 | 7   | 10            | 1   | 0   | 6     |
| Cumulative With Project         | 79             | 1270 | 356 | 350           | 759 | 121 | 85             | 698 | 298 | 306           | 809 | 117 | 5248  |

Intersection Number: **60**  
 Traffic Node Number: 127  
 Intersection Name: Homestead Rd & Lincoln St/Winchester Blvd  
 Peak Hour: PM  
 Count Date: 05/20/15  
 Scenario: BART Extension Phase II  
 Date of Analysis: 09/02/15

| Scenario:                       | Movements      |     |    |               |     |    |                |     |    |               |     |    | Total |
|---------------------------------|----------------|-----|----|---------------|-----|----|----------------|-----|----|---------------|-----|----|-------|
|                                 | North Approach |     |    | East Approach |     |    | South Approach |     |    | West Approach |     |    |       |
|                                 | RT             | TH  | LT | RT            | TH  | LT | RT             | TH  | LT | RT            | TH  | LT |       |
| Existing Conditions             | 37             | 351 | 50 | 11            | 158 | 61 | 32             | 171 | 27 | 15            | 205 | 34 | 1152  |
| <b>Approved Project Trips</b>   |                |     |    |               |     |    |                |     |    |               |     |    |       |
| San Jose ATI                    | 0              | 0   | 0  | 0             | 0   | 0  | 0              | 0   | 0  | 0             | 0   | 0  | 0     |
| Santa Clara ATI                 | 0              | 0   | 11 | 6             | 22  | 16 | 10             | 0   | 0  | 0             | 30  | 0  | 95    |
| Total Approved Trips            | 0              | 0   | 11 | 6             | 22  | 16 | 10             | 0   | 0  | 0             | 30  | 0  | 95    |
| Background Conditions           | 37             | 351 | 61 | 17            | 180 | 77 | 42             | 171 | 27 | 15            | 235 | 34 | 1247  |
| <b>2015 Project Trips</b>       |                |     |    |               |     |    |                |     |    |               |     |    |       |
| BART                            | 1              | 0   | 0  | 0             | 0   | 0  | 0              | 0   | 0  | 0             | 0   | 0  | 1     |
| Joint Development               | 1              | 10  | 0  | 0             | 0   | 0  | 0              | 0   | 0  | 0             | 0   | 0  | 11    |
| Net 2015 Trips                  | 2              | 10  | 0  | 0             | 0   | 0  | 0              | 0   | 0  | 0             | 0   | 0  | 12    |
| Existing + Project              | 39             | 361 | 50 | 11            | 158 | 61 | 32             | 171 | 27 | 15            | 205 | 34 | 1164  |
| <b>2025 Project Trips</b>       |                |     |    |               |     |    |                |     |    |               |     |    |       |
| BART                            | 1              | -2  | 0  | 0             | 0   | 0  | 0              | 0   | 0  | 0             | 0   | 0  | -1    |
| Joint Development               | 1              | 28  | 0  | 0             | 0   | 0  | 0              | 0   | 0  | 0             | 0   | 0  | 29    |
| Net 2025 Trips                  | 2              | 26  | 0  | 0             | 0   | 0  | 0              | 0   | 0  | 0             | 0   | 0  | 28    |
| Background + Project            | 39             | 377 | 61 | 17            | 180 | 77 | 42             | 171 | 27 | 15            | 235 | 34 | 1275  |
| Cumulative No Project           | 37             | 643 | 61 | 17            | 180 | 77 | 43             | 220 | 60 | 15            | 235 | 34 | 1588  |
| <b>Cumulative Project Trips</b> |                |     |    |               |     |    |                |     |    |               |     |    |       |
| BART                            | 1              | 7   | 0  | 0             | 0   | 0  | 0              | -1  | 0  | 0             | 0   | 1  | 8     |
| Joint Development               | 0              | 25  | 0  | 0             | 0   | 0  | 0              | 0   | 0  | 0             | 0   | 0  | 25    |
| Net 2035 Trips                  | 1              | 32  | 0  | 0             | 0   | 0  | 0              | -1  | 0  | 0             | 0   | 1  | 33    |
| Cumulative With Project         | 38             | 675 | 61 | 17            | 180 | 77 | 43             | 219 | 60 | 15            | 235 | 35 | 1655  |

Intersection Number: **61**  
 Traffic Node Number: 123  
 Intersection Name: Homestead Rd & Monroe St  
 Peak Hour: PM  
 Count Date: 05/20/15  
 Scenario: BART Extension Phase II  
 Date of Analysis: 09/02/15

| Scenario:                       | Movements      |     |    |               |     |     |                |     |    |               |     |    | Total |
|---------------------------------|----------------|-----|----|---------------|-----|-----|----------------|-----|----|---------------|-----|----|-------|
|                                 | North Approach |     |    | East Approach |     |     | South Approach |     |    | West Approach |     |    |       |
|                                 | RT             | TH  | LT | RT            | TH  | LT  | RT             | TH  | LT | RT            | TH  | LT |       |
| Existing Conditions             | 29             | 609 | 56 | 49            | 181 | 37  | 17             | 255 | 30 | 50            | 163 | 18 | 1494  |
| <b>Approved Project Trips</b>   |                |     |    |               |     |     |                |     |    |               |     |    |       |
| San Jose ATI                    | 0              | 0   | 0  | 0             | 0   | 0   | 0              | 0   | 0  | 0             | 0   | 0  | 0     |
| Santa Clara ATI                 | 5              | 24  | 0  | 0             | 0   | 0   | 0              | 9   | 0  | 0             | 0   | 3  | 41    |
| Total Approved Trips            | 5              | 24  | 0  | 0             | 0   | 0   | 0              | 9   | 0  | 0             | 0   | 3  | 41    |
| Background Conditions           | 34             | 633 | 56 | 49            | 181 | 37  | 17             | 264 | 30 | 50            | 163 | 21 | 1535  |
| <b>2015 Project Trips</b>       |                |     |    |               |     |     |                |     |    |               |     |    |       |
| BART                            | 1              | 0   | 0  | 0             | 0   | 0   | 0              | 0   | 0  | 0             | 0   | 0  | 1     |
| Joint Development               | 0              | 0   | 0  | 0             | 0   | 0   | 0              | 0   | 0  | 0             | 0   | 0  | 0     |
| Net 2015 Trips                  | 1              | 0   | 0  | 0             | 0   | 0   | 0              | 0   | 0  | 0             | 0   | 0  | 1     |
| Existing + Project              | 30             | 609 | 56 | 49            | 181 | 37  | 17             | 255 | 30 | 50            | 163 | 18 | 1495  |
| <b>2025 Project Trips</b>       |                |     |    |               |     |     |                |     |    |               |     |    |       |
| BART                            | 1              | 0   | 0  | 0             | 0   | 0   | 0              | 0   | 0  | 0             | 0   | 0  | 1     |
| Joint Development               | 0              | 1   | 0  | 0             | 0   | 0   | 0              | 0   | 0  | 0             | 0   | 0  | 1     |
| Net 2025 Trips                  | 1              | 1   | 0  | 0             | 0   | 0   | 0              | 0   | 0  | 0             | 0   | 0  | 2     |
| Background + Project            | 35             | 634 | 56 | 49            | 181 | 37  | 17             | 264 | 30 | 50            | 163 | 21 | 1537  |
| Cumulative No Project           | 34             | 659 | 56 | 49            | 181 | 108 | 18             | 264 | 52 | 75            | 163 | 21 | 1659  |
| <b>Cumulative Project Trips</b> |                |     |    |               |     |     |                |     |    |               |     |    |       |
| BART                            | 1              | 0   | 0  | 0             | 0   | -1  | 0              | 0   | -1 | -1            | 0   | 0  | -2    |
| Joint Development               | 0              | 1   | 0  | 0             | 0   | 0   | 0              | 0   | 0  | 0             | 0   | 0  | 1     |
| Net 2035 Trips                  | 1              | 1   | 0  | 0             | 0   | -1  | 0              | 0   | -1 | -1            | 0   | 0  | -1    |
| Cumulative With Project         | 35             | 660 | 56 | 49            | 181 | 107 | 18             | 264 | 51 | 74            | 163 | 21 | 1679  |

Intersection Number: **62**  
 Traffic Node Number: 4069  
 Intersection Name: US 101 & Trimble  
 Peak Hour: PM  
 Count Date: 10/07/14  
 Scenario: BART Extension Phase II  
 Date of Analysis: 09/02/15

| Scenario:                       | Movements      |    |    |               |      |    |                |    |     |               |      |    | Total |
|---------------------------------|----------------|----|----|---------------|------|----|----------------|----|-----|---------------|------|----|-------|
|                                 | North Approach |    |    | East Approach |      |    | South Approach |    |     | West Approach |      |    |       |
|                                 | RT             | TH | LT | RT            | TH   | LT | RT             | TH | LT  | RT            | TH   | LT |       |
| Existing Conditions             | 0              | 0  | 0  | 735           | 1948 | 0  | 318            | 0  | 507 | 205           | 1131 | 0  | 4844  |
| <b>Approved Project Trips</b>   |                |    |    |               |      |    |                |    |     |               |      |    |       |
| San Jose ATI                    | 0              | 0  | 0  | 0             | 0    | 0  | 0              | 0  | 0   | 0             | 0    | 0  | 0     |
| Santa Clara ATI                 | 0              | 0  | 0  | 0             | 103  | 0  | 3              | 0  | 27  | 0             | 32   | 0  | 165   |
| Total Approved Trips            | 0              | 0  | 0  | 0             | 103  | 0  | 3              | 0  | 27  | 0             | 32   | 0  | 165   |
| Background Conditions           | 0              | 0  | 0  | 735           | 2051 | 0  | 321            | 0  | 534 | 205           | 1163 | 0  | 5009  |
| <b>2015 Project Trips</b>       |                |    |    |               |      |    |                |    |     |               |      |    |       |
| BART                            | 0              | 0  | 0  | 0             | -5   | 0  | -3             | 0  | -2  | 0             | -6   | 0  | -16   |
| Joint Development               | 0              | 0  | 0  | 0             | 11   | 0  | 3              | 0  | 5   | 0             | 42   | 0  | 61    |
| Net 2015 Trips                  | 0              | 0  | 0  | 0             | 6    | 0  | 0              | 0  | 3   | 0             | 36   | 0  | 45    |
| Existing + Project              | 0              | 0  | 0  | 735           | 1954 | 0  | 318            | 0  | 510 | 205           | 1167 | 0  | 4889  |
| <b>2025 Project Trips</b>       |                |    |    |               |      |    |                |    |     |               |      |    |       |
| BART                            | 0              | 0  | 0  | 0             | -29  | 0  | -3             | 0  | -5  | 0             | -15  | 0  | -52   |
| Joint Development               | 0              | 0  | 0  | 0             | 11   | 0  | 3              | 0  | 11  | 0             | 34   | 0  | 59    |
| Net 2025 Trips                  | 0              | 0  | 0  | 0             | -18  | 0  | 0              | 0  | 6   | 0             | 19   | 0  | 7     |
| Background + Project            | 0              | 0  | 0  | 735           | 2033 | 0  | 321            | 0  | 540 | 205           | 1182 | 0  | 5016  |
| Cumulative No Project           | 0              | 0  | 0  | 735           | 2389 | 0  | 407            | 0  | 534 | 205           | 1369 | 0  | 5639  |
| <b>Cumulative Project Trips</b> |                |    |    |               |      |    |                |    |     |               |      |    |       |
| BART                            | 0              | 0  | 0  | 0             | -17  | 0  | -1             | 0  | -2  | 0             | -12  | 0  | -32   |
| Joint Development               | 0              | 0  | 0  | 0             | 8    | 0  | 3              | 0  | 6   | 0             | 18   | 0  | 35    |
| Net 2035 Trips                  | 0              | 0  | 0  | 0             | -9   | 0  | 2              | 0  | 4   | 0             | 6    | 0  | 3     |
| Cumulative With Project         | 0              | 0  | 0  | 735           | 2380 | 0  | 409            | 0  | 538 | 205           | 1375 | 0  | 5642  |

## **Appendix E**

### **Intersection Level of Service Calculations**

BART

Level Of Service Computation Report  
2000 HCM Operations (Future Volume Alternative)  
AM - Existing Conditions

Intersection #6: DE LA CRUZ/MARTIN [Study Int 31]

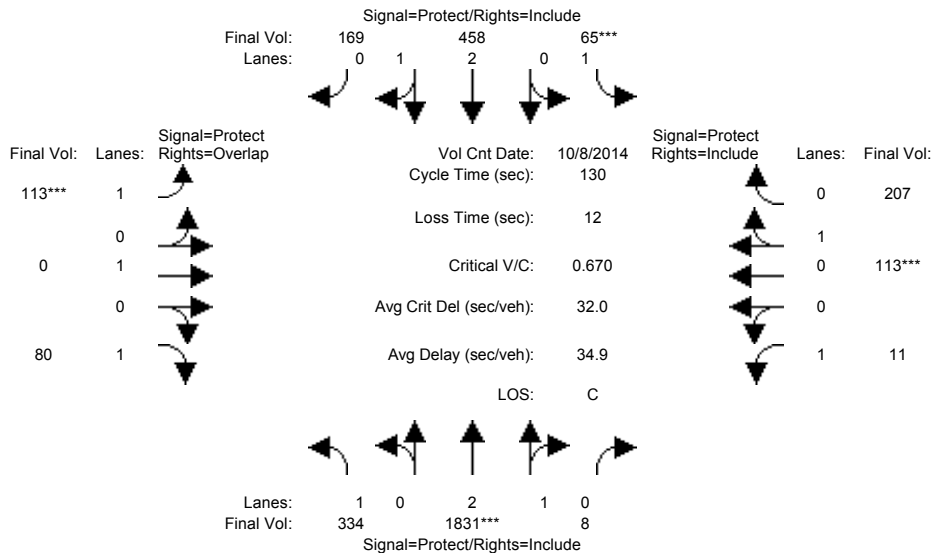

| Approach:                                   | North Bound |      |      | South Bound |      |      | East Bound |      |      | West Bound |      |      |
|---|-------------|------|------|-------------|------|------|------------|------|------|------------|------|------|
| Movement:                                   | L           | T    | R    | L           | T    | R    | L          | T    | R    | L          | T    | R    |
| Min. Green:                                 | 7           | 10   | 10   | 7           | 10   | 10   | 7          | 10   | 10   | 7          | 10   | 10   |
| Y+R:  | 4.0         | 4.0  | 4.0  | 4.0         | 4.0  | 4.0  | 4.0        | 4.0  | 4.0  | 4.0        | 4.0  | 4.0  |
| Volume Module: >> Count Date: 8 Oct 2014 << |             |      |      |             |      |      |            |      |      |            |      |      |
| Base Vol:                                   | 334         | 1831 | 8    | 65          | 458  | 169  | 113        | 0    | 80   | 11         | 113  | 207  |
| Growth Adj:                                 | 1.00        | 1.00 | 1.00 | 1.00        | 1.00 | 1.00 | 1.00       | 1.00 | 1.00 | 1.00       | 1.00 | 1.00 |
| Initial Bse:                                | 334         | 1831 | 8    | 65          | 458  | 169  | 113        | 0    | 80   | 11         | 113  | 207  |
| Added Vol:                                  | 0           | 0    | 0    | 0           | 0    | 0    | 0          | 0    | 0    | 0          | 0    | 0    |
| PasserByVol:                                | 0           | 0    | 0    | 0           | 0    | 0    | 0          | 0    | 0    | 0          | 0    | 0    |
| Initial Fut:                                | 334         | 1831 | 8    | 65          | 458  | 169  | 113        | 0    | 80   | 11         | 113  | 207  |
| User Adj:                                   | 1.00        | 1.00 | 1.00 | 1.00        | 1.00 | 1.00 | 1.00       | 1.00 | 1.00 | 1.00       | 1.00 | 1.00 |
| PHF Adj:                                    | 1.00        | 1.00 | 1.00 | 1.00        | 1.00 | 1.00 | 1.00       | 1.00 | 1.00 | 1.00       | 1.00 | 1.00 |
| PHF Volume:                                 | 334         | 1831 | 8    | 65          | 458  | 169  | 113        | 0    | 80   | 11         | 113  | 207  |
| Reduct Vol:                                 | 0           | 0    | 0    | 0           | 0    | 0    | 0          | 0    | 0    | 0          | 0    | 0    |
| Reduced Vol:                                | 334         | 1831 | 8    | 65          | 458  | 169  | 113        | 0    | 80   | 11         | 113  | 207  |
| PCE Adj:                                    | 1.00        | 1.00 | 1.00 | 1.00        | 1.00 | 1.00 | 1.00       | 1.00 | 1.00 | 1.00       | 1.00 | 1.00 |
| MLF Adj:                                    | 1.00        | 1.00 | 1.00 | 1.00        | 1.00 | 1.00 | 1.00       | 1.00 | 1.00 | 1.00       | 1.00 | 1.00 |
| Final Volume:                               | 334         | 1831 | 8    | 65          | 458  | 169  | 113        | 0    | 80   | 11         | 113  | 207  |
| Saturation Flow Module:                     |             |      |      |             |      |      |            |      |      |            |      |      |
| Sat/Lane:                                   | 1900        | 1900 | 1900 | 1900        | 1900 | 1900 | 1900       | 1900 | 1900 | 1900       | 1900 | 1900 |
| Adjustment:                                 | 0.92        | 0.98 | 0.95 | 0.92        | 1.00 | 0.95 | 0.92       | 1.00 | 0.92 | 0.92       | 0.95 | 0.95 |
| Lanes:                                      | 1.00        | 2.99 | 0.01 | 1.00        | 2.16 | 0.84 | 1.00       | 1.00 | 1.00 | 1.00       | 0.35 | 0.65 |
| Final Sat.:                                 | 1750        | 5576 | 24   | 1750        | 4089 | 1509 | 1750       | 1900 | 1750 | 1750       | 636  | 1164 |
| Capacity Analysis Module:                   |             |      |      |             |      |      |            |      |      |            |      |      |
| Vol/Sat:                                    | 0.19        | 0.33 | 0.33 | 0.04        | 0.11 | 0.11 | 0.06       | 0.00 | 0.05 | 0.01       | 0.18 | 0.18 |
| Crit Moves:                                 | ****        | **** | **** | ****        | **** | **** | ****       | **** | **** | ****       | **** | **** |
| Green Time:                                 | 44.7        | 63.7 | 63.7 | 7.2         | 26.2 | 26.2 | 12.5       | 0.0  | 57.2 | 47.0       | 34.5 | 34.5 |
| Volume/Cap:                                 | 0.55        | 0.67 | 0.67 | 0.67        | 0.55 | 0.55 | 0.67       | 0.00 | 0.10 | 0.02       | 0.67 | 0.67 |
| Delay/Veh:                                  | 35.7        | 25.8 | 25.8 | 76.9        | 47.2 | 47.2 | 66.7       | 0.0  | 21.4 | 26.6       | 46.3 | 46.3 |
| User DelAdj:                                | 1.00        | 1.00 | 1.00 | 1.00        | 1.00 | 1.00 | 1.00       | 1.00 | 1.00 | 1.00       | 1.00 | 1.00 |
| AdjDel/Veh:                                 | 35.7        | 25.8 | 25.8 | 76.9        | 47.2 | 47.2 | 66.7       | 0.0  | 21.4 | 26.6       | 46.3 | 46.3 |
| LOS by Move:                                | D           | C    | C    | E           | D    | D    | E          | A    | C    | C          | D    | D    |
| HCM2k95thQ:                                 | 21          | 32   | 32   | 6           | 14   | 14   | 10         | 0    | 4    | 1          | 23   | 23   |

Note: Queue reported is the number of cars per lane.

BART

Level Of Service Computation Report  
2000 HCM Operations (Future Volume Alternative)  
PM - Existing Conditions

Intersection #6: DE LA CRUZ/MARTIN [Study Int 31]

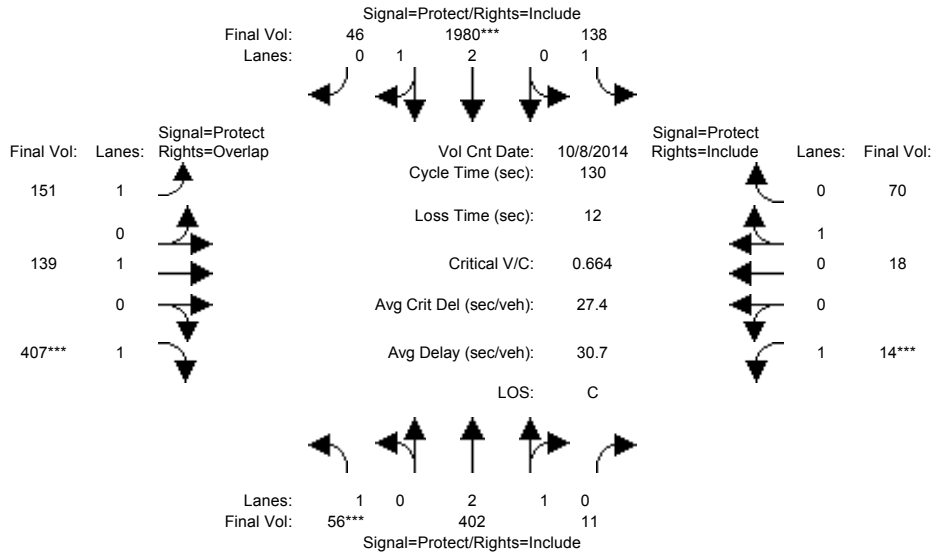

| Approach:                                   | North Bound |      |      | South Bound |      |      | East Bound |      |      | West Bound |      |      |
|---|-------------|------|------|-------------|------|------|------------|------|------|------------|------|------|
| Movement:                                   | L           | T    | R    | L           | T    | R    | L          | T    | R    | L          | T    | R    |
| Min. Green:                                 | 7           | 10   | 10   | 7           | 10   | 10   | 7          | 10   | 10   | 7          | 10   | 10   |
| Y+R:  | 4.0         | 4.0  | 4.0  | 4.0         | 4.0  | 4.0  | 4.0        | 4.0  | 4.0  | 4.0        | 4.0  | 4.0  |
| Volume Module: >> Count Date: 8 Oct 2014 << |             |      |      |             |      |      |            |      |      |            |      |      |
| Base Vol:                                   | 56          | 402  | 11   | 138         | 1980 | 46   | 151        | 139  | 407  | 14         | 18   | 70   |
| Growth Adj:                                 | 1.00        | 1.00 | 1.00 | 1.00        | 1.00 | 1.00 | 1.00       | 1.00 | 1.00 | 1.00       | 1.00 | 1.00 |
| Initial Bse:                                | 56          | 402  | 11   | 138         | 1980 | 46   | 151        | 139  | 407  | 14         | 18   | 70   |
| Added Vol:                                  | 0           | 0    | 0    | 0           | 0    | 0    | 0          | 0    | 0    | 0          | 0    | 0    |
| PasserByVol:                                | 0           | 0    | 0    | 0           | 0    | 0    | 0          | 0    | 0    | 0          | 0    | 0    |
| Initial Fut:                                | 56          | 402  | 11   | 138         | 1980 | 46   | 151        | 139  | 407  | 14         | 18   | 70   |
| User Adj:                                   | 1.00        | 1.00 | 1.00 | 1.00        | 1.00 | 1.00 | 1.00       | 1.00 | 1.00 | 1.00       | 1.00 | 1.00 |
| PHF Adj:                                    | 1.00        | 1.00 | 1.00 | 1.00        | 1.00 | 1.00 | 1.00       | 1.00 | 1.00 | 1.00       | 1.00 | 1.00 |
| PHF Volume:                                 | 56          | 402  | 11   | 138         | 1980 | 46   | 151        | 139  | 407  | 14         | 18   | 70   |
| Reduct Vol:                                 | 0           | 0    | 0    | 0           | 0    | 0    | 0          | 0    | 0    | 0          | 0    | 0    |
| Reduced Vol:                                | 56          | 402  | 11   | 138         | 1980 | 46   | 151        | 139  | 407  | 14         | 18   | 70   |
| PCE Adj:                                    | 1.00        | 1.00 | 1.00 | 1.00        | 1.00 | 1.00 | 1.00       | 1.00 | 1.00 | 1.00       | 1.00 | 1.00 |
| MLF Adj:                                    | 1.00        | 1.00 | 1.00 | 1.00        | 1.00 | 1.00 | 1.00       | 1.00 | 1.00 | 1.00       | 1.00 | 1.00 |
| Final Volume:                               | 56          | 402  | 11   | 138         | 1980 | 46   | 151        | 139  | 407  | 14         | 18   | 70   |
| Saturation Flow Module:                     |             |      |      |             |      |      |            |      |      |            |      |      |
| Sat/Lane:                                   | 1900        | 1900 | 1900 | 1900        | 1900 | 1900 | 1900       | 1900 | 1900 | 1900       | 1900 | 1900 |
| Adjustment:                                 | 0.92        | 0.98 | 0.95 | 0.92        | 0.98 | 0.95 | 0.92       | 1.00 | 0.92 | 0.92       | 0.95 | 0.95 |
| Lanes:                                      | 1.00        | 2.92 | 0.08 | 1.00        | 2.93 | 0.07 | 1.00       | 1.00 | 1.00 | 1.00       | 0.20 | 0.80 |
| Final Sat.:                                 | 1750        | 5451 | 149  | 1750        | 5473 | 127  | 1750       | 1900 | 1750 | 1750       | 368  | 1432 |
| Capacity Analysis Module:                   |             |      |      |             |      |      |            |      |      |            |      |      |
| Vol/Sat:                                    | 0.03        | 0.07 | 0.07 | 0.08        | 0.36 | 0.36 | 0.09       | 0.07 | 0.23 | 0.01       | 0.05 | 0.05 |
| Crit Moves:                                 | ****        | **** | **** | ****        | **** | **** | ****       | **** | **** | ****       | **** | **** |
| Green Time:                                 | 7.0         | 37.8 | 37.8 | 38.8        | 69.6 | 69.6 | 21.9       | 34.4 | 41.4 | 7.0        | 19.5 | 19.5 |
| Volume/Cap:                                 | 0.59        | 0.25 | 0.25 | 0.26        | 0.68 | 0.68 | 0.51       | 0.28 | 0.73 | 0.15       | 0.33 | 0.33 |
| Delay/Veh:                                  | 70.0        | 35.4 | 35.4 | 35.0        | 22.6 | 22.6 | 50.7       | 38.2 | 44.3 | 59.4       | 50.1 | 50.1 |
| User DelAdj:                                | 1.00        | 1.00 | 1.00 | 1.00        | 1.00 | 1.00 | 1.00       | 1.00 | 1.00 | 1.00       | 1.00 | 1.00 |
| AdjDel/Veh:                                 | 70.0        | 35.4 | 35.4 | 35.0        | 22.6 | 22.6 | 50.7       | 38.2 | 44.3 | 59.4       | 50.1 | 50.1 |
| LOS by Move:                                | E           | D    | D    | D           | C    | C    | D          | D    | D    | E          | D    | D    |
| HCM2k95thQ:                                 | 5           | 8    | 8    | 9           | 34   | 34   | 11         | 8    | 28   | 1          | 7    | 7    |

Note: Queue reported is the number of cars per lane.

BART

Level Of Service Computation Report  
2000 HCM Operations (Future Volume Alternative)  
AM - Existing Conditions

Intersection #7: LAFAYETTE/REED [Study Int 45]

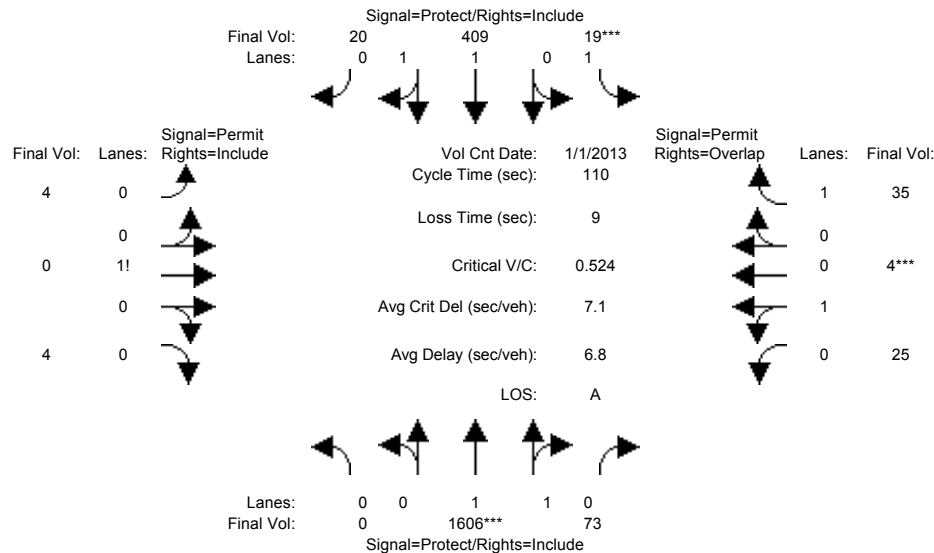

| Approach:                                   | North Bound |      |      | South Bound |      |      | East Bound |      |      | West Bound |      |      |
|---|-------------|------|------|-------------|------|------|------------|------|------|------------|------|------|
| Movement:                                   | L           | T    | R    | L           | T    | R    | L          | T    | R    | L          | T    | R    |
| Min. Green:                                 | 7           | 10   | 10   | 7           | 10   | 10   | 10         | 10   | 10   | 10         | 10   | 10   |
| Y+R:  | 4.0         | 4.0  | 4.0  | 4.0         | 4.0  | 4.0  | 4.0        | 4.0  | 4.0  | 4.0        | 4.0  | 4.0  |
| Volume Module: >> Count Date: 1 Jan 2013 << |             |      |      |             |      |      |            |      |      |            |      |      |
| Base Vol:                                   | 0           | 1606 | 73   | 19          | 409  | 20   | 4          | 0    | 4    | 25         | 4    | 35   |
| Growth Adj:                                 | 1.00        | 1.00 | 1.00 | 1.00        | 1.00 | 1.00 | 1.00       | 1.00 | 1.00 | 1.00       | 1.00 | 1.00 |
| Initial Bse:                                | 0           | 1606 | 73   | 19          | 409  | 20   | 4          | 0    | 4    | 25         | 4    | 35   |
| Added Vol:                                  | 0           | 0    | 0    | 0           | 0    | 0    | 0          | 0    | 0    | 0          | 0    | 0    |
| PasserByVol:                                | 0           | 0    | 0    | 0           | 0    | 0    | 0          | 0    | 0    | 0          | 0    | 0    |
| Initial Fut:                                | 0           | 1606 | 73   | 19          | 409  | 20   | 4          | 0    | 4    | 25         | 4    | 35   |
| User Adj:                                   | 1.00        | 1.00 | 1.00 | 1.00        | 1.00 | 1.00 | 1.00       | 1.00 | 1.00 | 1.00       | 1.00 | 1.00 |
| PHF Adj:                                    | 1.00        | 1.00 | 1.00 | 1.00        | 1.00 | 1.00 | 1.00       | 1.00 | 1.00 | 1.00       | 1.00 | 1.00 |
| PHF Volume:                                 | 0           | 1606 | 73   | 19          | 409  | 20   | 4          | 0    | 4    | 25         | 4    | 35   |
| Reduct Vol:                                 | 0           | 0    | 0    | 0           | 0    | 0    | 0          | 0    | 0    | 0          | 0    | 0    |
| Reduced Vol:                                | 0           | 1606 | 73   | 19          | 409  | 20   | 4          | 0    | 4    | 25         | 4    | 35   |
| PCE Adj:                                    | 1.00        | 1.00 | 1.00 | 1.00        | 1.00 | 1.00 | 1.00       | 1.00 | 1.00 | 1.00       | 1.00 | 1.00 |
| MLF Adj:                                    | 1.00        | 1.00 | 1.00 | 1.00        | 1.00 | 1.00 | 1.00       | 1.00 | 1.00 | 1.00       | 1.00 | 1.00 |
| Final Volume:                               | 0           | 1606 | 73   | 19          | 409  | 20   | 4          | 0    | 4    | 25         | 4    | 35   |
| Saturation Flow Module:                     |             |      |      |             |      |      |            |      |      |            |      |      |
| Sat/Lane:                                   | 1900        | 1900 | 1900 | 1900        | 1900 | 1900 | 1900       | 1900 | 1900 | 1900       | 1900 | 1900 |
| Adjustment:                                 | 0.92        | 0.97 | 0.95 | 0.92        | 0.97 | 0.95 | 0.92       | 0.92 | 0.92 | 0.95       | 0.95 | 0.92 |
| Lanes:                                      | 0.00        | 1.91 | 0.09 | 1.00        | 1.90 | 0.10 | 0.50       | 0.00 | 0.50 | 0.86       | 0.14 | 1.00 |
| Final Sat.:                                 | 0           | 3539 | 161  | 1750        | 3527 | 172  | 875        | 0    | 875  | 1552       | 248  | 1750 |
| Capacity Analysis Module:                   |             |      |      |             |      |      |            |      |      |            |      |      |
| Vol/Sat:                                    | 0.00        | 0.45 | 0.45 | 0.01        | 0.12 | 0.12 | 0.00       | 0.00 | 0.00 | 0.02       | 0.02 | 0.02 |
| Crit Moves:                                 | ****        | **** | **** | ****        | **** | **** | ****       | **** | **** | ****       | **** | **** |
| Green Time:                                 | 0.0         | 84.0 | 84.0 | 7.0         | 91.0 | 91.0 | 10.0       | 0.0  | 10.0 | 10.0       | 10.0 | 17.0 |
| Volume/Cap:                                 | 0.00        | 0.59 | 0.59 | 0.17        | 0.14 | 0.14 | 0.05       | 0.00 | 0.05 | 0.18       | 0.18 | 0.13 |
| Delay/Veh:                                  | 0.0         | 6.0  | 6.0  | 49.5        | 1.9  | 1.9  | 45.8       | 0.0  | 45.8 | 46.7       | 46.7 | 40.3 |
| User DelAdj:                                | 1.00        | 1.00 | 1.00 | 1.00        | 1.00 | 1.00 | 1.00       | 1.00 | 1.00 | 1.00       | 1.00 | 1.00 |
| AdjDel/Veh:                                 | 0.0         | 6.0  | 6.0  | 49.5        | 1.9  | 1.9  | 45.8       | 0.0  | 45.8 | 46.7       | 46.7 | 40.3 |
| LOS by Move:                                | A           | A    | A    | D           | A    | A    | D          | A    | D    | D          | D    | D    |
| HCM2k95thQ:                                 | 0           | 23   | 23   | 1           | 3    | 3    | 1          | 0    | 1    | 2          | 2    | 2    |

Note: Queue reported is the number of cars per lane.

BART

Level Of Service Computation Report  
 2000 HCM Operations (Future Volume Alternative)  
 PM - Existing Conditions

Intersection #7: LAFAYETTE/REED [Study Int 45]

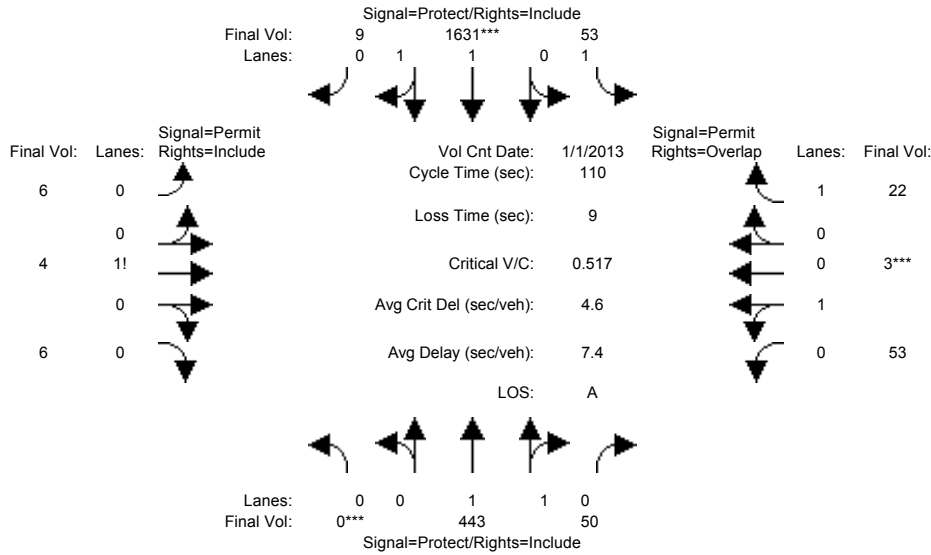

| Approach:                                   | North Bound |      |      | South Bound |      |      | East Bound |      |      | West Bound |      |      |
|---|-------------|------|------|-------------|------|------|------------|------|------|------------|------|------|
| Movement:                                   | L           | T    | R    | L           | T    | R    | L          | T    | R    | L          | T    | R    |
| Min. Green:                                 | 7           | 10   | 10   | 7           | 10   | 10   | 10         | 10   | 10   | 10         | 10   | 10   |
| Y+R:  | 4.0         | 4.0  | 4.0  | 4.0         | 4.0  | 4.0  | 4.0        | 4.0  | 4.0  | 4.0        | 4.0  | 4.0  |
| -----                                       |             |      |      |             |      |      |            |      |      |            |      |      |
| Volume Module: >> Count Date: 1 Jan 2013 << |             |      |      |             |      |      |            |      |      |            |      |      |
| Base Vol:                                   | 0           | 443  | 50   | 53          | 1631 | 9    | 6          | 4    | 6    | 53         | 3    | 22   |
| Growth Adj:                                 | 1.00        | 1.00 | 1.00 | 1.00        | 1.00 | 1.00 | 1.00       | 1.00 | 1.00 | 1.00       | 1.00 | 1.00 |
| Initial Bse:                                | 0           | 443  | 50   | 53          | 1631 | 9    | 6          | 4    | 6    | 53         | 3    | 22   |
| Added Vol:                                  | 0           | 0    | 0    | 0           | 0    | 0    | 0          | 0    | 0    | 0          | 0    | 0    |
| PasserByVol:                                | 0           | 0    | 0    | 0           | 0    | 0    | 0          | 0    | 0    | 0          | 0    | 0    |
| Initial Fut:                                | 0           | 443  | 50   | 53          | 1631 | 9    | 6          | 4    | 6    | 53         | 3    | 22   |
| User Adj:                                   | 1.00        | 1.00 | 1.00 | 1.00        | 1.00 | 1.00 | 1.00       | 1.00 | 1.00 | 1.00       | 1.00 | 1.00 |
| PHF Adj:                                    | 1.00        | 1.00 | 1.00 | 1.00        | 1.00 | 1.00 | 1.00       | 1.00 | 1.00 | 1.00       | 1.00 | 1.00 |
| PHF Volume:                                 | 0           | 443  | 50   | 53          | 1631 | 9    | 6          | 4    | 6    | 53         | 3    | 22   |
| Reduct Vol:                                 | 0           | 0    | 0    | 0           | 0    | 0    | 0          | 0    | 0    | 0          | 0    | 0    |
| Reduced Vol:                                | 0           | 443  | 50   | 53          | 1631 | 9    | 6          | 4    | 6    | 53         | 3    | 22   |
| PCE Adj:                                    | 1.00        | 1.00 | 1.00 | 1.00        | 1.00 | 1.00 | 1.00       | 1.00 | 1.00 | 1.00       | 1.00 | 1.00 |
| MLF Adj:                                    | 1.00        | 1.00 | 1.00 | 1.00        | 1.00 | 1.00 | 1.00       | 1.00 | 1.00 | 1.00       | 1.00 | 1.00 |
| FinalVolume:                                | 0           | 443  | 50   | 53          | 1631 | 9    | 6          | 4    | 6    | 53         | 3    | 22   |
| -----                                       |             |      |      |             |      |      |            |      |      |            |      |      |
| Saturation Flow Module:                     |             |      |      |             |      |      |            |      |      |            |      |      |
| Sat/Lane:                                   | 1900        | 1900 | 1900 | 1900        | 1900 | 1900 | 1900       | 1900 | 1900 | 1900       | 1900 | 1900 |
| Adjustment:                                 | 0.92        | 0.98 | 0.95 | 0.92        | 0.97 | 0.95 | 0.92       | 0.92 | 0.92 | 0.95       | 0.95 | 0.92 |
| Lanes:                                      | 0.00        | 1.79 | 0.21 | 1.00        | 1.99 | 0.01 | 0.37       | 0.25 | 0.38 | 0.95       | 0.05 | 1.00 |
| Final Sat.:                                 | 0           | 3324 | 375  | 1750        | 3680 | 20   | 656        | 438  | 656  | 1704       | 96   | 1750 |
| -----                                       |             |      |      |             |      |      |            |      |      |            |      |      |
| Capacity Analysis Module:                   |             |      |      |             |      |      |            |      |      |            |      |      |
| Vol/Sat:                                    | 0.00        | 0.13 | 0.13 | 0.03        | 0.44 | 0.44 | 0.01       | 0.01 | 0.01 | 0.03       | 0.03 | 0.01 |
| Crit Moves:                                 | ****        |      |      | ****        |      |      |            |      |      | ****       |      |      |
| Green Time:                                 | 0.0         | 61.6 | 61.6 | 29.4        | 91.0 | 91.0 | 10.0       | 10.0 | 10.0 | 10.0       | 10.0 | 39.4 |
| Volume/Cap:                                 | 0.00        | 0.24 | 0.24 | 0.11        | 0.54 | 0.54 | 0.10       | 0.10 | 0.10 | 0.34       | 0.34 | 0.04 |
| Delay/Veh:                                  | 0.0         | 12.4 | 12.4 | 30.6        | 3.1  | 3.1  | 46.2       | 46.2 | 46.2 | 48.2       | 48.2 | 23.0 |
| User DelAdj:                                | 1.00        | 1.00 | 1.00 | 1.00        | 1.00 | 1.00 | 1.00       | 1.00 | 1.00 | 1.00       | 1.00 | 1.00 |
| AdjDel/Veh:                                 | 0.0         | 12.4 | 12.4 | 30.6        | 3.1  | 3.1  | 46.2       | 46.2 | 46.2 | 48.2       | 48.2 | 23.0 |
| LOS by Move:                                | A           | B    | B    | C           | A    | A    | D          | D    | D    | D          | D    | C    |
| HCM2k95thQ:                                 | 0           | 8    | 8    | 3           | 17   | 17   | 1          | 1    | 1    | 4          | 4    | 1    |

Note: Queue reported is the number of cars per lane.

BART

Level Of Service Computation Report  
 2000 HCM Operations (Future Volume Alternative)  
 AM - Existing Conditions

Intersection #9: Coleman/Brokaw [Study Int 33]

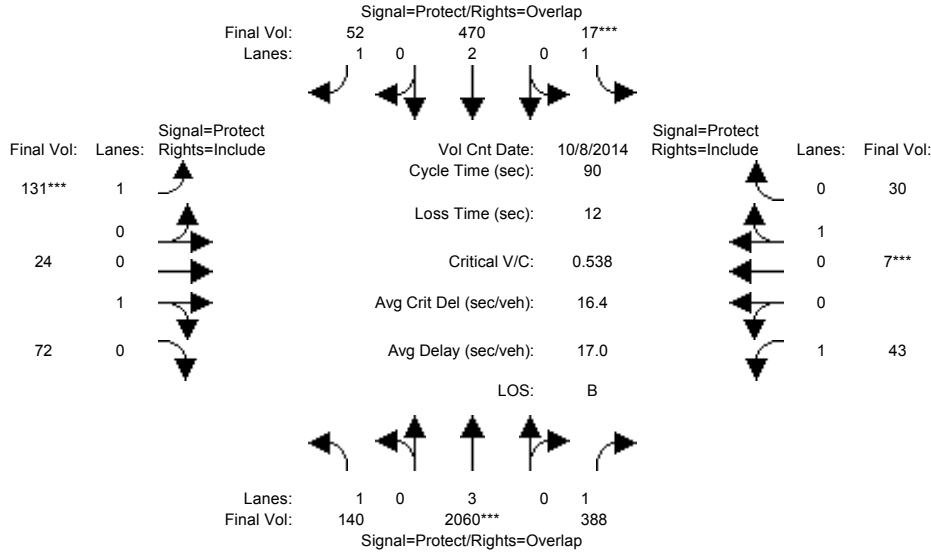

| Approach:                                   | North Bound |      |      | South Bound |      |      | East Bound |      |      | West Bound |      |      |
|---|-------------|------|------|-------------|------|------|------------|------|------|------------|------|------|
| Movement:                                   | L           | T    | R    | L           | T    | R    | L          | T    | R    | L          | T    | R    |
| Min. Green:                                 | 7           | 10   | 10   | 7           | 10   | 10   | 7          | 10   | 10   | 7          | 10   | 10   |
| Y+R:  | 4.0         | 4.0  | 4.0  | 4.0         | 4.0  | 4.0  | 4.0        | 4.0  | 4.0  | 4.0        | 4.0  | 4.0  |
| Volume Module: >> Count Date: 8 Oct 2014 << |             |      |      |             |      |      |            |      |      |            |      |      |
| Base Vol:                                   | 140         | 2060 | 388  | 17          | 470  | 52   | 131        | 24   | 72   | 43         | 7    | 30   |
| Growth Adj:                                 | 1.00        | 1.00 | 1.00 | 1.00        | 1.00 | 1.00 | 1.00       | 1.00 | 1.00 | 1.00       | 1.00 | 1.00 |
| Initial Bse:                                | 140         | 2060 | 388  | 17          | 470  | 52   | 131        | 24   | 72   | 43         | 7    | 30   |
| Added Vol:                                  | 0           | 0    | 0    | 0           | 0    | 0    | 0          | 0    | 0    | 0          | 0    | 0    |
| PasserByVol:                                | 0           | 0    | 0    | 0           | 0    | 0    | 0          | 0    | 0    | 0          | 0    | 0    |
| Initial Fut:                                | 140         | 2060 | 388  | 17          | 470  | 52   | 131        | 24   | 72   | 43         | 7    | 30   |
| User Adj:                                   | 1.00        | 1.00 | 1.00 | 1.00        | 1.00 | 1.00 | 1.00       | 1.00 | 1.00 | 1.00       | 1.00 | 1.00 |
| PHF Adj:                                    | 1.00        | 1.00 | 1.00 | 1.00        | 1.00 | 1.00 | 1.00       | 1.00 | 1.00 | 1.00       | 1.00 | 1.00 |
| PHF Volume:                                 | 140         | 2060 | 388  | 17          | 470  | 52   | 131        | 24   | 72   | 43         | 7    | 30   |
| Reduct Vol:                                 | 0           | 0    | 0    | 0           | 0    | 0    | 0          | 0    | 0    | 0          | 0    | 0    |
| Reduced Vol:                                | 140         | 2060 | 388  | 17          | 470  | 52   | 131        | 24   | 72   | 43         | 7    | 30   |
| PCE Adj:                                    | 1.00        | 1.00 | 1.00 | 1.00        | 1.00 | 1.00 | 1.00       | 1.00 | 1.00 | 1.00       | 1.00 | 1.00 |
| MLF Adj:                                    | 1.00        | 1.00 | 1.00 | 1.00        | 1.00 | 1.00 | 1.00       | 1.00 | 1.00 | 1.00       | 1.00 | 1.00 |
| Final Volume:                               | 140         | 2060 | 388  | 17          | 470  | 52   | 131        | 24   | 72   | 43         | 7    | 30   |
| Saturation Flow Module:                     |             |      |      |             |      |      |            |      |      |            |      |      |
| Sat/Lane:                                   | 1900        | 1900 | 1900 | 1900        | 1900 | 1900 | 1900       | 1900 | 1900 | 1900       | 1900 | 1900 |
| Adjustment:                                 | 0.92        | 1.00 | 0.92 | 0.92        | 1.00 | 0.92 | 0.92       | 0.95 | 0.95 | 0.92       | 0.95 | 0.95 |
| Lanes:                                      | 1.00        | 3.00 | 1.00 | 1.00        | 2.00 | 1.00 | 1.00       | 0.25 | 0.75 | 1.00       | 0.19 | 0.81 |
| Final Sat.:                                 | 1750        | 5700 | 1750 | 1750        | 3800 | 1750 | 1750       | 450  | 1350 | 1750       | 341  | 1459 |
| Capacity Analysis Module:                   |             |      |      |             |      |      |            |      |      |            |      |      |
| Vol/Sat:                                    | 0.08        | 0.36 | 0.22 | 0.01        | 0.12 | 0.03 | 0.07       | 0.05 | 0.05 | 0.02       | 0.02 | 0.02 |
| Crit Moves:                                 | ****        | **** | **** | ****        | **** | **** | ****       | **** | **** | ****       | **** | **** |
| Green Time:                                 | 22.6        | 50.5 | 59.0 | 7.0         | 34.9 | 45.4 | 10.5       | 12.0 | 12.0 | 8.4        | 10.0 | 10.0 |
| Volume/Cap:                                 | 0.32        | 0.64 | 0.34 | 0.12        | 0.32 | 0.06 | 0.64       | 0.40 | 0.40 | 0.26       | 0.19 | 0.19 |
| Delay/Veh:                                  | 27.9        | 14.0 | 7.1  | 39.1        | 19.3 | 11.4 | 44.9       | 36.8 | 36.8 | 38.8       | 36.8 | 36.8 |
| User DelAdj:                                | 1.00        | 1.00 | 1.00 | 1.00        | 1.00 | 1.00 | 1.00       | 1.00 | 1.00 | 1.00       | 1.00 | 1.00 |
| AdjDel/Veh:                                 | 27.9        | 14.0 | 7.1  | 39.1        | 19.3 | 11.4 | 44.9       | 36.8 | 36.8 | 38.8       | 36.8 | 36.8 |
| LOS by Move:                                | C           | B    | A    | D           | B    | B    | D          | D    | D    | D          | D    | D    |
| HCM2k95thQ:                                 | 6           | 22   | 9    | 1           | 9    | 2    | 10         | 6    | 6    | 2          | 2    | 2    |

Note: Queue reported is the number of cars per lane.



BART

Level Of Service Computation Report  
 2000 HCM Operations (Future Volume Alternative)  
 PM - Existing Conditions

Intersection #9: Coleman/Brokaw [Study Int 33]

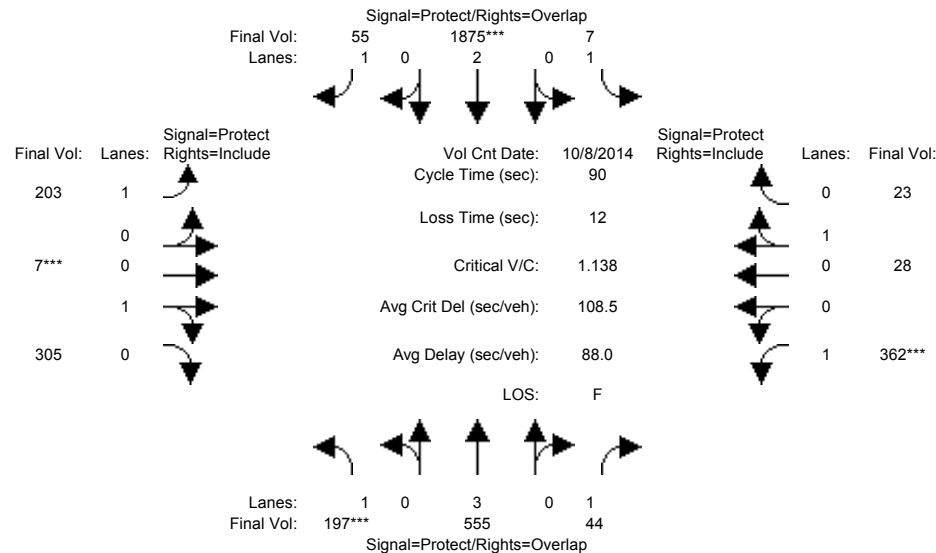

| Approach:                                   | North Bound |      |      | South Bound |      |      | East Bound |      |       | West Bound |      |      |
|---|-------------|------|------|-------------|------|------|------------|------|-------|------------|------|------|
| Movement:                                   | L           | T    | R    | L           | T    | R    | L          | T    | R     | L          | T    | R    |
| Min. Green:                                 | 7           | 10   | 10   | 7           | 10   | 10   | 7          | 10   | 10    | 7          | 10   | 10   |
| Y+R:  | 4.0         | 4.0  | 4.0  | 4.0         | 4.0  | 4.0  | 4.0        | 4.0  | 4.0   | 4.0        | 4.0  | 4.0  |
| Volume Module: >> Count Date: 8 Oct 2014 << |             |      |      |             |      |      |            |      |       |            |      |      |
| Base Vol:                                   | 197         | 555  | 44   | 7           | 1875 | 55   | 203        | 7    | 305   | 362        | 28   | 23   |
| Growth Adj:                                 | 1.00        | 1.00 | 1.00 | 1.00        | 1.00 | 1.00 | 1.00       | 1.00 | 1.00  | 1.00       | 1.00 | 1.00 |
| Initial Bse:                                | 197         | 555  | 44   | 7           | 1875 | 55   | 203        | 7    | 305   | 362        | 28   | 23   |
| Added Vol:                                  | 0           | 0    | 0    | 0           | 0    | 0    | 0          | 0    | 0     | 0          | 0    | 0    |
| PasserByVol:                                | 0           | 0    | 0    | 0           | 0    | 0    | 0          | 0    | 0     | 0          | 0    | 0    |
| Initial Fut:                                | 197         | 555  | 44   | 7           | 1875 | 55   | 203        | 7    | 305   | 362        | 28   | 23   |
| User Adj:                                   | 1.00        | 1.00 | 1.00 | 1.00        | 1.00 | 1.00 | 1.00       | 1.00 | 1.00  | 1.00       | 1.00 | 1.00 |
| PHF Adj:                                    | 1.00        | 1.00 | 1.00 | 1.00        | 1.00 | 1.00 | 1.00       | 1.00 | 1.00  | 1.00       | 1.00 | 1.00 |
| PHF Volume:                                 | 197         | 555  | 44   | 7           | 1875 | 55   | 203        | 7    | 305   | 362        | 28   | 23   |
| Reduct Vol:                                 | 0           | 0    | 0    | 0           | 0    | 0    | 0          | 0    | 0     | 0          | 0    | 0    |
| Reduced Vol:                                | 197         | 555  | 44   | 7           | 1875 | 55   | 203        | 7    | 305   | 362        | 28   | 23   |
| PCE Adj:                                    | 1.00        | 1.00 | 1.00 | 1.00        | 1.00 | 1.00 | 1.00       | 1.00 | 1.00  | 1.00       | 1.00 | 1.00 |
| MLF Adj:                                    | 1.00        | 1.00 | 1.00 | 1.00        | 1.00 | 1.00 | 1.00       | 1.00 | 1.00  | 1.00       | 1.00 | 1.00 |
| FinalVolume:                                | 197         | 555  | 44   | 7           | 1875 | 55   | 203        | 7    | 305   | 362        | 28   | 23   |
| Saturation Flow Module:                     |             |      |      |             |      |      |            |      |       |            |      |      |
| Sat/Lane:                                   | 1900        | 1900 | 1900 | 1900        | 1900 | 1900 | 1900       | 1900 | 1900  | 1900       | 1900 | 1900 |
| Adjustment:                                 | 0.92        | 1.00 | 0.92 | 0.92        | 1.00 | 0.92 | 0.92       | 0.95 | 0.95  | 0.92       | 0.95 | 0.95 |
| Lanes:                                      | 1.00        | 3.00 | 1.00 | 1.00        | 2.00 | 1.00 | 1.00       | 0.02 | 0.98  | 1.00       | 0.55 | 0.45 |
| Final Sat.:                                 | 1750        | 5700 | 1750 | 1750        | 3800 | 1750 | 1750       | 40   | 1760  | 1750       | 988  | 812  |
| Capacity Analysis Module:                   |             |      |      |             |      |      |            |      |       |            |      |      |
| Vol/Sat:                                    | 0.11        | 0.10 | 0.03 | 0.00        | 0.49 | 0.03 | 0.12       | 0.17 | 0.17  | 0.21       | 0.03 | 0.03 |
| Crit Moves:                                 | ****        | **** | **** | ****        | **** | **** | ****       | **** | ****  | ****       | **** | **** |
| Green Time:                                 | 8.9         | 28.2 | 44.6 | 19.7        | 39.0 | 54.4 | 15.4       | 13.7 | 13.7  | 16.4       | 14.7 | 14.7 |
| Volume/Cap:                                 | 1.14        | 0.31 | 0.05 | 0.02        | 1.14 | 0.05 | 0.68       | 1.14 | 1.14  | 1.14       | 0.17 | 0.17 |
| Delay/Veh:                                  | 150.9       | 23.6 | 11.8 | 27.6        | 95.5 | 7.3  | 41.2       | 135  | 134.9 | 130.0      | 32.7 | 32.7 |
| User DelAdj:                                | 1.00        | 1.00 | 1.00 | 1.00        | 1.00 | 1.00 | 1.00       | 1.00 | 1.00  | 1.00       | 1.00 | 1.00 |
| AdjDel/Veh:                                 | 150.9       | 23.6 | 11.8 | 27.6        | 95.5 | 7.3  | 41.2       | 135  | 134.9 | 130.0      | 32.7 | 32.7 |
| LOS by Move:                                | F           | C    | B    | C           | F    | A    | D          | F    | F     | F          | C    | C    |
| HCM2k95thQ:                                 | 18          | 7    | 1    | 0           | 65   | 1    | 13         | 30   | 30    | 31         | 3    | 3    |

Note: Queue reported is the number of cars per lane.

BART

Level Of Service Computation Report  
 2000 HCM Operations (Future Volume Alternative)  
 AM - Existing Conditions

Intersection #106: Benton/E/ Camino Real [Study Int 52]

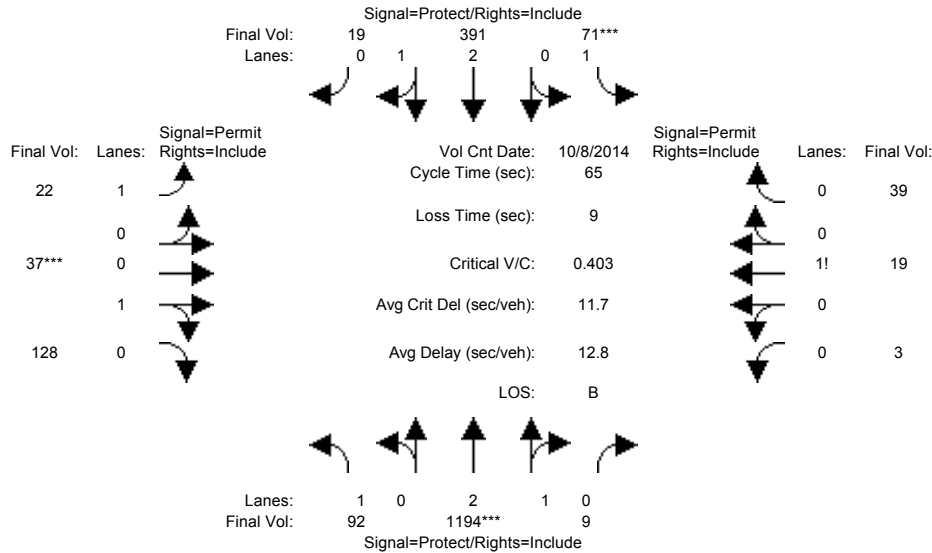

| Approach:                 | North Bound                  |      |      | South Bound |      |      | East Bound |      |      | West Bound |      |      |
|---------------------------|------------------------------|------|------|-------------|------|------|------------|------|------|------------|------|------|
| Movement:                 | L                            | T    | R    | L           | T    | R    | L          | T    | R    | L          | T    | R    |
| Min. Green:               | 7                            | 10   | 10   | 7           | 10   | 10   | 10         | 10   | 10   | 10         | 10   | 10   |
| Y+R:                      | 4.0                          | 4.0  | 4.0  | 4.0         | 4.0  | 4.0  | 4.0        | 4.0  | 4.0  | 4.0        | 4.0  | 4.0  |
| -----                     |                              |      |      |             |      |      |            |      |      |            |      |      |
| Volume Module:            | >> Count Date: 8 Oct 2014 << |      |      |             |      |      |            |      |      |            |      |      |
| Base Vol:                 | 92                           | 1194 | 9    | 71          | 391  | 19   | 22         | 37   | 128  | 3          | 19   | 39   |
| Growth Adj:               | 1.00                         | 1.00 | 1.00 | 1.00        | 1.00 | 1.00 | 1.00       | 1.00 | 1.00 | 1.00       | 1.00 | 1.00 |
| Initial Bse:              | 92                           | 1194 | 9    | 71          | 391  | 19   | 22         | 37   | 128  | 3          | 19   | 39   |
| Added Vol:                | 0                            | 0    | 0    | 0           | 0    | 0    | 0          | 0    | 0    | 0          | 0    | 0    |
| PasserByVol:              | 0                            | 0    | 0    | 0           | 0    | 0    | 0          | 0    | 0    | 0          | 0    | 0    |
| Initial Fut:              | 92                           | 1194 | 9    | 71          | 391  | 19   | 22         | 37   | 128  | 3          | 19   | 39   |
| User Adj:                 | 1.00                         | 1.00 | 1.00 | 1.00        | 1.00 | 1.00 | 1.00       | 1.00 | 1.00 | 1.00       | 1.00 | 1.00 |
| PHF Adj:                  | 1.00                         | 1.00 | 1.00 | 1.00        | 1.00 | 1.00 | 1.00       | 1.00 | 1.00 | 1.00       | 1.00 | 1.00 |
| PHF Volume:               | 92                           | 1194 | 9    | 71          | 391  | 19   | 22         | 37   | 128  | 3          | 19   | 39   |
| Reduct Vol:               | 0                            | 0    | 0    | 0           | 0    | 0    | 0          | 0    | 0    | 0          | 0    | 0    |
| Reduced Vol:              | 92                           | 1194 | 9    | 71          | 391  | 19   | 22         | 37   | 128  | 3          | 19   | 39   |
| PCE Adj:                  | 1.00                         | 1.00 | 1.00 | 1.00        | 1.00 | 1.00 | 1.00       | 1.00 | 1.00 | 1.00       | 1.00 | 1.00 |
| MLF Adj:                  | 1.00                         | 1.00 | 1.00 | 1.00        | 1.00 | 1.00 | 1.00       | 1.00 | 1.00 | 1.00       | 1.00 | 1.00 |
| Final Volume:             | 92                           | 1194 | 9    | 71          | 391  | 19   | 22         | 37   | 128  | 3          | 19   | 39   |
| -----                     |                              |      |      |             |      |      |            |      |      |            |      |      |
| Saturation Flow Module:   |                              |      |      |             |      |      |            |      |      |            |      |      |
| Sat/Lane:                 | 1900                         | 1900 | 1900 | 1900        | 1900 | 1900 | 1900       | 1900 | 1900 | 1900       | 1900 | 1900 |
| Adjustment:               | 0.92                         | 0.98 | 0.95 | 0.92        | 0.98 | 0.95 | 0.92       | 0.95 | 0.95 | 0.92       | 0.92 | 0.92 |
| Lanes:                    | 1.00                         | 2.98 | 0.02 | 1.00        | 2.86 | 0.14 | 1.00       | 0.22 | 0.78 | 0.05       | 0.31 | 0.64 |
| Final Sat.:               | 1750                         | 5558 | 42   | 1750        | 5340 | 259  | 1750       | 404  | 1396 | 86         | 545  | 1119 |
| -----                     |                              |      |      |             |      |      |            |      |      |            |      |      |
| Capacity Analysis Module: |                              |      |      |             |      |      |            |      |      |            |      |      |
| Vol/Sat:                  | 0.05                         | 0.21 | 0.21 | 0.04        | 0.07 | 0.07 | 0.01       | 0.09 | 0.09 | 0.03       | 0.03 | 0.03 |
| Crit Moves:               | ****                         |      |      | ****        |      |      | ****       |      |      | ****       |      |      |
| Green Time:               | 17.0                         | 34.3 | 34.3 | 7.0         | 24.3 | 24.3 | 14.7       | 14.7 | 14.7 | 14.7       | 14.7 | 14.7 |
| Volume/Cap:               | 0.20                         | 0.41 | 0.41 | 0.38        | 0.20 | 0.20 | 0.06       | 0.41 | 0.41 | 0.15       | 0.15 | 0.15 |
| Delay/Veh:                | 18.9                         | 9.3  | 9.3  | 28.2        | 13.8 | 13.8 | 19.8       | 22.1 | 22.1 | 20.4       | 20.4 | 20.4 |
| User DelAdj:              | 1.00                         | 1.00 | 1.00 | 1.00        | 1.00 | 1.00 | 1.00       | 1.00 | 1.00 | 1.00       | 1.00 | 1.00 |
| AdjDel/Veh:               | 18.9                         | 9.3  | 9.3  | 28.2        | 13.8 | 13.8 | 19.8       | 22.1 | 22.1 | 20.4       | 20.4 | 20.4 |
| LOS by Move:              | B                            | A    | A    | C           | B    | B    | C          | C    | C    | C          | C    | C    |
| HCM2k95thQ:               | 3                            | 9    | 9    | 3           | 4    | 4    | 1          | 6    | 6    | 2          | 2    | 2    |

Note: Queue reported is the number of cars per lane.

BART

Level Of Service Computation Report  
2000 HCM Operations (Future Volume Alternative)  
PM - Existing Conditions

Intersection #106: Benton/EI Camino Real [Study Int 52]

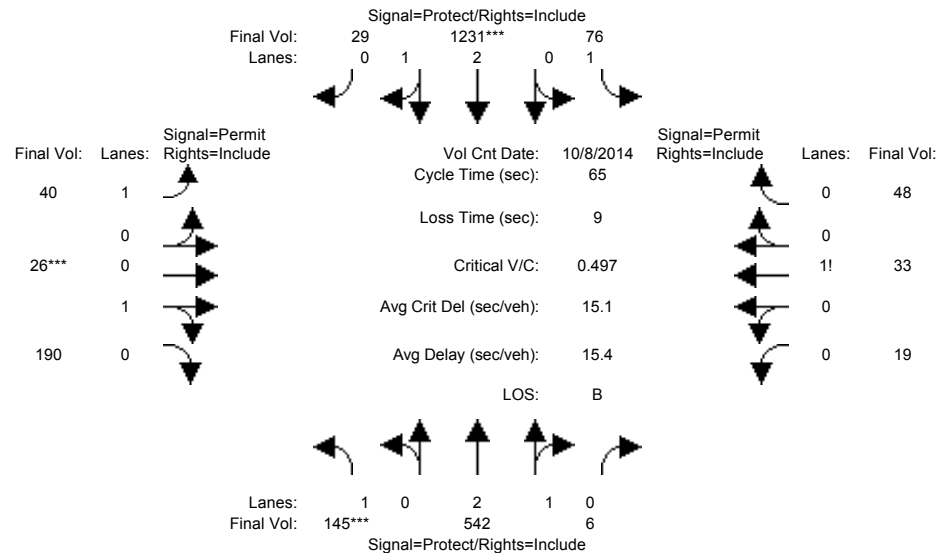

| Approach:                                   | North Bound |      |      | South Bound |      |      | East Bound |      |      | West Bound |      |      |
|---|-------------|------|------|-------------|------|------|------------|------|------|------------|------|------|
| Movement:                                   | L           | T    | R    | L           | T    | R    | L          | T    | R    | L          | T    | R    |
| Min. Green:                                 | 7           | 10   | 10   | 7           | 10   | 10   | 10         | 10   | 10   | 10         | 10   | 10   |
| Y+R:  | 4.0         | 4.0  | 4.0  | 4.0         | 4.0  | 4.0  | 4.0        | 4.0  | 4.0  | 4.0        | 4.0  | 4.0  |
| Volume Module: >> Count Date: 8 Oct 2014 << |             |      |      |             |      |      |            |      |      |            |      |      |
| Base Vol:                                   | 145         | 542  | 6    | 76          | 1231 | 29   | 40         | 26   | 190  | 19         | 33   | 48   |
| Growth Adj:                                 | 1.00        | 1.00 | 1.00 | 1.00        | 1.00 | 1.00 | 1.00       | 1.00 | 1.00 | 1.00       | 1.00 | 1.00 |
| Initial Bse:                                | 145         | 542  | 6    | 76          | 1231 | 29   | 40         | 26   | 190  | 19         | 33   | 48   |
| Added Vol:                                  | 0           | 0    | 0    | 0           | 0    | 0    | 0          | 0    | 0    | 0          | 0    | 0    |
| PasserByVol:                                | 0           | 0    | 0    | 0           | 0    | 0    | 0          | 0    | 0    | 0          | 0    | 0    |
| Initial Fut:                                | 145         | 542  | 6    | 76          | 1231 | 29   | 40         | 26   | 190  | 19         | 33   | 48   |
| User Adj:                                   | 1.00        | 1.00 | 1.00 | 1.00        | 1.00 | 1.00 | 1.00       | 1.00 | 1.00 | 1.00       | 1.00 | 1.00 |
| PHF Adj:                                    | 1.00        | 1.00 | 1.00 | 1.00        | 1.00 | 1.00 | 1.00       | 1.00 | 1.00 | 1.00       | 1.00 | 1.00 |
| PHF Volume:                                 | 145         | 542  | 6    | 76          | 1231 | 29   | 40         | 26   | 190  | 19         | 33   | 48   |
| Reduct Vol:                                 | 0           | 0    | 0    | 0           | 0    | 0    | 0          | 0    | 0    | 0          | 0    | 0    |
| Reduced Vol:                                | 145         | 542  | 6    | 76          | 1231 | 29   | 40         | 26   | 190  | 19         | 33   | 48   |
| PCE Adj:                                    | 1.00        | 1.00 | 1.00 | 1.00        | 1.00 | 1.00 | 1.00       | 1.00 | 1.00 | 1.00       | 1.00 | 1.00 |
| MLF Adj:                                    | 1.00        | 1.00 | 1.00 | 1.00        | 1.00 | 1.00 | 1.00       | 1.00 | 1.00 | 1.00       | 1.00 | 1.00 |
| Final Volume:                               | 145         | 542  | 6    | 76          | 1231 | 29   | 40         | 26   | 190  | 19         | 33   | 48   |
| Saturation Flow Module:                     |             |      |      |             |      |      |            |      |      |            |      |      |
| Sat/Lane:                                   | 1900        | 1900 | 1900 | 1900        | 1900 | 1900 | 1900       | 1900 | 1900 | 1900       | 1900 | 1900 |
| Adjustment:                                 | 0.92        | 0.98 | 0.95 | 0.92        | 0.98 | 0.95 | 0.92       | 0.95 | 0.95 | 0.92       | 0.92 | 0.92 |
| Lanes:                                      | 1.00        | 2.97 | 0.03 | 1.00        | 2.93 | 0.07 | 1.00       | 0.12 | 0.88 | 0.19       | 0.33 | 0.48 |
| Final Sat.:                                 | 1750        | 5539 | 61   | 1750        | 5471 | 129  | 1750       | 217  | 1583 | 333        | 578  | 840  |
| Capacity Analysis Module:                   |             |      |      |             |      |      |            |      |      |            |      |      |
| Vol/Sat:                                    | 0.08        | 0.10 | 0.10 | 0.04        | 0.23 | 0.23 | 0.02       | 0.12 | 0.12 | 0.06       | 0.06 | 0.06 |
| Crit Moves:                                 | ****        |      |      | ****        |      |      | ****       |      |      |            |      |      |
| Green Time:                                 | 10.8        | 23.7 | 23.7 | 16.6        | 29.4 | 29.4 | 15.7       | 15.7 | 15.7 | 15.7       | 15.7 | 15.7 |
| Volume/Cap:                                 | 0.50        | 0.27 | 0.27 | 0.17        | 0.50 | 0.50 | 0.09       | 0.50 | 0.50 | 0.24       | 0.24 | 0.24 |
| Delay/Veh:                                  | 25.9        | 14.6 | 14.6 | 19.0        | 12.7 | 12.7 | 19.2       | 22.1 | 22.1 | 20.1       | 20.1 | 20.1 |
| User DelAdj:                                | 1.00        | 1.00 | 1.00 | 1.00        | 1.00 | 1.00 | 1.00       | 1.00 | 1.00 | 1.00       | 1.00 | 1.00 |
| AdjDel/Veh:                                 | 25.9        | 14.6 | 14.6 | 19.0        | 12.7 | 12.7 | 19.2       | 22.1 | 22.1 | 20.1       | 20.1 | 20.1 |
| LOS by Move:                                | C           | B    | B    | B           | B    | B    | B          | C    | C    | C          | C    | C    |
| HCM2k95thQ:                                 | 6           | 5    | 5    | 3           | 11   | 11   | 1          | 8    | 8    | 4          | 4    | 4    |

Note: Queue reported is the number of cars per lane.

BART

Level Of Service Computation Report  
2000 HCM Operations (Future Volume Alternative)  
AM - Existing Conditions

Intersection #107: Lafayette/Benton [Study Int 49]

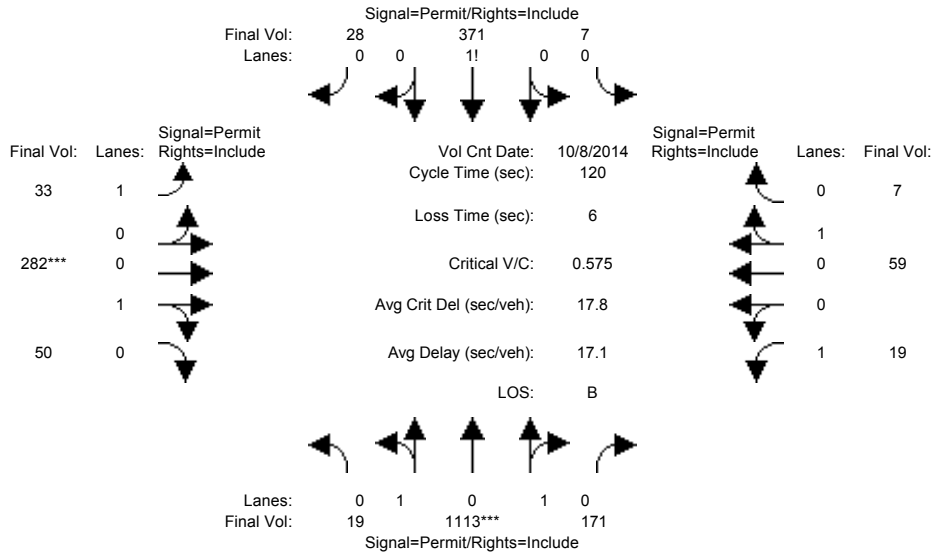

| Approach:                                   | North Bound |      |      | South Bound |      |      | East Bound |      |      | West Bound |      |      |
|---|-------------|------|------|-------------|------|------|------------|------|------|------------|------|------|
| Movement:                                   | L           | T    | R    | L           | T    | R    | L          | T    | R    | L          | T    | R    |
| Min. Green:                                 | 10          | 10   | 10   | 10          | 10   | 10   | 10         | 10   | 10   | 10         | 10   | 10   |
| Y+R:  | 4.0         | 4.0  | 4.0  | 4.0         | 4.0  | 4.0  | 4.0        | 4.0  | 4.0  | 4.0        | 4.0  | 4.0  |
| Volume Module: >> Count Date: 8 Oct 2014 << |             |      |      |             |      |      |            |      |      |            |      |      |
| Base Vol:                                   | 19          | 1113 | 171  | 7           | 371  | 28   | 33         | 282  | 50   | 19         | 59   | 7    |
| Growth Adj:                                 | 1.00        | 1.00 | 1.00 | 1.00        | 1.00 | 1.00 | 1.00       | 1.00 | 1.00 | 1.00       | 1.00 | 1.00 |
| Initial Bse:                                | 19          | 1113 | 171  | 7           | 371  | 28   | 33         | 282  | 50   | 19         | 59   | 7    |
| Added Vol:                                  | 0           | 0    | 0    | 0           | 0    | 0    | 0          | 0    | 0    | 0          | 0    | 0    |
| PasserByVol:                                | 0           | 0    | 0    | 0           | 0    | 0    | 0          | 0    | 0    | 0          | 0    | 0    |
| Initial Fut:                                | 19          | 1113 | 171  | 7           | 371  | 28   | 33         | 282  | 50   | 19         | 59   | 7    |
| User Adj:                                   | 1.00        | 1.00 | 1.00 | 1.00        | 1.00 | 1.00 | 1.00       | 1.00 | 1.00 | 1.00       | 1.00 | 1.00 |
| PHF Adj:                                    | 1.00        | 1.00 | 1.00 | 1.00        | 1.00 | 1.00 | 1.00       | 1.00 | 1.00 | 1.00       | 1.00 | 1.00 |
| PHF Volume:                                 | 19          | 1113 | 171  | 7           | 371  | 28   | 33         | 282  | 50   | 19         | 59   | 7    |
| Reduct Vol:                                 | 0           | 0    | 0    | 0           | 0    | 0    | 0          | 0    | 0    | 0          | 0    | 0    |
| Reduced Vol:                                | 19          | 1113 | 171  | 7           | 371  | 28   | 33         | 282  | 50   | 19         | 59   | 7    |
| PCE Adj:                                    | 1.00        | 1.00 | 1.00 | 1.00        | 1.00 | 1.00 | 1.00       | 1.00 | 1.00 | 1.00       | 1.00 | 1.00 |
| MLF Adj:                                    | 1.00        | 1.00 | 1.00 | 1.00        | 1.00 | 1.00 | 1.00       | 1.00 | 1.00 | 1.00       | 1.00 | 1.00 |
| Final Volume:                               | 19          | 1113 | 171  | 7           | 371  | 28   | 33         | 282  | 50   | 19         | 59   | 7    |
| Saturation Flow Module:                     |             |      |      |             |      |      |            |      |      |            |      |      |
| Sat/Lane:                                   | 1900        | 1900 | 1900 | 1900        | 1900 | 1900 | 1900       | 1900 | 1900 | 1900       | 1900 | 1900 |
| Adjustment:                                 | 0.95        | 0.95 | 0.95 | 0.92        | 0.92 | 0.92 | 0.92       | 0.95 | 0.95 | 0.92       | 0.95 | 0.95 |
| Lanes:                                      | 0.03        | 1.71 | 0.26 | 0.02        | 0.91 | 0.07 | 1.00       | 0.85 | 0.15 | 1.00       | 0.89 | 0.11 |
| Final Sat.:                                 | 52          | 3075 | 472  | 30          | 1599 | 121  | 1750       | 1529 | 271  | 1750       | 1609 | 191  |
| Capacity Analysis Module:                   |             |      |      |             |      |      |            |      |      |            |      |      |
| Vol/Sat:                                    | 0.36        | 0.36 | 0.36 | 0.23        | 0.23 | 0.23 | 0.02       | 0.18 | 0.18 | 0.01       | 0.04 | 0.04 |
| Crit Moves:                                 | ****        |      |      | ****        |      |      | ****       |      |      | ****       |      |      |
| Green Time:                                 | 75.5        | 75.5 | 75.5 | 75.5        | 75.5 | 75.5 | 38.5       | 38.5 | 38.5 | 38.5       | 38.5 | 38.5 |
| Volume/Cap:                                 | 0.58        | 0.58 | 0.58 | 0.37        | 0.37 | 0.37 | 0.06       | 0.58 | 0.58 | 0.03       | 0.11 | 0.11 |
| Delay/Veh:                                  | 13.3        | 13.3 | 13.3 | 10.9        | 10.9 | 10.9 | 28.3       | 35.4 | 35.4 | 28.0       | 28.8 | 28.8 |
| User DelAdj:                                | 1.00        | 1.00 | 1.00 | 1.00        | 1.00 | 1.00 | 1.00       | 1.00 | 1.00 | 1.00       | 1.00 | 1.00 |
| AdjDel/Veh:                                 | 13.3        | 13.3 | 13.3 | 10.9        | 10.9 | 10.9 | 28.3       | 35.4 | 35.4 | 28.0       | 28.8 | 28.8 |
| LOS by Move:                                | B           | B    | B    | B           | B    | B    | C          | D    | D    | C          | C    | C    |
| HCM2k95thQ:                                 | 24          | 24   | 24   | 14          | 14   | 14   | 2          | 19   | 19   | 1          | 4    | 4    |

Note: Queue reported is the number of cars per lane.

BART

Level Of Service Computation Report  
2000 HCM Operations (Future Volume Alternative)  
PM - Existing Conditions

Intersection #107: Lafayette/Benton [Study Int 49]

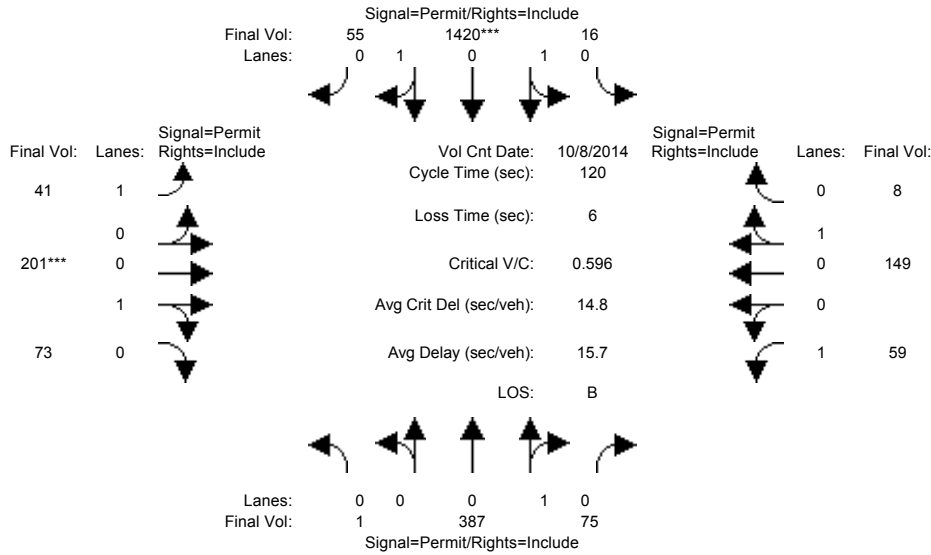

| Approach:                                   | North Bound |      |      | South Bound |      |      | East Bound |      |      | West Bound |      |      |
|---|-------------|------|------|-------------|------|------|------------|------|------|------------|------|------|
| Movement:                                   | L           | T    | R    | L           | T    | R    | L          | T    | R    | L          | T    | R    |
| Min. Green:                                 | 10          | 10   | 10   | 10          | 10   | 10   | 10         | 10   | 10   | 10         | 10   | 10   |
| Y+R:  | 4.0         | 4.0  | 4.0  | 4.0         | 4.0  | 4.0  | 4.0        | 4.0  | 4.0  | 4.0        | 4.0  | 4.0  |
| Volume Module: >> Count Date: 8 Oct 2014 << |             |      |      |             |      |      |            |      |      |            |      |      |
| Base Vol:                                   | 1           | 387  | 75   | 16          | 1420 | 55   | 41         | 201  | 73   | 59         | 149  | 8    |
| Growth Adj:                                 | 1.00        | 1.00 | 1.00 | 1.00        | 1.00 | 1.00 | 1.00       | 1.00 | 1.00 | 1.00       | 1.00 | 1.00 |
| Initial Bse:                                | 1           | 387  | 75   | 16          | 1420 | 55   | 41         | 201  | 73   | 59         | 149  | 8    |
| Added Vol:                                  | 0           | 0    | 0    | 0           | 0    | 0    | 0          | 0    | 0    | 0          | 0    | 0    |
| PasserByVol:                                | 0           | 0    | 0    | 0           | 0    | 0    | 0          | 0    | 0    | 0          | 0    | 0    |
| Initial Fut:                                | 1           | 387  | 75   | 16          | 1420 | 55   | 41         | 201  | 73   | 59         | 149  | 8    |
| User Adj:                                   | 1.00        | 1.00 | 1.00 | 1.00        | 1.00 | 1.00 | 1.00       | 1.00 | 1.00 | 1.00       | 1.00 | 1.00 |
| PHF Adj:                                    | 1.00        | 1.00 | 1.00 | 1.00        | 1.00 | 1.00 | 1.00       | 1.00 | 1.00 | 1.00       | 1.00 | 1.00 |
| PHF Volume:                                 | 1           | 387  | 75   | 16          | 1420 | 55   | 41         | 201  | 73   | 59         | 149  | 8    |
| Reduct Vol:                                 | 0           | 0    | 0    | 0           | 0    | 0    | 0          | 0    | 0    | 0          | 0    | 0    |
| Reduced Vol:                                | 1           | 387  | 75   | 16          | 1420 | 55   | 41         | 201  | 73   | 59         | 149  | 8    |
| PCE Adj:                                    | 1.00        | 1.00 | 1.00 | 1.00        | 1.00 | 1.00 | 1.00       | 1.00 | 1.00 | 1.00       | 1.00 | 1.00 |
| MLF Adj:                                    | 1.00        | 1.00 | 1.00 | 1.00        | 1.00 | 1.00 | 1.00       | 1.00 | 1.00 | 1.00       | 1.00 | 1.00 |
| Final Volume:                               | 1           | 387  | 75   | 16          | 1420 | 55   | 41         | 201  | 73   | 59         | 149  | 8    |
| Saturation Flow Module:                     |             |      |      |             |      |      |            |      |      |            |      |      |
| Sat/Lane:                                   | 1900        | 1900 | 1900 | 1900        | 1900 | 1900 | 1900       | 1900 | 1900 | 1900       | 1900 | 1900 |
| Adjustment:                                 | 0.92        | 0.92 | 0.92 | 0.95        | 0.95 | 0.95 | 0.92       | 0.95 | 0.95 | 0.92       | 0.95 | 0.95 |
| Lanes:                                      | 0.01        | 0.83 | 0.16 | 0.02        | 1.91 | 0.07 | 1.00       | 0.73 | 0.27 | 1.00       | 0.95 | 0.05 |
| Final Sat.:                                 | 4           | 1463 | 283  | 39          | 3429 | 133  | 1750       | 1320 | 480  | 1750       | 1708 | 92   |
| Capacity Analysis Module:                   |             |      |      |             |      |      |            |      |      |            |      |      |
| Vol/Sat:                                    | 0.26        | 0.26 | 0.26 | 0.41        | 0.41 | 0.41 | 0.02       | 0.15 | 0.15 | 0.03       | 0.09 | 0.09 |
| Crit Moves:                                 | *****       |      |      |             |      |      |            |      |      |            |      |      |
| Green Time:                                 | 83.4        | 83.4 | 83.4 | 83.4        | 83.4 | 83.4 | 30.6       | 30.6 | 30.6 | 30.6       | 30.6 | 30.6 |
| Volume/Cap:                                 | 0.38        | 0.38 | 0.38 | 0.60        | 0.60 | 0.60 | 0.09       | 0.60 | 0.60 | 0.13       | 0.34 | 0.34 |
| Delay/Veh:                                  | 7.8         | 7.8  | 7.8  | 9.9         | 9.9  | 9.9  | 34.2       | 41.4 | 41.4 | 34.6       | 36.9 | 36.9 |
| User DelAdj:                                | 1.00        | 1.00 | 1.00 | 1.00        | 1.00 | 1.00 | 1.00       | 1.00 | 1.00 | 1.00       | 1.00 | 1.00 |
| AdjDel/Veh:                                 | 7.8         | 7.8  | 7.8  | 9.9         | 9.9  | 9.9  | 34.2       | 41.4 | 41.4 | 34.6       | 36.9 | 36.9 |
| LOS by Move:                                | A           | A    | A    | A           | A    | A    | C          | D    | D    | C          | D    | D    |
| HCM2k95thQ:                                 | 14          | 14   | 14   | 25          | 25   | 25   | 2          | 17   | 17   | 4          | 10   | 10   |

Note: Queue reported is the number of cars per lane.

BART

Level Of Service Computation Report  
 2000 HCM Operations (Future Volume Alternative)  
 AM - Existing Conditions

Intersection #121: Market/Lafayette [Study Int 51]

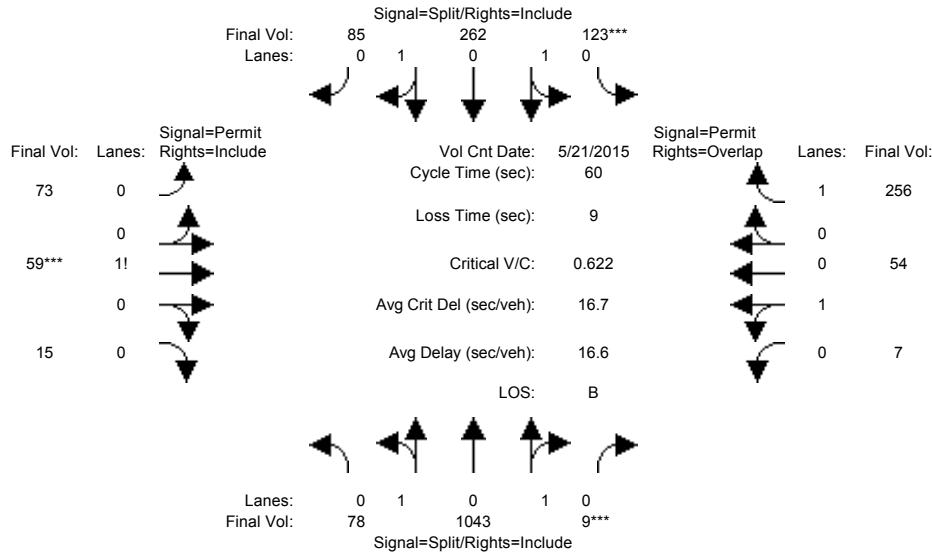

| Approach:                                    | North Bound |      |      | South Bound |      |      | East Bound |      |      | West Bound |      |      |
|--|-------------|------|------|-------------|------|------|------------|------|------|------------|------|------|
| Movement:                                    | L           | T    | R    | L           | T    | R    | L          | T    | R    | L          | T    | R    |
| Min. Green:                                  | 10          | 10   | 10   | 10          | 10   | 10   | 10         | 10   | 10   | 10         | 10   | 10   |
| Y+R:   | 4.0         | 4.0  | 4.0  | 4.0         | 4.0  | 4.0  | 4.0        | 4.0  | 4.0  | 4.0        | 4.0  | 4.0  |
| Volume Module: >> Count Date: 21 May 2015 << |             |      |      |             |      |      |            |      |      |            |      |      |
| Base Vol:                                    | 78          | 1043 | 9    | 123         | 262  | 85   | 73         | 59   | 15   | 7          | 54   | 256  |
| Growth Adj:                                  | 1.00        | 1.00 | 1.00 | 1.00        | 1.00 | 1.00 | 1.00       | 1.00 | 1.00 | 1.00       | 1.00 | 1.00 |
| Initial Bse:                                 | 78          | 1043 | 9    | 123         | 262  | 85   | 73         | 59   | 15   | 7          | 54   | 256  |
| Added Vol:                                   | 0           | 0    | 0    | 0           | 0    | 0    | 0          | 0    | 0    | 0          | 0    | 0    |
| PasserByVol:                                 | 0           | 0    | 0    | 0           | 0    | 0    | 0          | 0    | 0    | 0          | 0    | 0    |
| Initial Fut:                                 | 78          | 1043 | 9    | 123         | 262  | 85   | 73         | 59   | 15   | 7          | 54   | 256  |
| User Adj:                                    | 1.00        | 1.00 | 1.00 | 1.00        | 1.00 | 1.00 | 1.00       | 1.00 | 1.00 | 1.00       | 1.00 | 1.00 |
| PHF Adj:                                     | 1.00        | 1.00 | 1.00 | 1.00        | 1.00 | 1.00 | 1.00       | 1.00 | 1.00 | 1.00       | 1.00 | 1.00 |
| PHF Volume:                                  | 78          | 1043 | 9    | 123         | 262  | 85   | 73         | 59   | 15   | 7          | 54   | 256  |
| Reduct Vol:                                  | 0           | 0    | 0    | 0           | 0    | 0    | 0          | 0    | 0    | 0          | 0    | 0    |
| Reduced Vol:                                 | 78          | 1043 | 9    | 123         | 262  | 85   | 73         | 59   | 15   | 7          | 54   | 256  |
| PCE Adj:                                     | 1.00        | 1.00 | 1.00 | 1.00        | 1.00 | 1.00 | 1.00       | 1.00 | 1.00 | 1.00       | 1.00 | 1.00 |
| MLF Adj:                                     | 1.00        | 1.00 | 1.00 | 1.00        | 1.00 | 1.00 | 1.00       | 1.00 | 1.00 | 1.00       | 1.00 | 1.00 |
| Final Volume:                                | 78          | 1043 | 9    | 123         | 262  | 85   | 73         | 59   | 15   | 7          | 54   | 256  |
| Saturation Flow Module:                      |             |      |      |             |      |      |            |      |      |            |      |      |
| Sat/Lane:                                    | 1900        | 1900 | 1900 | 1900        | 1900 | 1900 | 1900       | 1900 | 1900 | 1900       | 1900 | 1900 |
| Adjustment:                                  | 0.95        | 0.95 | 0.95 | 0.95        | 0.95 | 0.95 | 0.92       | 0.92 | 0.92 | 0.95       | 0.95 | 0.92 |
| Lanes:                                       | 0.14        | 1.85 | 0.01 | 0.52        | 1.12 | 0.36 | 0.50       | 0.40 | 0.10 | 0.11       | 0.89 | 1.00 |
| Final Sat.:                                  | 248         | 3323 | 29   | 942         | 2007 | 651  | 869        | 702  | 179  | 207        | 1593 | 1750 |
| Capacity Analysis Module:                    |             |      |      |             |      |      |            |      |      |            |      |      |
| Vol/Sat:                                     | 0.31        | 0.31 | 0.31 | 0.13        | 0.13 | 0.13 | 0.08       | 0.08 | 0.08 | 0.03       | 0.03 | 0.15 |
| Crit Moves:                                  | ****        | **** | **** | ****        | **** | **** | ****       | **** | **** | ****       | **** | **** |
| Green Time:                                  | 29.0        | 29.0 | 29.0 | 12.0        | 12.0 | 12.0 | 10.0       | 10.0 | 10.0 | 10.0       | 10.0 | 22.0 |
| Volume/Cap:                                  | 0.65        | 0.65 | 0.65 | 0.65        | 0.65 | 0.65 | 0.50       | 0.50 | 0.50 | 0.20       | 0.20 | 0.40 |
| Delay/Veh:                                   | 12.6        | 12.6 | 12.6 | 24.1        | 24.1 | 24.1 | 24.2       | 24.2 | 24.2 | 21.9       | 21.9 | 14.5 |
| User DelAdj:                                 | 1.00        | 1.00 | 1.00 | 1.00        | 1.00 | 1.00 | 1.00       | 1.00 | 1.00 | 1.00       | 1.00 | 1.00 |
| AdjDel/Veh:                                  | 12.6        | 12.6 | 12.6 | 24.1        | 24.1 | 24.1 | 24.2       | 24.2 | 24.2 | 21.9       | 21.9 | 14.5 |
| LOS by Move:                                 | B           | B    | B    | C           | C    | C    | C          | C    | C    | C          | C    | B    |
| HCM2k95thQ:                                  | 16          | 16   | 16   | 9           | 9    | 9    | 5          | 5    | 5    | 2          | 2    | 8    |

Note: Queue reported is the number of cars per lane.

BART

Level Of Service Computation Report  
2000 HCM Operations (Future Volume Alternative)  
PM - Existing Conditions

Intersection #121: Market/Lafayette [Study Int 51]

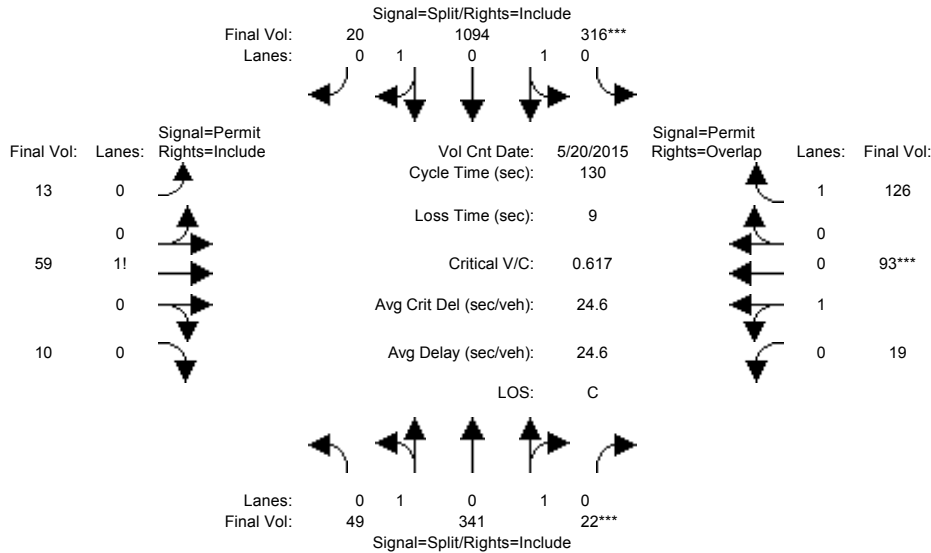

| Approach:                                    | North Bound |      |      | South Bound |      |      | East Bound |      |      | West Bound |      |      |
|--|-------------|------|------|-------------|------|------|------------|------|------|------------|------|------|
| Movement:                                    | L           | T    | R    | L           | T    | R    | L          | T    | R    | L          | T    | R    |
| Min. Green:                                  | 10          | 10   | 10   | 10          | 10   | 10   | 10         | 10   | 10   | 10         | 10   | 10   |
| Y+R:   | 4.0         | 4.0  | 4.0  | 4.0         | 4.0  | 4.0  | 4.0        | 4.0  | 4.0  | 4.0        | 4.0  | 4.0  |
| Volume Module: >> Count Date: 20 May 2015 << |             |      |      |             |      |      |            |      |      |            |      |      |
| Base Vol:                                    | 49          | 341  | 22   | 316         | 1094 | 20   | 13         | 59   | 10   | 19         | 93   | 126  |
| Growth Adj:                                  | 1.00        | 1.00 | 1.00 | 1.00        | 1.00 | 1.00 | 1.00       | 1.00 | 1.00 | 1.00       | 1.00 | 1.00 |
| Initial Bse:                                 | 49          | 341  | 22   | 316         | 1094 | 20   | 13         | 59   | 10   | 19         | 93   | 126  |
| Added Vol:                                   | 0           | 0    | 0    | 0           | 0    | 0    | 0          | 0    | 0    | 0          | 0    | 0    |
| PasserByVol:                                 | 0           | 0    | 0    | 0           | 0    | 0    | 0          | 0    | 0    | 0          | 0    | 0    |
| Initial Fut:                                 | 49          | 341  | 22   | 316         | 1094 | 20   | 13         | 59   | 10   | 19         | 93   | 126  |
| User Adj:                                    | 1.00        | 1.00 | 1.00 | 1.00        | 1.00 | 1.00 | 1.00       | 1.00 | 1.00 | 1.00       | 1.00 | 1.00 |
| PHF Adj:                                     | 1.00        | 1.00 | 1.00 | 1.00        | 1.00 | 1.00 | 1.00       | 1.00 | 1.00 | 1.00       | 1.00 | 1.00 |
| PHF Volume:                                  | 49          | 341  | 22   | 316         | 1094 | 20   | 13         | 59   | 10   | 19         | 93   | 126  |
| Reduct Vol:                                  | 0           | 0    | 0    | 0           | 0    | 0    | 0          | 0    | 0    | 0          | 0    | 0    |
| Reduced Vol:                                 | 49          | 341  | 22   | 316         | 1094 | 20   | 13         | 59   | 10   | 19         | 93   | 126  |
| PCE Adj:                                     | 1.00        | 1.00 | 1.00 | 1.00        | 1.00 | 1.00 | 1.00       | 1.00 | 1.00 | 1.00       | 1.00 | 1.00 |
| MLF Adj:                                     | 1.00        | 1.00 | 1.00 | 1.00        | 1.00 | 1.00 | 1.00       | 1.00 | 1.00 | 1.00       | 1.00 | 1.00 |
| Final Volume:                                | 49          | 341  | 22   | 316         | 1094 | 20   | 13         | 59   | 10   | 19         | 93   | 126  |
| Saturation Flow Module:                      |             |      |      |             |      |      |            |      |      |            |      |      |
| Sat/Lane:                                    | 1900        | 1900 | 1900 | 1900        | 1900 | 1900 | 1900       | 1900 | 1900 | 1900       | 1900 | 1900 |
| Adjustment:                                  | 0.95        | 0.95 | 0.95 | 0.95        | 0.95 | 0.95 | 0.92       | 0.92 | 0.92 | 0.95       | 0.95 | 0.92 |
| Lanes:                                       | 0.24        | 1.65 | 0.11 | 0.44        | 1.53 | 0.03 | 0.16       | 0.72 | 0.12 | 0.17       | 0.83 | 1.00 |
| Final Sat.:                                  | 428         | 2980 | 192  | 796         | 2754 | 50   | 277        | 1259 | 213  | 305        | 1495 | 1750 |
| Capacity Analysis Module:                    |             |      |      |             |      |      |            |      |      |            |      |      |
| Vol/Sat:                                     | 0.11        | 0.11 | 0.11 | 0.40        | 0.40 | 0.40 | 0.05       | 0.05 | 0.05 | 0.06       | 0.06 | 0.07 |
| Crit Moves:                                  | ****        |      |      | ****        |      |      | ****       |      |      | ****       |      |      |
| Green Time:                                  | 24.1        | 24.1 | 24.1 | 83.8        | 83.8 | 83.8 | 13.1       | 13.1 | 13.1 | 13.1       | 13.1 | 96.9 |
| Volume/Cap:                                  | 0.62        | 0.62 | 0.62 | 0.62        | 0.62 | 0.62 | 0.46       | 0.46 | 0.46 | 0.62       | 0.62 | 0.10 |
| Delay/Veh:                                   | 50.4        | 50.4 | 50.4 | 14.2        | 14.2 | 14.2 | 57.1       | 57.1 | 57.1 | 62.3       | 62.3 | 4.6  |
| User DelAdj:                                 | 1.00        | 1.00 | 1.00 | 1.00        | 1.00 | 1.00 | 1.00       | 1.00 | 1.00 | 1.00       | 1.00 | 1.00 |
| AdjDel/Veh:                                  | 50.4        | 50.4 | 50.4 | 14.2        | 14.2 | 14.2 | 57.1       | 57.1 | 57.1 | 62.3       | 62.3 | 4.6  |
| LOS by Move:                                 | D           | D    | D    | B           | B    | B    | E          | E    | E    | E          | E    | A    |
| HCM2k95thQ:                                  | 15          | 15   | 15   | 30          | 30   | 30   | 7          | 7    | 7    | 11         | 11   | 3    |

Note: Queue reported is the number of cars per lane.

BART

Level Of Service Computation Report  
 2000 HCM Operations (Future Volume Alternative)  
 AM - Existing Conditions

Intersection #123: Homestead/Monroe [Study Int 61]

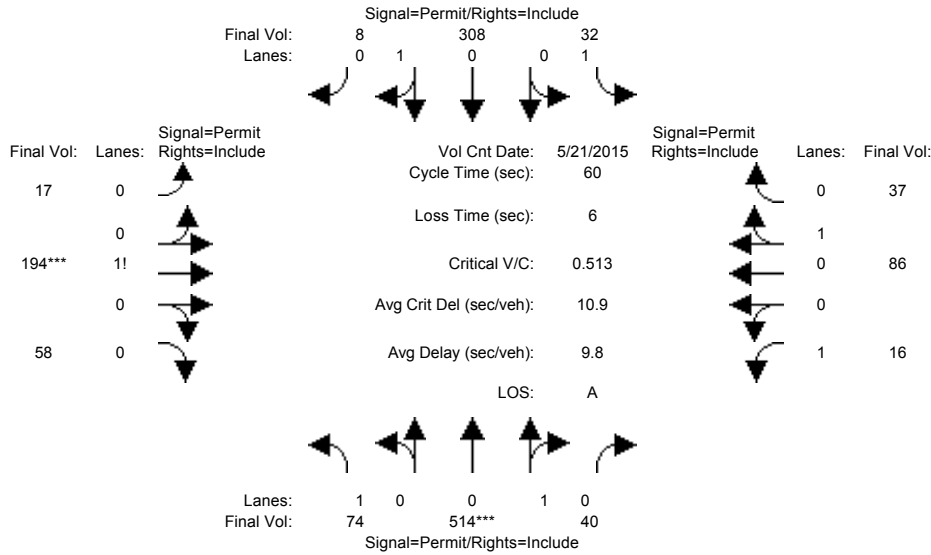

| Approach:                                    | North Bound |      |      | South Bound |      |      | East Bound |      |      | West Bound |      |      |
|--|-------------|------|------|-------------|------|------|------------|------|------|------------|------|------|
| Movement:                                    | L           | T    | R    | L           | T    | R    | L          | T    | R    | L          | T    | R    |
| Min. Green:                                  | 10          | 10   | 10   | 10          | 10   | 10   | 10         | 10   | 10   | 10         | 10   | 10   |
| Y+R:   | 4.0         | 4.0  | 4.0  | 4.0         | 4.0  | 4.0  | 4.0        | 4.0  | 4.0  | 4.0        | 4.0  | 4.0  |
| -----  |             |      |      |             |      |      |            |      |      |            |      |      |
| Volume Module: >> Count Date: 21 May 2015 << |             |      |      |             |      |      |            |      |      |            |      |      |
| Base Vol:                                    | 74          | 514  | 40   | 32          | 308  | 8    | 17         | 194  | 58   | 16         | 86   | 37   |
| Growth Adj:                                  | 1.00        | 1.00 | 1.00 | 1.00        | 1.00 | 1.00 | 1.00       | 1.00 | 1.00 | 1.00       | 1.00 | 1.00 |
| Initial Bse:                                 | 74          | 514  | 40   | 32          | 308  | 8    | 17         | 194  | 58   | 16         | 86   | 37   |
| Added Vol:                                   | 0           | 0    | 0    | 0           | 0    | 0    | 0          | 0    | 0    | 0          | 0    | 0    |
| PasserByVol:                                 | 0           | 0    | 0    | 0           | 0    | 0    | 0          | 0    | 0    | 0          | 0    | 0    |
| Initial Fut:                                 | 74          | 514  | 40   | 32          | 308  | 8    | 17         | 194  | 58   | 16         | 86   | 37   |
| User Adj:                                    | 1.00        | 1.00 | 1.00 | 1.00        | 1.00 | 1.00 | 1.00       | 1.00 | 1.00 | 1.00       | 1.00 | 1.00 |
| PHF Adj:                                     | 1.00        | 1.00 | 1.00 | 1.00        | 1.00 | 1.00 | 1.00       | 1.00 | 1.00 | 1.00       | 1.00 | 1.00 |
| PHF Volume:                                  | 74          | 514  | 40   | 32          | 308  | 8    | 17         | 194  | 58   | 16         | 86   | 37   |
| Reduct Vol:                                  | 0           | 0    | 0    | 0           | 0    | 0    | 0          | 0    | 0    | 0          | 0    | 0    |
| Reduced Vol:                                 | 74          | 514  | 40   | 32          | 308  | 8    | 17         | 194  | 58   | 16         | 86   | 37   |
| PCE Adj:                                     | 1.00        | 1.00 | 1.00 | 1.00        | 1.00 | 1.00 | 1.00       | 1.00 | 1.00 | 1.00       | 1.00 | 1.00 |
| MLF Adj:                                     | 1.00        | 1.00 | 1.00 | 1.00        | 1.00 | 1.00 | 1.00       | 1.00 | 1.00 | 1.00       | 1.00 | 1.00 |
| FinalVolume:                                 | 74          | 514  | 40   | 32          | 308  | 8    | 17         | 194  | 58   | 16         | 86   | 37   |
| -----  |             |      |      |             |      |      |            |      |      |            |      |      |
| Saturation Flow Module:                      |             |      |      |             |      |      |            |      |      |            |      |      |
| Sat/Lane:                                    | 1900        | 1900 | 1900 | 1900        | 1900 | 1900 | 1900       | 1900 | 1900 | 1900       | 1900 | 1900 |
| Adjustment:                                  | 0.92        | 0.95 | 0.95 | 0.92        | 0.95 | 0.95 | 0.92       | 0.92 | 0.92 | 0.92       | 0.95 | 0.95 |
| Lanes:                                       | 1.00        | 0.93 | 0.07 | 1.00        | 0.97 | 0.03 | 0.06       | 0.72 | 0.22 | 1.00       | 0.70 | 0.30 |
| Final Sat.:                                  | 1750        | 1670 | 130  | 1750        | 1754 | 46   | 111        | 1262 | 377  | 1750       | 1259 | 541  |
| -----  |             |      |      |             |      |      |            |      |      |            |      |      |
| Capacity Analysis Module:                    |             |      |      |             |      |      |            |      |      |            |      |      |
| Vol/Sat:                                     | 0.04        | 0.31 | 0.31 | 0.02        | 0.18 | 0.18 | 0.15       | 0.15 | 0.15 | 0.01       | 0.07 | 0.07 |
| Crit Moves:                                  | ****        |      |      | ****        |      |      | ****       |      |      | ****       |      |      |
| Green Time:                                  | 36.0        | 36.0 | 36.0 | 36.0        | 36.0 | 36.0 | 18.0       | 18.0 | 18.0 | 18.0       | 18.0 | 18.0 |
| Volume/Cap:                                  | 0.07        | 0.51 | 0.51 | 0.03        | 0.29 | 0.29 | 0.51       | 0.51 | 0.51 | 0.03       | 0.23 | 0.23 |
| Delay/Veh:                                   | 5.0         | 7.3  | 7.3  | 4.9         | 6.0  | 6.0  | 18.2       | 18.2 | 18.2 | 14.9       | 16.0 | 16.0 |
| User DelAdj:                                 | 1.00        | 1.00 | 1.00 | 1.00        | 1.00 | 1.00 | 1.00       | 1.00 | 1.00 | 1.00       | 1.00 | 1.00 |
| AdjDel/Veh:                                  | 5.0         | 7.3  | 7.3  | 4.9         | 6.0  | 6.0  | 18.2       | 18.2 | 18.2 | 14.9       | 16.0 | 16.0 |
| LOS by Move:                                 | A           | A    | A    | A           | A    | A    | B          | B    | B    | B          | B    | B    |
| HCM2k95thQ:                                  | 1           | 12   | 12   | 1           | 6    | 6    | 9          | 9    | 9    | 0          | 4    | 4    |

Note: Queue reported is the number of cars per lane.



BART

Level Of Service Computation Report  
2000 HCM Operations (Future Volume Alternative)  
PM - Existing Conditions

Intersection #123: Homestead/Monroe [Study Int 61]

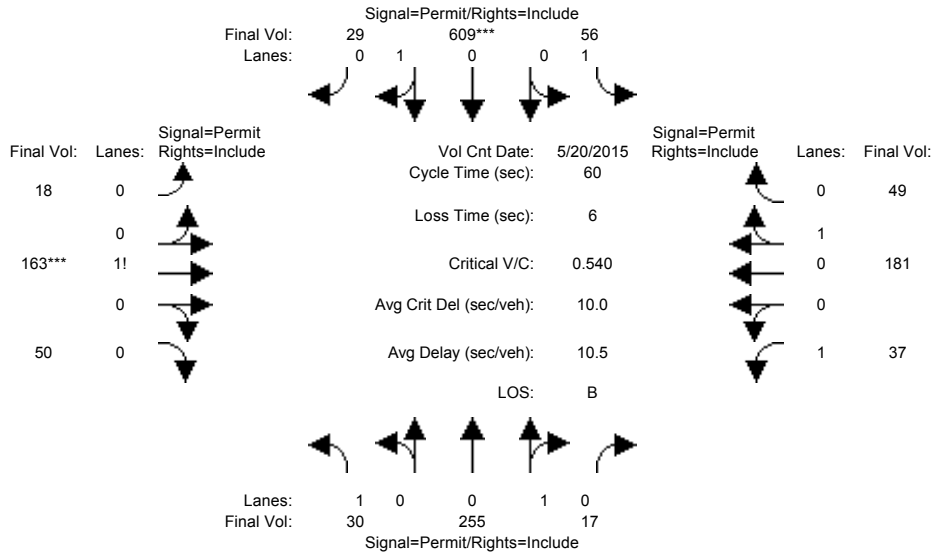

| Approach:                 | North Bound                   |      |      | South Bound |      |      | East Bound |      |      | West Bound |      |      |
|---------------------------|-------------------------------|------|------|-------------|------|------|------------|------|------|------------|------|------|
| Movement:                 | L                             | T    | R    | L           | T    | R    | L          | T    | R    | L          | T    | R    |
| Min. Green:               | 10                            | 10   | 10   | 10          | 10   | 10   | 10         | 10   | 10   | 10         | 10   | 10   |
| Y+R:                      | 4.0                           | 4.0  | 4.0  | 4.0         | 4.0  | 4.0  | 4.0        | 4.0  | 4.0  | 4.0        | 4.0  | 4.0  |
| -----                     |                               |      |      |             |      |      |            |      |      |            |      |      |
| Volume Module:            | >> Count Date: 20 May 2015 << |      |      |             |      |      |            |      |      |            |      |      |
| Base Vol:                 | 30                            | 255  | 17   | 56          | 609  | 29   | 18         | 163  | 50   | 37         | 181  | 49   |
| Growth Adj:               | 1.00                          | 1.00 | 1.00 | 1.00        | 1.00 | 1.00 | 1.00       | 1.00 | 1.00 | 1.00       | 1.00 | 1.00 |
| Initial Bse:              | 30                            | 255  | 17   | 56          | 609  | 29   | 18         | 163  | 50   | 37         | 181  | 49   |
| Added Vol:                | 0                             | 0    | 0    | 0           | 0    | 0    | 0          | 0    | 0    | 0          | 0    | 0    |
| PasserByVol:              | 0                             | 0    | 0    | 0           | 0    | 0    | 0          | 0    | 0    | 0          | 0    | 0    |
| Initial Fut:              | 30                            | 255  | 17   | 56          | 609  | 29   | 18         | 163  | 50   | 37         | 181  | 49   |
| User Adj:                 | 1.00                          | 1.00 | 1.00 | 1.00        | 1.00 | 1.00 | 1.00       | 1.00 | 1.00 | 1.00       | 1.00 | 1.00 |
| PHF Adj:                  | 1.00                          | 1.00 | 1.00 | 1.00        | 1.00 | 1.00 | 1.00       | 1.00 | 1.00 | 1.00       | 1.00 | 1.00 |
| PHF Volume:               | 30                            | 255  | 17   | 56          | 609  | 29   | 18         | 163  | 50   | 37         | 181  | 49   |
| Reduct Vol:               | 0                             | 0    | 0    | 0           | 0    | 0    | 0          | 0    | 0    | 0          | 0    | 0    |
| Reduced Vol:              | 30                            | 255  | 17   | 56          | 609  | 29   | 18         | 163  | 50   | 37         | 181  | 49   |
| PCE Adj:                  | 1.00                          | 1.00 | 1.00 | 1.00        | 1.00 | 1.00 | 1.00       | 1.00 | 1.00 | 1.00       | 1.00 | 1.00 |
| MLF Adj:                  | 1.00                          | 1.00 | 1.00 | 1.00        | 1.00 | 1.00 | 1.00       | 1.00 | 1.00 | 1.00       | 1.00 | 1.00 |
| Final Volume:             | 30                            | 255  | 17   | 56          | 609  | 29   | 18         | 163  | 50   | 37         | 181  | 49   |
| -----                     |                               |      |      |             |      |      |            |      |      |            |      |      |
| Saturation Flow Module:   |                               |      |      |             |      |      |            |      |      |            |      |      |
| Sat/Lane:                 | 1900                          | 1900 | 1900 | 1900        | 1900 | 1900 | 1900       | 1900 | 1900 | 1900       | 1900 | 1900 |
| Adjustment:               | 0.92                          | 0.95 | 0.95 | 0.92        | 0.95 | 0.95 | 0.92       | 0.92 | 0.92 | 0.92       | 0.95 | 0.95 |
| Lanes:                    | 1.00                          | 0.94 | 0.06 | 1.00        | 0.95 | 0.05 | 0.08       | 0.70 | 0.22 | 1.00       | 0.79 | 0.21 |
| Final Sat.:               | 1750                          | 1687 | 112  | 1750        | 1718 | 82   | 136        | 1235 | 379  | 1750       | 1417 | 383  |
| -----                     |                               |      |      |             |      |      |            |      |      |            |      |      |
| Capacity Analysis Module: |                               |      |      |             |      |      |            |      |      |            |      |      |
| Vol/Sat:                  | 0.02                          | 0.15 | 0.15 | 0.03        | 0.35 | 0.35 | 0.13       | 0.13 | 0.13 | 0.02       | 0.13 | 0.13 |
| Crit Moves:               | *****                         |      |      |             |      |      |            |      |      |            |      |      |
| Green Time:               | 39.3                          | 39.3 | 39.3 | 39.3        | 39.3 | 39.3 | 14.7       | 14.7 | 14.7 | 14.7       | 14.7 | 14.7 |
| Volume/Cap:               | 0.03                          | 0.23 | 0.23 | 0.05        | 0.54 | 0.54 | 0.54       | 0.54 | 0.54 | 0.09       | 0.52 | 0.52 |
| Delay/Veh:                | 3.6                           | 4.3  | 4.3  | 3.7         | 6.0  | 6.0  | 21.1       | 21.1 | 21.1 | 17.6       | 20.8 | 20.8 |
| User DelAdj:              | 1.00                          | 1.00 | 1.00 | 1.00        | 1.00 | 1.00 | 1.00       | 1.00 | 1.00 | 1.00       | 1.00 | 1.00 |
| AdjDel/Veh:               | 3.6                           | 4.3  | 4.3  | 3.7         | 6.0  | 6.0  | 21.1       | 21.1 | 21.1 | 17.6       | 20.8 | 20.8 |
| LOS by Move:              | A                             | A    | A    | A           | A    | A    | C          | C    | C    | B          | C    | C    |
| HCM2k95thQ:               | 0                             | 4    | 4    | 1           | 13   | 13   | 8          | 8    | 8    | 1          | 8    | 8    |

Note: Queue reported is the number of cars per lane.

BART

Level Of Service Computation Report  
 2000 HCM Operations (Future Volume Alternative)  
 AM - Existing Conditions

Intersection #127: Lincoln/Homestead [Study Int 60]

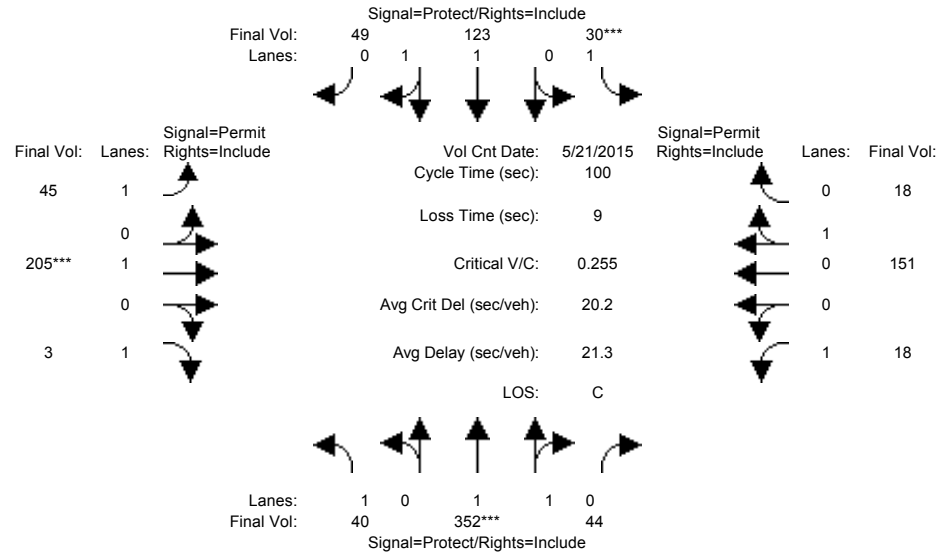

| Approach:                                    | North Bound |      |      | South Bound |      |      | East Bound |      |      | West Bound |      |      |
|--|-------------|------|------|-------------|------|------|------------|------|------|------------|------|------|
| Movement:                                    | L           | T    | R    | L           | T    | R    | L          | T    | R    | L          | T    | R    |
| Min. Green:                                  | 7           | 10   | 10   | 7           | 10   | 10   | 7          | 10   | 10   | 7          | 10   | 10   |
| Y+R:   | 4.0         | 4.0  | 4.0  | 4.0         | 4.0  | 4.0  | 4.0        | 4.0  | 4.0  | 4.0        | 4.0  | 4.0  |
| Volume Module: >> Count Date: 21 May 2015 << |             |      |      |             |      |      |            |      |      |            |      |      |
| Base Vol:                                    | 40          | 352  | 44   | 30          | 123  | 49   | 45         | 205  | 3    | 18         | 151  | 18   |
| Growth Adj:                                  | 1.00        | 1.00 | 1.00 | 1.00        | 1.00 | 1.00 | 1.00       | 1.00 | 1.00 | 1.00       | 1.00 | 1.00 |
| Initial Bse:                                 | 40          | 352  | 44   | 30          | 123  | 49   | 45         | 205  | 3    | 18         | 151  | 18   |
| Added Vol:                                   | 0           | 0    | 0    | 0           | 0    | 0    | 0          | 0    | 0    | 0          | 0    | 0    |
| PasserByVol:                                 | 0           | 0    | 0    | 0           | 0    | 0    | 0          | 0    | 0    | 0          | 0    | 0    |
| Initial Fut:                                 | 40          | 352  | 44   | 30          | 123  | 49   | 45         | 205  | 3    | 18         | 151  | 18   |
| User Adj:                                    | 1.00        | 1.00 | 1.00 | 1.00        | 1.00 | 1.00 | 1.00       | 1.00 | 1.00 | 1.00       | 1.00 | 1.00 |
| PHF Adj:                                     | 1.00        | 1.00 | 1.00 | 1.00        | 1.00 | 1.00 | 1.00       | 1.00 | 1.00 | 1.00       | 1.00 | 1.00 |
| PHF Volume:                                  | 40          | 352  | 44   | 30          | 123  | 49   | 45         | 205  | 3    | 18         | 151  | 18   |
| Reduct Vol:                                  | 0           | 0    | 0    | 0           | 0    | 0    | 0          | 0    | 0    | 0          | 0    | 0    |
| Reduced Vol:                                 | 40          | 352  | 44   | 30          | 123  | 49   | 45         | 205  | 3    | 18         | 151  | 18   |
| PCE Adj:                                     | 1.00        | 1.00 | 1.00 | 1.00        | 1.00 | 1.00 | 1.00       | 1.00 | 1.00 | 1.00       | 1.00 | 1.00 |
| MLF Adj:                                     | 1.00        | 1.00 | 1.00 | 1.00        | 1.00 | 1.00 | 1.00       | 1.00 | 1.00 | 1.00       | 1.00 | 1.00 |
| Final Volume:                                | 40          | 352  | 44   | 30          | 123  | 49   | 45         | 205  | 3    | 18         | 151  | 18   |
| Saturation Flow Module:                      |             |      |      |             |      |      |            |      |      |            |      |      |
| Sat/Lane:                                    | 1900        | 1900 | 1900 | 1900        | 1900 | 1900 | 1900       | 1900 | 1900 | 1900       | 1900 | 1900 |
| Adjustment:                                  | 0.92        | 0.98 | 0.95 | 0.92        | 0.98 | 0.95 | 0.92       | 1.00 | 0.92 | 0.92       | 0.95 | 0.95 |
| Lanes:                                       | 1.00        | 1.77 | 0.23 | 1.00        | 1.41 | 0.59 | 1.00       | 1.00 | 1.00 | 1.00       | 0.89 | 0.11 |
| Final Sat.:                                  | 1750        | 3289 | 411  | 1750        | 2645 | 1054 | 1750       | 1900 | 1750 | 1750       | 1608 | 192  |
| Capacity Analysis Module:                    |             |      |      |             |      |      |            |      |      |            |      |      |
| Vol/Sat:                                     | 0.02        | 0.11 | 0.11 | 0.02        | 0.05 | 0.05 | 0.03       | 0.11 | 0.00 | 0.01       | 0.09 | 0.09 |
| Crit Moves:                                  | ****        | **** | **** | ****        | **** | **** | ****       | **** | **** | ****       | **** | **** |
| Green Time:                                  | 20.1        | 41.8 | 41.8 | 7.0         | 28.7 | 28.7 | 42.2       | 42.2 | 42.2 | 42.2       | 42.2 | 42.2 |
| Volume/Cap:                                  | 0.11        | 0.26 | 0.26 | 0.24        | 0.16 | 0.16 | 0.06       | 0.26 | 0.00 | 0.02       | 0.22 | 0.22 |
| Delay/Veh:                                   | 32.8        | 19.0 | 19.0 | 45.0        | 26.7 | 26.7 | 17.2       | 18.9 | 16.8 | 16.9       | 18.6 | 18.6 |
| User DelAdj:                                 | 1.00        | 1.00 | 1.00 | 1.00        | 1.00 | 1.00 | 1.00       | 1.00 | 1.00 | 1.00       | 1.00 | 1.00 |
| AdjDel/Veh:                                  | 32.8        | 19.0 | 19.0 | 45.0        | 26.7 | 26.7 | 17.2       | 18.9 | 16.8 | 16.9       | 18.6 | 18.6 |
| LOS by Move:                                 | C           | B    | B    | D           | C    | C    | B          | B    | B    | B          | B    | B    |
| HCM2k95thQ:                                  | 2           | 8    | 8    | 2           | 4    | 4    | 2          | 8    | 0    | 1          | 7    | 7    |

Note: Queue reported is the number of cars per lane.

BART

Level Of Service Computation Report  
 2000 HCM Operations (Future Volume Alternative)  
 PM - Existing Conditions

Intersection #127: Lincoln/Homestead [Study Int 60]

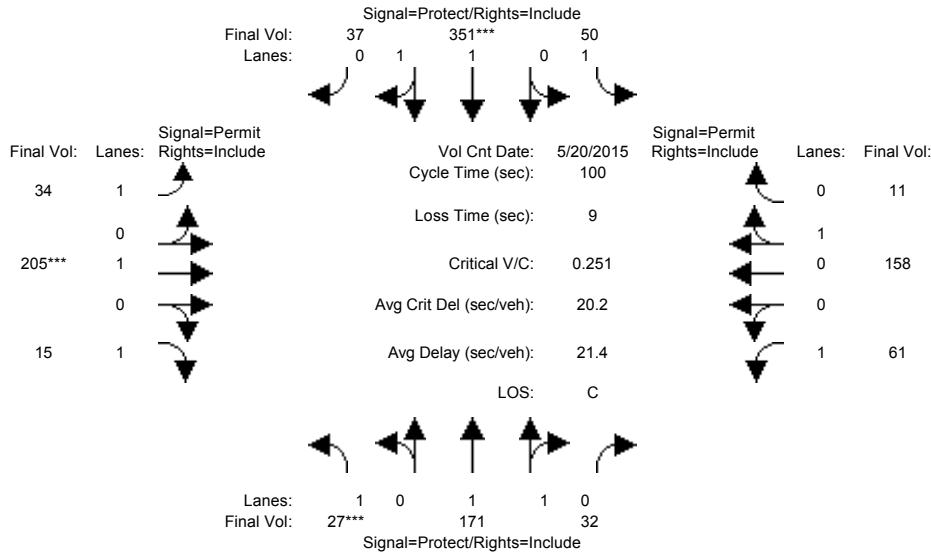

| Approach:                                    | North Bound |      |      | South Bound |      |      | East Bound |      |      | West Bound |      |      |
|--|-------------|------|------|-------------|------|------|------------|------|------|------------|------|------|
| Movement:                                    | L           | T    | R    | L           | T    | R    | L          | T    | R    | L          | T    | R    |
| Min. Green:                                  | 7           | 10   | 10   | 7           | 10   | 10   | 7          | 10   | 10   | 7          | 10   | 10   |
| Y+R:   | 4.0         | 4.0  | 4.0  | 4.0         | 4.0  | 4.0  | 4.0        | 4.0  | 4.0  | 4.0        | 4.0  | 4.0  |
| Volume Module: >> Count Date: 20 May 2015 << |             |      |      |             |      |      |            |      |      |            |      |      |
| Base Vol:                                    | 27          | 171  | 32   | 50          | 351  | 37   | 34         | 205  | 15   | 61         | 158  | 11   |
| Growth Adj:                                  | 1.00        | 1.00 | 1.00 | 1.00        | 1.00 | 1.00 | 1.00       | 1.00 | 1.00 | 1.00       | 1.00 | 1.00 |
| Initial Bse:                                 | 27          | 171  | 32   | 50          | 351  | 37   | 34         | 205  | 15   | 61         | 158  | 11   |
| Added Vol:                                   | 0           | 0    | 0    | 0           | 0    | 0    | 0          | 0    | 0    | 0          | 0    | 0    |
| PasserByVol:                                 | 0           | 0    | 0    | 0           | 0    | 0    | 0          | 0    | 0    | 0          | 0    | 0    |
| Initial Fut:                                 | 27          | 171  | 32   | 50          | 351  | 37   | 34         | 205  | 15   | 61         | 158  | 11   |
| User Adj:                                    | 1.00        | 1.00 | 1.00 | 1.00        | 1.00 | 1.00 | 1.00       | 1.00 | 1.00 | 1.00       | 1.00 | 1.00 |
| PHF Adj:                                     | 1.00        | 1.00 | 1.00 | 1.00        | 1.00 | 1.00 | 1.00       | 1.00 | 1.00 | 1.00       | 1.00 | 1.00 |
| PHF Volume:                                  | 27          | 171  | 32   | 50          | 351  | 37   | 34         | 205  | 15   | 61         | 158  | 11   |
| Reduct Vol:                                  | 0           | 0    | 0    | 0           | 0    | 0    | 0          | 0    | 0    | 0          | 0    | 0    |
| Reduced Vol:                                 | 27          | 171  | 32   | 50          | 351  | 37   | 34         | 205  | 15   | 61         | 158  | 11   |
| PCE Adj:                                     | 1.00        | 1.00 | 1.00 | 1.00        | 1.00 | 1.00 | 1.00       | 1.00 | 1.00 | 1.00       | 1.00 | 1.00 |
| MLF Adj:                                     | 1.00        | 1.00 | 1.00 | 1.00        | 1.00 | 1.00 | 1.00       | 1.00 | 1.00 | 1.00       | 1.00 | 1.00 |
| Final Volume:                                | 27          | 171  | 32   | 50          | 351  | 37   | 34         | 205  | 15   | 61         | 158  | 11   |
| Saturation Flow Module:                      |             |      |      |             |      |      |            |      |      |            |      |      |
| Sat/Lane:                                    | 1900        | 1900 | 1900 | 1900        | 1900 | 1900 | 1900       | 1900 | 1900 | 1900       | 1900 | 1900 |
| Adjustment:                                  | 0.92        | 0.98 | 0.95 | 0.92        | 0.98 | 0.95 | 0.92       | 1.00 | 0.92 | 0.92       | 0.95 | 0.95 |
| Lanes:                                       | 1.00        | 1.68 | 0.32 | 1.00        | 1.80 | 0.20 | 1.00       | 1.00 | 1.00 | 1.00       | 0.93 | 0.07 |
| Final Sat.:                                  | 1750        | 3116 | 583  | 1750        | 3347 | 353  | 1750       | 1900 | 1750 | 1750       | 1683 | 117  |
| Capacity Analysis Module:                    |             |      |      |             |      |      |            |      |      |            |      |      |
| Vol/Sat:                                     | 0.02        | 0.05 | 0.05 | 0.03        | 0.10 | 0.10 | 0.02       | 0.11 | 0.01 | 0.03       | 0.09 | 0.09 |
| Crit Moves:                                  | ****        |      |      | ****        |      |      | ****       |      |      | ****       |      |      |
| Green Time:                                  | 7.0         | 28.5 | 28.5 | 19.9        | 41.4 | 41.4 | 42.6       | 42.6 | 42.6 | 42.6       | 42.6 | 42.6 |
| Volume/Cap:                                  | 0.22        | 0.19 | 0.19 | 0.14        | 0.25 | 0.25 | 0.05       | 0.25 | 0.02 | 0.08       | 0.22 | 0.22 |
| Delay/Veh:                                   | 44.8        | 27.2 | 27.2 | 33.2        | 19.3 | 19.3 | 16.8       | 18.6 | 16.6 | 17.1       | 18.3 | 18.3 |
| User DelAdj:                                 | 1.00        | 1.00 | 1.00 | 1.00        | 1.00 | 1.00 | 1.00       | 1.00 | 1.00 | 1.00       | 1.00 | 1.00 |
| AdjDel/Veh:                                  | 44.8        | 27.2 | 27.2 | 33.2        | 19.3 | 19.3 | 16.8       | 18.6 | 16.6 | 17.1       | 18.3 | 18.3 |
| LOS by Move:                                 | D           | C    | C    | C           | B    | B    | B          | B    | B    | B          | B    | B    |
| HCM2k95thQ:                                  | 2           | 5    | 5    | 3           | 8    | 8    | 1          | 8    | 1    | 2          | 7    | 7    |

Note: Queue reported is the number of cars per lane.

BART

Level Of Service Computation Report  
 2000 HCM Operations (Future Volume Alternative)  
 AM - Existing Conditions

Intersection #128: Homestead/Lafayette [Study Int 50]

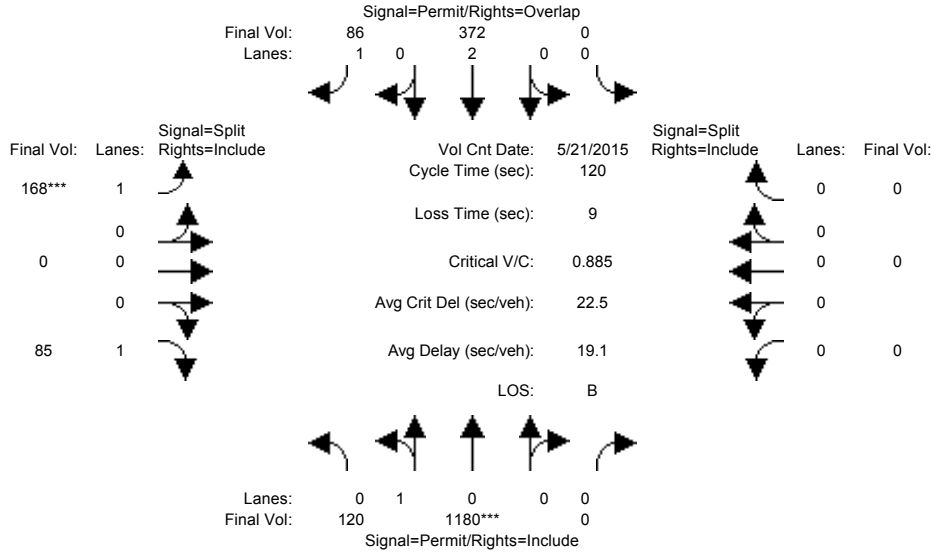

| Approach:                                    | North Bound |      |      | South Bound |      |       | East Bound |      |      | West Bound |      |      |
|--|-------------|------|------|-------------|------|-------|------------|------|------|------------|------|------|
| Movement:                                    | L           | T    | R    | L           | T    | R     | L          | T    | R    | L          | T    | R    |
| Min. Green:                                  | 10          | 10   | 10   | 10          | 10   | 10    | 10         | 10   | 10   | 10         | 10   | 10   |
| Y+R:   | 4.0         | 4.0  | 4.0  | 4.0         | 4.0  | 4.0   | 4.0        | 4.0  | 4.0  | 4.0        | 4.0  | 4.0  |
| -----  |             |      |      |             |      |       |            |      |      |            |      |      |
| Volume Module: >> Count Date: 21 May 2015 << |             |      |      |             |      |       |            |      |      |            |      |      |
| Base Vol:                                    | 120         | 1180 | 0    | 0           | 372  | 86    | 168        | 0    | 85   | 0          | 0    | 0    |
| Growth Adj:                                  | 1.00        | 1.00 | 1.00 | 1.00        | 1.00 | 1.00  | 1.00       | 1.00 | 1.00 | 1.00       | 1.00 | 1.00 |
| Initial Bse:                                 | 120         | 1180 | 0    | 0           | 372  | 86    | 168        | 0    | 85   | 0          | 0    | 0    |
| Added Vol:                                   | 0           | 0    | 0    | 0           | 0    | 0     | 0          | 0    | 0    | 0          | 0    | 0    |
| PasserByVol:                                 | 0           | 0    | 0    | 0           | 0    | 0     | 0          | 0    | 0    | 0          | 0    | 0    |
| Initial Fut:                                 | 120         | 1180 | 0    | 0           | 372  | 86    | 168        | 0    | 85   | 0          | 0    | 0    |
| User Adj:                                    | 1.00        | 1.00 | 1.00 | 1.00        | 1.00 | 1.00  | 1.00       | 1.00 | 1.00 | 1.00       | 1.00 | 1.00 |
| PHF Adj:                                     | 1.00        | 1.00 | 1.00 | 1.00        | 1.00 | 1.00  | 1.00       | 1.00 | 1.00 | 1.00       | 1.00 | 1.00 |
| PHF Volume:                                  | 120         | 1180 | 0    | 0           | 372  | 86    | 168        | 0    | 85   | 0          | 0    | 0    |
| Reduct Vol:                                  | 0           | 0    | 0    | 0           | 0    | 0     | 0          | 0    | 0    | 0          | 0    | 0    |
| Reduced Vol:                                 | 120         | 1180 | 0    | 0           | 372  | 86    | 168        | 0    | 85   | 0          | 0    | 0    |
| PCE Adj:                                     | 1.00        | 1.00 | 1.00 | 1.00        | 1.00 | 1.00  | 1.00       | 1.00 | 1.00 | 1.00       | 1.00 | 1.00 |
| MLF Adj:                                     | 1.00        | 1.00 | 1.00 | 1.00        | 1.00 | 1.00  | 1.00       | 1.00 | 1.00 | 1.00       | 1.00 | 1.00 |
| Final Volume:                                | 120         | 1180 | 0    | 0           | 372  | 86    | 168        | 0    | 85   | 0          | 0    | 0    |
| -----  |             |      |      |             |      |       |            |      |      |            |      |      |
| Saturation Flow Module:                      |             |      |      |             |      |       |            |      |      |            |      |      |
| Sat/Lane:                                    | 1900        | 1900 | 1900 | 1900        | 1900 | 1900  | 1900       | 1900 | 1900 | 1900       | 1900 | 1900 |
| Adjustment:                                  | 0.95        | 0.95 | 0.92 | 0.92        | 1.00 | 0.92  | 0.92       | 1.00 | 0.92 | 0.92       | 1.00 | 0.92 |
| Lanes:                                       | 0.09        | 0.91 | 0.00 | 0.00        | 2.00 | 1.00  | 1.00       | 0.00 | 1.00 | 0.00       | 0.00 | 0.00 |
| Final Sat.:                                  | 166         | 1634 | 0    | 0           | 3800 | 1750  | 1750       | 0    | 1750 | 0          | 0    | 0    |
| -----  |             |      |      |             |      |       |            |      |      |            |      |      |
| Capacity Analysis Module:                    |             |      |      |             |      |       |            |      |      |            |      |      |
| Vol/Sat:                                     | 0.72        | 0.72 | 0.00 | 0.00        | 0.10 | 0.05  | 0.10       | 0.00 | 0.05 | 0.00       | 0.00 | 0.00 |
| Crit Moves:                                  | ****        |      |      | ****        |      |       | ****       |      |      | ****       |      |      |
| Green Time:                                  | 98.0        | 98.0 | 0.0  | 0.0         | 98.0 | 111.0 | 13.0       | 0.0  | 13.0 | 0.0        | 0.0  | 0.0  |
| Volume/Cap:                                  | 0.88        | 0.88 | 0.00 | 0.00        | 0.12 | 0.05  | 0.88       | 0.00 | 0.45 | 0.00       | 0.00 | 0.00 |
| Delay/Veh:                                   | 14.0        | 14.0 | 0.0  | 0.0         | 2.3  | 0.4   | 88.0       | 0.0  | 51.8 | 0.0        | 0.0  | 0.0  |
| User DelAdj:                                 | 1.00        | 1.00 | 1.00 | 1.00        | 1.00 | 1.00  | 1.00       | 1.00 | 1.00 | 1.00       | 1.00 | 1.00 |
| AdjDel/Veh:                                  | 14.0        | 14.0 | 0.0  | 0.0         | 2.3  | 0.4   | 88.0       | 0.0  | 51.8 | 0.0        | 0.0  | 0.0  |
| LOS by Move:                                 | B           | B    | A    | A           | A    | A     | F          | A    | D    | A          | A    | A    |
| HCM2k95thQ:                                  | 58          | 58   | 0    | 0           | 3    | 1     | 14         | 0    | 6    | 0          | 0    | 0    |

Note: Queue reported is the number of cars per lane.

BART

Level Of Service Computation Report  
 2000 HCM Operations (Future Volume Alternative)  
 PM - Existing Conditions

Intersection #128: Homestead/Lafayette [Study Int 50]

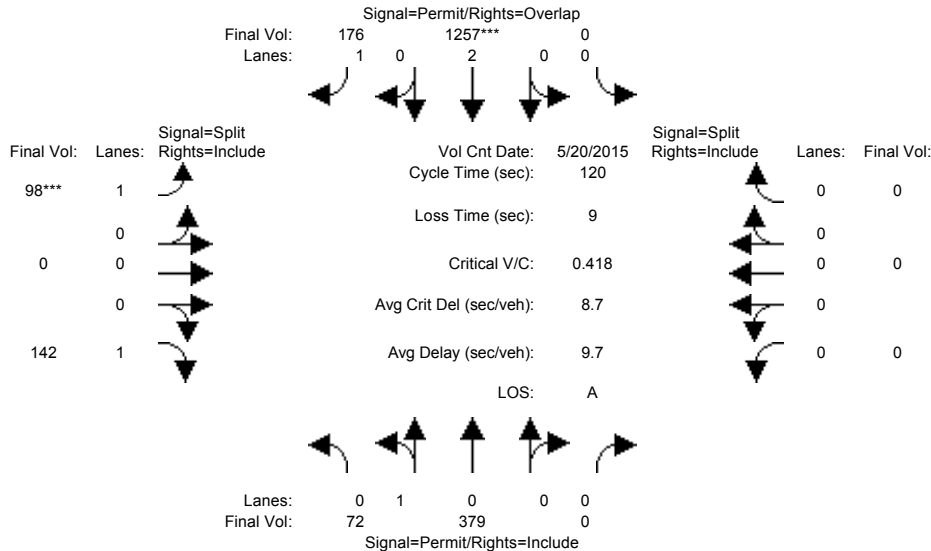

| Approach:                                    | North Bound |      |      | South Bound |      |       | East Bound |      |      | West Bound |      |      |
|--|-------------|------|------|-------------|------|-------|------------|------|------|------------|------|------|
| Movement:                                    | L           | T    | R    | L           | T    | R     | L          | T    | R    | L          | T    | R    |
| Min. Green:                                  | 10          | 10   | 10   | 10          | 10   | 10    | 10         | 10   | 10   | 10         | 10   | 10   |
| Y+R:   | 4.0         | 4.0  | 4.0  | 4.0         | 4.0  | 4.0   | 4.0        | 4.0  | 4.0  | 4.0        | 4.0  | 4.0  |
| Volume Module: >> Count Date: 20 May 2015 << |             |      |      |             |      |       |            |      |      |            |      |      |
| Base Vol:                                    | 72          | 379  | 0    | 0           | 1257 | 176   | 98         | 0    | 142  | 0          | 0    | 0    |
| Growth Adj:                                  | 1.00        | 1.00 | 1.00 | 1.00        | 1.00 | 1.00  | 1.00       | 1.00 | 1.00 | 1.00       | 1.00 | 1.00 |
| Initial Bse:                                 | 72          | 379  | 0    | 0           | 1257 | 176   | 98         | 0    | 142  | 0          | 0    | 0    |
| Added Vol:                                   | 0           | 0    | 0    | 0           | 0    | 0     | 0          | 0    | 0    | 0          | 0    | 0    |
| PasserByVol:                                 | 0           | 0    | 0    | 0           | 0    | 0     | 0          | 0    | 0    | 0          | 0    | 0    |
| Initial Fut:                                 | 72          | 379  | 0    | 0           | 1257 | 176   | 98         | 0    | 142  | 0          | 0    | 0    |
| User Adj:                                    | 1.00        | 1.00 | 1.00 | 1.00        | 1.00 | 1.00  | 1.00       | 1.00 | 1.00 | 1.00       | 1.00 | 1.00 |
| PHF Adj:                                     | 1.00        | 1.00 | 1.00 | 1.00        | 1.00 | 1.00  | 1.00       | 1.00 | 1.00 | 1.00       | 1.00 | 1.00 |
| PHF Volume:                                  | 72          | 379  | 0    | 0           | 1257 | 176   | 98         | 0    | 142  | 0          | 0    | 0    |
| Reduct Vol:                                  | 0           | 0    | 0    | 0           | 0    | 0     | 0          | 0    | 0    | 0          | 0    | 0    |
| Reduced Vol:                                 | 72          | 379  | 0    | 0           | 1257 | 176   | 98         | 0    | 142  | 0          | 0    | 0    |
| PCE Adj:                                     | 1.00        | 1.00 | 1.00 | 1.00        | 1.00 | 1.00  | 1.00       | 1.00 | 1.00 | 1.00       | 1.00 | 1.00 |
| MLF Adj:                                     | 1.00        | 1.00 | 1.00 | 1.00        | 1.00 | 1.00  | 1.00       | 1.00 | 1.00 | 1.00       | 1.00 | 1.00 |
| FinalVolume:                                 | 72          | 379  | 0    | 0           | 1257 | 176   | 98         | 0    | 142  | 0          | 0    | 0    |
| Saturation Flow Module:                      |             |      |      |             |      |       |            |      |      |            |      |      |
| Sat/Lane:                                    | 1900        | 1900 | 1900 | 1900        | 1900 | 1900  | 1900       | 1900 | 1900 | 1900       | 1900 | 1900 |
| Adjustment:                                  | 0.95        | 0.95 | 0.92 | 0.92        | 1.00 | 0.92  | 0.92       | 1.00 | 0.92 | 0.92       | 1.00 | 0.92 |
| Lanes:                                       | 0.16        | 0.84 | 0.00 | 0.00        | 2.00 | 1.00  | 1.00       | 0.00 | 1.00 | 0.00       | 0.00 | 0.00 |
| Final Sat.:                                  | 287         | 1513 | 0    | 0           | 3800 | 1750  | 1750       | 0    | 1750 | 0          | 0    | 0    |
| Capacity Analysis Module:                    |             |      |      |             |      |       |            |      |      |            |      |      |
| Vol/Sat:                                     | 0.25        | 0.25 | 0.00 | 0.00        | 0.33 | 0.10  | 0.06       | 0.00 | 0.08 | 0.00       | 0.00 | 0.00 |
| Crit Moves:                                  | *****       |      |      |             |      |       |            |      |      |            |      |      |
| Green Time:                                  | 89.1        | 89.1 | 0.0  | 0.0         | 89.1 | 111.0 | 21.9       | 0.0  | 21.9 | 0.0        | 0.0  | 0.0  |
| Volume/Cap:                                  | 0.34        | 0.34 | 0.00 | 0.00        | 0.45 | 0.11  | 0.31       | 0.00 | 0.45 | 0.00       | 0.00 | 0.00 |
| Delay/Veh:                                   | 5.4         | 5.4  | 0.0  | 0.0         | 6.0  | 0.4   | 43.1       | 0.0  | 44.7 | 0.0        | 0.0  | 0.0  |
| User DelAdj:                                 | 1.00        | 1.00 | 1.00 | 1.00        | 1.00 | 1.00  | 1.00       | 1.00 | 1.00 | 1.00       | 1.00 | 1.00 |
| AdjDel/Veh:                                  | 5.4         | 5.4  | 0.0  | 0.0         | 6.0  | 0.4   | 43.1       | 0.0  | 44.7 | 0.0        | 0.0  | 0.0  |
| LOS by Move:                                 | A           | A    | A    | A           | A    | A     | D          | A    | D    | A          | A    | A    |
| HCM2k95thQ:                                  | 12          | 12   | 0    | 0           | 16   | 1     | 7          | 0    | 10   | 0          | 0    | 0    |

Note: Queue reported is the number of cars per lane.

BART

Level Of Service Computation Report  
 2000 HCM Operations (Future Volume Alternative)  
 AM - Existing Conditions

Intersection #175: Reed/De La Cruz [Study Int 32]

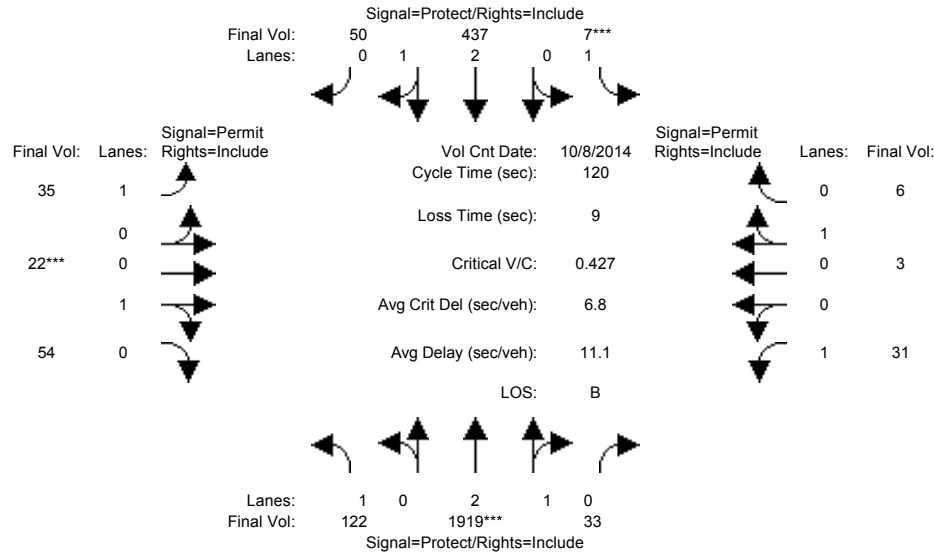

| Approach:                                   | North Bound |      |      | South Bound |      |      | East Bound |      |      | West Bound |      |      |
|---|-------------|------|------|-------------|------|------|------------|------|------|------------|------|------|
| Movement:                                   | L           | T    | R    | L           | T    | R    | L          | T    | R    | L          | T    | R    |
| Min. Green:                                 | 7           | 10   | 10   | 7           | 10   | 10   | 10         | 10   | 10   | 10         | 10   | 10   |
| Y+R:  | 4.0         | 4.0  | 4.0  | 4.0         | 4.0  | 4.0  | 4.0        | 4.0  | 4.0  | 4.0        | 4.0  | 4.0  |
| Volume Module: >> Count Date: 8 Oct 2014 << |             |      |      |             |      |      |            |      |      |            |      |      |
| Base Vol:                                   | 122         | 1919 | 33   | 7           | 437  | 50   | 35         | 22   | 54   | 31         | 3    | 6    |
| Growth Adj:                                 | 1.00        | 1.00 | 1.00 | 1.00        | 1.00 | 1.00 | 1.00       | 1.00 | 1.00 | 1.00       | 1.00 | 1.00 |
| Initial Bse:                                | 122         | 1919 | 33   | 7           | 437  | 50   | 35         | 22   | 54   | 31         | 3    | 6    |
| Added Vol:                                  | 0           | 0    | 0    | 0           | 0    | 0    | 0          | 0    | 0    | 0          | 0    | 0    |
| PasserByVol:                                | 0           | 0    | 0    | 0           | 0    | 0    | 0          | 0    | 0    | 0          | 0    | 0    |
| Initial Fut:                                | 122         | 1919 | 33   | 7           | 437  | 50   | 35         | 22   | 54   | 31         | 3    | 6    |
| User Adj:                                   | 1.00        | 1.00 | 1.00 | 1.00        | 1.00 | 1.00 | 1.00       | 1.00 | 1.00 | 1.00       | 1.00 | 1.00 |
| PHF Adj:                                    | 1.00        | 1.00 | 1.00 | 1.00        | 1.00 | 1.00 | 1.00       | 1.00 | 1.00 | 1.00       | 1.00 | 1.00 |
| PHF Volume:                                 | 122         | 1919 | 33   | 7           | 437  | 50   | 35         | 22   | 54   | 31         | 3    | 6    |
| Reduct Vol:                                 | 0           | 0    | 0    | 0           | 0    | 0    | 0          | 0    | 0    | 0          | 0    | 0    |
| Reduced Vol:                                | 122         | 1919 | 33   | 7           | 437  | 50   | 35         | 22   | 54   | 31         | 3    | 6    |
| PCE Adj:                                    | 1.00        | 1.00 | 1.00 | 1.00        | 1.00 | 1.00 | 1.00       | 1.00 | 1.00 | 1.00       | 1.00 | 1.00 |
| MLF Adj:                                    | 1.00        | 1.00 | 1.00 | 1.00        | 1.00 | 1.00 | 1.00       | 1.00 | 1.00 | 1.00       | 1.00 | 1.00 |
| Final Volume:                               | 122         | 1919 | 33   | 7           | 437  | 50   | 35         | 22   | 54   | 31         | 3    | 6    |
| Saturation Flow Module:                     |             |      |      |             |      |      |            |      |      |            |      |      |
| Sat/Lane:                                   | 1900        | 1900 | 1900 | 1900        | 1900 | 1900 | 1900       | 1900 | 1900 | 1900       | 1900 | 1900 |
| Adjustment:                                 | 0.92        | 0.98 | 0.95 | 0.92        | 0.99 | 0.95 | 0.92       | 0.95 | 0.95 | 0.92       | 0.95 | 0.95 |
| Lanes:                                      | 1.00        | 2.95 | 0.05 | 1.00        | 2.68 | 0.32 | 1.00       | 0.29 | 0.71 | 1.00       | 0.33 | 0.67 |
| Final Sat.:                                 | 1750        | 5505 | 95   | 1750        | 5024 | 575  | 1750       | 521  | 1279 | 1750       | 600  | 1200 |
| Capacity Analysis Module:                   |             |      |      |             |      |      |            |      |      |            |      |      |
| Vol/Sat:                                    | 0.07        | 0.35 | 0.35 | 0.00        | 0.09 | 0.09 | 0.02       | 0.04 | 0.04 | 0.02       | 0.01 | 0.01 |
| Crit Moves:                                 | ****        | **** | **** | ****        | **** | **** | ****       | **** | **** | ****       | **** | **** |
| Green Time:                                 | 44.4        | 92.8 | 92.8 | 7.0         | 55.4 | 55.4 | 11.2       | 11.2 | 11.2 | 11.2       | 11.2 | 11.2 |
| Volume/Cap:                                 | 0.19        | 0.45 | 0.45 | 0.07        | 0.19 | 0.19 | 0.21       | 0.45 | 0.45 | 0.19       | 0.05 | 0.05 |
| Delay/Veh:                                  | 25.7        | 4.8  | 4.8  | 53.7        | 19.1 | 19.1 | 51.0       | 53.4 | 53.4 | 50.7       | 49.7 | 49.7 |
| User DelAdj:                                | 1.00        | 1.00 | 1.00 | 1.00        | 1.00 | 1.00 | 1.00       | 1.00 | 1.00 | 1.00       | 1.00 | 1.00 |
| AdjDel/Veh:                                 | 25.7        | 4.8  | 4.8  | 53.7        | 19.1 | 19.1 | 51.0       | 53.4 | 53.4 | 50.7       | 49.7 | 49.7 |
| LOS by Move:                                | C           | A    | A    | D           | B    | B    | D          | D    | D    | D          | D    | D    |
| HCM2k95thQ:                                 | 6           | 16   | 16   | 1           | 7    | 7    | 3          | 6    | 6    | 3          | 1    | 1    |

Note: Queue reported is the number of cars per lane.

BART

Level Of Service Computation Report  
 2000 HCM Operations (Future Volume Alternative)  
 PM - Existing Conditions

Intersection #175: Reed/De La Cruz [Study Int 32]

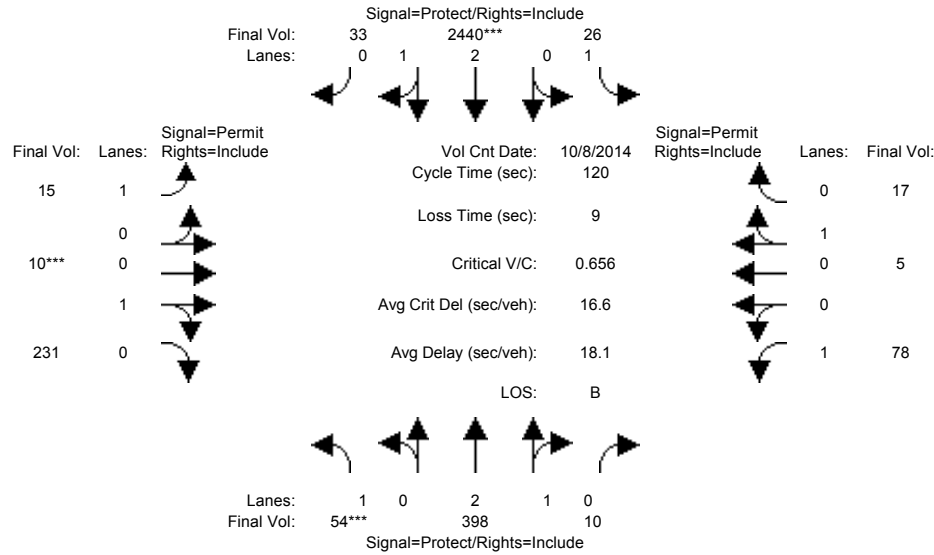

| Approach:                 | North Bound                  |      |      | South Bound |      |      | East Bound |      |      | West Bound |      |      |
|---------------------------|------------------------------|------|------|-------------|------|------|------------|------|------|------------|------|------|
| Movement:                 | L                            | T    | R    | L           | T    | R    | L          | T    | R    | L          | T    | R    |
| Min. Green:               | 7                            | 10   | 10   | 7           | 10   | 10   | 10         | 10   | 10   | 10         | 10   | 10   |
| Y+R:                      | 4.0                          | 4.0  | 4.0  | 4.0         | 4.0  | 4.0  | 4.0        | 4.0  | 4.0  | 4.0        | 4.0  | 4.0  |
| -----                     |                              |      |      |             |      |      |            |      |      |            |      |      |
| Volume Module:            | >> Count Date: 8 Oct 2014 << |      |      |             |      |      |            |      |      |            |      |      |
| Base Vol:                 | 54                           | 398  | 10   | 26          | 2440 | 33   | 15         | 10   | 231  | 78         | 5    | 17   |
| Growth Adj:               | 1.00                         | 1.00 | 1.00 | 1.00        | 1.00 | 1.00 | 1.00       | 1.00 | 1.00 | 1.00       | 1.00 | 1.00 |
| Initial Bse:              | 54                           | 398  | 10   | 26          | 2440 | 33   | 15         | 10   | 231  | 78         | 5    | 17   |
| Added Vol:                | 0                            | 0    | 0    | 0           | 0    | 0    | 0          | 0    | 0    | 0          | 0    | 0    |
| PasserByVol:              | 0                            | 0    | 0    | 0           | 0    | 0    | 0          | 0    | 0    | 0          | 0    | 0    |
| Initial Fut:              | 54                           | 398  | 10   | 26          | 2440 | 33   | 15         | 10   | 231  | 78         | 5    | 17   |
| User Adj:                 | 1.00                         | 1.00 | 1.00 | 1.00        | 1.00 | 1.00 | 1.00       | 1.00 | 1.00 | 1.00       | 1.00 | 1.00 |
| PHF Adj:                  | 1.00                         | 1.00 | 1.00 | 1.00        | 1.00 | 1.00 | 1.00       | 1.00 | 1.00 | 1.00       | 1.00 | 1.00 |
| PHF Volume:               | 54                           | 398  | 10   | 26          | 2440 | 33   | 15         | 10   | 231  | 78         | 5    | 17   |
| Reduct Vol:               | 0                            | 0    | 0    | 0           | 0    | 0    | 0          | 0    | 0    | 0          | 0    | 0    |
| Reduced Vol:              | 54                           | 398  | 10   | 26          | 2440 | 33   | 15         | 10   | 231  | 78         | 5    | 17   |
| PCE Adj:                  | 1.00                         | 1.00 | 1.00 | 1.00        | 1.00 | 1.00 | 1.00       | 1.00 | 1.00 | 1.00       | 1.00 | 1.00 |
| MLF Adj:                  | 1.00                         | 1.00 | 1.00 | 1.00        | 1.00 | 1.00 | 1.00       | 1.00 | 1.00 | 1.00       | 1.00 | 1.00 |
| FinalVolume:              | 54                           | 398  | 10   | 26          | 2440 | 33   | 15         | 10   | 231  | 78         | 5    | 17   |
| -----                     |                              |      |      |             |      |      |            |      |      |            |      |      |
| Saturation Flow Module:   |                              |      |      |             |      |      |            |      |      |            |      |      |
| Sat/Lane:                 | 1900                         | 1900 | 1900 | 1900        | 1900 | 1900 | 1900       | 1900 | 1900 | 1900       | 1900 | 1900 |
| Adjustment:               | 0.92                         | 0.98 | 0.95 | 0.92        | 0.98 | 0.95 | 0.92       | 0.95 | 0.95 | 0.92       | 0.95 | 0.95 |
| Lanes:                    | 1.00                         | 2.92 | 0.08 | 1.00        | 2.96 | 0.04 | 1.00       | 0.04 | 0.96 | 1.00       | 0.23 | 0.77 |
| Final Sat.:               | 1750                         | 5463 | 137  | 1750        | 5525 | 75   | 1750       | 75   | 1725 | 1750       | 409  | 1391 |
| -----                     |                              |      |      |             |      |      |            |      |      |            |      |      |
| Capacity Analysis Module: |                              |      |      |             |      |      |            |      |      |            |      |      |
| Vol/Sat:                  | 0.03                         | 0.07 | 0.07 | 0.01        | 0.44 | 0.44 | 0.01       | 0.13 | 0.13 | 0.04       | 0.01 | 0.01 |
| Crit Moves:               | ****                         |      |      | ****        |      |      | ****       |      |      | ****       |      |      |
| Green Time:               | 7.0                          | 51.1 | 51.1 | 35.7        | 79.8 | 79.8 | 24.2       | 24.2 | 24.2 | 24.2       | 24.2 | 24.2 |
| Volume/Cap:               | 0.53                         | 0.17 | 0.17 | 0.05        | 0.66 | 0.66 | 0.04       | 0.66 | 0.66 | 0.22       | 0.06 | 0.06 |
| Delay/Veh:                | 60.0                         | 21.4 | 21.4 | 30.1        | 12.5 | 12.5 | 38.6       | 48.7 | 48.7 | 40.3       | 38.8 | 38.8 |
| User DelAdj:              | 1.00                         | 1.00 | 1.00 | 1.00        | 1.00 | 1.00 | 1.00       | 1.00 | 1.00 | 1.00       | 1.00 | 1.00 |
| AdjDel/Veh:               | 60.0                         | 21.4 | 21.4 | 30.1        | 12.5 | 12.5 | 38.6       | 48.7 | 48.7 | 40.3       | 38.8 | 38.8 |
| LOS by Move:              | E                            | C    | C    | C           | B    | B    | D          | D    | D    | D          | D    | D    |
| HCM2k95thQ:               | 6                            | 6    | 6    | 1           | 32   | 32   | 1          | 16   | 16   | 5          | 1    | 1    |

Note: Queue reported is the number of cars per lane.

BART

Level Of Service Computation Report
2000 HCM Unsignalized (Future Volume Alternative)
AM - Existing Conditions

Intersection #1008: Lafayette/Harrison (unsignalized) [Study Int 48]

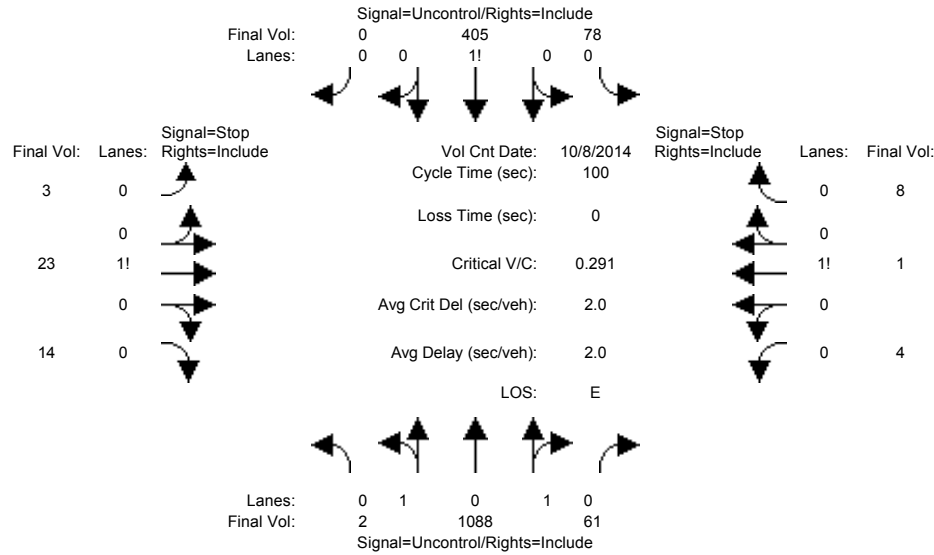

Table with columns for Approach (North, South, East, West Bound) and Movement (L, T, R). Rows include Volume Module, Critical Gap Module, Capacity Module, Level of Service Module, and various performance metrics like delay, saturation, and queue lengths.



ConflictVol: 405 xxxxx xxxxx 1149 xxxxx xxxxx 1110 1714 405 1702 1684 575  
\*\*\* Computation 5: Capacity for Subject Movement During Unblocked Period  
InitPotCap: 1165 xxxxx xxxxx 615 xxxxx xxxxx 188 91 650 73 95 522  
UpstreamAdj:1.00 x.xxx x.xxx 1.00 x.xxx x.xxx 1.00 1.000 1.000 1.00 1.000 1.000  
Potent Cap.:1165 xxxxx xxxxx 615 xxxxx xxxxx 188 91 650 73 95 522

BART

Level Of Service Computation Report  
2000 HCM Unsignalized (Future Volume Alternative)  
PM - Existing Conditions

Intersection #1008: Lafayette/Harrison (unsignalized) [Study Int 48]

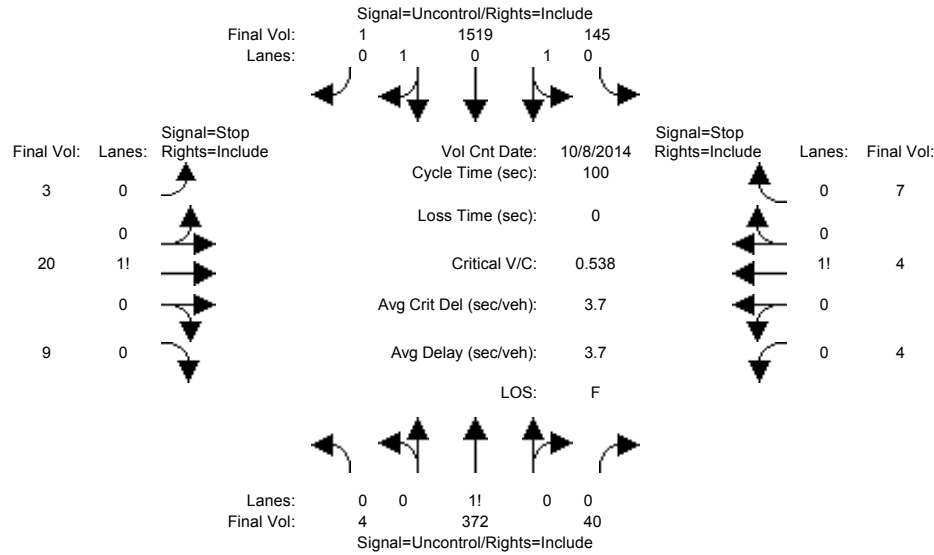

| Approach:   | North Bound               |               |               | South Bound   |               |               | East Bound    |               |               | West Bound    |               |       |
|---|---------------------------|---------------|---------------|---------------|---------------|---------------|---------------|---------------|---------------|---------------|---------------|-------|
| Movement:   | L                         | T             | R             | L             | T             | R             | L             | T             | R             | L             | T             | R     |
| Volume Module: >> Count Date: 8 Oct 2014 <<                               |                           |               |               |               |               |               |               |               |               |               |               |       |
| Base Vol:   | 4                         | 372           | 40            | 145           | 1519          | 1             | 3             | 20            | 9             | 4             | 4             | 7     |
| Growth Adj:   | 1.00                      | 1.00          | 1.00          | 1.00          | 1.00          | 1.00          | 1.00          | 1.00          | 1.00          | 1.00          | 1.00          | 1.00  |
| Initial Bse:  | 4                         | 372           | 40            | 145           | 1519          | 1             | 3             | 20            | 9             | 4             | 4             | 7     |
| Added Vol:  | 0                         | 0             | 0             | 0             | 0             | 0             | 0             | 0             | 0             | 0             | 0             | 0     |
| PasserByVol:  | 0                         | 0             | 0             | 0             | 0             | 0             | 0             | 0             | 0             | 0             | 0             | 0     |
| Initial Fut:  | 4                         | 372           | 40            | 145           | 1519          | 1             | 3             | 20            | 9             | 4             | 4             | 7     |
| User Adj:   | 1.00                      | 1.00          | 1.00          | 1.00          | 1.00          | 1.00          | 1.00          | 1.00          | 1.00          | 1.00          | 1.00          | 1.00  |
| PHF Adj:  | 1.00                      | 1.00          | 1.00          | 1.00          | 1.00          | 1.00          | 1.00          | 1.00          | 1.00          | 1.00          | 1.00          | 1.00  |
| PHF Volume:   | 4                         | 372           | 40            | 145           | 1519          | 1             | 3             | 20            | 9             | 4             | 4             | 7     |
| Reduct Vol:   | 0                         | 0             | 0             | 0             | 0             | 0             | 0             | 0             | 0             | 0             | 0             | 0     |
| FinalVolume:  | 4                         | 372           | 40            | 145           | 1519          | 1             | 3             | 20            | 9             | 4             | 4             | 7     |
| Critical Gap Module:  |                           |               |               |               |               |               |               |               |               |               |               |       |
| Critical Gp:  | 4.1                       | xxxx          | xxxxx         | 4.1           | xxxx          | xxxxx         | 7.1           | 6.5           | 6.2           | 7.1           | 6.5           | 6.2   |
| FollowUpTim:  | 2.2                       | xxxx          | xxxxx         | 2.2           | xxxx          | xxxxx         | 3.5           | 4.0           | 3.3           | 3.5           | 4.0           | 3.3   |
| Capacity Module:  |                           |               |               |               |               |               |               |               |               |               |               |       |
| Cnflct Vol:   | 1520                      | xxxx          | xxxxx         | 412           | xxxx          | xxxxx         | 2215          | 2230          | 760           | 1460          | 2210          | 392   |
| Potent Cap.:  | 445                       | xxxx          | xxxxx         | 1158          | xxxx          | xxxxx         | 32            | 43            | 409           | 108           | 45            | 661   |
| Move Cap.:  | 445                       | xxxx          | xxxxx         | 1158          | xxxx          | xxxxx         | 26            | 37            | 409           | 55            | 38            | 661   |
| Volume/Cap:   | 0.01                      | xxxx          | xxxx          | 0.13          | xxxx          | xxxx          | 0.12          | 0.54          | 0.02          | 0.07          | 0.10          | 0.01  |
| Level Of Service Module:  |                           |               |               |               |               |               |               |               |               |               |               |       |
| 2Way95thQ:  | 0.0                       | xxxx          | xxxxx         | 0.4           | xxxx          | xxxxx         | xxxx          | xxxx          | xxxxx         | xxxx          | xxxx          | xxxxx |
| Control Del:  | 13.2                      | xxxx          | xxxxx         | 8.6           | xxxx          | xxxxx         | xxxx          | xxxx          | xxxxx         | xxxx          | xxxx          | xxxxx |
| LOS by Move:  | B                         | *             | *             | A             | *             | *             | *             | *             | *             | *             | *             | *     |
| Movement:   | LT - LTR - RT             | LT - LTR - RT | LT - LTR - RT | LT - LTR - RT | LT - LTR - RT | LT - LTR - RT | LT - LTR - RT | LT - LTR - RT | LT - LTR - RT | LT - LTR - RT | LT - LTR - RT |       |
| Shared Cap.:  | xxxx                      | xxxx          | xxxxx         | xxxx          | xxxx          | xxxxx         | 47            | xxxx          | xxxx          | 80            | xxxx          | xxxxx |
| SharedQueue:  | xxxxx                     | xxxx          | xxxxx         | 0.4           | xxxx          | xxxxx         | 2.6           | xxxx          | xxxxx         | 0.6           | xxxx          | xxxxx |
| Shrd ConDel:  | xxxxx                     | xxxx          | xxxxx         | 8.6           | xxxx          | xxxxx         | 177           | xxxx          | xxxxx         | 60.3          | xxxx          | xxxxx |
| Shared LOS:   | *                         | *             | *             | A             | *             | *             | F             | *             | xxxx          | F             | *             | *     |
| ApproachDel:  | xxxxxx                    | xxxxxx        | xxxxxx        | xxxxxx        | xxxxxx        | 176.9         | xxxxxx        | xxxxxx        | 60.3          | xxxxxx        | xxxxxx        |       |
| ApproachLOS:  | *                         | *             | *             | *             | *             | F             | *             | *             | F             | *             | *             |       |
| Note: Queue reported is the number of cars per lane.                      |                           |               |               |               |               |               |               |               |               |               |               |       |
| HevVeh:   | 0%                        | 0%            | 0%            | 0%            | 0%            | 0%            | 0%            | 0%            | 0%            | 0%            | 0%            |       |
| Grade:  | 0%                        | 0%            | 0%            | 0%            | 0%            | 0%            | 0%            | 0%            | 0%            | 0%            | 0%            |       |
| Peds/Hour:  | 0                         | 0             | 0             | 0             | 0             | 0             | 0             | 0             | 0             | 0             | 0             |       |
| Pedestrian Walk Speed:  | 4.00 feet/sec             |               |               | 4.00 feet/sec |               |               | 4.00 feet/sec |               |               | 4.00 feet/sec |               |       |
| LaneWidth:  | 12 feet                   |               |               | 12 feet       |               |               | 12 feet       |               |               | 12 feet       |               |       |
| Time Period:  | 0.25 hour                 |               |               |               |               |               |               |               |               |               |               |       |
| Upstream Signals:   |                           |               |               |               |               |               |               |               |               |               |               |       |
| Link Index:   | #718                      |               |               | #974          |               |               |               |               |               |               |               |       |
| Dist(miles):  | 0.000                     |               |               | 0.000         |               |               |               |               |               |               |               |       |
| Speed (mph):  | 0.00                      |               |               | 0.00          |               |               |               |               |               |               |               |       |
| SignalIndex:  | #107                      |               |               | #5444         |               |               |               |               |               |               |               |       |
| Cycle Time:   | 0 secs                    |               |               | 0 secs        |               |               |               |               |               |               |               |       |
| InitVolume:   | 0                         | 0             | 0             | 0             | 0             | 0             | 0             | 0             | 0             | 0             | 0             | 0     |
| Saturation:   | 0                         | 0             | 0             | 0             | 0             | 0             | 0             | 0             | 0             | 0             | 0             | 0     |
| ArrivalType:  | 0                         | 0             | 0             | 0             | 0             | 0             | 0             | 0             | 0             | 0             | 0             | 0     |
| G/C:  | 0.00                      | 0.00          | 0.00          | 0.00          | 0.00          | 0.00          | 0.00          | 0.00          | 0.00          | 0.00          | 0.00          | 0.00  |
| *** Computation 1: Time for Queue to Clear at Each Upstream Intersection  |                           |               |               |               |               |               |               |               |               |               |               |       |
| P:  | 0.000                     | 0.000         | 0.000         | 0.000         | 0.000         | 0.000         | 0.000         | 0.000         | 0.000         | 0.000         | 0.000         | 0.000 |
| gg1:  | 0.00                      | 0.00          | 0.00          | 0.00          | 0.00          | 0.00          | 0.00          | 0.00          | 0.00          | 0.00          | 0.00          | 0.00  |
| gg2:  | 0.00                      | 0.00          | 0.00          | 0.00          | 0.00          | 0.00          | 0.00          | 0.00          | 0.00          | 0.00          | 0.00          | 0.00  |
| gg:   | 0.00                      | 0.00          | 0.00          | 0.00          | 0.00          | 0.00          | 0.00          | 0.00          | 0.00          | 0.00          | 0.00          | 0.00  |
| *** Computation 2: Time Intersection Blocked Because of Upstream Platoons |                           |               |               |               |               |               |               |               |               |               |               |       |
| alpha:  | 0.000                     | 0.000         | 0.000         | 0.000         | 0.000         | 0.000         | 0.000         | 0.000         | 0.000         | 0.000         | 0.000         |       |
| beta:   | 0.000                     | 0.000         | 0.000         | 0.000         | 0.000         | 0.000         | 0.000         | 0.000         | 0.000         | 0.000         | 0.000         |       |
| ta (secs):  | 0.000                     | 0.000         | 0.000         | 0.000         | 0.000         | 0.000         | 0.000         | 0.000         | 0.000         | 0.000         | 0.000         |       |
| F:  | 0.000                     | 0.000         | 0.000         | 0.000         | 0.000         | 0.000         | 0.000         | 0.000         | 0.000         | 0.000         | 0.000         |       |
| f:  | 0.000                     | 0.000         | 0.000         | 0.000         | 0.000         | 0.000         | 0.000         | 0.000         | 0.000         | 0.000         | 0.000         | 0.000 |
| vcmax:  | 0                         | 0             | 0             | 0             | 0             | 0             | 0             | 0             | 0             | 0             | 0             | 0     |
| vcg:  | 0                         | 0             | 0             | 0             | 0             | 0             | 0             | 0             | 0             | 0             | 0             | 0     |
| vcmin:  | 0                         | 0             | 0             | 0             | 0             | 0             | 0             | 0             | 0             | 0             | 0             | 0     |
| tp:   | 0.0                       | 0.0           | 0.0           | 0.0           | 0.0           | 0.0           | 0.0           | 0.0           | 0.0           | 0.0           | 0.0           | 0.0   |
| P1:   | 0.000                     | 0.000         | 0.000         | 0.000         | 0.000         | 0.000         | 0.000         | 0.000         | 0.000         | 0.000         | 0.000         |       |
| *** Computation 3: Platoon Event Periods                                  |                           |               |               |               |               |               |               |               |               |               |               |       |
| pdom/psubo:   | 0.000/0.000/Unconstrained |               |               |               |               |               |               |               |               |               |               |       |
| *** Computation 4: Conflicting Flows During Each Unblocked Period         |                           |               |               |               |               |               |               |               |               |               |               |       |
| InitCnflVol:  | 1520                      | xxxx          | xxxxx         | 412           | xxxx          | xxxxx         | 2215          | 2230          | 760           | 1460          | 2210          | 392   |
| AdjCnflVol:   | 1520                      | xxxx          | xxxxx         | 412           | xxxx          | xxxxx         | 2215          | 2230          | 760           | 1460          | 2210          | 392   |
| UpstreamAdj:  | 1.00                      | x.xxx         | x.xxx         | 1.00          | x.xxx         | x.xxx         | 1.00          | 1.000         | 1.000         | 1.00          | 1.000         | 1.000 |

ConflictVol:1520 xxxxx xxxxx 412 xxxxx xxxxx 2215 2230 760 1460 2210 392  
\*\*\* Computation 5: Capacity for Subject Movement During Unblocked Period  
InitPotCap: 445 xxxxx xxxxx 1158 xxxxx xxxxx 32 43 409 108 45 661  
UpstreamAdj:1.00 x.xxx x.xxx 1.00 x.xxx x.xxx 1.00 1.000 1.000 1.00 1.000 1.000  
Potent Cap.: 445 xxxxx xxxxx 1158 xxxxx xxxxx 32 43 409 108 45 661

BART

Level Of Service Computation Report  
 2000 HCM Operations (Future Volume Alternative)  
 AM - Existing Conditions

Intersection #1012: El Camino Real/Railroad Ave [Study Int 53]

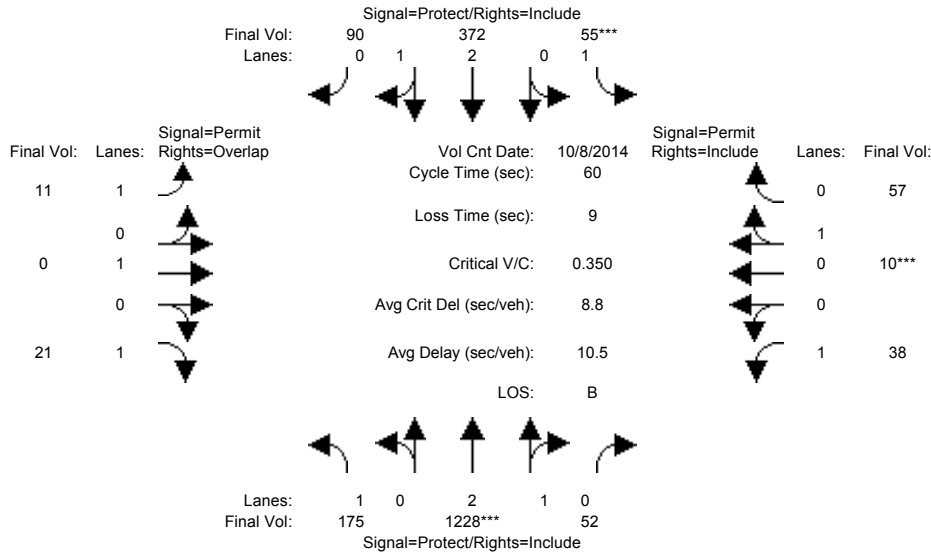

| Approach:                                   | North Bound |      |      | South Bound |      |      | East Bound |      |      | West Bound |      |      |
|---|-------------|------|------|-------------|------|------|------------|------|------|------------|------|------|
| Movement:                                   | L           | T    | R    | L           | T    | R    | L          | T    | R    | L          | T    | R    |
| Min. Green:                                 | 7           | 10   | 10   | 7           | 10   | 10   | 10         | 10   | 10   | 10         | 10   | 10   |
| Y+R:  | 4.0         | 4.0  | 4.0  | 4.0         | 4.0  | 4.0  | 4.0        | 4.0  | 4.0  | 4.0        | 4.0  | 4.0  |
| Volume Module: >> Count Date: 8 Oct 2014 << |             |      |      |             |      |      |            |      |      |            |      |      |
| Base Vol:                                   | 175         | 1228 | 52   | 55          | 372  | 90   | 11         | 0    | 21   | 38         | 10   | 57   |
| Growth Adj:                                 | 1.00        | 1.00 | 1.00 | 1.00        | 1.00 | 1.00 | 1.00       | 1.00 | 1.00 | 1.00       | 1.00 | 1.00 |
| Initial Bse:                                | 175         | 1228 | 52   | 55          | 372  | 90   | 11         | 0    | 21   | 38         | 10   | 57   |
| Added Vol:                                  | 0           | 0    | 0    | 0           | 0    | 0    | 0          | 0    | 0    | 0          | 0    | 0    |
| PasserByVol:                                | 0           | 0    | 0    | 0           | 0    | 0    | 0          | 0    | 0    | 0          | 0    | 0    |
| Initial Fut:                                | 175         | 1228 | 52   | 55          | 372  | 90   | 11         | 0    | 21   | 38         | 10   | 57   |
| User Adj:                                   | 1.00        | 1.00 | 1.00 | 1.00        | 1.00 | 1.00 | 1.00       | 1.00 | 1.00 | 1.00       | 1.00 | 1.00 |
| PHF Adj:                                    | 1.00        | 1.00 | 1.00 | 1.00        | 1.00 | 1.00 | 1.00       | 1.00 | 1.00 | 1.00       | 1.00 | 1.00 |
| PHF Volume:                                 | 175         | 1228 | 52   | 55          | 372  | 90   | 11         | 0    | 21   | 38         | 10   | 57   |
| Reduct Vol:                                 | 0           | 0    | 0    | 0           | 0    | 0    | 0          | 0    | 0    | 0          | 0    | 0    |
| Reduced Vol:                                | 175         | 1228 | 52   | 55          | 372  | 90   | 11         | 0    | 21   | 38         | 10   | 57   |
| PCE Adj:                                    | 1.00        | 1.00 | 1.00 | 1.00        | 1.00 | 1.00 | 1.00       | 1.00 | 1.00 | 1.00       | 1.00 | 1.00 |
| MLF Adj:                                    | 1.00        | 1.00 | 1.00 | 1.00        | 1.00 | 1.00 | 1.00       | 1.00 | 1.00 | 1.00       | 1.00 | 1.00 |
| Final Volume:                               | 175         | 1228 | 52   | 55          | 372  | 90   | 11         | 0    | 21   | 38         | 10   | 57   |
| Saturation Flow Module:                     |             |      |      |             |      |      |            |      |      |            |      |      |
| Sat/Lane:                                   | 1900        | 1900 | 1900 | 1900        | 1900 | 1900 | 1900       | 1900 | 1900 | 1900       | 1900 | 1900 |
| Adjustment:                                 | 0.92        | 0.98 | 0.95 | 0.92        | 0.99 | 0.95 | 0.92       | 1.00 | 0.92 | 0.92       | 0.95 | 0.95 |
| Lanes:                                      | 1.00        | 2.87 | 0.13 | 1.00        | 2.39 | 0.61 | 1.00       | 1.00 | 1.00 | 1.00       | 0.15 | 0.85 |
| Final Sat.:                                 | 1750        | 5372 | 227  | 1750        | 4508 | 1091 | 1750       | 1900 | 1750 | 1750       | 269  | 1531 |
| Capacity Analysis Module:                   |             |      |      |             |      |      |            |      |      |            |      |      |
| Vol/Sat:                                    | 0.10        | 0.23 | 0.23 | 0.03        | 0.08 | 0.08 | 0.01       | 0.00 | 0.01 | 0.02       | 0.04 | 0.04 |
| Crit Moves:                                 | ****        | **** | **** | ****        | **** | **** | ****       | **** | **** | ****       | **** | **** |
| Green Time:                                 | 16.9        | 34.0 | 34.0 | 7.0         | 24.1 | 24.1 | 10.0       | 0.0  | 26.9 | 10.0       | 10.0 | 10.0 |
| Volume/Cap:                                 | 0.36        | 0.40 | 0.40 | 0.27        | 0.21 | 0.21 | 0.04       | 0.00 | 0.03 | 0.13       | 0.22 | 0.22 |
| Delay/Veh:                                  | 17.7        | 7.4  | 7.4  | 24.9        | 11.7 | 11.7 | 21.0       | 0.0  | 9.3  | 21.5       | 22.0 | 22.0 |
| User DelAdj:                                | 1.00        | 1.00 | 1.00 | 1.00        | 1.00 | 1.00 | 1.00       | 1.00 | 1.00 | 1.00       | 1.00 | 1.00 |
| AdjDel/Veh:                                 | 17.7        | 7.4  | 7.4  | 24.9        | 11.7 | 11.7 | 21.0       | 0.0  | 9.3  | 21.5       | 22.0 | 22.0 |
| LOS by Move:                                | B           | A    | A    | C           | B    | B    | C          | A    | A    | C          | C    | C    |
| HCM2k95thQ:                                 | 6           | 9    | 9    | 2           | 4    | 4    | 0          | 0    | 1    | 2          | 3    | 3    |

Note: Queue reported is the number of cars per lane.

BART

Level Of Service Computation Report  
 2000 HCM Operations (Future Volume Alternative)  
 PM - Existing Conditions

Intersection #1012: El Camino Real/Railroad Ave [Study Int 53]

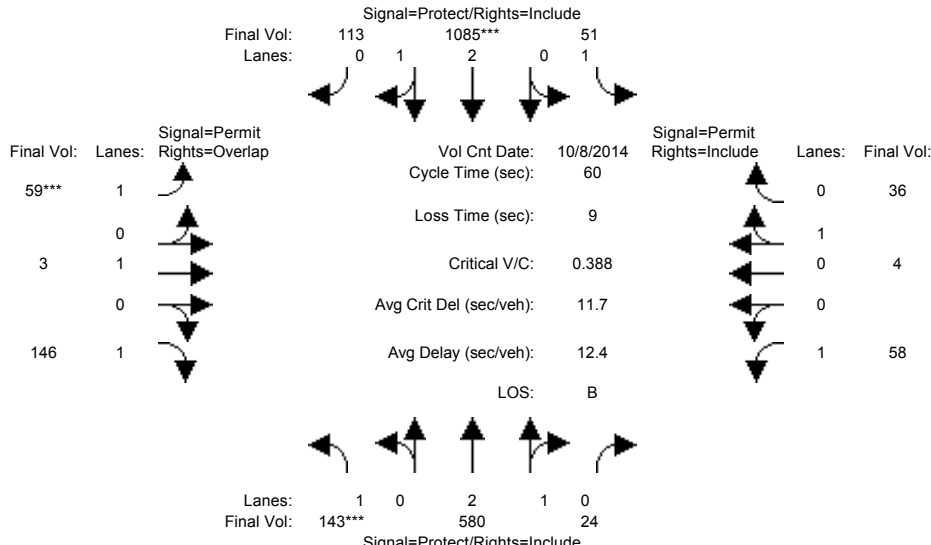

| Approach:   | North Bound   |      |      | South Bound |      |      | East Bound |      |      | West Bound |      |      |
|---|---------------|------|------|-------------|------|------|------------|------|------|------------|------|------|
| Movement:   | L             | T    | R    | L           | T    | R    | L          | T    | R    | L          | T    | R    |
| Min. Green:   | 7             | 10   | 10   | 7           | 10   | 10   | 10         | 10   | 10   | 10         | 10   | 10   |
| Y+R:  | 4.0           | 4.0  | 4.0  | 4.0         | 4.0  | 4.0  | 4.0        | 4.0  | 4.0  | 4.0        | 4.0  | 4.0  |
| ----- ----- ----- ----- ----- ----- ----- ----- ----- ----- ----- ----- ----- |               |      |      |             |      |      |            |      |      |            |      |      |
| Volume Module: >> Count Date:   | 8 Oct 2014 << |      |      |             |      |      |            |      |      |            |      |      |
| Base Vol:   | 143           | 580  | 24   | 51          | 1085 | 113  | 59         | 3    | 146  | 58         | 4    | 36   |
| Growth Adj:   | 1.00          | 1.00 | 1.00 | 1.00        | 1.00 | 1.00 | 1.00       | 1.00 | 1.00 | 1.00       | 1.00 | 1.00 |
| Initial Bse:  | 143           | 580  | 24   | 51          | 1085 | 113  | 59         | 3    | 146  | 58         | 4    | 36   |
| Added Vol:  | 0             | 0    | 0    | 0           | 0    | 0    | 0          | 0    | 0    | 0          | 0    | 0    |
| PasserByVol:  | 0             | 0    | 0    | 0           | 0    | 0    | 0          | 0    | 0    | 0          | 0    | 0    |
| Initial Fut:  | 143           | 580  | 24   | 51          | 1085 | 113  | 59         | 3    | 146  | 58         | 4    | 36   |
| User Adj:   | 1.00          | 1.00 | 1.00 | 1.00        | 1.00 | 1.00 | 1.00       | 1.00 | 1.00 | 1.00       | 1.00 | 1.00 |
| PHF Adj:  | 1.00          | 1.00 | 1.00 | 1.00        | 1.00 | 1.00 | 1.00       | 1.00 | 1.00 | 1.00       | 1.00 | 1.00 |
| PHF Volume:   | 143           | 580  | 24   | 51          | 1085 | 113  | 59         | 3    | 146  | 58         | 4    | 36   |
| Reduct Vol:   | 0             | 0    | 0    | 0           | 0    | 0    | 0          | 0    | 0    | 0          | 0    | 0    |
| Reduced Vol:  | 143           | 580  | 24   | 51          | 1085 | 113  | 59         | 3    | 146  | 58         | 4    | 36   |
| PCE Adj:  | 1.00          | 1.00 | 1.00 | 1.00        | 1.00 | 1.00 | 1.00       | 1.00 | 1.00 | 1.00       | 1.00 | 1.00 |
| MLF Adj:  | 1.00          | 1.00 | 1.00 | 1.00        | 1.00 | 1.00 | 1.00       | 1.00 | 1.00 | 1.00       | 1.00 | 1.00 |
| Final Volume:   | 143           | 580  | 24   | 51          | 1085 | 113  | 59         | 3    | 146  | 58         | 4    | 36   |
| ----- ----- ----- ----- ----- ----- ----- ----- ----- ----- ----- -----       |               |      |      |             |      |      |            |      |      |            |      |      |
| Saturation Flow Module:   |               |      |      |             |      |      |            |      |      |            |      |      |
| Sat/Lane:   | 1900          | 1900 | 1900 | 1900        | 1900 | 1900 | 1900       | 1900 | 1900 | 1900       | 1900 | 1900 |
| Adjustment:   | 0.92          | 0.98 | 0.95 | 0.92        | 0.99 | 0.95 | 0.92       | 1.00 | 0.92 | 0.92       | 0.95 | 0.95 |
| Lanes:  | 1.00          | 2.88 | 0.12 | 1.00        | 2.71 | 0.29 | 1.00       | 1.00 | 1.00 | 1.00       | 0.10 | 0.90 |
| Final Sat.:   | 1750          | 5377 | 223  | 1750        | 5071 | 528  | 1750       | 1900 | 1750 | 1750       | 180  | 1620 |
| ----- ----- ----- ----- ----- ----- ----- ----- ----- ----- ----- -----       |               |      |      |             |      |      |            |      |      |            |      |      |
| Capacity Analysis Module:   |               |      |      |             |      |      |            |      |      |            |      |      |
| Vol/Sat:  | 0.08          | 0.11 | 0.11 | 0.03        | 0.21 | 0.21 | 0.03       | 0.00 | 0.08 | 0.03       | 0.02 | 0.02 |
| Crit Moves:   | ****          |      |      |             |      |      |            |      |      |            |      |      |
| Green Time:   | 11.3          | 24.1 | 24.1 | 16.9        | 29.7 | 29.7 | 10.0       | 10.0 | 21.3 | 10.0       | 10.0 | 10.0 |
| Volume/Cap:   | 0.43          | 0.27 | 0.27 | 0.10        | 0.43 | 0.43 | 0.20       | 0.01 | 0.23 | 0.20       | 0.13 | 0.13 |
| Delay/Veh:  | 22.4          | 12.1 | 12.1 | 16.1        | 9.9  | 9.9  | 21.9       | 20.9 | 13.8 | 21.9       | 21.5 | 21.5 |
| User DelAdj:  | 1.00          | 1.00 | 1.00 | 1.00        | 1.00 | 1.00 | 1.00       | 1.00 | 1.00 | 1.00       | 1.00 | 1.00 |
| AdjDel/Veh:   | 22.4          | 12.1 | 12.1 | 16.1        | 9.9  | 9.9  | 21.9       | 20.9 | 13.8 | 21.9       | 21.5 | 21.5 |
| LOS by Move:  | C             | B    | B    | B           | A    | A    | C          | C    | B    | C          | C    | C    |
| HCM2k95thQ:   | 6             | 5    | 5    | 1           | 9    | 9    | 2          | 0    | 4    | 2          | 2    | 2    |

Note: Queue reported is the number of cars per lane.

BART

Level Of Service Computation Report  
 2000 HCM Operations (Future Volume Alternative)  
 AM - Existing Conditions

Intersection #1202: LAFAYETTE/EL CAMINO REAL [Study Int 46]

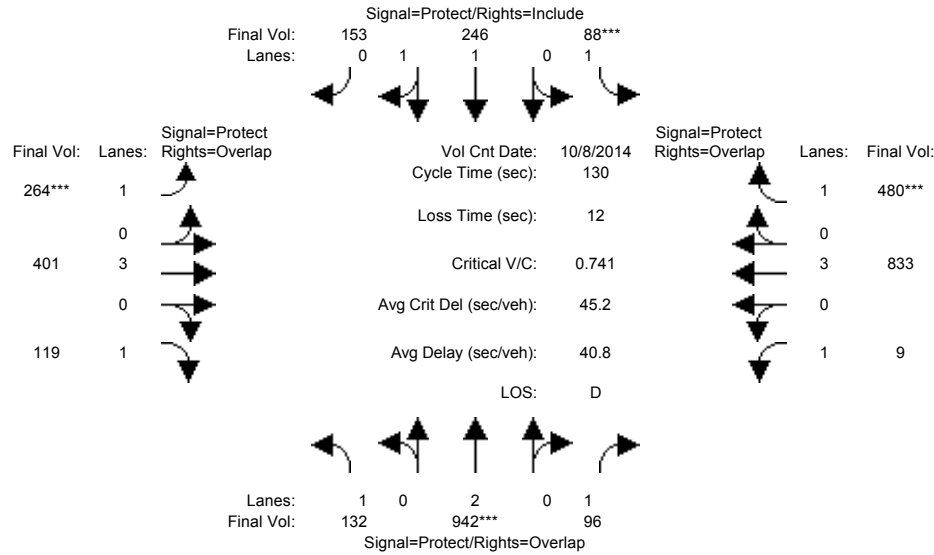

| Approach:                                   | North Bound |      |      | South Bound |      |      | East Bound |      |      | West Bound |      |      |
|---|-------------|------|------|-------------|------|------|------------|------|------|------------|------|------|
| Movement:                                   | L           | T    | R    | L           | T    | R    | L          | T    | R    | L          | T    | R    |
| Min. Green:                                 | 7           | 10   | 10   | 7           | 10   | 10   | 7          | 10   | 10   | 7          | 10   | 10   |
| Y+R:  | 4.0         | 4.0  | 4.0  | 4.0         | 4.0  | 4.0  | 4.0        | 4.0  | 4.0  | 4.0        | 4.0  | 4.0  |
| Volume Module: >> Count Date: 8 Oct 2014 << |             |      |      |             |      |      |            |      |      |            |      |      |
| Base Vol:                                   | 132         | 942  | 96   | 88          | 246  | 153  | 264        | 401  | 119  | 9          | 833  | 480  |
| Growth Adj:                                 | 1.00        | 1.00 | 1.00 | 1.00        | 1.00 | 1.00 | 1.00       | 1.00 | 1.00 | 1.00       | 1.00 | 1.00 |
| Initial Bse:                                | 132         | 942  | 96   | 88          | 246  | 153  | 264        | 401  | 119  | 9          | 833  | 480  |
| Added Vol:                                  | 0           | 0    | 0    | 0           | 0    | 0    | 0          | 0    | 0    | 0          | 0    | 0    |
| PasserByVol:                                | 0           | 0    | 0    | 0           | 0    | 0    | 0          | 0    | 0    | 0          | 0    | 0    |
| Initial Fut:                                | 132         | 942  | 96   | 88          | 246  | 153  | 264        | 401  | 119  | 9          | 833  | 480  |
| User Adj:                                   | 1.00        | 1.00 | 1.00 | 1.00        | 1.00 | 1.00 | 1.00       | 1.00 | 1.00 | 1.00       | 1.00 | 1.00 |
| PHF Adj:                                    | 1.00        | 1.00 | 1.00 | 1.00        | 1.00 | 1.00 | 1.00       | 1.00 | 1.00 | 1.00       | 1.00 | 1.00 |
| PHF Volume:                                 | 132         | 942  | 96   | 88          | 246  | 153  | 264        | 401  | 119  | 9          | 833  | 480  |
| Reduct Vol:                                 | 0           | 0    | 0    | 0           | 0    | 0    | 0          | 0    | 0    | 0          | 0    | 0    |
| Reduced Vol:                                | 132         | 942  | 96   | 88          | 246  | 153  | 264        | 401  | 119  | 9          | 833  | 480  |
| PCE Adj:                                    | 1.00        | 1.00 | 1.00 | 1.00        | 1.00 | 1.00 | 1.00       | 1.00 | 1.00 | 1.00       | 1.00 | 1.00 |
| MLF Adj:                                    | 1.00        | 1.00 | 1.00 | 1.00        | 1.00 | 1.00 | 1.00       | 1.00 | 1.00 | 1.00       | 1.00 | 1.00 |
| Final Volume:                               | 132         | 942  | 96   | 88          | 246  | 153  | 264        | 401  | 119  | 9          | 833  | 480  |
| Saturation Flow Module:                     |             |      |      |             |      |      |            |      |      |            |      |      |
| Sat/Lane:                                   | 1900        | 1900 | 1900 | 1900        | 1900 | 1900 | 1900       | 1900 | 1900 | 1900       | 1900 | 1900 |
| Adjustment:                                 | 0.92        | 1.00 | 0.92 | 0.92        | 0.99 | 0.95 | 0.92       | 1.00 | 0.92 | 0.92       | 1.00 | 0.92 |
| Lanes:                                      | 1.00        | 2.00 | 1.00 | 1.00        | 1.21 | 0.79 | 1.00       | 3.00 | 1.00 | 1.00       | 3.00 | 1.00 |
| Final Sat.:                                 | 1750        | 3800 | 1750 | 1750        | 2280 | 1418 | 1750       | 5700 | 1750 | 1750       | 5700 | 1750 |
| Capacity Analysis Module:                   |             |      |      |             |      |      |            |      |      |            |      |      |
| Vol/Sat:                                    | 0.08        | 0.25 | 0.05 | 0.05        | 0.11 | 0.11 | 0.15       | 0.07 | 0.07 | 0.01       | 0.15 | 0.27 |
| Crit Moves:                                 | ****        | **** | **** | ****        | **** | **** | ****       | **** | **** | ****       | **** | **** |
| Green Time:                                 | 21.5        | 43.5 | 70.3 | 8.8         | 30.8 | 30.8 | 26.4       | 38.3 | 59.8 | 26.8       | 38.6 | 47.5 |
| Volume/Cap:                                 | 0.46        | 0.74 | 0.10 | 0.74        | 0.46 | 0.46 | 0.74       | 0.24 | 0.15 | 0.02       | 0.49 | 0.75 |
| Delay/Veh:                                  | 50.1        | 40.7 | 14.6 | 81.4        | 42.8 | 42.8 | 56.7       | 34.9 | 20.4 | 41.2       | 37.8 | 41.1 |
| User DelAdj:                                | 1.00        | 1.00 | 1.00 | 1.00        | 1.00 | 1.00 | 1.00       | 1.00 | 1.00 | 1.00       | 1.00 | 1.00 |
| AdjDel/Veh:                                 | 50.1        | 40.7 | 14.6 | 81.4        | 42.8 | 42.8 | 56.7       | 34.9 | 20.4 | 41.2       | 37.8 | 41.1 |
| LOS by Move:                                | D           | D    | B    | F           | D    | D    | E          | C    | C    | D          | D    | D    |
| HCM2k95thQ:                                 | 10          | 29   | 4    | 8           | 13   | 13   | 20         | 8    | 6    | 1          | 17   | 33   |

Note: Queue reported is the number of cars per lane.

BART

Level Of Service Computation Report  
2000 HCM Operations (Future Volume Alternative)  
PM - Existing Conditions

Intersection #1202: LAFAYETTE/EL CAMINO REAL [Study Int 46]

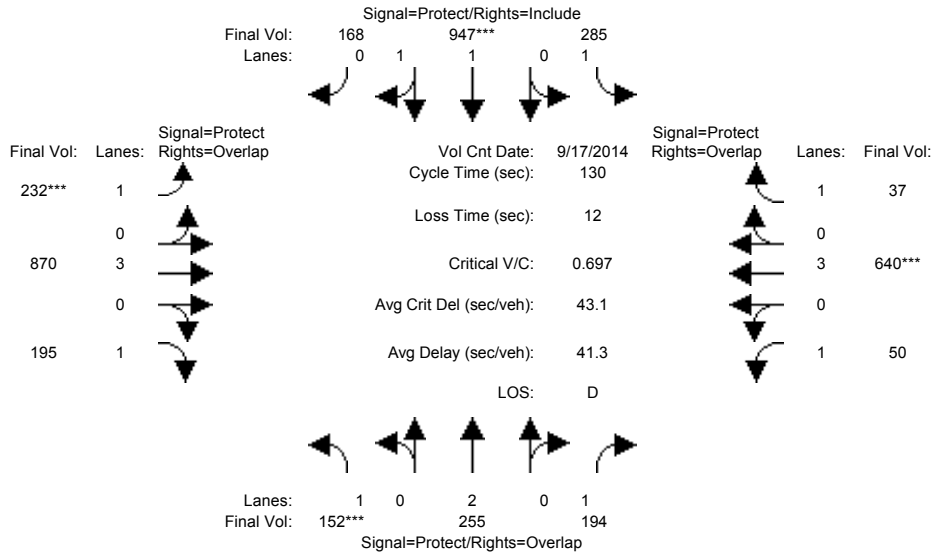

| Approach:                                    | North Bound |      |      | South Bound |      |      | East Bound |      |      | West Bound |      |      |
|--|-------------|------|------|-------------|------|------|------------|------|------|------------|------|------|
| Movement:                                    | L           | T    | R    | L           | T    | R    | L          | T    | R    | L          | T    | R    |
| Min. Green:                                  | 7           | 10   | 10   | 7           | 10   | 10   | 7          | 10   | 10   | 7          | 10   | 10   |
| Y+R:   | 4.0         | 4.0  | 4.0  | 4.0         | 4.0  | 4.0  | 4.0        | 4.0  | 4.0  | 4.0        | 4.0  | 4.0  |
| Volume Module: >> Count Date: 17 Sep 2014 << |             |      |      |             |      |      |            |      |      |            |      |      |
| Base Vol:                                    | 152         | 255  | 194  | 285         | 947  | 168  | 232        | 870  | 195  | 50         | 640  | 37   |
| Growth Adj:                                  | 1.00        | 1.00 | 1.00 | 1.00        | 1.00 | 1.00 | 1.00       | 1.00 | 1.00 | 1.00       | 1.00 | 1.00 |
| Initial Bse:                                 | 152         | 255  | 194  | 285         | 947  | 168  | 232        | 870  | 195  | 50         | 640  | 37   |
| Added Vol:                                   | 0           | 0    | 0    | 0           | 0    | 0    | 0          | 0    | 0    | 0          | 0    | 0    |
| PasserByVol:                                 | 0           | 0    | 0    | 0           | 0    | 0    | 0          | 0    | 0    | 0          | 0    | 0    |
| Initial Fut:                                 | 152         | 255  | 194  | 285         | 947  | 168  | 232        | 870  | 195  | 50         | 640  | 37   |
| User Adj:                                    | 1.00        | 1.00 | 1.00 | 1.00        | 1.00 | 1.00 | 1.00       | 1.00 | 1.00 | 1.00       | 1.00 | 1.00 |
| PHF Adj:                                     | 1.00        | 1.00 | 1.00 | 1.00        | 1.00 | 1.00 | 1.00       | 1.00 | 1.00 | 1.00       | 1.00 | 1.00 |
| PHF Volume:                                  | 152         | 255  | 194  | 285         | 947  | 168  | 232        | 870  | 195  | 50         | 640  | 37   |
| Reduct Vol:                                  | 0           | 0    | 0    | 0           | 0    | 0    | 0          | 0    | 0    | 0          | 0    | 0    |
| Reduced Vol:                                 | 152         | 255  | 194  | 285         | 947  | 168  | 232        | 870  | 195  | 50         | 640  | 37   |
| PCE Adj:                                     | 1.00        | 1.00 | 1.00 | 1.00        | 1.00 | 1.00 | 1.00       | 1.00 | 1.00 | 1.00       | 1.00 | 1.00 |
| MLF Adj:                                     | 1.00        | 1.00 | 1.00 | 1.00        | 1.00 | 1.00 | 1.00       | 1.00 | 1.00 | 1.00       | 1.00 | 1.00 |
| Final Volume:                                | 152         | 255  | 194  | 285         | 947  | 168  | 232        | 870  | 195  | 50         | 640  | 37   |
| Saturation Flow Module:                      |             |      |      |             |      |      |            |      |      |            |      |      |
| Sat/Lane:                                    | 1900        | 1900 | 1900 | 1900        | 1900 | 1900 | 1900       | 1900 | 1900 | 1900       | 1900 | 1900 |
| Adjustment:                                  | 0.92        | 1.00 | 0.92 | 0.92        | 0.98 | 0.95 | 0.92       | 1.00 | 0.92 | 0.92       | 1.00 | 0.92 |
| Lanes:                                       | 1.00        | 2.00 | 1.00 | 1.00        | 1.69 | 0.31 | 1.00       | 3.00 | 1.00 | 1.00       | 3.00 | 1.00 |
| Final Sat.:                                  | 1750        | 3800 | 1750 | 1750        | 3142 | 557  | 1750       | 5700 | 1750 | 1750       | 5700 | 1750 |
| Capacity Analysis Module:                    |             |      |      |             |      |      |            |      |      |            |      |      |
| Vol/Sat:                                     | 0.09        | 0.07 | 0.11 | 0.16        | 0.30 | 0.30 | 0.13       | 0.15 | 0.11 | 0.03       | 0.11 | 0.02 |
| Crit Moves:                                  | ****        |      |      | ****        |      |      | ****       |      |      | ****       |      |      |
| Green Time:                                  | 16.2        | 24.3 | 36.2 | 48.1        | 56.2 | 56.2 | 24.7       | 33.7 | 49.9 | 11.9       | 20.9 | 69.0 |
| Volume/Cap:                                  | 0.70        | 0.36 | 0.40 | 0.44        | 0.70 | 0.70 | 0.70       | 0.59 | 0.29 | 0.31       | 0.70 | 0.04 |
| Delay/Veh:                                   | 64.1        | 46.4 | 38.6 | 31.3        | 31.4 | 31.4 | 55.5       | 42.7 | 28.0 | 56.3       | 53.9 | 14.6 |
| User DelAdj:                                 | 1.00        | 1.00 | 1.00 | 1.00        | 1.00 | 1.00 | 1.00       | 1.00 | 1.00 | 1.00       | 1.00 | 1.00 |
| AdjDel/Veh:                                  | 64.1        | 46.4 | 38.6 | 31.3        | 31.4 | 31.4 | 55.5       | 42.7 | 28.0 | 56.3       | 53.9 | 14.6 |
| LOS by Move:                                 | E           | D    | D    | C           | C    | C    | E          | D    | C    | E          | D    | B    |
| HCM2k95thQ:                                  | 12          | 8    | 13   | 17          | 32   | 32   | 17         | 18   | 11   | 5          | 17   | 2    |

Note: Queue reported is the number of cars per lane.

BART

Level Of Service Computation Report  
2000 HCM Operations (Future Volume Alternative)  
AM - Existing Conditions

Intersection #1203: ECR/Lincoln 1203 [Study Int 43]

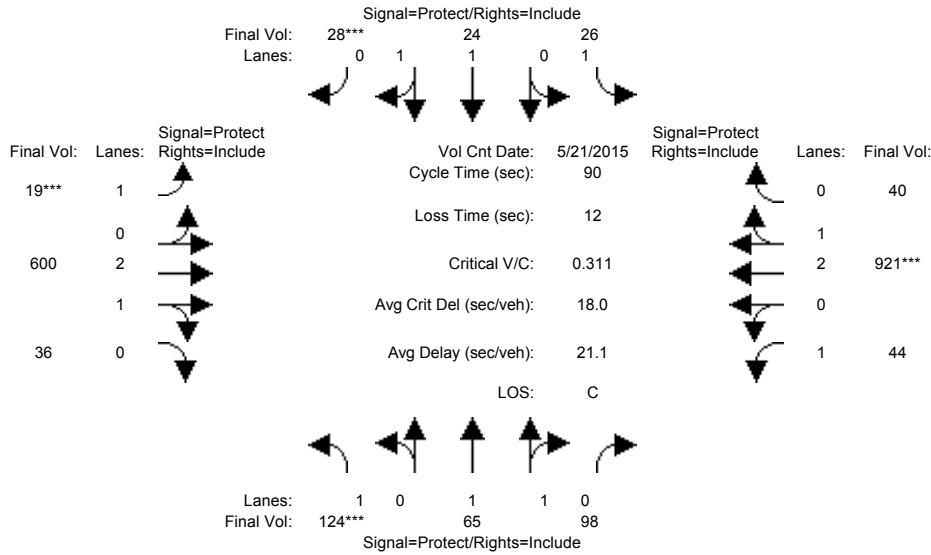

| Approach:                                    | North Bound |      |      | South Bound |      |      | East Bound |      |      | West Bound |      |      |
|--|-------------|------|------|-------------|------|------|------------|------|------|------------|------|------|
| Movement:                                    | L           | T    | R    | L           | T    | R    | L          | T    | R    | L          | T    | R    |
| Min. Green:                                  | 7           | 10   | 10   | 7           | 10   | 10   | 7          | 10   | 10   | 7          | 10   | 10   |
| Y+R:   | 4.0         | 4.0  | 4.0  | 4.0         | 4.0  | 4.0  | 4.0        | 4.0  | 4.0  | 4.0        | 4.0  | 4.0  |
| Volume Module: >> Count Date: 21 May 2015 << |             |      |      |             |      |      |            |      |      |            |      |      |
| Base Vol:                                    | 124         | 65   | 98   | 26          | 24   | 28   | 19         | 600  | 36   | 44         | 921  | 40   |
| Growth Adj:                                  | 1.00        | 1.00 | 1.00 | 1.00        | 1.00 | 1.00 | 1.00       | 1.00 | 1.00 | 1.00       | 1.00 | 1.00 |
| Initial Bse:                                 | 124         | 65   | 98   | 26          | 24   | 28   | 19         | 600  | 36   | 44         | 921  | 40   |
| Added Vol:                                   | 0           | 0    | 0    | 0           | 0    | 0    | 0          | 0    | 0    | 0          | 0    | 0    |
| PasserByVol:                                 | 0           | 0    | 0    | 0           | 0    | 0    | 0          | 0    | 0    | 0          | 0    | 0    |
| Initial Fut:                                 | 124         | 65   | 98   | 26          | 24   | 28   | 19         | 600  | 36   | 44         | 921  | 40   |
| User Adj:                                    | 1.00        | 1.00 | 1.00 | 1.00        | 1.00 | 1.00 | 1.00       | 1.00 | 1.00 | 1.00       | 1.00 | 1.00 |
| PHF Adj:                                     | 1.00        | 1.00 | 1.00 | 1.00        | 1.00 | 1.00 | 1.00       | 1.00 | 1.00 | 1.00       | 1.00 | 1.00 |
| PHF Volume:                                  | 124         | 65   | 98   | 26          | 24   | 28   | 19         | 600  | 36   | 44         | 921  | 40   |
| Reduct Vol:                                  | 0           | 0    | 0    | 0           | 0    | 0    | 0          | 0    | 0    | 0          | 0    | 0    |
| Reduced Vol:                                 | 124         | 65   | 98   | 26          | 24   | 28   | 19         | 600  | 36   | 44         | 921  | 40   |
| PCE Adj:                                     | 1.00        | 1.00 | 1.00 | 1.00        | 1.00 | 1.00 | 1.00       | 1.00 | 1.00 | 1.00       | 1.00 | 1.00 |
| MLF Adj:                                     | 1.00        | 1.00 | 1.00 | 1.00        | 1.00 | 1.00 | 1.00       | 1.00 | 1.00 | 1.00       | 1.00 | 1.00 |
| Final Volume:                                | 124         | 65   | 98   | 26          | 24   | 28   | 19         | 600  | 36   | 44         | 921  | 40   |
| Saturation Flow Module:                      |             |      |      |             |      |      |            |      |      |            |      |      |
| Sat/Lane:                                    | 1900        | 1900 | 1900 | 1900        | 1900 | 1900 | 1900       | 1900 | 1900 | 1900       | 1900 | 1900 |
| Adjustment:                                  | 0.92        | 1.00 | 0.92 | 0.92        | 1.00 | 0.92 | 0.92       | 0.98 | 0.95 | 0.92       | 0.98 | 0.95 |
| Lanes:                                       | 1.00        | 1.00 | 1.00 | 1.00        | 1.00 | 1.00 | 1.00       | 2.82 | 0.18 | 1.00       | 2.87 | 0.13 |
| Final Sat.:                                  | 1750        | 1900 | 1750 | 1750        | 1900 | 1750 | 1750       | 5283 | 317  | 1750       | 5367 | 233  |
| Capacity Analysis Module:                    |             |      |      |             |      |      |            |      |      |            |      |      |
| Vol/Sat:                                     | 0.07        | 0.03 | 0.06 | 0.01        | 0.01 | 0.02 | 0.01       | 0.11 | 0.11 | 0.03       | 0.17 | 0.17 |
| Crit Moves:                                  | ****        |      |      | ****        | **** | **** | ****       | **** | **** | ****       | **** | **** |
| Green Time:                                  | 17.8        | 16.4 | 16.4 | 11.5        | 10.0 | 10.0 | 7.0        | 29.8 | 29.8 | 20.4       | 43.2 | 43.2 |
| Volume/Cap:                                  | 0.36        | 0.19 | 0.31 | 0.12        | 0.11 | 0.14 | 0.14       | 0.34 | 0.34 | 0.11       | 0.36 | 0.36 |
| Delay/Veh:                                   | 31.8        | 31.3 | 32.2 | 35.0        | 36.1 | 36.3 | 39.2       | 22.8 | 22.8 | 27.7       | 14.8 | 14.8 |
| User DelAdj:                                 | 1.00        | 1.00 | 1.00 | 1.00        | 1.00 | 1.00 | 1.00       | 1.00 | 1.00 | 1.00       | 1.00 | 1.00 |
| AdjDel/Veh:                                  | 31.8        | 31.3 | 32.2 | 35.0        | 36.1 | 36.3 | 39.2       | 22.8 | 22.8 | 27.7       | 14.8 | 14.8 |
| LOS by Move:                                 | C           | C    | C    | D           | D    | D    | D          | C    | C    | C          | B    | B    |
| HCM2k95thQ:                                  | 6           | 3    | 5    | 2           | 1    | 2    | 1          | 9    | 9    | 2          | 11   | 11   |

Note: Queue reported is the number of cars per lane.



BART

Level Of Service Computation Report  
2000 HCM Operations (Future Volume Alternative)  
PM - Existing Conditions

Intersection #1203: ECR/Lincoln 1203 [Study Int 43]

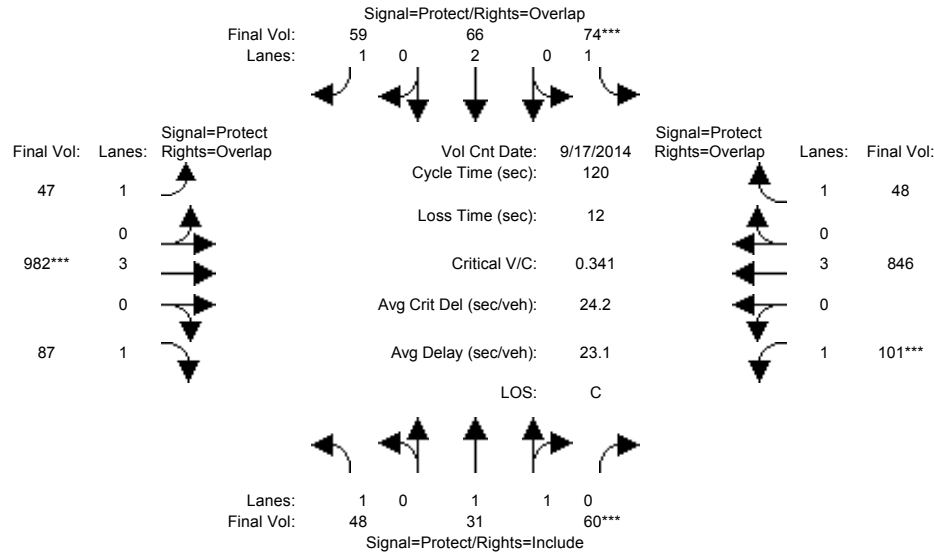

| Approach:  | North Bound |      |      | South Bound |      |      | East Bound |      |      | West Bound |      |      |
|--|-------------|------|------|-------------|------|------|------------|------|------|------------|------|------|
| Movement:  | L           | T    | R    | L           | T    | R    | L          | T    | R    | L          | T    | R    |
| Min. Green:  | 7           | 10   | 10   | 7           | 10   | 10   | 7          | 10   | 10   | 7          | 10   | 10   |
| Y+R:   | 4.0         | 4.0  | 4.0  | 4.0         | 4.0  | 4.0  | 4.0        | 4.0  | 4.0  | 4.0        | 4.0  | 4.0  |
| Volume Module: >> Count Date: 17 Sep 2014 << 4:45-5:45PM |             |      |      |             |      |      |            |      |      |            |      |      |
| Base Vol:  | 48          | 31   | 60   | 74          | 66   | 59   | 47         | 982  | 87   | 101        | 846  | 48   |
| Growth Adj:  | 1.00        | 1.00 | 1.00 | 1.00        | 1.00 | 1.00 | 1.00       | 1.00 | 1.00 | 1.00       | 1.00 | 1.00 |
| Initial Bse:   | 48          | 31   | 60   | 74          | 66   | 59   | 47         | 982  | 87   | 101        | 846  | 48   |
| Added Vol:   | 0           | 0    | 0    | 0           | 0    | 0    | 0          | 0    | 0    | 0          | 0    | 0    |
| PasserByVol:   | 0           | 0    | 0    | 0           | 0    | 0    | 0          | 0    | 0    | 0          | 0    | 0    |
| Initial Fut:   | 48          | 31   | 60   | 74          | 66   | 59   | 47         | 982  | 87   | 101        | 846  | 48   |
| User Adj:  | 1.00        | 1.00 | 1.00 | 1.00        | 1.00 | 1.00 | 1.00       | 1.00 | 1.00 | 1.00       | 1.00 | 1.00 |
| PHF Adj:   | 1.00        | 1.00 | 1.00 | 1.00        | 1.00 | 1.00 | 1.00       | 1.00 | 1.00 | 1.00       | 1.00 | 1.00 |
| PHF Volume:  | 48          | 31   | 60   | 74          | 66   | 59   | 47         | 982  | 87   | 101        | 846  | 48   |
| Reduct Vol:  | 0           | 0    | 0    | 0           | 0    | 0    | 0          | 0    | 0    | 0          | 0    | 0    |
| Reduced Vol:   | 48          | 31   | 60   | 74          | 66   | 59   | 47         | 982  | 87   | 101        | 846  | 48   |
| PCE Adj:   | 1.00        | 1.00 | 1.00 | 1.00        | 1.00 | 1.00 | 1.00       | 1.00 | 1.00 | 1.00       | 1.00 | 1.00 |
| MLF Adj:   | 1.00        | 1.00 | 1.00 | 1.00        | 1.00 | 1.00 | 1.00       | 1.00 | 1.00 | 1.00       | 1.00 | 1.00 |
| Final Volume:  | 48          | 31   | 60   | 74          | 66   | 59   | 47         | 982  | 87   | 101        | 846  | 48   |
| Saturation Flow Module:                                  |             |      |      |             |      |      |            |      |      |            |      |      |
| Sat/Lane:  | 1900        | 1900 | 1900 | 1900        | 1900 | 1900 | 1900       | 1900 | 1900 | 1900       | 1900 | 1900 |
| Adjustment:  | 0.92        | 1.00 | 0.92 | 0.92        | 1.00 | 0.92 | 0.92       | 1.00 | 0.92 | 0.92       | 1.00 | 0.92 |
| Lanes:   | 1.00        | 1.00 | 1.00 | 1.00        | 2.00 | 1.00 | 1.00       | 3.00 | 1.00 | 1.00       | 3.00 | 1.00 |
| Final Sat.:  | 1750        | 1900 | 1750 | 1750        | 3800 | 1750 | 1750       | 5700 | 1750 | 1750       | 5700 | 1750 |
| Capacity Analysis Module:                                |             |      |      |             |      |      |            |      |      |            |      |      |
| Vol/Sat:   | 0.03        | 0.02 | 0.03 | 0.04        | 0.02 | 0.03 | 0.03       | 0.17 | 0.05 | 0.06       | 0.15 | 0.03 |
| Crit Moves:  | ****        | **** | **** | ****        | **** | **** | ****       | **** | **** | ****       | **** | **** |
| Green Time:  | 11.1        | 12.1 | 12.1 | 14.9        | 15.9 | 38.7 | 22.9       | 60.7 | 71.8 | 20.3       | 58.2 | 73.1 |
| Volume/Cap:  | 0.30        | 0.16 | 0.34 | 0.34        | 0.13 | 0.10 | 0.14       | 0.34 | 0.08 | 0.34       | 0.31 | 0.05 |
| Delay/Veh:   | 51.8        | 49.5 | 51.0 | 49.0        | 46.1 | 28.6 | 40.6       | 17.8 | 10.2 | 44.6       | 18.8 | 9.5  |
| User DelAdj:   | 1.00        | 1.00 | 1.00 | 1.00        | 1.00 | 1.00 | 1.00       | 1.00 | 1.00 | 1.00       | 1.00 | 1.00 |
| AdjDel/Veh:  | 51.8        | 49.5 | 51.0 | 49.0        | 46.1 | 28.6 | 40.6       | 17.8 | 10.2 | 44.6       | 18.8 | 9.5  |
| LOS by Move:   | D           | D    | D    | D           | D    | C    | D          | B    | B    | D          | B    | A    |
| HCM2k95thQ:  | 4           | 2    | 4    | 6           | 2    | 3    | 3          | 13   | 3    | 7          | 12   | 2    |

Note: Queue reported is the number of cars per lane.

BART

Level Of Service Computation Report  
 2000 HCM Operations (Future Volume Alternative)  
 AM - Existing Conditions

Intersection #1204: MONROE/EL CAMINO REAL [Study Int 44]

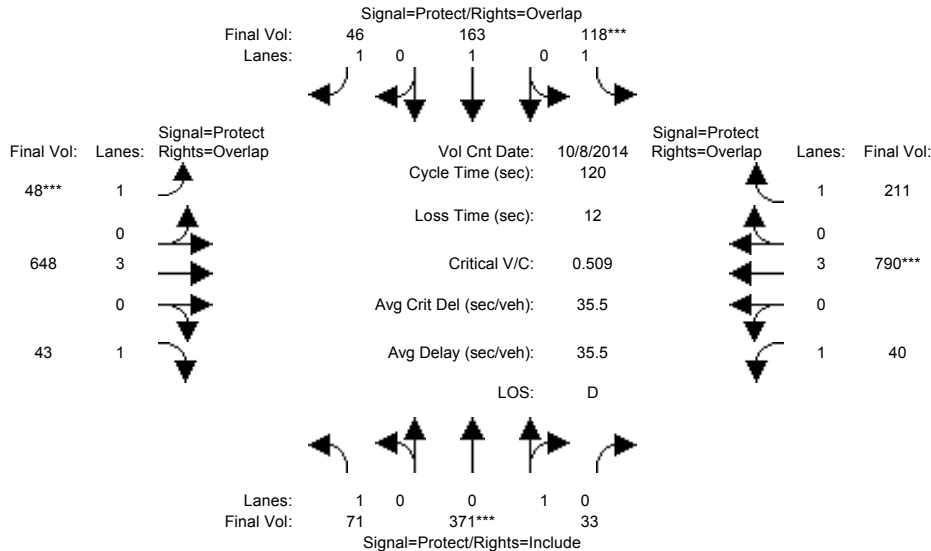

| Approach:                                   | North Bound |      |      | South Bound |      |      | East Bound |      |      | West Bound |      |      |
|---|-------------|------|------|-------------|------|------|------------|------|------|------------|------|------|
| Movement:                                   | L           | T    | R    | L           | T    | R    | L          | T    | R    | L          | T    | R    |
| Min. Green:                                 | 7           | 10   | 10   | 7           | 10   | 10   | 7          | 10   | 10   | 7          | 10   | 10   |
| Y+R:  | 4.0         | 4.0  | 4.0  | 4.0         | 4.0  | 4.0  | 4.0        | 4.0  | 4.0  | 4.0        | 4.0  | 4.0  |
| Volume Module: >> Count Date: 8 Oct 2014 << |             |      |      |             |      |      |            |      |      |            |      |      |
| Base Vol:                                   | 71          | 371  | 33   | 118         | 163  | 46   | 48         | 648  | 43   | 40         | 790  | 211  |
| Growth Adj:                                 | 1.00        | 1.00 | 1.00 | 1.00        | 1.00 | 1.00 | 1.00       | 1.00 | 1.00 | 1.00       | 1.00 | 1.00 |
| Initial Bse:                                | 71          | 371  | 33   | 118         | 163  | 46   | 48         | 648  | 43   | 40         | 790  | 211  |
| Added Vol:                                  | 0           | 0    | 0    | 0           | 0    | 0    | 0          | 0    | 0    | 0          | 0    | 0    |
| PasserByVol:                                | 0           | 0    | 0    | 0           | 0    | 0    | 0          | 0    | 0    | 0          | 0    | 0    |
| Initial Fut:                                | 71          | 371  | 33   | 118         | 163  | 46   | 48         | 648  | 43   | 40         | 790  | 211  |
| User Adj:                                   | 1.00        | 1.00 | 1.00 | 1.00        | 1.00 | 1.00 | 1.00       | 1.00 | 1.00 | 1.00       | 1.00 | 1.00 |
| PHF Adj:                                    | 1.00        | 1.00 | 1.00 | 1.00        | 1.00 | 1.00 | 1.00       | 1.00 | 1.00 | 1.00       | 1.00 | 1.00 |
| PHF Volume:                                 | 71          | 371  | 33   | 118         | 163  | 46   | 48         | 648  | 43   | 40         | 790  | 211  |
| Reduct Vol:                                 | 0           | 0    | 0    | 0           | 0    | 0    | 0          | 0    | 0    | 0          | 0    | 0    |
| Reduced Vol:                                | 71          | 371  | 33   | 118         | 163  | 46   | 48         | 648  | 43   | 40         | 790  | 211  |
| PCE Adj:                                    | 1.00        | 1.00 | 1.00 | 1.00        | 1.00 | 1.00 | 1.00       | 1.00 | 1.00 | 1.00       | 1.00 | 1.00 |
| MLF Adj:                                    | 1.00        | 1.00 | 1.00 | 1.00        | 1.00 | 1.00 | 1.00       | 1.00 | 1.00 | 1.00       | 1.00 | 1.00 |
| Final Volume:                               | 71          | 371  | 33   | 118         | 163  | 46   | 48         | 648  | 43   | 40         | 790  | 211  |
| Saturation Flow Module:                     |             |      |      |             |      |      |            |      |      |            |      |      |
| Sat/Lane:                                   | 1900        | 1900 | 1900 | 1900        | 1900 | 1900 | 1900       | 1900 | 1900 | 1900       | 1900 | 1900 |
| Adjustment:                                 | 0.92        | 0.95 | 0.95 | 0.92        | 1.00 | 0.92 | 0.92       | 1.00 | 0.92 | 0.92       | 1.00 | 0.92 |
| Lanes:                                      | 1.00        | 0.92 | 0.08 | 1.00        | 1.00 | 1.00 | 1.00       | 3.00 | 1.00 | 1.00       | 3.00 | 1.00 |
| Final Sat.:                                 | 1750        | 1653 | 147  | 1750        | 1900 | 1750 | 1750       | 5700 | 1750 | 1750       | 5700 | 1750 |
| Capacity Analysis Module:                   |             |      |      |             |      |      |            |      |      |            |      |      |
| Vol/Sat:                                    | 0.04        | 0.22 | 0.22 | 0.07        | 0.09 | 0.03 | 0.03       | 0.11 | 0.02 | 0.02       | 0.14 | 0.12 |
| Crit Moves:                                 | ****        | **** | **** | ****        | **** | **** | ****       | **** | **** | ****       | **** | **** |
| Green Time:                                 | 27.7        | 52.7 | 52.7 | 15.8        | 40.8 | 47.8 | 7.0        | 26.1 | 53.8 | 13.4       | 32.5 | 48.3 |
| Volume/Cap:                                 | 0.18        | 0.51 | 0.51 | 0.51        | 0.25 | 0.07 | 0.47       | 0.52 | 0.05 | 0.20       | 0.51 | 0.30 |
| Delay/Veh:                                  | 37.2        | 24.9 | 24.9 | 50.4        | 28.8 | 22.4 | 58.1       | 41.8 | 18.7 | 49.0       | 37.3 | 24.6 |
| User DelAdj:                                | 1.00        | 1.00 | 1.00 | 1.00        | 1.00 | 1.00 | 1.00       | 1.00 | 1.00 | 1.00       | 1.00 | 1.00 |
| AdjDel/Veh:                                 | 37.2        | 24.9 | 24.9 | 50.4        | 28.8 | 22.4 | 58.1       | 41.8 | 18.7 | 49.0       | 37.3 | 24.6 |
| LOS by Move:                                | D           | C    | C    | D           | C    | C    | E          | D    | B    | D          | D    | C    |
| HCM2k95thQ:                                 | 5           | 21   | 21   | 9           | 8    | 2    | 4          | 13   | 2    | 3          | 15   | 11   |

Note: Queue reported is the number of cars per lane.

BART

Level Of Service Computation Report  
2000 HCM Operations (Future Volume Alternative)  
PM - Existing Conditions

Intersection #1204: MONROE/EL CAMINO REAL [Study Int 44]

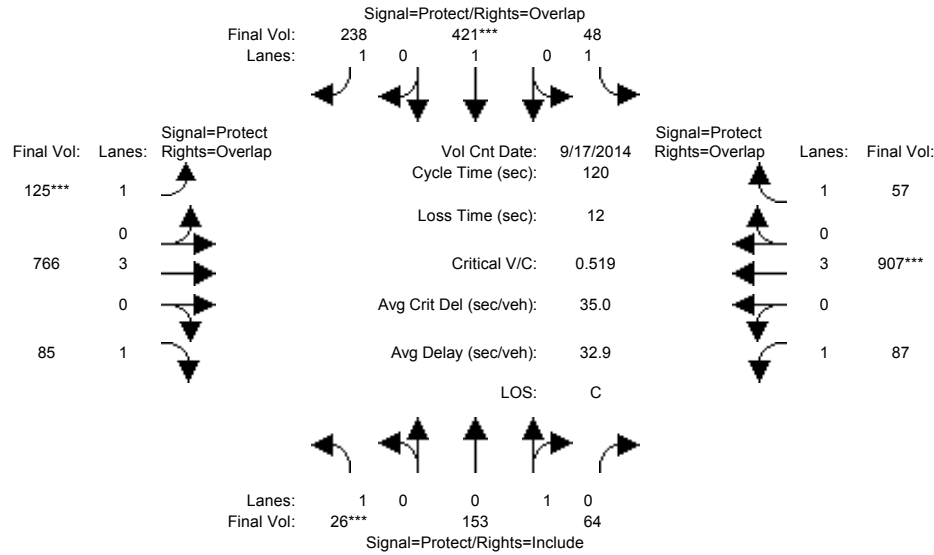

| Approach:                                    | North Bound |      |      | South Bound |      |      | East Bound |      |      | West Bound |      |      |
|--|-------------|------|------|-------------|------|------|------------|------|------|------------|------|------|
| Movement:                                    | L           | T    | R    | L           | T    | R    | L          | T    | R    | L          | T    | R    |
| Min. Green:                                  | 7           | 10   | 10   | 7           | 10   | 10   | 7          | 10   | 10   | 7          | 10   | 10   |
| Y+R:   | 4.0         | 4.0  | 4.0  | 4.0         | 4.0  | 4.0  | 4.0        | 4.0  | 4.0  | 4.0        | 4.0  | 4.0  |
| Volume Module: >> Count Date: 17 Sep 2014 << |             |      |      |             |      |      |            |      |      |            |      |      |
| Base Vol:                                    | 26          | 153  | 64   | 48          | 421  | 238  | 125        | 766  | 85   | 87         | 907  | 57   |
| Growth Adj:                                  | 1.00        | 1.00 | 1.00 | 1.00        | 1.00 | 1.00 | 1.00       | 1.00 | 1.00 | 1.00       | 1.00 | 1.00 |
| Initial Bse:                                 | 26          | 153  | 64   | 48          | 421  | 238  | 125        | 766  | 85   | 87         | 907  | 57   |
| Added Vol:                                   | 0           | 0    | 0    | 0           | 0    | 0    | 0          | 0    | 0    | 0          | 0    | 0    |
| PasserByVol:                                 | 0           | 0    | 0    | 0           | 0    | 0    | 0          | 0    | 0    | 0          | 0    | 0    |
| Initial Fut:                                 | 26          | 153  | 64   | 48          | 421  | 238  | 125        | 766  | 85   | 87         | 907  | 57   |
| User Adj:                                    | 1.00        | 1.00 | 1.00 | 1.00        | 1.00 | 1.00 | 1.00       | 1.00 | 1.00 | 1.00       | 1.00 | 1.00 |
| PHF Adj:                                     | 1.00        | 1.00 | 1.00 | 1.00        | 1.00 | 1.00 | 1.00       | 1.00 | 1.00 | 1.00       | 1.00 | 1.00 |
| PHF Volume:                                  | 26          | 153  | 64   | 48          | 421  | 238  | 125        | 766  | 85   | 87         | 907  | 57   |
| Reduct Vol:                                  | 0           | 0    | 0    | 0           | 0    | 0    | 0          | 0    | 0    | 0          | 0    | 0    |
| Reduced Vol:                                 | 26          | 153  | 64   | 48          | 421  | 238  | 125        | 766  | 85   | 87         | 907  | 57   |
| PCE Adj:                                     | 1.00        | 1.00 | 1.00 | 1.00        | 1.00 | 1.00 | 1.00       | 1.00 | 1.00 | 1.00       | 1.00 | 1.00 |
| MLF Adj:                                     | 1.00        | 1.00 | 1.00 | 1.00        | 1.00 | 1.00 | 1.00       | 1.00 | 1.00 | 1.00       | 1.00 | 1.00 |
| Final Volume:                                | 26          | 153  | 64   | 48          | 421  | 238  | 125        | 766  | 85   | 87         | 907  | 57   |
| Saturation Flow Module:                      |             |      |      |             |      |      |            |      |      |            |      |      |
| Sat/Lane:                                    | 1900        | 1900 | 1900 | 1900        | 1900 | 1900 | 1900       | 1900 | 1900 | 1900       | 1900 | 1900 |
| Adjustment:                                  | 0.92        | 0.95 | 0.95 | 0.92        | 1.00 | 0.92 | 0.92       | 1.00 | 0.92 | 0.92       | 1.00 | 0.92 |
| Lanes:                                       | 1.00        | 0.71 | 0.29 | 1.00        | 1.00 | 1.00 | 1.00       | 3.00 | 1.00 | 1.00       | 3.00 | 1.00 |
| Final Sat.:                                  | 1750        | 1269 | 531  | 1750        | 1900 | 1750 | 1750       | 5700 | 1750 | 1750       | 5700 | 1750 |
| Capacity Analysis Module:                    |             |      |      |             |      |      |            |      |      |            |      |      |
| Vol/Sat:                                     | 0.01        | 0.12 | 0.12 | 0.03        | 0.22 | 0.14 | 0.07       | 0.13 | 0.05 | 0.05       | 0.16 | 0.03 |
| Crit Moves:                                  | ****        |      |      | ****        |      |      | ****       |      |      | ****       |      |      |
| Green Time:                                  | 7.0         | 38.1 | 38.1 | 18.4        | 49.5 | 65.5 | 16.0       | 35.9 | 42.9 | 15.6       | 35.5 | 54.0 |
| Volume/Cap:                                  | 0.25        | 0.38 | 0.38 | 0.18        | 0.54 | 0.25 | 0.54       | 0.45 | 0.14 | 0.38       | 0.54 | 0.07 |
| Delay/Veh:                                   | 55.3        | 32.2 | 32.2 | 44.5        | 27.3 | 14.5 | 51.1       | 34.2 | 26.1 | 48.9       | 35.7 | 18.8 |
| User DelAdj:                                 | 1.00        | 1.00 | 1.00 | 1.00        | 1.00 | 1.00 | 1.00       | 1.00 | 1.00 | 1.00       | 1.00 | 1.00 |
| AdjDel/Veh:                                  | 55.3        | 32.2 | 32.2 | 44.5        | 27.3 | 14.5 | 51.1       | 34.2 | 26.1 | 48.9       | 35.7 | 18.8 |
| LOS by Move:                                 | E           | C    | C    | D           | C    | B    | D          | C    | C    | D          | D    | B    |
| HCM2k95thQ:                                  | 3           | 13   | 13   | 3           | 21   | 9    | 9          | 14   | 4    | 6          | 17   | 2    |

Note: Queue reported is the number of cars per lane.

BART

Level Of Service Computation Report  
 2000 HCM Operations (Future Volume Alternative)  
 AM - Existing Conditions

Intersection #1205: SCOTT/EL CAMINO REAL [Study Int 42]

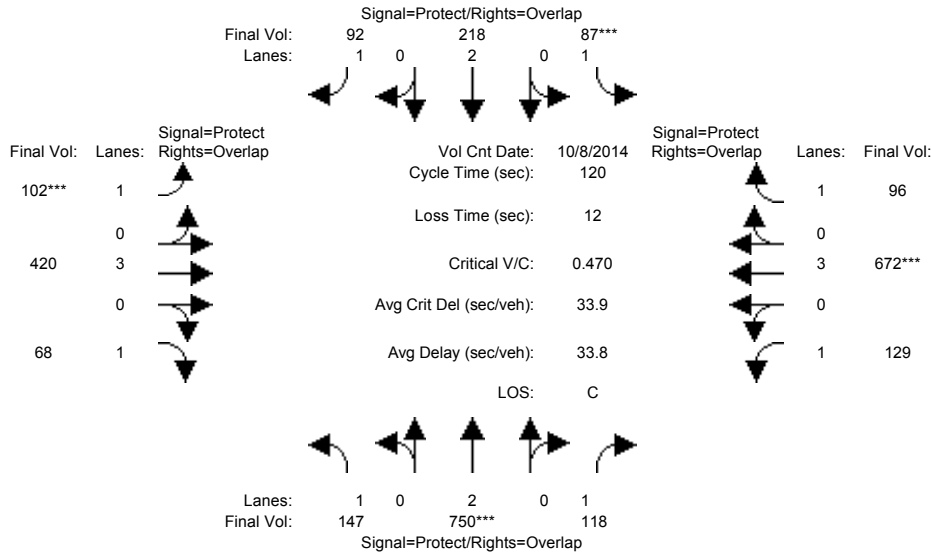

| Approach:                                   | North Bound |      |      | South Bound |      |      | East Bound |      |      | West Bound |      |      |
|---|-------------|------|------|-------------|------|------|------------|------|------|------------|------|------|
| Movement:                                   | L           | T    | R    | L           | T    | R    | L          | T    | R    | L          | T    | R    |
| Min. Green:                                 | 7           | 10   | 10   | 7           | 10   | 10   | 7          | 10   | 10   | 7          | 10   | 10   |
| Y+R:  | 4.0         | 4.0  | 4.0  | 4.0         | 4.0  | 4.0  | 4.0        | 4.0  | 4.0  | 4.0        | 4.0  | 4.0  |
| Volume Module: >> Count Date: 8 Oct 2014 << |             |      |      |             |      |      |            |      |      |            |      |      |
| Base Vol:                                   | 147         | 750  | 118  | 87          | 218  | 92   | 102        | 420  | 68   | 129        | 672  | 96   |
| Growth Adj:                                 | 1.00        | 1.00 | 1.00 | 1.00        | 1.00 | 1.00 | 1.00       | 1.00 | 1.00 | 1.00       | 1.00 | 1.00 |
| Initial Bse:                                | 147         | 750  | 118  | 87          | 218  | 92   | 102        | 420  | 68   | 129        | 672  | 96   |
| Added Vol:                                  | 0           | 0    | 0    | 0           | 0    | 0    | 0          | 0    | 0    | 0          | 0    | 0    |
| PasserByVol:                                | 0           | 0    | 0    | 0           | 0    | 0    | 0          | 0    | 0    | 0          | 0    | 0    |
| Initial Fut:                                | 147         | 750  | 118  | 87          | 218  | 92   | 102        | 420  | 68   | 129        | 672  | 96   |
| User Adj:                                   | 1.00        | 1.00 | 1.00 | 1.00        | 1.00 | 1.00 | 1.00       | 1.00 | 1.00 | 1.00       | 1.00 | 1.00 |
| PHF Adj:                                    | 1.00        | 1.00 | 1.00 | 1.00        | 1.00 | 1.00 | 1.00       | 1.00 | 1.00 | 1.00       | 1.00 | 1.00 |
| PHF Volume:                                 | 147         | 750  | 118  | 87          | 218  | 92   | 102        | 420  | 68   | 129        | 672  | 96   |
| Reduct Vol:                                 | 0           | 0    | 0    | 0           | 0    | 0    | 0          | 0    | 0    | 0          | 0    | 0    |
| Reduced Vol:                                | 147         | 750  | 118  | 87          | 218  | 92   | 102        | 420  | 68   | 129        | 672  | 96   |
| PCE Adj:                                    | 1.00        | 1.00 | 1.00 | 1.00        | 1.00 | 1.00 | 1.00       | 1.00 | 1.00 | 1.00       | 1.00 | 1.00 |
| MLF Adj:                                    | 1.00        | 1.00 | 1.00 | 1.00        | 1.00 | 1.00 | 1.00       | 1.00 | 1.00 | 1.00       | 1.00 | 1.00 |
| Final Volume:                               | 147         | 750  | 118  | 87          | 218  | 92   | 102        | 420  | 68   | 129        | 672  | 96   |
| Saturation Flow Module:                     |             |      |      |             |      |      |            |      |      |            |      |      |
| Sat/Lane:                                   | 1900        | 1900 | 1900 | 1900        | 1900 | 1900 | 1900       | 1900 | 1900 | 1900       | 1900 | 1900 |
| Adjustment:                                 | 0.92        | 1.00 | 0.92 | 0.92        | 1.00 | 0.92 | 0.92       | 1.00 | 0.92 | 0.92       | 1.00 | 0.92 |
| Lanes:                                      | 1.00        | 2.00 | 1.00 | 1.00        | 2.00 | 1.00 | 1.00       | 3.00 | 1.00 | 1.00       | 3.00 | 1.00 |
| Final Sat.:                                 | 1750        | 3800 | 1750 | 1750        | 3800 | 1750 | 1750       | 5700 | 1750 | 1750       | 5700 | 1750 |
| Capacity Analysis Module:                   |             |      |      |             |      |      |            |      |      |            |      |      |
| Vol/Sat:                                    | 0.08        | 0.20 | 0.07 | 0.05        | 0.06 | 0.05 | 0.06       | 0.07 | 0.04 | 0.07       | 0.12 | 0.05 |
| Crit Moves:                                 | ****        | **** | **** | ****        | **** | **** | ****       | **** | **** | ****       | **** | **** |
| Green Time:                                 | 31.6        | 50.4 | 71.5 | 12.7        | 31.4 | 46.3 | 14.9       | 23.9 | 55.5 | 21.1       | 30.1 | 42.8 |
| Volume/Cap:                                 | 0.32        | 0.47 | 0.11 | 0.47        | 0.22 | 0.14 | 0.47       | 0.37 | 0.08 | 0.42       | 0.47 | 0.15 |
| Delay/Veh:                                  | 35.9        | 25.4 | 10.6 | 52.4        | 34.8 | 24.0 | 50.5       | 41.8 | 18.1 | 44.9       | 38.4 | 26.4 |
| User DelAdj:                                | 1.00        | 1.00 | 1.00 | 1.00        | 1.00 | 1.00 | 1.00       | 1.00 | 1.00 | 1.00       | 1.00 | 1.00 |
| AdjDel/Veh:                                 | 35.9        | 25.4 | 10.6 | 52.4        | 34.8 | 24.0 | 50.5       | 41.8 | 18.1 | 44.9       | 38.4 | 26.4 |
| LOS by Move:                                | D           | C    | B    | D           | C    | C    | D          | D    | B    | D          | D    | C    |
| HCM2k95thQ:                                 | 9           | 18   | 4    | 6           | 6    | 5    | 7          | 8    | 3    | 9          | 13   | 5    |

Note: Queue reported is the number of cars per lane.

BART

Level Of Service Computation Report  
 2000 HCM Operations (Future Volume Alternative)  
 PM - Existing Conditions

Intersection #1205: SCOTT/EL CAMINO REAL [Study Int 42]

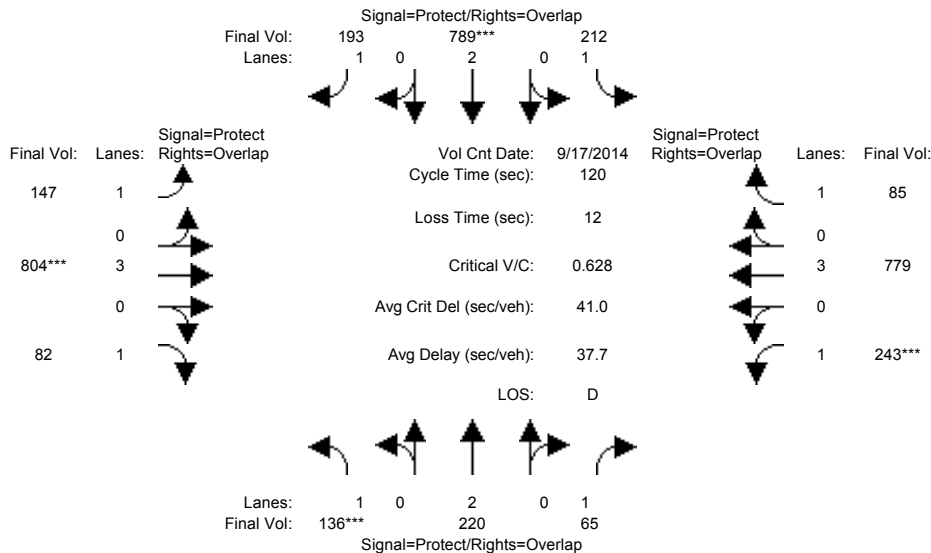

| Approach:                                    | North Bound |      |      | South Bound |      |      | East Bound |      |      | West Bound |      |      |
|--|-------------|------|------|-------------|------|------|------------|------|------|------------|------|------|
| Movement:                                    | L           | T    | R    | L           | T    | R    | L          | T    | R    | L          | T    | R    |
| Min. Green:                                  | 7           | 10   | 10   | 7           | 10   | 10   | 7          | 10   | 10   | 7          | 10   | 10   |
| Y+R:   | 4.0         | 4.0  | 4.0  | 4.0         | 4.0  | 4.0  | 4.0        | 4.0  | 4.0  | 4.0        | 4.0  | 4.0  |
| Volume Module: >> Count Date: 17 Sep 2014 << |             |      |      |             |      |      |            |      |      |            |      |      |
| Base Vol:                                    | 136         | 220  | 65   | 212         | 789  | 193  | 147        | 804  | 82   | 243        | 779  | 85   |
| Growth Adj:                                  | 1.00        | 1.00 | 1.00 | 1.00        | 1.00 | 1.00 | 1.00       | 1.00 | 1.00 | 1.00       | 1.00 | 1.00 |
| Initial Bse:                                 | 136         | 220  | 65   | 212         | 789  | 193  | 147        | 804  | 82   | 243        | 779  | 85   |
| Added Vol:                                   | 0           | 0    | 0    | 0           | 0    | 0    | 0          | 0    | 0    | 0          | 0    | 0    |
| PasserByVol:                                 | 0           | 0    | 0    | 0           | 0    | 0    | 0          | 0    | 0    | 0          | 0    | 0    |
| Initial Fut:                                 | 136         | 220  | 65   | 212         | 789  | 193  | 147        | 804  | 82   | 243        | 779  | 85   |
| User Adj:                                    | 1.00        | 1.00 | 1.00 | 1.00        | 1.00 | 1.00 | 1.00       | 1.00 | 1.00 | 1.00       | 1.00 | 1.00 |
| PHF Adj:                                     | 1.00        | 1.00 | 1.00 | 1.00        | 1.00 | 1.00 | 1.00       | 1.00 | 1.00 | 1.00       | 1.00 | 1.00 |
| PHF Volume:                                  | 136         | 220  | 65   | 212         | 789  | 193  | 147        | 804  | 82   | 243        | 779  | 85   |
| Reduct Vol:                                  | 0           | 0    | 0    | 0           | 0    | 0    | 0          | 0    | 0    | 0          | 0    | 0    |
| Reduced Vol:                                 | 136         | 220  | 65   | 212         | 789  | 193  | 147        | 804  | 82   | 243        | 779  | 85   |
| PCE Adj:                                     | 1.00        | 1.00 | 1.00 | 1.00        | 1.00 | 1.00 | 1.00       | 1.00 | 1.00 | 1.00       | 1.00 | 1.00 |
| MLF Adj:                                     | 1.00        | 1.00 | 1.00 | 1.00        | 1.00 | 1.00 | 1.00       | 1.00 | 1.00 | 1.00       | 1.00 | 1.00 |
| Final Volume:                                | 136         | 220  | 65   | 212         | 789  | 193  | 147        | 804  | 82   | 243        | 779  | 85   |
| Saturation Flow Module:                      |             |      |      |             |      |      |            |      |      |            |      |      |
| Sat/Lane:                                    | 1900        | 1900 | 1900 | 1900        | 1900 | 1900 | 1900       | 1900 | 1900 | 1900       | 1900 | 1900 |
| Adjustment:                                  | 0.92        | 1.00 | 0.92 | 0.92        | 1.00 | 0.92 | 0.92       | 1.00 | 0.92 | 0.92       | 1.00 | 0.92 |
| Lanes:                                       | 1.00        | 2.00 | 1.00 | 1.00        | 2.00 | 1.00 | 1.00       | 3.00 | 1.00 | 1.00       | 3.00 | 1.00 |
| Final Sat.:                                  | 1750        | 3800 | 1750 | 1750        | 3800 | 1750 | 1750       | 5700 | 1750 | 1750       | 5700 | 1750 |
| Capacity Analysis Module:                    |             |      |      |             |      |      |            |      |      |            |      |      |
| Vol/Sat:                                     | 0.08        | 0.06 | 0.04 | 0.12        | 0.21 | 0.11 | 0.08       | 0.14 | 0.05 | 0.14       | 0.14 | 0.05 |
| Crit Moves:                                  | ****        |      |      | ****        |      |      | ****       |      |      | ****       |      |      |
| Green Time:                                  | 14.8        | 22.2 | 48.7 | 32.3        | 39.7 | 60.0 | 20.4       | 27.0 | 41.8 | 26.5       | 33.1 | 65.4 |
| Volume/Cap:                                  | 0.63        | 0.31 | 0.09 | 0.45        | 0.63 | 0.22 | 0.50       | 0.63 | 0.13 | 0.63       | 0.50 | 0.09 |
| Delay/Veh:                                   | 55.7        | 42.5 | 22.0 | 37.2        | 35.0 | 17.0 | 46.5       | 43.0 | 26.8 | 45.5       | 36.7 | 13.1 |
| User DelAdj:                                 | 1.00        | 1.00 | 1.00 | 1.00        | 1.00 | 1.00 | 1.00       | 1.00 | 1.00 | 1.00       | 1.00 | 1.00 |
| AdjDel/Veh:                                  | 55.7        | 42.5 | 22.0 | 37.2        | 35.0 | 17.0 | 46.5       | 43.0 | 26.8 | 45.5       | 36.7 | 13.1 |
| LOS by Move:                                 | E           | D    | C    | D           | C    | B    | D          | D    | C    | D          | D    | B    |
| HCM2k95thQ:                                  | 10          | 7    | 3    | 13          | 22   | 8    | 10         | 17   | 4    | 16         | 15   | 3    |

Note: Queue reported is the number of cars per lane.

BART

Level Of Service Computation Report  
 2000 HCM Operations (Future Volume Alternative)  
 AM - Existing Conditions

Intersection #1213: THE ALAMEDA/EL CAMINO REAL [Study Int 54]

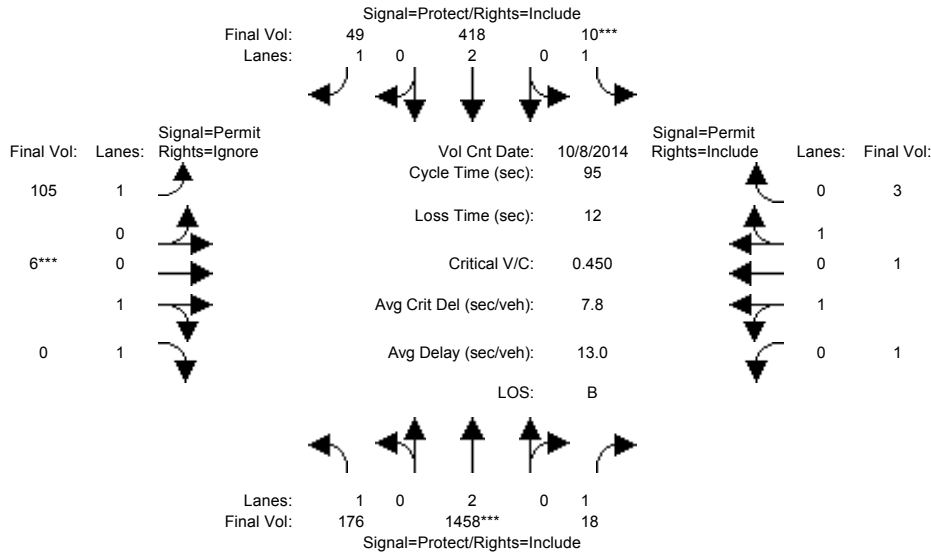

| Approach:                 | North Bound                  |      |      | South Bound |      |      | East Bound |      |      | West Bound |      |      |
|---------------------------|------------------------------|------|------|-------------|------|------|------------|------|------|------------|------|------|
| Movement:                 | L                            | T    | R    | L           | T    | R    | L          | T    | R    | L          | T    | R    |
| Min. Green:               | 7                            | 10   | 10   | 7           | 10   | 10   | 7          | 10   | 10   | 7          | 10   | 10   |
| Y+R:                      | 4.0                          | 4.0  | 4.0  | 4.0         | 4.0  | 4.0  | 4.0        | 4.0  | 4.0  | 4.0        | 4.0  | 4.0  |
| -----                     |                              |      |      |             |      |      |            |      |      |            |      |      |
| Volume Module:            | >> Count Date: 8 Oct 2014 << |      |      |             |      |      |            |      |      |            |      |      |
| Base Vol:                 | 176                          | 1458 | 18   | 10          | 418  | 49   | 105        | 6    | 108  | 1          | 1    | 3    |
| Growth Adj:               | 1.00                         | 1.00 | 1.00 | 1.00        | 1.00 | 1.00 | 1.00       | 1.00 | 1.00 | 1.00       | 1.00 | 1.00 |
| Initial Bse:              | 176                          | 1458 | 18   | 10          | 418  | 49   | 105        | 6    | 108  | 1          | 1    | 3    |
| Added Vol:                | 0                            | 0    | 0    | 0           | 0    | 0    | 0          | 0    | 0    | 0          | 0    | 0    |
| PasserByVol:              | 0                            | 0    | 0    | 0           | 0    | 0    | 0          | 0    | 0    | 0          | 0    | 0    |
| Initial Fut:              | 176                          | 1458 | 18   | 10          | 418  | 49   | 105        | 6    | 108  | 1          | 1    | 3    |
| User Adj:                 | 1.00                         | 1.00 | 1.00 | 1.00        | 1.00 | 1.00 | 1.00       | 1.00 | 0.00 | 1.00       | 1.00 | 1.00 |
| PHF Adj:                  | 1.00                         | 1.00 | 1.00 | 1.00        | 1.00 | 1.00 | 1.00       | 1.00 | 0.00 | 1.00       | 1.00 | 1.00 |
| PHF Volume:               | 176                          | 1458 | 18   | 10          | 418  | 49   | 105        | 6    | 0    | 1          | 1    | 3    |
| Reduct Vol:               | 0                            | 0    | 0    | 0           | 0    | 0    | 0          | 0    | 0    | 0          | 0    | 0    |
| Reduced Vol:              | 176                          | 1458 | 18   | 10          | 418  | 49   | 105        | 6    | 0    | 1          | 1    | 3    |
| PCE Adj:                  | 1.00                         | 1.00 | 1.00 | 1.00        | 1.00 | 1.00 | 1.00       | 1.00 | 0.00 | 1.00       | 1.00 | 1.00 |
| MLF Adj:                  | 1.00                         | 1.00 | 1.00 | 1.00        | 1.00 | 1.00 | 1.00       | 1.00 | 0.00 | 1.00       | 1.00 | 1.00 |
| FinalVolume:              | 176                          | 1458 | 18   | 10          | 418  | 49   | 105        | 6    | 0    | 1          | 1    | 3    |
| -----                     |                              |      |      |             |      |      |            |      |      |            |      |      |
| Saturation Flow Module:   |                              |      |      |             |      |      |            |      |      |            |      |      |
| Sat/Lane:                 | 1900                         | 1900 | 1900 | 1900        | 1900 | 1900 | 1900       | 1900 | 1900 | 1900       | 1900 | 1900 |
| Adjustment:               | 0.92                         | 1.00 | 0.92 | 0.92        | 1.00 | 0.92 | 0.92       | 0.95 | 0.92 | 0.95       | 0.95 | 0.95 |
| Lanes:                    | 1.00                         | 2.00 | 1.00 | 1.00        | 2.00 | 1.00 | 1.00       | 1.00 | 1.00 | 0.50       | 0.50 | 1.00 |
| Final Sat.:               | 1750                         | 3800 | 1750 | 1750        | 3800 | 1750 | 1750       | 1800 | 1750 | 900        | 900  | 1800 |
| -----                     |                              |      |      |             |      |      |            |      |      |            |      |      |
| Capacity Analysis Module: |                              |      |      |             |      |      |            |      |      |            |      |      |
| Vol/Sat:                  | 0.10                         | 0.38 | 0.01 | 0.01        | 0.11 | 0.03 | 0.06       | 0.00 | 0.00 | 0.00       | 0.00 | 0.00 |
| Crit Moves:               | ****                         | **** | **** | ****        | **** | **** | ****       | **** | **** | ****       | **** | **** |
| Green Time:               | 34.9                         | 66.0 | 66.0 | 7.0         | 38.1 | 38.1 | 10.0       | 10.0 | 0.0  | 10.0       | 10.0 | 10.0 |
| Volume/Cap:               | 0.27                         | 0.55 | 0.01 | 0.08        | 0.27 | 0.07 | 0.57       | 0.03 | 0.00 | 0.01       | 0.01 | 0.02 |
| Delay/Veh:                | 21.4                         | 7.4  | 4.5  | 41.3        | 19.2 | 17.6 | 44.7       | 38.2 | 0.0  | 38.1       | 38.1 | 38.1 |
| User DelAdj:              | 1.00                         | 1.00 | 1.00 | 1.00        | 1.00 | 1.00 | 1.00       | 1.00 | 1.00 | 1.00       | 1.00 | 1.00 |
| AdjDel/Veh:               | 21.4                         | 7.4  | 4.5  | 41.3        | 19.2 | 17.6 | 44.7       | 38.2 | 0.0  | 38.1       | 38.1 | 38.1 |
| LOS by Move:              | C                            | A    | A    | D           | B    | B    | D          | D    | A    | D          | D    | D    |
| HCM2k95thQ:               | 7                            | 19   | 0    | 1           | 8    | 2    | 8          | 0    | 0    | 0          | 0    | 0    |

Note: Queue reported is the number of cars per lane.

BART

Level Of Service Computation Report  
 2000 HCM Operations (Future Volume Alternative)  
 PM - Existing Conditions

Intersection #1213: THE ALAMEDA/EL CAMINO REAL [Study Int 54]

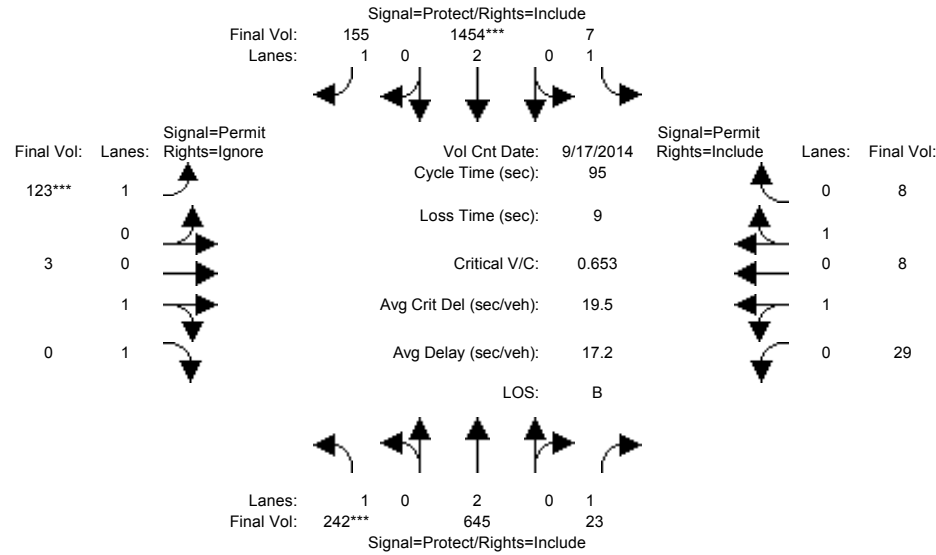

| Approach:                                    | North Bound |      |      | South Bound |      |      | East Bound |      |      | West Bound |      |      |
|--|-------------|------|------|-------------|------|------|------------|------|------|------------|------|------|
| Movement:                                    | L           | T    | R    | L           | T    | R    | L          | T    | R    | L          | T    | R    |
| Min. Green:                                  | 7           | 10   | 10   | 7           | 10   | 10   | 10         | 10   | 10   | 10         | 10   | 10   |
| Y+R:   | 4.0         | 4.0  | 4.0  | 4.0         | 4.0  | 4.0  | 4.0        | 4.0  | 4.0  | 4.0        | 4.0  | 4.0  |
| Volume Module: >> Count Date: 17 Sep 2014 << |             |      |      |             |      |      |            |      |      |            |      |      |
| Base Vol:                                    | 242         | 645  | 23   | 7           | 1454 | 155  | 123        | 3    | 281  | 29         | 8    | 8    |
| Growth Adj:                                  | 1.00        | 1.00 | 1.00 | 1.00        | 1.00 | 1.00 | 1.00       | 1.00 | 1.00 | 1.00       | 1.00 | 1.00 |
| Initial Bse:                                 | 242         | 645  | 23   | 7           | 1454 | 155  | 123        | 3    | 281  | 29         | 8    | 8    |
| Added Vol:                                   | 0           | 0    | 0    | 0           | 0    | 0    | 0          | 0    | 0    | 0          | 0    | 0    |
| PasserByVol:                                 | 0           | 0    | 0    | 0           | 0    | 0    | 0          | 0    | 0    | 0          | 0    | 0    |
| Initial Fut:                                 | 242         | 645  | 23   | 7           | 1454 | 155  | 123        | 3    | 281  | 29         | 8    | 8    |
| User Adj:                                    | 1.00        | 1.00 | 1.00 | 1.00        | 1.00 | 1.00 | 1.00       | 1.00 | 0.00 | 1.00       | 1.00 | 1.00 |
| PHF Adj:                                     | 1.00        | 1.00 | 1.00 | 1.00        | 1.00 | 1.00 | 1.00       | 1.00 | 0.00 | 1.00       | 1.00 | 1.00 |
| PHF Volume:                                  | 242         | 645  | 23   | 7           | 1454 | 155  | 123        | 3    | 0    | 29         | 8    | 8    |
| Reduct Vol:                                  | 0           | 0    | 0    | 0           | 0    | 0    | 0          | 0    | 0    | 0          | 0    | 0    |
| Reduced Vol:                                 | 242         | 645  | 23   | 7           | 1454 | 155  | 123        | 3    | 0    | 29         | 8    | 8    |
| PCE Adj:                                     | 1.00        | 1.00 | 1.00 | 1.00        | 1.00 | 1.00 | 1.00       | 1.00 | 0.00 | 1.00       | 1.00 | 1.00 |
| MLF Adj:                                     | 1.00        | 1.00 | 1.00 | 1.00        | 1.00 | 1.00 | 1.00       | 1.00 | 0.00 | 1.00       | 1.00 | 1.00 |
| FinalVolume:                                 | 242         | 645  | 23   | 7           | 1454 | 155  | 123        | 3    | 0    | 29         | 8    | 8    |
| Saturation Flow Module:                      |             |      |      |             |      |      |            |      |      |            |      |      |
| Sat/Lane:                                    | 1900        | 1900 | 1900 | 1900        | 1900 | 1900 | 1900       | 1900 | 1900 | 1900       | 1900 | 1900 |
| Adjustment:                                  | 0.92        | 1.00 | 0.92 | 0.92        | 1.00 | 0.92 | 0.92       | 0.95 | 0.92 | 0.95       | 0.95 | 0.95 |
| Lanes:                                       | 1.00        | 2.00 | 1.00 | 1.00        | 2.00 | 1.00 | 1.00       | 1.00 | 1.00 | 1.00       | 0.50 | 0.50 |
| Final Sat.:                                  | 1750        | 3800 | 1750 | 1750        | 3800 | 1750 | 1750       | 1800 | 1750 | 1800       | 900  | 900  |
| Capacity Analysis Module:                    |             |      |      |             |      |      |            |      |      |            |      |      |
| Vol/Sat:                                     | 0.14        | 0.17 | 0.01 | 0.00        | 0.38 | 0.09 | 0.07       | 0.00 | 0.00 | 0.02       | 0.01 | 0.01 |
| Crit Moves:                                  | ****        |      |      | ****        |      |      | ****       |      |      |            |      |      |
| Green Time:                                  | 20.1        | 52.8 | 52.8 | 22.9        | 55.7 | 55.7 | 10.2       | 10.2 | 0.0  | 10.2       | 10.2 | 10.2 |
| Volume/Cap:                                  | 0.65        | 0.31 | 0.02 | 0.02        | 0.65 | 0.15 | 0.65       | 0.02 | 0.00 | 0.15       | 0.08 | 0.08 |
| Delay/Veh:                                   | 38.4        | 11.4 | 9.5  | 27.5        | 13.9 | 9.0  | 48.6       | 37.9 | 0.0  | 38.7       | 38.2 | 38.2 |
| User DelAdj:                                 | 1.00        | 1.00 | 1.00 | 1.00        | 1.00 | 1.00 | 1.00       | 1.00 | 1.00 | 1.00       | 1.00 | 1.00 |
| AdjDel/Veh:                                  | 38.4        | 11.4 | 9.5  | 27.5        | 13.9 | 9.0  | 48.6       | 37.9 | 0.0  | 38.7       | 38.2 | 38.2 |
| LOS by Move:                                 | D           | B    | A    | C           | B    | A    | D          | D    | A    | D          | D    | D    |
| HCM2k95thQ:                                  | 13          | 9    | 1    | 0           | 26   | 4    | 10         | 0    | 0    | 2          | 1    | 1    |

Note: Queue reported is the number of cars per lane.

BART

Level Of Service Computation Report  
 2000 HCM Operations (Future Volume Alternative)  
 AM - Existing Conditions

Intersection #1214: THE ALAMEDA/NEWHALL [Study Int 55]

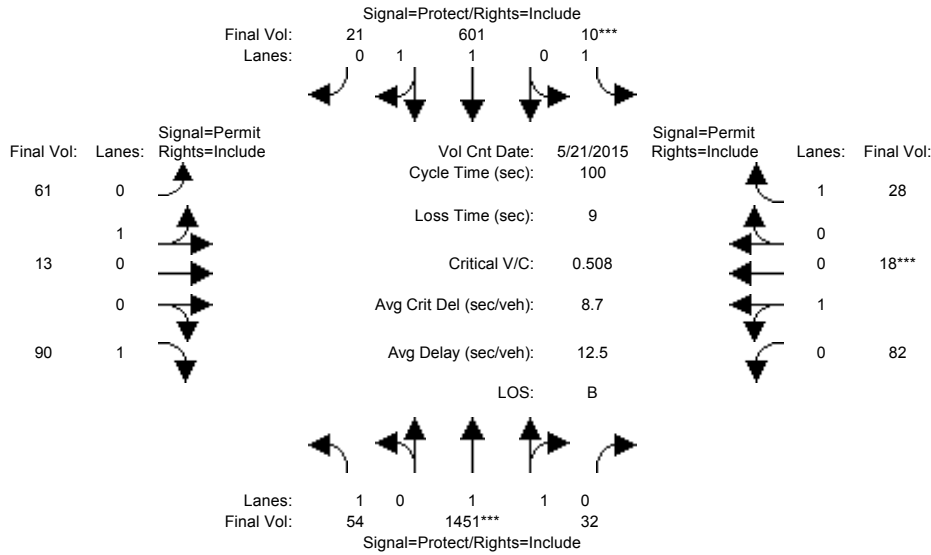

| Approach:                 | North Bound                   |      |      | South Bound |      |      | East Bound |      |      | West Bound |      |      |
|---------------------------|-------------------------------|------|------|-------------|------|------|------------|------|------|------------|------|------|
| Movement:                 | L                             | T    | R    | L           | T    | R    | L          | T    | R    | L          | T    | R    |
| Min. Green:               | 7                             | 10   | 10   | 7           | 10   | 10   | 7          | 10   | 10   | 7          | 10   | 10   |
| Y+R:                      | 4.0                           | 4.0  | 4.0  | 4.0         | 4.0  | 4.0  | 4.0        | 4.0  | 4.0  | 4.0        | 4.0  | 4.0  |
| -----                     |                               |      |      |             |      |      |            |      |      |            |      |      |
| Volume Module:            | >> Count Date: 21 May 2015 << |      |      |             |      |      |            |      |      |            |      |      |
| Base Vol:                 | 54                            | 1451 | 32   | 10          | 601  | 21   | 61         | 13   | 90   | 82         | 18   | 28   |
| Growth Adj:               | 1.00                          | 1.00 | 1.00 | 1.00        | 1.00 | 1.00 | 1.00       | 1.00 | 1.00 | 1.00       | 1.00 | 1.00 |
| Initial Bse:              | 54                            | 1451 | 32   | 10          | 601  | 21   | 61         | 13   | 90   | 82         | 18   | 28   |
| Added Vol:                | 0                             | 0    | 0    | 0           | 0    | 0    | 0          | 0    | 0    | 0          | 0    | 0    |
| PasserByVol:              | 0                             | 0    | 0    | 0           | 0    | 0    | 0          | 0    | 0    | 0          | 0    | 0    |
| Initial Fut:              | 54                            | 1451 | 32   | 10          | 601  | 21   | 61         | 13   | 90   | 82         | 18   | 28   |
| User Adj:                 | 1.00                          | 1.00 | 1.00 | 1.00        | 1.00 | 1.00 | 1.00       | 1.00 | 1.00 | 1.00       | 1.00 | 1.00 |
| PHF Adj:                  | 1.00                          | 1.00 | 1.00 | 1.00        | 1.00 | 1.00 | 1.00       | 1.00 | 1.00 | 1.00       | 1.00 | 1.00 |
| PHF Volume:               | 54                            | 1451 | 32   | 10          | 601  | 21   | 61         | 13   | 90   | 82         | 18   | 28   |
| Reduct Vol:               | 0                             | 0    | 0    | 0           | 0    | 0    | 0          | 0    | 0    | 0          | 0    | 0    |
| Reduced Vol:              | 54                            | 1451 | 32   | 10          | 601  | 21   | 61         | 13   | 90   | 82         | 18   | 28   |
| PCE Adj:                  | 1.00                          | 1.00 | 1.00 | 1.00        | 1.00 | 1.00 | 1.00       | 1.00 | 1.00 | 1.00       | 1.00 | 1.00 |
| MLF Adj:                  | 1.00                          | 1.00 | 1.00 | 1.00        | 1.00 | 1.00 | 1.00       | 1.00 | 1.00 | 1.00       | 1.00 | 1.00 |
| Final Volume:             | 54                            | 1451 | 32   | 10          | 601  | 21   | 61         | 13   | 90   | 82         | 18   | 28   |
| -----                     |                               |      |      |             |      |      |            |      |      |            |      |      |
| Saturation Flow Module:   |                               |      |      |             |      |      |            |      |      |            |      |      |
| Sat/Lane:                 | 1900                          | 1900 | 1900 | 1900        | 1900 | 1900 | 1900       | 1900 | 1900 | 1900       | 1900 | 1900 |
| Adjustment:               | 0.92                          | 0.97 | 0.95 | 0.92        | 0.97 | 0.95 | 0.95       | 0.95 | 0.92 | 0.95       | 0.95 | 0.92 |
| Lanes:                    | 1.00                          | 1.96 | 0.04 | 1.00        | 1.93 | 0.07 | 0.82       | 0.18 | 1.00 | 0.82       | 0.18 | 1.00 |
| Final Sat.:               | 1750                          | 3620 | 80   | 1750        | 3575 | 125  | 1484       | 316  | 1750 | 1476       | 324  | 1750 |
| -----                     |                               |      |      |             |      |      |            |      |      |            |      |      |
| Capacity Analysis Module: |                               |      |      |             |      |      |            |      |      |            |      |      |
| Vol/Sat:                  | 0.03                          | 0.40 | 0.40 | 0.01        | 0.17 | 0.17 | 0.04       | 0.04 | 0.05 | 0.06       | 0.06 | 0.02 |
| Crit Moves:               | ****                          |      |      | ****        |      |      | ****       |      |      | ****       |      |      |
| Green Time:               | 23.7                          | 73.8 | 73.8 | 7.0         | 57.0 | 57.0 | 10.2       | 10.2 | 10.2 | 10.2       | 10.2 | 10.2 |
| Volume/Cap:               | 0.13                          | 0.54 | 0.54 | 0.08        | 0.29 | 0.29 | 0.40       | 0.40 | 0.50 | 0.54       | 0.54 | 0.16 |
| Delay/Veh:                | 30.1                          | 6.0  | 6.0  | 43.8        | 11.2 | 11.2 | 43.5       | 43.5 | 44.7 | 46.0       | 46.0 | 41.4 |
| User DelAdj:              | 1.00                          | 1.00 | 1.00 | 1.00        | 1.00 | 1.00 | 1.00       | 1.00 | 1.00 | 1.00       | 1.00 | 1.00 |
| AdjDel/Veh:               | 30.1                          | 6.0  | 6.0  | 43.8        | 11.2 | 11.2 | 43.5       | 43.5 | 44.7 | 46.0       | 46.0 | 41.4 |
| LOS by Move:              | C                             | A    | A    | D           | B    | B    | D          | D    | D    | D          | D    | D    |
| HCM2k95thQ:               | 3                             | 19   | 19   | 1           | 10   | 10   | 4          | 4    | 6    | 8          | 8    | 2    |

Note: Queue reported is the number of cars per lane.



BART

Level Of Service Computation Report  
 2000 HCM Operations (Future Volume Alternative)  
 PM - Existing Conditions

Intersection #1214: THE ALAMEDA/NEWHALL [Study Int 55]

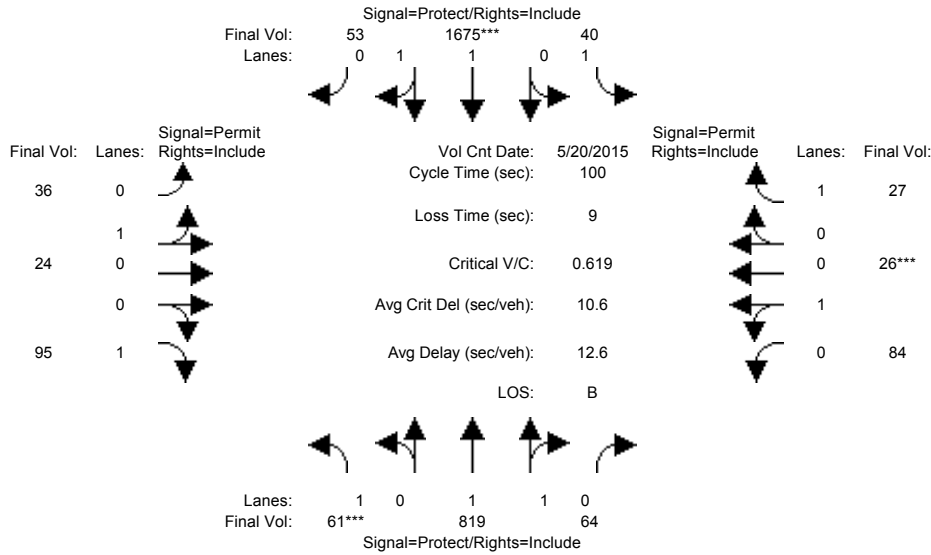

| Approach:                                    | North Bound |      |      | South Bound |      |      | East Bound |      |      | West Bound |      |      |
|--|-------------|------|------|-------------|------|------|------------|------|------|------------|------|------|
| Movement:                                    | L           | T    | R    | L           | T    | R    | L          | T    | R    | L          | T    | R    |
| Min. Green:                                  | 7           | 10   | 10   | 7           | 10   | 10   | 7          | 10   | 10   | 7          | 10   | 10   |
| Y+R:   | 4.0         | 4.0  | 4.0  | 4.0         | 4.0  | 4.0  | 4.0        | 4.0  | 4.0  | 4.0        | 4.0  | 4.0  |
| -----  |             |      |      |             |      |      |            |      |      |            |      |      |
| Volume Module: >> Count Date: 20 May 2015 << |             |      |      |             |      |      |            |      |      |            |      |      |
| Base Vol:                                    | 61          | 819  | 64   | 40          | 1675 | 53   | 36         | 24   | 95   | 84         | 26   | 27   |
| Growth Adj:                                  | 1.00        | 1.00 | 1.00 | 1.00        | 1.00 | 1.00 | 1.00       | 1.00 | 1.00 | 1.00       | 1.00 | 1.00 |
| Initial Bse:                                 | 61          | 819  | 64   | 40          | 1675 | 53   | 36         | 24   | 95   | 84         | 26   | 27   |
| Added Vol:                                   | 0           | 0    | 0    | 0           | 0    | 0    | 0          | 0    | 0    | 0          | 0    | 0    |
| PasserByVol:                                 | 0           | 0    | 0    | 0           | 0    | 0    | 0          | 0    | 0    | 0          | 0    | 0    |
| Initial Fut:                                 | 61          | 819  | 64   | 40          | 1675 | 53   | 36         | 24   | 95   | 84         | 26   | 27   |
| User Adj:                                    | 1.00        | 1.00 | 1.00 | 1.00        | 1.00 | 1.00 | 1.00       | 1.00 | 1.00 | 1.00       | 1.00 | 1.00 |
| PHF Adj:                                     | 1.00        | 1.00 | 1.00 | 1.00        | 1.00 | 1.00 | 1.00       | 1.00 | 1.00 | 1.00       | 1.00 | 1.00 |
| PHF Volume:                                  | 61          | 819  | 64   | 40          | 1675 | 53   | 36         | 24   | 95   | 84         | 26   | 27   |
| Reduct Vol:                                  | 0           | 0    | 0    | 0           | 0    | 0    | 0          | 0    | 0    | 0          | 0    | 0    |
| Reduced Vol:                                 | 61          | 819  | 64   | 40          | 1675 | 53   | 36         | 24   | 95   | 84         | 26   | 27   |
| PCE Adj:                                     | 1.00        | 1.00 | 1.00 | 1.00        | 1.00 | 1.00 | 1.00       | 1.00 | 1.00 | 1.00       | 1.00 | 1.00 |
| MLF Adj:                                     | 1.00        | 1.00 | 1.00 | 1.00        | 1.00 | 1.00 | 1.00       | 1.00 | 1.00 | 1.00       | 1.00 | 1.00 |
| FinalVolume:                                 | 61          | 819  | 64   | 40          | 1675 | 53   | 36         | 24   | 95   | 84         | 26   | 27   |
| -----  |             |      |      |             |      |      |            |      |      |            |      |      |
| Saturation Flow Module:                      |             |      |      |             |      |      |            |      |      |            |      |      |
| Sat/Lane:                                    | 1900        | 1900 | 1900 | 1900        | 1900 | 1900 | 1900       | 1900 | 1900 | 1900       | 1900 | 1900 |
| Adjustment:                                  | 0.92        | 0.98 | 0.95 | 0.92        | 0.97 | 0.95 | 0.95       | 0.95 | 0.92 | 0.95       | 0.95 | 0.92 |
| Lanes:                                       | 1.00        | 1.85 | 0.15 | 1.00        | 1.94 | 0.06 | 0.60       | 0.40 | 1.00 | 0.76       | 0.24 | 1.00 |
| Final Sat.:                                  | 1750        | 3432 | 268  | 1750        | 3586 | 113  | 1080       | 720  | 1750 | 1375       | 425  | 1750 |
| -----  |             |      |      |             |      |      |            |      |      |            |      |      |
| Capacity Analysis Module:                    |             |      |      |             |      |      |            |      |      |            |      |      |
| Vol/Sat:                                     | 0.03        | 0.24 | 0.24 | 0.02        | 0.47 | 0.47 | 0.03       | 0.03 | 0.05 | 0.06       | 0.06 | 0.02 |
| Crit Moves:                                  | ****        |      |      | ****        |      |      |            |      |      | ****       |      |      |
| Green Time:                                  | 7.0         | 62.6 | 62.6 | 18.4        | 74.0 | 74.0 | 10.0       | 10.0 | 10.0 | 10.0       | 10.0 | 10.0 |
| Volume/Cap:                                  | 0.50        | 0.38 | 0.38 | 0.12        | 0.63 | 0.63 | 0.33       | 0.33 | 0.54 | 0.61       | 0.61 | 0.15 |
| Delay/Veh:                                   | 48.0        | 9.3  | 9.3  | 34.3        | 6.8  | 6.8  | 43.0       | 43.0 | 46.3 | 49.2       | 49.2 | 41.5 |
| User DelAdj:                                 | 1.00        | 1.00 | 1.00 | 1.00        | 1.00 | 1.00 | 1.00       | 1.00 | 1.00 | 1.00       | 1.00 | 1.00 |
| AdjDel/Veh:                                  | 48.0        | 9.3  | 9.3  | 34.3        | 6.8  | 6.8  | 43.0       | 43.0 | 46.3 | 49.2       | 49.2 | 41.5 |
| LOS by Move:                                 | D           | A    | A    | C           | A    | A    | D          | D    | D    | D          | D    | D    |
| HCM2k95thQ:                                  | 4           | 13   | 13   | 2           | 23   | 23   | 4          | 4    | 6    | 9          | 9    | 2    |

Note: Queue reported is the number of cars per lane.

BART

Level Of Service Computation Report  
2000 HCM Operations (Future Volume Alternative)  
AM - Existing Conditions

Intersection #3016: 101/ALUM ROCK [Study Int 15]

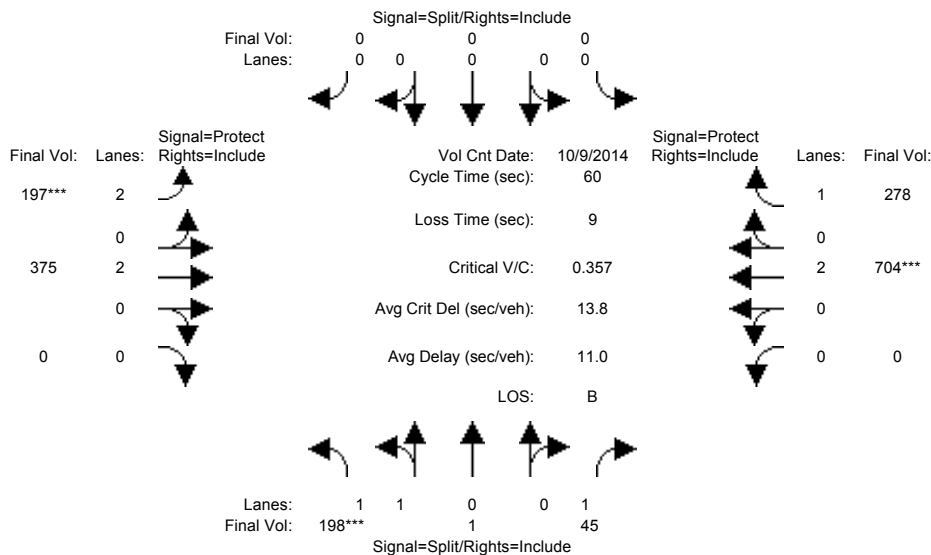

| Approach:                                   | North Bound |      |      | South Bound |      |      | East Bound |      |      | West Bound |      |      |
|---|-------------|------|------|-------------|------|------|------------|------|------|------------|------|------|
| Movement:                                   | L           | T    | R    | L           | T    | R    | L          | T    | R    | L          | T    | R    |
| Min. Green:                                 | 10          | 10   | 10   | 0           | 0    | 0    | 7          | 10   | 0    | 0          | 10   | 10   |
| Y+R:  | 4.0         | 4.0  | 4.0  | 4.0         | 4.0  | 4.0  | 4.0        | 4.0  | 4.0  | 4.0        | 4.0  | 4.0  |
| Volume Module: >> Count Date: 9 Oct 2014 << |             |      |      |             |      |      |            |      |      |            |      |      |
| Base Vol:                                   | 198         | 1    | 45   | 0           | 0    | 0    | 197        | 375  | 0    | 0          | 704  | 278  |
| Growth Adj:                                 | 1.00        | 1.00 | 1.00 | 1.00        | 1.00 | 1.00 | 1.00       | 1.00 | 1.00 | 1.00       | 1.00 | 1.00 |
| Initial Bse:                                | 198         | 1    | 45   | 0           | 0    | 0    | 197        | 375  | 0    | 0          | 704  | 278  |
| Added Vol:                                  | 0           | 0    | 0    | 0           | 0    | 0    | 0          | 0    | 0    | 0          | 0    | 0    |
| PasserByVol:                                | 0           | 0    | 0    | 0           | 0    | 0    | 0          | 0    | 0    | 0          | 0    | 0    |
| Initial Fut:                                | 198         | 1    | 45   | 0           | 0    | 0    | 197        | 375  | 0    | 0          | 704  | 278  |
| User Adj:                                   | 1.00        | 1.00 | 1.00 | 1.00        | 1.00 | 1.00 | 1.00       | 1.00 | 1.00 | 1.00       | 1.00 | 1.00 |
| PHF Adj:                                    | 1.00        | 1.00 | 1.00 | 1.00        | 1.00 | 1.00 | 1.00       | 1.00 | 1.00 | 1.00       | 1.00 | 1.00 |
| PHF Volume:                                 | 198         | 1    | 45   | 0           | 0    | 0    | 197        | 375  | 0    | 0          | 704  | 278  |
| Reduct Vol:                                 | 0           | 0    | 0    | 0           | 0    | 0    | 0          | 0    | 0    | 0          | 0    | 0    |
| Reduced Vol:                                | 198         | 1    | 45   | 0           | 0    | 0    | 197        | 375  | 0    | 0          | 704  | 278  |
| PCE Adj:                                    | 1.00        | 1.00 | 1.00 | 1.00        | 1.00 | 1.00 | 1.00       | 1.00 | 1.00 | 1.00       | 1.00 | 1.00 |
| MLF Adj:                                    | 1.00        | 1.00 | 1.00 | 1.00        | 1.00 | 1.00 | 1.00       | 1.00 | 1.00 | 1.00       | 1.00 | 1.00 |
| Final Volume:                               | 198         | 1    | 45   | 0           | 0    | 0    | 197        | 375  | 0    | 0          | 704  | 278  |
| Saturation Flow Module:                     |             |      |      |             |      |      |            |      |      |            |      |      |
| Sat/Lane:                                   | 1900        | 1900 | 1900 | 1900        | 1900 | 1900 | 1900       | 1900 | 1900 | 1900       | 1900 | 1900 |
| Adjustment:                                 | 0.93        | 0.95 | 0.92 | 0.92        | 1.00 | 0.92 | 0.83       | 1.00 | 0.92 | 0.92       | 1.00 | 0.92 |
| Lanes:                                      | 1.99        | 0.01 | 1.00 | 0.00        | 0.00 | 0.00 | 2.00       | 2.00 | 0.00 | 0.00       | 2.00 | 1.00 |
| Final Sat.:                                 | 3532        | 18   | 1750 | 0           | 0    | 0    | 3150       | 3800 | 0    | 0          | 3800 | 1750 |
| Capacity Analysis Module:                   |             |      |      |             |      |      |            |      |      |            |      |      |
| Vol/Sat:                                    | 0.06        | 0.06 | 0.03 | 0.00        | 0.00 | 0.00 | 0.06       | 0.10 | 0.00 | 0.00       | 0.19 | 0.16 |
| Crit Moves:                                 | ****        |      |      |             |      |      | ****       |      |      | ****       |      |      |
| Green Time:                                 | 10.0        | 10.0 | 10.0 | 0.0         | 0.0  | 0.0  | 10.3       | 41.0 | 0.0  | 0.0        | 30.7 | 30.7 |
| Volume/Cap:                                 | 0.34        | 0.34 | 0.15 | 0.00        | 0.00 | 0.00 | 0.36       | 0.14 | 0.00 | 0.00       | 0.36 | 0.31 |
| Delay/Veh:                                  | 22.4        | 22.4 | 21.6 | 0.0         | 0.0  | 0.0  | 22.3       | 3.4  | 0.0  | 0.0        | 8.9  | 8.7  |
| User DelAdj:                                | 1.00        | 1.00 | 1.00 | 1.00        | 1.00 | 1.00 | 1.00       | 1.00 | 1.00 | 1.00       | 1.00 | 1.00 |
| AdjDel/Veh:                                 | 22.4        | 22.4 | 21.6 | 0.0         | 0.0  | 0.0  | 22.3       | 3.4  | 0.0  | 0.0        | 8.9  | 8.7  |
| LOS by Move:                                | C           | C    | C    | A           | A    | A    | C          | A    | A    | A          | A    | A    |
| HCM2k95thQ:                                 | 4           | 4    | 2    | 0           | 0    | 0    | 4          | 2    | 0    | 0          | 8    | 6    |

Note: Queue reported is the number of cars per lane.

BART

Level Of Service Computation Report  
 2000 HCM Operations (Future Volume Alternative)  
 PM - Existing Conditions

Intersection #3016: 101/ALUM ROCK [Study Int 15]

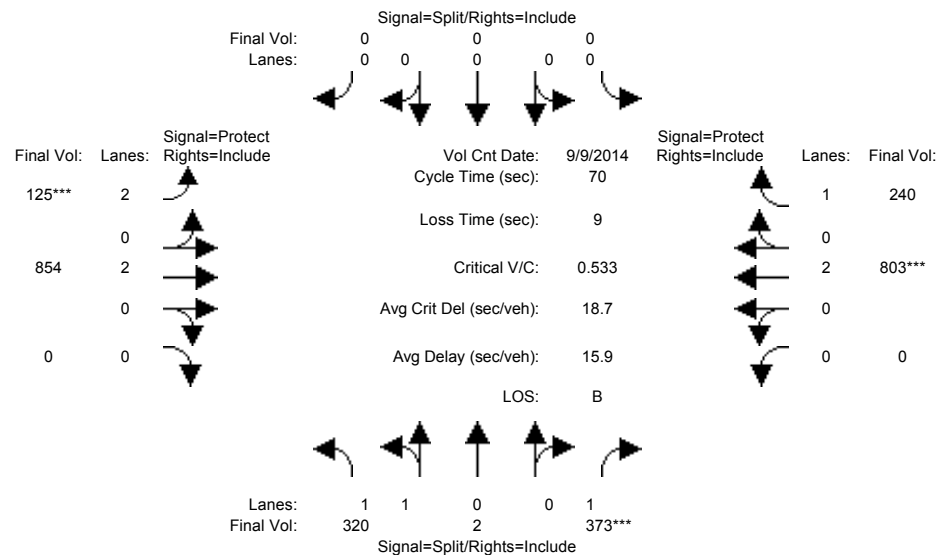

| Approach:                                   | North Bound |      |      | South Bound |      |      | East Bound |      |      | West Bound |      |      |
|---|-------------|------|------|-------------|------|------|------------|------|------|------------|------|------|
| Movement:                                   | L           | T    | R    | L           | T    | R    | L          | T    | R    | L          | T    | R    |
| Min. Green:                                 | 10          | 10   | 10   | 0           | 0    | 0    | 7          | 10   | 0    | 0          | 10   | 10   |
| Y+R:  | 4.0         | 4.0  | 4.0  | 4.0         | 4.0  | 4.0  | 4.0        | 4.0  | 4.0  | 4.0        | 4.0  | 4.0  |
| Volume Module: >> Count Date: 9 Sep 2014 << |             |      |      |             |      |      |            |      |      |            |      |      |
| Base Vol:                                   | 320         | 2    | 373  | 0           | 0    | 0    | 125        | 854  | 0    | 0          | 803  | 240  |
| Growth Adj:                                 | 1.00        | 1.00 | 1.00 | 1.00        | 1.00 | 1.00 | 1.00       | 1.00 | 1.00 | 1.00       | 1.00 | 1.00 |
| Initial Bse:                                | 320         | 2    | 373  | 0           | 0    | 0    | 125        | 854  | 0    | 0          | 803  | 240  |
| Added Vol:                                  | 0           | 0    | 0    | 0           | 0    | 0    | 0          | 0    | 0    | 0          | 0    | 0    |
| PasserByVol:                                | 0           | 0    | 0    | 0           | 0    | 0    | 0          | 0    | 0    | 0          | 0    | 0    |
| Initial Fut:                                | 320         | 2    | 373  | 0           | 0    | 0    | 125        | 854  | 0    | 0          | 803  | 240  |
| User Adj:                                   | 1.00        | 1.00 | 1.00 | 1.00        | 1.00 | 1.00 | 1.00       | 1.00 | 1.00 | 1.00       | 1.00 | 1.00 |
| PHF Adj:                                    | 1.00        | 1.00 | 1.00 | 1.00        | 1.00 | 1.00 | 1.00       | 1.00 | 1.00 | 1.00       | 1.00 | 1.00 |
| PHF Volume:                                 | 320         | 2    | 373  | 0           | 0    | 0    | 125        | 854  | 0    | 0          | 803  | 240  |
| Reduct Vol:                                 | 0           | 0    | 0    | 0           | 0    | 0    | 0          | 0    | 0    | 0          | 0    | 0    |
| Reduced Vol:                                | 320         | 2    | 373  | 0           | 0    | 0    | 125        | 854  | 0    | 0          | 803  | 240  |
| PCE Adj:                                    | 1.00        | 1.00 | 1.00 | 1.00        | 1.00 | 1.00 | 1.00       | 1.00 | 1.00 | 1.00       | 1.00 | 1.00 |
| MLF Adj:                                    | 1.00        | 1.00 | 1.00 | 1.00        | 1.00 | 1.00 | 1.00       | 1.00 | 1.00 | 1.00       | 1.00 | 1.00 |
| FinalVolume:                                | 320         | 2    | 373  | 0           | 0    | 0    | 125        | 854  | 0    | 0          | 803  | 240  |
| Saturation Flow Module:                     |             |      |      |             |      |      |            |      |      |            |      |      |
| Sat/Lane:                                   | 1900        | 1900 | 1900 | 1900        | 1900 | 1900 | 1900       | 1900 | 1900 | 1900       | 1900 | 1900 |
| Adjustment:                                 | 0.93        | 0.95 | 0.92 | 0.92        | 1.00 | 0.92 | 0.83       | 1.00 | 0.92 | 0.92       | 1.00 | 0.92 |
| Lanes:                                      | 1.99        | 0.01 | 1.00 | 0.00        | 0.00 | 0.00 | 2.00       | 2.00 | 0.00 | 0.00       | 2.00 | 1.00 |
| Final Sat.:                                 | 3528        | 22   | 1750 | 0           | 0    | 0    | 3150       | 3800 | 0    | 0          | 3800 | 1750 |
| Capacity Analysis Module:                   |             |      |      |             |      |      |            |      |      |            |      |      |
| Vol/Sat:                                    | 0.09        | 0.09 | 0.21 | 0.00        | 0.00 | 0.00 | 0.04       | 0.22 | 0.00 | 0.00       | 0.21 | 0.14 |
| Crit Moves:                                 | ****        |      |      | ****        |      |      | ****       |      |      | ****       |      |      |
| Green Time:                                 | 27.1        | 27.1 | 27.1 | 0.0         | 0.0  | 0.0  | 7.0        | 33.9 | 0.0  | 0.0        | 26.9 | 26.9 |
| Volume/Cap:                                 | 0.23        | 0.23 | 0.55 | 0.00        | 0.00 | 0.00 | 0.40       | 0.46 | 0.00 | 0.00       | 0.55 | 0.36 |
| Delay/Veh:                                  | 14.5        | 14.5 | 17.7 | 0.0         | 0.0  | 0.0  | 30.3       | 12.2 | 0.0  | 0.0        | 17.3 | 15.7 |
| User DelAdj:                                | 1.00        | 1.00 | 1.00 | 1.00        | 1.00 | 1.00 | 1.00       | 1.00 | 1.00 | 1.00       | 1.00 | 1.00 |
| AdjDel/Veh:                                 | 14.5        | 14.5 | 17.7 | 0.0         | 0.0  | 0.0  | 30.3       | 12.2 | 0.0  | 0.0        | 17.3 | 15.7 |
| LOS by Move:                                | B           | B    | B    | A           | A    | A    | C          | B    | A    | A          | B    | B    |
| HCM2k95thQ:                                 | 5           | 5    | 14   | 0           | 0    | 0    | 3          | 12   | 0    | 0          | 13   | 8    |

Note: Queue reported is the number of cars per lane.

BART

Level Of Service Computation Report  
 2000 HCM Operations (Future Volume Alternative)  
 AM - Existing Conditions

Intersection #3023: 101/SANTA CLARA [Study Int 14]

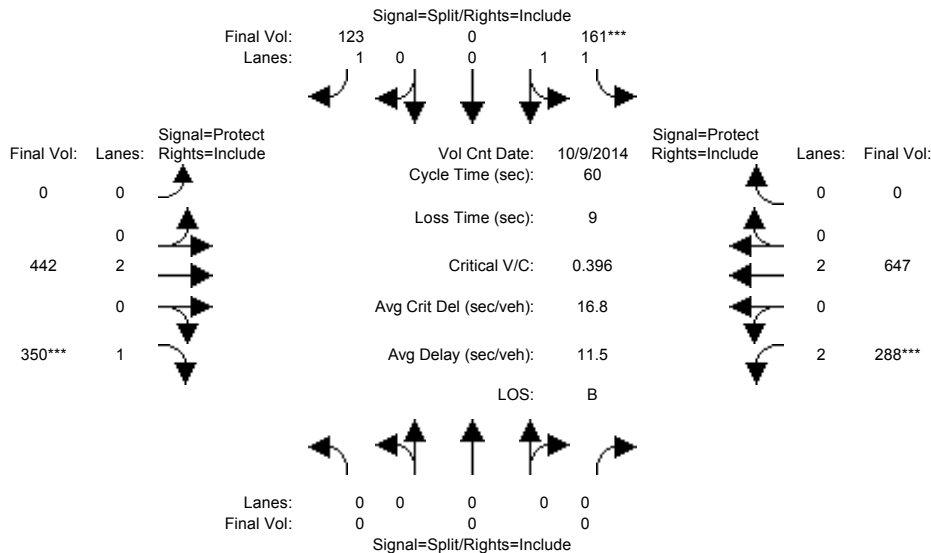

| Approach:                                   | North Bound |      |      | South Bound |      |      | East Bound |      |      | West Bound |      |      |
|---|-------------|------|------|-------------|------|------|------------|------|------|------------|------|------|
| Movement:                                   | L           | T    | R    | L           | T    | R    | L          | T    | R    | L          | T    | R    |
| Min. Green:                                 | 0           | 0    | 0    | 10          | 10   | 10   | 0          | 10   | 10   | 7          | 10   | 0    |
| Y+R:  | 4.0         | 4.0  | 4.0  | 4.0         | 4.0  | 4.0  | 4.0        | 4.0  | 4.0  | 4.0        | 4.0  | 4.0  |
| Volume Module: >> Count Date: 9 Oct 2014 << |             |      |      |             |      |      |            |      |      |            |      |      |
| Base Vol:                                   | 0           | 0    | 0    | 161         | 0    | 123  | 0          | 442  | 350  | 288        | 647  | 0    |
| Growth Adj:                                 | 1.00        | 1.00 | 1.00 | 1.00        | 1.00 | 1.00 | 1.00       | 1.00 | 1.00 | 1.00       | 1.00 | 1.00 |
| Initial Bse:                                | 0           | 0    | 0    | 161         | 0    | 123  | 0          | 442  | 350  | 288        | 647  | 0    |
| Added Vol:                                  | 0           | 0    | 0    | 0           | 0    | 0    | 0          | 0    | 0    | 0          | 0    | 0    |
| PasserByVol:                                | 0           | 0    | 0    | 0           | 0    | 0    | 0          | 0    | 0    | 0          | 0    | 0    |
| Initial Fut:                                | 0           | 0    | 0    | 161         | 0    | 123  | 0          | 442  | 350  | 288        | 647  | 0    |
| User Adj:                                   | 1.00        | 1.00 | 1.00 | 1.00        | 1.00 | 1.00 | 1.00       | 1.00 | 1.00 | 1.00       | 1.00 | 1.00 |
| PHF Adj:                                    | 1.00        | 1.00 | 1.00 | 1.00        | 1.00 | 1.00 | 1.00       | 1.00 | 1.00 | 1.00       | 1.00 | 1.00 |
| PHF Volume:                                 | 0           | 0    | 0    | 161         | 0    | 123  | 0          | 442  | 350  | 288        | 647  | 0    |
| Reduct Vol:                                 | 0           | 0    | 0    | 0           | 0    | 0    | 0          | 0    | 0    | 0          | 0    | 0    |
| Reduced Vol:                                | 0           | 0    | 0    | 161         | 0    | 123  | 0          | 442  | 350  | 288        | 647  | 0    |
| PCE Adj:                                    | 1.00        | 1.00 | 1.00 | 1.00        | 1.00 | 1.00 | 1.00       | 1.00 | 1.00 | 1.00       | 1.00 | 1.00 |
| MLF Adj:                                    | 1.00        | 1.00 | 1.00 | 1.00        | 1.00 | 1.00 | 1.00       | 1.00 | 1.00 | 1.00       | 1.00 | 1.00 |
| FinalVolume:                                | 0           | 0    | 0    | 161         | 0    | 123  | 0          | 442  | 350  | 288        | 647  | 0    |
| Saturation Flow Module:                     |             |      |      |             |      |      |            |      |      |            |      |      |
| Sat/Lane:                                   | 1900        | 1900 | 1900 | 1900        | 1900 | 1900 | 1900       | 1900 | 1900 | 1900       | 1900 | 1900 |
| Adjustment:                                 | 0.92        | 1.00 | 0.92 | 0.93        | 1.00 | 0.92 | 0.92       | 1.00 | 0.92 | 0.83       | 1.00 | 0.92 |
| Lanes:                                      | 0.00        | 0.00 | 0.00 | 2.00        | 0.00 | 1.00 | 0.00       | 2.00 | 1.00 | 2.00       | 2.00 | 0.00 |
| Final Sat.:                                 | 0           | 0    | 0    | 3550        | 0    | 1750 | 0          | 3800 | 1750 | 3150       | 3800 | 0    |
| Capacity Analysis Module:                   |             |      |      |             |      |      |            |      |      |            |      |      |
| Vol/Sat:                                    | 0.00        | 0.00 | 0.00 | 0.05        | 0.00 | 0.07 | 0.00       | 0.12 | 0.20 | 0.09       | 0.17 | 0.00 |
| Crit Moves:                                 | *****       |      |      |             |      |      |            |      |      |            |      |      |
| Green Time:                                 | 0.0         | 0.0  | 0.0  | 10.6        | 0.0  | 10.6 | 0.0        | 27.7 | 27.7 | 12.7       | 40.4 | 0.0  |
| Volume/Cap:                                 | 0.00        | 0.00 | 0.00 | 0.26        | 0.00 | 0.40 | 0.00       | 0.25 | 0.43 | 0.43       | 0.25 | 0.00 |
| Delay/Veh:                                  | 0.0         | 0.0  | 0.0  | 21.5        | 0.0  | 22.7 | 0.0        | 9.9  | 11.2 | 21.0       | 3.9  | 0.0  |
| User DelAdj:                                | 1.00        | 1.00 | 1.00 | 1.00        | 1.00 | 1.00 | 1.00       | 1.00 | 1.00 | 1.00       | 1.00 | 1.00 |
| AdjDel/Veh:                                 | 0.0         | 0.0  | 0.0  | 21.5        | 0.0  | 22.7 | 0.0        | 9.9  | 11.2 | 21.0       | 3.9  | 0.0  |
| LOS by Move:                                | A           | A    | A    | C           | A    | C    | A          | A    | B    | C          | A    | A    |
| HCM2k95thQ:                                 | 0           | 0    | 0    | 3           | 0    | 5    | 0          | 5    | 9    | 6          | 5    | 0    |

Note: Queue reported is the number of cars per lane.

BART

Level Of Service Computation Report  
 2000 HCM Operations (Future Volume Alternative)  
 PM - Existing Conditions

Intersection #3023: 101/SANTA CLARA [Study Int 14]

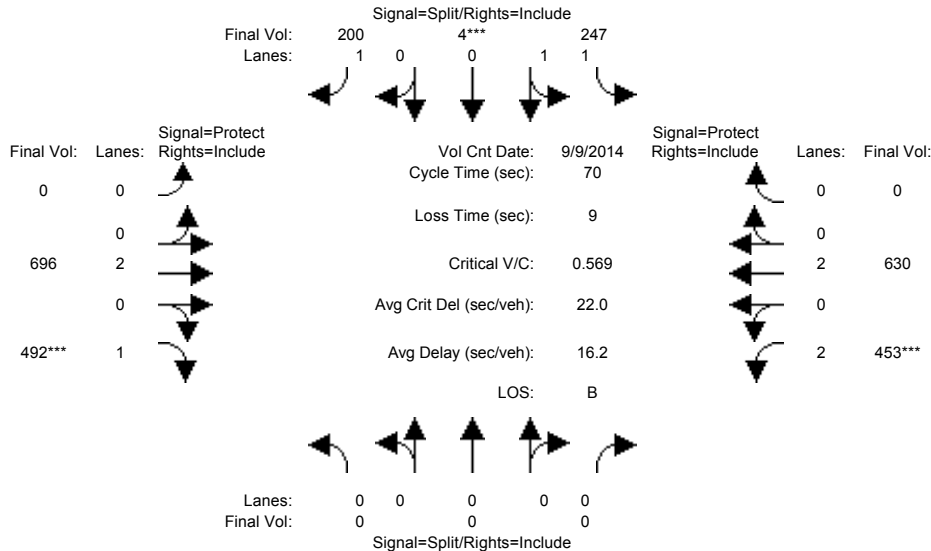

| Approach:                                   | North Bound |      |      | South Bound |      |      | East Bound |      |      | West Bound |      |      |
|---|-------------|------|------|-------------|------|------|------------|------|------|------------|------|------|
| Movement:                                   | L           | T    | R    | L           | T    | R    | L          | T    | R    | L          | T    | R    |
| Min. Green:                                 | 0           | 0    | 0    | 10          | 10   | 10   | 0          | 10   | 10   | 7          | 10   | 0    |
| Y+R:  | 4.0         | 4.0  | 4.0  | 4.0         | 4.0  | 4.0  | 4.0        | 4.0  | 4.0  | 4.0        | 4.0  | 4.0  |
| Volume Module: >> Count Date: 9 Sep 2014 << |             |      |      |             |      |      |            |      |      |            |      |      |
| Base Vol:                                   | 0           | 0    | 0    | 247         | 4    | 200  | 0          | 696  | 492  | 453        | 630  | 0    |
| Growth Adj:                                 | 1.00        | 1.00 | 1.00 | 1.00        | 1.00 | 1.00 | 1.00       | 1.00 | 1.00 | 1.00       | 1.00 | 1.00 |
| Initial Bse:                                | 0           | 0    | 0    | 247         | 4    | 200  | 0          | 696  | 492  | 453        | 630  | 0    |
| Added Vol:                                  | 0           | 0    | 0    | 0           | 0    | 0    | 0          | 0    | 0    | 0          | 0    | 0    |
| PasserByVol:                                | 0           | 0    | 0    | 0           | 0    | 0    | 0          | 0    | 0    | 0          | 0    | 0    |
| Initial Fut:                                | 0           | 0    | 0    | 247         | 4    | 200  | 0          | 696  | 492  | 453        | 630  | 0    |
| User Adj:                                   | 1.00        | 1.00 | 1.00 | 1.00        | 1.00 | 1.00 | 1.00       | 1.00 | 1.00 | 1.00       | 1.00 | 1.00 |
| PHF Adj:                                    | 1.00        | 1.00 | 1.00 | 1.00        | 1.00 | 1.00 | 1.00       | 1.00 | 1.00 | 1.00       | 1.00 | 1.00 |
| PHF Volume:                                 | 0           | 0    | 0    | 247         | 4    | 200  | 0          | 696  | 492  | 453        | 630  | 0    |
| Reduct Vol:                                 | 0           | 0    | 0    | 0           | 0    | 0    | 0          | 0    | 0    | 0          | 0    | 0    |
| Reduced Vol:                                | 0           | 0    | 0    | 247         | 4    | 200  | 0          | 696  | 492  | 453        | 630  | 0    |
| PCE Adj:                                    | 1.00        | 1.00 | 1.00 | 1.00        | 1.00 | 1.00 | 1.00       | 1.00 | 1.00 | 1.00       | 1.00 | 1.00 |
| MLF Adj:                                    | 1.00        | 1.00 | 1.00 | 1.00        | 1.00 | 1.00 | 1.00       | 1.00 | 1.00 | 1.00       | 1.00 | 1.00 |
| FinalVolume:                                | 0           | 0    | 0    | 247         | 4    | 200  | 0          | 696  | 492  | 453        | 630  | 0    |
| Saturation Flow Module:                     |             |      |      |             |      |      |            |      |      |            |      |      |
| Sat/Lane:                                   | 1900        | 1900 | 1900 | 1900        | 1900 | 1900 | 1900       | 1900 | 1900 | 1900       | 1900 | 1900 |
| Adjustment:                                 | 0.92        | 1.00 | 0.92 | 0.93        | 0.95 | 0.92 | 0.92       | 1.00 | 0.92 | 0.83       | 1.00 | 0.92 |
| Lanes:                                      | 0.00        | 0.00 | 0.00 | 1.97        | 0.03 | 1.00 | 0.00       | 2.00 | 1.00 | 2.00       | 2.00 | 0.00 |
| Final Sat.:                                 | 0           | 0    | 0    | 3493        | 57   | 1750 | 0          | 3800 | 1750 | 3150       | 3800 | 0    |
| Capacity Analysis Module:                   |             |      |      |             |      |      |            |      |      |            |      |      |
| Vol/Sat:                                    | 0.00        | 0.00 | 0.00 | 0.07        | 0.07 | 0.11 | 0.00       | 0.18 | 0.28 | 0.14       | 0.17 | 0.00 |
| Crit Moves:                                 |             |      |      | ****        |      |      |            |      | **** | ****       |      |      |
| Green Time:                                 | 0.0         | 0.0  | 0.0  | 14.1        | 14.1 | 14.1 | 0.0        | 31.1 | 31.1 | 15.9       | 46.9 | 0.0  |
| Volume/Cap:                                 | 0.00        | 0.00 | 0.00 | 0.35        | 0.35 | 0.57 | 0.00       | 0.41 | 0.63 | 0.63       | 0.25 | 0.00 |
| Delay/Veh:                                  | 0.0         | 0.0  | 0.0  | 24.3        | 24.3 | 27.4 | 0.0        | 13.4 | 16.8 | 26.3       | 4.6  | 0.0  |
| User DelAdj:                                | 1.00        | 1.00 | 1.00 | 1.00        | 1.00 | 1.00 | 1.00       | 1.00 | 1.00 | 1.00       | 1.00 | 1.00 |
| AdjDel/Veh:                                 | 0.0         | 0.0  | 0.0  | 24.3        | 24.3 | 27.4 | 0.0        | 13.4 | 16.8 | 26.3       | 4.6  | 0.0  |
| LOS by Move:                                | A           | A    | A    | C           | C    | C    | A          | B    | B    | C          | A    | A    |
| HCM2k95thQ:                                 | 0           | 0    | 0    | 6           | 6    | 10   | 0          | 10   | 16   | 10         | 5    | 0    |

Note: Queue reported is the number of cars per lane.

BART

Level Of Service Computation Report  
 2000 HCM Operations (Future Volume Alternative)  
 AM - Existing Conditions

Intersection #3036: 280/MCLAUGHLIN [Study Int 25]

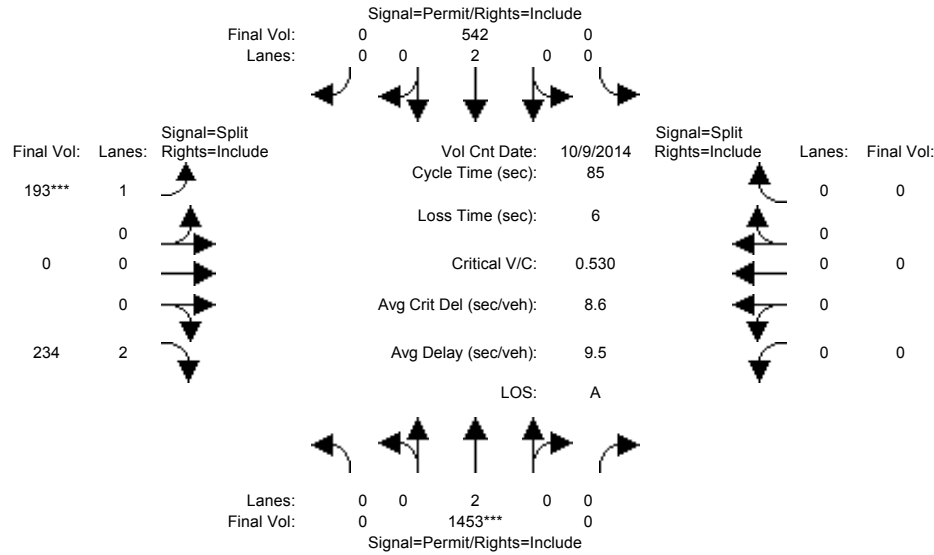

| Approach:                 | North Bound                  |      |      | South Bound |      |      | East Bound |      |      | West Bound |      |      |
|---------------------------|------------------------------|------|------|-------------|------|------|------------|------|------|------------|------|------|
| Movement:                 | L                            | T    | R    | L           | T    | R    | L          | T    | R    | L          | T    | R    |
| Min. Green:               | 0                            | 10   | 0    | 0           | 10   | 0    | 10         | 0    | 10   | 0          | 0    | 0    |
| Y+R:                      | 4.0                          | 4.0  | 4.0  | 4.0         | 4.0  | 4.0  | 4.0        | 4.0  | 4.0  | 4.0        | 4.0  | 4.0  |
| -----                     |                              |      |      |             |      |      |            |      |      |            |      |      |
| Volume Module:            | >> Count Date: 9 Oct 2014 << |      |      |             |      |      |            |      |      |            |      |      |
| Base Vol:                 | 0                            | 1453 | 0    | 0           | 542  | 0    | 193        | 0    | 234  | 0          | 0    | 0    |
| Growth Adj:               | 1.00                         | 1.00 | 1.00 | 1.00        | 1.00 | 1.00 | 1.00       | 1.00 | 1.00 | 1.00       | 1.00 | 1.00 |
| Initial Bse:              | 0                            | 1453 | 0    | 0           | 542  | 0    | 193        | 0    | 234  | 0          | 0    | 0    |
| Added Vol:                | 0                            | 0    | 0    | 0           | 0    | 0    | 0          | 0    | 0    | 0          | 0    | 0    |
| PasserByVol:              | 0                            | 0    | 0    | 0           | 0    | 0    | 0          | 0    | 0    | 0          | 0    | 0    |
| Initial Fut:              | 0                            | 1453 | 0    | 0           | 542  | 0    | 193        | 0    | 234  | 0          | 0    | 0    |
| User Adj:                 | 1.00                         | 1.00 | 1.00 | 1.00        | 1.00 | 1.00 | 1.00       | 1.00 | 1.00 | 1.00       | 1.00 | 1.00 |
| PHF Adj:                  | 1.00                         | 1.00 | 1.00 | 1.00        | 1.00 | 1.00 | 1.00       | 1.00 | 1.00 | 1.00       | 1.00 | 1.00 |
| PHF Volume:               | 0                            | 1453 | 0    | 0           | 542  | 0    | 193        | 0    | 234  | 0          | 0    | 0    |
| Reduct Vol:               | 0                            | 0    | 0    | 0           | 0    | 0    | 0          | 0    | 0    | 0          | 0    | 0    |
| Reduced Vol:              | 0                            | 1453 | 0    | 0           | 542  | 0    | 193        | 0    | 234  | 0          | 0    | 0    |
| PCE Adj:                  | 1.00                         | 1.00 | 1.00 | 1.00        | 1.00 | 1.00 | 1.00       | 1.00 | 1.00 | 1.00       | 1.00 | 1.00 |
| MLF Adj:                  | 1.00                         | 1.00 | 1.00 | 1.00        | 1.00 | 1.00 | 1.00       | 1.00 | 1.00 | 1.00       | 1.00 | 1.00 |
| FinalVolume:              | 0                            | 1453 | 0    | 0           | 542  | 0    | 193        | 0    | 234  | 0          | 0    | 0    |
| -----                     |                              |      |      |             |      |      |            |      |      |            |      |      |
| Saturation Flow Module:   |                              |      |      |             |      |      |            |      |      |            |      |      |
| Sat/Lane:                 | 1900                         | 1900 | 1900 | 1900        | 1900 | 1900 | 1900       | 1900 | 1900 | 1900       | 1900 | 1900 |
| Adjustment:               | 0.92                         | 1.00 | 0.92 | 0.92        | 1.00 | 0.92 | 0.92       | 1.00 | 0.83 | 0.92       | 1.00 | 0.92 |
| Lanes:                    | 0.00                         | 2.00 | 0.00 | 0.00        | 2.00 | 0.00 | 1.00       | 0.00 | 2.00 | 0.00       | 0.00 | 0.00 |
| Final Sat.:               | 0                            | 3800 | 0    | 0           | 3800 | 0    | 1750       | 0    | 3150 | 0          | 0    | 0    |
| -----                     |                              |      |      |             |      |      |            |      |      |            |      |      |
| Capacity Analysis Module: |                              |      |      |             |      |      |            |      |      |            |      |      |
| Vol/Sat:                  | 0.00                         | 0.38 | 0.00 | 0.00        | 0.14 | 0.00 | 0.11       | 0.00 | 0.07 | 0.00       | 0.00 | 0.00 |
| Crit Moves:               | *****                        |      |      |             |      |      |            |      |      |            |      |      |
| Green Time:               | 0.0                          | 61.3 | 0.0  | 0.0         | 61.3 | 0.0  | 17.7       | 0.0  | 17.7 | 0.0        | 0.0  | 0.0  |
| Volume/Cap:               | 0.00                         | 0.53 | 0.00 | 0.00        | 0.20 | 0.00 | 0.53       | 0.00 | 0.36 | 0.00       | 0.00 | 0.00 |
| Delay/Veh:                | 0.0                          | 5.5  | 0.0  | 0.0         | 3.9  | 0.0  | 31.4       | 0.0  | 29.1 | 0.0        | 0.0  | 0.0  |
| User DelAdj:              | 1.00                         | 1.00 | 1.00 | 1.00        | 1.00 | 1.00 | 1.00       | 1.00 | 1.00 | 1.00       | 1.00 | 1.00 |
| AdjDel/Veh:               | 0.0                          | 5.5  | 0.0  | 0.0         | 3.9  | 0.0  | 31.4       | 0.0  | 29.1 | 0.0        | 0.0  | 0.0  |
| LOS by Move:              | A                            | A    | A    | A           | A    | A    | C          | A    | C    | A          | A    | A    |
| HCM2k95thQ:               | 0                            | 16   | 0    | 0           | 5    | 0    | 11         | 0    | 7    | 0          | 0    | 0    |

Note: Queue reported is the number of cars per lane.

BART

Level Of Service Computation Report  
2000 HCM Operations (Future Volume Alternative)  
PM - Existing Conditions

Intersection #3036: 280/MCLAUGHLIN [Study Int 25]

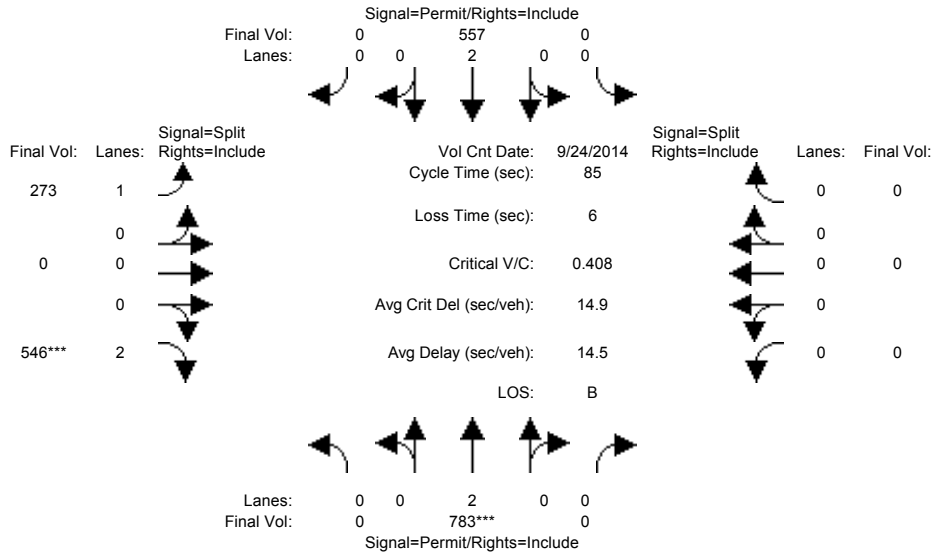

| Approach:                                    | North Bound |      |      | South Bound |      |      | East Bound |      |      | West Bound |      |      |
|--|-------------|------|------|-------------|------|------|------------|------|------|------------|------|------|
| Movement:                                    | L           | T    | R    | L           | T    | R    | L          | T    | R    | L          | T    | R    |
| Min. Green:                                  | 0           | 10   | 0    | 0           | 10   | 0    | 10         | 0    | 10   | 0          | 0    | 0    |
| Y+R:   | 4.0         | 4.0  | 4.0  | 4.0         | 4.0  | 4.0  | 4.0        | 4.0  | 4.0  | 4.0        | 4.0  | 4.0  |
| Volume Module: >> Count Date: 24 Sep 2014 << |             |      |      |             |      |      |            |      |      |            |      |      |
| Base Vol:                                    | 0           | 783  | 0    | 0           | 557  | 0    | 273        | 0    | 546  | 0          | 0    | 0    |
| Growth Adj:                                  | 1.00        | 1.00 | 1.00 | 1.00        | 1.00 | 1.00 | 1.00       | 1.00 | 1.00 | 1.00       | 1.00 | 1.00 |
| Initial Bse:                                 | 0           | 783  | 0    | 0           | 557  | 0    | 273        | 0    | 546  | 0          | 0    | 0    |
| Added Vol:                                   | 0           | 0    | 0    | 0           | 0    | 0    | 0          | 0    | 0    | 0          | 0    | 0    |
| PasserByVol:                                 | 0           | 0    | 0    | 0           | 0    | 0    | 0          | 0    | 0    | 0          | 0    | 0    |
| Initial Fut:                                 | 0           | 783  | 0    | 0           | 557  | 0    | 273        | 0    | 546  | 0          | 0    | 0    |
| User Adj:                                    | 1.00        | 1.00 | 1.00 | 1.00        | 1.00 | 1.00 | 1.00       | 1.00 | 1.00 | 1.00       | 1.00 | 1.00 |
| PHF Adj:                                     | 1.00        | 1.00 | 1.00 | 1.00        | 1.00 | 1.00 | 1.00       | 1.00 | 1.00 | 1.00       | 1.00 | 1.00 |
| PHF Volume:                                  | 0           | 783  | 0    | 0           | 557  | 0    | 273        | 0    | 546  | 0          | 0    | 0    |
| Reduct Vol:                                  | 0           | 0    | 0    | 0           | 0    | 0    | 0          | 0    | 0    | 0          | 0    | 0    |
| Reduced Vol:                                 | 0           | 783  | 0    | 0           | 557  | 0    | 273        | 0    | 546  | 0          | 0    | 0    |
| PCE Adj:                                     | 1.00        | 1.00 | 1.00 | 1.00        | 1.00 | 1.00 | 1.00       | 1.00 | 1.00 | 1.00       | 1.00 | 1.00 |
| MLF Adj:                                     | 1.00        | 1.00 | 1.00 | 1.00        | 1.00 | 1.00 | 1.00       | 1.00 | 1.00 | 1.00       | 1.00 | 1.00 |
| FinalVolume:                                 | 0           | 783  | 0    | 0           | 557  | 0    | 273        | 0    | 546  | 0          | 0    | 0    |
| Saturation Flow Module:                      |             |      |      |             |      |      |            |      |      |            |      |      |
| Sat/Lane:                                    | 1900        | 1900 | 1900 | 1900        | 1900 | 1900 | 1900       | 1900 | 1900 | 1900       | 1900 | 1900 |
| Adjustment:                                  | 0.92        | 1.00 | 0.92 | 0.92        | 1.00 | 0.92 | 0.92       | 1.00 | 0.83 | 0.92       | 1.00 | 0.92 |
| Lanes:                                       | 0.00        | 2.00 | 0.00 | 0.00        | 2.00 | 0.00 | 1.00       | 0.00 | 2.00 | 0.00       | 0.00 | 0.00 |
| Final Sat.:                                  | 0           | 3800 | 0    | 0           | 3800 | 0    | 1750       | 0    | 3150 | 0          | 0    | 0    |
| Capacity Analysis Module:                    |             |      |      |             |      |      |            |      |      |            |      |      |
| Vol/Sat:                                     | 0.00        | 0.21 | 0.00 | 0.00        | 0.15 | 0.00 | 0.16       | 0.00 | 0.17 | 0.00       | 0.00 | 0.00 |
| Crit Moves:                                  | ****        |      |      | ****        |      |      | ****       |      |      | ****       |      |      |
| Green Time:                                  | 0.0         | 42.9 | 0.0  | 0.0         | 42.9 | 0.0  | 36.1       | 0.0  | 36.1 | 0.0        | 0.0  | 0.0  |
| Volume/Cap:                                  | 0.00        | 0.41 | 0.00 | 0.00        | 0.29 | 0.00 | 0.37       | 0.00 | 0.41 | 0.00       | 0.00 | 0.00 |
| Delay/Veh:                                   | 0.0         | 13.3 | 0.0  | 0.0         | 12.3 | 0.0  | 17.0       | 0.0  | 17.2 | 0.0        | 0.0  | 0.0  |
| User DelAdj:                                 | 1.00        | 1.00 | 1.00 | 1.00        | 1.00 | 1.00 | 1.00       | 1.00 | 1.00 | 1.00       | 1.00 | 1.00 |
| AdjDel/Veh:                                  | 0.0         | 13.3 | 0.0  | 0.0         | 12.3 | 0.0  | 17.0       | 0.0  | 17.2 | 0.0        | 0.0  | 0.0  |
| LOS by Move:                                 | A           | B    | A    | A           | B    | A    | B          | A    | B    | A          | A    | A    |
| HCM2k95thQ:                                  | 0           | 12   | 0    | 0           | 8    | 0    | 10         | 0    | 12   | 0          | 0    | 0    |

Note: Queue reported is the number of cars per lane.

BART

Level Of Service Computation Report  
 2000 HCM Operations (Future Volume Alternative)  
 AM - Existing Conditions

Intersection #3042: 680N/ALUM ROCK (E) [Study Int 20]

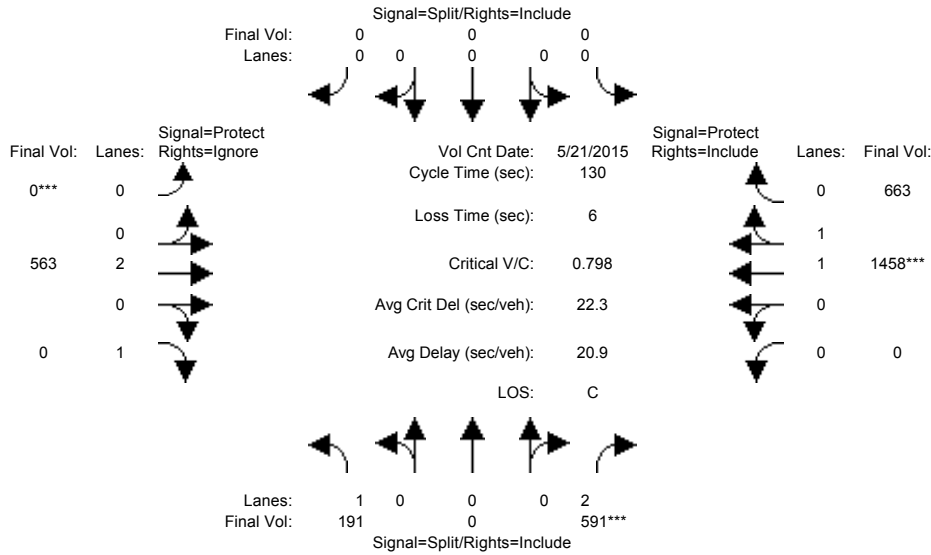

| Approach:  | North Bound |      |      | South Bound |      |      | East Bound |      |      | West Bound |      |      |
|--|-------------|------|------|-------------|------|------|------------|------|------|------------|------|------|
| Movement:  | L           | T    | R    | L           | T    | R    | L          | T    | R    | L          | T    | R    |
| Min. Green:  | 10          | 0    | 10   | 0           | 0    | 0    | 0          | 10   | 10   | 0          | 10   | 10   |
| Y+R:   | 4.0         | 4.0  | 4.0  | 4.0         | 4.0  | 4.0  | 4.0        | 4.0  | 4.0  | 4.0        | 4.0  | 4.0  |
| Volume Module: >> Count Date: 21 May 2015 << 7:30-8:30AM |             |      |      |             |      |      |            |      |      |            |      |      |
| Base Vol:  | 191         | 0    | 591  | 0           | 0    | 0    | 0          | 563  | 335  | 0          | 1458 | 663  |
| Growth Adj:  | 1.00        | 1.00 | 1.00 | 1.00        | 1.00 | 1.00 | 1.00       | 1.00 | 1.00 | 1.00       | 1.00 | 1.00 |
| Initial Bse:   | 191         | 0    | 591  | 0           | 0    | 0    | 0          | 563  | 335  | 0          | 1458 | 663  |
| Added Vol:   | 0           | 0    | 0    | 0           | 0    | 0    | 0          | 0    | 0    | 0          | 0    | 0    |
| PasserByVol:   | 0           | 0    | 0    | 0           | 0    | 0    | 0          | 0    | 0    | 0          | 0    | 0    |
| Initial Fut:   | 191         | 0    | 591  | 0           | 0    | 0    | 0          | 563  | 335  | 0          | 1458 | 663  |
| User Adj:  | 1.00        | 1.00 | 1.00 | 1.00        | 1.00 | 1.00 | 1.00       | 1.00 | 0.00 | 1.00       | 1.00 | 1.00 |
| PHF Adj:   | 1.00        | 1.00 | 1.00 | 1.00        | 1.00 | 1.00 | 1.00       | 1.00 | 0.00 | 1.00       | 1.00 | 1.00 |
| PHF Volume:  | 191         | 0    | 591  | 0           | 0    | 0    | 0          | 563  | 0    | 0          | 1458 | 663  |
| Reduct Vol:  | 0           | 0    | 0    | 0           | 0    | 0    | 0          | 0    | 0    | 0          | 0    | 0    |
| Reduced Vol:   | 191         | 0    | 591  | 0           | 0    | 0    | 0          | 563  | 0    | 0          | 1458 | 663  |
| PCE Adj:   | 1.00        | 1.00 | 1.00 | 1.00        | 1.00 | 1.00 | 1.00       | 1.00 | 0.00 | 1.00       | 1.00 | 1.00 |
| MLF Adj:   | 1.00        | 1.00 | 1.00 | 1.00        | 1.00 | 1.00 | 1.00       | 1.00 | 0.00 | 1.00       | 1.00 | 1.00 |
| Final Volume:  | 191         | 0    | 591  | 0           | 0    | 0    | 0          | 563  | 0    | 0          | 1458 | 663  |
| Saturation Flow Module:                                  |             |      |      |             |      |      |            |      |      |            |      |      |
| Sat/Lane:  | 1900        | 1900 | 1900 | 1900        | 1900 | 1900 | 1900       | 1900 | 1900 | 1900       | 1900 | 1900 |
| Adjustment:  | 0.92        | 1.00 | 0.83 | 0.92        | 1.00 | 0.92 | 0.92       | 1.00 | 0.92 | 0.92       | 0.99 | 0.95 |
| Lanes:   | 1.00        | 0.00 | 2.00 | 0.00        | 0.00 | 0.00 | 0.00       | 2.00 | 1.00 | 0.00       | 1.36 | 0.64 |
| Final Sat.:  | 1750        | 0    | 3150 | 0           | 0    | 0    | 0          | 3800 | 1750 | 0          | 2543 | 1156 |
| Capacity Analysis Module:                                |             |      |      |             |      |      |            |      |      |            |      |      |
| Vol/Sat:   | 0.11        | 0.00 | 0.19 | 0.00        | 0.00 | 0.00 | 0.00       | 0.15 | 0.00 | 0.00       | 0.57 | 0.57 |
| Crit Moves:  | ****        |      |      | ****        |      |      | ****       |      |      | ****       |      |      |
| Green Time:  | 30.6        | 0.0  | 30.6 | 0.0         | 0.0  | 0.0  | 0.0        | 93.4 | 0.0  | 0.0        | 93.4 | 93.4 |
| Volume/Cap:  | 0.46        | 0.00 | 0.80 | 0.00        | 0.00 | 0.00 | 0.00       | 0.21 | 0.00 | 0.00       | 0.80 | 0.80 |
| Delay/Veh:   | 43.5        | 0.0  | 52.9 | 0.0         | 0.0  | 0.0  | 0.0        | 6.1  | 0.0  | 0.0        | 13.8 | 13.8 |
| User DelAdj:   | 1.00        | 1.00 | 1.00 | 1.00        | 1.00 | 1.00 | 1.00       | 1.00 | 1.00 | 1.00       | 1.00 | 1.00 |
| AdjDel/Veh:  | 43.5        | 0.0  | 52.9 | 0.0         | 0.0  | 0.0  | 0.0        | 6.1  | 0.0  | 0.0        | 13.8 | 13.8 |
| LOS by Move:   | D           | A    | D    | A           | A    | A    | A          | A    | A    | A          | B    | B    |
| HCM2k95thQ:  | 14          | 0    | 27   | 0           | 0    | 0    | 0          | 7    | 0    | 0          | 48   | 48   |

Note: Queue reported is the number of cars per lane.



BART

Level Of Service Computation Report  
 2000 HCM Operations (Future Volume Alternative)  
 PM - Existing Conditions

Intersection #3042: 680N/ALUM ROCK (E) [Study Int 20]

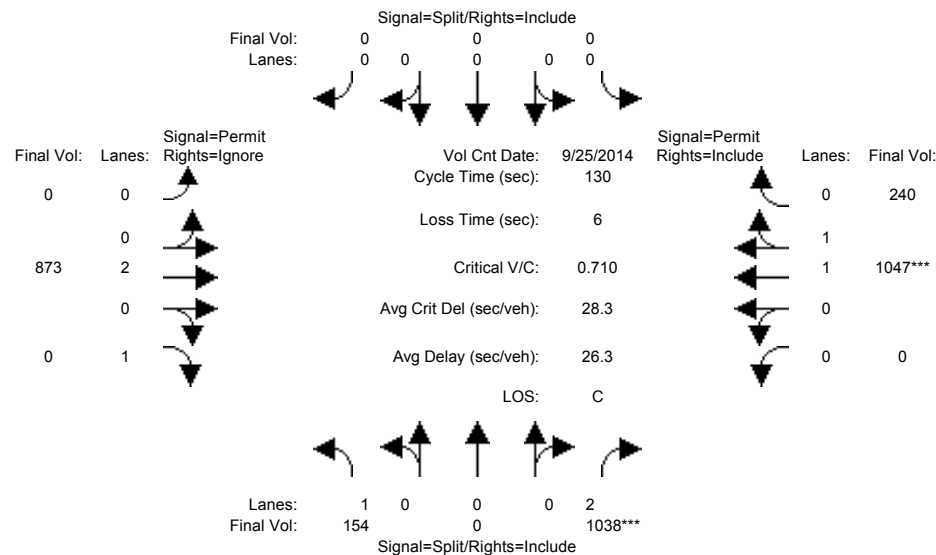

| Approach:  | North Bound |      |      | South Bound |      |      | East Bound |      |      | West Bound |      |      |
|--|-------------|------|------|-------------|------|------|------------|------|------|------------|------|------|
| Movement:  | L           | T    | R    | L           | T    | R    | L          | T    | R    | L          | T    | R    |
| Min. Green:  | 10          | 0    | 10   | 0           | 0    | 0    | 0          | 10   | 10   | 0          | 10   | 10   |
| Y+R:   | 4.0         | 4.0  | 4.0  | 4.0         | 4.0  | 4.0  | 4.0        | 4.0  | 4.0  | 4.0        | 4.0  | 4.0  |
| Volume Module: >> Count Date: 25 Sep 2014 << 4:45-5:45PM |             |      |      |             |      |      |            |      |      |            |      |      |
| Base Vol:  | 154         | 0    | 1038 | 0           | 0    | 0    | 0          | 873  | 0    | 0          | 1047 | 240  |
| Growth Adj:  | 1.00        | 1.00 | 1.00 | 1.00        | 1.00 | 1.00 | 1.00       | 1.00 | 1.00 | 1.00       | 1.00 | 1.00 |
| Initial Bse:   | 154         | 0    | 1038 | 0           | 0    | 0    | 0          | 873  | 0    | 0          | 1047 | 240  |
| Added Vol:   | 0           | 0    | 0    | 0           | 0    | 0    | 0          | 0    | 0    | 0          | 0    | 0    |
| PasserByVol:   | 0           | 0    | 0    | 0           | 0    | 0    | 0          | 0    | 0    | 0          | 0    | 0    |
| Initial Fut:   | 154         | 0    | 1038 | 0           | 0    | 0    | 0          | 873  | 0    | 0          | 1047 | 240  |
| User Adj:  | 1.00        | 1.00 | 1.00 | 1.00        | 1.00 | 1.00 | 1.00       | 1.00 | 0.00 | 1.00       | 1.00 | 1.00 |
| PHF Adj:   | 1.00        | 1.00 | 1.00 | 1.00        | 1.00 | 1.00 | 1.00       | 1.00 | 0.00 | 1.00       | 1.00 | 1.00 |
| PHF Volume:  | 154         | 0    | 1038 | 0           | 0    | 0    | 0          | 873  | 0    | 0          | 1047 | 240  |
| Reduct Vol:  | 0           | 0    | 0    | 0           | 0    | 0    | 0          | 0    | 0    | 0          | 0    | 0    |
| Reduced Vol:   | 154         | 0    | 1038 | 0           | 0    | 0    | 0          | 873  | 0    | 0          | 1047 | 240  |
| PCE Adj:   | 1.00        | 1.00 | 1.00 | 1.00        | 1.00 | 1.00 | 1.00       | 1.00 | 0.00 | 1.00       | 1.00 | 1.00 |
| MLF Adj:   | 1.00        | 1.00 | 1.00 | 1.00        | 1.00 | 1.00 | 1.00       | 1.00 | 0.00 | 1.00       | 1.00 | 1.00 |
| Final Volume:  | 154         | 0    | 1038 | 0           | 0    | 0    | 0          | 873  | 0    | 0          | 1047 | 240  |
| Saturation Flow Module:                                  |             |      |      |             |      |      |            |      |      |            |      |      |
| Sat/Lane:  | 1900        | 1900 | 1900 | 1900        | 1900 | 1900 | 1900       | 1900 | 1900 | 1900       | 1900 | 1900 |
| Adjustment:  | 0.92        | 1.00 | 0.83 | 0.92        | 1.00 | 0.92 | 0.92       | 1.00 | 0.92 | 0.92       | 0.98 | 0.95 |
| Lanes:   | 1.00        | 0.00 | 2.00 | 0.00        | 0.00 | 0.00 | 0.00       | 2.00 | 1.00 | 0.00       | 1.62 | 0.38 |
| Final Sat.:  | 1750        | 0    | 3150 | 0           | 0    | 0    | 0          | 3800 | 1750 | 0          | 3010 | 690  |
| Capacity Analysis Module:                                |             |      |      |             |      |      |            |      |      |            |      |      |
| Vol/Sat:   | 0.09        | 0.00 | 0.33 | 0.00        | 0.00 | 0.00 | 0.00       | 0.23 | 0.00 | 0.00       | 0.35 | 0.35 |
| Crit Moves:  | ****        |      |      |             |      |      |            |      |      |            |      |      |
| Green Time:  | 60.3        | 0.0  | 60.3 | 0.0         | 0.0  | 0.0  | 0.0        | 63.7 | 0.0  | 0.0        | 63.7 | 63.7 |
| Volume/Cap:  | 0.19        | 0.00 | 0.71 | 0.00        | 0.00 | 0.00 | 0.00       | 0.47 | 0.00 | 0.00       | 0.71 | 0.71 |
| Delay/Veh:   | 20.6        | 0.0  | 29.5 | 0.0         | 0.0  | 0.0  | 0.0        | 22.1 | 0.0  | 0.0        | 27.3 | 27.3 |
| User DelAdj:   | 1.00        | 1.00 | 1.00 | 1.00        | 1.00 | 1.00 | 1.00       | 1.00 | 1.00 | 1.00       | 1.00 | 1.00 |
| AdjDel/Veh:  | 20.6        | 0.0  | 29.5 | 0.0         | 0.0  | 0.0  | 0.0        | 22.1 | 0.0  | 0.0        | 27.3 | 27.3 |
| LOS by Move:   | C           | A    | C    | A           | A    | A    | A          | C    | A    | A          | C    | C    |
| HCM2k95thQ:  | 8           | 0    | 34   | 0           | 0    | 0    | 0          | 21   | 0    | 0          | 35   | 35   |

Note: Queue reported is the number of cars per lane.

BART

Level Of Service Computation Report  
 2000 HCM Operations (Future Volume Alternative)  
 AM - Existing Conditions

Intersection #3043: 680S/ALUM ROCK (W) [Study Int 19]

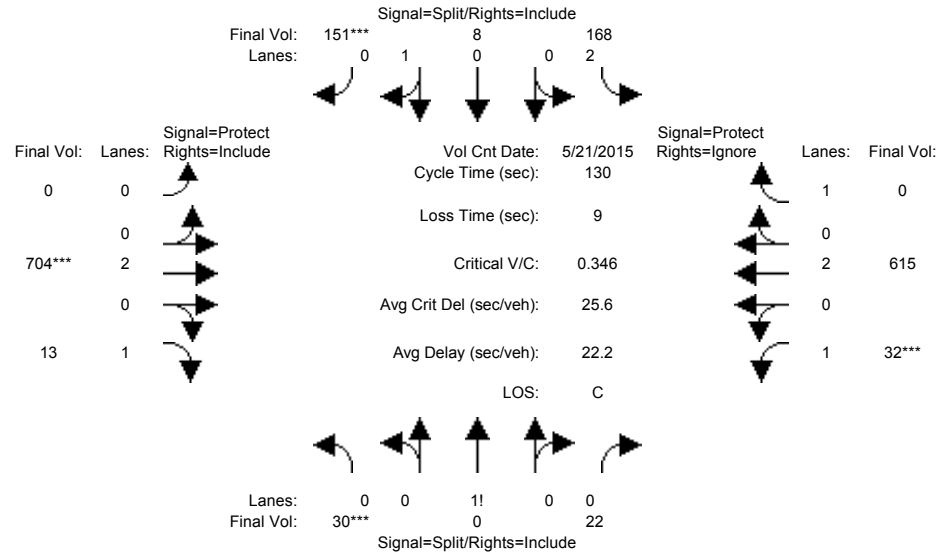

| Approach:  | North Bound |      |      | South Bound |      |      | East Bound |      |      | West Bound |      |      |
|--|-------------|------|------|-------------|------|------|------------|------|------|------------|------|------|
| Movement:  | L           | T    | R    | L           | T    | R    | L          | T    | R    | L          | T    | R    |
| Min. Green:  | 10          | 0    | 10   | 10          | 10   | 10   | 0          | 10   | 10   | 10         | 10   | 10   |
| Y+R:   | 4.0         | 4.0  | 4.0  | 4.0         | 4.0  | 4.0  | 4.0        | 4.0  | 4.0  | 4.0        | 4.0  | 4.0  |
| Volume Module: >> Count Date: 21 May 2015 << 7:30-8:30AM |             |      |      |             |      |      |            |      |      |            |      |      |
| Base Vol:  | 30          | 0    | 22   | 168         | 8    | 151  | 0          | 704  | 13   | 32         | 615  | 0    |
| Growth Adj:  | 1.00        | 1.00 | 1.00 | 1.00        | 1.00 | 1.00 | 1.00       | 1.00 | 1.00 | 1.00       | 1.00 | 1.00 |
| Initial Bse:   | 30          | 0    | 22   | 168         | 8    | 151  | 0          | 704  | 13   | 32         | 615  | 0    |
| Added Vol:   | 0           | 0    | 0    | 0           | 0    | 0    | 0          | 0    | 0    | 0          | 0    | 0    |
| PasserByVol:   | 0           | 0    | 0    | 0           | 0    | 0    | 0          | 0    | 0    | 0          | 0    | 0    |
| Initial Fut:   | 30          | 0    | 22   | 168         | 8    | 151  | 0          | 704  | 13   | 32         | 615  | 0    |
| User Adj:  | 1.00        | 1.00 | 1.00 | 1.00        | 1.00 | 1.00 | 1.00       | 1.00 | 1.00 | 1.00       | 1.00 | 0.00 |
| PHF Adj:   | 1.00        | 1.00 | 1.00 | 1.00        | 1.00 | 1.00 | 1.00       | 1.00 | 1.00 | 1.00       | 1.00 | 0.00 |
| PHF Volume:  | 30          | 0    | 22   | 168         | 8    | 151  | 0          | 704  | 13   | 32         | 615  | 0    |
| Reduct Vol:  | 0           | 0    | 0    | 0           | 0    | 0    | 0          | 0    | 0    | 0          | 0    | 0    |
| Reduced Vol:   | 30          | 0    | 22   | 168         | 8    | 151  | 0          | 704  | 13   | 32         | 615  | 0    |
| PCE Adj:   | 1.00        | 1.00 | 1.00 | 1.00        | 1.00 | 1.00 | 1.00       | 1.00 | 1.00 | 1.00       | 1.00 | 0.00 |
| MLF Adj:   | 1.00        | 1.00 | 1.00 | 1.00        | 1.00 | 1.00 | 1.00       | 1.00 | 1.00 | 1.00       | 1.00 | 0.00 |
| Final Volume:  | 30          | 0    | 22   | 168         | 8    | 151  | 0          | 704  | 13   | 32         | 615  | 0    |
| Saturation Flow Module:                                  |             |      |      |             |      |      |            |      |      |            |      |      |
| Sat/Lane:  | 1900        | 1900 | 1900 | 1900        | 1900 | 1900 | 1900       | 1900 | 1900 | 1900       | 1900 | 1900 |
| Adjustment:  | 0.92        | 0.92 | 0.92 | 0.83        | 0.95 | 0.95 | 0.92       | 1.00 | 0.92 | 0.92       | 1.00 | 0.92 |
| Lanes:   | 0.58        | 0.00 | 0.42 | 2.00        | 0.05 | 0.95 | 0.00       | 2.00 | 1.00 | 1.00       | 2.00 | 1.00 |
| Final Sat.:  | 1010        | 0    | 740  | 3150        | 91   | 1709 | 0          | 3800 | 1750 | 1750       | 3800 | 1750 |
| Capacity Analysis Module:                                |             |      |      |             |      |      |            |      |      |            |      |      |
| Vol/Sat:   | 0.03        | 0.00 | 0.03 | 0.05        | 0.09 | 0.09 | 0.00       | 0.19 | 0.01 | 0.02       | 0.16 | 0.00 |
| Crit Moves:  | ****        |      |      | ****        |      |      | ****       |      |      | ****       |      |      |
| Green Time:  | 10.9        | 0.0  | 10.9 | 32.3        | 32.3 | 32.3 | 0.0        | 67.8 | 67.8 | 10.0       | 77.8 | 0.0  |
| Volume/Cap:  | 0.36        | 0.00 | 0.36 | 0.21        | 0.36 | 0.36 | 0.00       | 0.36 | 0.01 | 0.24       | 0.27 | 0.00 |
| Delay/Veh:   | 57.7        | 0.0  | 57.7 | 38.9        | 40.7 | 40.7 | 0.0        | 18.4 | 15.0 | 57.3       | 12.6 | 0.0  |
| User DelAdj:   | 1.00        | 1.00 | 1.00 | 1.00        | 1.00 | 1.00 | 1.00       | 1.00 | 1.00 | 1.00       | 1.00 | 1.00 |
| AdjDel/Veh:  | 57.7        | 0.0  | 57.7 | 38.9        | 40.7 | 40.7 | 0.0        | 18.4 | 15.0 | 57.3       | 12.6 | 0.0  |
| LOS by Move:   | E           | A    | E    | D           | D    | D    | A          | B    | B    | E          | B    | A    |
| HCM2k95thQ:  | 5           | 0    | 5    | 6           | 11   | 11   | 0          | 15   | 1    | 3          | 11   | 0    |

Note: Queue reported is the number of cars per lane.

BART

Level Of Service Computation Report  
 2000 HCM Operations (Future Volume Alternative)  
 PM - Existing Conditions

Intersection #3043: 680S/ALUM ROCK (W) [Study Int 19]

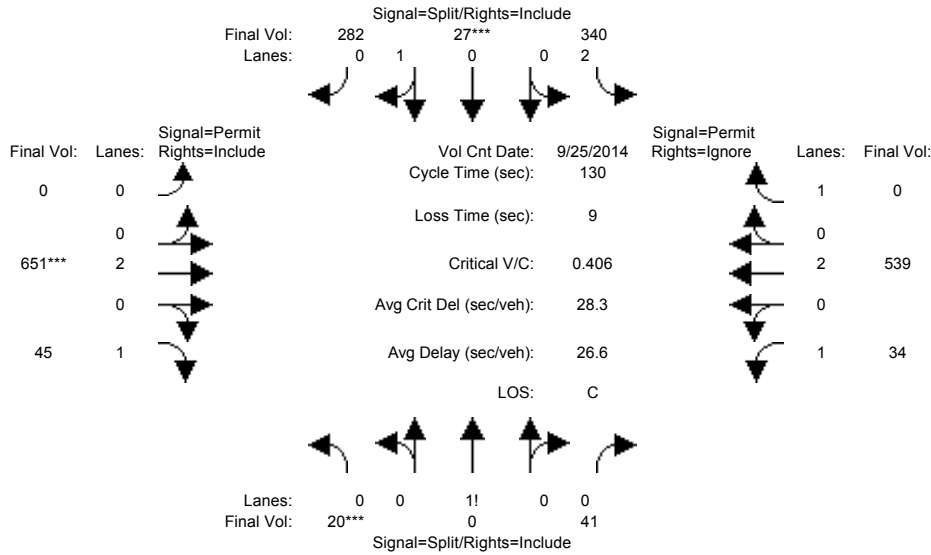

| Approach:  | North Bound |      |      | South Bound |      |      | East Bound |      |      | West Bound |      |      |
|--|-------------|------|------|-------------|------|------|------------|------|------|------------|------|------|
| Movement:  | L           | T    | R    | L           | T    | R    | L          | T    | R    | L          | T    | R    |
| Min. Green:  | 10          | 0    | 10   | 10          | 10   | 10   | 0          | 10   | 10   | 10         | 10   | 10   |
| Y+R:   | 4.0         | 4.0  | 4.0  | 4.0         | 4.0  | 4.0  | 4.0        | 4.0  | 4.0  | 4.0        | 4.0  | 4.0  |
| Volume Module: >> Count Date: 25 Sep 2014 << 4:15-5:15PM |             |      |      |             |      |      |            |      |      |            |      |      |
| Base Vol:  | 20          | 0    | 41   | 340         | 27   | 282  | 0          | 651  | 45   | 34         | 539  | 592  |
| Growth Adj:  | 1.00        | 1.00 | 1.00 | 1.00        | 1.00 | 1.00 | 1.00       | 1.00 | 1.00 | 1.00       | 1.00 | 1.00 |
| Initial Bse:   | 20          | 0    | 41   | 340         | 27   | 282  | 0          | 651  | 45   | 34         | 539  | 592  |
| Added Vol:   | 0           | 0    | 0    | 0           | 0    | 0    | 0          | 0    | 0    | 0          | 0    | 0    |
| PasserByVol:   | 0           | 0    | 0    | 0           | 0    | 0    | 0          | 0    | 0    | 0          | 0    | 0    |
| Initial Fut:   | 20          | 0    | 41   | 340         | 27   | 282  | 0          | 651  | 45   | 34         | 539  | 592  |
| User Adj:  | 1.00        | 1.00 | 1.00 | 1.00        | 1.00 | 1.00 | 1.00       | 1.00 | 1.00 | 1.00       | 1.00 | 0.00 |
| PHF Adj:   | 1.00        | 1.00 | 1.00 | 1.00        | 1.00 | 1.00 | 1.00       | 1.00 | 1.00 | 1.00       | 1.00 | 0.00 |
| PHF Volume:  | 20          | 0    | 41   | 340         | 27   | 282  | 0          | 651  | 45   | 34         | 539  | 0    |
| Reduct Vol:  | 0           | 0    | 0    | 0           | 0    | 0    | 0          | 0    | 0    | 0          | 0    | 0    |
| Reduced Vol:   | 20          | 0    | 41   | 340         | 27   | 282  | 0          | 651  | 45   | 34         | 539  | 0    |
| PCE Adj:   | 1.00        | 1.00 | 1.00 | 1.00        | 1.00 | 1.00 | 1.00       | 1.00 | 1.00 | 1.00       | 1.00 | 0.00 |
| MLF Adj:   | 1.00        | 1.00 | 1.00 | 1.00        | 1.00 | 1.00 | 1.00       | 1.00 | 1.00 | 1.00       | 1.00 | 0.00 |
| Final Volume:  | 20          | 0    | 41   | 340         | 27   | 282  | 0          | 651  | 45   | 34         | 539  | 0    |
| Saturation Flow Module:                                  |             |      |      |             |      |      |            |      |      |            |      |      |
| Sat/Lane:  | 1900        | 1900 | 1900 | 1900        | 1900 | 1900 | 1900       | 1900 | 1900 | 1900       | 1900 | 1900 |
| Adjustment:  | 0.92        | 0.92 | 0.92 | 0.83        | 0.95 | 0.95 | 0.92       | 1.00 | 0.92 | 0.92       | 1.00 | 0.92 |
| Lanes:   | 0.33        | 0.00 | 0.67 | 2.00        | 0.09 | 0.91 | 0.00       | 2.00 | 1.00 | 1.00       | 2.00 | 1.00 |
| Final Sat.:  | 574         | 0    | 1176 | 3150        | 157  | 1643 | 0          | 3800 | 1750 | 1750       | 3800 | 1750 |
| Capacity Analysis Module:                                |             |      |      |             |      |      |            |      |      |            |      |      |
| Vol/Sat:   | 0.03        | 0.00 | 0.03 | 0.11        | 0.17 | 0.17 | 0.00       | 0.17 | 0.03 | 0.02       | 0.14 | 0.00 |
| Crit Moves:  | ****        |      |      | ****        |      |      | ****       |      |      |            |      |      |
| Green Time:  | 11.2        | 0.0  | 11.2 | 55.0        | 55.0 | 55.0 | 0.0        | 54.9 | 54.9 | 54.9       | 54.9 | 0.0  |
| Volume/Cap:  | 0.41        | 0.00 | 0.41 | 0.26        | 0.41 | 0.41 | 0.00       | 0.41 | 0.06 | 0.05       | 0.34 | 0.00 |
| Delay/Veh:   | 58.1        | 0.0  | 58.1 | 24.4        | 26.5 | 26.5 | 0.0        | 26.4 | 22.3 | 22.2       | 25.4 | 0.0  |
| User DelAdj:   | 1.00        | 1.00 | 1.00 | 1.00        | 1.00 | 1.00 | 1.00       | 1.00 | 1.00 | 1.00       | 1.00 | 1.00 |
| AdjDel/Veh:  | 58.1        | 0.0  | 58.1 | 24.4        | 26.5 | 26.5 | 0.0        | 26.4 | 22.3 | 22.2       | 25.4 | 0.0  |
| LOS by Move:   | E           | A    | E    | C           | C    | C    | A          | C    | C    | C          | C    | A    |
| HCM2k95thQ:  | 6           | 0    | 6    | 10          | 17   | 17   | 0          | 16   | 2    | 2          | 13   | 0    |

Note: Queue reported is the number of cars per lane.

BART

Level Of Service Computation Report  
 2000 HCM Operations (Future Volume Alternative)  
 AM - Existing Conditions

Intersection #3046: The Alameda/880 SB Ramps [Study Int 56]

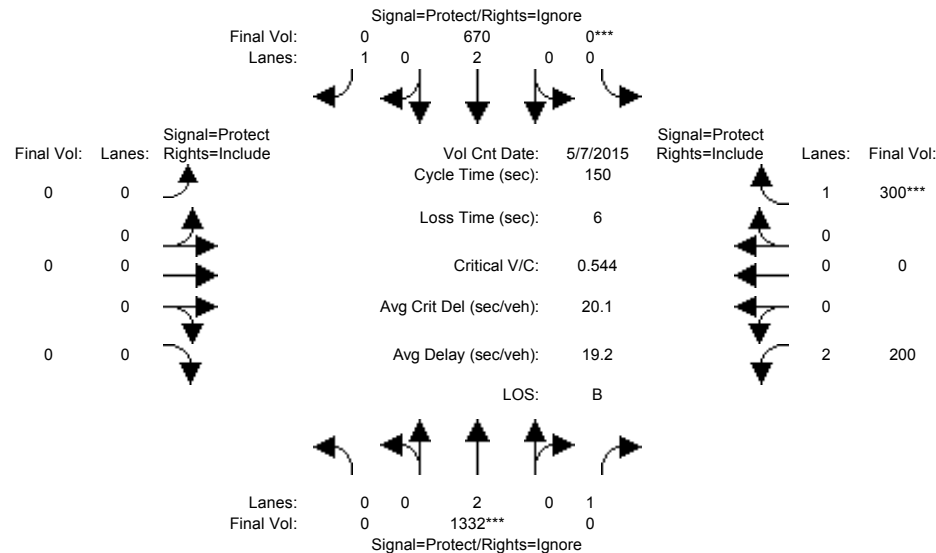

| Approach:   | North Bound |      |      | South Bound |      |      | East Bound |      |      | West Bound |      |      |
|---|-------------|------|------|-------------|------|------|------------|------|------|------------|------|------|
| Movement:   | L           | T    | R    | L           | T    | R    | L          | T    | R    | L          | T    | R    |
| Min. Green:   | 0           | 10   | 10   | 0           | 10   | 10   | 0          | 0    | 0    | 10         | 0    | 10   |
| Y+R:  | 4.0         | 4.0  | 4.0  | 4.0         | 4.0  | 4.0  | 4.0        | 4.0  | 4.0  | 4.0        | 4.0  | 4.0  |
| Volume Module: >> Count Date: 7 May 2015 << 7:35-8:35AM |             |      |      |             |      |      |            |      |      |            |      |      |
| Base Vol:   | 0           | 1332 | 308  | 0           | 670  | 176  | 0          | 0    | 0    | 200        | 0    | 300  |
| Growth Adj:   | 1.00        | 1.00 | 1.00 | 1.00        | 1.00 | 1.00 | 1.00       | 1.00 | 1.00 | 1.00       | 1.00 | 1.00 |
| Initial Bse:  | 0           | 1332 | 308  | 0           | 670  | 176  | 0          | 0    | 0    | 200        | 0    | 300  |
| Added Vol:  | 0           | 0    | 0    | 0           | 0    | 0    | 0          | 0    | 0    | 0          | 0    | 0    |
| PasserByVol:  | 0           | 0    | 0    | 0           | 0    | 0    | 0          | 0    | 0    | 0          | 0    | 0    |
| Initial Fut:  | 0           | 1332 | 308  | 0           | 670  | 176  | 0          | 0    | 0    | 200        | 0    | 300  |
| User Adj:   | 1.00        | 1.00 | 0.00 | 1.00        | 1.00 | 0.00 | 1.00       | 1.00 | 1.00 | 1.00       | 1.00 | 1.00 |
| PHF Adj:  | 1.00        | 1.00 | 0.00 | 1.00        | 1.00 | 0.00 | 1.00       | 1.00 | 1.00 | 1.00       | 1.00 | 1.00 |
| PHF Volume:   | 0           | 1332 | 0    | 0           | 670  | 0    | 0          | 0    | 0    | 200        | 0    | 300  |
| Reduct Vol:   | 0           | 0    | 0    | 0           | 0    | 0    | 0          | 0    | 0    | 0          | 0    | 0    |
| Reduced Vol:  | 0           | 1332 | 0    | 0           | 670  | 0    | 0          | 0    | 0    | 200        | 0    | 300  |
| PCE Adj:  | 1.00        | 1.00 | 0.00 | 1.00        | 1.00 | 0.00 | 1.00       | 1.00 | 1.00 | 1.00       | 1.00 | 1.00 |
| MLF Adj:  | 1.00        | 1.00 | 0.00 | 1.00        | 1.00 | 0.00 | 1.00       | 1.00 | 1.00 | 1.00       | 1.00 | 1.00 |
| Final Volume:   | 0           | 1332 | 0    | 0           | 670  | 0    | 0          | 0    | 0    | 200        | 0    | 300  |
| Saturation Flow Module:                                 |             |      |      |             |      |      |            |      |      |            |      |      |
| Sat/Lane:   | 1900        | 1900 | 1900 | 1900        | 1900 | 1900 | 1900       | 1900 | 1900 | 1900       | 1900 | 1900 |
| Adjustment:   | 0.92        | 1.00 | 0.92 | 0.92        | 1.00 | 0.92 | 0.92       | 1.00 | 0.92 | 0.83       | 1.00 | 0.92 |
| Lanes:  | 0.00        | 2.00 | 1.00 | 0.00        | 2.00 | 1.00 | 0.00       | 0.00 | 0.00 | 2.00       | 0.00 | 1.00 |
| Final Sat.:   | 0           | 3800 | 1750 | 0           | 3800 | 1750 | 0          | 0    | 0    | 3150       | 0    | 1750 |
| Capacity Analysis Module:                               |             |      |      |             |      |      |            |      |      |            |      |      |
| Vol/Sat:  | 0.00        | 0.35 | 0.00 | 0.00        | 0.18 | 0.00 | 0.00       | 0.00 | 0.00 | 0.06       | 0.00 | 0.17 |
| Crit Moves:   | ****        | **** | **** | ****        | **** | **** | ****       | **** | **** | ****       | **** | **** |
| Green Time:   | 0.0         | 96.7 | 0.0  | 0.0         | 96.7 | 0.0  | 0.0        | 0.0  | 0.0  | 47.3       | 0.0  | 47.3 |
| Volume/Cap:   | 0.00        | 0.54 | 0.00 | 0.00        | 0.27 | 0.00 | 0.00       | 0.00 | 0.00 | 0.20       | 0.00 | 0.54 |
| Delay/Veh:  | 0.0         | 14.8 | 0.0  | 0.0         | 11.6 | 0.0  | 0.0        | 0.0  | 0.0  | 37.6       | 0.0  | 43.6 |
| User DelAdj:  | 1.00        | 1.00 | 1.00 | 1.00        | 1.00 | 1.00 | 1.00       | 1.00 | 1.00 | 1.00       | 1.00 | 1.00 |
| AdjDel/Veh:   | 0.0         | 14.8 | 0.0  | 0.0         | 11.6 | 0.0  | 0.0        | 0.0  | 0.0  | 37.6       | 0.0  | 43.6 |
| LOS by Move:  | A           | B    | A    | A           | B    | A    | A          | A    | A    | D          | A    | D    |
| HCM2k95thQ:   | 0           | 28   | 0    | 0           | 12   | 0    | 0          | 0    | 0    | 8          | 0    | 22   |

Note: Queue reported is the number of cars per lane.

BART

Level Of Service Computation Report  
 2000 HCM Operations (Future Volume Alternative)  
 PM - Existing Conditions

Intersection #3046: The Alameda/880 SB Ramps [Study Int 56]

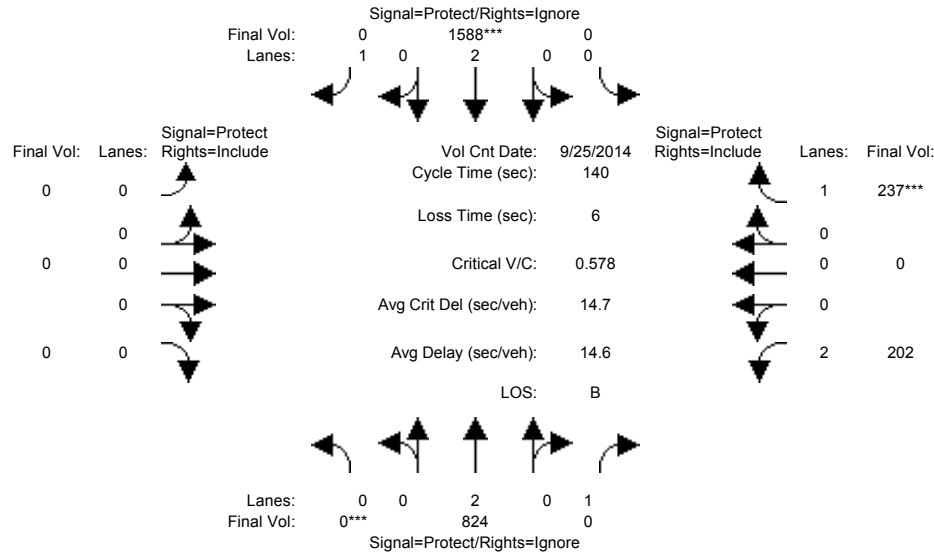

| Approach:  | North Bound |      |      | South Bound |      |      | East Bound |      |      | West Bound |      |      |
|--|-------------|------|------|-------------|------|------|------------|------|------|------------|------|------|
| Movement:  | L           | T    | R    | L           | T    | R    | L          | T    | R    | L          | T    | R    |
| Min. Green:  | 0           | 10   | 10   | 0           | 10   | 10   | 0          | 0    | 0    | 10         | 0    | 10   |
| Y+R:   | 4.0         | 4.0  | 4.0  | 4.0         | 4.0  | 4.0  | 4.0        | 4.0  | 4.0  | 4.0        | 4.0  | 4.0  |
| Volume Module: >> Count Date: 25 Sep 2014 << 4:45-5:00PM |             |      |      |             |      |      |            |      |      |            |      |      |
| Base Vol:  | 0           | 824  | 389  | 0           | 1588 | 322  | 0          | 0    | 0    | 202        | 0    | 237  |
| Growth Adj:  | 1.00        | 1.00 | 1.00 | 1.00        | 1.00 | 1.00 | 1.00       | 1.00 | 1.00 | 1.00       | 1.00 | 1.00 |
| Initial Bse:   | 0           | 824  | 389  | 0           | 1588 | 322  | 0          | 0    | 0    | 202        | 0    | 237  |
| Added Vol:   | 0           | 0    | 0    | 0           | 0    | 0    | 0          | 0    | 0    | 0          | 0    | 0    |
| PasserByVol:   | 0           | 0    | 0    | 0           | 0    | 0    | 0          | 0    | 0    | 0          | 0    | 0    |
| Initial Fut:   | 0           | 824  | 389  | 0           | 1588 | 322  | 0          | 0    | 0    | 202        | 0    | 237  |
| User Adj:  | 1.00        | 1.00 | 0.00 | 1.00        | 1.00 | 0.00 | 1.00       | 1.00 | 1.00 | 1.00       | 1.00 | 1.00 |
| PHF Adj:   | 1.00        | 1.00 | 0.00 | 1.00        | 1.00 | 0.00 | 1.00       | 1.00 | 1.00 | 1.00       | 1.00 | 1.00 |
| PHF Volume:  | 0           | 824  | 0    | 0           | 1588 | 0    | 0          | 0    | 0    | 202        | 0    | 237  |
| Reduct Vol:  | 0           | 0    | 0    | 0           | 0    | 0    | 0          | 0    | 0    | 0          | 0    | 0    |
| Reduced Vol:   | 0           | 824  | 0    | 0           | 1588 | 0    | 0          | 0    | 0    | 202        | 0    | 237  |
| PCE Adj:   | 1.00        | 1.00 | 0.00 | 1.00        | 1.00 | 0.00 | 1.00       | 1.00 | 1.00 | 1.00       | 1.00 | 1.00 |
| MLF Adj:   | 1.00        | 1.00 | 0.00 | 1.00        | 1.00 | 0.00 | 1.00       | 1.00 | 1.00 | 1.00       | 1.00 | 1.00 |
| Final Volume:  | 0           | 824  | 0    | 0           | 1588 | 0    | 0          | 0    | 0    | 202        | 0    | 237  |
| Saturation Flow Module:                                  |             |      |      |             |      |      |            |      |      |            |      |      |
| Sat/Lane:  | 1900        | 1900 | 1900 | 1900        | 1900 | 1900 | 1900       | 1900 | 1900 | 1900       | 1900 | 1900 |
| Adjustment:  | 0.92        | 1.00 | 0.92 | 0.92        | 1.00 | 0.92 | 0.92       | 1.00 | 0.92 | 0.83       | 1.00 | 0.92 |
| Lanes:   | 0.00        | 2.00 | 1.00 | 0.00        | 2.00 | 1.00 | 0.00       | 0.00 | 0.00 | 2.00       | 0.00 | 1.00 |
| Final Sat.:  | 0           | 3800 | 1750 | 0           | 3800 | 1750 | 0          | 0    | 0    | 3150       | 0    | 1750 |
| Capacity Analysis Module:                                |             |      |      |             |      |      |            |      |      |            |      |      |
| Vol/Sat:   | 0.00        | 0.22 | 0.00 | 0.00        | 0.42 | 0.00 | 0.00       | 0.00 | 0.00 | 0.06       | 0.00 | 0.14 |
| Crit Moves:  | ****        |      |      | ****        |      |      |            |      |      |            |      | **** |
| Green Time:  | 0.0         | 101  | 0.0  | 0.0         | 101  | 0.0  | 0.0        | 0.0  | 0.0  | 32.8       | 0.0  | 32.8 |
| Volume/Cap:  | 0.00        | 0.30 | 0.00 | 0.00        | 0.58 | 0.00 | 0.00       | 0.00 | 0.00 | 0.27       | 0.00 | 0.58 |
| Delay/Veh:   | 0.0         | 6.9  | 0.0  | 0.0         | 9.5  | 0.0  | 0.0        | 0.0  | 0.0  | 44.1       | 0.0  | 49.5 |
| User DelAdj:   | 1.00        | 1.00 | 1.00 | 1.00        | 1.00 | 1.00 | 1.00       | 1.00 | 1.00 | 1.00       | 1.00 | 1.00 |
| AdjDel/Veh:  | 0.0         | 6.9  | 0.0  | 0.0         | 9.5  | 0.0  | 0.0        | 0.0  | 0.0  | 44.1       | 0.0  | 49.5 |
| LOS by Move:   | A           | A    | A    | A           | A    | A    | A          | A    | A    | D          | A    | D    |
| HCM2k95thQ:  | 0           | 12   | 0    | 0           | 28   | 0    | 0          | 0    | 0    | 8          | 0    | 19   |

Note: Queue reported is the number of cars per lane.

BART

Level Of Service Computation Report  
 2000 HCM Operations (Future Volume Alternative)  
 AM - Existing Conditions

Intersection #3047: The Alameda/880 NB Ramps [Study Int 57]

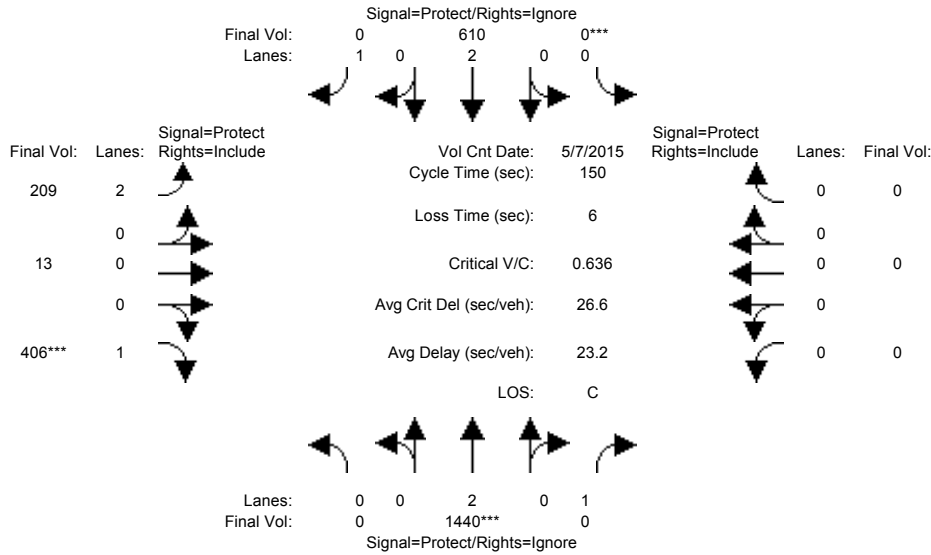

| Approach:   | North Bound |      |      | South Bound |      |      | East Bound |      |      | West Bound |      |      |
|---|-------------|------|------|-------------|------|------|------------|------|------|------------|------|------|
| Movement:   | L           | T    | R    | L           | T    | R    | L          | T    | R    | L          | T    | R    |
| Min. Green:   | 0           | 10   | 10   | 0           | 10   | 10   | 10         | 0    | 10   | 0          | 0    | 0    |
| Y+R:  | 4.0         | 4.0  | 4.0  | 4.0         | 4.0  | 4.0  | 4.0        | 4.0  | 4.0  | 4.0        | 4.0  | 4.0  |
| Volume Module: >> Count Date: 7 May 2015 << 7:50-8:50AM |             |      |      |             |      |      |            |      |      |            |      |      |
| Base Vol:   | 0           | 1440 | 469  | 0           | 610  | 250  | 209        | 13   | 406  | 0          | 0    | 0    |
| Growth Adj:   | 1.00        | 1.00 | 1.00 | 1.00        | 1.00 | 1.00 | 1.00       | 1.00 | 1.00 | 1.00       | 1.00 | 1.00 |
| Initial Bse:  | 0           | 1440 | 469  | 0           | 610  | 250  | 209        | 13   | 406  | 0          | 0    | 0    |
| Added Vol:  | 0           | 0    | 0    | 0           | 0    | 0    | 0          | 0    | 0    | 0          | 0    | 0    |
| PasserByVol:  | 0           | 0    | 0    | 0           | 0    | 0    | 0          | 0    | 0    | 0          | 0    | 0    |
| Initial Fut:  | 0           | 1440 | 469  | 0           | 610  | 250  | 209        | 13   | 406  | 0          | 0    | 0    |
| User Adj:   | 1.00        | 1.00 | 0.00 | 1.00        | 1.00 | 0.00 | 1.00       | 1.00 | 1.00 | 1.00       | 1.00 | 1.00 |
| PHF Adj:  | 1.00        | 1.00 | 0.00 | 1.00        | 1.00 | 0.00 | 1.00       | 1.00 | 1.00 | 1.00       | 1.00 | 1.00 |
| PHF Volume:   | 0           | 1440 | 0    | 0           | 610  | 0    | 209        | 13   | 406  | 0          | 0    | 0    |
| Reduct Vol:   | 0           | 0    | 0    | 0           | 0    | 0    | 0          | 0    | 0    | 0          | 0    | 0    |
| Reduced Vol:  | 0           | 1440 | 0    | 0           | 610  | 0    | 209        | 13   | 406  | 0          | 0    | 0    |
| PCE Adj:  | 1.00        | 1.00 | 0.00 | 1.00        | 1.00 | 0.00 | 1.00       | 1.00 | 1.00 | 1.00       | 1.00 | 1.00 |
| MLF Adj:  | 1.00        | 1.00 | 0.00 | 1.00        | 1.00 | 0.00 | 1.00       | 1.00 | 1.00 | 1.00       | 1.00 | 1.00 |
| FinalVolume:  | 0           | 1440 | 0    | 0           | 610  | 0    | 209        | 13   | 406  | 0          | 0    | 0    |
| Saturation Flow Module:                                 |             |      |      |             |      |      |            |      |      |            |      |      |
| Sat/Lane:   | 1900        | 1900 | 1900 | 1900        | 1900 | 1900 | 1900       | 1900 | 1900 | 1900       | 1900 | 1900 |
| Adjustment:   | 0.92        | 1.00 | 0.92 | 0.92        | 1.00 | 0.92 | 0.92       | 1.00 | 0.92 | 0.92       | 1.00 | 0.92 |
| Lanes:  | 0.00        | 2.00 | 1.00 | 0.00        | 2.00 | 1.00 | 1.89       | 0.11 | 1.00 | 0.00       | 0.00 | 0.00 |
| Final Sat.:   | 0           | 3800 | 1750 | 0           | 3800 | 1750 | 3310       | 206  | 1750 | 0          | 0    | 0    |
| Capacity Analysis Module:                               |             |      |      |             |      |      |            |      |      |            |      |      |
| Vol/Sat:  | 0.00        | 0.38 | 0.00 | 0.00        | 0.16 | 0.00 | 0.06       | 0.06 | 0.23 | 0.00       | 0.00 | 0.00 |
| Crit Moves:   | ****        | **** | **** | ****        | **** | **** | ****       | **** | **** | ****       | **** | **** |
| Green Time:   | 0.0         | 89.3 | 0.0  | 0.0         | 89.3 | 0.0  | 54.7       | 54.7 | 54.7 | 0.0        | 0.0  | 0.0  |
| Volume/Cap:   | 0.00        | 0.64 | 0.00 | 0.00        | 0.27 | 0.00 | 0.17       | 0.17 | 0.64 | 0.00       | 0.00 | 0.00 |
| Delay/Veh:  | 0.0         | 20.4 | 0.0  | 0.0         | 14.7 | 0.0  | 32.3       | 32.3 | 40.8 | 0.0        | 0.0  | 0.0  |
| User DelAdj:  | 1.00        | 1.00 | 1.00 | 1.00        | 1.00 | 1.00 | 1.00       | 1.00 | 1.00 | 1.00       | 1.00 | 1.00 |
| AdjDel/Veh:   | 0.0         | 20.4 | 0.0  | 0.0         | 14.7 | 0.0  | 32.3       | 32.3 | 40.8 | 0.0        | 0.0  | 0.0  |
| LOS by Move:  | A           | C    | A    | A           | B    | A    | C          | C    | D    | A          | A    | A    |
| HCM2k95thQ:   | 0           | 35   | 0    | 0           | 12   | 0    | 7          | 7    | 29   | 0          | 0    | 0    |

Note: Queue reported is the number of cars per lane.

BART

Level Of Service Computation Report  
 2000 HCM Operations (Future Volume Alternative)  
 PM - Existing Conditions

Intersection #3047: The Alameda/880 NB Ramps [Study Int 57]

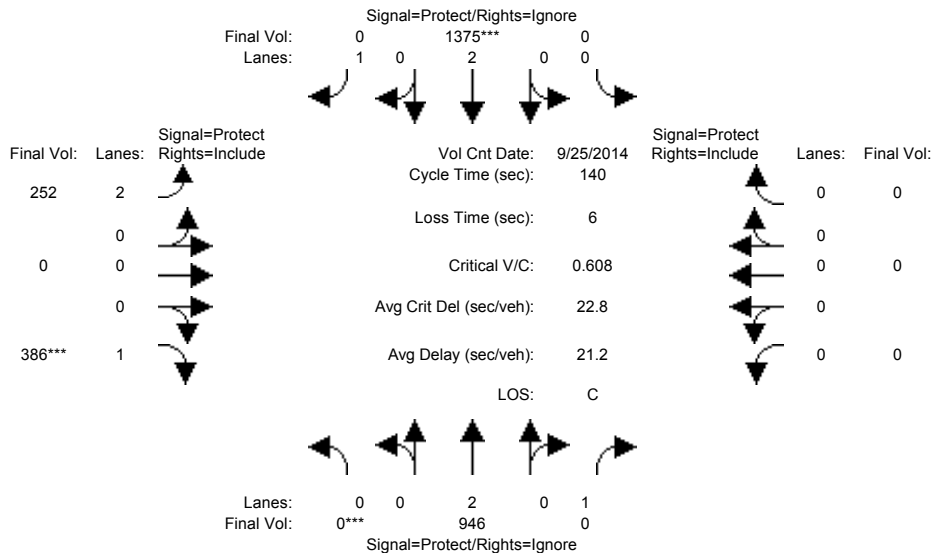

| Approach:  | North Bound |      |      | South Bound |      |      | East Bound |      |      | West Bound |      |      |
|--|-------------|------|------|-------------|------|------|------------|------|------|------------|------|------|
| Movement:  | L           | T    | R    | L           | T    | R    | L          | T    | R    | L          | T    | R    |
| Min. Green:  | 0           | 10   | 10   | 0           | 10   | 10   | 10         | 0    | 10   | 0          | 0    | 0    |
| Y+R:   | 4.0         | 4.0  | 4.0  | 4.0         | 4.0  | 4.0  | 4.0        | 4.0  | 4.0  | 4.0        | 4.0  | 4.0  |
| Volume Module: >> Count Date: 25 Sep 2014 << 4:45-5:45PM |             |      |      |             |      |      |            |      |      |            |      |      |
| Base Vol:  | 0           | 946  | 224  | 0           | 1375 | 424  | 252        | 0    | 386  | 0          | 0    | 0    |
| Growth Adj:  | 1.00        | 1.00 | 1.00 | 1.00        | 1.00 | 1.00 | 1.00       | 1.00 | 1.00 | 1.00       | 1.00 | 1.00 |
| Initial Bse:   | 0           | 946  | 224  | 0           | 1375 | 424  | 252        | 0    | 386  | 0          | 0    | 0    |
| Added Vol:   | 0           | 0    | 0    | 0           | 0    | 0    | 0          | 0    | 0    | 0          | 0    | 0    |
| PasserByVol:   | 0           | 0    | 0    | 0           | 0    | 0    | 0          | 0    | 0    | 0          | 0    | 0    |
| Initial Fut:   | 0           | 946  | 224  | 0           | 1375 | 424  | 252        | 0    | 386  | 0          | 0    | 0    |
| User Adj:  | 1.00        | 1.00 | 0.00 | 1.00        | 1.00 | 0.00 | 1.00       | 1.00 | 1.00 | 1.00       | 1.00 | 1.00 |
| PHF Adj:   | 1.00        | 1.00 | 0.00 | 1.00        | 1.00 | 0.00 | 1.00       | 1.00 | 1.00 | 1.00       | 1.00 | 1.00 |
| PHF Volume:  | 0           | 946  | 0    | 0           | 1375 | 0    | 252        | 0    | 386  | 0          | 0    | 0    |
| Reduct Vol:  | 0           | 0    | 0    | 0           | 0    | 0    | 0          | 0    | 0    | 0          | 0    | 0    |
| Reduced Vol:   | 0           | 946  | 0    | 0           | 1375 | 0    | 252        | 0    | 386  | 0          | 0    | 0    |
| PCE Adj:   | 1.00        | 1.00 | 0.00 | 1.00        | 1.00 | 0.00 | 1.00       | 1.00 | 1.00 | 1.00       | 1.00 | 1.00 |
| MLF Adj:   | 1.00        | 1.00 | 0.00 | 1.00        | 1.00 | 0.00 | 1.00       | 1.00 | 1.00 | 1.00       | 1.00 | 1.00 |
| Final Volume:  | 0           | 946  | 0    | 0           | 1375 | 0    | 252        | 0    | 386  | 0          | 0    | 0    |
| Saturation Flow Module:                                  |             |      |      |             |      |      |            |      |      |            |      |      |
| Sat/Lane:  | 1900        | 1900 | 1900 | 1900        | 1900 | 1900 | 1900       | 1900 | 1900 | 1900       | 1900 | 1900 |
| Adjustment:  | 0.92        | 1.00 | 0.92 | 0.92        | 1.00 | 0.92 | 0.83       | 1.00 | 0.92 | 0.92       | 1.00 | 0.92 |
| Lanes:   | 0.00        | 2.00 | 1.00 | 0.00        | 2.00 | 1.00 | 2.00       | 0.00 | 1.00 | 0.00       | 0.00 | 0.00 |
| Final Sat.:  | 0           | 3800 | 1750 | 0           | 3800 | 1750 | 3150       | 0    | 1750 | 0          | 0    | 0    |
| Capacity Analysis Module:                                |             |      |      |             |      |      |            |      |      |            |      |      |
| Vol/Sat:   | 0.00        | 0.25 | 0.00 | 0.00        | 0.36 | 0.00 | 0.08       | 0.00 | 0.22 | 0.00       | 0.00 | 0.00 |
| Crit Moves:  | ****        |      |      | ****        |      |      | ****       |      |      | ****       |      |      |
| Green Time:  | 0.0         | 83.3 | 0.0  | 0.0         | 83.3 | 0.0  | 50.7       | 0.0  | 50.7 | 0.0        | 0.0  | 0.0  |
| Volume/Cap:  | 0.00        | 0.42 | 0.00 | 0.00        | 0.61 | 0.00 | 0.22       | 0.00 | 0.61 | 0.00       | 0.00 | 0.00 |
| Delay/Veh:   | 0.0         | 15.4 | 0.0  | 0.0         | 18.5 | 0.0  | 31.0       | 0.0  | 38.2 | 0.0        | 0.0  | 0.0  |
| User DelAdj:   | 1.00        | 1.00 | 1.00 | 1.00        | 1.00 | 1.00 | 1.00       | 1.00 | 1.00 | 1.00       | 1.00 | 1.00 |
| AdjDel/Veh:  | 0.0         | 15.4 | 0.0  | 0.0         | 18.5 | 0.0  | 31.0       | 0.0  | 38.2 | 0.0        | 0.0  | 0.0  |
| LOS by Move:   | A           | B    | A    | A           | B    | A    | C          | A    | D    | A          | A    | A    |
| HCM2k95thQ:  | 0           | 19   | 0    | 0           | 32   | 0    | 9          | 0    | 26   | 0          | 0    | 0    |

Note: Queue reported is the number of cars per lane.

BART

Level Of Service Computation Report  
2000 HCM Operations (Future Volume Alternative)  
AM - Existing Conditions

Intersection #3052: 880 SB Ramps/Coleman [Study Int 36]

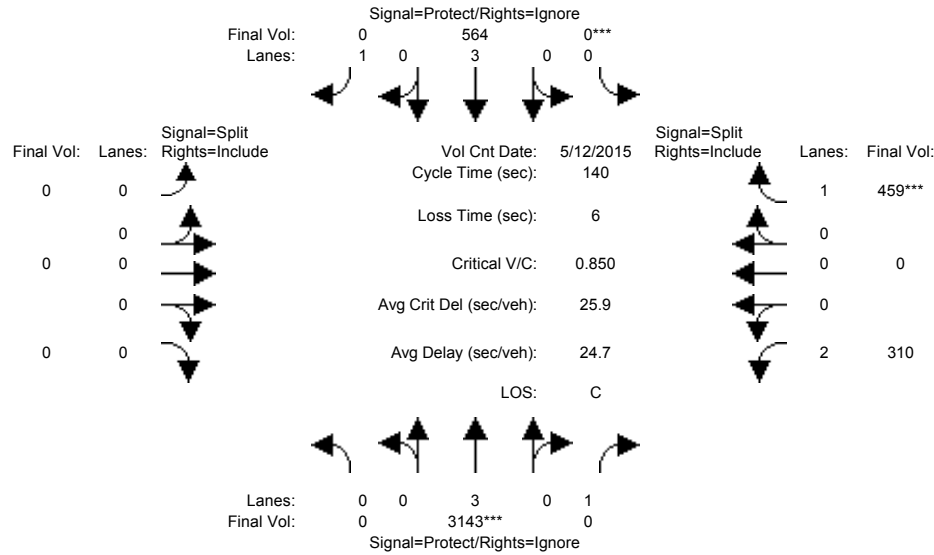

| Approach:  | North Bound |      |      | South Bound |      |      | East Bound |      |      | West Bound |      |      |
|--|-------------|------|------|-------------|------|------|------------|------|------|------------|------|------|
| Movement:  | L           | T    | R    | L           | T    | R    | L          | T    | R    | L          | T    | R    |
| Min. Green:  | 0           | 10   | 10   | 0           | 10   | 10   | 0          | 0    | 0    | 10         | 0    | 10   |
| Y+R:   | 4.0         | 4.0  | 4.0  | 4.0         | 4.0  | 4.0  | 4.0        | 4.0  | 4.0  | 4.0        | 4.0  | 4.0  |
| Volume Module: >> Count Date: 12 May 2015 << 7:45-8:45AM |             |      |      |             |      |      |            |      |      |            |      |      |
| Base Vol:  | 0           | 3143 | 178  | 0           | 564  | 183  | 0          | 0    | 0    | 310        | 0    | 459  |
| Growth Adj:  | 1.00        | 1.00 | 1.00 | 1.00        | 1.00 | 1.00 | 1.00       | 1.00 | 1.00 | 1.00       | 1.00 | 1.00 |
| Initial Bse:   | 0           | 3143 | 178  | 0           | 564  | 183  | 0          | 0    | 0    | 310        | 0    | 459  |
| Added Vol:   | 0           | 0    | 0    | 0           | 0    | 0    | 0          | 0    | 0    | 0          | 0    | 0    |
| PasserByVol:   | 0           | 0    | 0    | 0           | 0    | 0    | 0          | 0    | 0    | 0          | 0    | 0    |
| Initial Fut:   | 0           | 3143 | 178  | 0           | 564  | 183  | 0          | 0    | 0    | 310        | 0    | 459  |
| User Adj:  | 1.00        | 1.00 | 0.00 | 1.00        | 1.00 | 0.00 | 1.00       | 1.00 | 1.00 | 1.00       | 1.00 | 1.00 |
| PHF Adj:   | 1.00        | 1.00 | 0.00 | 1.00        | 1.00 | 0.00 | 1.00       | 1.00 | 1.00 | 1.00       | 1.00 | 1.00 |
| PHF Volume:  | 0           | 3143 | 0    | 0           | 564  | 0    | 0          | 0    | 0    | 310        | 0    | 459  |
| Reduct Vol:  | 0           | 0    | 0    | 0           | 0    | 0    | 0          | 0    | 0    | 0          | 0    | 0    |
| Reduced Vol:   | 0           | 3143 | 0    | 0           | 564  | 0    | 0          | 0    | 0    | 310        | 0    | 459  |
| PCE Adj:   | 1.00        | 1.00 | 0.00 | 1.00        | 1.00 | 0.00 | 1.00       | 1.00 | 1.00 | 1.00       | 1.00 | 1.00 |
| MLF Adj:   | 1.00        | 1.00 | 0.00 | 1.00        | 1.00 | 0.00 | 1.00       | 1.00 | 1.00 | 1.00       | 1.00 | 1.00 |
| Final Volume:  | 0           | 3143 | 0    | 0           | 564  | 0    | 0          | 0    | 0    | 310        | 0    | 459  |
| Saturation Flow Module:                                  |             |      |      |             |      |      |            |      |      |            |      |      |
| Sat/Lane:  | 1900        | 1900 | 1900 | 1900        | 1900 | 1900 | 1900       | 1900 | 1900 | 1900       | 1900 | 1900 |
| Adjustment:  | 0.92        | 1.00 | 0.92 | 0.92        | 1.00 | 0.92 | 0.92       | 1.00 | 0.92 | 0.83       | 1.00 | 0.92 |
| Lanes:   | 0.00        | 3.00 | 1.00 | 0.00        | 3.00 | 1.00 | 0.00       | 0.00 | 0.00 | 2.00       | 0.00 | 1.00 |
| Final Sat.:  | 0           | 5700 | 1750 | 0           | 5700 | 1750 | 0          | 0    | 0    | 3150       | 0    | 1750 |
| Capacity Analysis Module:                                |             |      |      |             |      |      |            |      |      |            |      |      |
| Vol/Sat:   | 0.00        | 0.55 | 0.00 | 0.00        | 0.10 | 0.00 | 0.00       | 0.00 | 0.00 | 0.10       | 0.00 | 0.26 |
| Crit Moves:  | ****        | **** | **** | ****        | **** | **** | ****       | **** | **** | ****       | **** | **** |
| Green Time:  | 0.0         | 90.8 | 0.0  | 0.0         | 90.8 | 0.0  | 0.0        | 0.0  | 0.0  | 43.2       | 0.0  | 43.2 |
| Volume/Cap:  | 0.00        | 0.85 | 0.00 | 0.00        | 0.15 | 0.00 | 0.00       | 0.00 | 0.00 | 0.32       | 0.00 | 0.85 |
| Delay/Veh:   | 0.0         | 21.3 | 0.0  | 0.0         | 9.6  | 0.0  | 0.0        | 0.0  | 0.0  | 37.3       | 0.0  | 57.5 |
| User DelAdj:   | 1.00        | 1.00 | 1.00 | 1.00        | 1.00 | 1.00 | 1.00       | 1.00 | 1.00 | 1.00       | 1.00 | 1.00 |
| AdjDel/Veh:  | 0.0         | 21.3 | 0.0  | 0.0         | 9.6  | 0.0  | 0.0        | 0.0  | 0.0  | 37.3       | 0.0  | 57.5 |
| LOS by Move:   | A           | C    | A    | A           | A    | A    | A          | A    | A    | D          | A    | E    |
| HCM2k95thQ:  | 0           | 58   | 0    | 0           | 6    | 0    | 0          | 0    | 0    | 12         | 0    | 37   |

Note: Queue reported is the number of cars per lane.



BART

Level Of Service Computation Report  
2000 HCM Operations (Future Volume Alternative)  
PM - Existing Conditions

Intersection #3052: 880 SB Ramps/Coleman [Study Int 36]

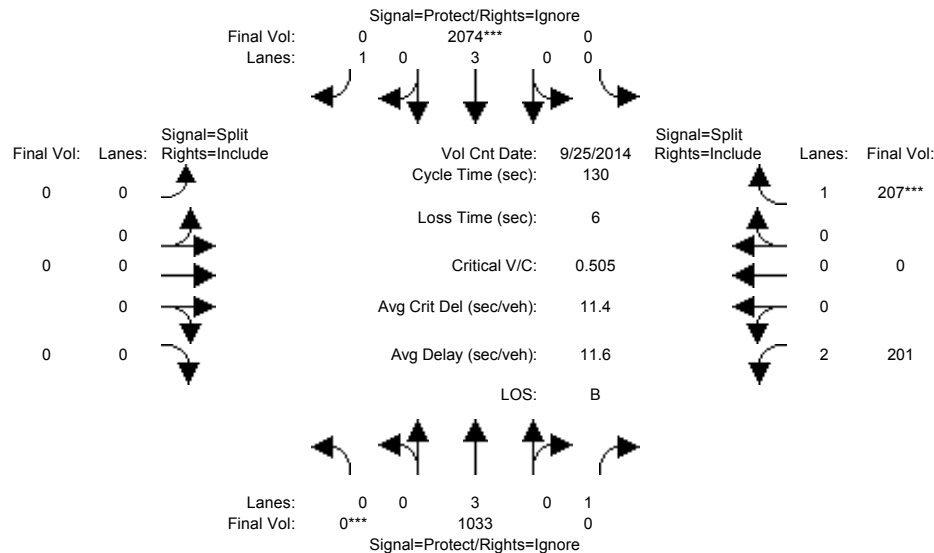

| Approach:   | North Bound |      |      | South Bound |      |      | East Bound |      |      | West Bound |      |      |
|---|-------------|------|------|-------------|------|------|------------|------|------|------------|------|------|
| Movement:   | L           | T    | R    | L           | T    | R    | L          | T    | R    | L          | T    | R    |
| Min. Green:   | 0           | 10   | 10   | 0           | 10   | 10   | 0          | 0    | 0    | 10         | 0    | 10   |
| Y+R:  | 4.0         | 4.0  | 4.0  | 4.0         | 4.0  | 4.0  | 4.0        | 4.0  | 4.0  | 4.0        | 4.0  | 4.0  |
| Volume Module: >> Count Date: 25 Sep 2014 << 4:30 PM to 5:30 PM |             |      |      |             |      |      |            |      |      |            |      |      |
| Base Vol:   | 0           | 1033 | 291  | 0           | 2074 | 709  | 0          | 0    | 0    | 201        | 0    | 207  |
| Growth Adj:   | 1.00        | 1.00 | 1.00 | 1.00        | 1.00 | 1.00 | 1.00       | 1.00 | 1.00 | 1.00       | 1.00 | 1.00 |
| Initial Bse:  | 0           | 1033 | 291  | 0           | 2074 | 709  | 0          | 0    | 0    | 201        | 0    | 207  |
| Added Vol:  | 0           | 0    | 0    | 0           | 0    | 0    | 0          | 0    | 0    | 0          | 0    | 0    |
| PasserByVol:  | 0           | 0    | 0    | 0           | 0    | 0    | 0          | 0    | 0    | 0          | 0    | 0    |
| Initial Fut:  | 0           | 1033 | 291  | 0           | 2074 | 709  | 0          | 0    | 0    | 201        | 0    | 207  |
| User Adj:   | 1.00        | 1.00 | 0.00 | 1.00        | 1.00 | 0.00 | 1.00       | 1.00 | 1.00 | 1.00       | 1.00 | 1.00 |
| PHF Adj:  | 1.00        | 1.00 | 0.00 | 1.00        | 1.00 | 0.00 | 1.00       | 1.00 | 1.00 | 1.00       | 1.00 | 1.00 |
| PHF Volume:   | 0           | 1033 | 0    | 0           | 2074 | 0    | 0          | 0    | 0    | 201        | 0    | 207  |
| Reduct Vol:   | 0           | 0    | 0    | 0           | 0    | 0    | 0          | 0    | 0    | 0          | 0    | 0    |
| Reduced Vol:  | 0           | 1033 | 0    | 0           | 2074 | 0    | 0          | 0    | 0    | 201        | 0    | 207  |
| PCE Adj:  | 1.00        | 1.00 | 0.00 | 1.00        | 1.00 | 0.00 | 1.00       | 1.00 | 1.00 | 1.00       | 1.00 | 1.00 |
| MLF Adj:  | 1.00        | 1.00 | 0.00 | 1.00        | 1.00 | 0.00 | 1.00       | 1.00 | 1.00 | 1.00       | 1.00 | 1.00 |
| Final Volume:   | 0           | 1033 | 0    | 0           | 2074 | 0    | 0          | 0    | 0    | 201        | 0    | 207  |
| Saturation Flow Module:   |             |      |      |             |      |      |            |      |      |            |      |      |
| Sat/Lane:   | 1900        | 1900 | 1900 | 1900        | 1900 | 1900 | 1900       | 1900 | 1900 | 1900       | 1900 | 1900 |
| Adjustment:   | 0.92        | 1.00 | 0.92 | 0.92        | 1.00 | 0.92 | 0.92       | 1.00 | 0.92 | 0.83       | 1.00 | 0.92 |
| Lanes:  | 0.00        | 3.00 | 1.00 | 0.00        | 3.00 | 1.00 | 0.00       | 0.00 | 0.00 | 2.00       | 0.00 | 1.00 |
| Final Sat.:   | 0           | 5700 | 1750 | 0           | 5700 | 1750 | 0          | 0    | 0    | 3150       | 0    | 1750 |
| Capacity Analysis Module:                                       |             |      |      |             |      |      |            |      |      |            |      |      |
| Vol/Sat:  | 0.00        | 0.18 | 0.00 | 0.00        | 0.36 | 0.00 | 0.00       | 0.00 | 0.00 | 0.06       | 0.00 | 0.12 |
| Crit Moves:   | ****        |      |      | ****        |      |      |            |      |      |            | **** |      |
| Green Time:   | 0.0         | 93.6 | 0.0  | 0.0         | 93.6 | 0.0  | 0.0        | 0.0  | 0.0  | 30.4       | 0.0  | 30.4 |
| Volume/Cap:   | 0.00        | 0.25 | 0.00 | 0.00        | 0.51 | 0.00 | 0.00       | 0.00 | 0.00 | 0.27       | 0.00 | 0.51 |
| Delay/Veh:  | 0.0         | 6.3  | 0.0  | 0.0         | 8.1  | 0.0  | 0.0        | 0.0  | 0.0  | 40.9       | 0.0  | 44.3 |
| User DelAdj:  | 1.00        | 1.00 | 1.00 | 1.00        | 1.00 | 1.00 | 1.00       | 1.00 | 1.00 | 1.00       | 1.00 | 1.00 |
| AdjDel/Veh:   | 0.0         | 6.3  | 0.0  | 0.0         | 8.1  | 0.0  | 0.0        | 0.0  | 0.0  | 40.9       | 0.0  | 44.3 |
| LOS by Move:  | A           | A    | A    | A           | A    | A    | A          | A    | A    | D          | A    | D    |
| HCM2k95thQ:   | 0           | 9    | 0    | 0           | 22   | 0    | 0          | 0    | 0    | 8          | 0    | 15   |

Note: Queue reported is the number of cars per lane.

BART

Level Of Service Computation Report  
 2000 HCM Operations (Future Volume Alternative)  
 AM - Existing Conditions

Intersection #3053: 880 NB Ramps/Coleman [Study Int 37]

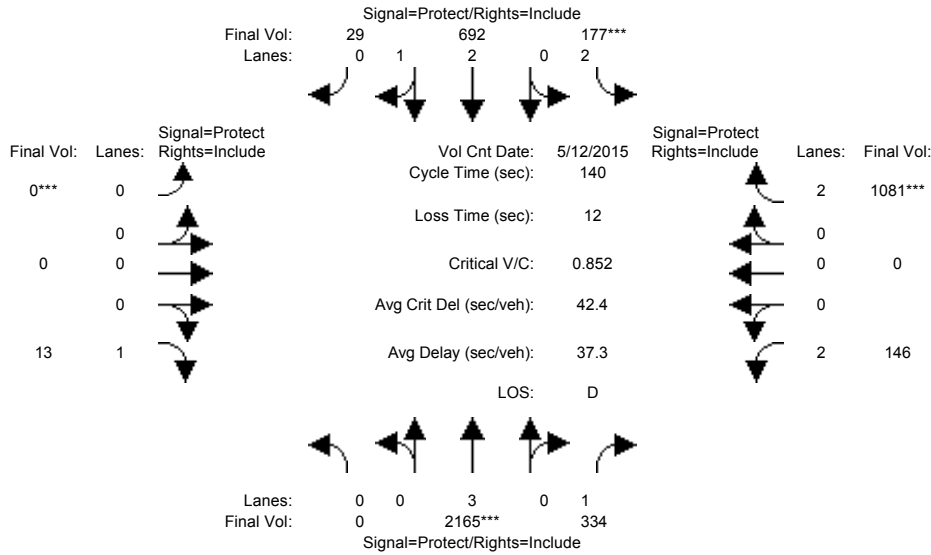

| Approach:  | North Bound |      |      | South Bound |      |      | East Bound |      |      | West Bound |      |      |
|--|-------------|------|------|-------------|------|------|------------|------|------|------------|------|------|
| Movement:  | L           | T    | R    | L           | T    | R    | L          | T    | R    | L          | T    | R    |
| Min. Green:  | 0           | 10   | 10   | 7           | 10   | 10   | 0          | 0    | 10   | 10         | 0    | 10   |
| Y+R:   | 4.0         | 4.0  | 4.0  | 4.0         | 4.0  | 4.0  | 4.0        | 4.0  | 4.0  | 4.0        | 4.0  | 4.0  |
| Volume Module: >> Count Date: 12 May 2015 << 7:45-8:45AM |             |      |      |             |      |      |            |      |      |            |      |      |
| Base Vol:  | 0           | 2165 | 334  | 177         | 692  | 29   | 0          | 0    | 13   | 146        | 0    | 1081 |
| Growth Adj:  | 1.00        | 1.00 | 1.00 | 1.00        | 1.00 | 1.00 | 1.00       | 1.00 | 1.00 | 1.00       | 1.00 | 1.00 |
| Initial Bse:   | 0           | 2165 | 334  | 177         | 692  | 29   | 0          | 0    | 13   | 146        | 0    | 1081 |
| Added Vol:   | 0           | 0    | 0    | 0           | 0    | 0    | 0          | 0    | 0    | 0          | 0    | 0    |
| PasserByVol:   | 0           | 0    | 0    | 0           | 0    | 0    | 0          | 0    | 0    | 0          | 0    | 0    |
| Initial Fut:   | 0           | 2165 | 334  | 177         | 692  | 29   | 0          | 0    | 13   | 146        | 0    | 1081 |
| User Adj:  | 1.00        | 1.00 | 1.00 | 1.00        | 1.00 | 1.00 | 1.00       | 1.00 | 1.00 | 1.00       | 1.00 | 1.00 |
| PHF Adj:   | 1.00        | 1.00 | 1.00 | 1.00        | 1.00 | 1.00 | 1.00       | 1.00 | 1.00 | 1.00       | 1.00 | 1.00 |
| PHF Volume:  | 0           | 2165 | 334  | 177         | 692  | 29   | 0          | 0    | 13   | 146        | 0    | 1081 |
| Reduct Vol:  | 0           | 0    | 0    | 0           | 0    | 0    | 0          | 0    | 0    | 0          | 0    | 0    |
| Reduced Vol:   | 0           | 2165 | 334  | 177         | 692  | 29   | 0          | 0    | 13   | 146        | 0    | 1081 |
| PCE Adj:   | 1.00        | 1.00 | 1.00 | 1.00        | 1.00 | 1.00 | 1.00       | 1.00 | 1.00 | 1.00       | 1.00 | 1.00 |
| MLF Adj:   | 1.00        | 1.00 | 1.00 | 1.00        | 1.00 | 1.00 | 1.00       | 1.00 | 1.00 | 1.00       | 1.00 | 1.00 |
| Final Volume:  | 0           | 2165 | 334  | 177         | 692  | 29   | 0          | 0    | 13   | 146        | 0    | 1081 |
| Saturation Flow Module:                                  |             |      |      |             |      |      |            |      |      |            |      |      |
| Sat/Lane:  | 1900        | 1900 | 1900 | 1900        | 1900 | 1900 | 1900       | 1900 | 1900 | 1900       | 1900 | 1900 |
| Adjustment:  | 0.92        | 1.00 | 0.92 | 0.83        | 0.98 | 0.95 | 0.92       | 1.00 | 0.92 | 0.83       | 1.00 | 0.83 |
| Lanes:   | 0.00        | 3.00 | 1.00 | 2.00        | 2.87 | 0.13 | 0.00       | 0.00 | 1.00 | 2.00       | 0.00 | 2.00 |
| Final Sat.:  | 0           | 5700 | 1750 | 3150        | 5374 | 225  | 0          | 0    | 1750 | 3150       | 0    | 3150 |
| Capacity Analysis Module:                                |             |      |      |             |      |      |            |      |      |            |      |      |
| Vol/Sat:   | 0.00        | 0.38 | 0.19 | 0.06        | 0.13 | 0.13 | 0.00       | 0.00 | 0.01 | 0.05       | 0.00 | 0.34 |
| Crit Moves:  | ****        | **** | **** | ****        | **** | **** | ****       | **** | **** | ****       | **** | **** |
| Green Time:  | 0.0         | 62.4 | 62.4 | 9.2         | 71.6 | 71.6 | 0.0        | 0.0  | 5.3  | 51.1       | 0.0  | 56.4 |
| Volume/Cap:  | 0.00        | 0.85 | 0.43 | 0.85        | 0.25 | 0.25 | 0.00       | 0.00 | 0.20 | 0.13       | 0.00 | 0.85 |
| Delay/Veh:   | 0.0         | 37.7 | 27.0 | 91.8        | 19.2 | 19.2 | 0.0        | 0.0  | 66.7 | 29.7       | 0.0  | 43.8 |
| User DelAdj:   | 1.00        | 1.00 | 1.00 | 1.00        | 1.00 | 1.00 | 1.00       | 1.00 | 1.00 | 1.00       | 1.00 | 1.00 |
| AdjDel/Veh:  | 0.0         | 37.7 | 27.0 | 91.8        | 19.2 | 19.2 | 0.0        | 0.0  | 66.7 | 29.7       | 0.0  | 43.8 |
| LOS by Move:   | A           | D    | C    | F           | B    | B    | A          | A    | E    | C          | A    | D    |
| HCM2k95thQ:  | 0           | 44   | 18   | 13          | 11   | 11   | 0          | 0    | 2    | 5          | 0    | 45   |

Note: Queue reported is the number of cars per lane.

BART

Level Of Service Computation Report  
 2000 HCM Operations (Future Volume Alternative)  
 PM - Existing Conditions

Intersection #3053: 880 NB Ramps/Coleman [Study Int 37]

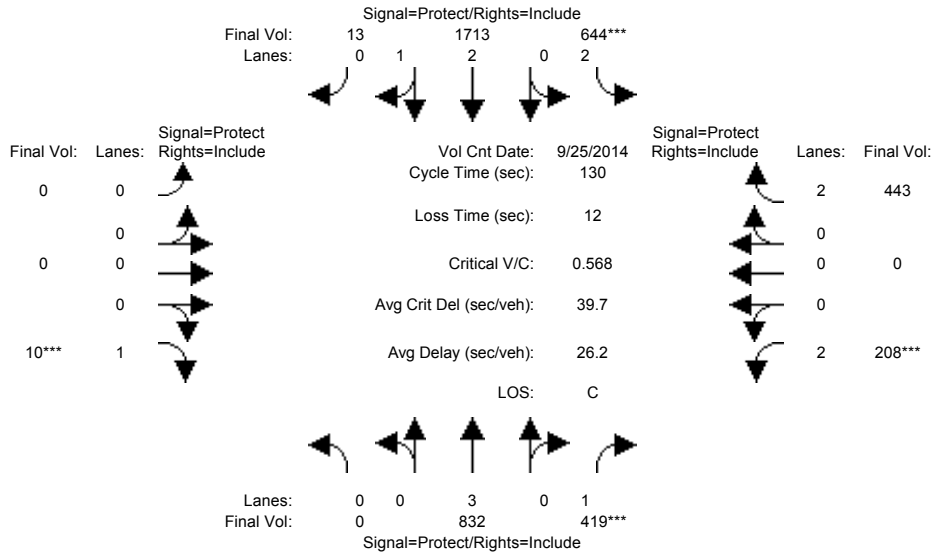

| Approach:  | North Bound |      |      | South Bound |      |      | East Bound |      |      | West Bound |      |      |
|--|-------------|------|------|-------------|------|------|------------|------|------|------------|------|------|
| Movement:  | L           | T    | R    | L           | T    | R    | L          | T    | R    | L          | T    | R    |
| Min. Green:  | 0           | 10   | 10   | 7           | 10   | 10   | 0          | 0    | 10   | 10         | 0    | 10   |
| Y+R:   | 4.0         | 4.0  | 4.0  | 4.0         | 4.0  | 4.0  | 4.0        | 4.0  | 4.0  | 4.0        | 4.0  | 4.0  |
| Volume Module: >> Count Date: 25 Sep 2014 << 5:00-6:00PM |             |      |      |             |      |      |            |      |      |            |      |      |
| Base Vol:  | 0           | 832  | 419  | 644         | 1713 | 13   | 0          | 0    | 10   | 208        | 0    | 443  |
| Growth Adj:  | 1.00        | 1.00 | 1.00 | 1.00        | 1.00 | 1.00 | 1.00       | 1.00 | 1.00 | 1.00       | 1.00 | 1.00 |
| Initial Bse:   | 0           | 832  | 419  | 644         | 1713 | 13   | 0          | 0    | 10   | 208        | 0    | 443  |
| Added Vol:   | 0           | 0    | 0    | 0           | 0    | 0    | 0          | 0    | 0    | 0          | 0    | 0    |
| PasserByVol:   | 0           | 0    | 0    | 0           | 0    | 0    | 0          | 0    | 0    | 0          | 0    | 0    |
| Initial Fut:   | 0           | 832  | 419  | 644         | 1713 | 13   | 0          | 0    | 10   | 208        | 0    | 443  |
| User Adj:  | 1.00        | 1.00 | 1.00 | 1.00        | 1.00 | 1.00 | 1.00       | 1.00 | 1.00 | 1.00       | 1.00 | 1.00 |
| PHF Adj:   | 1.00        | 1.00 | 1.00 | 1.00        | 1.00 | 1.00 | 1.00       | 1.00 | 1.00 | 1.00       | 1.00 | 1.00 |
| PHF Volume:  | 0           | 832  | 419  | 644         | 1713 | 13   | 0          | 0    | 10   | 208        | 0    | 443  |
| Reduct Vol:  | 0           | 0    | 0    | 0           | 0    | 0    | 0          | 0    | 0    | 0          | 0    | 0    |
| Reduced Vol:   | 0           | 832  | 419  | 644         | 1713 | 13   | 0          | 0    | 10   | 208        | 0    | 443  |
| PCE Adj:   | 1.00        | 1.00 | 1.00 | 1.00        | 1.00 | 1.00 | 1.00       | 1.00 | 1.00 | 1.00       | 1.00 | 1.00 |
| MLF Adj:   | 1.00        | 1.00 | 1.00 | 1.00        | 1.00 | 1.00 | 1.00       | 1.00 | 1.00 | 1.00       | 1.00 | 1.00 |
| Final Volume:  | 0           | 832  | 419  | 644         | 1713 | 13   | 0          | 0    | 10   | 208        | 0    | 443  |
| Saturation Flow Module:                                  |             |      |      |             |      |      |            |      |      |            |      |      |
| Sat/Lane:  | 1900        | 1900 | 1900 | 1900        | 1900 | 1900 | 1900       | 1900 | 1900 | 1900       | 1900 | 1900 |
| Adjustment:  | 0.92        | 1.00 | 0.92 | 0.83        | 0.98 | 0.95 | 0.92       | 1.00 | 0.92 | 0.83       | 1.00 | 0.83 |
| Lanes:   | 0.00        | 3.00 | 1.00 | 2.00        | 2.98 | 0.02 | 0.00       | 0.00 | 1.00 | 2.00       | 0.00 | 2.00 |
| Final Sat.:  | 0           | 5700 | 1750 | 3150        | 5558 | 42   | 0          | 0    | 1750 | 3150       | 0    | 3150 |
| Capacity Analysis Module:                                |             |      |      |             |      |      |            |      |      |            |      |      |
| Vol/Sat:   | 0.00        | 0.15 | 0.24 | 0.20        | 0.31 | 0.31 | 0.00       | 0.00 | 0.01 | 0.07       | 0.00 | 0.14 |
| Crit Moves:  | 0.00        | 50.7 | 50.7 | 43.3        | 94.0 | 94.0 | 0.00       | 0.00 | 10.0 | 14.0       | 0.00 | 24.0 |
| Green Time:  | 0.00        | 0.37 | 0.61 | 0.61        | 0.43 | 0.43 | 0.00       | 0.00 | 0.07 | 0.61       | 0.00 | 0.76 |
| Delay/Veh:   | 0.0         | 28.4 | 33.5 | 37.4        | 7.3  | 7.3  | 0.0        | 0.0  | 55.9 | 58.8       | 0.0  | 56.2 |
| User DelAdj:   | 1.00        | 1.00 | 1.00 | 1.00        | 1.00 | 1.00 | 1.00       | 1.00 | 1.00 | 1.00       | 1.00 | 1.00 |
| AdjDel/Veh:  | 0.0         | 28.4 | 33.5 | 37.4        | 7.3  | 7.3  | 0.0        | 0.0  | 55.9 | 58.8       | 0.0  | 56.2 |
| LOS by Move:   | A           | C    | C    | D           | A    | A    | A          | A    | E    | E          | A    | E    |
| HCM2k95thQ:  | 0           | 14   | 25   | 24          | 17   | 17   | 0          | 0    | 1    | 11         | 0    | 21   |

Note: Queue reported is the number of cars per lane.

BART

Level Of Service Computation Report  
 2000 HCM Operations (Future Volume Alternative)  
 AM - Existing Conditions

Intersection #3057: The Alameda/Hedding [Study Int 58]

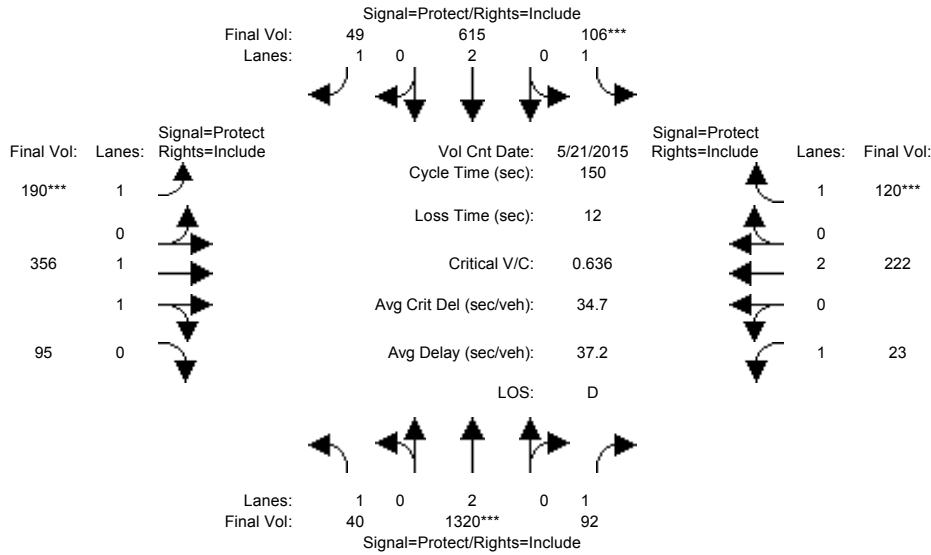

| Approach:  | North Bound |      |      | South Bound |      |      | East Bound |      |      | West Bound |      |      |
|--|-------------|------|------|-------------|------|------|------------|------|------|------------|------|------|
| Movement:  | L           | T    | R    | L           | T    | R    | L          | T    | R    | L          | T    | R    |
| Min. Green:  | 7           | 10   | 10   | 7           | 10   | 10   | 7          | 10   | 10   | 7          | 10   | 10   |
| Y+R:   | 4.0         | 4.0  | 4.0  | 4.0         | 4.0  | 4.0  | 4.0        | 4.0  | 4.0  | 4.0        | 4.0  | 4.0  |
| Volume Module: >> Count Date: 21 May 2015 << 7:30-8:30AM |             |      |      |             |      |      |            |      |      |            |      |      |
| Base Vol:  | 40          | 1320 | 92   | 106         | 615  | 49   | 190        | 356  | 95   | 23         | 222  | 120  |
| Growth Adj:  | 1.00        | 1.00 | 1.00 | 1.00        | 1.00 | 1.00 | 1.00       | 1.00 | 1.00 | 1.00       | 1.00 | 1.00 |
| Initial Bse:   | 40          | 1320 | 92   | 106         | 615  | 49   | 190        | 356  | 95   | 23         | 222  | 120  |
| Added Vol:   | 0           | 0    | 0    | 0           | 0    | 0    | 0          | 0    | 0    | 0          | 0    | 0    |
| PasserByVol:   | 0           | 0    | 0    | 0           | 0    | 0    | 0          | 0    | 0    | 0          | 0    | 0    |
| Initial Fut:   | 40          | 1320 | 92   | 106         | 615  | 49   | 190        | 356  | 95   | 23         | 222  | 120  |
| User Adj:  | 1.00        | 1.00 | 1.00 | 1.00        | 1.00 | 1.00 | 1.00       | 1.00 | 1.00 | 1.00       | 1.00 | 1.00 |
| PHF Adj:   | 1.00        | 1.00 | 1.00 | 1.00        | 1.00 | 1.00 | 1.00       | 1.00 | 1.00 | 1.00       | 1.00 | 1.00 |
| PHF Volume:  | 40          | 1320 | 92   | 106         | 615  | 49   | 190        | 356  | 95   | 23         | 222  | 120  |
| Reduct Vol:  | 0           | 0    | 0    | 0           | 0    | 0    | 0          | 0    | 0    | 0          | 0    | 0    |
| Reduced Vol:   | 40          | 1320 | 92   | 106         | 615  | 49   | 190        | 356  | 95   | 23         | 222  | 120  |
| PCE Adj:   | 1.00        | 1.00 | 1.00 | 1.00        | 1.00 | 1.00 | 1.00       | 1.00 | 1.00 | 1.00       | 1.00 | 1.00 |
| MLF Adj:   | 1.00        | 1.00 | 1.00 | 1.00        | 1.00 | 1.00 | 1.00       | 1.00 | 1.00 | 1.00       | 1.00 | 1.00 |
| Final Volume:  | 40          | 1320 | 92   | 106         | 615  | 49   | 190        | 356  | 95   | 23         | 222  | 120  |
| Saturation Flow Module:                                  |             |      |      |             |      |      |            |      |      |            |      |      |
| Sat/Lane:  | 1900        | 1900 | 1900 | 1900        | 1900 | 1900 | 1900       | 1900 | 1900 | 1900       | 1900 | 1900 |
| Adjustment:  | 0.92        | 1.00 | 0.92 | 0.92        | 1.00 | 0.92 | 0.92       | 0.98 | 0.95 | 0.92       | 1.00 | 0.92 |
| Lanes:   | 1.00        | 2.00 | 1.00 | 1.00        | 2.00 | 1.00 | 1.00       | 1.57 | 0.43 | 1.00       | 2.00 | 1.00 |
| Final Sat.:  | 1750        | 3800 | 1750 | 1750        | 3800 | 1750 | 1750       | 2920 | 779  | 1750       | 3800 | 1750 |
| Capacity Analysis Module:                                |             |      |      |             |      |      |            |      |      |            |      |      |
| Vol/Sat:   | 0.02        | 0.35 | 0.05 | 0.06        | 0.16 | 0.03 | 0.11       | 0.12 | 0.12 | 0.01       | 0.06 | 0.07 |
| Crit Moves:  | ****        | **** | **** | ****        | **** | **** | ****       | **** | **** | ****       | **** | **** |
| Green Time:  | 21.5        | 81.9 | 81.9 | 14.3        | 74.7 | 74.7 | 25.6       | 30.2 | 30.2 | 11.6       | 16.2 | 16.2 |
| Volume/Cap:  | 0.16        | 0.64 | 0.10 | 0.64        | 0.33 | 0.06 | 0.64       | 0.61 | 0.61 | 0.17       | 0.54 | 0.64 |
| Delay/Veh:   | 56.6        | 24.3 | 16.3 | 73.2        | 22.7 | 19.5 | 62.3       | 55.9 | 55.9 | 65.3       | 64.9 | 71.1 |
| User DelAdj:   | 1.00        | 1.00 | 1.00 | 1.00        | 1.00 | 1.00 | 1.00       | 1.00 | 1.00 | 1.00       | 1.00 | 1.00 |
| AdjDel/Veh:  | 56.6        | 24.3 | 16.3 | 73.2        | 22.7 | 19.5 | 62.3       | 55.9 | 55.9 | 65.3       | 64.9 | 71.1 |
| LOS by Move:   | E           | C    | B    | E           | C    | B    | E          | E    | E    | E          | E    | E    |
| HCM2k95thQ:  | 3           | 34   | 4    | 10          | 15   | 2    | 18         | 19   | 19   | 2          | 9    | 11   |

Note: Queue reported is the number of cars per lane.

BART

Level Of Service Computation Report  
2000 HCM Operations (Future Volume Alternative)  
PM - Existing Conditions

Intersection #3057: The Alameda/Hedding [Study Int 58]

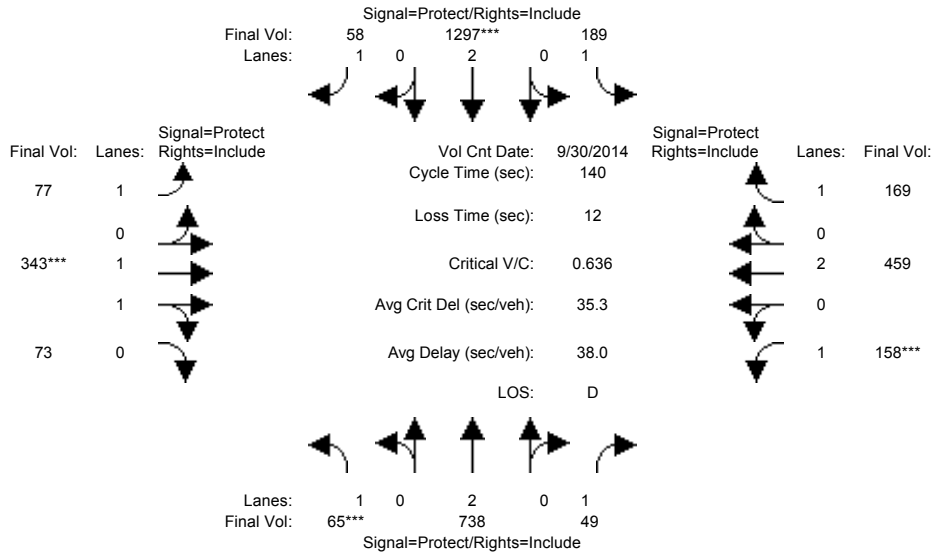

| Approach:  | North Bound |      |      | South Bound |      |      | East Bound |      |      | West Bound |      |      |
|--|-------------|------|------|-------------|------|------|------------|------|------|------------|------|------|
| Movement:  | L           | T    | R    | L           | T    | R    | L          | T    | R    | L          | T    | R    |
| Min. Green:  | 7           | 10   | 10   | 7           | 10   | 10   | 7          | 10   | 10   | 7          | 10   | 10   |
| Y+R:   | 4.0         | 4.0  | 4.0  | 4.0         | 4.0  | 4.0  | 4.0        | 4.0  | 4.0  | 4.0        | 4.0  | 4.0  |
| Volume Module: >> Count Date: 30 Sep 2014 << 5:00-6:00PM |             |      |      |             |      |      |            |      |      |            |      |      |
| Base Vol:  | 65          | 738  | 49   | 189         | 1297 | 58   | 77         | 343  | 73   | 158        | 459  | 169  |
| Growth Adj:  | 1.00        | 1.00 | 1.00 | 1.00        | 1.00 | 1.00 | 1.00       | 1.00 | 1.00 | 1.00       | 1.00 | 1.00 |
| Initial Bse:   | 65          | 738  | 49   | 189         | 1297 | 58   | 77         | 343  | 73   | 158        | 459  | 169  |
| Added Vol:   | 0           | 0    | 0    | 0           | 0    | 0    | 0          | 0    | 0    | 0          | 0    | 0    |
| PasserByVol:   | 0           | 0    | 0    | 0           | 0    | 0    | 0          | 0    | 0    | 0          | 0    | 0    |
| Initial Fut:   | 65          | 738  | 49   | 189         | 1297 | 58   | 77         | 343  | 73   | 158        | 459  | 169  |
| User Adj:  | 1.00        | 1.00 | 1.00 | 1.00        | 1.00 | 1.00 | 1.00       | 1.00 | 1.00 | 1.00       | 1.00 | 1.00 |
| PHF Adj:   | 1.00        | 1.00 | 1.00 | 1.00        | 1.00 | 1.00 | 1.00       | 1.00 | 1.00 | 1.00       | 1.00 | 1.00 |
| PHF Volume:  | 65          | 738  | 49   | 189         | 1297 | 58   | 77         | 343  | 73   | 158        | 459  | 169  |
| Reduct Vol:  | 0           | 0    | 0    | 0           | 0    | 0    | 0          | 0    | 0    | 0          | 0    | 0    |
| Reduced Vol:   | 65          | 738  | 49   | 189         | 1297 | 58   | 77         | 343  | 73   | 158        | 459  | 169  |
| PCE Adj:   | 1.00        | 1.00 | 1.00 | 1.00        | 1.00 | 1.00 | 1.00       | 1.00 | 1.00 | 1.00       | 1.00 | 1.00 |
| MLF Adj:   | 1.00        | 1.00 | 1.00 | 1.00        | 1.00 | 1.00 | 1.00       | 1.00 | 1.00 | 1.00       | 1.00 | 1.00 |
| FinalVolume:   | 65          | 738  | 49   | 189         | 1297 | 58   | 77         | 343  | 73   | 158        | 459  | 169  |
| Saturation Flow Module:                                  |             |      |      |             |      |      |            |      |      |            |      |      |
| Sat/Lane:  | 1900        | 1900 | 1900 | 1900        | 1900 | 1900 | 1900       | 1900 | 1900 | 1900       | 1900 | 1900 |
| Adjustment:  | 0.92        | 1.00 | 0.92 | 0.92        | 1.00 | 0.92 | 0.92       | 0.98 | 0.95 | 0.92       | 1.00 | 0.92 |
| Lanes:   | 1.00        | 2.00 | 1.00 | 1.00        | 2.00 | 1.00 | 1.00       | 1.64 | 0.36 | 1.00       | 2.00 | 1.00 |
| Final Sat.:  | 1750        | 3800 | 1750 | 1750        | 3800 | 1750 | 1750       | 3050 | 649  | 1750       | 3800 | 1750 |
| Capacity Analysis Module:                                |             |      |      |             |      |      |            |      |      |            |      |      |
| Vol/Sat:   | 0.04        | 0.19 | 0.03 | 0.11        | 0.34 | 0.03 | 0.04       | 0.11 | 0.11 | 0.09       | 0.12 | 0.10 |
| Crit Moves:  | ****        |      |      | ****        |      |      | ****       |      |      | ****       |      |      |
| Green Time:  | 8.2         | 53.6 | 53.6 | 29.8        | 75.2 | 75.2 | 13.1       | 24.8 | 24.8 | 19.9       | 31.6 | 31.6 |
| Volume/Cap:  | 0.64        | 0.51 | 0.07 | 0.51        | 0.64 | 0.06 | 0.47       | 0.64 | 0.64 | 0.64       | 0.54 | 0.43 |
| Delay/Veh:   | 76.9        | 33.4 | 27.5 | 49.8        | 23.5 | 15.6 | 62.3       | 55.5 | 55.5 | 62.0       | 48.4 | 47.2 |
| User DelAdj:   | 1.00        | 1.00 | 1.00 | 1.00        | 1.00 | 1.00 | 1.00       | 1.00 | 1.00 | 1.00       | 1.00 | 1.00 |
| AdjDel/Veh:  | 76.9        | 33.4 | 27.5 | 49.8        | 23.5 | 15.6 | 62.3       | 55.5 | 55.5 | 62.0       | 48.4 | 47.2 |
| LOS by Move:   | E           | C    | C    | D           | C    | B    | E          | E    | E    | E          | D    | D    |
| HCM2k95thQ:  | 6           | 21   | 3    | 14          | 32   | 3    | 8          | 17   | 17   | 13         | 16   | 12   |

Note: Queue reported is the number of cars per lane.

BART

Level Of Service Computation Report  
2000 HCM Operations (Future Volume Alternative)  
AM - Existing Conditions

Intersection #3058: The Alameda/Naglee [Study Int 59]

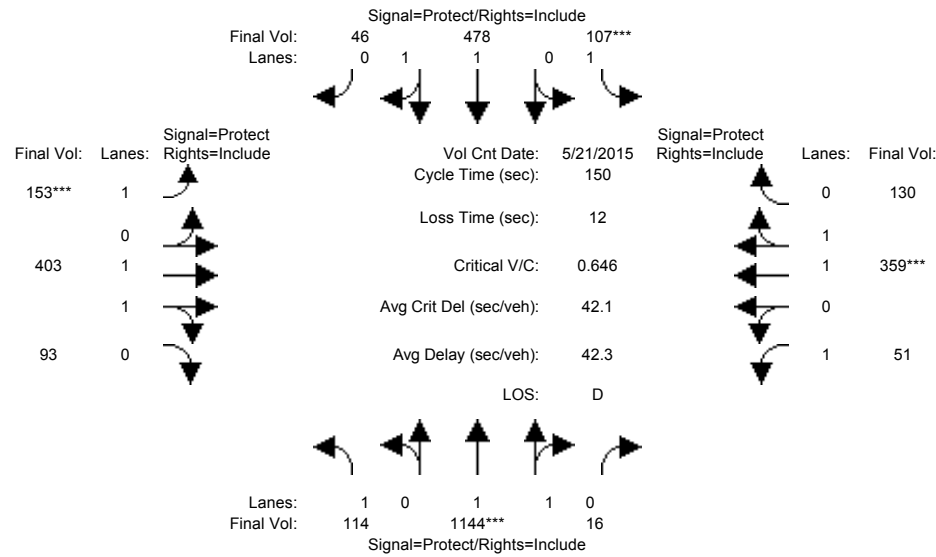

| Approach:  | North Bound |      |      | South Bound |      |      | East Bound |      |      | West Bound |      |      |
|--|-------------|------|------|-------------|------|------|------------|------|------|------------|------|------|
| Movement:  | L           | T    | R    | L           | T    | R    | L          | T    | R    | L          | T    | R    |
| Min. Green:  | 7           | 10   | 10   | 7           | 10   | 10   | 7          | 10   | 10   | 7          | 10   | 10   |
| Y+R:   | 4.0         | 4.0  | 4.0  | 4.0         | 4.0  | 4.0  | 4.0        | 4.0  | 4.0  | 4.0        | 4.0  | 4.0  |
| Volume Module: >> Count Date: 21 May 2015 << 7:30-8:30AM |             |      |      |             |      |      |            |      |      |            |      |      |
| Base Vol:  | 114         | 1144 | 16   | 107         | 478  | 46   | 153        | 403  | 93   | 51         | 359  | 130  |
| Growth Adj:  | 1.00        | 1.00 | 1.00 | 1.00        | 1.00 | 1.00 | 1.00       | 1.00 | 1.00 | 1.00       | 1.00 | 1.00 |
| Initial Bse:   | 114         | 1144 | 16   | 107         | 478  | 46   | 153        | 403  | 93   | 51         | 359  | 130  |
| Added Vol:   | 0           | 0    | 0    | 0           | 0    | 0    | 0          | 0    | 0    | 0          | 0    | 0    |
| PasserByVol:   | 0           | 0    | 0    | 0           | 0    | 0    | 0          | 0    | 0    | 0          | 0    | 0    |
| Initial Fut:   | 114         | 1144 | 16   | 107         | 478  | 46   | 153        | 403  | 93   | 51         | 359  | 130  |
| User Adj:  | 1.00        | 1.00 | 1.00 | 1.00        | 1.00 | 1.00 | 1.00       | 1.00 | 1.00 | 1.00       | 1.00 | 1.00 |
| PHF Adj:   | 1.00        | 1.00 | 1.00 | 1.00        | 1.00 | 1.00 | 1.00       | 1.00 | 1.00 | 1.00       | 1.00 | 1.00 |
| PHF Volume:  | 114         | 1144 | 16   | 107         | 478  | 46   | 153        | 403  | 93   | 51         | 359  | 130  |
| Reduct Vol:  | 0           | 0    | 0    | 0           | 0    | 0    | 0          | 0    | 0    | 0          | 0    | 0    |
| Reduced Vol:   | 114         | 1144 | 16   | 107         | 478  | 46   | 153        | 403  | 93   | 51         | 359  | 130  |
| PCE Adj:   | 1.00        | 1.00 | 1.00 | 1.00        | 1.00 | 1.00 | 1.00       | 1.00 | 1.00 | 1.00       | 1.00 | 1.00 |
| MLF Adj:   | 1.00        | 1.00 | 1.00 | 1.00        | 1.00 | 1.00 | 1.00       | 1.00 | 1.00 | 1.00       | 1.00 | 1.00 |
| Final Volume:  | 114         | 1144 | 16   | 107         | 478  | 46   | 153        | 403  | 93   | 51         | 359  | 130  |
| Saturation Flow Module:                                  |             |      |      |             |      |      |            |      |      |            |      |      |
| Sat/Lane:  | 1900        | 1900 | 1900 | 1900        | 1900 | 1900 | 1900       | 1900 | 1900 | 1900       | 1900 | 1900 |
| Adjustment:  | 0.92        | 0.97 | 0.95 | 0.92        | 0.98 | 0.95 | 0.92       | 0.98 | 0.95 | 0.92       | 0.98 | 0.95 |
| Lanes:   | 1.00        | 1.97 | 0.03 | 1.00        | 1.82 | 0.18 | 1.00       | 1.61 | 0.39 | 1.00       | 1.45 | 0.55 |
| Final Sat.:  | 1750        | 3649 | 51   | 1750        | 3375 | 325  | 1750       | 3006 | 694  | 1750       | 2716 | 983  |
| Capacity Analysis Module:                                |             |      |      |             |      |      |            |      |      |            |      |      |
| Vol/Sat:   | 0.07        | 0.31 | 0.31 | 0.06        | 0.14 | 0.14 | 0.09       | 0.13 | 0.13 | 0.03       | 0.13 | 0.13 |
| Crit Moves:  | ****        | **** | **** | ****        | **** | **** | ****       | **** | **** | ****       | **** | **** |
| Green Time:  | 27.4        | 72.8 | 72.8 | 14.2        | 59.6 | 59.6 | 20.3       | 37.8 | 37.8 | 13.2       | 30.7 | 30.7 |
| Volume/Cap:  | 0.36        | 0.65 | 0.65 | 0.65        | 0.36 | 0.36 | 0.65       | 0.53 | 0.53 | 0.33       | 0.65 | 0.65 |
| Delay/Veh:   | 54.3        | 29.8 | 29.8 | 74.0        | 31.9 | 31.9 | 67.5       | 49.0 | 49.0 | 65.6       | 56.6 | 56.6 |
| User DelAdj:   | 1.00        | 1.00 | 1.00 | 1.00        | 1.00 | 1.00 | 1.00       | 1.00 | 1.00 | 1.00       | 1.00 | 1.00 |
| AdjDel/Veh:  | 54.3        | 29.8 | 29.8 | 74.0        | 31.9 | 31.9 | 67.5       | 49.0 | 49.0 | 65.6       | 56.6 | 56.6 |
| LOS by Move:   | D           | C    | C    | E           | C    | C    | E          | D    | D    | E          | E    | E    |
| HCM2k95thQ:  | 10          | 34   | 34   | 10          | 16   | 16   | 15         | 19   | 19   | 5          | 19   | 19   |

Note: Queue reported is the number of cars per lane.

BART

Level Of Service Computation Report  
 2000 HCM Operations (Future Volume Alternative)  
 PM - Existing Conditions

Intersection #3058: The Alameda/Naglee [Study Int 59]

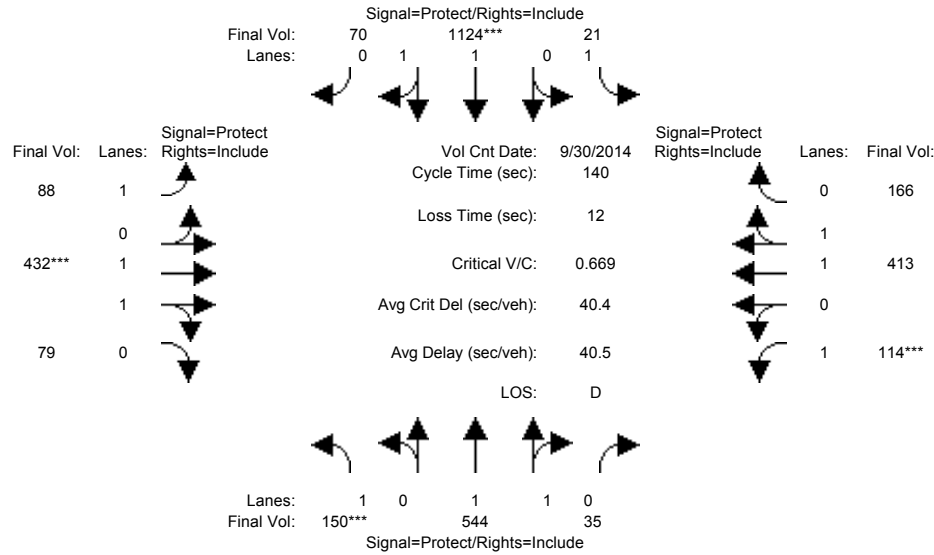

| Approach:  | North Bound |      |      | South Bound |      |      | East Bound |      |      | West Bound |      |      |
|--|-------------|------|------|-------------|------|------|------------|------|------|------------|------|------|
| Movement:  | L           | T    | R    | L           | T    | R    | L          | T    | R    | L          | T    | R    |
| Min. Green:  | 7           | 10   | 10   | 7           | 10   | 10   | 7          | 10   | 10   | 7          | 10   | 10   |
| Y+R:   | 4.0         | 4.0  | 4.0  | 4.0         | 4.0  | 4.0  | 4.0        | 4.0  | 4.0  | 4.0        | 4.0  | 4.0  |
| Volume Module: >> Count Date: 30 Sep 2014 << 500-600PM |             |      |      |             |      |      |            |      |      |            |      |      |
| Base Vol:  | 150         | 544  | 35   | 21          | 1124 | 70   | 88         | 432  | 79   | 114        | 413  | 166  |
| Growth Adj:  | 1.00        | 1.00 | 1.00 | 1.00        | 1.00 | 1.00 | 1.00       | 1.00 | 1.00 | 1.00       | 1.00 | 1.00 |
| Initial Bse:   | 150         | 544  | 35   | 21          | 1124 | 70   | 88         | 432  | 79   | 114        | 413  | 166  |
| Added Vol:   | 0           | 0    | 0    | 0           | 0    | 0    | 0          | 0    | 0    | 0          | 0    | 0    |
| PasserByVol:   | 0           | 0    | 0    | 0           | 0    | 0    | 0          | 0    | 0    | 0          | 0    | 0    |
| Initial Fut:   | 150         | 544  | 35   | 21          | 1124 | 70   | 88         | 432  | 79   | 114        | 413  | 166  |
| User Adj:  | 1.00        | 1.00 | 1.00 | 1.00        | 1.00 | 1.00 | 1.00       | 1.00 | 1.00 | 1.00       | 1.00 | 1.00 |
| PHF Adj:   | 1.00        | 1.00 | 1.00 | 1.00        | 1.00 | 1.00 | 1.00       | 1.00 | 1.00 | 1.00       | 1.00 | 1.00 |
| PHF Volume:  | 150         | 544  | 35   | 21          | 1124 | 70   | 88         | 432  | 79   | 114        | 413  | 166  |
| Reduct Vol:  | 0           | 0    | 0    | 0           | 0    | 0    | 0          | 0    | 0    | 0          | 0    | 0    |
| Reduced Vol:   | 150         | 544  | 35   | 21          | 1124 | 70   | 88         | 432  | 79   | 114        | 413  | 166  |
| PCE Adj:   | 1.00        | 1.00 | 1.00 | 1.00        | 1.00 | 1.00 | 1.00       | 1.00 | 1.00 | 1.00       | 1.00 | 1.00 |
| MLF Adj:   | 1.00        | 1.00 | 1.00 | 1.00        | 1.00 | 1.00 | 1.00       | 1.00 | 1.00 | 1.00       | 1.00 | 1.00 |
| Final Volume:  | 150         | 544  | 35   | 21          | 1124 | 70   | 88         | 432  | 79   | 114        | 413  | 166  |
| Saturation Flow Module:                                |             |      |      |             |      |      |            |      |      |            |      |      |
| Sat/Lane:  | 1900        | 1900 | 1900 | 1900        | 1900 | 1900 | 1900       | 1900 | 1900 | 1900       | 1900 | 1900 |
| Adjustment:  | 0.92        | 0.98 | 0.95 | 0.92        | 0.98 | 0.95 | 0.92       | 0.98 | 0.95 | 0.92       | 0.98 | 0.95 |
| Lanes:   | 1.00        | 1.88 | 0.12 | 1.00        | 1.88 | 0.12 | 1.00       | 1.68 | 0.32 | 1.00       | 1.41 | 0.59 |
| Final Sat.:  | 1750        | 3476 | 224  | 1750        | 3483 | 217  | 1750       | 3128 | 572  | 1750       | 2638 | 1060 |
| Capacity Analysis Module:                              |             |      |      |             |      |      |            |      |      |            |      |      |
| Vol/Sat:   | 0.09        | 0.16 | 0.16 | 0.01        | 0.32 | 0.32 | 0.05       | 0.14 | 0.14 | 0.07       | 0.16 | 0.16 |
| Crit Moves:  | ****        |      |      | ****        |      |      | ****       |      |      | ****       |      |      |
| Green Time:  | 17.9        | 64.8 | 64.8 | 20.7        | 67.5 | 67.5 | 10.3       | 28.9 | 28.9 | 13.6       | 32.2 | 32.2 |
| Volume/Cap:  | 0.67        | 0.34 | 0.34 | 0.08        | 0.67 | 0.67 | 0.68       | 0.67 | 0.67 | 0.67       | 0.68 | 0.68 |
| Delay/Veh:   | 65.8        | 24.1 | 24.1 | 51.6        | 28.7 | 28.7 | 77.0       | 53.4 | 53.4 | 70.8       | 51.5 | 51.5 |
| User DelAdj:   | 1.00        | 1.00 | 1.00 | 1.00        | 1.00 | 1.00 | 1.00       | 1.00 | 1.00 | 1.00       | 1.00 | 1.00 |
| AdjDel/Veh:  | 65.8        | 24.1 | 24.1 | 51.6        | 28.7 | 28.7 | 77.0       | 53.4 | 53.4 | 70.8       | 51.5 | 51.5 |
| LOS by Move:   | E           | C    | C    | D           | C    | C    | E          | D    | D    | E          | D    | D    |
| HCM2k95thQ:  | 15          | 15   | 15   | 2           | 33   | 33   | 10         | 20   | 20   | 10         | 21   | 21   |

Note: Queue reported is the number of cars per lane.

BART

Level Of Service Computation Report  
 2000 HCM Operations (Future Volume Alternative)  
 AM - Existing Conditions

Intersection #3063: ALUM ROCK/JACKSON [Study Int 18]

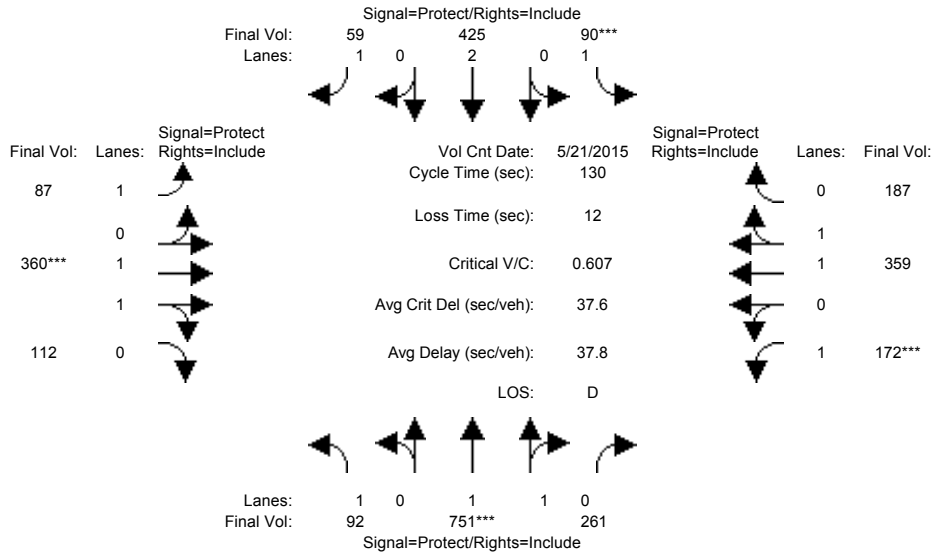

| Approach:  | North Bound |      |      | South Bound |      |      | East Bound |      |      | West Bound |      |      |
|--|-------------|------|------|-------------|------|------|------------|------|------|------------|------|------|
| Movement:  | L           | T    | R    | L           | T    | R    | L          | T    | R    | L          | T    | R    |
| Min. Green:  | 7           | 10   | 10   | 7           | 10   | 10   | 7          | 10   | 10   | 7          | 10   | 10   |
| Y+R:   | 4.0         | 4.0  | 4.0  | 4.0         | 4.0  | 4.0  | 4.0        | 4.0  | 4.0  | 4.0        | 4.0  | 4.0  |
| Volume Module: >> Count Date: 21 May 2015 << 7:45-8:45AM |             |      |      |             |      |      |            |      |      |            |      |      |
| Base Vol:  | 92          | 751  | 261  | 90          | 425  | 59   | 87         | 360  | 112  | 172        | 359  | 187  |
| Growth Adj:  | 1.00        | 1.00 | 1.00 | 1.00        | 1.00 | 1.00 | 1.00       | 1.00 | 1.00 | 1.00       | 1.00 | 1.00 |
| Initial Bse:   | 92          | 751  | 261  | 90          | 425  | 59   | 87         | 360  | 112  | 172        | 359  | 187  |
| Added Vol:   | 0           | 0    | 0    | 0           | 0    | 0    | 0          | 0    | 0    | 0          | 0    | 0    |
| PasserByVol:   | 0           | 0    | 0    | 0           | 0    | 0    | 0          | 0    | 0    | 0          | 0    | 0    |
| Initial Fut:   | 92          | 751  | 261  | 90          | 425  | 59   | 87         | 360  | 112  | 172        | 359  | 187  |
| User Adj:  | 1.00        | 1.00 | 1.00 | 1.00        | 1.00 | 1.00 | 1.00       | 1.00 | 1.00 | 1.00       | 1.00 | 1.00 |
| PHF Adj:   | 1.00        | 1.00 | 1.00 | 1.00        | 1.00 | 1.00 | 1.00       | 1.00 | 1.00 | 1.00       | 1.00 | 1.00 |
| PHF Volume:  | 92          | 751  | 261  | 90          | 425  | 59   | 87         | 360  | 112  | 172        | 359  | 187  |
| Reduct Vol:  | 0           | 0    | 0    | 0           | 0    | 0    | 0          | 0    | 0    | 0          | 0    | 0    |
| Reduced Vol:   | 92          | 751  | 261  | 90          | 425  | 59   | 87         | 360  | 112  | 172        | 359  | 187  |
| PCE Adj:   | 1.00        | 1.00 | 1.00 | 1.00        | 1.00 | 1.00 | 1.00       | 1.00 | 1.00 | 1.00       | 1.00 | 1.00 |
| MLF Adj:   | 1.00        | 1.00 | 1.00 | 1.00        | 1.00 | 1.00 | 1.00       | 1.00 | 1.00 | 1.00       | 1.00 | 1.00 |
| FinalVolume:   | 92          | 751  | 261  | 90          | 425  | 59   | 87         | 360  | 112  | 172        | 359  | 187  |
| Saturation Flow Module:                                  |             |      |      |             |      |      |            |      |      |            |      |      |
| Sat/Lane:  | 1900        | 1900 | 1900 | 1900        | 1900 | 1900 | 1900       | 1900 | 1900 | 1900       | 1900 | 1900 |
| Adjustment:  | 0.92        | 0.98 | 0.95 | 0.92        | 1.00 | 0.92 | 0.92       | 0.98 | 0.95 | 0.92       | 0.99 | 0.95 |
| Lanes:   | 1.00        | 1.47 | 0.53 | 1.00        | 2.00 | 1.00 | 1.00       | 1.51 | 0.49 | 1.00       | 1.30 | 0.70 |
| Final Sat.:  | 1750        | 2745 | 954  | 1750        | 3800 | 1750 | 1750       | 2821 | 878  | 1750       | 2432 | 1267 |
| Capacity Analysis Module:                                |             |      |      |             |      |      |            |      |      |            |      |      |
| Vol/Sat:   | 0.05        | 0.27 | 0.27 | 0.05        | 0.11 | 0.03 | 0.05       | 0.13 | 0.13 | 0.10       | 0.15 | 0.15 |
| Crit Moves:  | ****        | **** | **** | ****        | **** | **** | ****       | **** | **** | ****       | **** | **** |
| Green Time:  | 22.6        | 58.6 | 58.6 | 11.0        | 47.0 | 47.0 | 12.9       | 27.3 | 27.3 | 21.1       | 35.5 | 35.5 |
| Volume/Cap:  | 0.30        | 0.61 | 0.61 | 0.61        | 0.31 | 0.09 | 0.50       | 0.61 | 0.61 | 0.61       | 0.54 | 0.54 |
| Delay/Veh:   | 47.4        | 27.6 | 27.6 | 64.5        | 30.0 | 27.5 | 57.7       | 47.9 | 47.9 | 54.4       | 40.9 | 40.9 |
| User DelAdj:   | 1.00        | 1.00 | 1.00 | 1.00        | 1.00 | 1.00 | 1.00       | 1.00 | 1.00 | 1.00       | 1.00 | 1.00 |
| AdjDel/Veh:  | 47.4        | 27.6 | 27.6 | 64.5        | 30.0 | 27.5 | 57.7       | 47.9 | 47.9 | 54.4       | 40.9 | 40.9 |
| LOS by Move:   | D           | C    | C    | E           | C    | C    | E          | D    | D    | D          | D    | D    |
| HCM2k95thQ:  | 7           | 27   | 27   | 9           | 12   | 3    | 7          | 16   | 16   | 13         | 17   | 17   |

Note: Queue reported is the number of cars per lane.



BART

Level Of Service Computation Report  
 2000 HCM Operations (Future Volume Alternative)  
 PM - Existing Conditions

Intersection #3063: ALUM ROCK/JACKSON [Study Int 18]

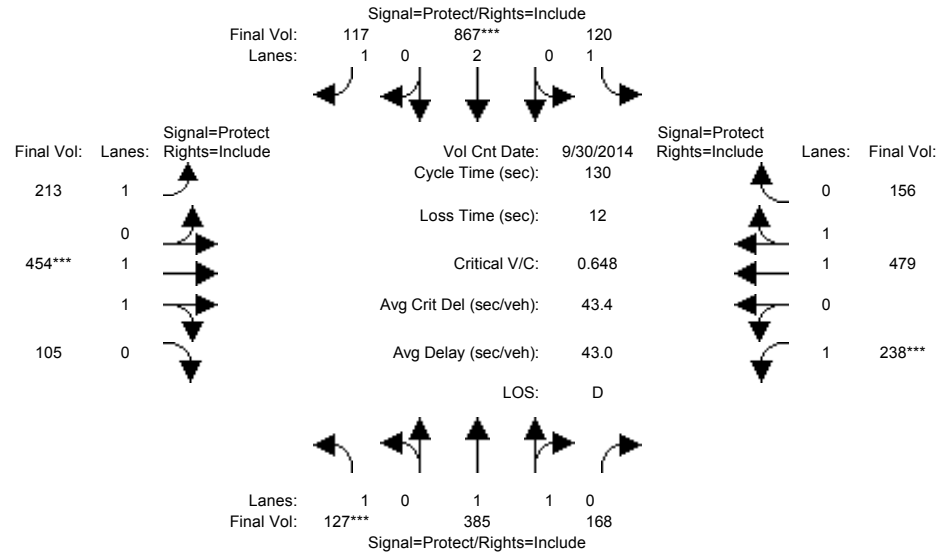

| Approach:  | North Bound |      |      | South Bound |      |      | East Bound |      |      | West Bound |      |      |
|--|-------------|------|------|-------------|------|------|------------|------|------|------------|------|------|
| Movement:  | L           | T    | R    | L           | T    | R    | L          | T    | R    | L          | T    | R    |
| Min. Green:  | 7           | 10   | 10   | 7           | 10   | 10   | 7          | 10   | 10   | 7          | 10   | 10   |
| Y+R:   | 4.0         | 4.0  | 4.0  | 4.0         | 4.0  | 4.0  | 4.0        | 4.0  | 4.0  | 4.0        | 4.0  | 4.0  |
| Volume Module: >> Count Date: 30 Sep 2014 << 4:15-5:15PM |             |      |      |             |      |      |            |      |      |            |      |      |
| Base Vol:  | 127         | 385  | 168  | 120         | 867  | 117  | 213        | 454  | 105  | 238        | 479  | 156  |
| Growth Adj:  | 1.00        | 1.00 | 1.00 | 1.00        | 1.00 | 1.00 | 1.00       | 1.00 | 1.00 | 1.00       | 1.00 | 1.00 |
| Initial Bse:   | 127         | 385  | 168  | 120         | 867  | 117  | 213        | 454  | 105  | 238        | 479  | 156  |
| Added Vol:   | 0           | 0    | 0    | 0           | 0    | 0    | 0          | 0    | 0    | 0          | 0    | 0    |
| PasserByVol:   | 0           | 0    | 0    | 0           | 0    | 0    | 0          | 0    | 0    | 0          | 0    | 0    |
| Initial Fut:   | 127         | 385  | 168  | 120         | 867  | 117  | 213        | 454  | 105  | 238        | 479  | 156  |
| User Adj:  | 1.00        | 1.00 | 1.00 | 1.00        | 1.00 | 1.00 | 1.00       | 1.00 | 1.00 | 1.00       | 1.00 | 1.00 |
| PHF Adj:   | 1.00        | 1.00 | 1.00 | 1.00        | 1.00 | 1.00 | 1.00       | 1.00 | 1.00 | 1.00       | 1.00 | 1.00 |
| PHF Volume:  | 127         | 385  | 168  | 120         | 867  | 117  | 213        | 454  | 105  | 238        | 479  | 156  |
| Reduct Vol:  | 0           | 0    | 0    | 0           | 0    | 0    | 0          | 0    | 0    | 0          | 0    | 0    |
| Reduced Vol:   | 127         | 385  | 168  | 120         | 867  | 117  | 213        | 454  | 105  | 238        | 479  | 156  |
| PCE Adj:   | 1.00        | 1.00 | 1.00 | 1.00        | 1.00 | 1.00 | 1.00       | 1.00 | 1.00 | 1.00       | 1.00 | 1.00 |
| MLF Adj:   | 1.00        | 1.00 | 1.00 | 1.00        | 1.00 | 1.00 | 1.00       | 1.00 | 1.00 | 1.00       | 1.00 | 1.00 |
| Final Volume:  | 127         | 385  | 168  | 120         | 867  | 117  | 213        | 454  | 105  | 238        | 479  | 156  |
| Saturation Flow Module:                                  |             |      |      |             |      |      |            |      |      |            |      |      |
| Sat/Lane:  | 1900        | 1900 | 1900 | 1900        | 1900 | 1900 | 1900       | 1900 | 1900 | 1900       | 1900 | 1900 |
| Adjustment:  | 0.92        | 0.99 | 0.95 | 0.92        | 1.00 | 0.92 | 0.92       | 0.98 | 0.95 | 0.92       | 0.98 | 0.95 |
| Lanes:   | 1.00        | 1.38 | 0.62 | 1.00        | 2.00 | 1.00 | 1.00       | 1.61 | 0.39 | 1.00       | 1.50 | 0.50 |
| Final Sat.:  | 1750        | 2575 | 1124 | 1750        | 3800 | 1750 | 1750       | 3004 | 695  | 1750       | 2790 | 909  |
| Capacity Analysis Module:                                |             |      |      |             |      |      |            |      |      |            |      |      |
| Vol/Sat:   | 0.07        | 0.15 | 0.15 | 0.07        | 0.23 | 0.07 | 0.12       | 0.15 | 0.15 | 0.14       | 0.17 | 0.17 |
| Crit Moves:  | ****        |      |      | ****        |      |      | ****       |      |      | ****       |      |      |
| Green Time:  | 14.6        | 41.4 | 41.4 | 19.0        | 45.8 | 45.8 | 23.9       | 30.3 | 30.3 | 27.3       | 33.7 | 33.7 |
| Volume/Cap:  | 0.65        | 0.47 | 0.47 | 0.47        | 0.65 | 0.19 | 0.66       | 0.65 | 0.65 | 0.65       | 0.66 | 0.66 |
| Delay/Veh:   | 62.6        | 35.8 | 35.8 | 52.3        | 36.4 | 29.4 | 54.4       | 46.7 | 46.7 | 51.0       | 44.8 | 44.8 |
| User DelAdj:   | 1.00        | 1.00 | 1.00 | 1.00        | 1.00 | 1.00 | 1.00       | 1.00 | 1.00 | 1.00       | 1.00 | 1.00 |
| AdjDel/Veh:  | 62.6        | 35.8 | 35.8 | 52.3        | 36.4 | 29.4 | 54.4       | 46.7 | 46.7 | 51.0       | 44.8 | 44.8 |
| LOS by Move:   | E           | D    | D    | D           | D    | C    | D          | D    | D    | D          | D    | D    |
| HCM2k95thQ:  | 12          | 17   | 17   | 10          | 26   | 7    | 16         | 19   | 19   | 17         | 21   | 21   |

Note: Queue reported is the number of cars per lane.

BART

Level Of Service Computation Report  
 2000 HCM Operations (Future Volume Alternative)  
 AM - Existing Conditions

Intersection #3064: ALUM ROCK/KING [Study Int 17]

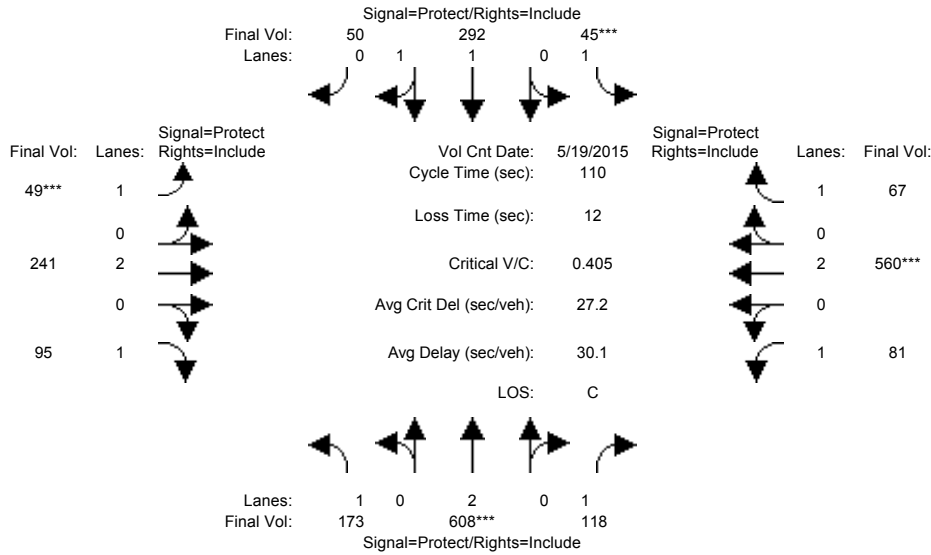

| Approach:  | North Bound |      |      | South Bound |      |      | East Bound |      |      | West Bound |      |      |
|--|-------------|------|------|-------------|------|------|------------|------|------|------------|------|------|
| Movement:  | L           | T    | R    | L           | T    | R    | L          | T    | R    | L          | T    | R    |
| Min. Green:  | 7           | 10   | 10   | 7           | 10   | 10   | 7          | 10   | 10   | 7          | 10   | 10   |
| Y+R:   | 4.0         | 4.0  | 4.0  | 4.0         | 4.0  | 4.0  | 4.0        | 4.0  | 4.0  | 4.0        | 4.0  | 4.0  |
| Volume Module: >> Count Date: 19 May 2015 << 7:45-8:45AM |             |      |      |             |      |      |            |      |      |            |      |      |
| Base Vol:  | 173         | 608  | 118  | 45          | 292  | 50   | 49         | 241  | 95   | 81         | 560  | 67   |
| Growth Adj:  | 1.00        | 1.00 | 1.00 | 1.00        | 1.00 | 1.00 | 1.00       | 1.00 | 1.00 | 1.00       | 1.00 | 1.00 |
| Initial Bse:   | 173         | 608  | 118  | 45          | 292  | 50   | 49         | 241  | 95   | 81         | 560  | 67   |
| Added Vol:   | 0           | 0    | 0    | 0           | 0    | 0    | 0          | 0    | 0    | 0          | 0    | 0    |
| PasserByVol:   | 0           | 0    | 0    | 0           | 0    | 0    | 0          | 0    | 0    | 0          | 0    | 0    |
| Initial Fut:   | 173         | 608  | 118  | 45          | 292  | 50   | 49         | 241  | 95   | 81         | 560  | 67   |
| User Adj:  | 1.00        | 1.00 | 1.00 | 1.00        | 1.00 | 1.00 | 1.00       | 1.00 | 1.00 | 1.00       | 1.00 | 1.00 |
| PHF Adj:   | 1.00        | 1.00 | 1.00 | 1.00        | 1.00 | 1.00 | 1.00       | 1.00 | 1.00 | 1.00       | 1.00 | 1.00 |
| PHF Volume:  | 173         | 608  | 118  | 45          | 292  | 50   | 49         | 241  | 95   | 81         | 560  | 67   |
| Reduct Vol:  | 0           | 0    | 0    | 0           | 0    | 0    | 0          | 0    | 0    | 0          | 0    | 0    |
| Reduced Vol:   | 173         | 608  | 118  | 45          | 292  | 50   | 49         | 241  | 95   | 81         | 560  | 67   |
| PCE Adj:   | 1.00        | 1.00 | 1.00 | 1.00        | 1.00 | 1.00 | 1.00       | 1.00 | 1.00 | 1.00       | 1.00 | 1.00 |
| MLF Adj:   | 1.00        | 1.00 | 1.00 | 1.00        | 1.00 | 1.00 | 1.00       | 1.00 | 1.00 | 1.00       | 1.00 | 1.00 |
| Final Volume:  | 173         | 608  | 118  | 45          | 292  | 50   | 49         | 241  | 95   | 81         | 560  | 67   |
| Saturation Flow Module:                                  |             |      |      |             |      |      |            |      |      |            |      |      |
| Sat/Lane:  | 1900        | 1900 | 1900 | 1900        | 1900 | 1900 | 1900       | 1900 | 1900 | 1900       | 1900 | 1900 |
| Adjustment:  | 0.92        | 1.00 | 0.92 | 0.92        | 0.98 | 0.95 | 0.92       | 1.00 | 0.92 | 0.92       | 1.00 | 0.92 |
| Lanes:   | 1.00        | 2.00 | 1.00 | 1.00        | 1.70 | 0.30 | 1.00       | 2.00 | 1.00 | 1.00       | 2.00 | 1.00 |
| Final Sat.:  | 1750        | 3800 | 1750 | 1750        | 3159 | 541  | 1750       | 3800 | 1750 | 1750       | 3800 | 1750 |
| Capacity Analysis Module:                                |             |      |      |             |      |      |            |      |      |            |      |      |
| Vol/Sat:   | 0.10        | 0.16 | 0.07 | 0.03        | 0.09 | 0.09 | 0.03       | 0.06 | 0.05 | 0.05       | 0.15 | 0.04 |
| Crit Moves:  | ****        | **** | **** | ****        | **** | **** | ****       | **** | **** | ****       | **** | **** |
| Green Time:  | 26.1        | 43.4 | 43.4 | 7.0         | 24.4 | 24.4 | 7.6        | 28.0 | 28.0 | 19.6       | 40.0 | 40.0 |
| Volume/Cap:  | 0.42        | 0.41 | 0.17 | 0.40        | 0.42 | 0.42 | 0.41       | 0.25 | 0.21 | 0.26       | 0.41 | 0.11 |
| Delay/Veh:   | 36.2        | 24.2 | 21.7 | 51.9        | 37.1 | 37.1 | 51.3       | 32.8 | 32.6 | 39.4       | 26.3 | 23.2 |
| User DelAdj:   | 1.00        | 1.00 | 1.00 | 1.00        | 1.00 | 1.00 | 1.00       | 1.00 | 1.00 | 1.00       | 1.00 | 1.00 |
| AdjDel/Veh:  | 36.2        | 24.2 | 21.7 | 51.9        | 37.1 | 37.1 | 51.3       | 32.8 | 32.6 | 39.4       | 26.3 | 23.2 |
| LOS by Move:   | D           | C    | C    | D           | D    | D    | D          | C    | C    | D          | C    | C    |
| HCM2k95thQ:  | 10          | 14   | 5    | 3           | 10   | 10   | 4          | 6    | 5    | 5          | 13   | 3    |

Note: Queue reported is the number of cars per lane.

BART

Level Of Service Computation Report  
 2000 HCM Operations (Future Volume Alternative)  
 PM - Existing Conditions

Intersection #3064: ALUM ROCK/KING [Study Int 17]

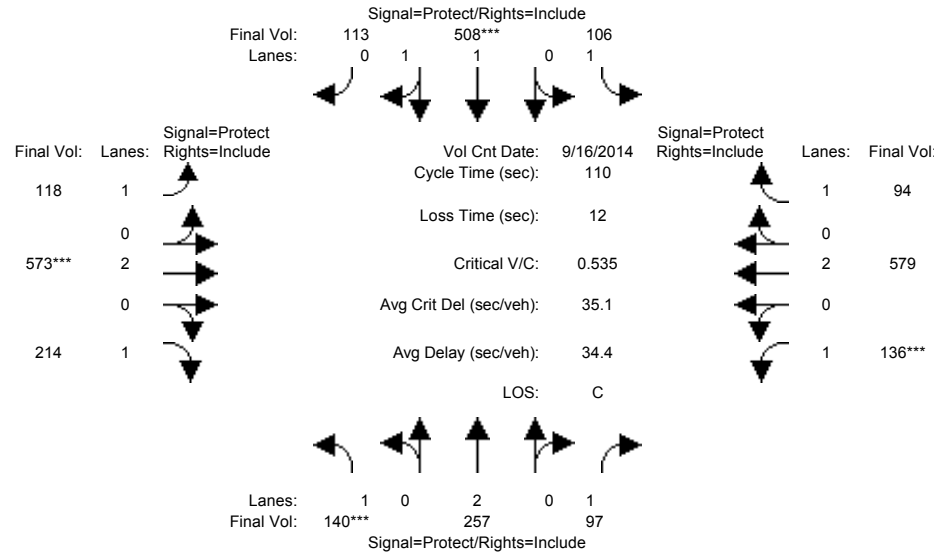

| Approach:   | North Bound |      |      | South Bound |      |      | East Bound |      |      | West Bound |      |      |
|---|-------------|------|------|-------------|------|------|------------|------|------|------------|------|------|
| Movement:   | L           | T    | R    | L           | T    | R    | L          | T    | R    | L          | T    | R    |
| Min. Green:   | 7           | 10   | 10   | 7           | 10   | 10   | 7          | 10   | 10   | 7          | 10   | 10   |
| Y+R:  | 4.0         | 4.0  | 4.0  | 4.0         | 4.0  | 4.0  | 4.0        | 4.0  | 4.0  | 4.0        | 4.0  | 4.0  |
| Volume Module: >> Count Date: 16 Sep 2014 << 5:00 - 6:00 PM |             |      |      |             |      |      |            |      |      |            |      |      |
| Base Vol:   | 140         | 257  | 97   | 106         | 508  | 113  | 118        | 573  | 214  | 136        | 579  | 94   |
| Growth Adj:   | 1.00        | 1.00 | 1.00 | 1.00        | 1.00 | 1.00 | 1.00       | 1.00 | 1.00 | 1.00       | 1.00 | 1.00 |
| Initial Bse:  | 140         | 257  | 97   | 106         | 508  | 113  | 118        | 573  | 214  | 136        | 579  | 94   |
| Added Vol:  | 0           | 0    | 0    | 0           | 0    | 0    | 0          | 0    | 0    | 0          | 0    | 0    |
| PasserByVol:  | 0           | 0    | 0    | 0           | 0    | 0    | 0          | 0    | 0    | 0          | 0    | 0    |
| Initial Fut:  | 140         | 257  | 97   | 106         | 508  | 113  | 118        | 573  | 214  | 136        | 579  | 94   |
| User Adj:   | 1.00        | 1.00 | 1.00 | 1.00        | 1.00 | 1.00 | 1.00       | 1.00 | 1.00 | 1.00       | 1.00 | 1.00 |
| PHF Adj:  | 1.00        | 1.00 | 1.00 | 1.00        | 1.00 | 1.00 | 1.00       | 1.00 | 1.00 | 1.00       | 1.00 | 1.00 |
| PHF Volume:   | 140         | 257  | 97   | 106         | 508  | 113  | 118        | 573  | 214  | 136        | 579  | 94   |
| Reduct Vol:   | 0           | 0    | 0    | 0           | 0    | 0    | 0          | 0    | 0    | 0          | 0    | 0    |
| Reduced Vol:  | 140         | 257  | 97   | 106         | 508  | 113  | 118        | 573  | 214  | 136        | 579  | 94   |
| PCE Adj:  | 1.00        | 1.00 | 1.00 | 1.00        | 1.00 | 1.00 | 1.00       | 1.00 | 1.00 | 1.00       | 1.00 | 1.00 |
| MLF Adj:  | 1.00        | 1.00 | 1.00 | 1.00        | 1.00 | 1.00 | 1.00       | 1.00 | 1.00 | 1.00       | 1.00 | 1.00 |
| Final Volume:   | 140         | 257  | 97   | 106         | 508  | 113  | 118        | 573  | 214  | 136        | 579  | 94   |
| Saturation Flow Module:                                     |             |      |      |             |      |      |            |      |      |            |      |      |
| Sat/Lane:   | 1900        | 1900 | 1900 | 1900        | 1900 | 1900 | 1900       | 1900 | 1900 | 1900       | 1900 | 1900 |
| Adjustment:   | 0.92        | 1.00 | 0.92 | 0.92        | 0.98 | 0.95 | 0.92       | 1.00 | 0.92 | 0.92       | 1.00 | 0.92 |
| Lanes:  | 1.00        | 2.00 | 1.00 | 1.00        | 1.63 | 0.37 | 1.00       | 2.00 | 1.00 | 1.00       | 2.00 | 1.00 |
| Final Sat.:   | 1750        | 3800 | 1750 | 1750        | 3026 | 673  | 1750       | 3800 | 1750 | 1750       | 3800 | 1750 |
| Capacity Analysis Module:                                   |             |      |      |             |      |      |            |      |      |            |      |      |
| Vol/Sat:  | 0.08        | 0.07 | 0.06 | 0.06        | 0.17 | 0.17 | 0.07       | 0.15 | 0.12 | 0.08       | 0.15 | 0.05 |
| Crit Moves:   | ****        |      |      | ****        |      |      | ****       |      |      | ****       |      |      |
| Green Time:   | 16.5        | 30.0 | 30.0 | 21.0        | 34.5 | 34.5 | 14.4       | 31.0 | 31.0 | 16.0       | 32.6 | 32.6 |
| Volume/Cap:   | 0.53        | 0.25 | 0.20 | 0.32        | 0.53 | 0.53 | 0.51       | 0.53 | 0.43 | 0.53       | 0.51 | 0.18 |
| Delay/Veh:  | 45.4        | 31.3 | 31.0 | 38.9        | 31.6 | 31.6 | 46.5       | 33.9 | 32.9 | 45.8       | 32.5 | 29.0 |
| User DelAdj:  | 1.00        | 1.00 | 1.00 | 1.00        | 1.00 | 1.00 | 1.00       | 1.00 | 1.00 | 1.00       | 1.00 | 1.00 |
| AdjDel/Veh:   | 45.4        | 31.3 | 31.0 | 38.9        | 31.6 | 31.6 | 46.5       | 33.9 | 32.9 | 45.8       | 32.5 | 29.0 |
| LOS by Move:  | D           | C    | C    | D           | C    | C    | D          | C    | C    | D          | C    | C    |
| HCM2k95thQ:   | 9           | 6    | 5    | 6           | 16   | 16   | 8          | 15   | 12   | 10         | 16   | 5    |

Note: Queue reported is the number of cars per lane.

BART

Level Of Service Computation Report  
 2000 HCM Operations (Future Volume Alternative)  
 AM - Existing Conditions

Intersection #3210: 101/Julian-McKee (W) [Study Int 4]

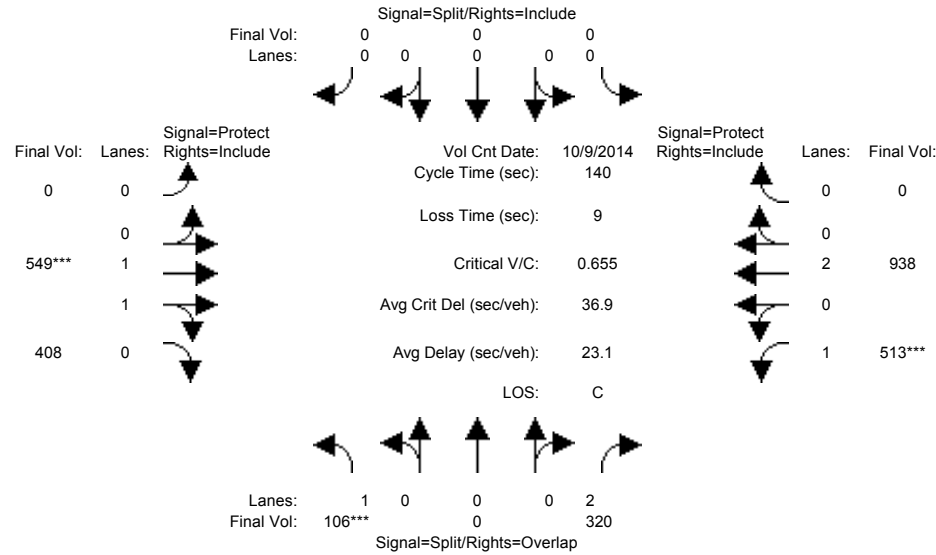

| Approach:                     | North Bound   |      |      | South Bound |      |      | East Bound |      |      | West Bound |      |      |
|-------------------------------|---------------|------|------|-------------|------|------|------------|------|------|------------|------|------|
| Movement:                     | L             | T    | R    | L           | T    | R    | L          | T    | R    | L          | T    | R    |
| Min. Green:                   | 10            | 0    | 10   | 0           | 0    | 0    | 0          | 10   | 10   | 7          | 10   | 0    |
| Y+R:                          | 4.0           | 4.0  | 4.0  | 4.0         | 4.0  | 4.0  | 4.0        | 4.0  | 4.0  | 4.0        | 4.0  | 4.0  |
| -----                         |               |      |      |             |      |      |            |      |      |            |      |      |
| Volume Module: >> Count Date: | 9 Oct 2014 << |      |      |             |      |      |            |      |      |            |      |      |
| Base Vol:                     | 106           | 0    | 320  | 0           | 0    | 0    | 0          | 549  | 408  | 513        | 938  | 0    |
| Growth Adj:                   | 1.00          | 1.00 | 1.00 | 1.00        | 1.00 | 1.00 | 1.00       | 1.00 | 1.00 | 1.00       | 1.00 | 1.00 |
| Initial Bse:                  | 106           | 0    | 320  | 0           | 0    | 0    | 0          | 549  | 408  | 513        | 938  | 0    |
| Added Vol:                    | 0             | 0    | 0    | 0           | 0    | 0    | 0          | 0    | 0    | 0          | 0    | 0    |
| PasserByVol:                  | 0             | 0    | 0    | 0           | 0    | 0    | 0          | 0    | 0    | 0          | 0    | 0    |
| Initial Fut:                  | 106           | 0    | 320  | 0           | 0    | 0    | 0          | 549  | 408  | 513        | 938  | 0    |
| User Adj:                     | 1.00          | 1.00 | 1.00 | 1.00        | 1.00 | 1.00 | 1.00       | 1.00 | 1.00 | 1.00       | 1.00 | 1.00 |
| PHF Adj:                      | 1.00          | 1.00 | 1.00 | 1.00        | 1.00 | 1.00 | 1.00       | 1.00 | 1.00 | 1.00       | 1.00 | 1.00 |
| PHF Volume:                   | 106           | 0    | 320  | 0           | 0    | 0    | 0          | 549  | 408  | 513        | 938  | 0    |
| Reduct Vol:                   | 0             | 0    | 0    | 0           | 0    | 0    | 0          | 0    | 0    | 0          | 0    | 0    |
| Reduced Vol:                  | 106           | 0    | 320  | 0           | 0    | 0    | 0          | 549  | 408  | 513        | 938  | 0    |
| PCE Adj:                      | 1.00          | 1.00 | 1.00 | 1.00        | 1.00 | 1.00 | 1.00       | 1.00 | 1.00 | 1.00       | 1.00 | 1.00 |
| MLF Adj:                      | 1.00          | 1.00 | 1.00 | 1.00        | 1.00 | 1.00 | 1.00       | 1.00 | 1.00 | 1.00       | 1.00 | 1.00 |
| FinalVolume:                  | 106           | 0    | 320  | 0           | 0    | 0    | 0          | 549  | 408  | 513        | 938  | 0    |
| -----                         |               |      |      |             |      |      |            |      |      |            |      |      |
| Saturation Flow Module:       |               |      |      |             |      |      |            |      |      |            |      |      |
| Sat/Lane:                     | 1900          | 1900 | 1900 | 1900        | 1900 | 1900 | 1900       | 1900 | 1900 | 1900       | 1900 | 1900 |
| Adjustment:                   | 0.92          | 1.00 | 0.83 | 0.92        | 1.00 | 0.92 | 0.92       | 0.99 | 0.95 | 0.92       | 1.00 | 0.92 |
| Lanes:                        | 1.00          | 0.00 | 2.00 | 0.00        | 0.00 | 0.00 | 0.00       | 1.12 | 0.88 | 1.00       | 2.00 | 0.00 |
| Final Sat.:                   | 1750          | 0    | 3150 | 0           | 0    | 0    | 0          | 2121 | 1577 | 1750       | 3800 | 0    |
| -----                         |               |      |      |             |      |      |            |      |      |            |      |      |
| Capacity Analysis Module:     |               |      |      |             |      |      |            |      |      |            |      |      |
| Vol/Sat:                      | 0.06          | 0.00 | 0.10 | 0.00        | 0.00 | 0.00 | 0.00       | 0.26 | 0.26 | 0.29       | 0.25 | 0.00 |
| Crit Moves:                   | ****          |      |      |             |      |      | ****       |      |      | ****       |      |      |
| Green Time:                   | 13.0          | 0.0  | 75.7 | 0.0         | 0.0  | 0.0  | 0.0        | 55.3 | 55.3 | 62.7       | 118  | 0.0  |
| Volume/Cap:                   | 0.65          | 0.00 | 0.19 | 0.00        | 0.00 | 0.00 | 0.00       | 0.65 | 0.65 | 0.65       | 0.29 | 0.00 |
| Delay/Veh:                    | 70.7          | 0.0  | 16.5 | 0.0         | 0.0  | 0.0  | 0.0        | 35.6 | 35.6 | 32.2       | 2.3  | 0.0  |
| User DelAdj:                  | 1.00          | 1.00 | 1.00 | 1.00        | 1.00 | 1.00 | 1.00       | 1.00 | 1.00 | 1.00       | 1.00 | 1.00 |
| AdjDel/Veh:                   | 70.7          | 0.0  | 16.5 | 0.0         | 0.0  | 0.0  | 0.0        | 35.6 | 35.6 | 32.2       | 2.3  | 0.0  |
| LOS by Move:                  | E             | A    | B    | A           | A    | A    | A          | D    | D    | C          | A    | A    |
| HCM2k95thQ:                   | 11            | 0    | 8    | 0           | 0    | 0    | 0          | 29   | 29   | 32         | 8    | 0    |

Note: Queue reported is the number of cars per lane.

BART

Level Of Service Computation Report  
2000 HCM Operations (Future Volume Alternative)  
PM - Existing Conditions

Intersection #3210: 101/Julian-McKee (W) [Study Int 4]

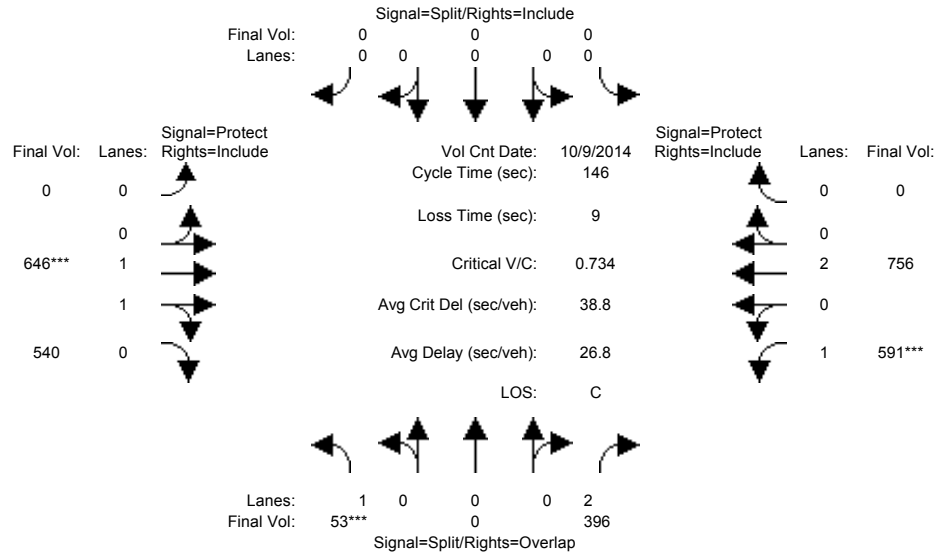

| Approach:                                   | North Bound |      |      | South Bound |      |      | East Bound |      |      | West Bound |      |      |
|---|-------------|------|------|-------------|------|------|------------|------|------|------------|------|------|
| Movement:                                   | L           | T    | R    | L           | T    | R    | L          | T    | R    | L          | T    | R    |
| Min. Green:                                 | 10          | 0    | 10   | 0           | 0    | 0    | 0          | 10   | 10   | 7          | 10   | 0    |
| Y+R:  | 4.0         | 4.0  | 4.0  | 4.0         | 4.0  | 4.0  | 4.0        | 4.0  | 4.0  | 4.0        | 4.0  | 4.0  |
| Volume Module: >> Count Date: 9 Oct 2014 << |             |      |      |             |      |      |            |      |      |            |      |      |
| Base Vol:                                   | 53          | 0    | 396  | 0           | 0    | 0    | 0          | 646  | 540  | 591        | 756  | 0    |
| Growth Adj:                                 | 1.00        | 1.00 | 1.00 | 1.00        | 1.00 | 1.00 | 1.00       | 1.00 | 1.00 | 1.00       | 1.00 | 1.00 |
| Initial Bse:                                | 53          | 0    | 396  | 0           | 0    | 0    | 0          | 646  | 540  | 591        | 756  | 0    |
| Added Vol:                                  | 0           | 0    | 0    | 0           | 0    | 0    | 0          | 0    | 0    | 0          | 0    | 0    |
| PasserByVol:                                | 0           | 0    | 0    | 0           | 0    | 0    | 0          | 0    | 0    | 0          | 0    | 0    |
| Initial Fut:                                | 53          | 0    | 396  | 0           | 0    | 0    | 0          | 646  | 540  | 591        | 756  | 0    |
| User Adj:                                   | 1.00        | 1.00 | 1.00 | 1.00        | 1.00 | 1.00 | 1.00       | 1.00 | 1.00 | 1.00       | 1.00 | 1.00 |
| PHF Adj:                                    | 1.00        | 1.00 | 1.00 | 1.00        | 1.00 | 1.00 | 1.00       | 1.00 | 1.00 | 1.00       | 1.00 | 1.00 |
| PHF Volume:                                 | 53          | 0    | 396  | 0           | 0    | 0    | 0          | 646  | 540  | 591        | 756  | 0    |
| Reduct Vol:                                 | 0           | 0    | 0    | 0           | 0    | 0    | 0          | 0    | 0    | 0          | 0    | 0    |
| Reduced Vol:                                | 53          | 0    | 396  | 0           | 0    | 0    | 0          | 646  | 540  | 591        | 756  | 0    |
| PCE Adj:                                    | 1.00        | 1.00 | 1.00 | 1.00        | 1.00 | 1.00 | 1.00       | 1.00 | 1.00 | 1.00       | 1.00 | 1.00 |
| MLF Adj:                                    | 1.00        | 1.00 | 1.00 | 1.00        | 1.00 | 1.00 | 1.00       | 1.00 | 1.00 | 1.00       | 1.00 | 1.00 |
| FinalVolume:                                | 53          | 0    | 396  | 0           | 0    | 0    | 0          | 646  | 540  | 591        | 756  | 0    |
| Saturation Flow Module:                     |             |      |      |             |      |      |            |      |      |            |      |      |
| Sat/Lane:                                   | 1900        | 1900 | 1900 | 1900        | 1900 | 1900 | 1900       | 1900 | 1900 | 1900       | 1900 | 1900 |
| Adjustment:                                 | 0.92        | 1.00 | 0.83 | 0.92        | 1.00 | 0.92 | 0.92       | 1.00 | 0.95 | 0.92       | 1.00 | 0.92 |
| Lanes:                                      | 1.00        | 0.00 | 2.00 | 0.00        | 0.00 | 0.00 | 0.00       | 1.06 | 0.94 | 1.00       | 2.00 | 0.00 |
| Final Sat.:                                 | 1750        | 0    | 3150 | 0           | 0    | 0    | 0          | 2014 | 1684 | 1750       | 3800 | 0    |
| Capacity Analysis Module:                   |             |      |      |             |      |      |            |      |      |            |      |      |
| Vol/Sat:                                    | 0.03        | 0.00 | 0.13 | 0.00        | 0.00 | 0.00 | 0.00       | 0.32 | 0.32 | 0.34       | 0.20 | 0.00 |
| Crit Moves:                                 | ****        |      |      |             |      |      |            | **** |      | ****       |      |      |
| Green Time:                                 | 10.0        | 0.0  | 75.1 | 0.0         | 0.0  | 0.0  | 0.0        | 61.9 | 61.9 | 65.1       | 127  | 0.0  |
| Volume/Cap:                                 | 0.44        | 0.00 | 0.24 | 0.00        | 0.00 | 0.00 | 0.00       | 0.76 | 0.76 | 0.76       | 0.23 | 0.00 |
| Delay/Veh:                                  | 67.9        | 0.0  | 19.7 | 0.0         | 0.0  | 0.0  | 0.0        | 37.9 | 37.9 | 38.1       | 1.6  | 0.0  |
| User DelAdj:                                | 1.00        | 1.00 | 1.00 | 1.00        | 1.00 | 1.00 | 1.00       | 1.00 | 1.00 | 1.00       | 1.00 | 1.00 |
| AdjDel/Veh:                                 | 67.9        | 0.0  | 19.7 | 0.0         | 0.0  | 0.0  | 0.0        | 37.9 | 37.9 | 38.1       | 1.6  | 0.0  |
| LOS by Move:                                | E           | A    | B    | A           | A    | A    | A          | D    | D    | D          | A    | A    |
| HCM2k95thQ:                                 | 6           | 0    | 11   | 0           | 0    | 0    | 0          | 39   | 39   | 41         | 6    | 0    |

Note: Queue reported is the number of cars per lane.

BART

Level Of Service Computation Report  
 2000 HCM Operations (Future Volume Alternative)  
 AM - Existing Conditions

Intersection #3211: 101/McKee(E) [Study Int 5]

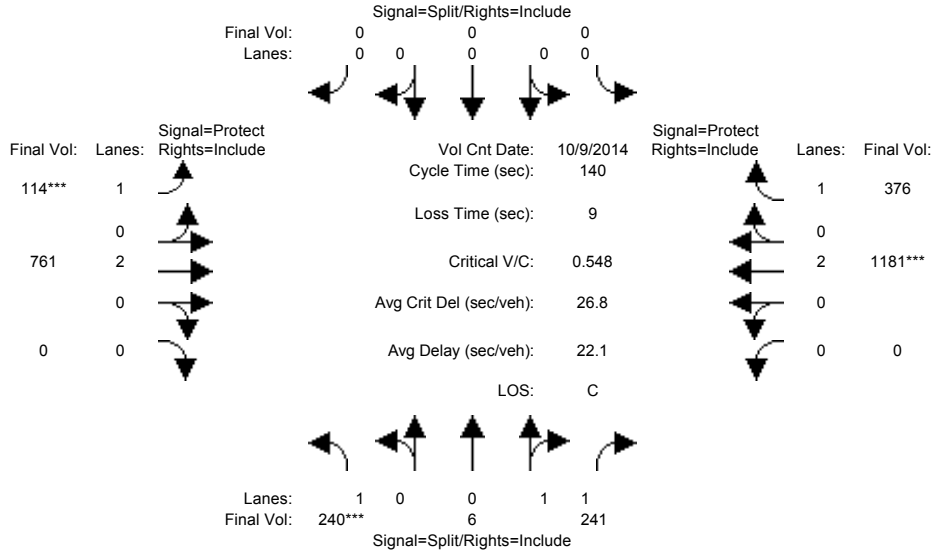

| Approach:                                   | North Bound |      |      | South Bound |      |      | East Bound |      |      | West Bound |      |      |
|---|-------------|------|------|-------------|------|------|------------|------|------|------------|------|------|
| Movement:                                   | L           | T    | R    | L           | T    | R    | L          | T    | R    | L          | T    | R    |
| Min. Green:                                 | 10          | 10   | 10   | 0           | 0    | 0    | 7          | 10   | 0    | 0          | 10   | 10   |
| Y+R:  | 4.0         | 4.0  | 4.0  | 4.0         | 4.0  | 4.0  | 4.0        | 4.0  | 4.0  | 4.0        | 4.0  | 4.0  |
| Volume Module: >> Count Date: 9 Oct 2014 << |             |      |      |             |      |      |            |      |      |            |      |      |
| Base Vol:                                   | 240         | 6    | 241  | 0           | 0    | 0    | 114        | 761  | 0    | 0          | 1181 | 376  |
| Growth Adj:                                 | 1.00        | 1.00 | 1.00 | 1.00        | 1.00 | 1.00 | 1.00       | 1.00 | 1.00 | 1.00       | 1.00 | 1.00 |
| Initial Bse:                                | 240         | 6    | 241  | 0           | 0    | 0    | 114        | 761  | 0    | 0          | 1181 | 376  |
| Added Vol:                                  | 0           | 0    | 0    | 0           | 0    | 0    | 0          | 0    | 0    | 0          | 0    | 0    |
| PasserByVol:                                | 0           | 0    | 0    | 0           | 0    | 0    | 0          | 0    | 0    | 0          | 0    | 0    |
| Initial Fut:                                | 240         | 6    | 241  | 0           | 0    | 0    | 114        | 761  | 0    | 0          | 1181 | 376  |
| User Adj:                                   | 1.00        | 1.00 | 1.00 | 1.00        | 1.00 | 1.00 | 1.00       | 1.00 | 1.00 | 1.00       | 1.00 | 1.00 |
| PHF Adj:                                    | 1.00        | 1.00 | 1.00 | 1.00        | 1.00 | 1.00 | 1.00       | 1.00 | 1.00 | 1.00       | 1.00 | 1.00 |
| PHF Volume:                                 | 240         | 6    | 241  | 0           | 0    | 0    | 114        | 761  | 0    | 0          | 1181 | 376  |
| Reduct Vol:                                 | 0           | 0    | 0    | 0           | 0    | 0    | 0          | 0    | 0    | 0          | 0    | 0    |
| Reduced Vol:                                | 240         | 6    | 241  | 0           | 0    | 0    | 114        | 761  | 0    | 0          | 1181 | 376  |
| PCE Adj:                                    | 1.00        | 1.00 | 1.00 | 1.00        | 1.00 | 1.00 | 1.00       | 1.00 | 1.00 | 1.00       | 1.00 | 1.00 |
| MLF Adj:                                    | 1.00        | 1.00 | 1.00 | 1.00        | 1.00 | 1.00 | 1.00       | 1.00 | 1.00 | 1.00       | 1.00 | 1.00 |
| Final Volume:                               | 240         | 6    | 241  | 0           | 0    | 0    | 114        | 761  | 0    | 0          | 1181 | 376  |
| Saturation Flow Module:                     |             |      |      |             |      |      |            |      |      |            |      |      |
| Sat/Lane:                                   | 1900        | 1900 | 1900 | 1900        | 1900 | 1900 | 1900       | 1900 | 1900 | 1900       | 1900 | 1900 |
| Adjustment:                                 | 0.92        | 0.95 | 0.95 | 0.92        | 1.00 | 0.92 | 0.92       | 1.00 | 0.92 | 0.92       | 1.00 | 0.92 |
| Lanes:                                      | 1.00        | 0.05 | 1.95 | 0.00        | 0.00 | 0.00 | 1.00       | 2.00 | 0.00 | 0.00       | 2.00 | 1.00 |
| Final Sat.:                                 | 1750        | 87   | 3513 | 0           | 0    | 0    | 1750       | 3800 | 0    | 0          | 3800 | 1750 |
| Capacity Analysis Module:                   |             |      |      |             |      |      |            |      |      |            |      |      |
| Vol/Sat:                                    | 0.14        | 0.07 | 0.07 | 0.00        | 0.00 | 0.00 | 0.07       | 0.20 | 0.00 | 0.00       | 0.31 | 0.21 |
| Crit Moves:                                 | ****        |      |      |             |      |      | ****       |      |      | ****       |      |      |
| Green Time:                                 | 35.0        | 35.0 | 35.0 | 0.0         | 0.0  | 0.0  | 16.6       | 96.0 | 0.0  | 0.0        | 79.4 | 79.4 |
| Volume/Cap:                                 | 0.55        | 0.27 | 0.27 | 0.00        | 0.00 | 0.00 | 0.55       | 0.29 | 0.00 | 0.00       | 0.55 | 0.38 |
| Delay/Veh:                                  | 47.1        | 42.4 | 42.4 | 0.0         | 0.0  | 0.0  | 61.2       | 8.7  | 0.0  | 0.0        | 19.4 | 17.0 |
| User DelAdj:                                | 1.00        | 1.00 | 1.00 | 1.00        | 1.00 | 1.00 | 1.00       | 1.00 | 1.00 | 1.00       | 1.00 | 1.00 |
| AdjDel/Veh:                                 | 47.1        | 42.4 | 42.4 | 0.0         | 0.0  | 0.0  | 61.2       | 8.7  | 0.0  | 0.0        | 19.4 | 17.0 |
| LOS by Move:                                | D           | D    | D    | A           | A    | A    | E          | A    | A    | A          | B    | B    |
| HCM2k95thQ:                                 | 18          | 9    | 9    | 0           | 0    | 0    | 11         | 12   | 0    | 0          | 27   | 17   |

Note: Queue reported is the number of cars per lane.

BART

Level Of Service Computation Report  
 2000 HCM Operations (Future Volume Alternative)  
 PM - Existing Conditions

Intersection #3211: 101/McKee(E) [Study Int 5]

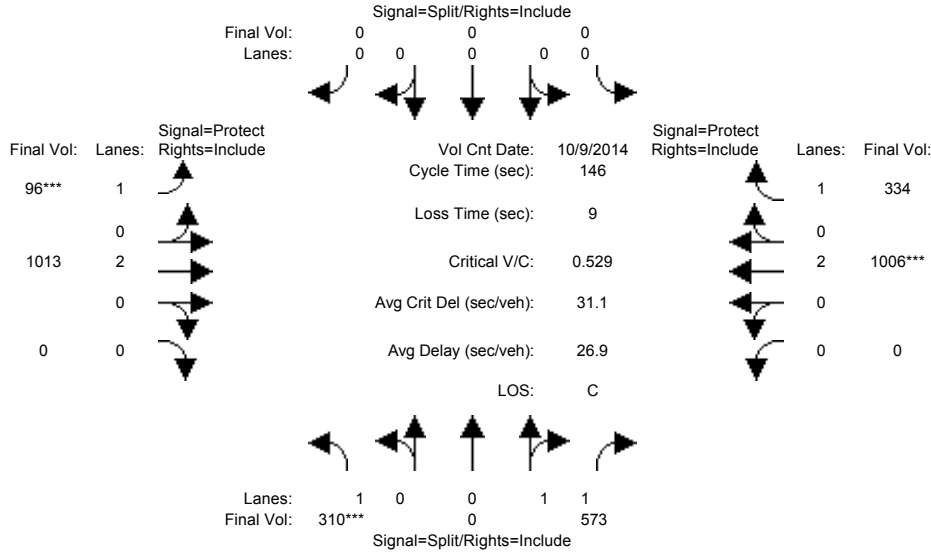

| Approach:   | North Bound |      |      | South Bound |      |      | East Bound |      |      | West Bound |      |      |
|---|-------------|------|------|-------------|------|------|------------|------|------|------------|------|------|
| Movement:   | L           | T    | R    | L           | T    | R    | L          | T    | R    | L          | T    | R    |
| Min. Green:   | 10          | 10   | 10   | 0           | 0    | 0    | 7          | 10   | 0    | 0          | 10   | 10   |
| Y+R:  | 4.0         | 4.0  | 4.0  | 4.0         | 4.0  | 4.0  | 4.0        | 4.0  | 4.0  | 4.0        | 4.0  | 4.0  |
| ----- ----- ----- ----- ----- ----- ----- ----- ----- ----- ----- ----- |             |      |      |             |      |      |            |      |      |            |      |      |
| Volume Module: >> Count Date: 9 Oct 2014 <<                             |             |      |      |             |      |      |            |      |      |            |      |      |
| Base Vol:   | 310         | 0    | 573  | 0           | 0    | 0    | 96         | 1013 | 0    | 0          | 1006 | 334  |
| Growth Adj:   | 1.00        | 1.00 | 1.00 | 1.00        | 1.00 | 1.00 | 1.00       | 1.00 | 1.00 | 1.00       | 1.00 | 1.00 |
| Initial Bse:  | 310         | 0    | 573  | 0           | 0    | 0    | 96         | 1013 | 0    | 0          | 1006 | 334  |
| Added Vol:  | 0           | 0    | 0    | 0           | 0    | 0    | 0          | 0    | 0    | 0          | 0    | 0    |
| PasserByVol:  | 0           | 0    | 0    | 0           | 0    | 0    | 0          | 0    | 0    | 0          | 0    | 0    |
| Initial Fut:  | 310         | 0    | 573  | 0           | 0    | 0    | 96         | 1013 | 0    | 0          | 1006 | 334  |
| User Adj:   | 1.00        | 1.00 | 1.00 | 1.00        | 1.00 | 1.00 | 1.00       | 1.00 | 1.00 | 1.00       | 1.00 | 1.00 |
| PHF Adj:  | 1.00        | 1.00 | 1.00 | 1.00        | 1.00 | 1.00 | 1.00       | 1.00 | 1.00 | 1.00       | 1.00 | 1.00 |
| PHF Volume:   | 310         | 0    | 573  | 0           | 0    | 0    | 96         | 1013 | 0    | 0          | 1006 | 334  |
| Reduct Vol:   | 0           | 0    | 0    | 0           | 0    | 0    | 0          | 0    | 0    | 0          | 0    | 0    |
| Reduced Vol:  | 310         | 0    | 573  | 0           | 0    | 0    | 96         | 1013 | 0    | 0          | 1006 | 334  |
| PCE Adj:  | 1.00        | 1.00 | 1.00 | 1.00        | 1.00 | 1.00 | 1.00       | 1.00 | 1.00 | 1.00       | 1.00 | 1.00 |
| MLF Adj:  | 1.00        | 1.00 | 1.00 | 1.00        | 1.00 | 1.00 | 1.00       | 1.00 | 1.00 | 1.00       | 1.00 | 1.00 |
| FinalVolume:  | 310         | 0    | 573  | 0           | 0    | 0    | 96         | 1013 | 0    | 0          | 1006 | 334  |
| ----- ----- ----- ----- ----- ----- ----- ----- ----- ----- ----- ----- |             |      |      |             |      |      |            |      |      |            |      |      |
| Saturation Flow Module:   |             |      |      |             |      |      |            |      |      |            |      |      |
| Sat/Lane:   | 1900        | 1900 | 1900 | 1900        | 1900 | 1900 | 1900       | 1900 | 1900 | 1900       | 1900 | 1900 |
| Adjustment:   | 0.92        | 1.00 | 0.95 | 0.92        | 1.00 | 0.92 | 0.92       | 1.00 | 0.92 | 0.92       | 1.00 | 0.92 |
| Lanes:  | 1.00        | 0.00 | 2.00 | 0.00        | 0.00 | 0.00 | 1.00       | 2.00 | 0.00 | 0.00       | 2.00 | 1.00 |
| Final Sat.:   | 1750        | 0    | 3600 | 0           | 0    | 0    | 1750       | 3800 | 0    | 0          | 3800 | 1750 |
| ----- ----- ----- ----- ----- ----- ----- ----- ----- ----- ----- ----- |             |      |      |             |      |      |            |      |      |            |      |      |
| Capacity Analysis Module:   |             |      |      |             |      |      |            |      |      |            |      |      |
| Vol/Sat:  | 0.18        | 0.00 | 0.16 | 0.00        | 0.00 | 0.00 | 0.05       | 0.27 | 0.00 | 0.00       | 0.26 | 0.19 |
| Crit Moves:   | ****        |      |      |             |      |      | ****       |      |      | ****       |      |      |
| Green Time:   | 48.9        | 0.0  | 48.9 | 0.0         | 0.0  | 0.0  | 15.1       | 88.1 | 0.0  | 0.0        | 73.0 | 73.0 |
| Volume/Cap:   | 0.53        | 0.00 | 0.48 | 0.00        | 0.00 | 0.00 | 0.53       | 0.44 | 0.00 | 0.00       | 0.53 | 0.38 |
| Delay/Veh:  | 40.2        | 0.0  | 38.7 | 0.0         | 0.0  | 0.0  | 65.0       | 15.8 | 0.0  | 0.0        | 25.1 | 22.8 |
| User DelAdj:  | 1.00        | 1.00 | 1.00 | 1.00        | 1.00 | 1.00 | 1.00       | 1.00 | 1.00 | 1.00       | 1.00 | 1.00 |
| AdjDel/Veh:   | 40.2        | 0.0  | 38.7 | 0.0         | 0.0  | 0.0  | 65.0       | 15.8 | 0.0  | 0.0        | 25.1 | 22.8 |
| LOS by Move:  | D           | A    | D    | A           | A    | A    | E          | B    | A    | A          | C    | C    |
| HCM2k95thQ:   | 22          | 0    | 19   | 0           | 0    | 0    | 10         | 22   | 0    | 0          | 26   | 18   |

Note: Queue reported is the number of cars per lane.

BART

Level Of Service Computation Report  
 2000 HCM Operations (Future Volume Alternative)  
 AM - Existing Conditions

Intersection #3260: ALUM ROCK/33rd [Study Int 16]

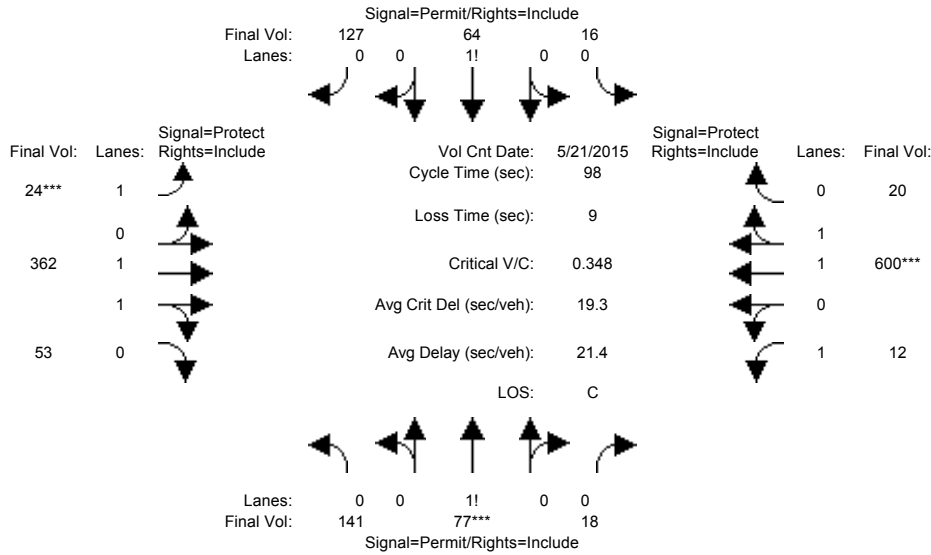

| Approach:  | North Bound |      |      | South Bound |      |      | East Bound |      |      | West Bound |      |      |
|--|-------------|------|------|-------------|------|------|------------|------|------|------------|------|------|
| Movement:  | L           | T    | R    | L           | T    | R    | L          | T    | R    | L          | T    | R    |
| Min. Green:  | 10          | 10   | 10   | 10          | 10   | 10   | 7          | 10   | 10   | 7          | 10   | 10   |
| Y+R:   | 4.0         | 4.0  | 4.0  | 4.0         | 4.0  | 4.0  | 4.0        | 4.0  | 4.0  | 4.0        | 4.0  | 4.0  |
| Volume Module: >> Count Date: 21 May 2015 << 7:30-8:30AM |             |      |      |             |      |      |            |      |      |            |      |      |
| Base Vol:  | 141         | 77   | 18   | 16          | 64   | 127  | 24         | 362  | 53   | 12         | 600  | 20   |
| Growth Adj:  | 1.00        | 1.00 | 1.00 | 1.00        | 1.00 | 1.00 | 1.00       | 1.00 | 1.00 | 1.00       | 1.00 | 1.00 |
| Initial Bse:   | 141         | 77   | 18   | 16          | 64   | 127  | 24         | 362  | 53   | 12         | 600  | 20   |
| Added Vol:   | 0           | 0    | 0    | 0           | 0    | 0    | 0          | 0    | 0    | 0          | 0    | 0    |
| PasserByVol:   | 0           | 0    | 0    | 0           | 0    | 0    | 0          | 0    | 0    | 0          | 0    | 0    |
| Initial Fut:   | 141         | 77   | 18   | 16          | 64   | 127  | 24         | 362  | 53   | 12         | 600  | 20   |
| User Adj:  | 1.00        | 1.00 | 1.00 | 1.00        | 1.00 | 1.00 | 1.00       | 1.00 | 1.00 | 1.00       | 1.00 | 1.00 |
| PHF Adj:   | 1.00        | 1.00 | 1.00 | 1.00        | 1.00 | 1.00 | 1.00       | 1.00 | 1.00 | 1.00       | 1.00 | 1.00 |
| PHF Volume:  | 141         | 77   | 18   | 16          | 64   | 127  | 24         | 362  | 53   | 12         | 600  | 20   |
| Reduct Vol:  | 0           | 0    | 0    | 0           | 0    | 0    | 0          | 0    | 0    | 0          | 0    | 0    |
| Reduced Vol:   | 141         | 77   | 18   | 16          | 64   | 127  | 24         | 362  | 53   | 12         | 600  | 20   |
| PCE Adj:   | 1.00        | 1.00 | 1.00 | 1.00        | 1.00 | 1.00 | 1.00       | 1.00 | 1.00 | 1.00       | 1.00 | 1.00 |
| MLF Adj:   | 1.00        | 1.00 | 1.00 | 1.00        | 1.00 | 1.00 | 1.00       | 1.00 | 1.00 | 1.00       | 1.00 | 1.00 |
| Final Volume:  | 141         | 77   | 18   | 16          | 64   | 127  | 24         | 362  | 53   | 12         | 600  | 20   |
| Saturation Flow Module:                                  |             |      |      |             |      |      |            |      |      |            |      |      |
| Sat/Lane:  | 1900        | 1900 | 1900 | 1900        | 1900 | 1900 | 1900       | 1900 | 1900 | 1900       | 1900 | 1900 |
| Adjustment:  | 0.92        | 0.92 | 0.92 | 0.92        | 0.92 | 0.92 | 0.92       | 0.98 | 0.95 | 0.92       | 0.97 | 0.95 |
| Lanes:   | 0.60        | 0.33 | 0.07 | 0.08        | 0.31 | 0.61 | 1.00       | 1.74 | 0.26 | 1.00       | 1.93 | 0.07 |
| Final Sat.:  | 1046        | 571  | 133  | 135         | 541  | 1074 | 1750       | 3227 | 472  | 1750       | 3581 | 119  |
| Capacity Analysis Module:                                |             |      |      |             |      |      |            |      |      |            |      |      |
| Vol/Sat:   | 0.13        | 0.13 | 0.13 | 0.12        | 0.12 | 0.12 | 0.01       | 0.11 | 0.11 | 0.01       | 0.17 | 0.17 |
| Crit Moves:  | ****        |      |      |             |      |      | ****       |      |      | ****       |      |      |
| Green Time:  | 36.6        | 36.6 | 36.6 | 36.6        | 36.6 | 36.6 | 7.0        | 32.0 | 32.0 | 20.4       | 45.4 | 45.4 |
| Volume/Cap:  | 0.36        | 0.36 | 0.36 | 0.32        | 0.32 | 0.32 | 0.19       | 0.34 | 0.34 | 0.03       | 0.36 | 0.36 |
| Delay/Veh:   | 22.6        | 22.6 | 22.6 | 22.1        | 22.1 | 22.1 | 43.6       | 25.2 | 25.2 | 31.0       | 17.1 | 17.1 |
| User DelAdj:   | 1.00        | 1.00 | 1.00 | 1.00        | 1.00 | 1.00 | 1.00       | 1.00 | 1.00 | 1.00       | 1.00 | 1.00 |
| AdjDel/Veh:  | 22.6        | 22.6 | 22.6 | 22.1        | 22.1 | 22.1 | 43.6       | 25.2 | 25.2 | 31.0       | 17.1 | 17.1 |
| LOS by Move:   | C           | C    | C    | C           | C    | C    | D          | C    | C    | C          | B    | B    |
| HCM2k95thQ:  | 11          | 11   | 11   | 9           | 9    | 9    | 1          | 9    | 9    | 1          | 12   | 12   |

Note: Queue reported is the number of cars per lane.



BART

Level Of Service Computation Report  
2000 HCM Operations (Future Volume Alternative)  
PM - Existing Conditions

Intersection #3260: ALUM ROCK/33rd [Study Int 16]

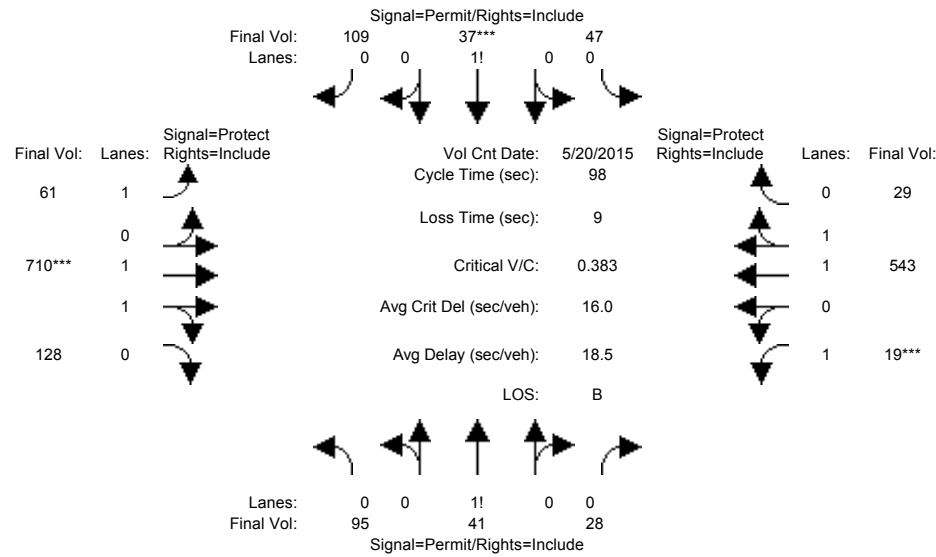

| Approach:  | North Bound |      |      | South Bound |      |      | East Bound |      |      | West Bound |      |      |
|--|-------------|------|------|-------------|------|------|------------|------|------|------------|------|------|
| Movement:  | L           | T    | R    | L           | T    | R    | L          | T    | R    | L          | T    | R    |
| Min. Green:  | 10          | 10   | 10   | 10          | 10   | 10   | 7          | 10   | 10   | 7          | 10   | 10   |
| Y+R:   | 4.0         | 4.0  | 4.0  | 4.0         | 4.0  | 4.0  | 4.0        | 4.0  | 4.0  | 4.0        | 4.0  | 4.0  |
| Volume Module: >> Count Date: 20 May 2015 << 4:15-5:15PM |             |      |      |             |      |      |            |      |      |            |      |      |
| Base Vol:  | 95          | 41   | 28   | 47          | 37   | 109  | 61         | 710  | 128  | 19         | 543  | 29   |
| Growth Adj:  | 1.00        | 1.00 | 1.00 | 1.00        | 1.00 | 1.00 | 1.00       | 1.00 | 1.00 | 1.00       | 1.00 | 1.00 |
| Initial Bse:   | 95          | 41   | 28   | 47          | 37   | 109  | 61         | 710  | 128  | 19         | 543  | 29   |
| Added Vol:   | 0           | 0    | 0    | 0           | 0    | 0    | 0          | 0    | 0    | 0          | 0    | 0    |
| PasserByVol:   | 0           | 0    | 0    | 0           | 0    | 0    | 0          | 0    | 0    | 0          | 0    | 0    |
| Initial Fut:   | 95          | 41   | 28   | 47          | 37   | 109  | 61         | 710  | 128  | 19         | 543  | 29   |
| User Adj:  | 1.00        | 1.00 | 1.00 | 1.00        | 1.00 | 1.00 | 1.00       | 1.00 | 1.00 | 1.00       | 1.00 | 1.00 |
| PHF Adj:   | 1.00        | 1.00 | 1.00 | 1.00        | 1.00 | 1.00 | 1.00       | 1.00 | 1.00 | 1.00       | 1.00 | 1.00 |
| PHF Volume:  | 95          | 41   | 28   | 47          | 37   | 109  | 61         | 710  | 128  | 19         | 543  | 29   |
| Reduct Vol:  | 0           | 0    | 0    | 0           | 0    | 0    | 0          | 0    | 0    | 0          | 0    | 0    |
| Reduced Vol:   | 95          | 41   | 28   | 47          | 37   | 109  | 61         | 710  | 128  | 19         | 543  | 29   |
| PCE Adj:   | 1.00        | 1.00 | 1.00 | 1.00        | 1.00 | 1.00 | 1.00       | 1.00 | 1.00 | 1.00       | 1.00 | 1.00 |
| MLF Adj:   | 1.00        | 1.00 | 1.00 | 1.00        | 1.00 | 1.00 | 1.00       | 1.00 | 1.00 | 1.00       | 1.00 | 1.00 |
| FinalVolume:   | 95          | 41   | 28   | 47          | 37   | 109  | 61         | 710  | 128  | 19         | 543  | 29   |
| Saturation Flow Module:                                  |             |      |      |             |      |      |            |      |      |            |      |      |
| Sat/Lane:  | 1900        | 1900 | 1900 | 1900        | 1900 | 1900 | 1900       | 1900 | 1900 | 1900       | 1900 | 1900 |
| Adjustment:  | 0.92        | 0.92 | 0.92 | 0.92        | 0.92 | 0.92 | 0.92       | 0.98 | 0.95 | 0.92       | 0.98 | 0.95 |
| Lanes:   | 0.58        | 0.25 | 0.17 | 0.24        | 0.19 | 0.57 | 1.00       | 1.69 | 0.31 | 1.00       | 1.90 | 0.10 |
| Final Sat.:  | 1014        | 438  | 299  | 426         | 335  | 988  | 1750       | 3134 | 565  | 1750       | 3512 | 188  |
| Capacity Analysis Module:                                |             |      |      |             |      |      |            |      |      |            |      |      |
| Vol/Sat:   | 0.09        | 0.09 | 0.09 | 0.11        | 0.11 | 0.11 | 0.03       | 0.23 | 0.23 | 0.01       | 0.15 | 0.15 |
| Crit Moves:  |             |      |      | ****        |      |      | ****       |      |      | ****       |      |      |
| Green Time:  | 26.9        | 26.9 | 26.9 | 26.9        | 26.9 | 26.9 | 19.6       | 55.1 | 55.1 | 7.0        | 42.5 | 42.5 |
| Volume/Cap:  | 0.34        | 0.34 | 0.34 | 0.40        | 0.40 | 0.40 | 0.17       | 0.40 | 0.40 | 0.15       | 0.36 | 0.36 |
| Delay/Veh:   | 28.9        | 28.9 | 28.9 | 29.6        | 29.6 | 29.6 | 32.7       | 12.2 | 12.2 | 43.3       | 18.7 | 18.7 |
| User DelAdj:   | 1.00        | 1.00 | 1.00 | 1.00        | 1.00 | 1.00 | 1.00       | 1.00 | 1.00 | 1.00       | 1.00 | 1.00 |
| AdjDel/Veh:  | 28.9        | 28.9 | 28.9 | 29.6        | 29.6 | 29.6 | 32.7       | 12.2 | 12.2 | 43.3       | 18.7 | 18.7 |
| LOS by Move:   | C           | C    | C    | C           | C    | C    | C          | B    | B    | D          | B    | B    |
| HCM2k95thQ:  | 9           | 9    | 9    | 10          | 10   | 10   | 3          | 13   | 13   | 1          | 11   | 11   |

Note: Queue reported is the number of cars per lane.

BART

Level Of Service Computation Report  
2000 HCM Operations (Future Volume Alternative)  
AM - Existing Conditions

Intersection #3384: JACKSON/CAPITOL/SAN ANTONIO [Study Int 23]

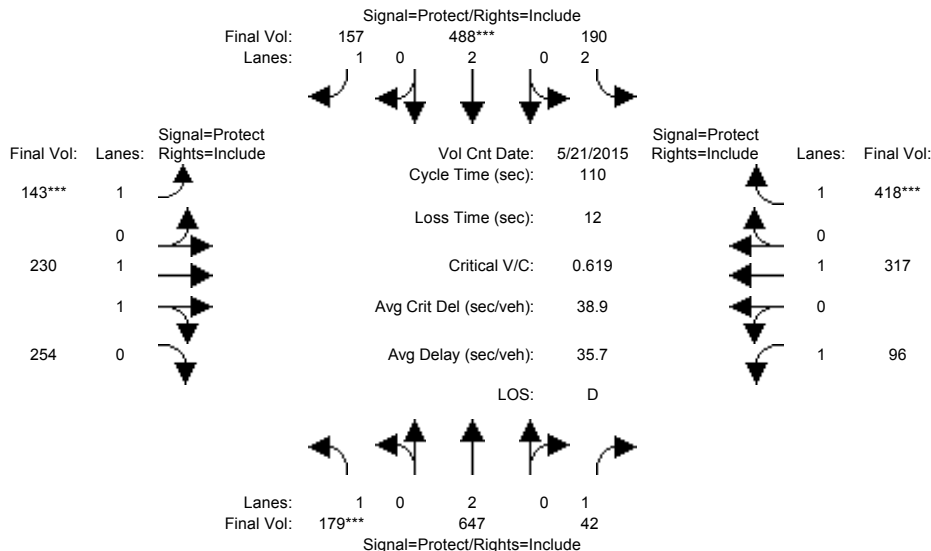

| Approach:  | North Bound |      |      | South Bound |      |      | East Bound |      |      | West Bound |      |      |
|--|-------------|------|------|-------------|------|------|------------|------|------|------------|------|------|
| Movement:  | L           | T    | R    | L           | T    | R    | L          | T    | R    | L          | T    | R    |
| Min. Green:  | 7           | 10   | 10   | 7           | 10   | 10   | 7          | 10   | 10   | 7          | 10   | 10   |
| Y+R:   | 4.0         | 4.0  | 4.0  | 4.0         | 4.0  | 4.0  | 4.0        | 4.0  | 4.0  | 4.0        | 4.0  | 4.0  |
| Volume Module: >> Count Date: 21 May 2015 << 7:30-8:30AM |             |      |      |             |      |      |            |      |      |            |      |      |
| Base Vol:  | 179         | 647  | 42   | 190         | 488  | 157  | 143        | 230  | 254  | 96         | 317  | 418  |
| Growth Adj:  | 1.00        | 1.00 | 1.00 | 1.00        | 1.00 | 1.00 | 1.00       | 1.00 | 1.00 | 1.00       | 1.00 | 1.00 |
| Initial Bse:   | 179         | 647  | 42   | 190         | 488  | 157  | 143        | 230  | 254  | 96         | 317  | 418  |
| Added Vol:   | 0           | 0    | 0    | 0           | 0    | 0    | 0          | 0    | 0    | 0          | 0    | 0    |
| PasserByVol:   | 0           | 0    | 0    | 0           | 0    | 0    | 0          | 0    | 0    | 0          | 0    | 0    |
| Initial Fut:   | 179         | 647  | 42   | 190         | 488  | 157  | 143        | 230  | 254  | 96         | 317  | 418  |
| User Adj:  | 1.00        | 1.00 | 1.00 | 1.00        | 1.00 | 1.00 | 1.00       | 1.00 | 1.00 | 1.00       | 1.00 | 1.00 |
| PHF Adj:   | 1.00        | 1.00 | 1.00 | 1.00        | 1.00 | 1.00 | 1.00       | 1.00 | 1.00 | 1.00       | 1.00 | 1.00 |
| PHF Volume:  | 179         | 647  | 42   | 190         | 488  | 157  | 143        | 230  | 254  | 96         | 317  | 418  |
| Reduct Vol:  | 0           | 0    | 0    | 0           | 0    | 0    | 0          | 0    | 0    | 0          | 0    | 0    |
| Reduced Vol:   | 179         | 647  | 42   | 190         | 488  | 157  | 143        | 230  | 254  | 96         | 317  | 418  |
| PCE Adj:   | 1.00        | 1.00 | 1.00 | 1.00        | 1.00 | 1.00 | 1.00       | 1.00 | 1.00 | 1.00       | 1.00 | 1.00 |
| MLF Adj:   | 1.00        | 1.00 | 1.00 | 1.00        | 1.00 | 1.00 | 1.00       | 1.00 | 1.00 | 1.00       | 1.00 | 1.00 |
| Final Volume:  | 179         | 647  | 42   | 190         | 488  | 157  | 143        | 230  | 254  | 96         | 317  | 418  |
| Saturation Flow Module:                                  |             |      |      |             |      |      |            |      |      |            |      |      |
| Sat/Lane:  | 1900        | 1900 | 1900 | 1900        | 1900 | 1900 | 1900       | 1900 | 1900 | 1900       | 1900 | 1900 |
| Adjustment:  | 0.92        | 1.00 | 0.92 | 0.83        | 1.00 | 0.92 | 0.92       | 1.00 | 0.92 | 0.92       | 1.00 | 0.92 |
| Lanes:   | 1.00        | 2.00 | 1.00 | 2.00        | 2.00 | 1.00 | 1.00       | 1.00 | 1.00 | 1.00       | 1.00 | 1.00 |
| Final Sat.:  | 1750        | 3800 | 1750 | 3150        | 3800 | 1750 | 1750       | 1900 | 1750 | 1750       | 1900 | 1750 |
| Capacity Analysis Module:                                |             |      |      |             |      |      |            |      |      |            |      |      |
| Vol/Sat:   | 0.10        | 0.17 | 0.02 | 0.06        | 0.13 | 0.09 | 0.08       | 0.12 | 0.15 | 0.05       | 0.17 | 0.24 |
| Crit Moves:  | ****        |      |      | ****        |      |      | ****       |      |      | ****       |      |      |
| Green Time:  | 18.2        | 29.9 | 29.9 | 11.2        | 22.8 | 22.8 | 14.5       | 39.6 | 39.6 | 17.4       | 42.5 | 42.5 |
| Volume/Cap:  | 0.62        | 0.63 | 0.09 | 0.59        | 0.62 | 0.43 | 0.62       | 0.34 | 0.40 | 0.35       | 0.43 | 0.62 |
| Delay/Veh:   | 46.7        | 36.4 | 30.0 | 50.3        | 41.1 | 38.8 | 50.2       | 25.8 | 26.6 | 42.0       | 25.3 | 29.0 |
| User DelAdj:   | 1.00        | 1.00 | 1.00 | 1.00        | 1.00 | 1.00 | 1.00       | 1.00 | 1.00 | 1.00       | 1.00 | 1.00 |
| AdjDel/Veh:  | 46.7        | 36.4 | 30.0 | 50.3        | 41.1 | 38.8 | 50.2       | 25.8 | 26.6 | 42.0       | 25.3 | 29.0 |
| LOS by Move:   | D           | D    | C    | D           | D    | D    | D          | C    | C    | D          | C    | C    |
| HCM2k95thQ:  | 12          | 18   | 2    | 9           | 16   | 10   | 10         | 10   | 11   | 7          | 15   | 23   |

Note: Queue reported is the number of cars per lane.

BART

Level Of Service Computation Report  
 2000 HCM Operations (Future Volume Alternative)  
 PM - Existing Conditions

Intersection #3384: JACKSON/CAPITOL/SAN ANTONIO [Study Int 23]

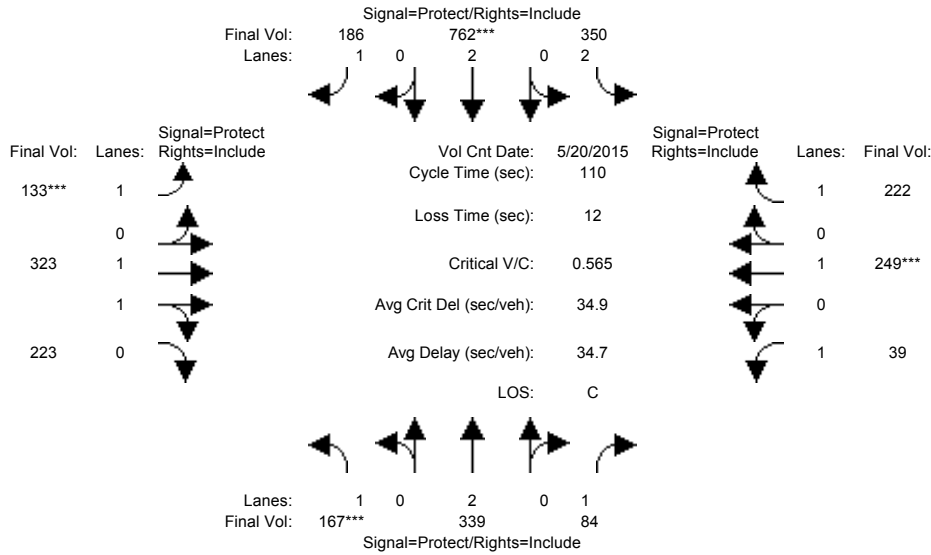

| Approach:  | North Bound |      |      | South Bound |      |      | East Bound |      |      | West Bound |      |      |
|--|-------------|------|------|-------------|------|------|------------|------|------|------------|------|------|
| Movement:  | L           | T    | R    | L           | T    | R    | L          | T    | R    | L          | T    | R    |
| Min. Green:  | 7           | 10   | 10   | 7           | 10   | 10   | 7          | 10   | 10   | 7          | 10   | 10   |
| Y+R:   | 4.0         | 4.0  | 4.0  | 4.0         | 4.0  | 4.0  | 4.0        | 4.0  | 4.0  | 4.0        | 4.0  | 4.0  |
| Volume Module: >> Count Date: 20 May 2015 << 5:00-6:00PM |             |      |      |             |      |      |            |      |      |            |      |      |
| Base Vol:  | 167         | 339  | 84   | 350         | 762  | 186  | 133        | 323  | 223  | 39         | 249  | 222  |
| Growth Adj:  | 1.00        | 1.00 | 1.00 | 1.00        | 1.00 | 1.00 | 1.00       | 1.00 | 1.00 | 1.00       | 1.00 | 1.00 |
| Initial Bse:   | 167         | 339  | 84   | 350         | 762  | 186  | 133        | 323  | 223  | 39         | 249  | 222  |
| Added Vol:   | 0           | 0    | 0    | 0           | 0    | 0    | 0          | 0    | 0    | 0          | 0    | 0    |
| PasserByVol:   | 0           | 0    | 0    | 0           | 0    | 0    | 0          | 0    | 0    | 0          | 0    | 0    |
| Initial Fut:   | 167         | 339  | 84   | 350         | 762  | 186  | 133        | 323  | 223  | 39         | 249  | 222  |
| User Adj:  | 1.00        | 1.00 | 1.00 | 1.00        | 1.00 | 1.00 | 1.00       | 1.00 | 1.00 | 1.00       | 1.00 | 1.00 |
| PHF Adj:   | 1.00        | 1.00 | 1.00 | 1.00        | 1.00 | 1.00 | 1.00       | 1.00 | 1.00 | 1.00       | 1.00 | 1.00 |
| PHF Volume:  | 167         | 339  | 84   | 350         | 762  | 186  | 133        | 323  | 223  | 39         | 249  | 222  |
| Reduct Vol:  | 0           | 0    | 0    | 0           | 0    | 0    | 0          | 0    | 0    | 0          | 0    | 0    |
| Reduced Vol:   | 167         | 339  | 84   | 350         | 762  | 186  | 133        | 323  | 223  | 39         | 249  | 222  |
| PCE Adj:   | 1.00        | 1.00 | 1.00 | 1.00        | 1.00 | 1.00 | 1.00       | 1.00 | 1.00 | 1.00       | 1.00 | 1.00 |
| MLF Adj:   | 1.00        | 1.00 | 1.00 | 1.00        | 1.00 | 1.00 | 1.00       | 1.00 | 1.00 | 1.00       | 1.00 | 1.00 |
| Final Volume:  | 167         | 339  | 84   | 350         | 762  | 186  | 133        | 323  | 223  | 39         | 249  | 222  |
| Saturation Flow Module:                                  |             |      |      |             |      |      |            |      |      |            |      |      |
| Sat/Lane:  | 1900        | 1900 | 1900 | 1900        | 1900 | 1900 | 1900       | 1900 | 1900 | 1900       | 1900 | 1900 |
| Adjustment:  | 0.92        | 1.00 | 0.92 | 0.83        | 1.00 | 0.92 | 0.92       | 0.99 | 0.95 | 0.92       | 1.00 | 0.92 |
| Lanes:   | 1.00        | 2.00 | 1.00 | 2.00        | 2.00 | 1.00 | 1.00       | 1.16 | 0.84 | 1.00       | 1.00 | 1.00 |
| Final Sat.:  | 1750        | 3800 | 1750 | 3150        | 3800 | 1750 | 1750       | 2188 | 1510 | 1750       | 1900 | 1750 |
| Capacity Analysis Module:                                |             |      |      |             |      |      |            |      |      |            |      |      |
| Vol/Sat:   | 0.10        | 0.09 | 0.05 | 0.11        | 0.20 | 0.11 | 0.08       | 0.15 | 0.15 | 0.02       | 0.13 | 0.13 |
| Crit Moves:  | ****        |      |      | ****        |      |      | ****       |      |      | ****       |      |      |
| Green Time:  | 18.6        | 25.9 | 25.9 | 31.7        | 39.1 | 39.1 | 14.8       | 28.2 | 28.2 | 12.2       | 25.5 | 25.5 |
| Volume/Cap:  | 0.56        | 0.38 | 0.20 | 0.39        | 0.56 | 0.30 | 0.56       | 0.58 | 0.58 | 0.20       | 0.56 | 0.55 |
| Delay/Veh:   | 44.5        | 35.5 | 34.0 | 31.6        | 29.2 | 25.9 | 47.7       | 36.6 | 36.6 | 45.0       | 39.0 | 38.7 |
| User DelAdj:   | 1.00        | 1.00 | 1.00 | 1.00        | 1.00 | 1.00 | 1.00       | 1.00 | 1.00 | 1.00       | 1.00 | 1.00 |
| AdjDel/Veh:  | 44.5        | 35.5 | 34.0 | 31.6        | 29.2 | 25.9 | 47.7       | 36.6 | 36.6 | 45.0       | 39.0 | 38.7 |
| LOS by Move:   | D           | D    | C    | C           | C    | C    | D          | D    | D    | D          | D    | D    |
| HCM2k95thQ:  | 11          | 9    | 5    | 11          | 20   | 10   | 9          | 15   | 15   | 3          | 15   | 14   |

Note: Queue reported is the number of cars per lane.

BART

Level Of Service Computation Report  
 2000 HCM Operations (Future Volume Alternative)  
 AM - Existing Conditions

Intersection #3411: AVIATION/COLEMAN [Study Int 34]

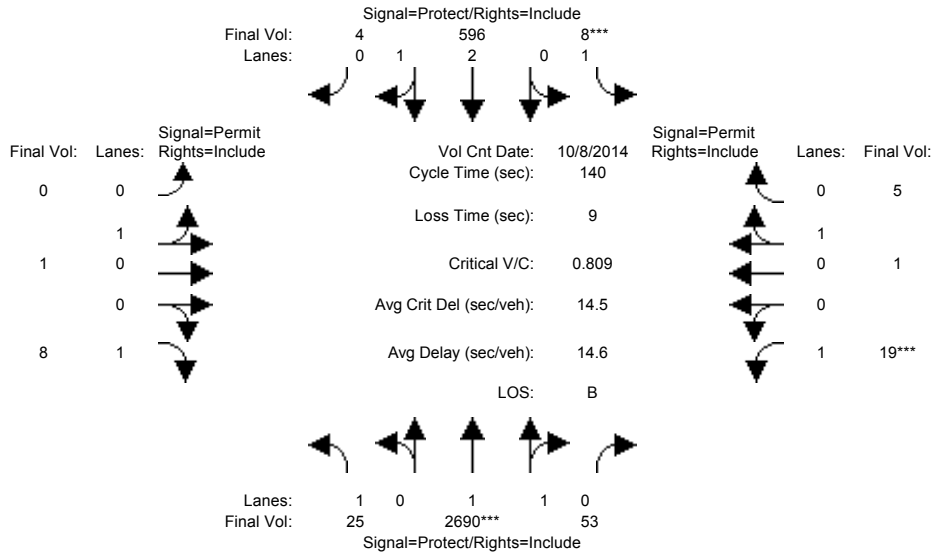

| Approach:                 | North Bound                  |      |       | South Bound |      |      | East Bound |      |      | West Bound |      |      |
|---------------------------|------------------------------|------|-------|-------------|------|------|------------|------|------|------------|------|------|
| Movement:                 | L                            | T    | R     | L           | T    | R    | L          | T    | R    | L          | T    | R    |
| Min. Green:               | 7                            | 10   | 10    | 7           | 10   | 10   | 10         | 10   | 10   | 10         | 10   | 10   |
| Y+R:                      | 4.0                          | 4.0  | 4.0   | 4.0         | 4.0  | 4.0  | 4.0        | 4.0  | 4.0  | 4.0        | 4.0  | 4.0  |
| -----                     |                              |      |       |             |      |      |            |      |      |            |      |      |
| Volume Module:            | >> Count Date: 8 Oct 2014 << |      |       |             |      |      |            |      |      |            |      |      |
| Base Vol:                 | 25                           | 2690 | 53    | 8           | 596  | 4    | 0          | 1    | 8    | 19         | 1    | 5    |
| Growth Adj:               | 1.00                         | 1.00 | 1.00  | 1.00        | 1.00 | 1.00 | 1.00       | 1.00 | 1.00 | 1.00       | 1.00 | 1.00 |
| Initial Bse:              | 25                           | 2690 | 53    | 8           | 596  | 4    | 0          | 1    | 8    | 19         | 1    | 5    |
| Added Vol:                | 0                            | 0    | 0     | 0           | 0    | 0    | 0          | 0    | 0    | 0          | 0    | 0    |
| PasserByVol:              | 0                            | 0    | 0     | 0           | 0    | 0    | 0          | 0    | 0    | 0          | 0    | 0    |
| Initial Fut:              | 25                           | 2690 | 53    | 8           | 596  | 4    | 0          | 1    | 8    | 19         | 1    | 5    |
| User Adj:                 | 1.00                         | 1.00 | 1.00  | 1.00        | 1.00 | 1.00 | 1.00       | 1.00 | 1.00 | 1.00       | 1.00 | 1.00 |
| PHF Adj:                  | 1.00                         | 1.00 | 1.00  | 1.00        | 1.00 | 1.00 | 1.00       | 1.00 | 1.00 | 1.00       | 1.00 | 1.00 |
| PHF Volume:               | 25                           | 2690 | 53    | 8           | 596  | 4    | 0          | 1    | 8    | 19         | 1    | 5    |
| Reduct Vol:               | 0                            | 0    | 0     | 0           | 0    | 0    | 0          | 0    | 0    | 0          | 0    | 0    |
| Reduced Vol:              | 25                           | 2690 | 53    | 8           | 596  | 4    | 0          | 1    | 8    | 19         | 1    | 5    |
| PCE Adj:                  | 1.00                         | 1.00 | 1.00  | 1.00        | 1.00 | 1.00 | 1.00       | 1.00 | 1.00 | 1.00       | 1.00 | 1.00 |
| MLF Adj:                  | 1.00                         | 1.00 | 1.00  | 1.00        | 1.00 | 1.00 | 1.00       | 1.00 | 1.00 | 1.00       | 1.00 | 1.00 |
| FinalVolume:              | 25                           | 2690 | 53    | 8           | 596  | 4    | 0          | 1    | 8    | 19         | 1    | 5    |
| -----                     |                              |      |       |             |      |      |            |      |      |            |      |      |
| Saturation Flow Module:   |                              |      |       |             |      |      |            |      |      |            |      |      |
| Sat/Lane:                 | 1900                         | 1900 | 1900  | 1900        | 1900 | 1900 | 1900       | 1900 | 1900 | 1900       | 1900 | 1900 |
| Adjustment:               | 0.92                         | 0.97 | 0.95  | 0.92        | 0.98 | 0.95 | 0.95       | 0.95 | 0.92 | 0.92       | 0.95 | 0.95 |
| Lanes:                    | 1.00                         | 1.96 | 0.04  | 1.00        | 2.98 | 0.02 | 0.00       | 1.00 | 1.00 | 1.00       | 0.17 | 0.83 |
| Final Sat.:               | 1750                         | 3628 | 71    | 1750        | 5563 | 37   | 0          | 1800 | 1750 | 1750       | 300  | 1500 |
| -----                     |                              |      |       |             |      |      |            |      |      |            |      |      |
| Capacity Analysis Module: |                              |      |       |             |      |      |            |      |      |            |      |      |
| Vol/Sat:                  | 0.01                         | 0.74 | 0.74  | 0.00        | 0.11 | 0.11 | 0.00       | 0.00 | 0.00 | 0.01       | 0.00 | 0.00 |
| Crit Moves:               | ****                         |      |       | ****        |      |      | ****       |      |      | ****       |      |      |
| Green Time:               | 38.5                         | 114  | 114.0 | 7.0         | 82.5 | 82.5 | 0.0        | 10.0 | 10.0 | 10.0       | 10.0 | 10.0 |
| Volume/Cap:               | 0.05                         | 0.91 | 0.91  | 0.09        | 0.18 | 0.18 | 0.00       | 0.01 | 0.06 | 0.15       | 0.05 | 0.05 |
| Delay/Veh:                | 37.4                         | 14.0 | 14.0  | 63.9        | 13.3 | 13.3 | 0.0        | 60.4 | 60.9 | 61.6       | 60.7 | 60.7 |
| User DelAdj:              | 1.00                         | 1.00 | 1.00  | 1.00        | 1.00 | 1.00 | 1.00       | 1.00 | 1.00 | 1.00       | 1.00 | 1.00 |
| AdjDel/Veh:               | 37.4                         | 14.0 | 14.0  | 63.9        | 13.3 | 13.3 | 0.0        | 60.4 | 60.9 | 61.6       | 60.7 | 60.7 |
| LOS by Move:              | D                            | B    | B     | E           | B    | B    | A          | E    | E    | E          | E    | E    |
| HCM2k95thQ:               | 2                            | 71   | 71    | 1           | 8    | 8    | 0          | 0    | 1    | 2          | 1    | 1    |

Note: Queue reported is the number of cars per lane.

BART

Level Of Service Computation Report  
2000 HCM Operations (Future Volume Alternative)  
PM - Existing Conditions

Intersection #3411: AVIATION/COLEMAN [Study Int 34]

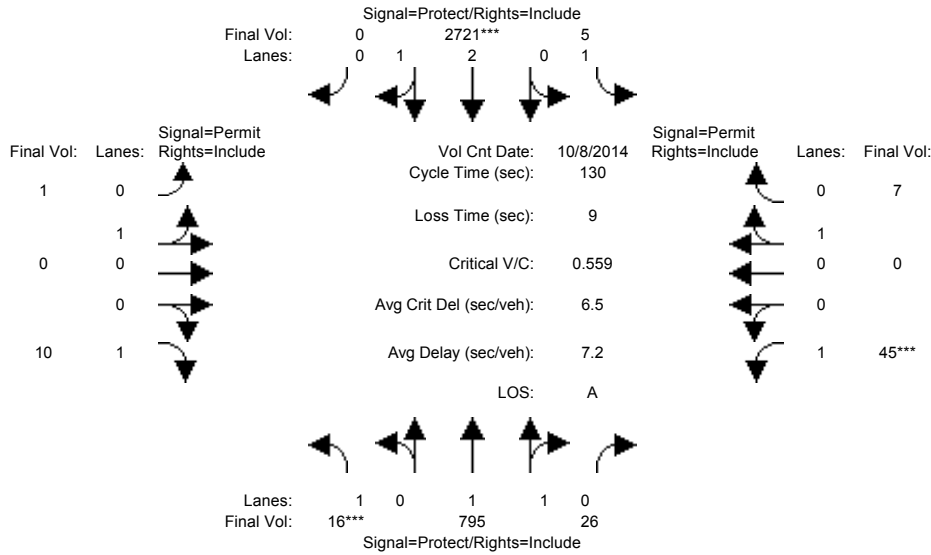

| Approach:                 | North Bound                  |      |      | South Bound |      |      | East Bound |      |      | West Bound |      |      |
|---------------------------|------------------------------|------|------|-------------|------|------|------------|------|------|------------|------|------|
| Movement:                 | L                            | T    | R    | L           | T    | R    | L          | T    | R    | L          | T    | R    |
| Min. Green:               | 7                            | 10   | 10   | 7           | 10   | 10   | 10         | 10   | 10   | 10         | 10   | 10   |
| Y+R:                      | 4.0                          | 4.0  | 4.0  | 4.0         | 4.0  | 4.0  | 4.0        | 4.0  | 4.0  | 4.0        | 4.0  | 4.0  |
| -----                     |                              |      |      |             |      |      |            |      |      |            |      |      |
| Volume Module:            | >> Count Date: 8 Oct 2014 << |      |      |             |      |      |            |      |      |            |      |      |
| Base Vol:                 | 16                           | 795  | 26   | 5           | 2721 | 0    | 1          | 0    | 10   | 45         | 0    | 7    |
| Growth Adj:               | 1.00                         | 1.00 | 1.00 | 1.00        | 1.00 | 1.00 | 1.00       | 1.00 | 1.00 | 1.00       | 1.00 | 1.00 |
| Initial Bse:              | 16                           | 795  | 26   | 5           | 2721 | 0    | 1          | 0    | 10   | 45         | 0    | 7    |
| Added Vol:                | 0                            | 0    | 0    | 0           | 0    | 0    | 0          | 0    | 0    | 0          | 0    | 0    |
| PasserByVol:              | 0                            | 0    | 0    | 0           | 0    | 0    | 0          | 0    | 0    | 0          | 0    | 0    |
| Initial Fut:              | 16                           | 795  | 26   | 5           | 2721 | 0    | 1          | 0    | 10   | 45         | 0    | 7    |
| User Adj:                 | 1.00                         | 1.00 | 1.00 | 1.00        | 1.00 | 1.00 | 1.00       | 1.00 | 1.00 | 1.00       | 1.00 | 1.00 |
| PHF Adj:                  | 1.00                         | 1.00 | 1.00 | 1.00        | 1.00 | 1.00 | 1.00       | 1.00 | 1.00 | 1.00       | 1.00 | 1.00 |
| PHF Volume:               | 16                           | 795  | 26   | 5           | 2721 | 0    | 1          | 0    | 10   | 45         | 0    | 7    |
| Reduct Vol:               | 0                            | 0    | 0    | 0           | 0    | 0    | 0          | 0    | 0    | 0          | 0    | 0    |
| Reduced Vol:              | 16                           | 795  | 26   | 5           | 2721 | 0    | 1          | 0    | 10   | 45         | 0    | 7    |
| PCE Adj:                  | 1.00                         | 1.00 | 1.00 | 1.00        | 1.00 | 1.00 | 1.00       | 1.00 | 1.00 | 1.00       | 1.00 | 1.00 |
| MLF Adj:                  | 1.00                         | 1.00 | 1.00 | 1.00        | 1.00 | 1.00 | 1.00       | 1.00 | 1.00 | 1.00       | 1.00 | 1.00 |
| Final Volume:             | 16                           | 795  | 26   | 5           | 2721 | 0    | 1          | 0    | 10   | 45         | 0    | 7    |
| -----                     |                              |      |      |             |      |      |            |      |      |            |      |      |
| Saturation Flow Module:   |                              |      |      |             |      |      |            |      |      |            |      |      |
| Sat/Lane:                 | 1900                         | 1900 | 1900 | 1900        | 1900 | 1900 | 1900       | 1900 | 1900 | 1900       | 1900 | 1900 |
| Adjustment:               | 0.92                         | 0.97 | 0.95 | 0.92        | 0.98 | 0.92 | 0.95       | 0.95 | 0.92 | 0.92       | 1.00 | 0.95 |
| Lanes:                    | 1.00                         | 1.93 | 0.07 | 1.00        | 3.00 | 0.00 | 1.00       | 0.00 | 1.00 | 1.00       | 0.00 | 1.00 |
| Final Sat.:               | 1750                         | 3583 | 117  | 1750        | 5600 | 0    | 1800       | 0    | 1750 | 1750       | 0    | 1800 |
| -----                     |                              |      |      |             |      |      |            |      |      |            |      |      |
| Capacity Analysis Module: |                              |      |      |             |      |      |            |      |      |            |      |      |
| Vol/Sat:                  | 0.01                         | 0.22 | 0.22 | 0.00        | 0.49 | 0.00 | 0.00       | 0.00 | 0.01 | 0.03       | 0.00 | 0.00 |
| Crit Moves:               | ****                         |      |      | ****        |      |      | ****       |      |      | ****       |      |      |
| Green Time:               | 7.0                          | 89.3 | 89.3 | 21.7        | 104  | 0.0  | 10.0       | 0.0  | 10.0 | 10.0       | 0.0  | 10.0 |
| Volume/Cap:               | 0.17                         | 0.32 | 0.32 | 0.02        | 0.61 | 0.00 | 0.01       | 0.00 | 0.07 | 0.33       | 0.00 | 0.05 |
| Delay/Veh:                | 59.6                         | 8.3  | 8.3  | 45.3        | 5.3  | 0.0  | 55.4       | 0.0  | 55.9 | 58.3       | 0.0  | 55.8 |
| User DelAdj:              | 1.00                         | 1.00 | 1.00 | 1.00        | 1.00 | 1.00 | 1.00       | 1.00 | 1.00 | 1.00       | 1.00 | 1.00 |
| AdjDel/Veh:               | 59.6                         | 8.3  | 8.3  | 45.3        | 5.3  | 0.0  | 55.4       | 0.0  | 55.9 | 58.3       | 0.0  | 55.8 |
| LOS by Move:              | E                            | A    | A    | D           | A    | A    | E          | A    | E    | E          | A    | E    |
| HCM2k95thQ:               | 1                            | 13   | 13   | 0           | 23   | 0    | 0          | 0    | 1    | 4          | 0    | 1    |

Note: Queue reported is the number of cars per lane.

BART

Level Of Service Computation Report  
2000 HCM Operations (Future Volume Alternative)  
AM - Existing Conditions

Intersection #3413: Coleman/Hedding [Study Int 38]

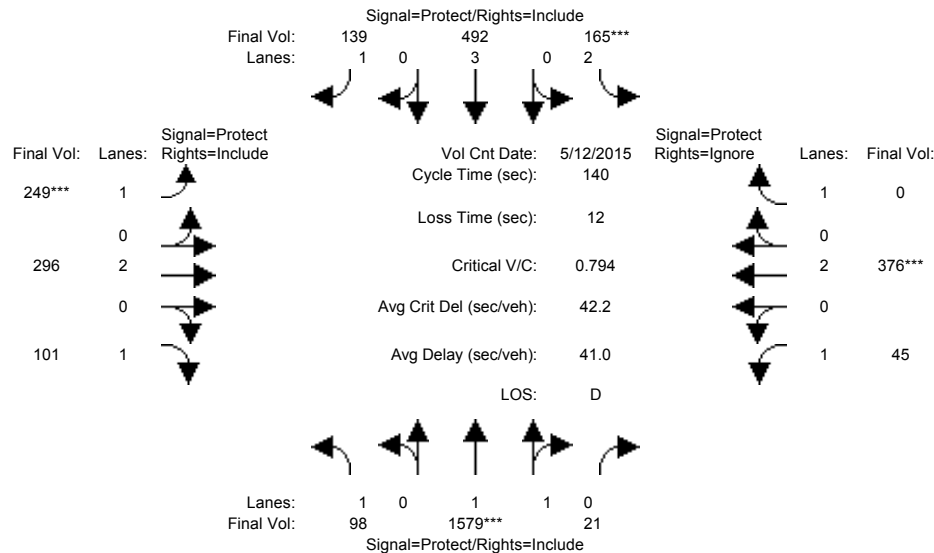

| Approach:  | North Bound |      |      | South Bound |      |      | East Bound |      |      | West Bound |      |      |
|--|-------------|------|------|-------------|------|------|------------|------|------|------------|------|------|
| Movement:  | L           | T    | R    | L           | T    | R    | L          | T    | R    | L          | T    | R    |
| Min. Green:  | 7           | 10   | 10   | 7           | 10   | 10   | 7          | 10   | 10   | 7          | 10   | 10   |
| Y+R:   | 4.0         | 4.0  | 4.0  | 4.0         | 4.0  | 4.0  | 4.0        | 4.0  | 4.0  | 4.0        | 4.0  | 4.0  |
| Volume Module: >> Count Date: 12 May 2015 << 7:45-8:45AM |             |      |      |             |      |      |            |      |      |            |      |      |
| Base Vol:  | 98          | 1579 | 21   | 165         | 492  | 139  | 249        | 296  | 101  | 45         | 376  | 746  |
| Growth Adj:  | 1.00        | 1.00 | 1.00 | 1.00        | 1.00 | 1.00 | 1.00       | 1.00 | 1.00 | 1.00       | 1.00 | 1.00 |
| Initial Bse:   | 98          | 1579 | 21   | 165         | 492  | 139  | 249        | 296  | 101  | 45         | 376  | 746  |
| Added Vol:   | 0           | 0    | 0    | 0           | 0    | 0    | 0          | 0    | 0    | 0          | 0    | 0    |
| PasserByVol:   | 0           | 0    | 0    | 0           | 0    | 0    | 0          | 0    | 0    | 0          | 0    | 0    |
| Initial Fut:   | 98          | 1579 | 21   | 165         | 492  | 139  | 249        | 296  | 101  | 45         | 376  | 746  |
| User Adj:  | 1.00        | 1.00 | 1.00 | 1.00        | 1.00 | 1.00 | 1.00       | 1.00 | 1.00 | 1.00       | 1.00 | 0.00 |
| PHF Adj:   | 1.00        | 1.00 | 1.00 | 1.00        | 1.00 | 1.00 | 1.00       | 1.00 | 1.00 | 1.00       | 1.00 | 0.00 |
| PHF Volume:  | 98          | 1579 | 21   | 165         | 492  | 139  | 249        | 296  | 101  | 45         | 376  | 0    |
| Reduct Vol:  | 0           | 0    | 0    | 0           | 0    | 0    | 0          | 0    | 0    | 0          | 0    | 0    |
| Reduced Vol:   | 98          | 1579 | 21   | 165         | 492  | 139  | 249        | 296  | 101  | 45         | 376  | 0    |
| PCE Adj:   | 1.00        | 1.00 | 1.00 | 1.00        | 1.00 | 1.00 | 1.00       | 1.00 | 1.00 | 1.00       | 1.00 | 0.00 |
| MLF Adj:   | 1.00        | 1.00 | 1.00 | 1.00        | 1.00 | 1.00 | 1.00       | 1.00 | 1.00 | 1.00       | 1.00 | 0.00 |
| FinalVolume:   | 98          | 1579 | 21   | 165         | 492  | 139  | 249        | 296  | 101  | 45         | 376  | 0    |
| Saturation Flow Module:                                  |             |      |      |             |      |      |            |      |      |            |      |      |
| Sat/Lane:  | 1900        | 1900 | 1900 | 1900        | 1900 | 1900 | 1900       | 1900 | 1900 | 1900       | 1900 | 1900 |
| Adjustment:  | 0.92        | 0.97 | 0.95 | 0.83        | 0.83 | 0.92 | 0.92       | 1.00 | 0.92 | 0.92       | 1.00 | 0.92 |
| Lanes:   | 1.00        | 1.97 | 0.03 | 2.00        | 3.00 | 1.00 | 1.00       | 2.00 | 1.00 | 1.00       | 2.00 | 1.00 |
| Final Sat.:  | 1750        | 3651 | 49   | 3150        | 4750 | 1750 | 1750       | 3800 | 1750 | 1750       | 3800 | 1750 |
| Capacity Analysis Module:                                |             |      |      |             |      |      |            |      |      |            |      |      |
| Vol/Sat:   | 0.06        | 0.43 | 0.43 | 0.05        | 0.10 | 0.08 | 0.14       | 0.08 | 0.06 | 0.03       | 0.10 | 0.00 |
| Crit Moves:  | ****        | **** | **** | ****        | **** | **** | ****       | **** | **** | ****       | **** | **** |
| Green Time:  | 30.0        | 76.2 | 76.2 | 9.2         | 55.5 | 55.5 | 25.1       | 25.9 | 25.9 | 16.6       | 17.4 | 0.0  |
| Volume/Cap:  | 0.26        | 0.79 | 0.79 | 0.79        | 0.26 | 0.20 | 0.79       | 0.42 | 0.31 | 0.22       | 0.79 | 0.00 |
| Delay/Veh:   | 46.2        | 27.8 | 27.8 | 83.1        | 28.5 | 27.9 | 68.0       | 50.8 | 49.9 | 56.3       | 68.5 | 0.0  |
| User DelAdj:   | 1.00        | 1.00 | 1.00 | 1.00        | 1.00 | 1.00 | 1.00       | 1.00 | 1.00 | 1.00       | 1.00 | 1.00 |
| AdjDel/Veh:  | 46.2        | 27.8 | 27.8 | 83.1        | 28.5 | 27.9 | 68.0       | 50.8 | 49.9 | 56.3       | 68.5 | 0.0  |
| LOS by Move:   | D           | C    | C    | F           | C    | C    | E          | D    | D    | E          | E    | A    |
| HCM2k95thQ:  | 7           | 45   | 45   | 9           | 9    | 8    | 21         | 10   | 8    | 4          | 18   | 0    |

Note: Queue reported is the number of cars per lane.

BART

Level Of Service Computation Report  
2000 HCM Operations (Future Volume Alternative)  
PM - Existing Conditions

Intersection #3413: Coleman/Hedding [Study Int 38]

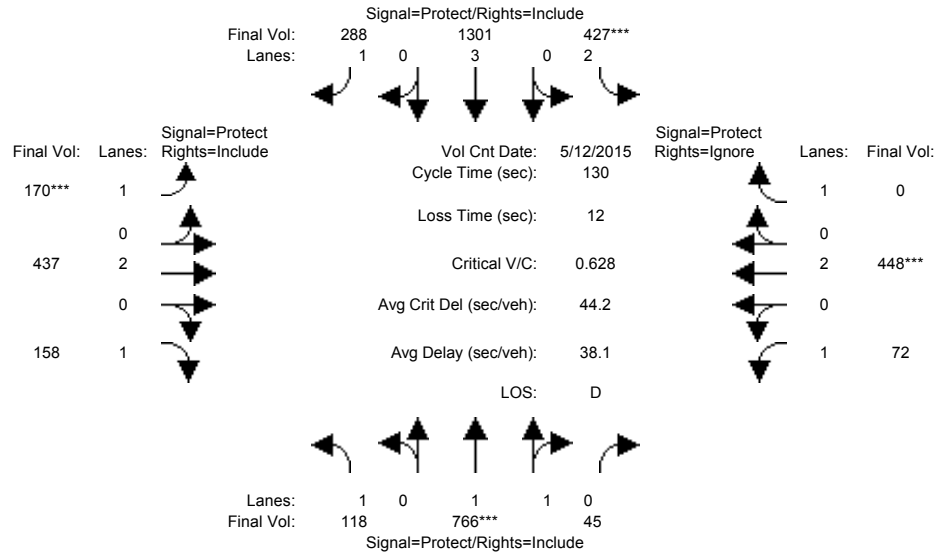

| Approach:  | North Bound |      |      | South Bound |      |      | East Bound |      |      | West Bound |      |      |
|--|-------------|------|------|-------------|------|------|------------|------|------|------------|------|------|
| Movement:  | L           | T    | R    | L           | T    | R    | L          | T    | R    | L          | T    | R    |
| Min. Green:  | 7           | 10   | 10   | 7           | 10   | 10   | 7          | 10   | 10   | 7          | 10   | 10   |
| Y+R:   | 4.0         | 4.0  | 4.0  | 4.0         | 4.0  | 4.0  | 4.0        | 4.0  | 4.0  | 4.0        | 4.0  | 4.0  |
| Volume Module: >> Count Date: 12 May 2015 << 5:00-6:00PM |             |      |      |             |      |      |            |      |      |            |      |      |
| Base Vol:  | 118         | 766  | 45   | 427         | 1301 | 288  | 170        | 437  | 158  | 72         | 448  | 328  |
| Growth Adj:  | 1.00        | 1.00 | 1.00 | 1.00        | 1.00 | 1.00 | 1.00       | 1.00 | 1.00 | 1.00       | 1.00 | 1.00 |
| Initial Bse:   | 118         | 766  | 45   | 427         | 1301 | 288  | 170        | 437  | 158  | 72         | 448  | 328  |
| Added Vol:   | 0           | 0    | 0    | 0           | 0    | 0    | 0          | 0    | 0    | 0          | 0    | 0    |
| PasserByVol:   | 0           | 0    | 0    | 0           | 0    | 0    | 0          | 0    | 0    | 0          | 0    | 0    |
| Initial Fut:   | 118         | 766  | 45   | 427         | 1301 | 288  | 170        | 437  | 158  | 72         | 448  | 328  |
| User Adj:  | 1.00        | 1.00 | 1.00 | 1.00        | 1.00 | 1.00 | 1.00       | 1.00 | 1.00 | 1.00       | 1.00 | 0.00 |
| PHF Adj:   | 1.00        | 1.00 | 1.00 | 1.00        | 1.00 | 1.00 | 1.00       | 1.00 | 1.00 | 1.00       | 1.00 | 0.00 |
| PHF Volume:  | 118         | 766  | 45   | 427         | 1301 | 288  | 170        | 437  | 158  | 72         | 448  | 0    |
| Reduct Vol:  | 0           | 0    | 0    | 0           | 0    | 0    | 0          | 0    | 0    | 0          | 0    | 0    |
| Reduced Vol:   | 118         | 766  | 45   | 427         | 1301 | 288  | 170        | 437  | 158  | 72         | 448  | 0    |
| PCE Adj:   | 1.00        | 1.00 | 1.00 | 1.00        | 1.00 | 1.00 | 1.00       | 1.00 | 1.00 | 1.00       | 1.00 | 0.00 |
| MLF Adj:   | 1.00        | 1.00 | 1.00 | 1.00        | 1.00 | 1.00 | 1.00       | 1.00 | 1.00 | 1.00       | 1.00 | 0.00 |
| Final Volume:  | 118         | 766  | 45   | 427         | 1301 | 288  | 170        | 437  | 158  | 72         | 448  | 0    |
| Saturation Flow Module:                                  |             |      |      |             |      |      |            |      |      |            |      |      |
| Sat/Lane:  | 1900        | 1900 | 1900 | 1900        | 1900 | 1900 | 1900       | 1900 | 1900 | 1900       | 1900 | 1900 |
| Adjustment:  | 0.92        | 0.98 | 0.95 | 0.83        | 0.83 | 0.92 | 0.92       | 1.00 | 0.92 | 0.92       | 1.00 | 0.92 |
| Lanes:   | 1.00        | 1.89 | 0.11 | 2.00        | 3.00 | 1.00 | 1.00       | 2.00 | 1.00 | 1.00       | 2.00 | 1.00 |
| Final Sat.:  | 1750        | 3495 | 205  | 3150        | 4750 | 1750 | 1750       | 3800 | 1750 | 1750       | 3800 | 1750 |
| Capacity Analysis Module:                                |             |      |      |             |      |      |            |      |      |            |      |      |
| Vol/Sat:   | 0.07        | 0.22 | 0.22 | 0.14        | 0.27 | 0.16 | 0.10       | 0.12 | 0.09 | 0.04       | 0.12 | 0.00 |
| Crit Moves:  | ****        | **** | **** | ****        | **** | **** | ****       | **** | **** | ****       | **** | **** |
| Green Time:  | 14.5        | 45.4 | 45.4 | 28.1        | 59.0 | 59.0 | 20.1       | 30.3 | 30.3 | 14.2       | 24.4 | 0.0  |
| Volume/Cap:  | 0.60        | 0.63 | 0.63 | 0.63        | 0.60 | 0.36 | 0.63       | 0.49 | 0.39 | 0.38       | 0.63 | 0.00 |
| Delay/Veh:   | 60.3        | 36.3 | 36.3 | 48.1        | 27.2 | 23.5 | 56.1       | 43.6 | 42.6 | 55.0       | 50.4 | 0.0  |
| User DelAdj:   | 1.00        | 1.00 | 1.00 | 1.00        | 1.00 | 1.00 | 1.00       | 1.00 | 1.00 | 1.00       | 1.00 | 1.00 |
| AdjDel/Veh:  | 60.3        | 36.3 | 36.3 | 48.1        | 27.2 | 23.5 | 56.1       | 43.6 | 42.6 | 55.0       | 50.4 | 0.0  |
| LOS by Move:   | E           | D    | D    | D           | C    | C    | E          | D    | D    | E          | D    | A    |
| HCM2k95thQ:  | 9           | 24   | 24   | 17          | 23   | 15   | 13         | 14   | 11   | 6          | 17   | 0    |

Note: Queue reported is the number of cars per lane.

BART

Level Of Service Computation Report  
2000 HCM Operations (Future Volume Alternative)  
AM - Existing Conditions

Intersection #3417: Coleman/Taylor [Study Int 39]

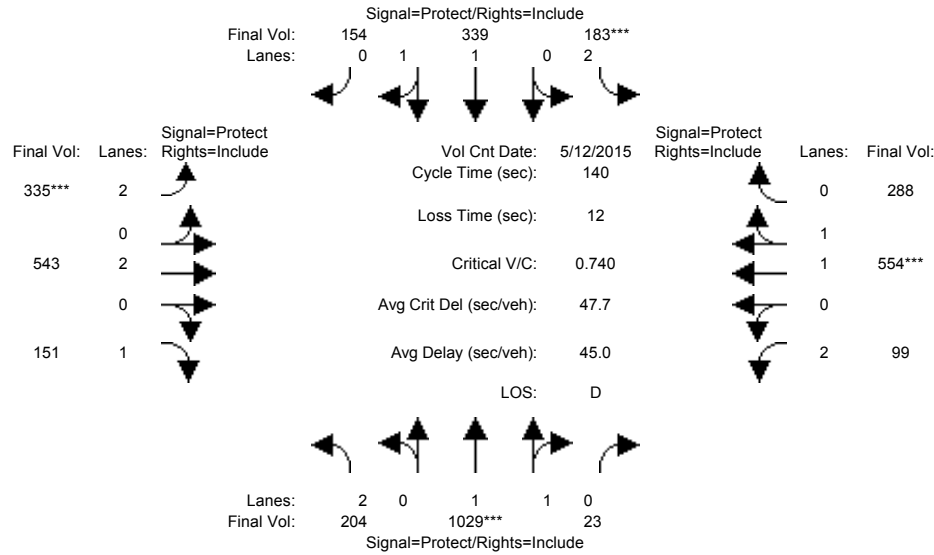

| Approach:  | North Bound |      |      | South Bound |      |      | East Bound |      |      | West Bound |      |      |
|--|-------------|------|------|-------------|------|------|------------|------|------|------------|------|------|
| Movement:  | L           | T    | R    | L           | T    | R    | L          | T    | R    | L          | T    | R    |
| Min. Green:  | 7           | 10   | 10   | 7           | 10   | 10   | 7          | 10   | 10   | 7          | 10   | 10   |
| Y+R:   | 4.0         | 4.0  | 4.0  | 4.0         | 4.0  | 4.0  | 4.0        | 4.0  | 4.0  | 4.0        | 4.0  | 4.0  |
| Volume Module: >> Count Date: 12 May 2015 << 7:30-8:30AM |             |      |      |             |      |      |            |      |      |            |      |      |
| Base Vol:  | 204         | 1029 | 23   | 183         | 339  | 154  | 335        | 543  | 151  | 99         | 554  | 288  |
| Growth Adj:  | 1.00        | 1.00 | 1.00 | 1.00        | 1.00 | 1.00 | 1.00       | 1.00 | 1.00 | 1.00       | 1.00 | 1.00 |
| Initial Bse:   | 204         | 1029 | 23   | 183         | 339  | 154  | 335        | 543  | 151  | 99         | 554  | 288  |
| Added Vol:   | 0           | 0    | 0    | 0           | 0    | 0    | 0          | 0    | 0    | 0          | 0    | 0    |
| PasserByVol:   | 0           | 0    | 0    | 0           | 0    | 0    | 0          | 0    | 0    | 0          | 0    | 0    |
| Initial Fut:   | 204         | 1029 | 23   | 183         | 339  | 154  | 335        | 543  | 151  | 99         | 554  | 288  |
| User Adj:  | 1.00        | 1.00 | 1.00 | 1.00        | 1.00 | 1.00 | 1.00       | 1.00 | 1.00 | 1.00       | 1.00 | 1.00 |
| PHF Adj:   | 1.00        | 1.00 | 1.00 | 1.00        | 1.00 | 1.00 | 1.00       | 1.00 | 1.00 | 1.00       | 1.00 | 1.00 |
| PHF Volume:  | 204         | 1029 | 23   | 183         | 339  | 154  | 335        | 543  | 151  | 99         | 554  | 288  |
| Reduct Vol:  | 0           | 0    | 0    | 0           | 0    | 0    | 0          | 0    | 0    | 0          | 0    | 0    |
| Reduced Vol:   | 204         | 1029 | 23   | 183         | 339  | 154  | 335        | 543  | 151  | 99         | 554  | 288  |
| PCE Adj:   | 1.00        | 1.00 | 1.00 | 1.00        | 1.00 | 1.00 | 1.00       | 1.00 | 1.00 | 1.00       | 1.00 | 1.00 |
| MLF Adj:   | 1.00        | 1.00 | 1.00 | 1.00        | 1.00 | 1.00 | 1.00       | 1.00 | 1.00 | 1.00       | 1.00 | 1.00 |
| Final Volume:  | 204         | 1029 | 23   | 183         | 339  | 154  | 335        | 543  | 151  | 99         | 554  | 288  |
| Saturation Flow Module:                                  |             |      |      |             |      |      |            |      |      |            |      |      |
| Sat/Lane:  | 1900        | 1900 | 1900 | 1900        | 1900 | 1900 | 1900       | 1900 | 1900 | 1900       | 1900 | 1900 |
| Adjustment:  | 0.83        | 0.97 | 0.95 | 0.83        | 0.99 | 0.95 | 0.83       | 1.00 | 0.92 | 0.83       | 0.99 | 0.95 |
| Lanes:   | 2.00        | 1.96 | 0.04 | 2.00        | 1.36 | 0.64 | 2.00       | 2.00 | 1.00 | 2.00       | 1.30 | 0.70 |
| Final Sat.:  | 3150        | 3619 | 81   | 3150        | 2543 | 1155 | 3150       | 3800 | 1750 | 3150       | 2434 | 1265 |
| Capacity Analysis Module:                                |             |      |      |             |      |      |            |      |      |            |      |      |
| Vol/Sat:   | 0.06        | 0.28 | 0.28 | 0.06        | 0.13 | 0.13 | 0.11       | 0.14 | 0.09 | 0.03       | 0.23 | 0.23 |
| Crit Moves:  | ****        | **** | **** | ****        | **** | **** | ****       | **** | **** | ****       | **** | **** |
| Green Time:  | 21.2        | 53.8 | 53.8 | 11.0        | 43.6 | 43.6 | 20.1       | 46.8 | 46.8 | 16.4       | 43.1 | 43.1 |
| Volume/Cap:  | 0.43        | 0.74 | 0.74 | 0.74        | 0.43 | 0.43 | 0.74       | 0.43 | 0.26 | 0.27       | 0.74 | 0.74 |
| Delay/Veh:   | 54.5        | 39.2 | 39.2 | 74.4        | 38.5 | 38.5 | 63.8       | 36.4 | 34.2 | 56.7       | 46.1 | 46.1 |
| User DelAdj:   | 1.00        | 1.00 | 1.00 | 1.00        | 1.00 | 1.00 | 1.00       | 1.00 | 1.00 | 1.00       | 1.00 | 1.00 |
| AdjDel/Veh:  | 54.5        | 39.2 | 39.2 | 74.4        | 38.5 | 38.5 | 63.8       | 36.4 | 34.2 | 56.7       | 46.1 | 46.1 |
| LOS by Move:   | D           | D    | D    | E           | D    | D    | E          | D    | C    | E          | D    | D    |
| HCM2k95thQ:  | 10          | 35   | 35   | 10          | 16   | 16   | 16         | 16   | 9    | 5          | 29   | 29   |

Note: Queue reported is the number of cars per lane.



BART

Level Of Service Computation Report  
2000 HCM Operations (Future Volume Alternative)  
PM - Existing Conditions

Intersection #3417: Coleman/Taylor [Study Int 39]

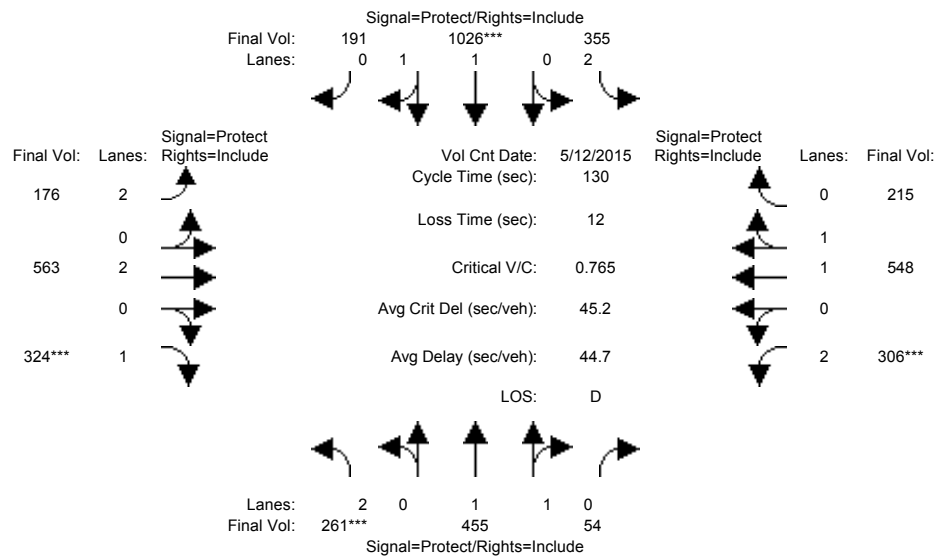

| Approach:  | North Bound |      |      | South Bound |      |      | East Bound |      |      | West Bound |      |      |
|--|-------------|------|------|-------------|------|------|------------|------|------|------------|------|------|
| Movement:  | L           | T    | R    | L           | T    | R    | L          | T    | R    | L          | T    | R    |
| Min. Green:  | 7           | 10   | 10   | 7           | 10   | 10   | 7          | 10   | 10   | 7          | 10   | 10   |
| Y+R:   | 4.0         | 4.0  | 4.0  | 4.0         | 4.0  | 4.0  | 4.0        | 4.0  | 4.0  | 4.0        | 4.0  | 4.0  |
| Volume Module: >> Count Date: 12 May 2015 << 5:00-6:00PM |             |      |      |             |      |      |            |      |      |            |      |      |
| Base Vol:  | 261         | 455  | 54   | 355         | 1026 | 191  | 176        | 563  | 324  | 306        | 548  | 215  |
| Growth Adj:  | 1.00        | 1.00 | 1.00 | 1.00        | 1.00 | 1.00 | 1.00       | 1.00 | 1.00 | 1.00       | 1.00 | 1.00 |
| Initial Bse:   | 261         | 455  | 54   | 355         | 1026 | 191  | 176        | 563  | 324  | 306        | 548  | 215  |
| Added Vol:   | 0           | 0    | 0    | 0           | 0    | 0    | 0          | 0    | 0    | 0          | 0    | 0    |
| PasserByVol:   | 0           | 0    | 0    | 0           | 0    | 0    | 0          | 0    | 0    | 0          | 0    | 0    |
| Initial Fut:   | 261         | 455  | 54   | 355         | 1026 | 191  | 176        | 563  | 324  | 306        | 548  | 215  |
| User Adj:  | 1.00        | 1.00 | 1.00 | 1.00        | 1.00 | 1.00 | 1.00       | 1.00 | 1.00 | 1.00       | 1.00 | 1.00 |
| PHF Adj:   | 1.00        | 1.00 | 1.00 | 1.00        | 1.00 | 1.00 | 1.00       | 1.00 | 1.00 | 1.00       | 1.00 | 1.00 |
| PHF Volume:  | 261         | 455  | 54   | 355         | 1026 | 191  | 176        | 563  | 324  | 306        | 548  | 215  |
| Reduct Vol:  | 0           | 0    | 0    | 0           | 0    | 0    | 0          | 0    | 0    | 0          | 0    | 0    |
| Reduced Vol:   | 261         | 455  | 54   | 355         | 1026 | 191  | 176        | 563  | 324  | 306        | 548  | 215  |
| PCE Adj:   | 1.00        | 1.00 | 1.00 | 1.00        | 1.00 | 1.00 | 1.00       | 1.00 | 1.00 | 1.00       | 1.00 | 1.00 |
| MLF Adj:   | 1.00        | 1.00 | 1.00 | 1.00        | 1.00 | 1.00 | 1.00       | 1.00 | 1.00 | 1.00       | 1.00 | 1.00 |
| Final Volume:  | 261         | 455  | 54   | 355         | 1026 | 191  | 176        | 563  | 324  | 306        | 548  | 215  |
| Saturation Flow Module:                                  |             |      |      |             |      |      |            |      |      |            |      |      |
| Sat/Lane:  | 1900        | 1900 | 1900 | 1900        | 1900 | 1900 | 1900       | 1900 | 1900 | 1900       | 1900 | 1900 |
| Adjustment:  | 0.83        | 0.98 | 0.95 | 0.83        | 0.98 | 0.95 | 0.83       | 1.00 | 0.92 | 0.83       | 0.98 | 0.95 |
| Lanes:   | 2.00        | 1.78 | 0.22 | 2.00        | 1.68 | 0.32 | 2.00       | 2.00 | 1.00 | 2.00       | 1.42 | 0.58 |
| Final Sat.:  | 3150        | 3307 | 392  | 3150        | 3119 | 581  | 3150       | 3800 | 1750 | 3150       | 2657 | 1042 |
| Capacity Analysis Module:                                |             |      |      |             |      |      |            |      |      |            |      |      |
| Vol/Sat:   | 0.08        | 0.14 | 0.14 | 0.11        | 0.33 | 0.33 | 0.06       | 0.15 | 0.19 | 0.10       | 0.21 | 0.21 |
| Crit Moves:  | ****        |      |      | ****        |      |      | ****       |      | **** | ****       |      |      |
| Green Time:  | 14.1        | 38.5 | 38.5 | 31.5        | 55.9 | 55.9 | 10.2       | 31.5 | 31.5 | 16.5       | 37.8 | 37.8 |
| Volume/Cap:  | 0.76        | 0.46 | 0.46 | 0.46        | 0.76 | 0.76 | 0.71       | 0.61 | 0.76 | 0.76       | 0.71 | 0.71 |
| Delay/Veh:   | 66.2        | 37.7 | 37.7 | 42.5        | 33.7 | 33.7 | 67.7       | 45.1 | 53.9 | 63.4       | 43.5 | 43.5 |
| User DelAdj:   | 1.00        | 1.00 | 1.00 | 1.00        | 1.00 | 1.00 | 1.00       | 1.00 | 1.00 | 1.00       | 1.00 | 1.00 |
| AdjDel/Veh:  | 66.2        | 37.7 | 37.7 | 42.5        | 33.7 | 33.7 | 67.7       | 45.1 | 53.9 | 63.4       | 43.5 | 43.5 |
| LOS by Move:   | E           | D    | D    | D           | C    | C    | E          | D    | D    | E          | D    | D    |
| HCM2k95thQ:  | 15          | 16   | 16   | 13          | 35   | 35   | 8          | 18   | 23   | 14         | 25   | 25   |

Note: Queue reported is the number of cars per lane.

BART

Level Of Service Computation Report  
2000 HCM Operations (Future Volume Alternative)  
AM - Existing Conditions

Intersection #3596: JACKSON/McKEE [Study Int 8]

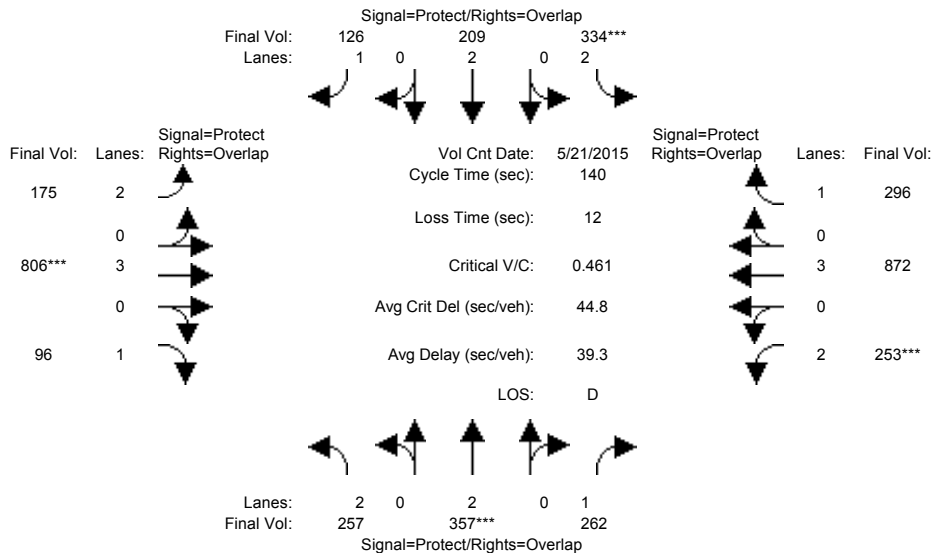

| Approach:  | North Bound |      |      | South Bound |      |      | East Bound |      |      | West Bound |      |      |
|--|-------------|------|------|-------------|------|------|------------|------|------|------------|------|------|
| Movement:  | L           | T    | R    | L           | T    | R    | L          | T    | R    | L          | T    | R    |
| Min. Green:  | 7           | 10   | 10   | 7           | 10   | 10   | 7          | 10   | 10   | 7          | 10   | 10   |
| Y+R:   | 4.0         | 4.0  | 4.0  | 4.0         | 4.0  | 4.0  | 4.0        | 4.0  | 4.0  | 4.0        | 4.0  | 4.0  |
| Volume Module: >> Count Date: 21 May 2015 << 7:30-8:30AM |             |      |      |             |      |      |            |      |      |            |      |      |
| Base Vol:  | 257         | 357  | 262  | 334         | 209  | 126  | 175        | 806  | 96   | 253        | 872  | 296  |
| Growth Adj:  | 1.00        | 1.00 | 1.00 | 1.00        | 1.00 | 1.00 | 1.00       | 1.00 | 1.00 | 1.00       | 1.00 | 1.00 |
| Initial Bse:   | 257         | 357  | 262  | 334         | 209  | 126  | 175        | 806  | 96   | 253        | 872  | 296  |
| Added Vol:   | 0           | 0    | 0    | 0           | 0    | 0    | 0          | 0    | 0    | 0          | 0    | 0    |
| PasserByVol:   | 0           | 0    | 0    | 0           | 0    | 0    | 0          | 0    | 0    | 0          | 0    | 0    |
| Initial Fut:   | 257         | 357  | 262  | 334         | 209  | 126  | 175        | 806  | 96   | 253        | 872  | 296  |
| User Adj:  | 1.00        | 1.00 | 1.00 | 1.00        | 1.00 | 1.00 | 1.00       | 1.00 | 1.00 | 1.00       | 1.00 | 1.00 |
| PHF Adj:   | 1.00        | 1.00 | 1.00 | 1.00        | 1.00 | 1.00 | 1.00       | 1.00 | 1.00 | 1.00       | 1.00 | 1.00 |
| PHF Volume:  | 257         | 357  | 262  | 334         | 209  | 126  | 175        | 806  | 96   | 253        | 872  | 296  |
| Reduct Vol:  | 0           | 0    | 0    | 0           | 0    | 0    | 0          | 0    | 0    | 0          | 0    | 0    |
| Reduced Vol:   | 257         | 357  | 262  | 334         | 209  | 126  | 175        | 806  | 96   | 253        | 872  | 296  |
| PCE Adj:   | 1.00        | 1.00 | 1.00 | 1.00        | 1.00 | 1.00 | 1.00       | 1.00 | 1.00 | 1.00       | 1.00 | 1.00 |
| MLF Adj:   | 1.00        | 1.00 | 1.00 | 1.00        | 1.00 | 1.00 | 1.00       | 1.00 | 1.00 | 1.00       | 1.00 | 1.00 |
| Final Volume:  | 257         | 357  | 262  | 334         | 209  | 126  | 175        | 806  | 96   | 253        | 872  | 296  |
| Saturation Flow Module:                                  |             |      |      |             |      |      |            |      |      |            |      |      |
| Sat/Lane:  | 1900        | 1900 | 1900 | 1900        | 1900 | 1900 | 1900       | 1900 | 1900 | 1900       | 1900 | 1900 |
| Adjustment:  | 0.83        | 1.00 | 0.92 | 0.83        | 1.00 | 0.92 | 0.83       | 1.00 | 0.92 | 0.83       | 1.00 | 0.92 |
| Lanes:   | 2.00        | 2.00 | 1.00 | 2.00        | 2.00 | 1.00 | 2.00       | 3.00 | 1.00 | 2.00       | 3.00 | 1.00 |
| Final Sat.:  | 3150        | 3800 | 1750 | 3150        | 3800 | 1750 | 3150       | 5700 | 1750 | 3150       | 5700 | 1750 |
| Capacity Analysis Module:                                |             |      |      |             |      |      |            |      |      |            |      |      |
| Vol/Sat:   | 0.08        | 0.09 | 0.15 | 0.11        | 0.06 | 0.07 | 0.06       | 0.14 | 0.05 | 0.08       | 0.15 | 0.17 |
| Crit Moves:  | ****        | **** | **** | ****        | **** | **** | ****       | **** | **** | ****       | **** | **** |
| Green Time:  | 32.4        | 28.5 | 52.9 | 32.2        | 28.3 | 46.3 | 17.9       | 42.9 | 75.3 | 24.4       | 49.4 | 81.6 |
| Volume/Cap:  | 0.35        | 0.46 | 0.40 | 0.46        | 0.27 | 0.22 | 0.43       | 0.46 | 0.10 | 0.46       | 0.43 | 0.29 |
| Delay/Veh:   | 45.3        | 49.4 | 32.3 | 46.9        | 47.3 | 34.0 | 57.1       | 39.4 | 15.9 | 52.5       | 34.8 | 14.8 |
| User DelAdj:   | 1.00        | 1.00 | 1.00 | 1.00        | 1.00 | 1.00 | 1.00       | 1.00 | 1.00 | 1.00       | 1.00 | 1.00 |
| AdjDel/Veh:  | 45.3        | 49.4 | 32.3 | 46.9        | 47.3 | 34.0 | 57.1       | 39.4 | 15.9 | 52.5       | 34.8 | 14.8 |
| LOS by Move:   | D           | D    | C    | D           | D    | C    | E          | D    | B    | D          | C    | B    |
| HCM2k95thQ:  | 11          | 13   | 16   | 14          | 7    | 8    | 8          | 17   | 4    | 12         | 17   | 13   |

Note: Queue reported is the number of cars per lane.

BART

Level Of Service Computation Report  
2000 HCM Operations (Future Volume Alternative)  
PM - Existing Conditions

Intersection #3596: JACKSON/McKEE [Study Int 8]

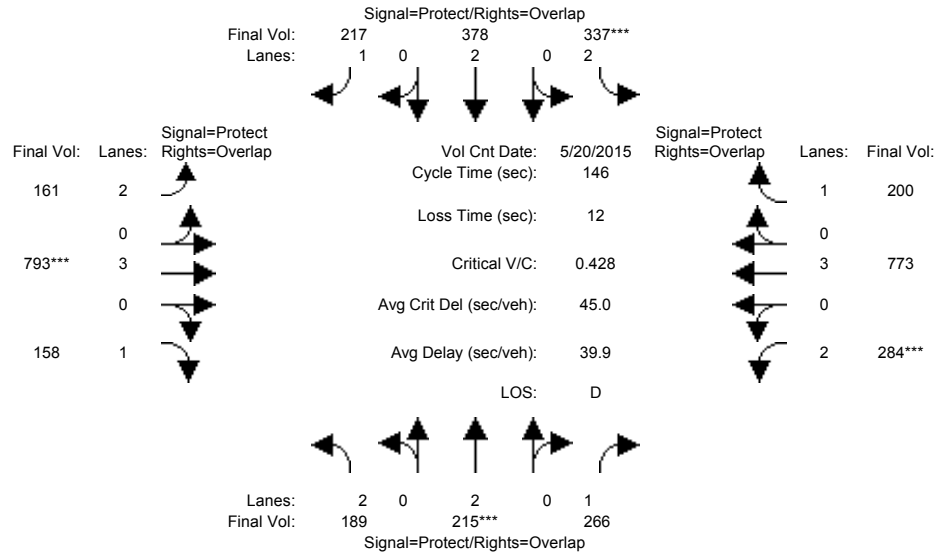

| Approach:  | North Bound |      |      | South Bound |      |      | East Bound |      |      | West Bound |      |      |
|--|-------------|------|------|-------------|------|------|------------|------|------|------------|------|------|
| Movement:  | L           | T    | R    | L           | T    | R    | L          | T    | R    | L          | T    | R    |
| Min. Green:  | 7           | 10   | 10   | 7           | 10   | 10   | 7          | 10   | 10   | 7          | 10   | 10   |
| Y+R:   | 4.0         | 4.0  | 4.0  | 4.0         | 4.0  | 4.0  | 4.0        | 4.0  | 4.0  | 4.0        | 4.0  | 4.0  |
| Volume Module: >> Count Date: 20 May 2015 << 5:00-6:00PM |             |      |      |             |      |      |            |      |      |            |      |      |
| Base Vol:  | 189         | 215  | 266  | 337         | 378  | 217  | 161        | 793  | 158  | 284        | 773  | 200  |
| Growth Adj:  | 1.00        | 1.00 | 1.00 | 1.00        | 1.00 | 1.00 | 1.00       | 1.00 | 1.00 | 1.00       | 1.00 | 1.00 |
| Initial Bse:   | 189         | 215  | 266  | 337         | 378  | 217  | 161        | 793  | 158  | 284        | 773  | 200  |
| Added Vol:   | 0           | 0    | 0    | 0           | 0    | 0    | 0          | 0    | 0    | 0          | 0    | 0    |
| PasserByVol:   | 0           | 0    | 0    | 0           | 0    | 0    | 0          | 0    | 0    | 0          | 0    | 0    |
| Initial Fut:   | 189         | 215  | 266  | 337         | 378  | 217  | 161        | 793  | 158  | 284        | 773  | 200  |
| User Adj:  | 1.00        | 1.00 | 1.00 | 1.00        | 1.00 | 1.00 | 1.00       | 1.00 | 1.00 | 1.00       | 1.00 | 1.00 |
| PHF Adj:   | 1.00        | 1.00 | 1.00 | 1.00        | 1.00 | 1.00 | 1.00       | 1.00 | 1.00 | 1.00       | 1.00 | 1.00 |
| PHF Volume:  | 189         | 215  | 266  | 337         | 378  | 217  | 161        | 793  | 158  | 284        | 773  | 200  |
| Reduct Vol:  | 0           | 0    | 0    | 0           | 0    | 0    | 0          | 0    | 0    | 0          | 0    | 0    |
| Reduced Vol:   | 189         | 215  | 266  | 337         | 378  | 217  | 161        | 793  | 158  | 284        | 773  | 200  |
| PCE Adj:   | 1.00        | 1.00 | 1.00 | 1.00        | 1.00 | 1.00 | 1.00       | 1.00 | 1.00 | 1.00       | 1.00 | 1.00 |
| MLF Adj:   | 1.00        | 1.00 | 1.00 | 1.00        | 1.00 | 1.00 | 1.00       | 1.00 | 1.00 | 1.00       | 1.00 | 1.00 |
| Final Volume:  | 189         | 215  | 266  | 337         | 378  | 217  | 161        | 793  | 158  | 284        | 773  | 200  |
| Saturation Flow Module:                                  |             |      |      |             |      |      |            |      |      |            |      |      |
| Sat/Lane:  | 1900        | 1900 | 1900 | 1900        | 1900 | 1900 | 1900       | 1900 | 1900 | 1900       | 1900 | 1900 |
| Adjustment:  | 0.83        | 1.00 | 0.92 | 0.83        | 1.00 | 0.92 | 0.83       | 1.00 | 0.92 | 0.83       | 1.00 | 0.92 |
| Lanes:   | 2.00        | 2.00 | 1.00 | 2.00        | 2.00 | 1.00 | 2.00       | 3.00 | 1.00 | 2.00       | 3.00 | 1.00 |
| Final Sat.:  | 3150        | 3800 | 1750 | 3150        | 3800 | 1750 | 3150       | 5700 | 1750 | 3150       | 5700 | 1750 |
| Capacity Analysis Module:                                |             |      |      |             |      |      |            |      |      |            |      |      |
| Vol/Sat:   | 0.06        | 0.06 | 0.15 | 0.11        | 0.10 | 0.12 | 0.05       | 0.14 | 0.09 | 0.09       | 0.14 | 0.11 |
| Crit Moves:  | ****        | **** | **** | ****        | **** | **** | ****       | **** | **** | ****       | **** | **** |
| Green Time:  | 21.0        | 19.3 | 50.1 | 36.5        | 34.8 | 56.2 | 21.4       | 47.5 | 68.4 | 30.8       | 56.8 | 93.3 |
| Volume/Cap:  | 0.42        | 0.43 | 0.44 | 0.43        | 0.42 | 0.32 | 0.35       | 0.43 | 0.19 | 0.43       | 0.35 | 0.18 |
| Delay/Veh:   | 57.6        | 58.9 | 37.7 | 46.4        | 47.3 | 31.8 | 56.5       | 38.8 | 22.8 | 50.4       | 31.6 | 10.8 |
| User DelAdj:   | 1.00        | 1.00 | 1.00 | 1.00        | 1.00 | 1.00 | 1.00       | 1.00 | 1.00 | 1.00       | 1.00 | 1.00 |
| AdjDel/Veh:  | 57.6        | 58.9 | 37.7 | 46.4        | 47.3 | 31.8 | 56.5       | 38.8 | 22.8 | 50.4       | 31.6 | 10.8 |
| LOS by Move:   | E           | E    | D    | D           | D    | C    | E          | D    | C    | D          | C    | B    |
| HCM2k95thQ:  | 10          | 9    | 18   | 14          | 13   | 13   | 7          | 17   | 8    | 13         | 15   | 8    |

Note: Queue reported is the number of cars per lane.

BART

Level Of Service Computation Report  
2000 HCM Operations (Future Volume Alternative)  
AM - Existing Conditions

Intersection #3612: JULIAN/21ST [Study Int 1]

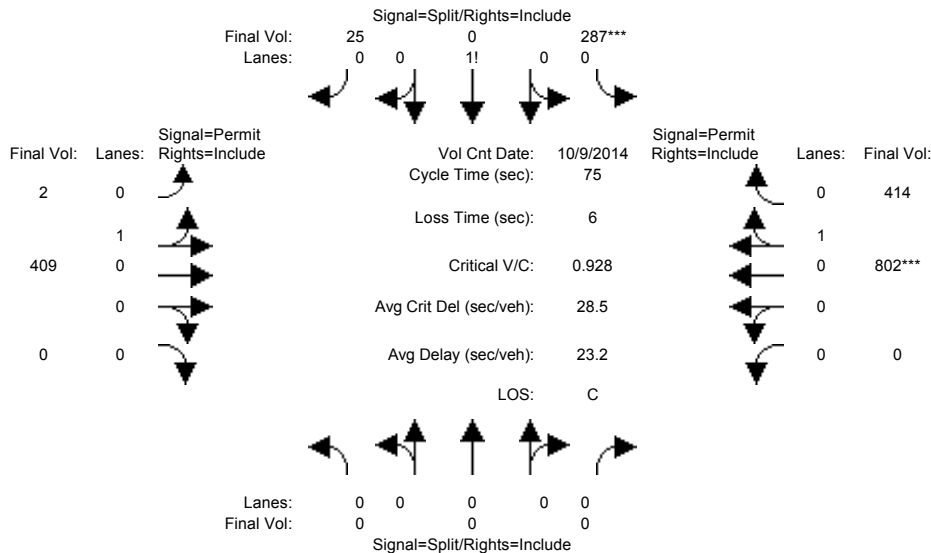

| Approach:                                   | North Bound |      |      | South Bound |      |      | East Bound |      |      | West Bound |      |      |
|---|-------------|------|------|-------------|------|------|------------|------|------|------------|------|------|
| Movement:                                   | L           | T    | R    | L           | T    | R    | L          | T    | R    | L          | T    | R    |
| Min. Green:                                 | 0           | 0    | 0    | 10          | 0    | 10   | 10         | 10   | 0    | 0          | 10   | 10   |
| Y+R:  | 4.0         | 4.0  | 4.0  | 4.0         | 4.0  | 4.0  | 4.0        | 4.0  | 4.0  | 4.0        | 4.0  | 4.0  |
| Volume Module: >> Count Date: 9 Oct 2014 << |             |      |      |             |      |      |            |      |      |            |      |      |
| Base Vol:                                   | 0           | 0    | 0    | 287         | 0    | 25   | 2          | 409  | 0    | 0          | 802  | 414  |
| Growth Adj:                                 | 1.00        | 1.00 | 1.00 | 1.00        | 1.00 | 1.00 | 1.00       | 1.00 | 1.00 | 1.00       | 1.00 | 1.00 |
| Initial Bse:                                | 0           | 0    | 0    | 287         | 0    | 25   | 2          | 409  | 0    | 0          | 802  | 414  |
| Added Vol:                                  | 0           | 0    | 0    | 0           | 0    | 0    | 0          | 0    | 0    | 0          | 0    | 0    |
| PasserByVol:                                | 0           | 0    | 0    | 0           | 0    | 0    | 0          | 0    | 0    | 0          | 0    | 0    |
| Initial Fut:                                | 0           | 0    | 0    | 287         | 0    | 25   | 2          | 409  | 0    | 0          | 802  | 414  |
| User Adj:                                   | 1.00        | 1.00 | 1.00 | 1.00        | 1.00 | 1.00 | 1.00       | 1.00 | 1.00 | 1.00       | 1.00 | 1.00 |
| PHF Adj:                                    | 1.00        | 1.00 | 1.00 | 1.00        | 1.00 | 1.00 | 1.00       | 1.00 | 1.00 | 1.00       | 1.00 | 1.00 |
| PHF Volume:                                 | 0           | 0    | 0    | 287         | 0    | 25   | 2          | 409  | 0    | 0          | 802  | 414  |
| Reduct Vol:                                 | 0           | 0    | 0    | 0           | 0    | 0    | 0          | 0    | 0    | 0          | 0    | 0    |
| Reduced Vol:                                | 0           | 0    | 0    | 287         | 0    | 25   | 2          | 409  | 0    | 0          | 802  | 414  |
| PCE Adj:                                    | 1.00        | 1.00 | 1.00 | 1.00        | 1.00 | 1.00 | 1.00       | 1.00 | 1.00 | 1.00       | 1.00 | 1.00 |
| MLF Adj:                                    | 1.00        | 1.00 | 1.00 | 1.00        | 1.00 | 1.00 | 1.00       | 1.00 | 1.00 | 1.00       | 1.00 | 1.00 |
| Final Volume:                               | 0           | 0    | 0    | 287         | 0    | 25   | 2          | 409  | 0    | 0          | 802  | 414  |
| Saturation Flow Module:                     |             |      |      |             |      |      |            |      |      |            |      |      |
| Sat/Lane:                                   | 1900        | 1900 | 1900 | 1900        | 1900 | 1900 | 1900       | 1900 | 1900 | 1900       | 1900 | 1900 |
| Adjustment:                                 | 0.92        | 1.00 | 0.92 | 0.92        | 0.92 | 0.92 | 0.95       | 0.95 | 0.92 | 0.92       | 0.95 | 0.95 |
| Lanes:                                      | 0.00        | 0.00 | 0.00 | 0.92        | 0.00 | 0.08 | 0.01       | 0.99 | 0.00 | 0.00       | 0.66 | 0.34 |
| Final Sat.:                                 | 0           | 0    | 0    | 1610        | 0    | 140  | 9          | 1791 | 0    | 0          | 1187 | 613  |
| Capacity Analysis Module:                   |             |      |      |             |      |      |            |      |      |            |      |      |
| Vol/Sat:                                    | 0.00        | 0.00 | 0.00 | 0.18        | 0.00 | 0.18 | 0.23       | 0.23 | 0.00 | 0.00       | 0.68 | 0.68 |
| Crit Moves:                                 | ****        |      |      |             |      |      |            |      |      |            |      |      |
| Green Time:                                 | 0.0         | 0.0  | 0.0  | 14.4        | 0.0  | 14.4 | 54.6       | 54.6 | 0.0  | 0.0        | 54.6 | 54.6 |
| Volume/Cap:                                 | 0.00        | 0.00 | 0.00 | 0.93        | 0.00 | 0.93 | 0.31       | 0.31 | 0.00 | 0.00       | 0.93 | 0.93 |
| Delay/Veh:                                  | 0.0         | 0.0  | 0.0  | 60.9        | 0.0  | 60.9 | 3.7        | 3.7  | 0.0  | 0.0        | 20.1 | 20.1 |
| User DelAdj:                                | 1.00        | 1.00 | 1.00 | 1.00        | 1.00 | 1.00 | 1.00       | 1.00 | 1.00 | 1.00       | 1.00 | 1.00 |
| AdjDel/Veh:                                 | 0.0         | 0.0  | 0.0  | 60.9        | 0.0  | 60.9 | 3.7        | 3.7  | 0.0  | 0.0        | 20.1 | 20.1 |
| LOS by Move:                                | A           | A    | A    | E           | A    | E    | A          | A    | A    | A          | C    | C    |
| HCM2k95thQ:                                 | 0           | 0    | 0    | 22          | 0    | 22   | 7          | 7    | 0    | 0          | 46   | 46   |

Note: Queue reported is the number of cars per lane.

BART

Level Of Service Computation Report  
2000 HCM Operations (Future Volume Alternative)  
PM - Existing Conditions

Intersection #3612: JULIAN/21ST [Study Int 1]

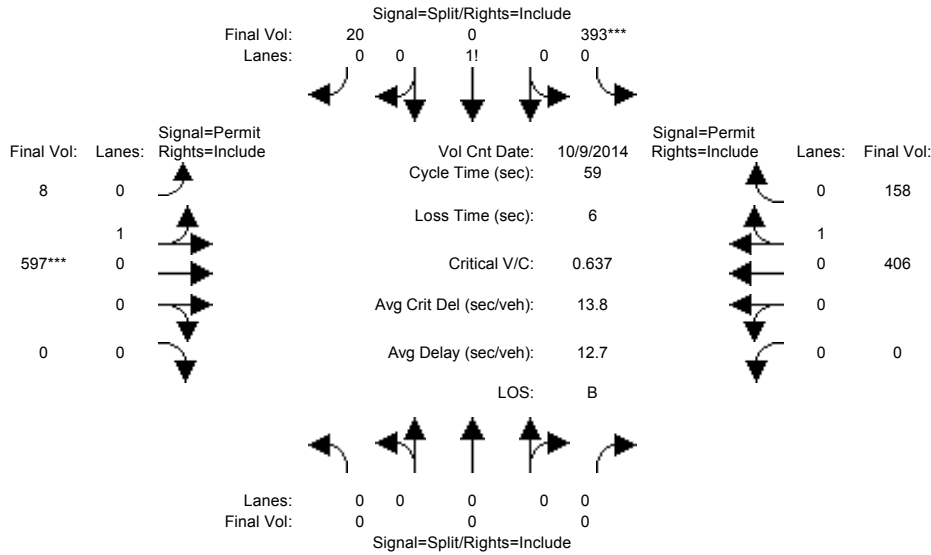

| Approach:                                   | North Bound |      |      | South Bound |      |      | East Bound |      |      | West Bound |      |      |
|---|-------------|------|------|-------------|------|------|------------|------|------|------------|------|------|
| Movement:                                   | L           | T    | R    | L           | T    | R    | L          | T    | R    | L          | T    | R    |
| Min. Green:                                 | 0           | 0    | 0    | 10          | 0    | 10   | 10         | 10   | 0    | 0          | 10   | 10   |
| Y+R:  | 4.0         | 4.0  | 4.0  | 4.0         | 4.0  | 4.0  | 4.0        | 4.0  | 4.0  | 4.0        | 4.0  | 4.0  |
| Volume Module: >> Count Date: 9 Oct 2014 << |             |      |      |             |      |      |            |      |      |            |      |      |
| Base Vol:                                   | 0           | 0    | 0    | 393         | 0    | 20   | 8          | 597  | 0    | 0          | 406  | 158  |
| Growth Adj:                                 | 1.00        | 1.00 | 1.00 | 1.00        | 1.00 | 1.00 | 1.00       | 1.00 | 1.00 | 1.00       | 1.00 | 1.00 |
| Initial Bse:                                | 0           | 0    | 0    | 393         | 0    | 20   | 8          | 597  | 0    | 0          | 406  | 158  |
| Added Vol:                                  | 0           | 0    | 0    | 0           | 0    | 0    | 0          | 0    | 0    | 0          | 0    | 0    |
| PasserByVol:                                | 0           | 0    | 0    | 0           | 0    | 0    | 0          | 0    | 0    | 0          | 0    | 0    |
| Initial Fut:                                | 0           | 0    | 0    | 393         | 0    | 20   | 8          | 597  | 0    | 0          | 406  | 158  |
| User Adj:                                   | 1.00        | 1.00 | 1.00 | 1.00        | 1.00 | 1.00 | 1.00       | 1.00 | 1.00 | 1.00       | 1.00 | 1.00 |
| PHF Adj:                                    | 1.00        | 1.00 | 1.00 | 1.00        | 1.00 | 1.00 | 1.00       | 1.00 | 1.00 | 1.00       | 1.00 | 1.00 |
| PHF Volume:                                 | 0           | 0    | 0    | 393         | 0    | 20   | 8          | 597  | 0    | 0          | 406  | 158  |
| Reduct Vol:                                 | 0           | 0    | 0    | 0           | 0    | 0    | 0          | 0    | 0    | 0          | 0    | 0    |
| Reduced Vol:                                | 0           | 0    | 0    | 393         | 0    | 20   | 8          | 597  | 0    | 0          | 406  | 158  |
| PCE Adj:                                    | 1.00        | 1.00 | 1.00 | 1.00        | 1.00 | 1.00 | 1.00       | 1.00 | 1.00 | 1.00       | 1.00 | 1.00 |
| MLF Adj:                                    | 1.00        | 1.00 | 1.00 | 1.00        | 1.00 | 1.00 | 1.00       | 1.00 | 1.00 | 1.00       | 1.00 | 1.00 |
| Final Volume:                               | 0           | 0    | 0    | 393         | 0    | 20   | 8          | 597  | 0    | 0          | 406  | 158  |
| Saturation Flow Module:                     |             |      |      |             |      |      |            |      |      |            |      |      |
| Sat/Lane:                                   | 1900        | 1900 | 1900 | 1900        | 1900 | 1900 | 1900       | 1900 | 1900 | 1900       | 1900 | 1900 |
| Adjustment:                                 | 0.92        | 1.00 | 0.92 | 0.92        | 0.92 | 0.92 | 0.95       | 0.95 | 0.92 | 0.92       | 0.95 | 0.95 |
| Lanes:                                      | 0.00        | 0.00 | 0.00 | 0.95        | 0.00 | 0.05 | 0.01       | 0.99 | 0.00 | 0.00       | 0.72 | 0.28 |
| Final Sat.:                                 | 0           | 0    | 0    | 1665        | 0    | 85   | 24         | 1776 | 0    | 0          | 1296 | 504  |
| Capacity Analysis Module:                   |             |      |      |             |      |      |            |      |      |            |      |      |
| Vol/Sat:                                    | 0.00        | 0.00 | 0.00 | 0.24        | 0.00 | 0.24 | 0.34       | 0.34 | 0.00 | 0.00       | 0.31 | 0.31 |
| Crit Moves:                                 | ****        |      |      |             |      |      |            |      |      |            |      |      |
| Green Time:                                 | 0.0         | 0.0  | 0.0  | 21.9        | 0.0  | 21.9 | 31.1       | 31.1 | 0.0  | 0.0        | 31.1 | 31.1 |
| Volume/Cap:                                 | 0.00        | 0.00 | 0.00 | 0.64        | 0.00 | 0.64 | 0.64       | 0.64 | 0.00 | 0.00       | 0.59 | 0.59 |
| Delay/Veh:                                  | 0.0         | 0.0  | 0.0  | 17.4        | 0.0  | 17.4 | 11.4       | 11.4 | 0.0  | 0.0        | 10.6 | 10.6 |
| User DelAdj:                                | 1.00        | 1.00 | 1.00 | 1.00        | 1.00 | 1.00 | 1.00       | 1.00 | 1.00 | 1.00       | 1.00 | 1.00 |
| AdjDel/Veh:                                 | 0.0         | 0.0  | 0.0  | 17.4        | 0.0  | 17.4 | 11.4       | 11.4 | 0.0  | 0.0        | 10.6 | 10.6 |
| LOS by Move:                                | A           | A    | A    | B           | A    | B    | B          | B    | A    | A          | B    | B    |
| HCM2k95thQ:                                 | 0           | 0    | 0    | 15          | 0    | 15   | 16         | 16   | 0    | 0          | 14   | 14   |

Note: Queue reported is the number of cars per lane.

BART

Level Of Service Computation Report  
 2000 HCM Operations (Future Volume Alternative)  
 AM - Existing Conditions

Intersection #3613: JULIAN/24TH [Study Int 2]

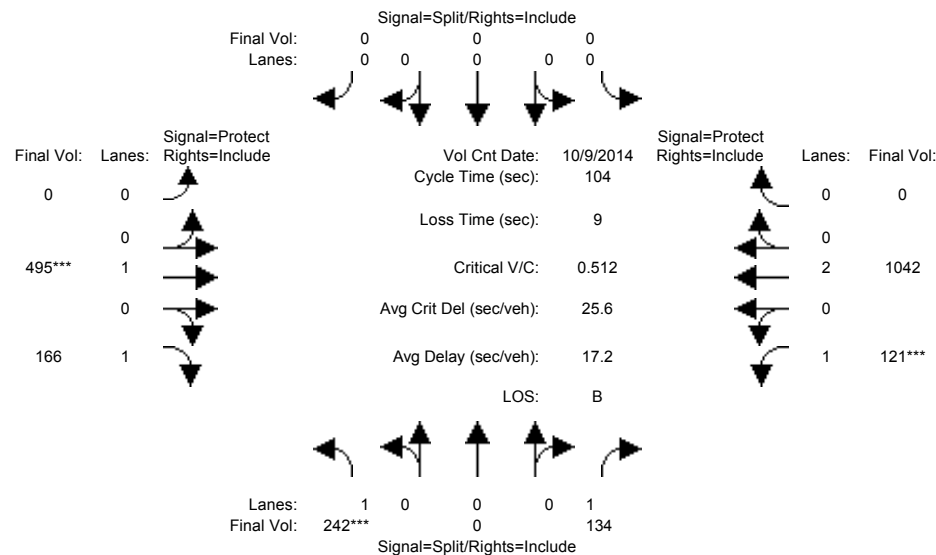

| Approach:                                   | North Bound |      |      | South Bound |      |      | East Bound |      |      | West Bound |      |      |
|---|-------------|------|------|-------------|------|------|------------|------|------|------------|------|------|
| Movement:                                   | L           | T    | R    | L           | T    | R    | L          | T    | R    | L          | T    | R    |
| Min. Green:                                 | 10          | 0    | 10   | 0           | 0    | 0    | 0          | 10   | 10   | 7          | 10   | 0    |
| Y+R:  | 4.0         | 4.0  | 4.0  | 4.0         | 4.0  | 4.0  | 4.0        | 4.0  | 4.0  | 4.0        | 4.0  | 4.0  |
| Volume Module: >> Count Date: 9 Oct 2014 << |             |      |      |             |      |      |            |      |      |            |      |      |
| Base Vol:                                   | 242         | 0    | 134  | 0           | 0    | 0    | 0          | 495  | 166  | 121        | 1042 | 0    |
| Growth Adj:                                 | 1.00        | 1.00 | 1.00 | 1.00        | 1.00 | 1.00 | 1.00       | 1.00 | 1.00 | 1.00       | 1.00 | 1.00 |
| Initial Bse:                                | 242         | 0    | 134  | 0           | 0    | 0    | 0          | 495  | 166  | 121        | 1042 | 0    |
| Added Vol:                                  | 0           | 0    | 0    | 0           | 0    | 0    | 0          | 0    | 0    | 0          | 0    | 0    |
| PasserByVol:                                | 0           | 0    | 0    | 0           | 0    | 0    | 0          | 0    | 0    | 0          | 0    | 0    |
| Initial Fut:                                | 242         | 0    | 134  | 0           | 0    | 0    | 0          | 495  | 166  | 121        | 1042 | 0    |
| User Adj:                                   | 1.00        | 1.00 | 1.00 | 1.00        | 1.00 | 1.00 | 1.00       | 1.00 | 1.00 | 1.00       | 1.00 | 1.00 |
| PHF Adj:                                    | 1.00        | 1.00 | 1.00 | 1.00        | 1.00 | 1.00 | 1.00       | 1.00 | 1.00 | 1.00       | 1.00 | 1.00 |
| PHF Volume:                                 | 242         | 0    | 134  | 0           | 0    | 0    | 0          | 495  | 166  | 121        | 1042 | 0    |
| Reduct Vol:                                 | 0           | 0    | 0    | 0           | 0    | 0    | 0          | 0    | 0    | 0          | 0    | 0    |
| Reduced Vol:                                | 242         | 0    | 134  | 0           | 0    | 0    | 0          | 495  | 166  | 121        | 1042 | 0    |
| PCE Adj:                                    | 1.00        | 1.00 | 1.00 | 1.00        | 1.00 | 1.00 | 1.00       | 1.00 | 1.00 | 1.00       | 1.00 | 1.00 |
| MLF Adj:                                    | 1.00        | 1.00 | 1.00 | 1.00        | 1.00 | 1.00 | 1.00       | 1.00 | 1.00 | 1.00       | 1.00 | 1.00 |
| FinalVolume:                                | 242         | 0    | 134  | 0           | 0    | 0    | 0          | 495  | 166  | 121        | 1042 | 0    |
| Saturation Flow Module:                     |             |      |      |             |      |      |            |      |      |            |      |      |
| Sat/Lane:                                   | 1900        | 1900 | 1900 | 1900        | 1900 | 1900 | 1900       | 1900 | 1900 | 1900       | 1900 | 1900 |
| Adjustment:                                 | 0.92        | 1.00 | 0.92 | 0.92        | 1.00 | 0.92 | 0.92       | 1.00 | 0.92 | 0.92       | 1.00 | 0.92 |
| Lanes:                                      | 1.00        | 0.00 | 1.00 | 0.00        | 0.00 | 0.00 | 0.00       | 1.00 | 1.00 | 1.00       | 2.00 | 0.00 |
| Final Sat.:                                 | 1750        | 0    | 1750 | 0           | 0    | 0    | 0          | 1900 | 1750 | 1750       | 3800 | 0    |
| Capacity Analysis Module:                   |             |      |      |             |      |      |            |      |      |            |      |      |
| Vol/Sat:                                    | 0.14        | 0.00 | 0.08 | 0.00        | 0.00 | 0.00 | 0.00       | 0.26 | 0.09 | 0.07       | 0.27 | 0.00 |
| Crit Moves:                                 | ****        |      |      |             |      |      |            | **** |      | ****       |      |      |
| Green Time:                                 | 28.1        | 0.0  | 28.1 | 0.0         | 0.0  | 0.0  | 0.0        | 52.9 | 52.9 | 14.0       | 66.9 | 0.0  |
| Volume/Cap:                                 | 0.51        | 0.00 | 0.28 | 0.00        | 0.00 | 0.00 | 0.00       | 0.51 | 0.19 | 0.51       | 0.43 | 0.00 |
| Delay/Veh:                                  | 33.1        | 0.0  | 30.3 | 0.0         | 0.0  | 0.0  | 0.0        | 17.5 | 14.0 | 43.7       | 9.2  | 0.0  |
| User DelAdj:                                | 1.00        | 1.00 | 1.00 | 1.00        | 1.00 | 1.00 | 1.00       | 1.00 | 1.00 | 1.00       | 1.00 | 1.00 |
| AdjDel/Veh:                                 | 33.1        | 0.0  | 30.3 | 0.0         | 0.0  | 0.0  | 0.0        | 17.5 | 14.0 | 43.7       | 9.2  | 0.0  |
| LOS by Move:                                | C           | A    | C    | A           | A    | A    | A          | B    | B    | D          | A    | A    |
| HCM2k95thQ:                                 | 14          | 0    | 7    | 0           | 0    | 0    | 0          | 19   | 6    | 9          | 15   | 0    |

Note: Queue reported is the number of cars per lane.

BART

Level Of Service Computation Report  
2000 HCM Operations (Future Volume Alternative)  
PM - Existing Conditions

Intersection #3613: JULIAN/24TH [Study Int 2]

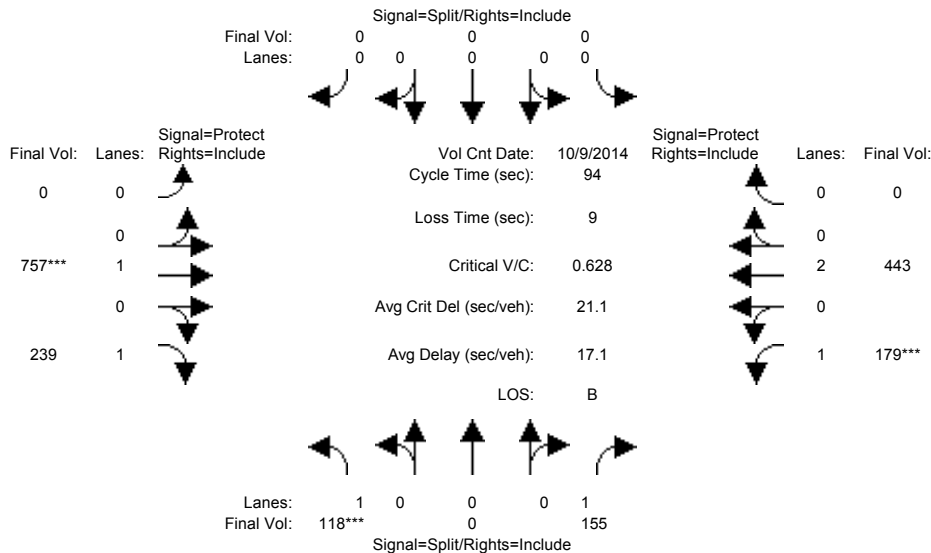

| Approach:                                   | North Bound |      |      | South Bound |      |      | East Bound |      |      | West Bound |      |      |
|---|-------------|------|------|-------------|------|------|------------|------|------|------------|------|------|
| Movement:                                   | L           | T    | R    | L           | T    | R    | L          | T    | R    | L          | T    | R    |
| Min. Green:                                 | 10          | 0    | 10   | 0           | 0    | 0    | 0          | 10   | 10   | 7          | 10   | 0    |
| Y+R:  | 4.0         | 4.0  | 4.0  | 4.0         | 4.0  | 4.0  | 4.0        | 4.0  | 4.0  | 4.0        | 4.0  | 0    |
| Volume Module: >> Count Date: 9 Oct 2014 << |             |      |      |             |      |      |            |      |      |            |      |      |
| Base Vol:                                   | 118         | 0    | 155  | 0           | 0    | 0    | 0          | 757  | 239  | 179        | 443  | 0    |
| Growth Adj:                                 | 1.00        | 1.00 | 1.00 | 1.00        | 1.00 | 1.00 | 1.00       | 1.00 | 1.00 | 1.00       | 1.00 | 1.00 |
| Initial Bse:                                | 118         | 0    | 155  | 0           | 0    | 0    | 0          | 757  | 239  | 179        | 443  | 0    |
| Added Vol:                                  | 0           | 0    | 0    | 0           | 0    | 0    | 0          | 0    | 0    | 0          | 0    | 0    |
| PasserByVol:                                | 0           | 0    | 0    | 0           | 0    | 0    | 0          | 0    | 0    | 0          | 0    | 0    |
| Initial Fut:                                | 118         | 0    | 155  | 0           | 0    | 0    | 0          | 757  | 239  | 179        | 443  | 0    |
| User Adj:                                   | 1.00        | 1.00 | 1.00 | 1.00        | 1.00 | 1.00 | 1.00       | 1.00 | 1.00 | 1.00       | 1.00 | 1.00 |
| PHF Adj:                                    | 1.00        | 1.00 | 1.00 | 1.00        | 1.00 | 1.00 | 1.00       | 1.00 | 1.00 | 1.00       | 1.00 | 1.00 |
| PHF Volume:                                 | 118         | 0    | 155  | 0           | 0    | 0    | 0          | 757  | 239  | 179        | 443  | 0    |
| Reduct Vol:                                 | 0           | 0    | 0    | 0           | 0    | 0    | 0          | 0    | 0    | 0          | 0    | 0    |
| Reduced Vol:                                | 118         | 0    | 155  | 0           | 0    | 0    | 0          | 757  | 239  | 179        | 443  | 0    |
| PCE Adj:                                    | 1.00        | 1.00 | 1.00 | 1.00        | 1.00 | 1.00 | 1.00       | 1.00 | 1.00 | 1.00       | 1.00 | 1.00 |
| MLF Adj:                                    | 1.00        | 1.00 | 1.00 | 1.00        | 1.00 | 1.00 | 1.00       | 1.00 | 1.00 | 1.00       | 1.00 | 1.00 |
| Final Volume:                               | 118         | 0    | 155  | 0           | 0    | 0    | 0          | 757  | 239  | 179        | 443  | 0    |
| Saturation Flow Module:                     |             |      |      |             |      |      |            |      |      |            |      |      |
| Sat/Lane:                                   | 1900        | 1900 | 1900 | 1900        | 1900 | 1900 | 1900       | 1900 | 1900 | 1900       | 1900 | 1900 |
| Adjustment:                                 | 0.92        | 1.00 | 0.92 | 0.92        | 1.00 | 0.92 | 0.92       | 1.00 | 0.92 | 0.92       | 1.00 | 0.92 |
| Lanes:                                      | 1.00        | 0.00 | 1.00 | 0.00        | 0.00 | 0.00 | 0.00       | 1.00 | 1.00 | 1.00       | 2.00 | 0.00 |
| Final Sat.:                                 | 1750        | 0    | 1750 | 0           | 0    | 0    | 0          | 1900 | 1750 | 1750       | 3800 | 0    |
| Capacity Analysis Module:                   |             |      |      |             |      |      |            |      |      |            |      |      |
| Vol/Sat:                                    | 0.07        | 0.00 | 0.09 | 0.00        | 0.00 | 0.00 | 0.00       | 0.40 | 0.14 | 0.10       | 0.12 | 0.00 |
| Crit Moves:                                 | ****        |      |      |             |      |      | ****       |      |      | ****       |      |      |
| Green Time:                                 | 12.8        | 0.0  | 12.8 | 0.0         | 0.0  | 0.0  | 0.0        | 57.5 | 57.5 | 14.8       | 72.2 | 0.0  |
| Volume/Cap:                                 | 0.50        | 0.00 | 0.65 | 0.00        | 0.00 | 0.00 | 0.00       | 0.65 | 0.22 | 0.65       | 0.15 | 0.00 |
| Delay/Veh:                                  | 39.3        | 0.0  | 44.8 | 0.0         | 0.0  | 0.0  | 0.0        | 13.1 | 8.3  | 42.7       | 2.9  | 0.0  |
| User DelAdj:                                | 1.00        | 1.00 | 1.00 | 1.00        | 1.00 | 1.00 | 1.00       | 1.00 | 1.00 | 1.00       | 1.00 | 1.00 |
| AdjDel/Veh:                                 | 39.3        | 0.0  | 44.8 | 0.0         | 0.0  | 0.0  | 0.0        | 13.1 | 8.3  | 42.7       | 2.9  | 0.0  |
| LOS by Move:                                | D           | A    | D    | A           | A    | A    | A          | B    | A    | D          | A    | A    |
| HCM2k95thQ:                                 | 8           | 0    | 11   | 0           | 0    | 0    | 0          | 25   | 6    | 12         | 3    | 0    |

Note: Queue reported is the number of cars per lane.

BART

Level Of Service Computation Report  
 2000 HCM Operations (Future Volume Alternative)  
 AM - Existing Conditions

Intersection #3623: KING/MABURY [Study Int 27]

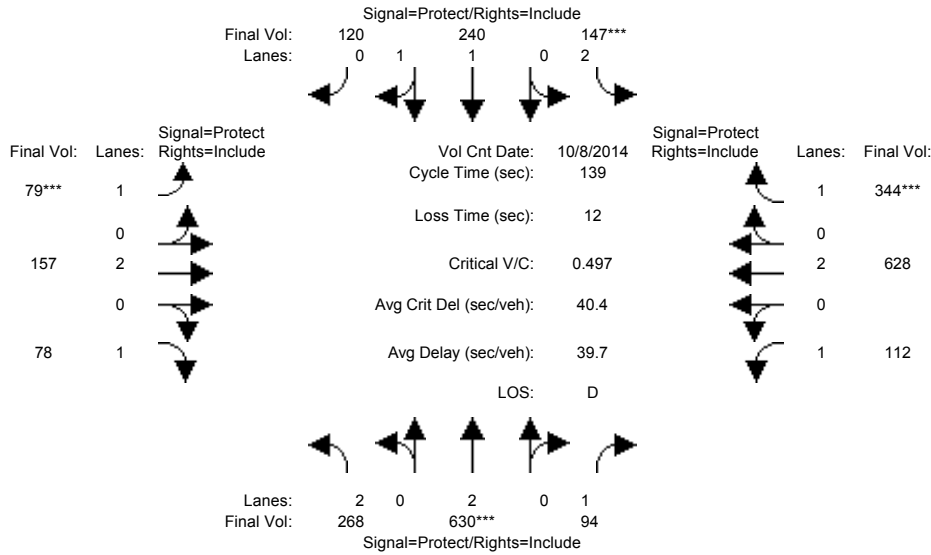

| Approach:                                   | North Bound |      |      | South Bound |      |      | East Bound |      |      | West Bound |      |      |
|---|-------------|------|------|-------------|------|------|------------|------|------|------------|------|------|
| Movement:                                   | L           | T    | R    | L           | T    | R    | L          | T    | R    | L          | T    | R    |
| Min. Green:                                 | 7           | 10   | 10   | 7           | 10   | 10   | 7          | 10   | 10   | 7          | 10   | 10   |
| Y+R:  | 4.0         | 4.0  | 4.0  | 4.0         | 4.0  | 4.0  | 4.0        | 4.0  | 4.0  | 4.0        | 4.0  | 4.0  |
| Volume Module: >> Count Date: 8 Oct 2014 << |             |      |      |             |      |      |            |      |      |            |      |      |
| Base Vol:                                   | 268         | 630  | 94   | 147         | 240  | 120  | 79         | 157  | 78   | 112        | 628  | 344  |
| Growth Adj:                                 | 1.00        | 1.00 | 1.00 | 1.00        | 1.00 | 1.00 | 1.00       | 1.00 | 1.00 | 1.00       | 1.00 | 1.00 |
| Initial Bse:                                | 268         | 630  | 94   | 147         | 240  | 120  | 79         | 157  | 78   | 112        | 628  | 344  |
| Added Vol:                                  | 0           | 0    | 0    | 0           | 0    | 0    | 0          | 0    | 0    | 0          | 0    | 0    |
| PasserByVol:                                | 0           | 0    | 0    | 0           | 0    | 0    | 0          | 0    | 0    | 0          | 0    | 0    |
| Initial Fut:                                | 268         | 630  | 94   | 147         | 240  | 120  | 79         | 157  | 78   | 112        | 628  | 344  |
| User Adj:                                   | 1.00        | 1.00 | 1.00 | 1.00        | 1.00 | 1.00 | 1.00       | 1.00 | 1.00 | 1.00       | 1.00 | 1.00 |
| PHF Adj:                                    | 1.00        | 1.00 | 1.00 | 1.00        | 1.00 | 1.00 | 1.00       | 1.00 | 1.00 | 1.00       | 1.00 | 1.00 |
| PHF Volume:                                 | 268         | 630  | 94   | 147         | 240  | 120  | 79         | 157  | 78   | 112        | 628  | 344  |
| Reduct Vol:                                 | 0           | 0    | 0    | 0           | 0    | 0    | 0          | 0    | 0    | 0          | 0    | 0    |
| Reduced Vol:                                | 268         | 630  | 94   | 147         | 240  | 120  | 79         | 157  | 78   | 112        | 628  | 344  |
| PCE Adj:                                    | 1.00        | 1.00 | 1.00 | 1.00        | 1.00 | 1.00 | 1.00       | 1.00 | 1.00 | 1.00       | 1.00 | 1.00 |
| MLF Adj:                                    | 1.00        | 1.00 | 1.00 | 1.00        | 1.00 | 1.00 | 1.00       | 1.00 | 1.00 | 1.00       | 1.00 | 1.00 |
| FinalVolume:                                | 268         | 630  | 94   | 147         | 240  | 120  | 79         | 157  | 78   | 112        | 628  | 344  |
| Saturation Flow Module:                     |             |      |      |             |      |      |            |      |      |            |      |      |
| Sat/Lane:                                   | 1900        | 1900 | 1900 | 1900        | 1900 | 1900 | 1900       | 1900 | 1900 | 1900       | 1900 | 1900 |
| Adjustment:                                 | 0.83        | 1.00 | 0.92 | 0.83        | 0.99 | 0.95 | 0.92       | 1.00 | 0.92 | 0.92       | 1.00 | 0.92 |
| Lanes:                                      | 2.00        | 2.00 | 1.00 | 2.00        | 1.32 | 0.68 | 1.00       | 2.00 | 1.00 | 1.00       | 2.00 | 1.00 |
| Final Sat.:                                 | 3150        | 3800 | 1750 | 3150        | 2466 | 1233 | 1750       | 3800 | 1750 | 1750       | 3800 | 1750 |
| Capacity Analysis Module:                   |             |      |      |             |      |      |            |      |      |            |      |      |
| Vol/Sat:                                    | 0.09        | 0.17 | 0.05 | 0.05        | 0.10 | 0.10 | 0.05       | 0.04 | 0.04 | 0.06       | 0.17 | 0.20 |
| Crit Moves:                                 | ****        | **** | **** | ****        | **** | **** | ****       | **** | **** | ****       | **** | **** |
| Green Time:                                 | 27.7        | 46.4 | 46.4 | 13.0        | 31.7 | 31.7 | 12.6       | 35.8 | 35.8 | 31.8       | 55.0 | 55.0 |
| Volume/Cap:                                 | 0.43        | 0.50 | 0.16 | 0.50        | 0.43 | 0.43 | 0.50       | 0.16 | 0.17 | 0.28       | 0.42 | 0.50 |
| Delay/Veh:                                  | 49.2        | 37.3 | 32.8 | 61.2        | 46.2 | 46.2 | 62.6       | 40.1 | 40.3 | 44.5       | 30.6 | 32.2 |
| User DelAdj:                                | 1.00        | 1.00 | 1.00 | 1.00        | 1.00 | 1.00 | 1.00       | 1.00 | 1.00 | 1.00       | 1.00 | 1.00 |
| AdjDel/Veh:                                 | 49.2        | 37.3 | 32.8 | 61.2        | 46.2 | 46.2 | 62.6       | 40.1 | 40.3 | 44.5       | 30.6 | 32.2 |
| LOS by Move:                                | D           | D    | C    | E           | D    | D    | E          | D    | D    | D          | C    | C    |
| HCM2k95thQ:                                 | 11          | 19   | 6    | 7           | 12   | 12   | 7          | 5    | 5    | 8          | 17   | 21   |

Note: Queue reported is the number of cars per lane.



BART

Level Of Service Computation Report  
 2000 HCM Operations (Future Volume Alternative)  
 PM - Existing Conditions

Intersection #3623: KING/MABURY [Study Int 27]

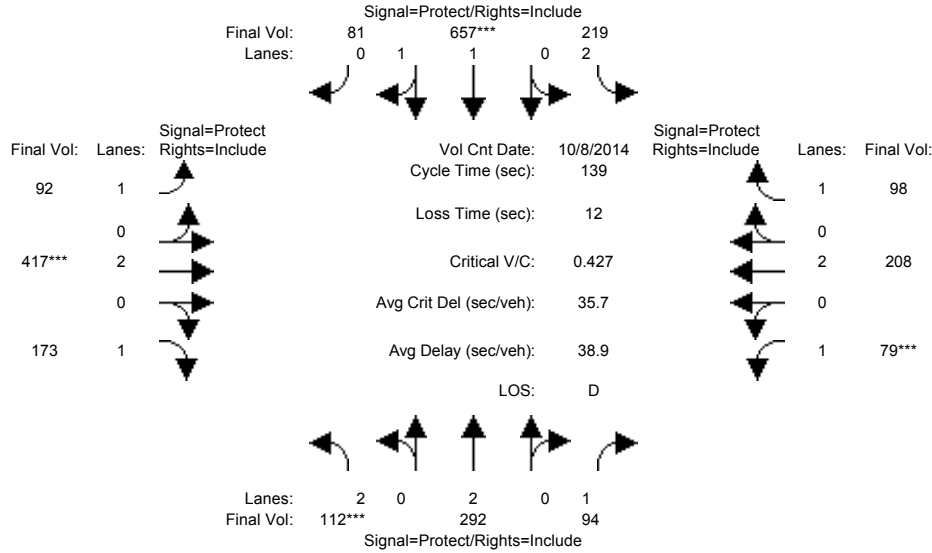

| Approach:                                   | North Bound |      |      | South Bound |      |      | East Bound |      |      | West Bound |      |      |
|---|-------------|------|------|-------------|------|------|------------|------|------|------------|------|------|
| Movement:                                   | L           | T    | R    | L           | T    | R    | L          | T    | R    | L          | T    | R    |
| Min. Green:                                 | 7           | 10   | 10   | 7           | 10   | 10   | 7          | 10   | 10   | 7          | 10   | 10   |
| Y+R:  | 4.0         | 4.0  | 4.0  | 4.0         | 4.0  | 4.0  | 4.0        | 4.0  | 4.0  | 4.0        | 4.0  | 4.0  |
| -----                                       |             |      |      |             |      |      |            |      |      |            |      |      |
| Volume Module: >> Count Date: 8 Oct 2014 << |             |      |      |             |      |      |            |      |      |            |      |      |
| Base Vol:                                   | 112         | 292  | 94   | 219         | 657  | 81   | 92         | 417  | 173  | 79         | 208  | 98   |
| Growth Adj:                                 | 1.00        | 1.00 | 1.00 | 1.00        | 1.00 | 1.00 | 1.00       | 1.00 | 1.00 | 1.00       | 1.00 | 1.00 |
| Initial Bse:                                | 112         | 292  | 94   | 219         | 657  | 81   | 92         | 417  | 173  | 79         | 208  | 98   |
| Added Vol:                                  | 0           | 0    | 0    | 0           | 0    | 0    | 0          | 0    | 0    | 0          | 0    | 0    |
| PasserByVol:                                | 0           | 0    | 0    | 0           | 0    | 0    | 0          | 0    | 0    | 0          | 0    | 0    |
| Initial Fut:                                | 112         | 292  | 94   | 219         | 657  | 81   | 92         | 417  | 173  | 79         | 208  | 98   |
| User Adj:                                   | 1.00        | 1.00 | 1.00 | 1.00        | 1.00 | 1.00 | 1.00       | 1.00 | 1.00 | 1.00       | 1.00 | 1.00 |
| PHF Adj:                                    | 1.00        | 1.00 | 1.00 | 1.00        | 1.00 | 1.00 | 1.00       | 1.00 | 1.00 | 1.00       | 1.00 | 1.00 |
| PHF Volume:                                 | 112         | 292  | 94   | 219         | 657  | 81   | 92         | 417  | 173  | 79         | 208  | 98   |
| Reduct Vol:                                 | 0           | 0    | 0    | 0           | 0    | 0    | 0          | 0    | 0    | 0          | 0    | 0    |
| Reduced Vol:                                | 112         | 292  | 94   | 219         | 657  | 81   | 92         | 417  | 173  | 79         | 208  | 98   |
| PCE Adj:                                    | 1.00        | 1.00 | 1.00 | 1.00        | 1.00 | 1.00 | 1.00       | 1.00 | 1.00 | 1.00       | 1.00 | 1.00 |
| MLF Adj:                                    | 1.00        | 1.00 | 1.00 | 1.00        | 1.00 | 1.00 | 1.00       | 1.00 | 1.00 | 1.00       | 1.00 | 1.00 |
| Final Volume:                               | 112         | 292  | 94   | 219         | 657  | 81   | 92         | 417  | 173  | 79         | 208  | 98   |
| -----                                       |             |      |      |             |      |      |            |      |      |            |      |      |
| Saturation Flow Module:                     |             |      |      |             |      |      |            |      |      |            |      |      |
| Sat/Lane:                                   | 1900        | 1900 | 1900 | 1900        | 1900 | 1900 | 1900       | 1900 | 1900 | 1900       | 1900 | 1900 |
| Adjustment:                                 | 0.83        | 1.00 | 0.92 | 0.83        | 0.98 | 0.95 | 0.92       | 1.00 | 0.92 | 0.92       | 1.00 | 0.92 |
| Lanes:                                      | 2.00        | 2.00 | 1.00 | 2.00        | 1.77 | 0.23 | 1.00       | 2.00 | 1.00 | 1.00       | 2.00 | 1.00 |
| Final Sat.:                                 | 3150        | 3800 | 1750 | 3150        | 3294 | 406  | 1750       | 3800 | 1750 | 1750       | 3800 | 1750 |
| -----                                       |             |      |      |             |      |      |            |      |      |            |      |      |
| Capacity Analysis Module:                   |             |      |      |             |      |      |            |      |      |            |      |      |
| Vol/Sat:                                    | 0.04        | 0.08 | 0.05 | 0.07        | 0.20 | 0.20 | 0.05       | 0.11 | 0.10 | 0.05       | 0.05 | 0.06 |
| Crit Moves:                                 | ****        |      |      | ****        |      |      | ****       |      |      | ****       |      |      |
| Green Time:                                 | 11.6        | 40.2 | 40.2 | 36.4        | 65.0 | 65.0 | 21.3       | 35.7 | 35.7 | 14.7       | 29.1 | 29.1 |
| Volume/Cap:                                 | 0.43        | 0.27 | 0.19 | 0.27        | 0.43 | 0.43 | 0.34       | 0.43 | 0.38 | 0.43       | 0.26 | 0.27 |
| Delay/Veh:                                  | 61.7        | 38.2 | 37.3 | 40.9        | 24.8 | 24.8 | 53.4       | 43.4 | 43.1 | 59.8       | 46.1 | 46.4 |
| User DelAdj:                                | 1.00        | 1.00 | 1.00 | 1.00        | 1.00 | 1.00 | 1.00       | 1.00 | 1.00 | 1.00       | 1.00 | 1.00 |
| AdjDel/Veh:                                 | 61.7        | 38.2 | 37.3 | 40.9        | 24.8 | 24.8 | 53.4       | 43.4 | 43.1 | 59.8       | 46.1 | 46.4 |
| LOS by Move:                                | E           | D    | D    | D           | C    | C    | D          | D    | D    | E          | D    | D    |
| HCM2k95thQ:                                 | 5           | 9    | 6    | 8           | 19   | 19   | 7          | 14   | 12   | 7          | 7    | 7    |

Note: Queue reported is the number of cars per lane.

BART

Level Of Service Computation Report  
2000 HCM Operations (Future Volume Alternative)  
AM - Existing Conditions

Intersection #3625: KING/McKEE [Study Int 7]

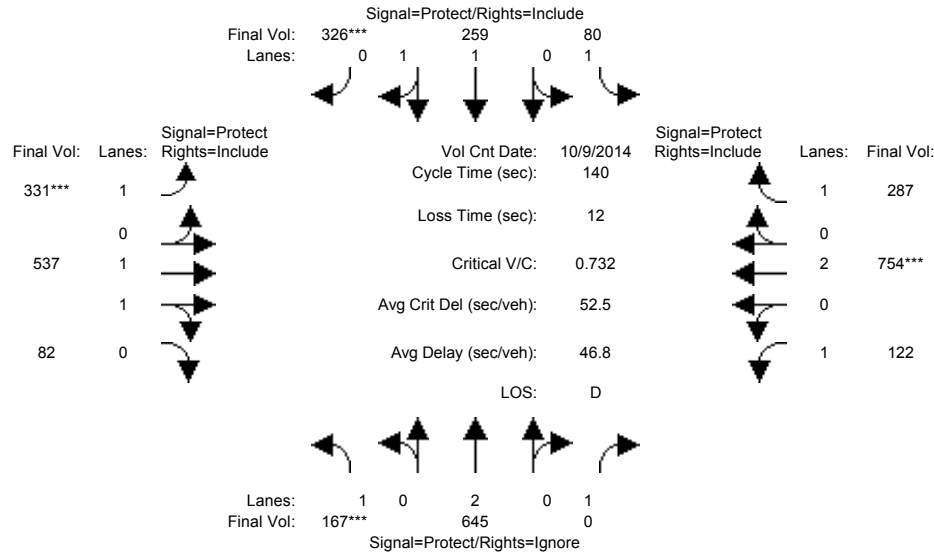

| Approach:                                   | North Bound |      |      | South Bound |      |      | East Bound |      |      | West Bound |      |      |
|---|-------------|------|------|-------------|------|------|------------|------|------|------------|------|------|
| Movement:                                   | L           | T    | R    | L           | T    | R    | L          | T    | R    | L          | T    | R    |
| Min. Green:                                 | 7           | 10   | 10   | 7           | 10   | 10   | 7          | 10   | 10   | 7          | 10   | 10   |
| Y+R:  | 4.0         | 4.0  | 4.0  | 4.0         | 4.0  | 4.0  | 4.0        | 4.0  | 4.0  | 4.0        | 4.0  | 4.0  |
| Volume Module: >> Count Date: 9 Oct 2014 << |             |      |      |             |      |      |            |      |      |            |      |      |
| Base Vol:                                   | 167         | 645  | 162  | 80          | 259  | 326  | 331        | 537  | 82   | 122        | 754  | 287  |
| Growth Adj:                                 | 1.00        | 1.00 | 1.00 | 1.00        | 1.00 | 1.00 | 1.00       | 1.00 | 1.00 | 1.00       | 1.00 | 1.00 |
| Initial Bse:                                | 167         | 645  | 162  | 80          | 259  | 326  | 331        | 537  | 82   | 122        | 754  | 287  |
| Added Vol:                                  | 0           | 0    | 0    | 0           | 0    | 0    | 0          | 0    | 0    | 0          | 0    | 0    |
| PasserByVol:                                | 0           | 0    | 0    | 0           | 0    | 0    | 0          | 0    | 0    | 0          | 0    | 0    |
| Initial Fut:                                | 167         | 645  | 162  | 80          | 259  | 326  | 331        | 537  | 82   | 122        | 754  | 287  |
| User Adj:                                   | 1.00        | 1.00 | 0.00 | 1.00        | 1.00 | 1.00 | 1.00       | 1.00 | 1.00 | 1.00       | 1.00 | 1.00 |
| PHF Adj:                                    | 1.00        | 1.00 | 0.00 | 1.00        | 1.00 | 1.00 | 1.00       | 1.00 | 1.00 | 1.00       | 1.00 | 1.00 |
| PHF Volume:                                 | 167         | 645  | 0    | 80          | 259  | 326  | 331        | 537  | 82   | 122        | 754  | 287  |
| Reduct Vol:                                 | 0           | 0    | 0    | 0           | 0    | 0    | 0          | 0    | 0    | 0          | 0    | 0    |
| Reduced Vol:                                | 167         | 645  | 0    | 80          | 259  | 326  | 331        | 537  | 82   | 122        | 754  | 287  |
| PCE Adj:                                    | 1.00        | 1.00 | 0.00 | 1.00        | 1.00 | 1.00 | 1.00       | 1.00 | 1.00 | 1.00       | 1.00 | 1.00 |
| MLF Adj:                                    | 1.00        | 1.00 | 0.00 | 1.00        | 1.00 | 1.00 | 1.00       | 1.00 | 1.00 | 1.00       | 1.00 | 1.00 |
| Final Volume:                               | 167         | 645  | 0    | 80          | 259  | 326  | 331        | 537  | 82   | 122        | 754  | 287  |
| Saturation Flow Module:                     |             |      |      |             |      |      |            |      |      |            |      |      |
| Sat/Lane:                                   | 1900        | 1900 | 1900 | 1900        | 1900 | 1900 | 1900       | 1900 | 1900 | 1900       | 1900 | 1900 |
| Adjustment:                                 | 0.92        | 1.00 | 0.92 | 0.92        | 1.00 | 0.92 | 0.92       | 0.98 | 0.95 | 0.92       | 1.00 | 0.92 |
| Lanes:                                      | 1.00        | 2.00 | 1.00 | 1.00        | 1.00 | 1.00 | 1.00       | 1.73 | 0.27 | 1.00       | 2.00 | 1.00 |
| Final Sat.:                                 | 1750        | 3800 | 1750 | 1750        | 1900 | 1750 | 1750       | 3209 | 490  | 1750       | 3800 | 1750 |
| Capacity Analysis Module:                   |             |      |      |             |      |      |            |      |      |            |      |      |
| Vol/Sat:                                    | 0.10        | 0.17 | 0.00 | 0.05        | 0.14 | 0.19 | 0.19       | 0.17 | 0.17 | 0.07       | 0.20 | 0.16 |
| Crit Moves:                                 | ****        |      |      | ****        | **** | **** | ****       | **** | **** | ****       |      |      |
| Green Time:                                 | 18.3        | 41.6 | 0.0  | 12.3        | 35.6 | 35.6 | 36.2       | 52.3 | 52.3 | 21.8       | 37.9 | 37.9 |
| Volume/Cap:                                 | 0.73        | 0.57 | 0.00 | 0.52        | 0.54 | 0.73 | 0.73       | 0.45 | 0.45 | 0.45       | 0.73 | 0.61 |
| Delay/Veh:                                  | 70.0        | 42.3 | 0.0  | 64.3        | 45.6 | 51.3 | 53.5       | 33.2 | 33.2 | 54.8       | 49.1 | 46.7 |
| User DelAdj:                                | 1.00        | 1.00 | 1.00 | 1.00        | 1.00 | 1.00 | 1.00       | 1.00 | 1.00 | 1.00       | 1.00 | 1.00 |
| AdjDel/Veh:                                 | 70.0        | 42.3 | 0.0  | 64.3        | 45.6 | 51.3 | 53.5       | 33.2 | 33.2 | 54.8       | 49.1 | 46.7 |
| LOS by Move:                                | E           | D    | A    | E           | D    | D    | D          | C    | C    | D          | D    | D    |
| HCM2k95thQ:                                 | 15          | 21   | 0    | 7           | 17   | 25   | 25         | 18   | 18   | 10         | 26   | 21   |

Note: Queue reported is the number of cars per lane.

BART

Level Of Service Computation Report  
 2000 HCM Operations (Future Volume Alternative)  
 PM - Existing Conditions

Intersection #3625: KING/McKEE [Study Int 7]

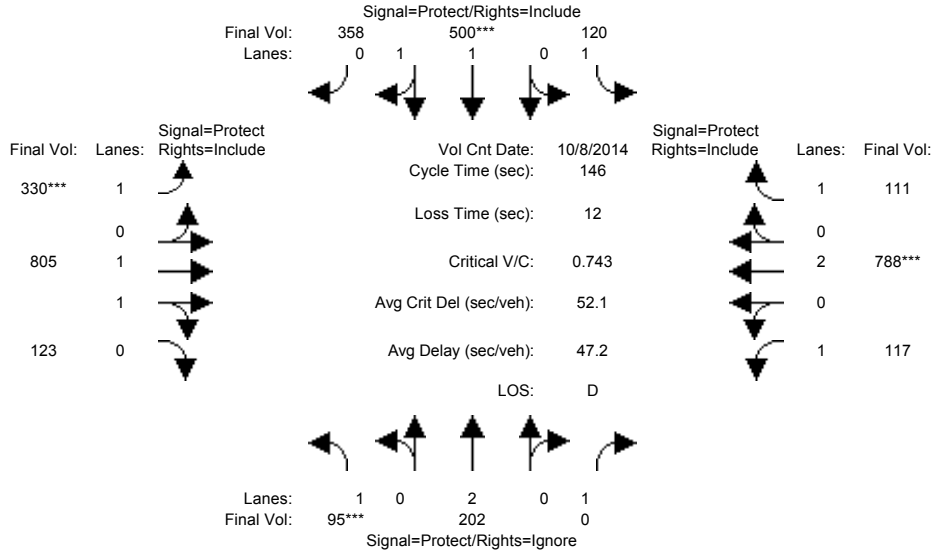

| Approach:                                   | North Bound |      |      | South Bound |      |      | East Bound |      |      | West Bound |      |      |
|---|-------------|------|------|-------------|------|------|------------|------|------|------------|------|------|
| Movement:                                   | L           | T    | R    | L           | T    | R    | L          | T    | R    | L          | T    | R    |
| Min. Green:                                 | 7           | 10   | 10   | 7           | 10   | 10   | 7          | 10   | 10   | 7          | 10   | 10   |
| Y+R:  | 4.0         | 4.0  | 4.0  | 4.0         | 4.0  | 4.0  | 4.0        | 4.0  | 4.0  | 4.0        | 4.0  | 4.0  |
| Volume Module: >> Count Date: 8 Oct 2014 << |             |      |      |             |      |      |            |      |      |            |      |      |
| Base Vol:                                   | 95          | 202  | 98   | 120         | 500  | 358  | 330        | 805  | 123  | 117        | 788  | 111  |
| Growth Adj:                                 | 1.00        | 1.00 | 1.00 | 1.00        | 1.00 | 1.00 | 1.00       | 1.00 | 1.00 | 1.00       | 1.00 | 1.00 |
| Initial Bse:                                | 95          | 202  | 98   | 120         | 500  | 358  | 330        | 805  | 123  | 117        | 788  | 111  |
| Added Vol:                                  | 0           | 0    | 0    | 0           | 0    | 0    | 0          | 0    | 0    | 0          | 0    | 0    |
| PasserByVol:                                | 0           | 0    | 0    | 0           | 0    | 0    | 0          | 0    | 0    | 0          | 0    | 0    |
| Initial Fut:                                | 95          | 202  | 98   | 120         | 500  | 358  | 330        | 805  | 123  | 117        | 788  | 111  |
| User Adj:                                   | 1.00        | 1.00 | 0.00 | 1.00        | 1.00 | 1.00 | 1.00       | 1.00 | 1.00 | 1.00       | 1.00 | 1.00 |
| PHF Adj:                                    | 1.00        | 1.00 | 0.00 | 1.00        | 1.00 | 1.00 | 1.00       | 1.00 | 1.00 | 1.00       | 1.00 | 1.00 |
| PHF Volume:                                 | 95          | 202  | 0    | 120         | 500  | 358  | 330        | 805  | 123  | 117        | 788  | 111  |
| Reduct Vol:                                 | 0           | 0    | 0    | 0           | 0    | 0    | 0          | 0    | 0    | 0          | 0    | 0    |
| Reduced Vol:                                | 95          | 202  | 0    | 120         | 500  | 358  | 330        | 805  | 123  | 117        | 788  | 111  |
| PCE Adj:                                    | 1.00        | 1.00 | 0.00 | 1.00        | 1.00 | 1.00 | 1.00       | 1.00 | 1.00 | 1.00       | 1.00 | 1.00 |
| MLF Adj:                                    | 1.00        | 1.00 | 0.00 | 1.00        | 1.00 | 1.00 | 1.00       | 1.00 | 1.00 | 1.00       | 1.00 | 1.00 |
| FinalVolume:                                | 95          | 202  | 0    | 120         | 500  | 358  | 330        | 805  | 123  | 117        | 788  | 111  |
| Saturation Flow Module:                     |             |      |      |             |      |      |            |      |      |            |      |      |
| Sat/Lane:                                   | 1900        | 1900 | 1900 | 1900        | 1900 | 1900 | 1900       | 1900 | 1900 | 1900       | 1900 | 1900 |
| Adjustment:                                 | 0.92        | 1.00 | 0.92 | 0.92        | 0.99 | 0.95 | 0.92       | 0.98 | 0.95 | 0.92       | 1.00 | 0.92 |
| Lanes:                                      | 1.00        | 2.00 | 1.00 | 1.00        | 1.14 | 0.86 | 1.00       | 1.73 | 0.27 | 1.00       | 2.00 | 1.00 |
| Final Sat.:                                 | 1750        | 3800 | 1750 | 1750        | 2155 | 1543 | 1750       | 3209 | 490  | 1750       | 3800 | 1750 |
| Capacity Analysis Module:                   |             |      |      |             |      |      |            |      |      |            |      |      |
| Vol/Sat:                                    | 0.05        | 0.05 | 0.00 | 0.07        | 0.23 | 0.23 | 0.19       | 0.25 | 0.25 | 0.07       | 0.21 | 0.06 |
| Crit Moves:                                 | ****        | **** | **** | ****        | **** | **** | ****       | **** | **** | ****       | **** | **** |
| Green Time:                                 | 10.7        | 28.1 | 0.0  | 28.1        | 45.6 | 45.6 | 37.0       | 61.4 | 61.4 | 16.4       | 40.7 | 40.7 |
| Volume/Cap:                                 | 0.74        | 0.28 | 0.00 | 0.36        | 0.74 | 0.74 | 0.74       | 0.60 | 0.60 | 0.60       | 0.74 | 0.23 |
| Delay/Veh:                                  | 87.1        | 50.5 | 0.0  | 51.7        | 47.6 | 47.6 | 56.8       | 33.4 | 33.4 | 66.6       | 50.8 | 40.8 |
| User DelAdj:                                | 1.00        | 1.00 | 1.00 | 1.00        | 1.00 | 1.00 | 1.00       | 1.00 | 1.00 | 1.00       | 1.00 | 1.00 |
| AdjDel/Veh:                                 | 87.1        | 50.5 | 0.0  | 51.7        | 47.6 | 47.6 | 56.8       | 33.4 | 33.4 | 66.6       | 50.8 | 40.8 |
| LOS by Move:                                | F           | D    | A    | D           | D    | D    | E          | C    | C    | E          | D    | D    |
| HCM2k95thQ:                                 | 9           | 7    | 0    | 10          | 31   | 31   | 26         | 28   | 28   | 11         | 28   | 8    |

Note: Queue reported is the number of cars per lane.

BART

Level Of Service Computation Report  
 2000 HCM Operations (Future Volume Alternative)  
 AM - Existing Conditions

Intersection #3627: KING/SAN ANTONIO [Study Int 22]

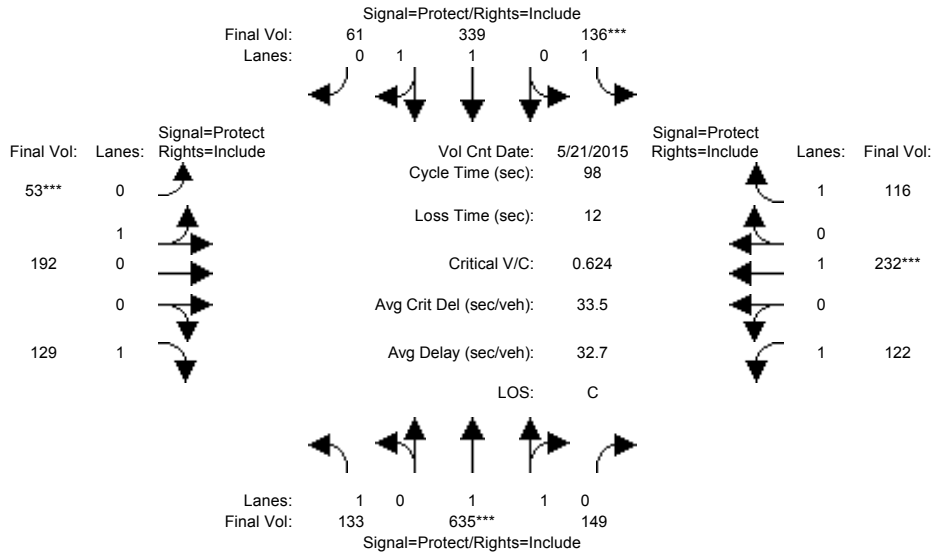

| Approach:  | North Bound |      |      | South Bound |      |      | East Bound |      |      | West Bound |      |      |
|--|-------------|------|------|-------------|------|------|------------|------|------|------------|------|------|
| Movement:  | L           | T    | R    | L           | T    | R    | L          | T    | R    | L          | T    | R    |
| Min. Green:  | 7           | 10   | 10   | 7           | 10   | 10   | 10         | 10   | 10   | 10         | 10   | 10   |
| Y+R:   | 4.0         | 4.0  | 4.0  | 4.0         | 4.0  | 4.0  | 4.0        | 4.0  | 4.0  | 4.0        | 4.0  | 4.0  |
| Volume Module: >> Count Date: 21 May 2015 << 7:30-8:30AM |             |      |      |             |      |      |            |      |      |            |      |      |
| Base Vol:  | 133         | 635  | 149  | 136         | 339  | 61   | 53         | 192  | 129  | 122        | 232  | 116  |
| Growth Adj:  | 1.00        | 1.00 | 1.00 | 1.00        | 1.00 | 1.00 | 1.00       | 1.00 | 1.00 | 1.00       | 1.00 | 1.00 |
| Initial Bse:   | 133         | 635  | 149  | 136         | 339  | 61   | 53         | 192  | 129  | 122        | 232  | 116  |
| Added Vol:   | 0           | 0    | 0    | 0           | 0    | 0    | 0          | 0    | 0    | 0          | 0    | 0    |
| PasserByVol:   | 0           | 0    | 0    | 0           | 0    | 0    | 0          | 0    | 0    | 0          | 0    | 0    |
| Initial Fut:   | 133         | 635  | 149  | 136         | 339  | 61   | 53         | 192  | 129  | 122        | 232  | 116  |
| User Adj:  | 1.00        | 1.00 | 1.00 | 1.00        | 1.00 | 1.00 | 1.00       | 1.00 | 1.00 | 1.00       | 1.00 | 1.00 |
| PHF Adj:   | 1.00        | 1.00 | 1.00 | 1.00        | 1.00 | 1.00 | 1.00       | 1.00 | 1.00 | 1.00       | 1.00 | 1.00 |
| PHF Volume:  | 133         | 635  | 149  | 136         | 339  | 61   | 53         | 192  | 129  | 122        | 232  | 116  |
| Reduct Vol:  | 0           | 0    | 0    | 0           | 0    | 0    | 0          | 0    | 0    | 0          | 0    | 0    |
| Reduced Vol:   | 133         | 635  | 149  | 136         | 339  | 61   | 53         | 192  | 129  | 122        | 232  | 116  |
| PCE Adj:   | 1.00        | 1.00 | 1.00 | 1.00        | 1.00 | 1.00 | 1.00       | 1.00 | 1.00 | 1.00       | 1.00 | 1.00 |
| MLF Adj:   | 1.00        | 1.00 | 1.00 | 1.00        | 1.00 | 1.00 | 1.00       | 1.00 | 1.00 | 1.00       | 1.00 | 1.00 |
| Final Volume:  | 133         | 635  | 149  | 136         | 339  | 61   | 53         | 192  | 129  | 122        | 232  | 116  |
| Saturation Flow Module:                                  |             |      |      |             |      |      |            |      |      |            |      |      |
| Sat/Lane:  | 1900        | 1900 | 1900 | 1900        | 1900 | 1900 | 1900       | 1900 | 1900 | 1900       | 1900 | 1900 |
| Adjustment:  | 0.92        | 0.98 | 0.95 | 0.92        | 0.98 | 0.95 | 0.95       | 0.95 | 0.92 | 0.92       | 1.00 | 0.92 |
| Lanes:   | 1.00        | 1.61 | 0.39 | 1.00        | 1.69 | 0.31 | 0.22       | 0.78 | 1.00 | 1.00       | 1.00 | 1.00 |
| Final Sat.:  | 1750        | 2996 | 703  | 1750        | 3135 | 564  | 389        | 1411 | 1750 | 1750       | 1900 | 1750 |
| Capacity Analysis Module:                                |             |      |      |             |      |      |            |      |      |            |      |      |
| Vol/Sat:   | 0.08        | 0.21 | 0.21 | 0.08        | 0.11 | 0.11 | 0.14       | 0.14 | 0.07 | 0.07       | 0.12 | 0.07 |
| Crit Moves:  | ****        | **** | **** | ****        | **** | **** | ****       | **** | **** | ****       | **** | **** |
| Green Time:  | 18.8        | 33.3 | 33.3 | 12.2        | 26.7 | 26.7 | 21.4       | 23.2 | 23.2 | 17.4       | 19.2 | 19.2 |
| Volume/Cap:  | 0.40        | 0.62 | 0.62 | 0.62        | 0.40 | 0.40 | 0.62       | 0.58 | 0.31 | 0.39       | 0.62 | 0.34 |
| Delay/Veh:   | 35.4        | 28.1 | 28.1 | 46.3        | 29.3 | 29.3 | 37.8       | 35.0 | 31.3 | 36.5       | 39.4 | 34.5 |
| User DelAdj:   | 1.00        | 1.00 | 1.00 | 1.00        | 1.00 | 1.00 | 1.00       | 1.00 | 1.00 | 1.00       | 1.00 | 1.00 |
| AdjDel/Veh:  | 35.4        | 28.1 | 28.1 | 46.3        | 29.3 | 29.3 | 37.8       | 35.0 | 31.3 | 36.5       | 39.4 | 34.5 |
| LOS by Move:   | D           | C    | C    | D           | C    | C    | D          | D    | C    | D          | D    | C    |
| HCM2k95thQ:  | 7           | 19   | 19   | 8           | 10   | 10   | 15         | 14   | 7    | 8          | 14   | 7    |

Note: Queue reported is the number of cars per lane.

BART

Level Of Service Computation Report  
 2000 HCM Operations (Future Volume Alternative)  
 PM - Existing Conditions

Intersection #3627: KING/SAN ANTONIO [Study Int 22]

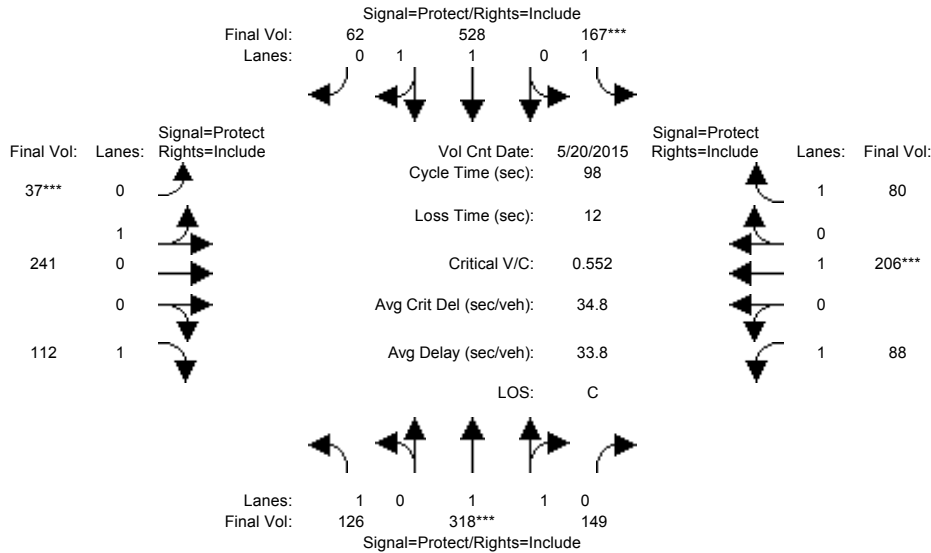

| Approach:  | North Bound |      |      | South Bound |      |      | East Bound |      |      | West Bound |      |      |
|--|-------------|------|------|-------------|------|------|------------|------|------|------------|------|------|
| Movement:  | L           | T    | R    | L           | T    | R    | L          | T    | R    | L          | T    | R    |
| Min. Green:  | 7           | 10   | 10   | 7           | 10   | 10   | 10         | 10   | 10   | 10         | 10   | 10   |
| Y+R:   | 4.0         | 4.0  | 4.0  | 4.0         | 4.0  | 4.0  | 4.0        | 4.0  | 4.0  | 4.0        | 4.0  | 4.0  |
| Volume Module: >> Count Date: 20 May 2015 << 4:45-5:45PM |             |      |      |             |      |      |            |      |      |            |      |      |
| Base Vol:  | 126         | 318  | 149  | 167         | 528  | 62   | 37         | 241  | 112  | 88         | 206  | 80   |
| Growth Adj:  | 1.00        | 1.00 | 1.00 | 1.00        | 1.00 | 1.00 | 1.00       | 1.00 | 1.00 | 1.00       | 1.00 | 1.00 |
| Initial Bse:   | 126         | 318  | 149  | 167         | 528  | 62   | 37         | 241  | 112  | 88         | 206  | 80   |
| Added Vol:   | 0           | 0    | 0    | 0           | 0    | 0    | 0          | 0    | 0    | 0          | 0    | 0    |
| PasserByVol:   | 0           | 0    | 0    | 0           | 0    | 0    | 0          | 0    | 0    | 0          | 0    | 0    |
| Initial Fut:   | 126         | 318  | 149  | 167         | 528  | 62   | 37         | 241  | 112  | 88         | 206  | 80   |
| User Adj:  | 1.00        | 1.00 | 1.00 | 1.00        | 1.00 | 1.00 | 1.00       | 1.00 | 1.00 | 1.00       | 1.00 | 1.00 |
| PHF Adj:   | 1.00        | 1.00 | 1.00 | 1.00        | 1.00 | 1.00 | 1.00       | 1.00 | 1.00 | 1.00       | 1.00 | 1.00 |
| PHF Volume:  | 126         | 318  | 149  | 167         | 528  | 62   | 37         | 241  | 112  | 88         | 206  | 80   |
| Reduct Vol:  | 0           | 0    | 0    | 0           | 0    | 0    | 0          | 0    | 0    | 0          | 0    | 0    |
| Reduced Vol:   | 126         | 318  | 149  | 167         | 528  | 62   | 37         | 241  | 112  | 88         | 206  | 80   |
| PCE Adj:   | 1.00        | 1.00 | 1.00 | 1.00        | 1.00 | 1.00 | 1.00       | 1.00 | 1.00 | 1.00       | 1.00 | 1.00 |
| MLF Adj:   | 1.00        | 1.00 | 1.00 | 1.00        | 1.00 | 1.00 | 1.00       | 1.00 | 1.00 | 1.00       | 1.00 | 1.00 |
| Final Volume:  | 126         | 318  | 149  | 167         | 528  | 62   | 37         | 241  | 112  | 88         | 206  | 80   |
| Saturation Flow Module:                                  |             |      |      |             |      |      |            |      |      |            |      |      |
| Sat/Lane:  | 1900        | 1900 | 1900 | 1900        | 1900 | 1900 | 1900       | 1900 | 1900 | 1900       | 1900 | 1900 |
| Adjustment:  | 0.92        | 0.99 | 0.95 | 0.92        | 0.98 | 0.95 | 0.95       | 0.95 | 0.92 | 0.92       | 1.00 | 0.92 |
| Lanes:   | 1.00        | 1.34 | 0.66 | 1.00        | 1.78 | 0.22 | 0.13       | 0.87 | 1.00 | 1.00       | 1.00 | 1.00 |
| Final Sat.:  | 1750        | 2519 | 1180 | 1750        | 3311 | 389  | 240        | 1560 | 1750 | 1750       | 1900 | 1750 |
| Capacity Analysis Module:                                |             |      |      |             |      |      |            |      |      |            |      |      |
| Vol/Sat:   | 0.07        | 0.13 | 0.13 | 0.10        | 0.16 | 0.16 | 0.15       | 0.15 | 0.06 | 0.05       | 0.11 | 0.05 |
| Crit Moves:  | ****        | **** | **** | ****        | **** | **** | ****       | **** | **** | ****       | **** | **** |
| Green Time:  | 12.2        | 22.4 | 22.4 | 16.9        | 27.1 | 27.1 | 27.4       | 28.1 | 28.1 | 18.6       | 19.2 | 19.2 |
| Volume/Cap:  | 0.58        | 0.55 | 0.55 | 0.55        | 0.58 | 0.58 | 0.55       | 0.54 | 0.22 | 0.27       | 0.55 | 0.23 |
| Delay/Veh:   | 44.2        | 34.2 | 34.2 | 39.3        | 31.3 | 31.3 | 31.4       | 30.6 | 26.9 | 34.3       | 37.3 | 33.5 |
| User DelAdj:   | 1.00        | 1.00 | 1.00 | 1.00        | 1.00 | 1.00 | 1.00       | 1.00 | 1.00 | 1.00       | 1.00 | 1.00 |
| AdjDel/Veh:  | 44.2        | 34.2 | 34.2 | 39.3        | 31.3 | 31.3 | 31.4       | 30.6 | 26.9 | 34.3       | 37.3 | 33.5 |
| LOS by Move:   | D           | C    | C    | D           | C    | C    | C          | C    | C    | C          | D    | C    |
| HCM2k95thQ:  | 8           | 12   | 12   | 10          | 15   | 15   | 15         | 15   | 6    | 5          | 12   | 5    |

Note: Queue reported is the number of cars per lane.

BART

Level Of Service Computation Report  
2000 HCM Operations (Future Volume Alternative)  
AM - Existing Conditions

Intersection #3678: MCKEE/33RD [Study Int 6]

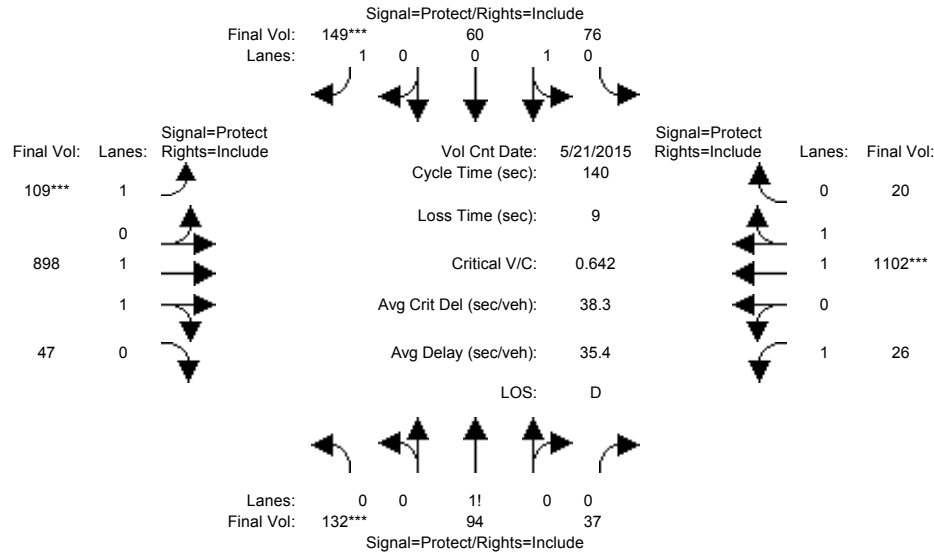

| Approach:  | North Bound |      |      | South Bound |      |      | East Bound |      |      | West Bound |      |      |
|--|-------------|------|------|-------------|------|------|------------|------|------|------------|------|------|
| Movement:  | L           | T    | R    | L           | T    | R    | L          | T    | R    | L          | T    | R    |
| Min. Green:  | 10          | 10   | 10   | 10          | 10   | 10   | 7          | 10   | 10   | 7          | 10   | 10   |
| Y+R:   | 4.0         | 4.0  | 4.0  | 4.0         | 4.0  | 4.0  | 4.0        | 4.0  | 4.0  | 4.0        | 4.0  | 4.0  |
| Volume Module: >> Count Date: 21 May 2015 << 7:30-8:30AM |             |      |      |             |      |      |            |      |      |            |      |      |
| Base Vol:  | 132         | 94   | 37   | 76          | 60   | 149  | 109        | 898  | 47   | 26         | 1102 | 20   |
| Growth Adj:  | 1.00        | 1.00 | 1.00 | 1.00        | 1.00 | 1.00 | 1.00       | 1.00 | 1.00 | 1.00       | 1.00 | 1.00 |
| Initial Bse:   | 132         | 94   | 37   | 76          | 60   | 149  | 109        | 898  | 47   | 26         | 1102 | 20   |
| Added Vol:   | 0           | 0    | 0    | 0           | 0    | 0    | 0          | 0    | 0    | 0          | 0    | 0    |
| PasserByVol:   | 0           | 0    | 0    | 0           | 0    | 0    | 0          | 0    | 0    | 0          | 0    | 0    |
| Initial Fut:   | 132         | 94   | 37   | 76          | 60   | 149  | 109        | 898  | 47   | 26         | 1102 | 20   |
| User Adj:  | 1.00        | 1.00 | 1.00 | 1.00        | 1.00 | 1.00 | 1.00       | 1.00 | 1.00 | 1.00       | 1.00 | 1.00 |
| PHF Adj:   | 1.00        | 1.00 | 1.00 | 1.00        | 1.00 | 1.00 | 1.00       | 1.00 | 1.00 | 1.00       | 1.00 | 1.00 |
| PHF Volume:  | 132         | 94   | 37   | 76          | 60   | 149  | 109        | 898  | 47   | 26         | 1102 | 20   |
| Reduct Vol:  | 0           | 0    | 0    | 0           | 0    | 0    | 0          | 0    | 0    | 0          | 0    | 0    |
| Reduced Vol:   | 132         | 94   | 37   | 76          | 60   | 149  | 109        | 898  | 47   | 26         | 1102 | 20   |
| PCE Adj:   | 1.00        | 1.00 | 1.00 | 1.00        | 1.00 | 1.00 | 1.00       | 1.00 | 1.00 | 1.00       | 1.00 | 1.00 |
| MLF Adj:   | 1.00        | 1.00 | 1.00 | 1.00        | 1.00 | 1.00 | 1.00       | 1.00 | 1.00 | 1.00       | 1.00 | 1.00 |
| Final Volume:  | 132         | 94   | 37   | 76          | 60   | 149  | 109        | 898  | 47   | 26         | 1102 | 20   |
| Saturation Flow Module:                                  |             |      |      |             |      |      |            |      |      |            |      |      |
| Sat/Lane:  | 1900        | 1900 | 1900 | 1900        | 1900 | 1900 | 1900       | 1900 | 1900 | 1900       | 1900 | 1900 |
| Adjustment:  | 0.92        | 0.92 | 0.92 | 0.95        | 0.95 | 0.92 | 0.92       | 0.98 | 0.95 | 0.92       | 0.97 | 0.95 |
| Lanes:   | 0.50        | 0.36 | 0.14 | 0.56        | 0.44 | 1.00 | 1.00       | 1.90 | 0.10 | 1.00       | 1.96 | 0.04 |
| Final Sat.:  | 878         | 625  | 246  | 1006        | 794  | 1750 | 1750       | 3516 | 184  | 1750       | 3634 | 66   |
| Capacity Analysis Module:                                |             |      |      |             |      |      |            |      |      |            |      |      |
| Vol/Sat:   | 0.15        | 0.15 | 0.15 | 0.08        | 0.08 | 0.09 | 0.06       | 0.26 | 0.26 | 0.01       | 0.30 | 0.30 |
| Crit Moves:  | ****        | **** | **** | ****        | **** | **** | ****       | **** | **** | ****       | **** | **** |
| Green Time:  | 32.8        | 34.2 | 34.2 | 17.2        | 18.6 | 18.6 | 13.6       | 66.6 | 66.6 | 13.0       | 66.1 | 66.1 |
| Volume/Cap:  | 0.64        | 0.62 | 0.62 | 0.62        | 0.57 | 0.64 | 0.64       | 0.54 | 0.54 | 0.16       | 0.64 | 0.64 |
| Delay/Veh:   | 51.8        | 49.8 | 49.8 | 63.4        | 60.2 | 63.6 | 69.0       | 26.1 | 26.1 | 58.9       | 28.8 | 28.8 |
| User DelAdj:   | 1.00        | 1.00 | 1.00 | 1.00        | 1.00 | 1.00 | 1.00       | 1.00 | 1.00 | 1.00       | 1.00 | 1.00 |
| AdjDel/Veh:  | 51.8        | 49.8 | 49.8 | 63.4        | 60.2 | 63.6 | 69.0       | 26.1 | 26.1 | 58.9       | 28.8 | 28.8 |
| LOS by Move:   | D           | D    | D    | E           | E    | E    | E          | C    | C    | E          | C    | C    |
| HCM2k95thQ:  | 20          | 20   | 20   | 13          | 12   | 14   | 10         | 25   | 25   | 2          | 31   | 31   |

Note: Queue reported is the number of cars per lane.

BART

Level Of Service Computation Report  
2000 HCM Operations (Future Volume Alternative)  
PM - Existing Conditions

Intersection #3678: MCKEE/33RD [Study Int 6]

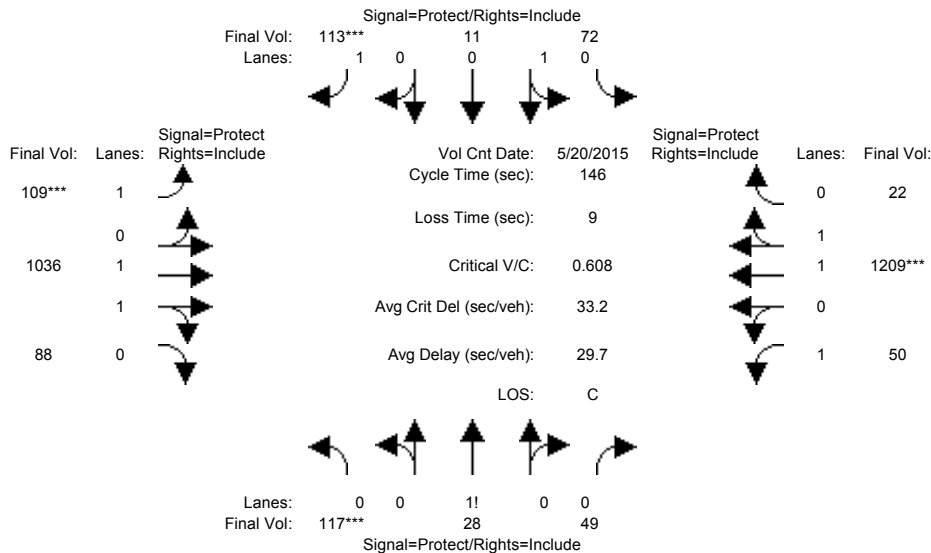

| Approach:  | North Bound |      |      | South Bound |      |      | East Bound |      |      | West Bound |      |      |
|--|-------------|------|------|-------------|------|------|------------|------|------|------------|------|------|
| Movement:  | L           | T    | R    | L           | T    | R    | L          | T    | R    | L          | T    | R    |
| Min. Green:  | 10          | 10   | 10   | 10          | 10   | 10   | 7          | 10   | 10   | 7          | 10   | 10   |
| Y+R:   | 4.0         | 4.0  | 4.0  | 4.0         | 4.0  | 4.0  | 4.0        | 4.0  | 4.0  | 4.0        | 4.0  | 4.0  |
| Volume Module: >> Count Date: 20 May 2015 << 5:00-6:00PM |             |      |      |             |      |      |            |      |      |            |      |      |
| Base Vol:  | 117         | 28   | 49   | 72          | 11   | 113  | 109        | 1036 | 88   | 50         | 1209 | 22   |
| Growth Adj:  | 1.00        | 1.00 | 1.00 | 1.00        | 1.00 | 1.00 | 1.00       | 1.00 | 1.00 | 1.00       | 1.00 | 1.00 |
| Initial Bse:   | 117         | 28   | 49   | 72          | 11   | 113  | 109        | 1036 | 88   | 50         | 1209 | 22   |
| Added Vol:   | 0           | 0    | 0    | 0           | 0    | 0    | 0          | 0    | 0    | 0          | 0    | 0    |
| PasserByVol:   | 0           | 0    | 0    | 0           | 0    | 0    | 0          | 0    | 0    | 0          | 0    | 0    |
| Initial Fut:   | 117         | 28   | 49   | 72          | 11   | 113  | 109        | 1036 | 88   | 50         | 1209 | 22   |
| User Adj:  | 1.00        | 1.00 | 1.00 | 1.00        | 1.00 | 1.00 | 1.00       | 1.00 | 1.00 | 1.00       | 1.00 | 1.00 |
| PHF Adj:   | 1.00        | 1.00 | 1.00 | 1.00        | 1.00 | 1.00 | 1.00       | 1.00 | 1.00 | 1.00       | 1.00 | 1.00 |
| PHF Volume:  | 117         | 28   | 49   | 72          | 11   | 113  | 109        | 1036 | 88   | 50         | 1209 | 22   |
| Reduct Vol:  | 0           | 0    | 0    | 0           | 0    | 0    | 0          | 0    | 0    | 0          | 0    | 0    |
| Reduced Vol:   | 117         | 28   | 49   | 72          | 11   | 113  | 109        | 1036 | 88   | 50         | 1209 | 22   |
| PCE Adj:   | 1.00        | 1.00 | 1.00 | 1.00        | 1.00 | 1.00 | 1.00       | 1.00 | 1.00 | 1.00       | 1.00 | 1.00 |
| MLF Adj:   | 1.00        | 1.00 | 1.00 | 1.00        | 1.00 | 1.00 | 1.00       | 1.00 | 1.00 | 1.00       | 1.00 | 1.00 |
| Final Volume:  | 117         | 28   | 49   | 72          | 11   | 113  | 109        | 1036 | 88   | 50         | 1209 | 22   |
| Saturation Flow Module:                                  |             |      |      |             |      |      |            |      |      |            |      |      |
| Sat/Lane:  | 1900        | 1900 | 1900 | 1900        | 1900 | 1900 | 1900       | 1900 | 1900 | 1900       | 1900 | 1900 |
| Adjustment:  | 0.92        | 0.92 | 0.92 | 0.95        | 0.95 | 0.92 | 0.92       | 0.98 | 0.95 | 0.92       | 0.97 | 0.95 |
| Lanes:   | 0.61        | 0.14 | 0.25 | 0.87        | 0.13 | 1.00 | 1.00       | 1.84 | 0.16 | 1.00       | 1.96 | 0.04 |
| Final Sat.:  | 1055        | 253  | 442  | 1561        | 239  | 1750 | 1750       | 3410 | 290  | 1750       | 3634 | 66   |
| Capacity Analysis Module:                                |             |      |      |             |      |      |            |      |      |            |      |      |
| Vol/Sat:   | 0.11        | 0.11 | 0.11 | 0.05        | 0.05 | 0.06 | 0.06       | 0.30 | 0.30 | 0.03       | 0.33 | 0.33 |
| Crit Moves:  | ****        |      |      | ****        | **** | **** | ****       | **** | **** | ****       | **** | **** |
| Green Time:  | 26.6        | 26.0 | 26.0 | 16.1        | 15.5 | 15.5 | 15.0       | 81.9 | 81.9 | 12.9       | 79.9 | 79.9 |
| Volume/Cap:  | 0.61        | 0.62 | 0.62 | 0.42        | 0.43 | 0.61 | 0.61       | 0.54 | 0.54 | 0.32       | 0.61 | 0.61 |
| Delay/Veh:   | 58.3        | 59.3 | 59.3 | 62.0        | 62.7 | 68.1 | 68.6       | 20.5 | 20.5 | 63.6       | 23.0 | 23.0 |
| User DelAdj:   | 1.00        | 1.00 | 1.00 | 1.00        | 1.00 | 1.00 | 1.00       | 1.00 | 1.00 | 1.00       | 1.00 | 1.00 |
| AdjDel/Veh:  | 58.3        | 59.3 | 59.3 | 62.0        | 62.7 | 68.1 | 68.6       | 20.5 | 20.5 | 63.6       | 23.0 | 23.0 |
| LOS by Move:   | E           | E    | E    | E           | E    | E    | E          | C    | C    | E          | C    | C    |
| HCM2k95thQ:  | 16          | 16   | 16   | 8           | 8    | 12   | 10         | 28   | 28   | 4          | 31   | 31   |

Note: Queue reported is the number of cars per lane.

BART

Level Of Service Computation Report  
 2000 HCM Operations (Future Volume Alternative)  
 AM - Existing Conditions

Intersection #3683: McLAUGHLIN/STORY [Study Int 26]

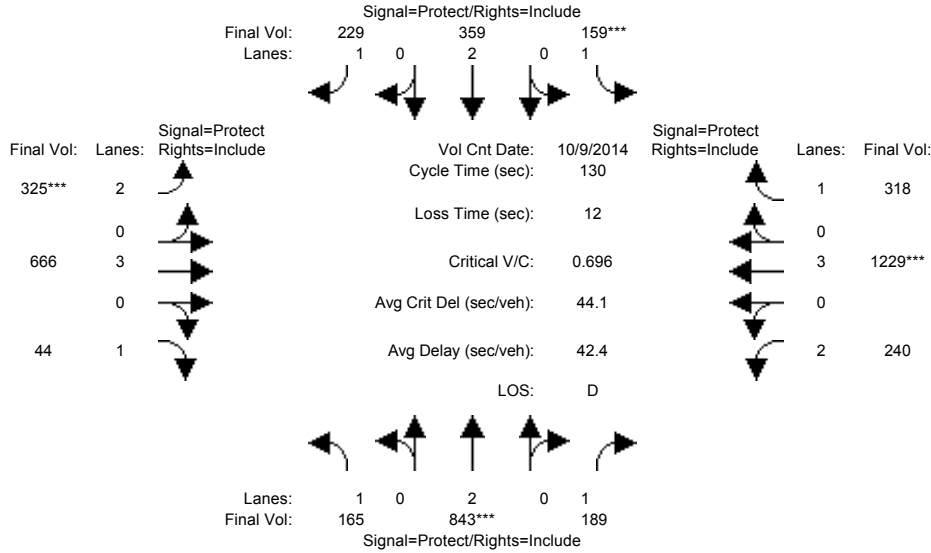

| Approach:                                   | North Bound |      |      | South Bound |      |      | East Bound |      |      | West Bound |      |      |
|---|-------------|------|------|-------------|------|------|------------|------|------|------------|------|------|
| Movement:                                   | L           | T    | R    | L           | T    | R    | L          | T    | R    | L          | T    | R    |
| Min. Green:                                 | 7           | 10   | 10   | 7           | 10   | 10   | 7          | 10   | 10   | 7          | 10   | 10   |
| Y+R:  | 4.0         | 4.0  | 4.0  | 4.0         | 4.0  | 4.0  | 4.0        | 4.0  | 4.0  | 4.0        | 4.0  | 4.0  |
| Volume Module: >> Count Date: 9 Oct 2014 << |             |      |      |             |      |      |            |      |      |            |      |      |
| Base Vol:                                   | 165         | 843  | 189  | 159         | 359  | 229  | 325        | 666  | 44   | 240        | 1229 | 318  |
| Growth Adj:                                 | 1.00        | 1.00 | 1.00 | 1.00        | 1.00 | 1.00 | 1.00       | 1.00 | 1.00 | 1.00       | 1.00 | 1.00 |
| Initial Bse:                                | 165         | 843  | 189  | 159         | 359  | 229  | 325        | 666  | 44   | 240        | 1229 | 318  |
| Added Vol:                                  | 0           | 0    | 0    | 0           | 0    | 0    | 0          | 0    | 0    | 0          | 0    | 0    |
| PasserByVol:                                | 0           | 0    | 0    | 0           | 0    | 0    | 0          | 0    | 0    | 0          | 0    | 0    |
| Initial Fut:                                | 165         | 843  | 189  | 159         | 359  | 229  | 325        | 666  | 44   | 240        | 1229 | 318  |
| User Adj:                                   | 1.00        | 1.00 | 1.00 | 1.00        | 1.00 | 1.00 | 1.00       | 1.00 | 1.00 | 1.00       | 1.00 | 1.00 |
| PHF Adj:                                    | 1.00        | 1.00 | 1.00 | 1.00        | 1.00 | 1.00 | 1.00       | 1.00 | 1.00 | 1.00       | 1.00 | 1.00 |
| PHF Volume:                                 | 165         | 843  | 189  | 159         | 359  | 229  | 325        | 666  | 44   | 240        | 1229 | 318  |
| Reduct Vol:                                 | 0           | 0    | 0    | 0           | 0    | 0    | 0          | 0    | 0    | 0          | 0    | 0    |
| Reduced Vol:                                | 165         | 843  | 189  | 159         | 359  | 229  | 325        | 666  | 44   | 240        | 1229 | 318  |
| PCE Adj:                                    | 1.00        | 1.00 | 1.00 | 1.00        | 1.00 | 1.00 | 1.00       | 1.00 | 1.00 | 1.00       | 1.00 | 1.00 |
| MLF Adj:                                    | 1.00        | 1.00 | 1.00 | 1.00        | 1.00 | 1.00 | 1.00       | 1.00 | 1.00 | 1.00       | 1.00 | 1.00 |
| Final Volume:                               | 165         | 843  | 189  | 159         | 359  | 229  | 325        | 666  | 44   | 240        | 1229 | 318  |
| Saturation Flow Module:                     |             |      |      |             |      |      |            |      |      |            |      |      |
| Sat/Lane:                                   | 1900        | 1900 | 1900 | 1900        | 1900 | 1900 | 1900       | 1900 | 1900 | 1900       | 1900 | 1900 |
| Adjustment:                                 | 0.92        | 1.00 | 0.92 | 0.92        | 1.00 | 0.92 | 0.83       | 1.00 | 0.92 | 0.83       | 1.00 | 0.92 |
| Lanes:                                      | 1.00        | 2.00 | 1.00 | 1.00        | 2.00 | 1.00 | 2.00       | 3.00 | 1.00 | 2.00       | 3.00 | 1.00 |
| Final Sat.:                                 | 1750        | 3800 | 1750 | 1750        | 3800 | 1750 | 3150       | 5700 | 1750 | 3150       | 5700 | 1750 |
| Capacity Analysis Module:                   |             |      |      |             |      |      |            |      |      |            |      |      |
| Vol/Sat:                                    | 0.09        | 0.22 | 0.11 | 0.09        | 0.09 | 0.13 | 0.10       | 0.12 | 0.03 | 0.08       | 0.22 | 0.18 |
| Crit Moves:                                 | ****        | **** | **** | ****        | **** | **** | ****       | **** | **** | ****       | **** | **** |
| Green Time:                                 | 24.5        | 41.5 | 41.5 | 17.0        | 34.0 | 34.0 | 19.3       | 36.1 | 36.1 | 23.5       | 40.3 | 40.3 |
| Volume/Cap:                                 | 0.50        | 0.70 | 0.34 | 0.70        | 0.36 | 0.50 | 0.70       | 0.42 | 0.09 | 0.42       | 0.70 | 0.59 |
| Delay/Veh:                                  | 48.5        | 40.5 | 34.2 | 63.0        | 39.4 | 41.7 | 57.1       | 38.6 | 34.9 | 47.7       | 40.7 | 39.5 |
| User DelAdj:                                | 1.00        | 1.00 | 1.00 | 1.00        | 1.00 | 1.00 | 1.00       | 1.00 | 1.00 | 1.00       | 1.00 | 1.00 |
| AdjDel/Veh:                                 | 48.5        | 40.5 | 34.2 | 63.0        | 39.4 | 41.7 | 57.1       | 38.6 | 34.9 | 47.7       | 40.7 | 39.5 |
| LOS by Move:                                | D           | D    | C    | E           | D    | D    | E          | D    | C    | D          | D    | D    |
| HCM2k95thQ:                                 | 13          | 27   | 12   | 13          | 11   | 15   | 16         | 14   | 3    | 10         | 25   | 21   |

Note: Queue reported is the number of cars per lane.



BART

Level Of Service Computation Report  
2000 HCM Operations (Future Volume Alternative)  
PM - Existing Conditions

Intersection #3683: McLAUGHLIN/STORY [Study Int 26]

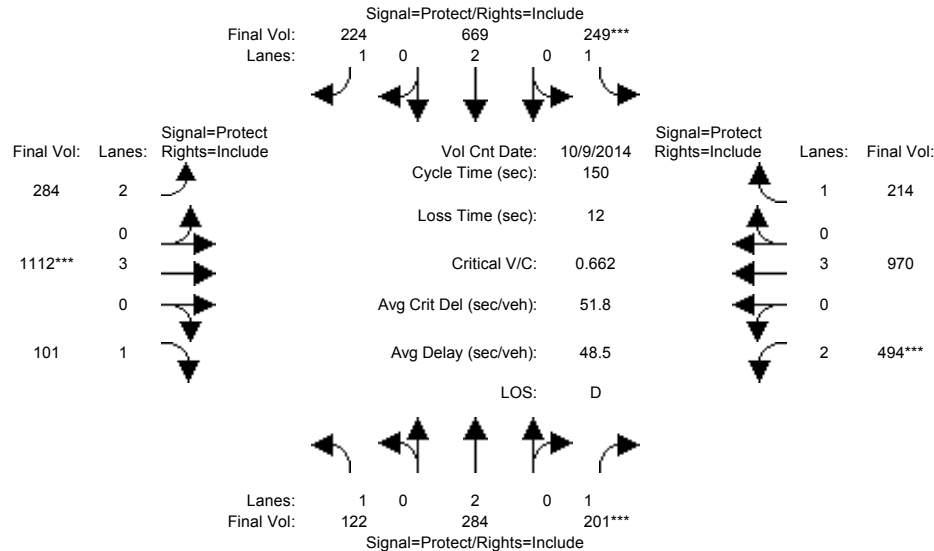

| Approach:                                   | North Bound |      |      | South Bound |      |      | East Bound |      |      | West Bound |      |      |
|---|-------------|------|------|-------------|------|------|------------|------|------|------------|------|------|
| Movement:                                   | L           | T    | R    | L           | T    | R    | L          | T    | R    | L          | T    | R    |
| Min. Green:                                 | 7           | 10   | 10   | 7           | 10   | 10   | 7          | 10   | 10   | 7          | 10   | 10   |
| Y+R:  | 4.0         | 4.0  | 4.0  | 4.0         | 4.0  | 4.0  | 4.0        | 4.0  | 4.0  | 4.0        | 4.0  | 4.0  |
| Volume Module: >> Count Date: 9 Oct 2014 << |             |      |      |             |      |      |            |      |      |            |      |      |
| Base Vol:                                   | 122         | 284  | 201  | 249         | 669  | 224  | 284        | 1112 | 101  | 494        | 970  | 214  |
| Growth Adj:                                 | 1.00        | 1.00 | 1.00 | 1.00        | 1.00 | 1.00 | 1.00       | 1.00 | 1.00 | 1.00       | 1.00 | 1.00 |
| Initial Bse:                                | 122         | 284  | 201  | 249         | 669  | 224  | 284        | 1112 | 101  | 494        | 970  | 214  |
| Added Vol:                                  | 0           | 0    | 0    | 0           | 0    | 0    | 0          | 0    | 0    | 0          | 0    | 0    |
| PasserByVol:                                | 0           | 0    | 0    | 0           | 0    | 0    | 0          | 0    | 0    | 0          | 0    | 0    |
| Initial Fut:                                | 122         | 284  | 201  | 249         | 669  | 224  | 284        | 1112 | 101  | 494        | 970  | 214  |
| User Adj:                                   | 1.00        | 1.00 | 1.00 | 1.00        | 1.00 | 1.00 | 1.00       | 1.00 | 1.00 | 1.00       | 1.00 | 1.00 |
| PHF Adj:                                    | 1.00        | 1.00 | 1.00 | 1.00        | 1.00 | 1.00 | 1.00       | 1.00 | 1.00 | 1.00       | 1.00 | 1.00 |
| PHF Volume:                                 | 122         | 284  | 201  | 249         | 669  | 224  | 284        | 1112 | 101  | 494        | 970  | 214  |
| Reduct Vol:                                 | 0           | 0    | 0    | 0           | 0    | 0    | 0          | 0    | 0    | 0          | 0    | 0    |
| Reduced Vol:                                | 122         | 284  | 201  | 249         | 669  | 224  | 284        | 1112 | 101  | 494        | 970  | 214  |
| PCE Adj:                                    | 1.00        | 1.00 | 1.00 | 1.00        | 1.00 | 1.00 | 1.00       | 1.00 | 1.00 | 1.00       | 1.00 | 1.00 |
| MLF Adj:                                    | 1.00        | 1.00 | 1.00 | 1.00        | 1.00 | 1.00 | 1.00       | 1.00 | 1.00 | 1.00       | 1.00 | 1.00 |
| Final Volume:                               | 122         | 284  | 201  | 249         | 669  | 224  | 284        | 1112 | 101  | 494        | 970  | 214  |
| Saturation Flow Module:                     |             |      |      |             |      |      |            |      |      |            |      |      |
| Sat/Lane:                                   | 1900        | 1900 | 1900 | 1900        | 1900 | 1900 | 1900       | 1900 | 1900 | 1900       | 1900 | 1900 |
| Adjustment:                                 | 0.92        | 1.00 | 0.92 | 0.92        | 1.00 | 0.92 | 0.83       | 1.00 | 0.92 | 0.83       | 1.00 | 0.92 |
| Lanes:                                      | 1.00        | 2.00 | 1.00 | 1.00        | 2.00 | 1.00 | 2.00       | 3.00 | 1.00 | 2.00       | 3.00 | 1.00 |
| Final Sat.:                                 | 1750        | 3800 | 1750 | 1750        | 3800 | 1750 | 3150       | 5700 | 1750 | 3150       | 5700 | 1750 |
| Capacity Analysis Module:                   |             |      |      |             |      |      |            |      |      |            |      |      |
| Vol/Sat:                                    | 0.07        | 0.07 | 0.11 | 0.14        | 0.18 | 0.13 | 0.09       | 0.20 | 0.06 | 0.16       | 0.17 | 0.12 |
| Crit Moves:                                 | ****        | **** | **** | ****        | **** | **** | ****       | **** | **** | ****       | **** | **** |
| Green Time:                                 | 16.5        | 26.0 | 26.0 | 32.2        | 41.7 | 41.7 | 27.6       | 44.2 | 44.2 | 35.5       | 52.1 | 52.1 |
| Volume/Cap:                                 | 0.63        | 0.43 | 0.66 | 0.66        | 0.63 | 0.46 | 0.49       | 0.66 | 0.20 | 0.66       | 0.49 | 0.35 |
| Delay/Veh:                                  | 70.5        | 55.8 | 63.3 | 58.3        | 48.7 | 45.5 | 55.5       | 47.4 | 39.8 | 54.0       | 38.7 | 36.7 |
| User DelAdj:                                | 1.00        | 1.00 | 1.00 | 1.00        | 1.00 | 1.00 | 1.00       | 1.00 | 1.00 | 1.00       | 1.00 | 1.00 |
| AdjDel/Veh:                                 | 70.5        | 55.8 | 63.3 | 58.3        | 48.7 | 45.5 | 55.5       | 47.4 | 39.8 | 54.0       | 38.7 | 36.7 |
| LOS by Move:                                | E           | E    | E    | E           | D    | D    | E          | D    | D    | D          | D    | D    |
| HCM2k95thQ:                                 | 13          | 12   | 19   | 21          | 24   | 17   | 14         | 27   | 7    | 22         | 21   | 14   |

Note: Queue reported is the number of cars per lane.

BART

Level Of Service Computation Report  
 2000 HCM Operations (Future Volume Alternative)  
 AM - Existing Conditions

Intersection #3762: SAN ANTONIO/24TH [Study Int 21]

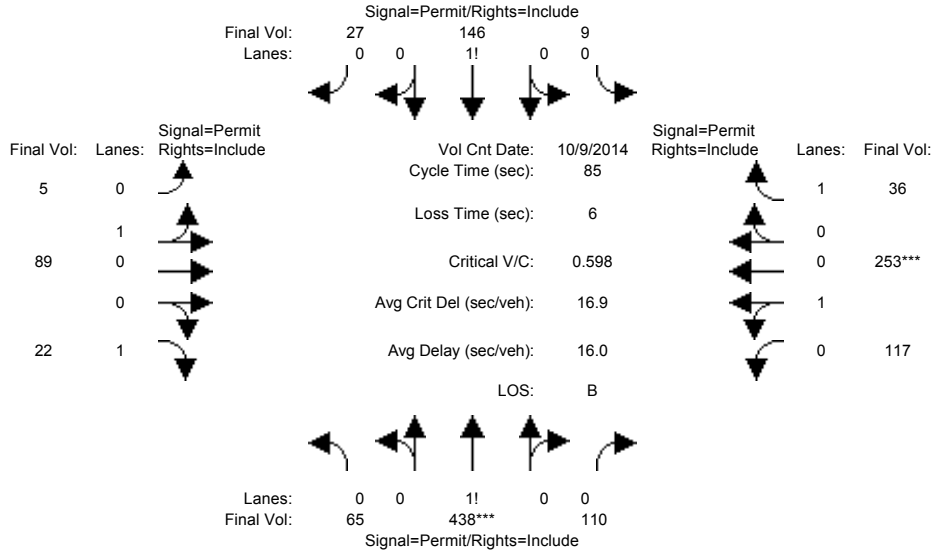

| Approach:                 | North Bound                  |      |      | South Bound |      |      | East Bound |      |      | West Bound |      |      |
|---------------------------|------------------------------|------|------|-------------|------|------|------------|------|------|------------|------|------|
| Movement:                 | L                            | T    | R    | L           | T    | R    | L          | T    | R    | L          | T    | R    |
| Min. Green:               | 10                           | 10   | 10   | 10          | 10   | 10   | 10         | 10   | 10   | 10         | 10   | 10   |
| Y+R:                      | 4.0                          | 4.0  | 4.0  | 4.0         | 4.0  | 4.0  | 4.0        | 4.0  | 4.0  | 4.0        | 4.0  | 4.0  |
| -----                     |                              |      |      |             |      |      |            |      |      |            |      |      |
| Volume Module:            | >> Count Date: 9 Oct 2014 << |      |      |             |      |      |            |      |      |            |      |      |
| Base Vol:                 | 65                           | 438  | 110  | 9           | 146  | 27   | 5          | 89   | 22   | 117        | 253  | 36   |
| Growth Adj:               | 1.00                         | 1.00 | 1.00 | 1.00        | 1.00 | 1.00 | 1.00       | 1.00 | 1.00 | 1.00       | 1.00 | 1.00 |
| Initial Bse:              | 65                           | 438  | 110  | 9           | 146  | 27   | 5          | 89   | 22   | 117        | 253  | 36   |
| Added Vol:                | 0                            | 0    | 0    | 0           | 0    | 0    | 0          | 0    | 0    | 0          | 0    | 0    |
| PasserByVol:              | 0                            | 0    | 0    | 0           | 0    | 0    | 0          | 0    | 0    | 0          | 0    | 0    |
| Initial Fut:              | 65                           | 438  | 110  | 9           | 146  | 27   | 5          | 89   | 22   | 117        | 253  | 36   |
| User Adj:                 | 1.00                         | 1.00 | 1.00 | 1.00        | 1.00 | 1.00 | 1.00       | 1.00 | 1.00 | 1.00       | 1.00 | 1.00 |
| PHF Adj:                  | 1.00                         | 1.00 | 1.00 | 1.00        | 1.00 | 1.00 | 1.00       | 1.00 | 1.00 | 1.00       | 1.00 | 1.00 |
| PHF Volume:               | 65                           | 438  | 110  | 9           | 146  | 27   | 5          | 89   | 22   | 117        | 253  | 36   |
| Reduct Vol:               | 0                            | 0    | 0    | 0           | 0    | 0    | 0          | 0    | 0    | 0          | 0    | 0    |
| Reduced Vol:              | 65                           | 438  | 110  | 9           | 146  | 27   | 5          | 89   | 22   | 117        | 253  | 36   |
| PCE Adj:                  | 1.00                         | 1.00 | 1.00 | 1.00        | 1.00 | 1.00 | 1.00       | 1.00 | 1.00 | 1.00       | 1.00 | 1.00 |
| MLF Adj:                  | 1.00                         | 1.00 | 1.00 | 1.00        | 1.00 | 1.00 | 1.00       | 1.00 | 1.00 | 1.00       | 1.00 | 1.00 |
| Final Volume:             | 65                           | 438  | 110  | 9           | 146  | 27   | 5          | 89   | 22   | 117        | 253  | 36   |
| -----                     |                              |      |      |             |      |      |            |      |      |            |      |      |
| Saturation Flow Module:   |                              |      |      |             |      |      |            |      |      |            |      |      |
| Sat/Lane:                 | 1900                         | 1900 | 1900 | 1900        | 1900 | 1900 | 1900       | 1900 | 1900 | 1900       | 1900 | 1900 |
| Adjustment:               | 0.92                         | 0.92 | 0.92 | 0.92        | 0.92 | 0.92 | 0.95       | 0.95 | 0.92 | 0.95       | 0.95 | 0.92 |
| Lanes:                    | 0.11                         | 0.71 | 0.18 | 0.05        | 0.80 | 0.15 | 0.05       | 0.95 | 1.00 | 0.32       | 0.68 | 1.00 |
| Final Sat.:               | 186                          | 1250 | 314  | 87          | 1404 | 260  | 96         | 1704 | 1750 | 569        | 1231 | 1750 |
| -----                     |                              |      |      |             |      |      |            |      |      |            |      |      |
| Capacity Analysis Module: |                              |      |      |             |      |      |            |      |      |            |      |      |
| Vol/Sat:                  | 0.35                         | 0.35 | 0.35 | 0.10        | 0.10 | 0.10 | 0.05       | 0.05 | 0.01 | 0.21       | 0.21 | 0.02 |
| Crit Moves:               | *****                        |      |      |             |      |      |            |      |      |            |      |      |
| Green Time:               | 49.8                         | 49.8 | 49.8 | 49.8        | 49.8 | 49.8 | 29.2       | 29.2 | 29.2 | 29.2       | 29.2 | 29.2 |
| Volume/Cap:               | 0.60                         | 0.60 | 0.60 | 0.18        | 0.18 | 0.18 | 0.15       | 0.15 | 0.04 | 0.60       | 0.60 | 0.06 |
| Delay/Veh:                | 12.2                         | 12.2 | 12.2 | 8.2         | 8.2  | 8.2  | 19.4       | 19.4 | 18.6 | 24.7       | 24.7 | 18.7 |
| User DelAdj:              | 1.00                         | 1.00 | 1.00 | 1.00        | 1.00 | 1.00 | 1.00       | 1.00 | 1.00 | 1.00       | 1.00 | 1.00 |
| AdjDel/Veh:               | 12.2                         | 12.2 | 12.2 | 8.2         | 8.2  | 8.2  | 19.4       | 19.4 | 18.6 | 24.7       | 24.7 | 18.7 |
| LOS by Move:              | B                            | B    | B    | A           | A    | A    | B          | B    | B    | C          | C    | B    |
| HCM2k95thQ:               | 20                           | 20   | 20   | 5           | 5    | 5    | 4          | 4    | 1    | 16         | 16   | 1    |

Note: Queue reported is the number of cars per lane.

BART

Level Of Service Computation Report  
 2000 HCM Operations (Future Volume Alternative)  
 PM - Existing Conditions

Intersection #3762: SAN ANTONIO/24TH [Study Int 21]

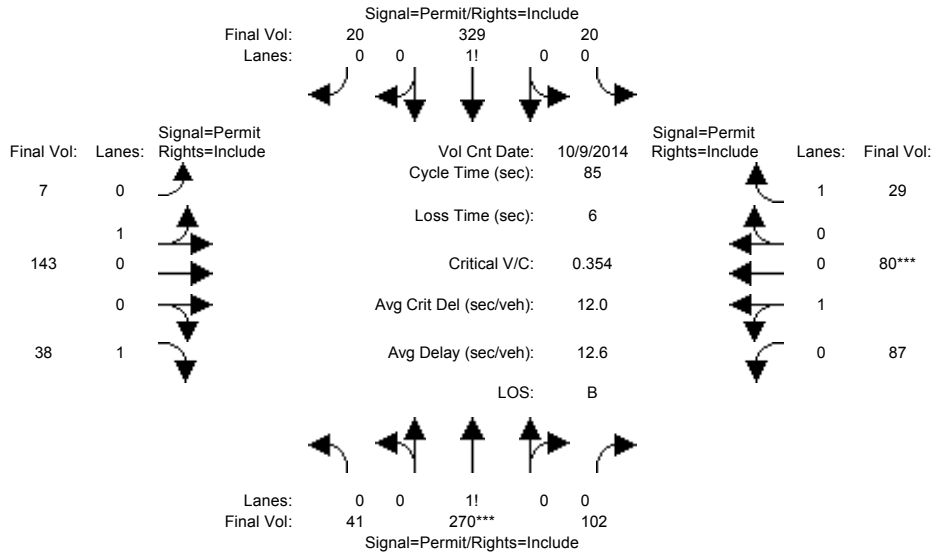

| Approach:                                   | North Bound |      |      | South Bound |      |      | East Bound |      |      | West Bound |      |      |
|---|-------------|------|------|-------------|------|------|------------|------|------|------------|------|------|
| Movement:                                   | L           | T    | R    | L           | T    | R    | L          | T    | R    | L          | T    | R    |
| Min. Green:                                 | 10          | 10   | 10   | 10          | 10   | 10   | 10         | 10   | 10   | 10         | 10   | 10   |
| Y+R:  | 4.0         | 4.0  | 4.0  | 4.0         | 4.0  | 4.0  | 4.0        | 4.0  | 4.0  | 4.0        | 4.0  | 4.0  |
| Volume Module: >> Count Date: 9 Oct 2014 << |             |      |      |             |      |      |            |      |      |            |      |      |
| Base Vol:                                   | 41          | 270  | 102  | 20          | 329  | 20   | 7          | 143  | 38   | 87         | 80   | 29   |
| Growth Adj:                                 | 1.00        | 1.00 | 1.00 | 1.00        | 1.00 | 1.00 | 1.00       | 1.00 | 1.00 | 1.00       | 1.00 | 1.00 |
| Initial Bse:                                | 41          | 270  | 102  | 20          | 329  | 20   | 7          | 143  | 38   | 87         | 80   | 29   |
| Added Vol:                                  | 0           | 0    | 0    | 0           | 0    | 0    | 0          | 0    | 0    | 0          | 0    | 0    |
| PasserByVol:                                | 0           | 0    | 0    | 0           | 0    | 0    | 0          | 0    | 0    | 0          | 0    | 0    |
| Initial Fut:                                | 41          | 270  | 102  | 20          | 329  | 20   | 7          | 143  | 38   | 87         | 80   | 29   |
| User Adj:                                   | 1.00        | 1.00 | 1.00 | 1.00        | 1.00 | 1.00 | 1.00       | 1.00 | 1.00 | 1.00       | 1.00 | 1.00 |
| PHF Adj:                                    | 1.00        | 1.00 | 1.00 | 1.00        | 1.00 | 1.00 | 1.00       | 1.00 | 1.00 | 1.00       | 1.00 | 1.00 |
| PHF Volume:                                 | 41          | 270  | 102  | 20          | 329  | 20   | 7          | 143  | 38   | 87         | 80   | 29   |
| Reduct Vol:                                 | 0           | 0    | 0    | 0           | 0    | 0    | 0          | 0    | 0    | 0          | 0    | 0    |
| Reduced Vol:                                | 41          | 270  | 102  | 20          | 329  | 20   | 7          | 143  | 38   | 87         | 80   | 29   |
| PCE Adj:                                    | 1.00        | 1.00 | 1.00 | 1.00        | 1.00 | 1.00 | 1.00       | 1.00 | 1.00 | 1.00       | 1.00 | 1.00 |
| MLF Adj:                                    | 1.00        | 1.00 | 1.00 | 1.00        | 1.00 | 1.00 | 1.00       | 1.00 | 1.00 | 1.00       | 1.00 | 1.00 |
| Final Volume:                               | 41          | 270  | 102  | 20          | 329  | 20   | 7          | 143  | 38   | 87         | 80   | 29   |
| Saturation Flow Module:                     |             |      |      |             |      |      |            |      |      |            |      |      |
| Sat/Lane:                                   | 1900        | 1900 | 1900 | 1900        | 1900 | 1900 | 1900       | 1900 | 1900 | 1900       | 1900 | 1900 |
| Adjustment:                                 | 0.92        | 0.92 | 0.92 | 0.92        | 0.92 | 0.92 | 0.95       | 0.95 | 0.92 | 0.95       | 0.95 | 0.92 |
| Lanes:                                      | 0.10        | 0.65 | 0.25 | 0.05        | 0.90 | 0.05 | 0.05       | 0.95 | 1.00 | 0.52       | 0.48 | 1.00 |
| Final Sat.:                                 | 174         | 1144 | 432  | 95          | 1560 | 95   | 84         | 1716 | 1750 | 938        | 862  | 1750 |
| Capacity Analysis Module:                   |             |      |      |             |      |      |            |      |      |            |      |      |
| Vol/Sat:                                    | 0.24        | 0.24 | 0.24 | 0.21        | 0.21 | 0.21 | 0.08       | 0.08 | 0.02 | 0.09       | 0.09 | 0.02 |
| Crit Moves:                                 | *****       |      |      |             |      |      |            |      |      |            |      |      |
| Green Time:                                 | 56.7        | 56.7 | 56.7 | 56.7        | 56.7 | 56.7 | 22.3       | 22.3 | 22.3 | 22.3       | 22.3 | 22.3 |
| Volume/Cap:                                 | 0.35        | 0.35 | 0.35 | 0.32        | 0.32 | 0.32 | 0.32       | 0.32 | 0.08 | 0.35       | 0.35 | 0.06 |
| Delay/Veh:                                  | 6.3         | 6.3  | 6.3  | 6.1         | 6.1  | 6.1  | 25.6       | 25.6 | 23.7 | 26.0       | 26.0 | 23.6 |
| User DelAdj:                                | 1.00        | 1.00 | 1.00 | 1.00        | 1.00 | 1.00 | 1.00       | 1.00 | 1.00 | 1.00       | 1.00 | 1.00 |
| AdjDel/Veh:                                 | 6.3         | 6.3  | 6.3  | 6.1         | 6.1  | 6.1  | 25.6       | 25.6 | 23.7 | 26.0       | 26.0 | 23.6 |
| LOS by Move:                                | A           | A    | A    | A           | A    | A    | C          | C    | C    | C          | C    | C    |
| HCM2k95thQ:                                 | 10          | 10   | 10   | 9           | 9    | 9    | 7          | 7    | 2    | 7          | 7    | 1    |

Note: Queue reported is the number of cars per lane.

BART

Level Of Service Computation Report  
2000 HCM Operations (Future Volume Alternative)  
AM - Existing Conditions

Intersection #3783: SANTA CLARA/17TH [Study Int 9]

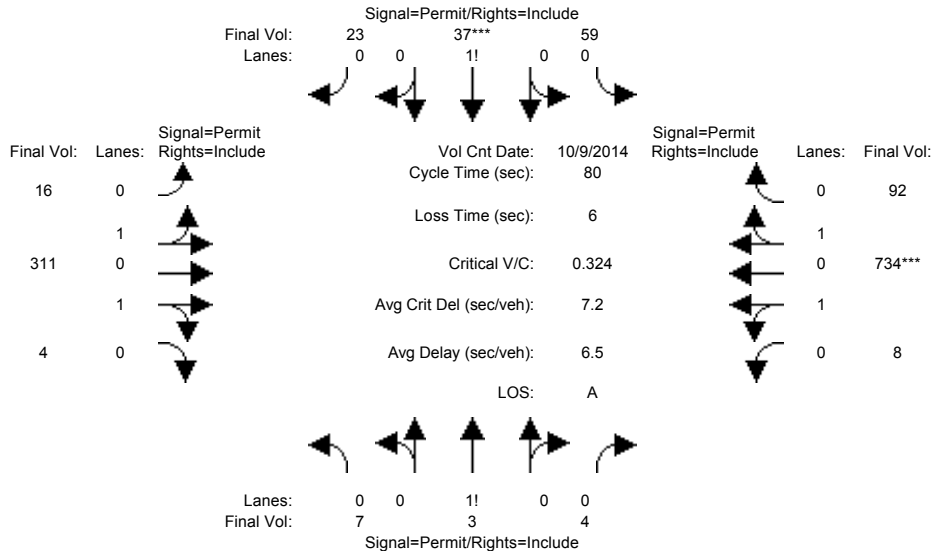

| Approach:                                   | North Bound |      |      | South Bound |      |      | East Bound |      |      | West Bound |      |      |
|---|-------------|------|------|-------------|------|------|------------|------|------|------------|------|------|
| Movement:                                   | L           | T    | R    | L           | T    | R    | L          | T    | R    | L          | T    | R    |
| Min. Green:                                 | 10          | 10   | 10   | 10          | 10   | 10   | 10         | 10   | 10   | 10         | 10   | 10   |
| Y+R:  | 4.0         | 4.0  | 4.0  | 4.0         | 4.0  | 4.0  | 4.0        | 4.0  | 4.0  | 4.0        | 4.0  | 4.0  |
| Volume Module: >> Count Date: 9 Oct 2014 << |             |      |      |             |      |      |            |      |      |            |      |      |
| Base Vol:                                   | 7           | 3    | 4    | 59          | 37   | 23   | 16         | 311  | 4    | 8          | 734  | 92   |
| Growth Adj:                                 | 1.00        | 1.00 | 1.00 | 1.00        | 1.00 | 1.00 | 1.00       | 1.00 | 1.00 | 1.00       | 1.00 | 1.00 |
| Initial Bse:                                | 7           | 3    | 4    | 59          | 37   | 23   | 16         | 311  | 4    | 8          | 734  | 92   |
| Added Vol:                                  | 0           | 0    | 0    | 0           | 0    | 0    | 0          | 0    | 0    | 0          | 0    | 0    |
| PasserByVol:                                | 0           | 0    | 0    | 0           | 0    | 0    | 0          | 0    | 0    | 0          | 0    | 0    |
| Initial Fut:                                | 7           | 3    | 4    | 59          | 37   | 23   | 16         | 311  | 4    | 8          | 734  | 92   |
| User Adj:                                   | 1.00        | 1.00 | 1.00 | 1.00        | 1.00 | 1.00 | 1.00       | 1.00 | 1.00 | 1.00       | 1.00 | 1.00 |
| PHF Adj:                                    | 1.00        | 1.00 | 1.00 | 1.00        | 1.00 | 1.00 | 1.00       | 1.00 | 1.00 | 1.00       | 1.00 | 1.00 |
| PHF Volume:                                 | 7           | 3    | 4    | 59          | 37   | 23   | 16         | 311  | 4    | 8          | 734  | 92   |
| Reduct Vol:                                 | 0           | 0    | 0    | 0           | 0    | 0    | 0          | 0    | 0    | 0          | 0    | 0    |
| Reduced Vol:                                | 7           | 3    | 4    | 59          | 37   | 23   | 16         | 311  | 4    | 8          | 734  | 92   |
| PCE Adj:                                    | 1.00        | 1.00 | 1.00 | 1.00        | 1.00 | 1.00 | 1.00       | 1.00 | 1.00 | 1.00       | 1.00 | 1.00 |
| MLF Adj:                                    | 1.00        | 1.00 | 1.00 | 1.00        | 1.00 | 1.00 | 1.00       | 1.00 | 1.00 | 1.00       | 1.00 | 1.00 |
| FinalVolume:                                | 7           | 3    | 4    | 59          | 37   | 23   | 16         | 311  | 4    | 8          | 734  | 92   |
| Saturation Flow Module:                     |             |      |      |             |      |      |            |      |      |            |      |      |
| Sat/Lane:                                   | 1900        | 1900 | 1900 | 1900        | 1900 | 1900 | 1900       | 1900 | 1900 | 1900       | 1900 | 1900 |
| Adjustment:                                 | 0.92        | 0.92 | 0.92 | 0.92        | 0.92 | 0.92 | 0.95       | 0.95 | 0.95 | 0.95       | 0.95 | 0.95 |
| Lanes:                                      | 0.50        | 0.21 | 0.29 | 0.50        | 0.31 | 0.19 | 0.10       | 1.88 | 0.02 | 0.02       | 1.76 | 0.22 |
| Final Sat.:                                 | 875         | 375  | 500  | 868         | 544  | 338  | 174        | 3382 | 44   | 35         | 3168 | 397  |
| Capacity Analysis Module:                   |             |      |      |             |      |      |            |      |      |            |      |      |
| Vol/Sat:                                    | 0.01        | 0.01 | 0.01 | 0.07        | 0.07 | 0.07 | 0.09       | 0.09 | 0.09 | 0.23       | 0.23 | 0.23 |
| Crit Moves:                                 | *****       |      |      |             |      |      |            |      |      |            |      |      |
| Green Time:                                 | 16.8        | 16.8 | 16.8 | 16.8        | 16.8 | 16.8 | 57.2       | 57.2 | 57.2 | 57.2       | 57.2 | 57.2 |
| Volume/Cap:                                 | 0.04        | 0.04 | 0.04 | 0.32        | 0.32 | 0.32 | 0.13       | 0.13 | 0.13 | 0.32       | 0.32 | 0.32 |
| Delay/Veh:                                  | 25.2        | 25.2 | 25.2 | 27.3        | 27.3 | 27.3 | 3.6        | 3.6  | 3.6  | 4.3        | 4.3  | 4.3  |
| User DelAdj:                                | 1.00        | 1.00 | 1.00 | 1.00        | 1.00 | 1.00 | 1.00       | 1.00 | 1.00 | 1.00       | 1.00 | 1.00 |
| AdjDel/Veh:                                 | 25.2        | 25.2 | 25.2 | 27.3        | 27.3 | 27.3 | 3.6        | 3.6  | 3.6  | 4.3        | 4.3  | 4.3  |
| LOS by Move:                                | C           | C    | C    | C           | C    | C    | A          | A    | A    | A          | A    | A    |
| HCM2k95thQ:                                 | 1           | 1    | 1    | 6           | 6    | 6    | 3          | 3    | 3    | 8          | 8    | 8    |

Note: Queue reported is the number of cars per lane.

BART

Level Of Service Computation Report  
2000 HCM Operations (Future Volume Alternative)  
PM - Existing Conditions

Intersection #3783: SANTA CLARA/17TH [Study Int 9]

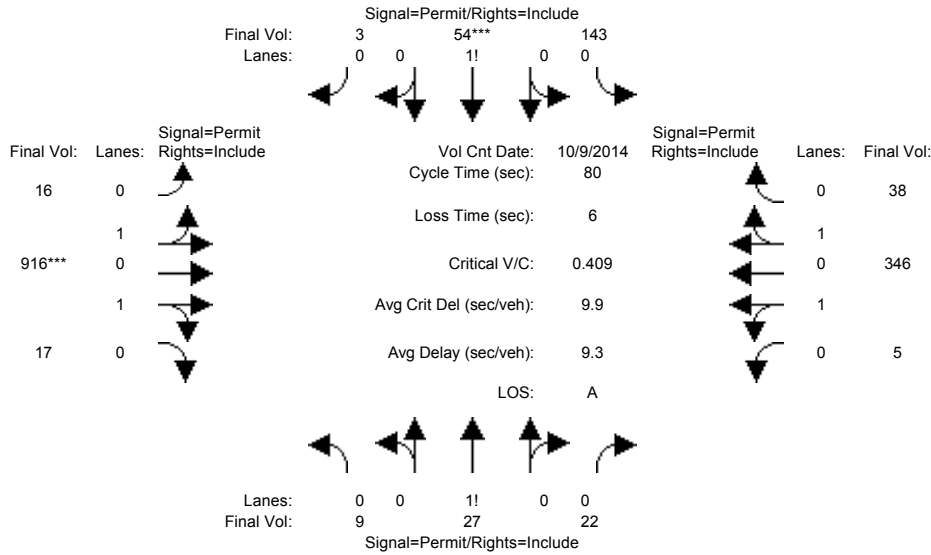

| Approach:                 | North Bound                  |      |      | South Bound |      |      | East Bound |      |      | West Bound |      |      |
|---------------------------|------------------------------|------|------|-------------|------|------|------------|------|------|------------|------|------|
| Movement:                 | L                            | T    | R    | L           | T    | R    | L          | T    | R    | L          | T    | R    |
| Min. Green:               | 10                           | 10   | 10   | 10          | 10   | 10   | 10         | 10   | 10   | 10         | 10   | 10   |
| Y+R:                      | 4.0                          | 4.0  | 4.0  | 4.0         | 4.0  | 4.0  | 4.0        | 4.0  | 4.0  | 4.0        | 4.0  | 4.0  |
| -----                     |                              |      |      |             |      |      |            |      |      |            |      |      |
| Volume Module:            | >> Count Date: 9 Oct 2014 << |      |      |             |      |      |            |      |      |            |      |      |
| Base Vol:                 | 9                            | 27   | 22   | 143         | 54   | 3    | 16         | 916  | 17   | 5          | 346  | 38   |
| Growth Adj:               | 1.00                         | 1.00 | 1.00 | 1.00        | 1.00 | 1.00 | 1.00       | 1.00 | 1.00 | 1.00       | 1.00 | 1.00 |
| Initial Bse:              | 9                            | 27   | 22   | 143         | 54   | 3    | 16         | 916  | 17   | 5          | 346  | 38   |
| Added Vol:                | 0                            | 0    | 0    | 0           | 0    | 0    | 0          | 0    | 0    | 0          | 0    | 0    |
| PasserByVol:              | 0                            | 0    | 0    | 0           | 0    | 0    | 0          | 0    | 0    | 0          | 0    | 0    |
| Initial Fut:              | 9                            | 27   | 22   | 143         | 54   | 3    | 16         | 916  | 17   | 5          | 346  | 38   |
| User Adj:                 | 1.00                         | 1.00 | 1.00 | 1.00        | 1.00 | 1.00 | 1.00       | 1.00 | 1.00 | 1.00       | 1.00 | 1.00 |
| PHF Adj:                  | 1.00                         | 1.00 | 1.00 | 1.00        | 1.00 | 1.00 | 1.00       | 1.00 | 1.00 | 1.00       | 1.00 | 1.00 |
| PHF Volume:               | 9                            | 27   | 22   | 143         | 54   | 3    | 16         | 916  | 17   | 5          | 346  | 38   |
| Reduct Vol:               | 0                            | 0    | 0    | 0           | 0    | 0    | 0          | 0    | 0    | 0          | 0    | 0    |
| Reduced Vol:              | 9                            | 27   | 22   | 143         | 54   | 3    | 16         | 916  | 17   | 5          | 346  | 38   |
| PCE Adj:                  | 1.00                         | 1.00 | 1.00 | 1.00        | 1.00 | 1.00 | 1.00       | 1.00 | 1.00 | 1.00       | 1.00 | 1.00 |
| MLF Adj:                  | 1.00                         | 1.00 | 1.00 | 1.00        | 1.00 | 1.00 | 1.00       | 1.00 | 1.00 | 1.00       | 1.00 | 1.00 |
| FinalVolume:              | 9                            | 27   | 22   | 143         | 54   | 3    | 16         | 916  | 17   | 5          | 346  | 38   |
| -----                     |                              |      |      |             |      |      |            |      |      |            |      |      |
| Saturation Flow Module:   |                              |      |      |             |      |      |            |      |      |            |      |      |
| Sat/Lane:                 | 1900                         | 1900 | 1900 | 1900        | 1900 | 1900 | 1900       | 1900 | 1900 | 1900       | 1900 | 1900 |
| Adjustment:               | 0.92                         | 0.92 | 0.92 | 0.92        | 0.92 | 0.92 | 0.95       | 0.95 | 0.95 | 0.95       | 0.95 | 0.95 |
| Lanes:                    | 0.15                         | 0.47 | 0.38 | 0.72        | 0.27 | 0.01 | 0.03       | 1.93 | 0.04 | 0.03       | 1.78 | 0.19 |
| Final Sat.:               | 272                          | 815  | 664  | 1251        | 473  | 26   | 61         | 3475 | 64   | 46         | 3202 | 352  |
| -----                     |                              |      |      |             |      |      |            |      |      |            |      |      |
| Capacity Analysis Module: |                              |      |      |             |      |      |            |      |      |            |      |      |
| Vol/Sat:                  | 0.03                         | 0.03 | 0.03 | 0.11        | 0.11 | 0.11 | 0.26       | 0.26 | 0.26 | 0.11       | 0.11 | 0.11 |
| Crit Moves:               | *****                        |      |      |             |      |      |            |      |      |            |      |      |
| Green Time:               | 22.4                         | 22.4 | 22.4 | 22.4        | 22.4 | 22.4 | 51.6       | 51.6 | 51.6 | 51.6       | 51.6 | 51.6 |
| Volume/Cap:               | 0.12                         | 0.12 | 0.12 | 0.41        | 0.41 | 0.41 | 0.41       | 0.41 | 0.41 | 0.17       | 0.17 | 0.17 |
| Delay/Veh:                | 21.6                         | 21.6 | 21.6 | 24.0        | 24.0 | 24.0 | 7.0        | 7.0  | 7.0  | 5.7        | 5.7  | 5.7  |
| User DelAdj:              | 1.00                         | 1.00 | 1.00 | 1.00        | 1.00 | 1.00 | 1.00       | 1.00 | 1.00 | 1.00       | 1.00 | 1.00 |
| AdjDel/Veh:               | 21.6                         | 21.6 | 21.6 | 24.0        | 24.0 | 24.0 | 7.0        | 7.0  | 7.0  | 5.7        | 5.7  | 5.7  |
| LOS by Move:              | C                            | C    | C    | C           | C    | C    | A          | A    | A    | A          | A    | A    |
| HCM2k95thQ:               | 2                            | 2    | 2    | 9           | 9    | 9    | 12         | 12   | 12   | 4          | 4    | 4    |

Note: Queue reported is the number of cars per lane.

BART

Level Of Service Computation Report  
 2000 HCM Operations (Future Volume Alternative)  
 AM - Existing Conditions

Intersection #3788: SANTA CLARA/28TH [Study Int 13]

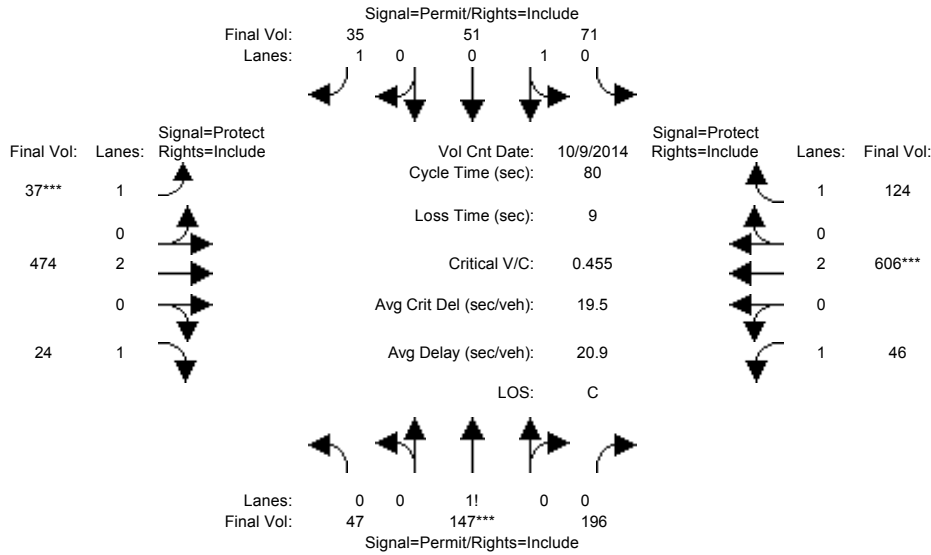

| Approach:                 | North Bound                  |      |      | South Bound |      |      | East Bound |      |      | West Bound |      |      |
|---------------------------|------------------------------|------|------|-------------|------|------|------------|------|------|------------|------|------|
| Movement:                 | L                            | T    | R    | L           | T    | R    | L          | T    | R    | L          | T    | R    |
| Min. Green:               | 10                           | 10   | 10   | 10          | 10   | 10   | 7          | 10   | 10   | 7          | 10   | 10   |
| Y+R:                      | 4.0                          | 4.0  | 4.0  | 4.0         | 4.0  | 4.0  | 4.0        | 4.0  | 4.0  | 4.0        | 4.0  | 4.0  |
| -----                     |                              |      |      |             |      |      |            |      |      |            |      |      |
| Volume Module:            | >> Count Date: 9 Oct 2014 << |      |      |             |      |      |            |      |      |            |      |      |
| Base Vol:                 | 47                           | 147  | 196  | 71          | 51   | 35   | 37         | 474  | 24   | 46         | 606  | 124  |
| Growth Adj:               | 1.00                         | 1.00 | 1.00 | 1.00        | 1.00 | 1.00 | 1.00       | 1.00 | 1.00 | 1.00       | 1.00 | 1.00 |
| Initial Bse:              | 47                           | 147  | 196  | 71          | 51   | 35   | 37         | 474  | 24   | 46         | 606  | 124  |
| Added Vol:                | 0                            | 0    | 0    | 0           | 0    | 0    | 0          | 0    | 0    | 0          | 0    | 0    |
| PasserByVol:              | 0                            | 0    | 0    | 0           | 0    | 0    | 0          | 0    | 0    | 0          | 0    | 0    |
| Initial Fut:              | 47                           | 147  | 196  | 71          | 51   | 35   | 37         | 474  | 24   | 46         | 606  | 124  |
| User Adj:                 | 1.00                         | 1.00 | 1.00 | 1.00        | 1.00 | 1.00 | 1.00       | 1.00 | 1.00 | 1.00       | 1.00 | 1.00 |
| PHF Adj:                  | 1.00                         | 1.00 | 1.00 | 1.00        | 1.00 | 1.00 | 1.00       | 1.00 | 1.00 | 1.00       | 1.00 | 1.00 |
| PHF Volume:               | 47                           | 147  | 196  | 71          | 51   | 35   | 37         | 474  | 24   | 46         | 606  | 124  |
| Reduct Vol:               | 0                            | 0    | 0    | 0           | 0    | 0    | 0          | 0    | 0    | 0          | 0    | 0    |
| Reduced Vol:              | 47                           | 147  | 196  | 71          | 51   | 35   | 37         | 474  | 24   | 46         | 606  | 124  |
| PCE Adj:                  | 1.00                         | 1.00 | 1.00 | 1.00        | 1.00 | 1.00 | 1.00       | 1.00 | 1.00 | 1.00       | 1.00 | 1.00 |
| MLF Adj:                  | 1.00                         | 1.00 | 1.00 | 1.00        | 1.00 | 1.00 | 1.00       | 1.00 | 1.00 | 1.00       | 1.00 | 1.00 |
| Final Volume:             | 47                           | 147  | 196  | 71          | 51   | 35   | 37         | 474  | 24   | 46         | 606  | 124  |
| -----                     |                              |      |      |             |      |      |            |      |      |            |      |      |
| Saturation Flow Module:   |                              |      |      |             |      |      |            |      |      |            |      |      |
| Sat/Lane:                 | 1900                         | 1900 | 1900 | 1900        | 1900 | 1900 | 1900       | 1900 | 1900 | 1900       | 1900 | 1900 |
| Adjustment:               | 0.92                         | 0.92 | 0.92 | 0.95        | 0.95 | 0.92 | 0.92       | 1.00 | 0.92 | 0.92       | 1.00 | 0.92 |
| Lanes:                    | 0.12                         | 0.38 | 0.50 | 0.58        | 0.42 | 1.00 | 1.00       | 2.00 | 1.00 | 1.00       | 2.00 | 1.00 |
| Final Sat.:               | 211                          | 660  | 879  | 1048        | 752  | 1750 | 1750       | 3800 | 1750 | 1750       | 3800 | 1750 |
| -----                     |                              |      |      |             |      |      |            |      |      |            |      |      |
| Capacity Analysis Module: |                              |      |      |             |      |      |            |      |      |            |      |      |
| Vol/Sat:                  | 0.22                         | 0.22 | 0.22 | 0.07        | 0.07 | 0.02 | 0.02       | 0.12 | 0.01 | 0.03       | 0.16 | 0.07 |
| Crit Moves:               | ****                         |      |      | ****        |      |      | ****       |      |      | ****       |      |      |
| Green Time:               | 37.3                         | 37.3 | 37.3 | 37.3        | 37.3 | 37.3 | 7.0        | 19.8 | 19.8 | 13.9       | 26.7 | 26.7 |
| Volume/Cap:               | 0.48                         | 0.48 | 0.48 | 0.15        | 0.15 | 0.04 | 0.24       | 0.50 | 0.06 | 0.15       | 0.48 | 0.21 |
| Delay/Veh:                | 15.1                         | 15.1 | 15.1 | 12.3        | 12.3 | 11.6 | 34.8       | 26.3 | 23.0 | 28.3       | 21.4 | 19.3 |
| User DelAdj:              | 1.00                         | 1.00 | 1.00 | 1.00        | 1.00 | 1.00 | 1.00       | 1.00 | 1.00 | 1.00       | 1.00 | 1.00 |
| AdjDel/Veh:               | 15.1                         | 15.1 | 15.1 | 12.3        | 12.3 | 11.6 | 34.8       | 26.3 | 23.0 | 28.3       | 21.4 | 19.3 |
| LOS by Move:              | B                            | B    | B    | B           | B    | B    | C          | C    | C    | C          | C    | B    |
| HCM2k95thQ:               | 13                           | 13   | 13   | 4           | 4    | 1    | 2          | 10   | 1    | 2          | 11   | 5    |

Note: Queue reported is the number of cars per lane.

BART

Level Of Service Computation Report  
 2000 HCM Operations (Future Volume Alternative)  
 PM - Existing Conditions

Intersection #3788: SANTA CLARA/28TH [Study Int 13]

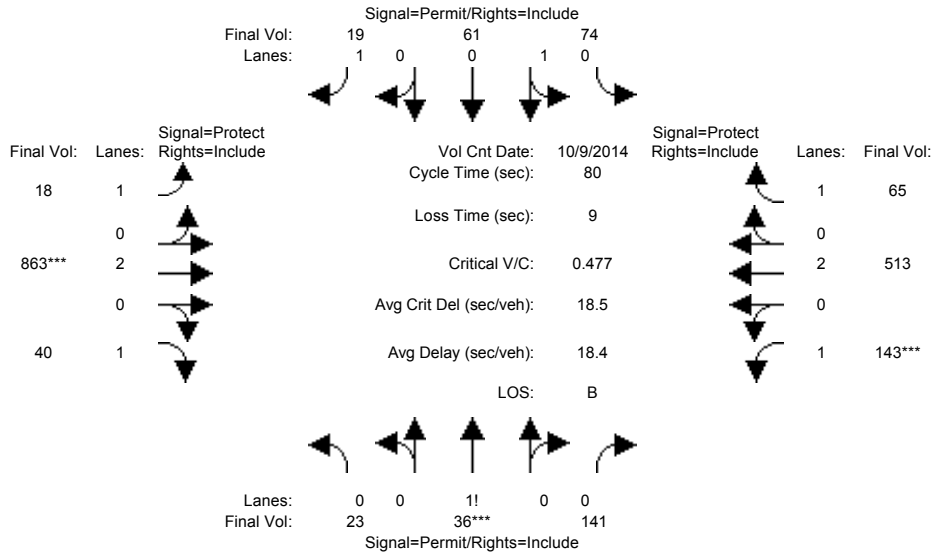

| Approach:                                   | North Bound |      |      | South Bound |      |      | East Bound |      |      | West Bound |      |      |
|---|-------------|------|------|-------------|------|------|------------|------|------|------------|------|------|
| Movement:                                   | L           | T    | R    | L           | T    | R    | L          | T    | R    | L          | T    | R    |
| Min. Green:                                 | 10          | 10   | 10   | 10          | 10   | 10   | 7          | 10   | 10   | 7          | 10   | 10   |
| Y+R:  | 4.0         | 4.0  | 4.0  | 4.0         | 4.0  | 4.0  | 4.0        | 4.0  | 4.0  | 4.0        | 4.0  | 4.0  |
| Volume Module: >> Count Date: 9 Oct 2014 << |             |      |      |             |      |      |            |      |      |            |      |      |
| Base Vol:                                   | 23          | 36   | 141  | 74          | 61   | 19   | 18         | 863  | 40   | 143        | 513  | 65   |
| Growth Adj:                                 | 1.00        | 1.00 | 1.00 | 1.00        | 1.00 | 1.00 | 1.00       | 1.00 | 1.00 | 1.00       | 1.00 | 1.00 |
| Initial Bse:                                | 23          | 36   | 141  | 74          | 61   | 19   | 18         | 863  | 40   | 143        | 513  | 65   |
| Added Vol:                                  | 0           | 0    | 0    | 0           | 0    | 0    | 0          | 0    | 0    | 0          | 0    | 0    |
| PasserByVol:                                | 0           | 0    | 0    | 0           | 0    | 0    | 0          | 0    | 0    | 0          | 0    | 0    |
| Initial Fut:                                | 23          | 36   | 141  | 74          | 61   | 19   | 18         | 863  | 40   | 143        | 513  | 65   |
| User Adj:                                   | 1.00        | 1.00 | 1.00 | 1.00        | 1.00 | 1.00 | 1.00       | 1.00 | 1.00 | 1.00       | 1.00 | 1.00 |
| PHF Adj:                                    | 1.00        | 1.00 | 1.00 | 1.00        | 1.00 | 1.00 | 1.00       | 1.00 | 1.00 | 1.00       | 1.00 | 1.00 |
| PHF Volume:                                 | 23          | 36   | 141  | 74          | 61   | 19   | 18         | 863  | 40   | 143        | 513  | 65   |
| Reduct Vol:                                 | 0           | 0    | 0    | 0           | 0    | 0    | 0          | 0    | 0    | 0          | 0    | 0    |
| Reduced Vol:                                | 23          | 36   | 141  | 74          | 61   | 19   | 18         | 863  | 40   | 143        | 513  | 65   |
| PCE Adj:                                    | 1.00        | 1.00 | 1.00 | 1.00        | 1.00 | 1.00 | 1.00       | 1.00 | 1.00 | 1.00       | 1.00 | 1.00 |
| MLF Adj:                                    | 1.00        | 1.00 | 1.00 | 1.00        | 1.00 | 1.00 | 1.00       | 1.00 | 1.00 | 1.00       | 1.00 | 1.00 |
| Final Volume:                               | 23          | 36   | 141  | 74          | 61   | 19   | 18         | 863  | 40   | 143        | 513  | 65   |
| Saturation Flow Module:                     |             |      |      |             |      |      |            |      |      |            |      |      |
| Sat/Lane:                                   | 1900        | 1900 | 1900 | 1900        | 1900 | 1900 | 1900       | 1900 | 1900 | 1900       | 1900 | 1900 |
| Adjustment:                                 | 0.92        | 0.92 | 0.92 | 0.95        | 0.95 | 0.92 | 0.92       | 1.00 | 0.92 | 0.92       | 1.00 | 0.92 |
| Lanes:                                      | 0.11        | 0.18 | 0.71 | 0.55        | 0.45 | 1.00 | 1.00       | 2.00 | 1.00 | 1.00       | 2.00 | 1.00 |
| Final Sat.:                                 | 201         | 315  | 1234 | 987         | 813  | 1750 | 1750       | 3800 | 1750 | 1750       | 3800 | 1750 |
| Capacity Analysis Module:                   |             |      |      |             |      |      |            |      |      |            |      |      |
| Vol/Sat:                                    | 0.11        | 0.11 | 0.11 | 0.08        | 0.08 | 0.01 | 0.01       | 0.23 | 0.02 | 0.08       | 0.14 | 0.04 |
| Crit Moves:                                 | ****        |      |      | ****        |      |      | ****       |      |      | ****       |      |      |
| Green Time:                                 | 19.2        | 19.2 | 19.2 | 19.2        | 19.2 | 19.2 | 20.4       | 38.1 | 38.1 | 13.7       | 31.4 | 31.4 |
| Volume/Cap:                                 | 0.48        | 0.48 | 0.48 | 0.31        | 0.31 | 0.05 | 0.04       | 0.48 | 0.05 | 0.48       | 0.34 | 0.09 |
| Delay/Veh:                                  | 27.0        | 27.0 | 27.0 | 25.4        | 25.4 | 23.4 | 22.5       | 14.4 | 11.2 | 31.1       | 17.2 | 15.4 |
| User DelAdj:                                | 1.00        | 1.00 | 1.00 | 1.00        | 1.00 | 1.00 | 1.00       | 1.00 | 1.00 | 1.00       | 1.00 | 1.00 |
| AdjDel/Veh:                                 | 27.0        | 27.0 | 27.0 | 25.4        | 25.4 | 23.4 | 22.5       | 14.4 | 11.2 | 31.1       | 17.2 | 15.4 |
| LOS by Move:                                | C           | C    | C    | C           | C    | C    | C          | B    | B    | C          | B    | B    |
| HCM2k95thQ:                                 | 9           | 9    | 9    | 6           | 6    | 1    | 1          | 13   | 1    | 7          | 8    | 2    |

Note: Queue reported is the number of cars per lane.

BART

Level Of Service Computation Report  
2000 HCM Operations (Future Volume Alternative)  
AM - Existing Conditions

Intersection #3789: SANTA CLARA/21ST [Study Int 10]

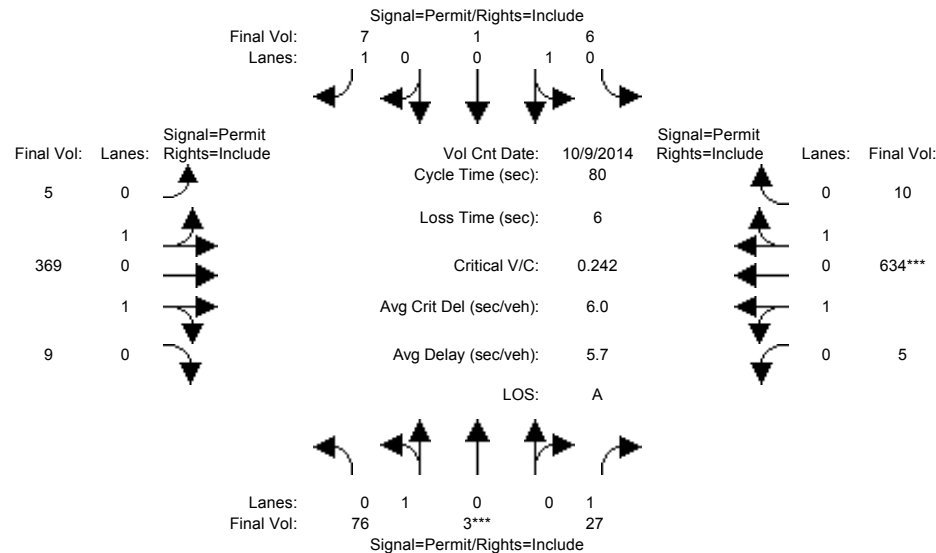

| Approach:                     | North Bound   |      |      | South Bound |      |      | East Bound |      |      | West Bound |      |      |
|-------------------------------|---------------|------|------|-------------|------|------|------------|------|------|------------|------|------|
| Movement:                     | L             | T    | R    | L           | T    | R    | L          | T    | R    | L          | T    | R    |
| Min. Green:                   | 10            | 10   | 10   | 10          | 10   | 10   | 10         | 10   | 10   | 10         | 10   | 10   |
| Y+R:                          | 4.0           | 4.0  | 4.0  | 4.0         | 4.0  | 4.0  | 4.0        | 4.0  | 4.0  | 4.0        | 4.0  | 4.0  |
| -----                         |               |      |      |             |      |      |            |      |      |            |      |      |
| Volume Module: >> Count Date: | 9 Oct 2014 << |      |      |             |      |      |            |      |      |            |      |      |
| Base Vol:                     | 76            | 3    | 27   | 6           | 1    | 7    | 5          | 369  | 9    | 5          | 634  | 10   |
| Growth Adj:                   | 1.00          | 1.00 | 1.00 | 1.00        | 1.00 | 1.00 | 1.00       | 1.00 | 1.00 | 1.00       | 1.00 | 1.00 |
| Initial Bse:                  | 76            | 3    | 27   | 6           | 1    | 7    | 5          | 369  | 9    | 5          | 634  | 10   |
| Added Vol:                    | 0             | 0    | 0    | 0           | 0    | 0    | 0          | 0    | 0    | 0          | 0    | 0    |
| PasserByVol:                  | 0             | 0    | 0    | 0           | 0    | 0    | 0          | 0    | 0    | 0          | 0    | 0    |
| Initial Fut:                  | 76            | 3    | 27   | 6           | 1    | 7    | 5          | 369  | 9    | 5          | 634  | 10   |
| User Adj:                     | 1.00          | 1.00 | 1.00 | 1.00        | 1.00 | 1.00 | 1.00       | 1.00 | 1.00 | 1.00       | 1.00 | 1.00 |
| PHF Adj:                      | 1.00          | 1.00 | 1.00 | 1.00        | 1.00 | 1.00 | 1.00       | 1.00 | 1.00 | 1.00       | 1.00 | 1.00 |
| PHF Volume:                   | 76            | 3    | 27   | 6           | 1    | 7    | 5          | 369  | 9    | 5          | 634  | 10   |
| Reduct Vol:                   | 0             | 0    | 0    | 0           | 0    | 0    | 0          | 0    | 0    | 0          | 0    | 0    |
| Reduced Vol:                  | 76            | 3    | 27   | 6           | 1    | 7    | 5          | 369  | 9    | 5          | 634  | 10   |
| PCE Adj:                      | 1.00          | 1.00 | 1.00 | 1.00        | 1.00 | 1.00 | 1.00       | 1.00 | 1.00 | 1.00       | 1.00 | 1.00 |
| MLF Adj:                      | 1.00          | 1.00 | 1.00 | 1.00        | 1.00 | 1.00 | 1.00       | 1.00 | 1.00 | 1.00       | 1.00 | 1.00 |
| Final Volume:                 | 76            | 3    | 27   | 6           | 1    | 7    | 5          | 369  | 9    | 5          | 634  | 10   |
| -----                         |               |      |      |             |      |      |            |      |      |            |      |      |
| Saturation Flow Module:       |               |      |      |             |      |      |            |      |      |            |      |      |
| Sat/Lane:                     | 1900          | 1900 | 1900 | 1900        | 1900 | 1900 | 1900       | 1900 | 1900 | 1900       | 1900 | 1900 |
| Adjustment:                   | 0.95          | 0.95 | 0.92 | 0.95        | 0.95 | 0.92 | 0.95       | 0.95 | 0.95 | 0.95       | 0.95 | 0.95 |
| Lanes:                        | 0.96          | 0.04 | 1.00 | 0.86        | 0.14 | 1.00 | 0.02       | 1.93 | 0.05 | 0.02       | 1.95 | 0.03 |
| Final Sat.:                   | 1732          | 68   | 1750 | 1543        | 257  | 1750 | 47         | 3468 | 85   | 28         | 3517 | 55   |
| -----                         |               |      |      |             |      |      |            |      |      |            |      |      |
| Capacity Analysis Module:     |               |      |      |             |      |      |            |      |      |            |      |      |
| Vol/Sat:                      | 0.04          | 0.04 | 0.02 | 0.00        | 0.00 | 0.00 | 0.11       | 0.11 | 0.11 | 0.18       | 0.18 | 0.18 |
| Crit Moves:                   | *****         |      |      |             |      |      |            |      |      |            |      |      |
| Green Time:                   | 14.5          | 14.5 | 14.5 | 14.5        | 14.5 | 14.5 | 59.5       | 59.5 | 59.5 | 59.5       | 59.5 | 59.5 |
| Volume/Cap:                   | 0.24          | 0.24 | 0.09 | 0.02        | 0.02 | 0.02 | 0.14       | 0.14 | 0.14 | 0.24       | 0.24 | 0.24 |
| Delay/Veh:                    | 28.4          | 28.4 | 27.4 | 27.0        | 27.0 | 27.0 | 3.0        | 3.0  | 3.0  | 3.2        | 3.2  | 3.2  |
| User DelAdj:                  | 1.00          | 1.00 | 1.00 | 1.00        | 1.00 | 1.00 | 1.00       | 1.00 | 1.00 | 1.00       | 1.00 | 1.00 |
| AdjDel/Veh:                   | 28.4          | 28.4 | 27.4 | 27.0        | 27.0 | 27.0 | 3.0        | 3.0  | 3.0  | 3.2        | 3.2  | 3.2  |
| LOS by Move:                  | C             | C    | C    | C           | C    | C    | A          | A    | A    | A          | A    | A    |
| HCM2k95thQ:                   | 4             | 4    | 1    | 0           | 0    | 0    | 3          | 3    | 3    | 5          | 5    | 5    |

Note: Queue reported is the number of cars per lane.



BART

Level Of Service Computation Report  
 2000 HCM Operations (Future Volume Alternative)  
 PM - Existing Conditions

Intersection #3789: SANTA CLARA/21ST [Study Int 10]

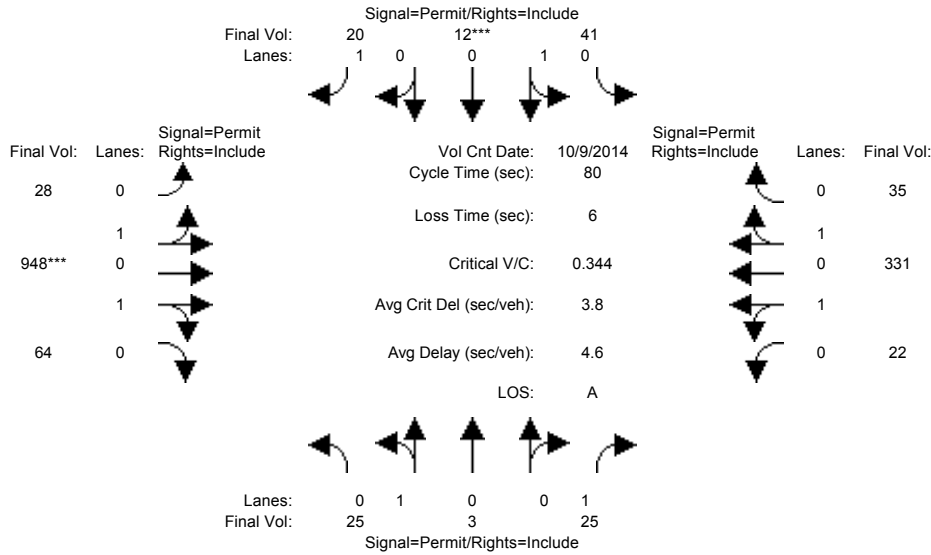

| Approach:                                   | North Bound |      |      | South Bound |      |      | East Bound |      |      | West Bound |      |      |
|---|-------------|------|------|-------------|------|------|------------|------|------|------------|------|------|
| Movement:                                   | L           | T    | R    | L           | T    | R    | L          | T    | R    | L          | T    | R    |
| Min. Green:                                 | 10          | 10   | 10   | 10          | 10   | 10   | 10         | 10   | 10   | 10         | 10   | 10   |
| Y+R:  | 4.0         | 4.0  | 4.0  | 4.0         | 4.0  | 4.0  | 4.0        | 4.0  | 4.0  | 4.0        | 4.0  | 4.0  |
| Volume Module: >> Count Date: 9 Oct 2014 << |             |      |      |             |      |      |            |      |      |            |      |      |
| Base Vol:                                   | 25          | 3    | 25   | 41          | 12   | 20   | 28         | 948  | 64   | 22         | 331  | 35   |
| Growth Adj:                                 | 1.00        | 1.00 | 1.00 | 1.00        | 1.00 | 1.00 | 1.00       | 1.00 | 1.00 | 1.00       | 1.00 | 1.00 |
| Initial Bse:                                | 25          | 3    | 25   | 41          | 12   | 20   | 28         | 948  | 64   | 22         | 331  | 35   |
| Added Vol:                                  | 0           | 0    | 0    | 0           | 0    | 0    | 0          | 0    | 0    | 0          | 0    | 0    |
| PasserByVol:                                | 0           | 0    | 0    | 0           | 0    | 0    | 0          | 0    | 0    | 0          | 0    | 0    |
| Initial Fut:                                | 25          | 3    | 25   | 41          | 12   | 20   | 28         | 948  | 64   | 22         | 331  | 35   |
| User Adj:                                   | 1.00        | 1.00 | 1.00 | 1.00        | 1.00 | 1.00 | 1.00       | 1.00 | 1.00 | 1.00       | 1.00 | 1.00 |
| PHF Adj:                                    | 1.00        | 1.00 | 1.00 | 1.00        | 1.00 | 1.00 | 1.00       | 1.00 | 1.00 | 1.00       | 1.00 | 1.00 |
| PHF Volume:                                 | 25          | 3    | 25   | 41          | 12   | 20   | 28         | 948  | 64   | 22         | 331  | 35   |
| Reduct Vol:                                 | 0           | 0    | 0    | 0           | 0    | 0    | 0          | 0    | 0    | 0          | 0    | 0    |
| Reduced Vol:                                | 25          | 3    | 25   | 41          | 12   | 20   | 28         | 948  | 64   | 22         | 331  | 35   |
| PCE Adj:                                    | 1.00        | 1.00 | 1.00 | 1.00        | 1.00 | 1.00 | 1.00       | 1.00 | 1.00 | 1.00       | 1.00 | 1.00 |
| MLF Adj:                                    | 1.00        | 1.00 | 1.00 | 1.00        | 1.00 | 1.00 | 1.00       | 1.00 | 1.00 | 1.00       | 1.00 | 1.00 |
| Final Volume:                               | 25          | 3    | 25   | 41          | 12   | 20   | 28         | 948  | 64   | 22         | 331  | 35   |
| Saturation Flow Module:                     |             |      |      |             |      |      |            |      |      |            |      |      |
| Sat/Lane:                                   | 1900        | 1900 | 1900 | 1900        | 1900 | 1900 | 1900       | 1900 | 1900 | 1900       | 1900 | 1900 |
| Adjustment:                                 | 0.95        | 0.95 | 0.92 | 0.95        | 0.95 | 0.92 | 0.95       | 0.95 | 0.95 | 0.95       | 0.95 | 0.95 |
| Lanes:                                      | 0.89        | 0.11 | 1.00 | 0.77        | 0.23 | 1.00 | 0.05       | 1.83 | 0.12 | 0.11       | 1.71 | 0.18 |
| Final Sat.:                                 | 1607        | 193  | 1750 | 1392        | 408  | 1750 | 97         | 3282 | 222  | 204        | 3071 | 325  |
| Capacity Analysis Module:                   |             |      |      |             |      |      |            |      |      |            |      |      |
| Vol/Sat:                                    | 0.02        | 0.02 | 0.01 | 0.03        | 0.03 | 0.01 | 0.29       | 0.29 | 0.29 | 0.11       | 0.11 | 0.11 |
| Crit Moves:                                 | *****       |      |      |             |      |      |            |      |      |            |      |      |
| Green Time:                                 | 10.0        | 10.0 | 10.0 | 10.0        | 10.0 | 10.0 | 64.0       | 64.0 | 64.0 | 64.0       | 64.0 | 64.0 |
| Volume/Cap:                                 | 0.12        | 0.12 | 0.11 | 0.24        | 0.24 | 0.09 | 0.36       | 0.36 | 0.36 | 0.13       | 0.13 | 0.13 |
| Delay/Veh:                                  | 31.4        | 31.4 | 31.3 | 32.1        | 32.1 | 31.2 | 2.3        | 2.3  | 2.3  | 1.8        | 1.8  | 1.8  |
| User DelAdj:                                | 1.00        | 1.00 | 1.00 | 1.00        | 1.00 | 1.00 | 1.00       | 1.00 | 1.00 | 1.00       | 1.00 | 1.00 |
| AdjDel/Veh:                                 | 31.4        | 31.4 | 31.3 | 32.1        | 32.1 | 31.2 | 2.3        | 2.3  | 2.3  | 1.8        | 1.8  | 1.8  |
| LOS by Move:                                | C           | C    | C    | C           | C    | C    | A          | A    | A    | A          | A    | A    |
| HCM2k95thQ:                                 | 2           | 2    | 1    | 3           | 3    | 1    | 8          | 8    | 8    | 2          | 2    | 2    |

Note: Queue reported is the number of cars per lane.

BART

Level Of Service Computation Report  
 2000 HCM Operations (Future Volume Alternative)  
 AM - Existing Conditions

Intersection #3790: SANTA CLARA/24TH [Study Int 11]

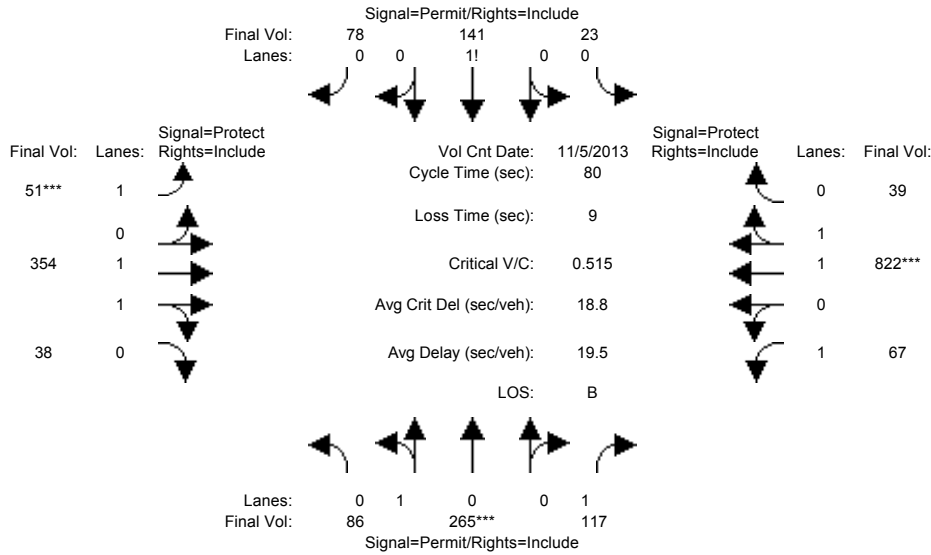

| Approach:                 | North Bound                  |      |      | South Bound |      |      | East Bound |      |      | West Bound |      |      |
|---------------------------|------------------------------|------|------|-------------|------|------|------------|------|------|------------|------|------|
| Movement:                 | L                            | T    | R    | L           | T    | R    | L          | T    | R    | L          | T    | R    |
| Min. Green:               | 10                           | 10   | 10   | 10          | 10   | 10   | 7          | 10   | 10   | 7          | 10   | 10   |
| Y+R:                      | 4.0                          | 4.0  | 4.0  | 4.0         | 4.0  | 4.0  | 4.0        | 4.0  | 4.0  | 4.0        | 4.0  | 4.0  |
| Volume Module:            | >> Count Date: 5 Nov 2013 << |      |      |             |      |      |            |      |      |            |      |      |
| Base Vol:                 | 86                           | 265  | 117  | 23          | 141  | 78   | 51         | 354  | 38   | 67         | 822  | 39   |
| Growth Adj:               | 1.00                         | 1.00 | 1.00 | 1.00        | 1.00 | 1.00 | 1.00       | 1.00 | 1.00 | 1.00       | 1.00 | 1.00 |
| Initial Bse:              | 86                           | 265  | 117  | 23          | 141  | 78   | 51         | 354  | 38   | 67         | 822  | 39   |
| Added Vol:                | 0                            | 0    | 0    | 0           | 0    | 0    | 0          | 0    | 0    | 0          | 0    | 0    |
| PasserByVol:              | 0                            | 0    | 0    | 0           | 0    | 0    | 0          | 0    | 0    | 0          | 0    | 0    |
| Initial Fut:              | 86                           | 265  | 117  | 23          | 141  | 78   | 51         | 354  | 38   | 67         | 822  | 39   |
| User Adj:                 | 1.00                         | 1.00 | 1.00 | 1.00        | 1.00 | 1.00 | 1.00       | 1.00 | 1.00 | 1.00       | 1.00 | 1.00 |
| PHF Adj:                  | 1.00                         | 1.00 | 1.00 | 1.00        | 1.00 | 1.00 | 1.00       | 1.00 | 1.00 | 1.00       | 1.00 | 1.00 |
| PHF Volume:               | 86                           | 265  | 117  | 23          | 141  | 78   | 51         | 354  | 38   | 67         | 822  | 39   |
| Reduct Vol:               | 0                            | 0    | 0    | 0           | 0    | 0    | 0          | 0    | 0    | 0          | 0    | 0    |
| Reduced Vol:              | 86                           | 265  | 117  | 23          | 141  | 78   | 51         | 354  | 38   | 67         | 822  | 39   |
| PCE Adj:                  | 1.00                         | 1.00 | 1.00 | 1.00        | 1.00 | 1.00 | 1.00       | 1.00 | 1.00 | 1.00       | 1.00 | 1.00 |
| MLF Adj:                  | 1.00                         | 1.00 | 1.00 | 1.00        | 1.00 | 1.00 | 1.00       | 1.00 | 1.00 | 1.00       | 1.00 | 1.00 |
| Final Volume:             | 86                           | 265  | 117  | 23          | 141  | 78   | 51         | 354  | 38   | 67         | 822  | 39   |
| Saturation Flow Module:   |                              |      |      |             |      |      |            |      |      |            |      |      |
| Sat/Lane:                 | 1900                         | 1900 | 1900 | 1900        | 1900 | 1900 | 1900       | 1900 | 1900 | 1900       | 1900 | 1900 |
| Adjustment:               | 0.95                         | 0.95 | 0.92 | 0.92        | 0.92 | 0.92 | 0.92       | 0.98 | 0.95 | 0.92       | 0.97 | 0.95 |
| Lanes:                    | 0.25                         | 0.75 | 1.00 | 0.10        | 0.58 | 0.32 | 1.00       | 1.80 | 0.20 | 1.00       | 1.91 | 0.09 |
| Final Sat.:               | 441                          | 1359 | 1750 | 166         | 1020 | 564  | 1750       | 3341 | 359  | 1750       | 3532 | 168  |
| Capacity Analysis Module: |                              |      |      |             |      |      |            |      |      |            |      |      |
| Vol/Sat:                  | 0.20                         | 0.20 | 0.07 | 0.14        | 0.14 | 0.14 | 0.03       | 0.11 | 0.11 | 0.04       | 0.23 | 0.23 |
| Crit Moves:               | ****                         |      |      | ****        |      |      | ****       |      |      | ****       |      |      |
| Green Time:               | 29.2                         | 29.2 | 29.2 | 29.2        | 29.2 | 29.2 | 7.0        | 24.6 | 24.6 | 17.2       | 34.8 | 34.8 |
| Volume/Cap:               | 0.53                         | 0.53 | 0.18 | 0.38        | 0.38 | 0.38 | 0.33       | 0.34 | 0.34 | 0.18       | 0.53 | 0.53 |
| Delay/Veh:                | 20.9                         | 20.9 | 17.4 | 19.1        | 19.1 | 19.1 | 35.6       | 21.6 | 21.6 | 25.8       | 17.0 | 17.0 |
| User DelAdj:              | 1.00                         | 1.00 | 1.00 | 1.00        | 1.00 | 1.00 | 1.00       | 1.00 | 1.00 | 1.00       | 1.00 | 1.00 |
| AdjDel/Veh:               | 20.9                         | 20.9 | 17.4 | 19.1        | 19.1 | 19.1 | 35.6       | 21.6 | 21.6 | 25.8       | 17.0 | 17.0 |
| LOS by Move:              | C                            | C    | B    | B           | B    | B    | D          | C    | C    | C          | B    | B    |
| HCM2k95thQ:               | 13                           | 13   | 4    | 10          | 10   | 10   | 3          | 7    | 7    | 3          | 15   | 15   |

Note: Queue reported is the number of cars per lane.

BART

Level Of Service Computation Report  
2000 HCM Operations (Future Volume Alternative)  
PM - Existing Conditions

Intersection #3790: SANTA CLARA/24TH [Study Int 11]

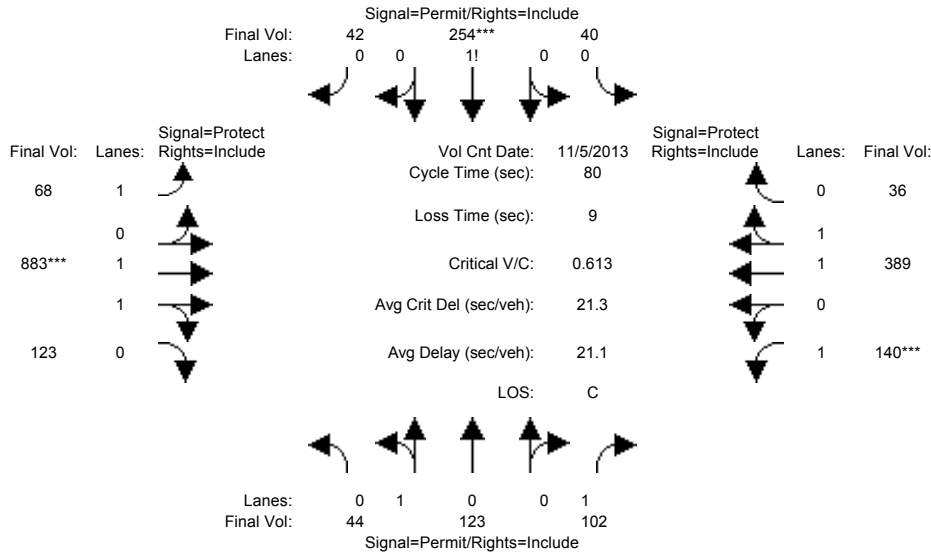

| Approach:                                   | North Bound |      |      | South Bound |      |      | East Bound |      |      | West Bound |      |      |
|---|-------------|------|------|-------------|------|------|------------|------|------|------------|------|------|
| Movement:                                   | L           | T    | R    | L           | T    | R    | L          | T    | R    | L          | T    | R    |
| Min. Green:                                 | 10          | 10   | 10   | 10          | 10   | 10   | 7          | 10   | 10   | 7          | 10   | 10   |
| Y+R:  | 4.0         | 4.0  | 4.0  | 4.0         | 4.0  | 4.0  | 4.0        | 4.0  | 4.0  | 4.0        | 4.0  | 4.0  |
| Volume Module: >> Count Date: 5 Nov 2013 << |             |      |      |             |      |      |            |      |      |            |      |      |
| Base Vol:                                   | 44          | 123  | 102  | 40          | 254  | 42   | 68         | 883  | 123  | 140        | 389  | 36   |
| Growth Adj:                                 | 1.00        | 1.00 | 1.00 | 1.00        | 1.00 | 1.00 | 1.00       | 1.00 | 1.00 | 1.00       | 1.00 | 1.00 |
| Initial Bse:                                | 44          | 123  | 102  | 40          | 254  | 42   | 68         | 883  | 123  | 140        | 389  | 36   |
| Added Vol:                                  | 0           | 0    | 0    | 0           | 0    | 0    | 0          | 0    | 0    | 0          | 0    | 0    |
| PasserByVol:                                | 0           | 0    | 0    | 0           | 0    | 0    | 0          | 0    | 0    | 0          | 0    | 0    |
| Initial Fut:                                | 44          | 123  | 102  | 40          | 254  | 42   | 68         | 883  | 123  | 140        | 389  | 36   |
| User Adj:                                   | 1.00        | 1.00 | 1.00 | 1.00        | 1.00 | 1.00 | 1.00       | 1.00 | 1.00 | 1.00       | 1.00 | 1.00 |
| PHF Adj:                                    | 1.00        | 1.00 | 1.00 | 1.00        | 1.00 | 1.00 | 1.00       | 1.00 | 1.00 | 1.00       | 1.00 | 1.00 |
| PHF Volume:                                 | 44          | 123  | 102  | 40          | 254  | 42   | 68         | 883  | 123  | 140        | 389  | 36   |
| Reduct Vol:                                 | 0           | 0    | 0    | 0           | 0    | 0    | 0          | 0    | 0    | 0          | 0    | 0    |
| Reduced Vol:                                | 44          | 123  | 102  | 40          | 254  | 42   | 68         | 883  | 123  | 140        | 389  | 36   |
| PCE Adj:                                    | 1.00        | 1.00 | 1.00 | 1.00        | 1.00 | 1.00 | 1.00       | 1.00 | 1.00 | 1.00       | 1.00 | 1.00 |
| MLF Adj:                                    | 1.00        | 1.00 | 1.00 | 1.00        | 1.00 | 1.00 | 1.00       | 1.00 | 1.00 | 1.00       | 1.00 | 1.00 |
| Final Volume:                               | 44          | 123  | 102  | 40          | 254  | 42   | 68         | 883  | 123  | 140        | 389  | 36   |
| Saturation Flow Module:                     |             |      |      |             |      |      |            |      |      |            |      |      |
| Sat/Lane:                                   | 1900        | 1900 | 1900 | 1900        | 1900 | 1900 | 1900       | 1900 | 1900 | 1900       | 1900 | 1900 |
| Adjustment:                                 | 0.95        | 0.95 | 0.92 | 0.92        | 0.92 | 0.92 | 0.92       | 0.98 | 0.95 | 0.92       | 0.98 | 0.95 |
| Lanes:                                      | 0.26        | 0.74 | 1.00 | 0.12        | 0.76 | 0.12 | 1.00       | 1.75 | 0.25 | 1.00       | 1.83 | 0.17 |
| Final Sat.:                                 | 474         | 1326 | 1750 | 208         | 1323 | 219  | 1750       | 3247 | 452  | 1750       | 3386 | 313  |
| Capacity Analysis Module:                   |             |      |      |             |      |      |            |      |      |            |      |      |
| Vol/Sat:                                    | 0.09        | 0.09 | 0.06 | 0.19        | 0.19 | 0.19 | 0.04       | 0.27 | 0.27 | 0.08       | 0.11 | 0.11 |
| Crit Moves:                                 | ****        |      |      | ****        |      |      | ****       |      |      | ****       |      |      |
| Green Time:                                 | 25.1        | 25.1 | 25.1 | 25.1        | 25.1 | 25.1 | 18.9       | 35.5 | 35.5 | 10.4       | 27.0 | 27.0 |
| Volume/Cap:                                 | 0.30        | 0.30 | 0.19 | 0.61        | 0.61 | 0.61 | 0.16       | 0.61 | 0.61 | 0.61       | 0.34 | 0.34 |
| Delay/Veh:                                  | 21.1        | 21.1 | 20.2 | 25.4        | 25.4 | 25.4 | 24.5       | 17.7 | 17.7 | 37.7       | 20.0 | 20.0 |
| User DelAdj:                                | 1.00        | 1.00 | 1.00 | 1.00        | 1.00 | 1.00 | 1.00       | 1.00 | 1.00 | 1.00       | 1.00 | 1.00 |
| AdjDel/Veh:                                 | 21.1        | 21.1 | 20.2 | 25.4        | 25.4 | 25.4 | 24.5       | 17.7 | 17.7 | 37.7       | 20.0 | 20.0 |
| LOS by Move:                                | C           | C    | C    | C           | C    | C    | C          | B    | B    | D          | B    | B    |
| HCM2k95thQ:                                 | 6           | 6    | 4    | 16          | 16   | 16   | 3          | 18   | 18   | 7          | 8    | 8    |

Note: Queue reported is the number of cars per lane.

BART

Level Of Service Computation Report  
2000 HCM Operations (Future Volume Alternative)  
AM - Existing Conditions

Intersection #3832: 24TH/WILLIAM [Study Int 24]

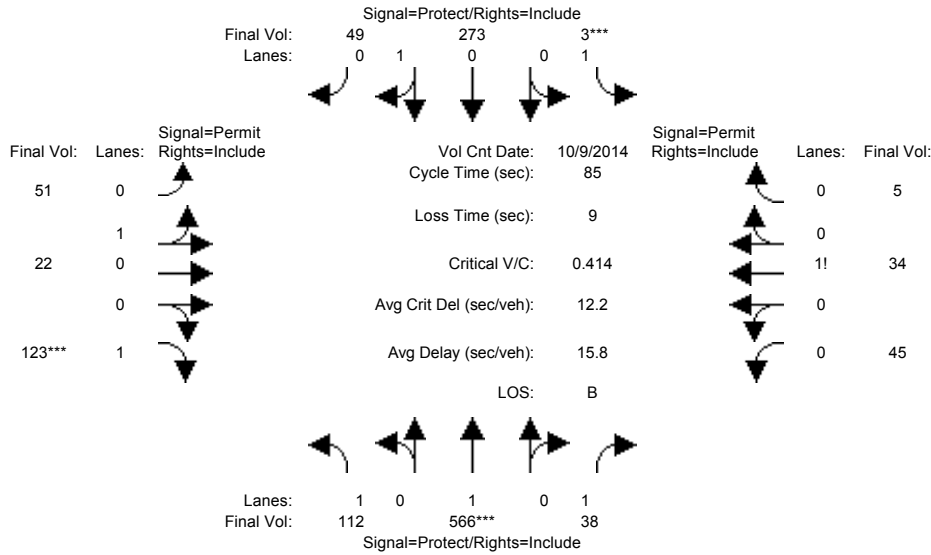

| Approach:                                   | North Bound |      |      | South Bound |      |      | East Bound |      |      | West Bound |      |      |
|---|-------------|------|------|-------------|------|------|------------|------|------|------------|------|------|
| Movement:                                   | L           | T    | R    | L           | T    | R    | L          | T    | R    | L          | T    | R    |
| Min. Green:                                 | 7           | 10   | 10   | 7           | 10   | 10   | 10         | 10   | 10   | 10         | 10   | 10   |
| Y+R:  | 4.0         | 4.0  | 4.0  | 4.0         | 4.0  | 4.0  | 4.0        | 4.0  | 4.0  | 4.0        | 4.0  | 4.0  |
| Volume Module: >> Count Date: 9 Oct 2014 << |             |      |      |             |      |      |            |      |      |            |      |      |
| Base Vol:                                   | 112         | 566  | 38   | 3           | 273  | 49   | 51         | 22   | 123  | 45         | 34   | 5    |
| Growth Adj:                                 | 1.00        | 1.00 | 1.00 | 1.00        | 1.00 | 1.00 | 1.00       | 1.00 | 1.00 | 1.00       | 1.00 | 1.00 |
| Initial Bse:                                | 112         | 566  | 38   | 3           | 273  | 49   | 51         | 22   | 123  | 45         | 34   | 5    |
| Added Vol:                                  | 0           | 0    | 0    | 0           | 0    | 0    | 0          | 0    | 0    | 0          | 0    | 0    |
| PasserByVol:                                | 0           | 0    | 0    | 0           | 0    | 0    | 0          | 0    | 0    | 0          | 0    | 0    |
| Initial Fut:                                | 112         | 566  | 38   | 3           | 273  | 49   | 51         | 22   | 123  | 45         | 34   | 5    |
| User Adj:                                   | 1.00        | 1.00 | 1.00 | 1.00        | 1.00 | 1.00 | 1.00       | 1.00 | 1.00 | 1.00       | 1.00 | 1.00 |
| PHF Adj:                                    | 1.00        | 1.00 | 1.00 | 1.00        | 1.00 | 1.00 | 1.00       | 1.00 | 1.00 | 1.00       | 1.00 | 1.00 |
| PHF Volume:                                 | 112         | 566  | 38   | 3           | 273  | 49   | 51         | 22   | 123  | 45         | 34   | 5    |
| Reduct Vol:                                 | 0           | 0    | 0    | 0           | 0    | 0    | 0          | 0    | 0    | 0          | 0    | 0    |
| Reduced Vol:                                | 112         | 566  | 38   | 3           | 273  | 49   | 51         | 22   | 123  | 45         | 34   | 5    |
| PCE Adj:                                    | 1.00        | 1.00 | 1.00 | 1.00        | 1.00 | 1.00 | 1.00       | 1.00 | 1.00 | 1.00       | 1.00 | 1.00 |
| MLF Adj:                                    | 1.00        | 1.00 | 1.00 | 1.00        | 1.00 | 1.00 | 1.00       | 1.00 | 1.00 | 1.00       | 1.00 | 1.00 |
| Final Volume:                               | 112         | 566  | 38   | 3           | 273  | 49   | 51         | 22   | 123  | 45         | 34   | 5    |
| Saturation Flow Module:                     |             |      |      |             |      |      |            |      |      |            |      |      |
| Sat/Lane:                                   | 1900        | 1900 | 1900 | 1900        | 1900 | 1900 | 1900       | 1900 | 1900 | 1900       | 1900 | 1900 |
| Adjustment:                                 | 0.92        | 1.00 | 0.92 | 0.92        | 0.95 | 0.95 | 0.95       | 0.95 | 0.92 | 0.92       | 0.92 | 0.92 |
| Lanes:                                      | 1.00        | 1.00 | 1.00 | 1.00        | 0.85 | 0.15 | 0.70       | 0.30 | 1.00 | 0.54       | 0.40 | 0.06 |
| Final Sat.:                                 | 1750        | 1900 | 1750 | 1750        | 1526 | 274  | 1258       | 542  | 1750 | 938        | 708  | 104  |
| Capacity Analysis Module:                   |             |      |      |             |      |      |            |      |      |            |      |      |
| Vol/Sat:                                    | 0.06        | 0.30 | 0.02 | 0.00        | 0.18 | 0.18 | 0.04       | 0.04 | 0.07 | 0.05       | 0.05 | 0.05 |
| Crit Moves:                                 | ****        | **** | **** | ****        | **** | **** | ****       | **** | **** | ****       | **** | **** |
| Green Time:                                 | 19.8        | 55.8 | 55.8 | 7.0         | 43.0 | 43.0 | 13.2       | 13.2 | 13.2 | 13.2       | 13.2 | 13.2 |
| Volume/Cap:                                 | 0.27        | 0.45 | 0.03 | 0.02        | 0.35 | 0.35 | 0.26       | 0.26 | 0.45 | 0.31       | 0.31 | 0.31 |
| Delay/Veh:                                  | 27.1        | 7.4  | 5.1  | 35.9        | 12.9 | 12.9 | 32.1       | 32.1 | 33.8 | 32.5       | 32.5 | 32.5 |
| User DelAdj:                                | 1.00        | 1.00 | 1.00 | 1.00        | 1.00 | 1.00 | 1.00       | 1.00 | 1.00 | 1.00       | 1.00 | 1.00 |
| AdjDel/Veh:                                 | 27.1        | 7.4  | 5.1  | 35.9        | 12.9 | 12.9 | 32.1       | 32.1 | 33.8 | 32.5       | 32.5 | 32.5 |
| LOS by Move:                                | C           | A    | A    | D           | B    | B    | C          | C    | C    | C          | C    | C    |
| HCM2k95thQ:                                 | 5           | 14   | 1    | 0           | 10   | 10   | 4          | 4    | 7    | 5          | 5    | 5    |

Note: Queue reported is the number of cars per lane.

BART

Level Of Service Computation Report  
 2000 HCM Operations (Future Volume Alternative)  
 PM - Existing Conditions

Intersection #3832: 24TH/WILLIAM [Study Int 24]

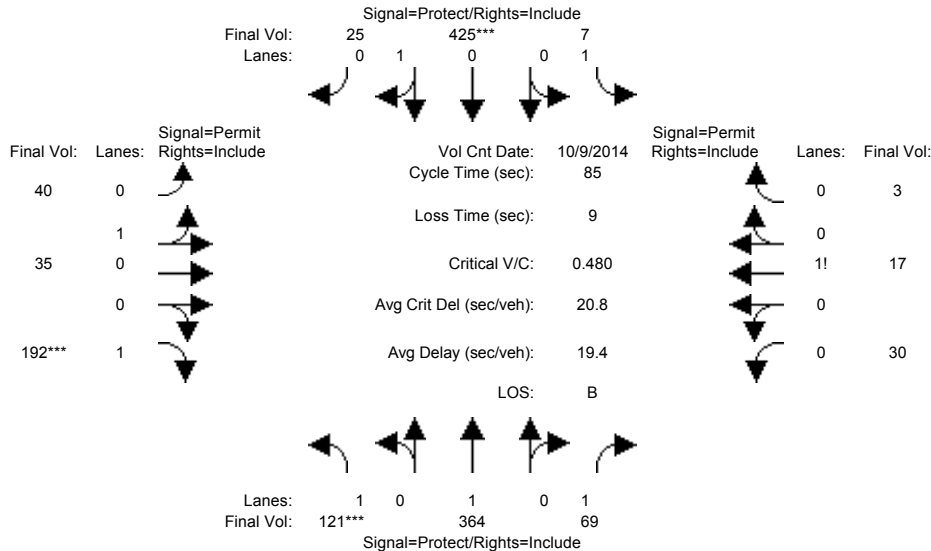

| Approach:                                   | North Bound |      |      | South Bound |      |      | East Bound |      |      | West Bound |      |      |
|---|-------------|------|------|-------------|------|------|------------|------|------|------------|------|------|
| Movement:                                   | L           | T    | R    | L           | T    | R    | L          | T    | R    | L          | T    | R    |
| Min. Green:                                 | 7           | 10   | 10   | 7           | 10   | 10   | 10         | 10   | 10   | 10         | 10   | 10   |
| Y+R:  | 4.0         | 4.0  | 4.0  | 4.0         | 4.0  | 4.0  | 4.0        | 4.0  | 4.0  | 4.0        | 4.0  | 4.0  |
| Volume Module: >> Count Date: 9 Oct 2014 << |             |      |      |             |      |      |            |      |      |            |      |      |
| Base Vol:                                   | 121         | 364  | 69   | 7           | 425  | 25   | 40         | 35   | 192  | 30         | 17   | 3    |
| Growth Adj:                                 | 1.00        | 1.00 | 1.00 | 1.00        | 1.00 | 1.00 | 1.00       | 1.00 | 1.00 | 1.00       | 1.00 | 1.00 |
| Initial Bse:                                | 121         | 364  | 69   | 7           | 425  | 25   | 40         | 35   | 192  | 30         | 17   | 3    |
| Added Vol:                                  | 0           | 0    | 0    | 0           | 0    | 0    | 0          | 0    | 0    | 0          | 0    | 0    |
| PasserByVol:                                | 0           | 0    | 0    | 0           | 0    | 0    | 0          | 0    | 0    | 0          | 0    | 0    |
| Initial Fut:                                | 121         | 364  | 69   | 7           | 425  | 25   | 40         | 35   | 192  | 30         | 17   | 3    |
| User Adj:                                   | 1.00        | 1.00 | 1.00 | 1.00        | 1.00 | 1.00 | 1.00       | 1.00 | 1.00 | 1.00       | 1.00 | 1.00 |
| PHF Adj:                                    | 1.00        | 1.00 | 1.00 | 1.00        | 1.00 | 1.00 | 1.00       | 1.00 | 1.00 | 1.00       | 1.00 | 1.00 |
| PHF Volume:                                 | 121         | 364  | 69   | 7           | 425  | 25   | 40         | 35   | 192  | 30         | 17   | 3    |
| Reduct Vol:                                 | 0           | 0    | 0    | 0           | 0    | 0    | 0          | 0    | 0    | 0          | 0    | 0    |
| Reduced Vol:                                | 121         | 364  | 69   | 7           | 425  | 25   | 40         | 35   | 192  | 30         | 17   | 3    |
| PCE Adj:                                    | 1.00        | 1.00 | 1.00 | 1.00        | 1.00 | 1.00 | 1.00       | 1.00 | 1.00 | 1.00       | 1.00 | 1.00 |
| MLF Adj:                                    | 1.00        | 1.00 | 1.00 | 1.00        | 1.00 | 1.00 | 1.00       | 1.00 | 1.00 | 1.00       | 1.00 | 1.00 |
| Final Volume:                               | 121         | 364  | 69   | 7           | 425  | 25   | 40         | 35   | 192  | 30         | 17   | 3    |
| Saturation Flow Module:                     |             |      |      |             |      |      |            |      |      |            |      |      |
| Sat/Lane:                                   | 1900        | 1900 | 1900 | 1900        | 1900 | 1900 | 1900       | 1900 | 1900 | 1900       | 1900 | 1900 |
| Adjustment:                                 | 0.92        | 1.00 | 0.92 | 0.92        | 0.95 | 0.95 | 0.95       | 0.95 | 0.92 | 0.92       | 0.92 | 0.92 |
| Lanes:                                      | 1.00        | 1.00 | 1.00 | 1.00        | 0.94 | 0.06 | 0.53       | 0.47 | 1.00 | 0.60       | 0.34 | 0.06 |
| Final Sat.:                                 | 1750        | 1900 | 1750 | 1750        | 1700 | 100  | 960        | 840  | 1750 | 1050       | 595  | 105  |
| Capacity Analysis Module:                   |             |      |      |             |      |      |            |      |      |            |      |      |
| Vol/Sat:                                    | 0.07        | 0.19 | 0.04 | 0.00        | 0.25 | 0.25 | 0.04       | 0.04 | 0.11 | 0.03       | 0.03 | 0.03 |
| Crit Moves:                                 | ****        |      |      | ****        |      |      | ****       |      | **** | ****       |      |      |
| Green Time:                                 | 12.3        | 39.6 | 39.6 | 17.0        | 44.3 | 44.3 | 19.4       | 19.4 | 19.4 | 19.4       | 19.4 | 19.4 |
| Volume/Cap:                                 | 0.48        | 0.41 | 0.08 | 0.02        | 0.48 | 0.48 | 0.18       | 0.18 | 0.48 | 0.12       | 0.12 | 0.12 |
| Delay/Veh:                                  | 34.9        | 15.3 | 12.7 | 27.3        | 13.4 | 13.4 | 26.6       | 26.6 | 29.3 | 26.2       | 26.2 | 26.2 |
| User DelAdj:                                | 1.00        | 1.00 | 1.00 | 1.00        | 1.00 | 1.00 | 1.00       | 1.00 | 1.00 | 1.00       | 1.00 | 1.00 |
| AdjDel/Veh:                                 | 34.9        | 15.3 | 12.7 | 27.3        | 13.4 | 13.4 | 26.6       | 26.6 | 29.3 | 26.2       | 26.2 | 26.2 |
| LOS by Move:                                | C           | B    | B    | C           | B    | B    | C          | C    | C    | C          | C    | C    |
| HCM2k95thQ:                                 | 6           | 12   | 2    | 0           | 15   | 15   | 4          | 4    | 10   | 2          | 2    | 2    |

Note: Queue reported is the number of cars per lane.

BART

Level Of Service Computation Report  
2000 HCM Operations (Future Volume Alternative)  
AM - Existing Conditions

Intersection #4005: JULIAN/28TH [Study Int 3]

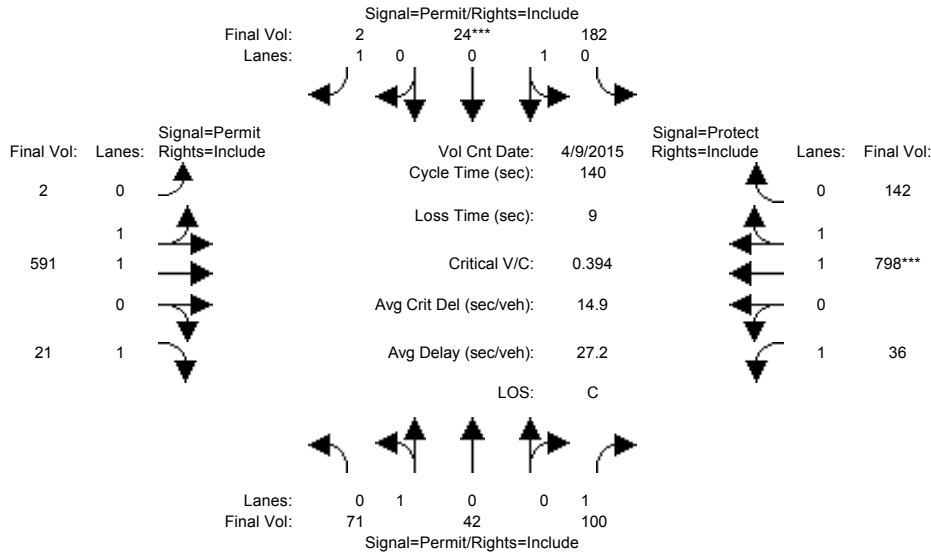

| Approach:                                   | North Bound |      |      | South Bound |      |      | East Bound |      |      | West Bound |      |       |
|---|-------------|------|------|-------------|------|------|------------|------|------|------------|------|-------|
| Movement:                                   | L           | T    | R    | L           | T    | R    | L          | T    | R    | L          | T    | R     |
| Min. Green:                                 | 10          | 10   | 10   | 10          | 10   | 10   | 10         | 10   | 10   | 7          | 10   | 10    |
| Y+R:  | 4.0         | 4.0  | 4.0  | 4.0         | 4.0  | 4.0  | 4.0        | 4.0  | 4.0  | 4.0        | 4.0  | 4.0   |
| -----                                       |             |      |      |             |      |      |            |      |      |            |      |       |
| Volume Module: >> Count Date: 9 Apr 2015 << |             |      |      |             |      |      |            |      |      |            |      |       |
| Base Vol:                                   | 71          | 42   | 100  | 182         | 24   | 2    | 2          | 591  | 21   | 36         | 798  | 142   |
| Growth Adj:                                 | 1.00        | 1.00 | 1.00 | 1.00        | 1.00 | 1.00 | 1.00       | 1.00 | 1.00 | 1.00       | 1.00 | 1.00  |
| Initial Bse:                                | 71          | 42   | 100  | 182         | 24   | 2    | 2          | 591  | 21   | 36         | 798  | 142   |
| Added Vol:                                  | 0           | 0    | 0    | 0           | 0    | 0    | 0          | 0    | 0    | 0          | 0    | 0     |
| PasserByVol:                                | 0           | 0    | 0    | 0           | 0    | 0    | 0          | 0    | 0    | 0          | 0    | 0     |
| Initial Fut:                                | 71          | 42   | 100  | 182         | 24   | 2    | 2          | 591  | 21   | 36         | 798  | 142   |
| User Adj:                                   | 1.00        | 1.00 | 1.00 | 1.00        | 1.00 | 1.00 | 1.00       | 1.00 | 1.00 | 1.00       | 1.00 | 1.00  |
| PHF Adj:                                    | 1.00        | 1.00 | 1.00 | 1.00        | 1.00 | 1.00 | 1.00       | 1.00 | 1.00 | 1.00       | 1.00 | 1.00  |
| PHF Volume:                                 | 71          | 42   | 100  | 182         | 24   | 2    | 2          | 591  | 21   | 36         | 798  | 142   |
| Reduct Vol:                                 | 0           | 0    | 0    | 0           | 0    | 0    | 0          | 0    | 0    | 0          | 0    | 0     |
| Reduced Vol:                                | 71          | 42   | 100  | 182         | 24   | 2    | 2          | 591  | 21   | 36         | 798  | 142   |
| PCE Adj:                                    | 1.00        | 1.00 | 1.00 | 1.00        | 1.00 | 1.00 | 1.00       | 1.00 | 1.00 | 1.00       | 1.00 | 1.00  |
| MLF Adj:                                    | 1.00        | 1.00 | 1.00 | 1.00        | 1.00 | 1.00 | 1.00       | 1.00 | 1.00 | 1.00       | 1.00 | 1.00  |
| FinalVolume:                                | 71          | 42   | 100  | 182         | 24   | 2    | 2          | 591  | 21   | 36         | 798  | 142   |
| -----                                       |             |      |      |             |      |      |            |      |      |            |      |       |
| Saturation Flow Module:                     |             |      |      |             |      |      |            |      |      |            |      |       |
| Sat/Lane:                                   | 1900        | 1900 | 1900 | 1900        | 1900 | 1900 | 1900       | 1900 | 1900 | 1900       | 1900 | 1900  |
| Adjustment:                                 | 0.95        | 0.95 | 0.92 | 0.95        | 0.95 | 0.92 | 0.95       | 0.97 | 0.92 | 0.92       | 0.98 | 0.95  |
| Lanes:                                      | 0.63        | 0.37 | 1.00 | 0.88        | 0.12 | 1.00 | 0.01       | 1.99 | 1.00 | 1.00       | 1.69 | 0.31  |
| Final Sat.:                                 | 1131        | 669  | 1750 | 1590        | 210  | 1750 | 12         | 3688 | 1750 | 1750       | 3141 | 559   |
| -----                                       |             |      |      |             |      |      |            |      |      |            |      |       |
| Capacity Analysis Module:                   |             |      |      |             |      |      |            |      |      |            |      |       |
| Vol/Sat:                                    | 0.06        | 0.06 | 0.06 | 0.11        | 0.11 | 0.00 | 0.16       | 0.16 | 0.01 | 0.02       | 0.25 | 0.25  |
| Crit Moves:                                 | *****       |      |      |             |      |      |            |      |      |            |      |       |
| Green Time:                                 | 28.4        | 28.4 | 28.4 | 28.4        | 28.4 | 28.4 | 39.7       | 39.7 | 39.7 | 62.9       | 103  | 102.6 |
| Volume/Cap:                                 | 0.31        | 0.31 | 0.28 | 0.57        | 0.57 | 0.01 | 0.57       | 0.57 | 0.04 | 0.05       | 0.35 | 0.35  |
| Delay/Veh:                                  | 48.0        | 48.0 | 47.7 | 52.3        | 52.3 | 44.6 | 43.5       | 43.5 | 36.4 | 21.7       | 6.8  | 6.8   |
| User DelAdj:                                | 1.00        | 1.00 | 1.00 | 1.00        | 1.00 | 1.00 | 1.00       | 1.00 | 1.00 | 1.00       | 1.00 | 1.00  |
| AdjDel/Veh:                                 | 48.0        | 48.0 | 47.7 | 52.3        | 52.3 | 44.6 | 43.5       | 43.5 | 36.4 | 21.7       | 6.8  | 6.8   |
| LOS by Move:                                | D           | D    | D    | D           | D    | D    | D          | D    | D    | C          | A    | A     |
| HCM2k95thQ:                                 | 8           | 8    | 7    | 17          | 17   | 0    | 20         | 20   | 1    | 2          | 14   | 14    |

Note: Queue reported is the number of cars per lane.

BART

Level Of Service Computation Report  
 2000 HCM Operations (Future Volume Alternative)  
 PM - Existing Conditions

Intersection #4005: JULIAN/28TH [Study Int 3]

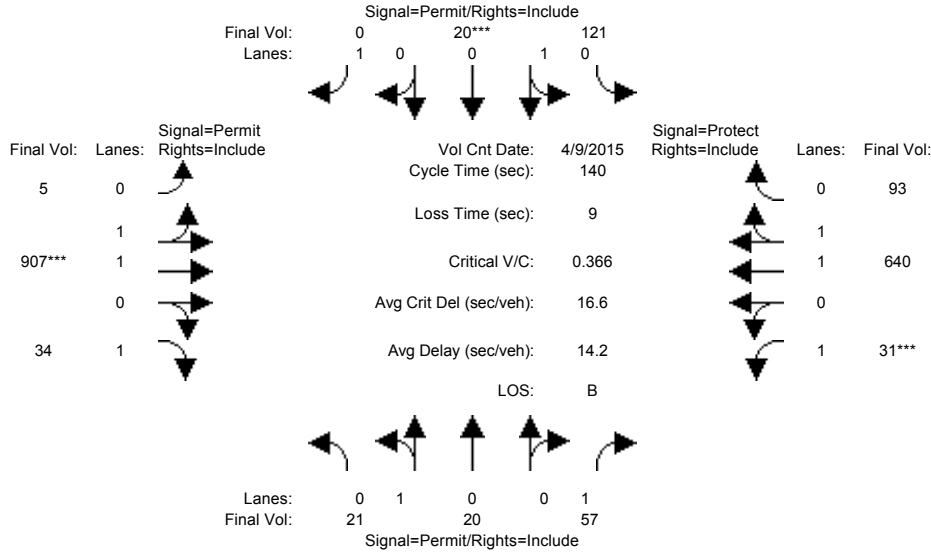

| Approach:                                   | North Bound |      |      | South Bound |      |      | East Bound |      |      | West Bound |      |       |
|---|-------------|------|------|-------------|------|------|------------|------|------|------------|------|-------|
| Movement:                                   | L           | T    | R    | L           | T    | R    | L          | T    | R    | L          | T    | R     |
| Min. Green:                                 | 10          | 10   | 10   | 10          | 10   | 10   | 10         | 10   | 10   | 7          | 10   | 10    |
| Y+R:  | 4.0         | 4.0  | 4.0  | 4.0         | 4.0  | 4.0  | 4.0        | 4.0  | 4.0  | 4.0        | 4.0  | 4.0   |
| Volume Module: >> Count Date: 9 Apr 2015 << |             |      |      |             |      |      |            |      |      |            |      |       |
| Base Vol:                                   | 21          | 20   | 57   | 121         | 20   | 0    | 5          | 907  | 34   | 31         | 640  | 93    |
| Growth Adj:                                 | 1.00        | 1.00 | 1.00 | 1.00        | 1.00 | 1.00 | 1.00       | 1.00 | 1.00 | 1.00       | 1.00 | 1.00  |
| Initial Bse:                                | 21          | 20   | 57   | 121         | 20   | 0    | 5          | 907  | 34   | 31         | 640  | 93    |
| Added Vol:                                  | 0           | 0    | 0    | 0           | 0    | 0    | 0          | 0    | 0    | 0          | 0    | 0     |
| PasserByVol:                                | 0           | 0    | 0    | 0           | 0    | 0    | 0          | 0    | 0    | 0          | 0    | 0     |
| Initial Fut:                                | 21          | 20   | 57   | 121         | 20   | 0    | 5          | 907  | 34   | 31         | 640  | 93    |
| User Adj:                                   | 1.00        | 1.00 | 1.00 | 1.00        | 1.00 | 1.00 | 1.00       | 1.00 | 1.00 | 1.00       | 1.00 | 1.00  |
| PHF Adj:                                    | 1.00        | 1.00 | 1.00 | 1.00        | 1.00 | 1.00 | 1.00       | 1.00 | 1.00 | 1.00       | 1.00 | 1.00  |
| PHF Volume:                                 | 21          | 20   | 57   | 121         | 20   | 0    | 5          | 907  | 34   | 31         | 640  | 93    |
| Reduct Vol:                                 | 0           | 0    | 0    | 0           | 0    | 0    | 0          | 0    | 0    | 0          | 0    | 0     |
| Reduced Vol:                                | 21          | 20   | 57   | 121         | 20   | 0    | 5          | 907  | 34   | 31         | 640  | 93    |
| PCE Adj:                                    | 1.00        | 1.00 | 1.00 | 1.00        | 1.00 | 1.00 | 1.00       | 1.00 | 1.00 | 1.00       | 1.00 | 1.00  |
| MLF Adj:                                    | 1.00        | 1.00 | 1.00 | 1.00        | 1.00 | 1.00 | 1.00       | 1.00 | 1.00 | 1.00       | 1.00 | 1.00  |
| Final Volume:                               | 21          | 20   | 57   | 121         | 20   | 0    | 5          | 907  | 34   | 31         | 640  | 93    |
| Saturation Flow Module:                     |             |      |      |             |      |      |            |      |      |            |      |       |
| Sat/Lane:                                   | 1900        | 1900 | 1900 | 1900        | 1900 | 1900 | 1900       | 1900 | 1900 | 1900       | 1900 | 1900  |
| Adjustment:                                 | 0.95        | 0.95 | 0.92 | 0.95        | 0.95 | 0.92 | 0.95       | 0.97 | 0.92 | 0.92       | 0.98 | 0.95  |
| Lanes:                                      | 0.51        | 0.49 | 1.00 | 0.86        | 0.14 | 1.00 | 0.01       | 1.99 | 1.00 | 1.00       | 1.74 | 0.26  |
| Final Sat.:                                 | 922         | 878  | 1750 | 1545        | 255  | 1750 | 20         | 3680 | 1750 | 1750       | 3230 | 469   |
| Capacity Analysis Module:                   |             |      |      |             |      |      |            |      |      |            |      |       |
| Vol/Sat:                                    | 0.02        | 0.02 | 0.03 | 0.08        | 0.08 | 0.00 | 0.25       | 0.25 | 0.02 | 0.02       | 0.20 | 0.20  |
| Crit Moves:                                 |             |      |      | ****        |      |      |            | **** |      |            |      | ****  |
| Green Time:                                 | 29.9        | 29.9 | 29.9 | 29.9        | 29.9 | 0.0  | 94.1       | 94.1 | 94.1 | 7.0        | 101  | 101.1 |
| Volume/Cap:                                 | 0.11        | 0.11 | 0.15 | 0.37        | 0.37 | 0.00 | 0.37       | 0.37 | 0.03 | 0.35       | 0.27 | 0.27  |
| Delay/Veh:                                  | 44.4        | 44.4 | 44.9 | 47.6        | 47.6 | 0.0  | 10.1       | 10.1 | 7.7  | 66.8       | 6.8  | 6.8   |
| User DelAdj:                                | 1.00        | 1.00 | 1.00 | 1.00        | 1.00 | 1.00 | 1.00       | 1.00 | 1.00 | 1.00       | 1.00 | 1.00  |
| AdjDel/Veh:                                 | 44.4        | 44.4 | 44.9 | 47.6        | 47.6 | 0.0  | 10.1       | 10.1 | 7.7  | 66.8       | 6.8  | 6.8   |
| LOS by Move:                                | D           | D    | D    | D           | D    | A    | B          | B    | A    | E          | A    | A     |
| HCM2k95thQ:                                 | 3           | 3    | 4    | 11          | 11   | 0    | 16         | 16   | 1    | 3          | 11   | 11    |

Note: Queue reported is the number of cars per lane.

BART

Level Of Service Computation Report  
 2000 HCM Operations (Future Volume Alternative)  
 AM - Existing Conditions

Intersection #4022: SANTA CLARA/26TH [Study Int 12]

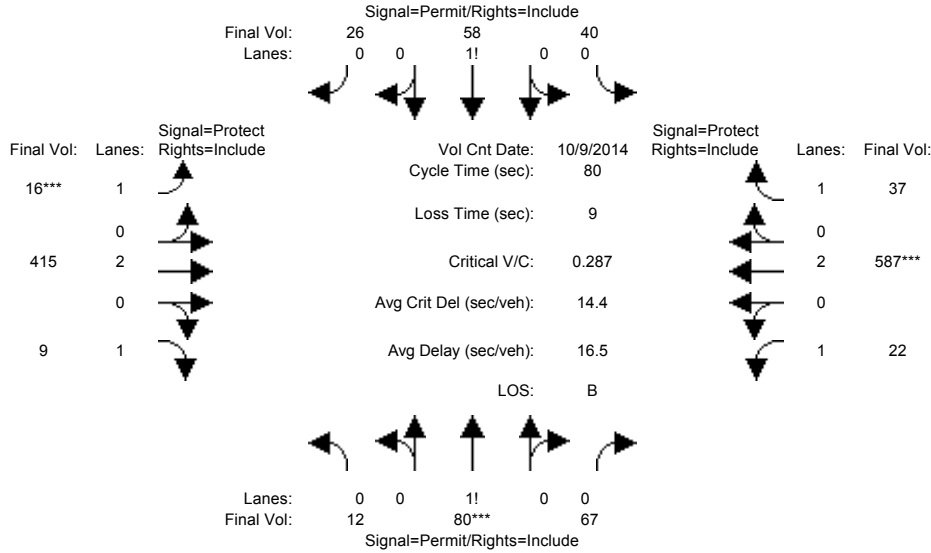

| Approach:                                   | North Bound |      |      | South Bound |      |      | East Bound |      |      | West Bound |      |      |
|---|-------------|------|------|-------------|------|------|------------|------|------|------------|------|------|
| Movement:                                   | L           | T    | R    | L           | T    | R    | L          | T    | R    | L          | T    | R    |
| Min. Green:                                 | 10          | 10   | 10   | 10          | 10   | 10   | 7          | 10   | 10   | 7          | 10   | 10   |
| Y+R:  | 4.0         | 4.0  | 4.0  | 4.0         | 4.0  | 4.0  | 4.0        | 4.0  | 4.0  | 4.0        | 4.0  | 4.0  |
| Volume Module: >> Count Date: 9 Oct 2014 << |             |      |      |             |      |      |            |      |      |            |      |      |
| Base Vol:                                   | 12          | 80   | 67   | 40          | 58   | 26   | 16         | 415  | 9    | 22         | 587  | 37   |
| Growth Adj:                                 | 1.00        | 1.00 | 1.00 | 1.00        | 1.00 | 1.00 | 1.00       | 1.00 | 1.00 | 1.00       | 1.00 | 1.00 |
| Initial Bse:                                | 12          | 80   | 67   | 40          | 58   | 26   | 16         | 415  | 9    | 22         | 587  | 37   |
| Added Vol:                                  | 0           | 0    | 0    | 0           | 0    | 0    | 0          | 0    | 0    | 0          | 0    | 0    |
| PasserByVol:                                | 0           | 0    | 0    | 0           | 0    | 0    | 0          | 0    | 0    | 0          | 0    | 0    |
| Initial Fut:                                | 12          | 80   | 67   | 40          | 58   | 26   | 16         | 415  | 9    | 22         | 587  | 37   |
| User Adj:                                   | 1.00        | 1.00 | 1.00 | 1.00        | 1.00 | 1.00 | 1.00       | 1.00 | 1.00 | 1.00       | 1.00 | 1.00 |
| PHF Adj:                                    | 1.00        | 1.00 | 1.00 | 1.00        | 1.00 | 1.00 | 1.00       | 1.00 | 1.00 | 1.00       | 1.00 | 1.00 |
| PHF Volume:                                 | 12          | 80   | 67   | 40          | 58   | 26   | 16         | 415  | 9    | 22         | 587  | 37   |
| Reduct Vol:                                 | 0           | 0    | 0    | 0           | 0    | 0    | 0          | 0    | 0    | 0          | 0    | 0    |
| Reduced Vol:                                | 12          | 80   | 67   | 40          | 58   | 26   | 16         | 415  | 9    | 22         | 587  | 37   |
| PCE Adj:                                    | 1.00        | 1.00 | 1.00 | 1.00        | 1.00 | 1.00 | 1.00       | 1.00 | 1.00 | 1.00       | 1.00 | 1.00 |
| MLF Adj:                                    | 1.00        | 1.00 | 1.00 | 1.00        | 1.00 | 1.00 | 1.00       | 1.00 | 1.00 | 1.00       | 1.00 | 1.00 |
| Final Volume:                               | 12          | 80   | 67   | 40          | 58   | 26   | 16         | 415  | 9    | 22         | 587  | 37   |
| Saturation Flow Module:                     |             |      |      |             |      |      |            |      |      |            |      |      |
| Sat/Lane:                                   | 1900        | 1900 | 1900 | 1900        | 1900 | 1900 | 1900       | 1900 | 1900 | 1900       | 1900 | 1900 |
| Adjustment:                                 | 0.92        | 0.92 | 0.92 | 0.92        | 0.92 | 0.92 | 0.92       | 1.00 | 0.92 | 0.92       | 1.00 | 0.92 |
| Lanes:                                      | 0.08        | 0.50 | 0.42 | 0.32        | 0.47 | 0.21 | 1.00       | 2.00 | 1.00 | 1.00       | 2.00 | 1.00 |
| Final Sat.:                                 | 132         | 881  | 737  | 565         | 819  | 367  | 1750       | 3800 | 1750 | 1750       | 3800 | 1750 |
| Capacity Analysis Module:                   |             |      |      |             |      |      |            |      |      |            |      |      |
| Vol/Sat:                                    | 0.09        | 0.09 | 0.09 | 0.07        | 0.07 | 0.07 | 0.01       | 0.11 | 0.01 | 0.01       | 0.15 | 0.02 |
| Crit Moves:                                 | ****        |      |      | ****        |      |      | ****       |      |      | ****       |      |      |
| Green Time:                                 | 23.7        | 23.7 | 23.7 | 23.7        | 23.7 | 23.7 | 7.0        | 27.8 | 27.8 | 19.5       | 40.3 | 40.3 |
| Volume/Cap:                                 | 0.31        | 0.31 | 0.31 | 0.24        | 0.24 | 0.24 | 0.10       | 0.31 | 0.01 | 0.05       | 0.31 | 0.04 |
| Delay/Veh:                                  | 22.1        | 22.1 | 22.1 | 21.6        | 21.6 | 21.6 | 33.9       | 19.2 | 17.1 | 23.2       | 11.7 | 10.1 |
| User DelAdj:                                | 1.00        | 1.00 | 1.00 | 1.00        | 1.00 | 1.00 | 1.00       | 1.00 | 1.00 | 1.00       | 1.00 | 1.00 |
| AdjDel/Veh:                                 | 22.1        | 22.1 | 22.1 | 21.6        | 21.6 | 21.6 | 33.9       | 19.2 | 17.1 | 23.2       | 11.7 | 10.1 |
| LOS by Move:                                | C           | C    | C    | C           | C    | C    | C          | B    | B    | C          | B    | B    |
| HCM2k95thQ:                                 | 7           | 7    | 7    | 5           | 5    | 5    | 1          | 7    | 0    | 1          | 8    | 1    |

Note: Queue reported is the number of cars per lane.



BART

Level Of Service Computation Report  
 2000 HCM Operations (Future Volume Alternative)  
 PM - Existing Conditions

Intersection #4022: SANTA CLARA/26TH [Study Int 12]

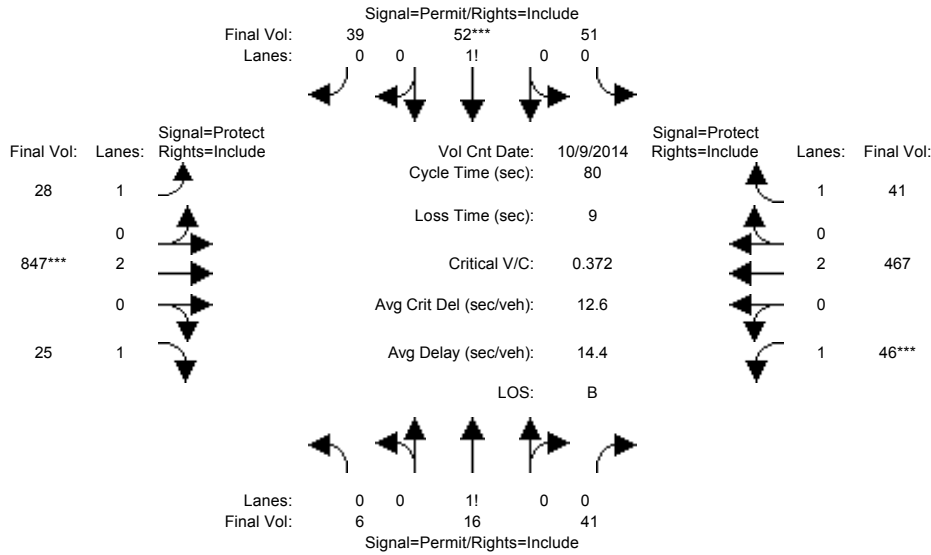

| Approach:                                   | North Bound |      |      | South Bound |      |      | East Bound |      |      | West Bound |      |      |
|---|-------------|------|------|-------------|------|------|------------|------|------|------------|------|------|
| Movement:                                   | L           | T    | R    | L           | T    | R    | L          | T    | R    | L          | T    | R    |
| Min. Green:                                 | 10          | 10   | 10   | 10          | 10   | 10   | 7          | 10   | 10   | 7          | 10   | 10   |
| Y+R:  | 4.0         | 4.0  | 4.0  | 4.0         | 4.0  | 4.0  | 4.0        | 4.0  | 4.0  | 4.0        | 4.0  | 4.0  |
| Volume Module: >> Count Date: 9 Oct 2014 << |             |      |      |             |      |      |            |      |      |            |      |      |
| Base Vol:                                   | 6           | 16   | 41   | 51          | 52   | 39   | 28         | 847  | 25   | 46         | 467  | 41   |
| Growth Adj:                                 | 1.00        | 1.00 | 1.00 | 1.00        | 1.00 | 1.00 | 1.00       | 1.00 | 1.00 | 1.00       | 1.00 | 1.00 |
| Initial Bse:                                | 6           | 16   | 41   | 51          | 52   | 39   | 28         | 847  | 25   | 46         | 467  | 41   |
| Added Vol:                                  | 0           | 0    | 0    | 0           | 0    | 0    | 0          | 0    | 0    | 0          | 0    | 0    |
| PasserByVol:                                | 0           | 0    | 0    | 0           | 0    | 0    | 0          | 0    | 0    | 0          | 0    | 0    |
| Initial Fut:                                | 6           | 16   | 41   | 51          | 52   | 39   | 28         | 847  | 25   | 46         | 467  | 41   |
| User Adj:                                   | 1.00        | 1.00 | 1.00 | 1.00        | 1.00 | 1.00 | 1.00       | 1.00 | 1.00 | 1.00       | 1.00 | 1.00 |
| PHF Adj:                                    | 1.00        | 1.00 | 1.00 | 1.00        | 1.00 | 1.00 | 1.00       | 1.00 | 1.00 | 1.00       | 1.00 | 1.00 |
| PHF Volume:                                 | 6           | 16   | 41   | 51          | 52   | 39   | 28         | 847  | 25   | 46         | 467  | 41   |
| Reduct Vol:                                 | 0           | 0    | 0    | 0           | 0    | 0    | 0          | 0    | 0    | 0          | 0    | 0    |
| Reduced Vol:                                | 6           | 16   | 41   | 51          | 52   | 39   | 28         | 847  | 25   | 46         | 467  | 41   |
| PCE Adj:                                    | 1.00        | 1.00 | 1.00 | 1.00        | 1.00 | 1.00 | 1.00       | 1.00 | 1.00 | 1.00       | 1.00 | 1.00 |
| MLF Adj:                                    | 1.00        | 1.00 | 1.00 | 1.00        | 1.00 | 1.00 | 1.00       | 1.00 | 1.00 | 1.00       | 1.00 | 1.00 |
| Final Volume:                               | 6           | 16   | 41   | 51          | 52   | 39   | 28         | 847  | 25   | 46         | 467  | 41   |
| Saturation Flow Module:                     |             |      |      |             |      |      |            |      |      |            |      |      |
| Sat/Lane:                                   | 1900        | 1900 | 1900 | 1900        | 1900 | 1900 | 1900       | 1900 | 1900 | 1900       | 1900 | 1900 |
| Adjustment:                                 | 0.92        | 0.92 | 0.92 | 0.92        | 0.92 | 0.92 | 0.92       | 1.00 | 0.92 | 0.92       | 1.00 | 0.92 |
| Lanes:                                      | 0.10        | 0.25 | 0.65 | 0.36        | 0.37 | 0.27 | 1.00       | 2.00 | 1.00 | 1.00       | 2.00 | 1.00 |
| Final Sat.:                                 | 167         | 444  | 1139 | 629         | 641  | 481  | 1750       | 3800 | 1750 | 1750       | 3800 | 1750 |
| Capacity Analysis Module:                   |             |      |      |             |      |      |            |      |      |            |      |      |
| Vol/Sat:                                    | 0.04        | 0.04 | 0.04 | 0.08        | 0.08 | 0.08 | 0.02       | 0.22 | 0.01 | 0.03       | 0.12 | 0.02 |
| Crit Moves:                                 |             |      |      | ****        |      |      |            | **** |      |            |      |      |
| Green Time:                                 | 17.1        | 17.1 | 17.1 | 17.1        | 17.1 | 17.1 | 22.2       | 46.9 | 46.9 | 7.0        | 31.7 | 31.7 |
| Volume/Cap:                                 | 0.17        | 0.17 | 0.17 | 0.38        | 0.38 | 0.38 | 0.06       | 0.38 | 0.02 | 0.30       | 0.31 | 0.06 |
| Delay/Veh:                                  | 25.9        | 25.9 | 25.9 | 27.6        | 27.6 | 27.6 | 21.3       | 8.9  | 6.9  | 35.3       | 16.7 | 15.0 |
| User DelAdj:                                | 1.00        | 1.00 | 1.00 | 1.00        | 1.00 | 1.00 | 1.00       | 1.00 | 1.00 | 1.00       | 1.00 | 1.00 |
| AdjDel/Veh:                                 | 25.9        | 25.9 | 25.9 | 27.6        | 27.6 | 27.6 | 21.3       | 8.9  | 6.9  | 35.3       | 16.7 | 15.0 |
| LOS by Move:                                | C           | C    | C    | C           | C    | C    | C          | A    | A    | D          | B    | B    |
| HCM2k95thQ:                                 | 3           | 3    | 3    | 7           | 7    | 7    | 1          | 11   | 1    | 2          | 8    | 1    |

Note: Queue reported is the number of cars per lane.

BART

Level Of Service Computation Report  
 2000 HCM Operations (Future Volume Alternative)  
 AM - Existing Conditions

Intersection #4038: 87/Taylor [Study Int 40]

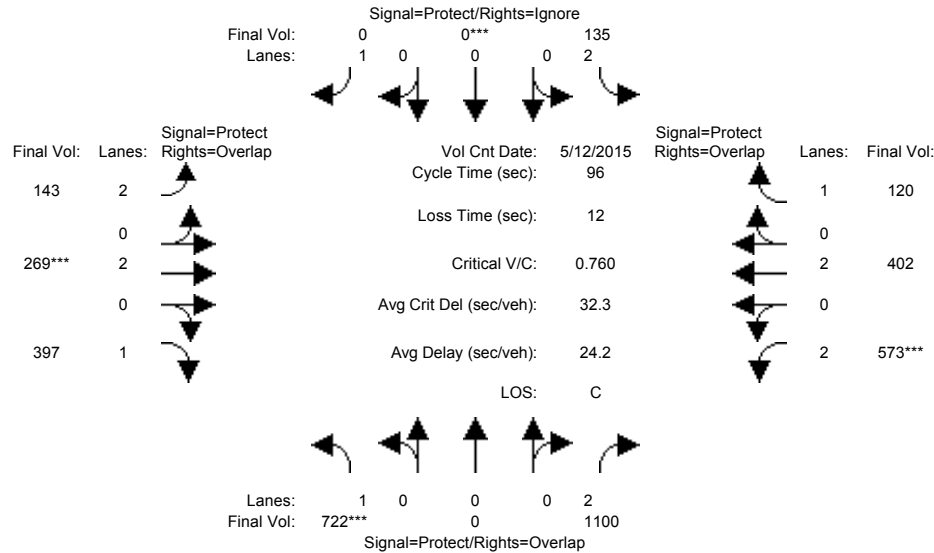

| Approach:                     | North Bound                |      |      | South Bound |      |      | East Bound |      |      | West Bound |      |      |
|-------------------------------|----------------------------|------|------|-------------|------|------|------------|------|------|------------|------|------|
| Movement:                     | L                          | T    | R    | L           | T    | R    | L          | T    | R    | L          | T    | R    |
| Min. Green:                   | 7                          | 0    | 10   | 7           | 0    | 10   | 7          | 10   | 10   | 7          | 10   | 10   |
| Y+R:                          | 4.0                        | 4.0  | 4.0  | 4.0         | 4.0  | 4.0  | 4.0        | 4.0  | 4.0  | 4.0        | 4.0  | 4.0  |
| Volume Module: >> Count Date: | 12 May 2015 << 7:30-8:30AM |      |      |             |      |      |            |      |      |            |      |      |
| Base Vol:                     | 722                        | 0    | 1100 | 135         | 0    | 146  | 143        | 269  | 397  | 573        | 402  | 120  |
| Growth Adj:                   | 1.00                       | 1.00 | 1.00 | 1.00        | 1.00 | 1.00 | 1.00       | 1.00 | 1.00 | 1.00       | 1.00 | 1.00 |
| Initial Bse:                  | 722                        | 0    | 1100 | 135         | 0    | 146  | 143        | 269  | 397  | 573        | 402  | 120  |
| Added Vol:                    | 0                          | 0    | 0    | 0           | 0    | 0    | 0          | 0    | 0    | 0          | 0    | 0    |
| PasserByVol:                  | 0                          | 0    | 0    | 0           | 0    | 0    | 0          | 0    | 0    | 0          | 0    | 0    |
| Initial Fut:                  | 722                        | 0    | 1100 | 135         | 0    | 146  | 143        | 269  | 397  | 573        | 402  | 120  |
| User Adj:                     | 1.00                       | 1.00 | 1.00 | 1.00        | 1.00 | 0.00 | 1.00       | 1.00 | 1.00 | 1.00       | 1.00 | 1.00 |
| PHF Adj:                      | 1.00                       | 1.00 | 1.00 | 1.00        | 1.00 | 0.00 | 1.00       | 1.00 | 1.00 | 1.00       | 1.00 | 1.00 |
| PHF Volume:                   | 722                        | 0    | 1100 | 135         | 0    | 0    | 143        | 269  | 397  | 573        | 402  | 120  |
| Reduct Vol:                   | 0                          | 0    | 0    | 0           | 0    | 0    | 0          | 0    | 0    | 0          | 0    | 0    |
| Reduced Vol:                  | 722                        | 0    | 1100 | 135         | 0    | 0    | 143        | 269  | 397  | 573        | 402  | 120  |
| PCE Adj:                      | 1.00                       | 1.00 | 1.00 | 1.00        | 1.00 | 0.00 | 1.00       | 1.00 | 1.00 | 1.00       | 1.00 | 1.00 |
| MLF Adj:                      | 1.00                       | 1.00 | 1.00 | 1.00        | 1.00 | 0.00 | 1.00       | 1.00 | 1.00 | 1.00       | 1.00 | 1.00 |
| Final Volume:                 | 722                        | 0    | 1100 | 135         | 0    | 0    | 143        | 269  | 397  | 573        | 402  | 120  |
| Saturation Flow Module:       |                            |      |      |             |      |      |            |      |      |            |      |      |
| Sat/Lane:                     | 1900                       | 1900 | 1900 | 1900        | 1900 | 1900 | 1900       | 1900 | 1900 | 1900       | 1900 | 1900 |
| Adjustment:                   | 0.92                       | 1.00 | 0.83 | 0.83        | 1.00 | 0.92 | 0.83       | 1.00 | 0.92 | 0.83       | 1.00 | 0.92 |
| Lanes:                        | 1.00                       | 0.00 | 2.00 | 2.00        | 0.00 | 1.00 | 2.00       | 2.00 | 1.00 | 2.00       | 2.00 | 1.00 |
| Final Sat.:                   | 1750                       | 0    | 3150 | 3150        | 0    | 1750 | 3150       | 3800 | 1750 | 3150       | 3800 | 1750 |
| Capacity Analysis Module:     |                            |      |      |             |      |      |            |      |      |            |      |      |
| Vol/Sat:                      | 0.41                       | 0.00 | 0.35 | 0.04        | 0.00 | 0.00 | 0.05       | 0.07 | 0.23 | 0.18       | 0.11 | 0.07 |
| Crit Moves:                   | ****                       |      |      | ****        |      |      | ****       |      |      | ****       |      |      |
| Green Time:                   | 51.4                       | 0.0  | 58.4 | 15.6        | 0.0  | 0.0  | 13.3       | 10.0 | 61.4 | 22.6       | 19.3 | 34.9 |
| Volume/Cap:                   | 0.77                       | 0.00 | 0.57 | 0.26        | 0.00 | 0.00 | 0.33       | 0.68 | 0.35 | 0.77       | 0.53 | 0.19 |
| Delay/Veh:                    | 21.7                       | 0.0  | 11.7 | 35.5        | 0.0  | 0.0  | 37.7       | 46.2 | 8.3  | 39.2       | 34.9 | 21.0 |
| User DelAdj:                  | 1.00                       | 1.00 | 1.00 | 1.00        | 1.00 | 1.00 | 1.00       | 1.00 | 1.00 | 1.00       | 1.00 | 1.00 |
| AdjDel/Veh:                   | 21.7                       | 0.0  | 11.7 | 35.5        | 0.0  | 0.0  | 37.7       | 46.2 | 8.3  | 39.2       | 34.9 | 21.0 |
| LOS by Move:                  | C                          | A    | B    | D           | A    | A    | D          | D    | A    | D          | C    | C    |
| HCM2k95thQ:                   | 33                         | 0    | 22   | 5           | 0    | 0    | 5          | 8    | 11   | 21         | 11   | 5    |

Note: Queue reported is the number of cars per lane.

BART

Level Of Service Computation Report  
2000 HCM Operations (Future Volume Alternative)  
PM - Existing Conditions

Intersection #4038: 87/Taylor [Study Int 40]

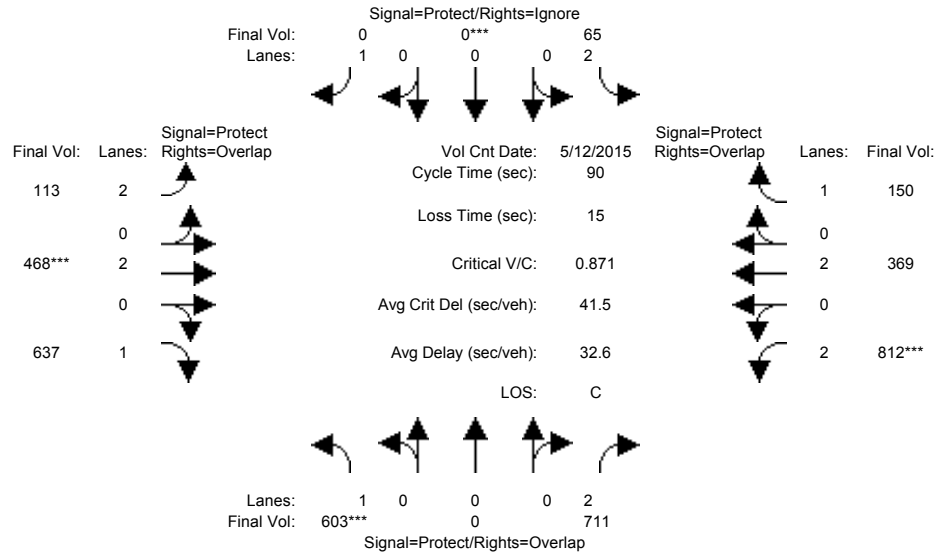

| Approach:  | North Bound |      |      | South Bound |      |      | East Bound |      |      | West Bound |      |      |
|--|-------------|------|------|-------------|------|------|------------|------|------|------------|------|------|
| Movement:  | L           | T    | R    | L           | T    | R    | L          | T    | R    | L          | T    | R    |
| Min. Green:  | 7           | 0    | 10   | 7           | 0    | 10   | 7          | 10   | 10   | 7          | 10   | 10   |
| Y+R:   | 4.0         | 4.0  | 4.0  | 4.0         | 4.0  | 4.0  | 4.0        | 4.0  | 4.0  | 4.0        | 4.0  | 4.0  |
| Volume Module: >> Count Date: 12 May 2015 << 5:00-6:00PM |             |      |      |             |      |      |            |      |      |            |      |      |
| Base Vol:  | 603         | 0    | 711  | 65          | 0    | 155  | 113        | 468  | 637  | 812        | 369  | 150  |
| Growth Adj:  | 1.00        | 1.00 | 1.00 | 1.00        | 1.00 | 1.00 | 1.00       | 1.00 | 1.00 | 1.00       | 1.00 | 1.00 |
| Initial Bse:   | 603         | 0    | 711  | 65          | 0    | 155  | 113        | 468  | 637  | 812        | 369  | 150  |
| Added Vol:   | 0           | 0    | 0    | 0           | 0    | 0    | 0          | 0    | 0    | 0          | 0    | 0    |
| PasserByVol:   | 0           | 0    | 0    | 0           | 0    | 0    | 0          | 0    | 0    | 0          | 0    | 0    |
| Initial Fut:   | 603         | 0    | 711  | 65          | 0    | 155  | 113        | 468  | 637  | 812        | 369  | 150  |
| User Adj:  | 1.00        | 1.00 | 1.00 | 1.00        | 1.00 | 0.00 | 1.00       | 1.00 | 1.00 | 1.00       | 1.00 | 1.00 |
| PHF Adj:   | 1.00        | 1.00 | 1.00 | 1.00        | 1.00 | 0.00 | 1.00       | 1.00 | 1.00 | 1.00       | 1.00 | 1.00 |
| PHF Volume:  | 603         | 0    | 711  | 65          | 0    | 0    | 113        | 468  | 637  | 812        | 369  | 150  |
| Reduct Vol:  | 0           | 0    | 0    | 0           | 0    | 0    | 0          | 0    | 0    | 0          | 0    | 0    |
| Reduced Vol:   | 603         | 0    | 711  | 65          | 0    | 0    | 113        | 468  | 637  | 812        | 369  | 150  |
| PCE Adj:   | 1.00        | 1.00 | 1.00 | 1.00        | 1.00 | 0.00 | 1.00       | 1.00 | 1.00 | 1.00       | 1.00 | 1.00 |
| MLF Adj:   | 1.00        | 1.00 | 1.00 | 1.00        | 1.00 | 0.00 | 1.00       | 1.00 | 1.00 | 1.00       | 1.00 | 1.00 |
| Final Volume:  | 603         | 0    | 711  | 65          | 0    | 0    | 113        | 468  | 637  | 812        | 369  | 150  |
| Saturation Flow Module:                                  |             |      |      |             |      |      |            |      |      |            |      |      |
| Sat/Lane:  | 1900        | 1900 | 1900 | 1900        | 1900 | 1900 | 1900       | 1900 | 1900 | 1900       | 1900 | 1900 |
| Adjustment:  | 0.92        | 1.00 | 0.83 | 0.83        | 1.00 | 0.92 | 0.83       | 1.00 | 0.92 | 0.83       | 1.00 | 0.92 |
| Lanes:   | 1.00        | 0.00 | 2.00 | 2.00        | 0.00 | 1.00 | 2.00       | 2.00 | 1.00 | 2.00       | 2.00 | 1.00 |
| Final Sat.:  | 1750        | 0    | 3150 | 3150        | 0    | 1750 | 3150       | 3800 | 1750 | 3150       | 3800 | 1750 |
| Capacity Analysis Module:                                |             |      |      |             |      |      |            |      |      |            |      |      |
| Vol/Sat:   | 0.34        | 0.00 | 0.23 | 0.02        | 0.00 | 0.00 | 0.04       | 0.12 | 0.36 | 0.26       | 0.10 | 0.09 |
| Crit Moves:  | ****        |      |      | ****        |      |      | ****       |      |      | ****       |      |      |
| Green Time:  | 35.6        | 0.0  | 26.6 | 35.6        | 0.0  | 0.0  | 16.2       | 12.7 | 48.4 | 26.6       | 23.2 | 58.8 |
| Volume/Cap:  | 0.87        | 0.00 | 0.76 | 0.05        | 0.00 | 0.00 | 0.20       | 0.87 | 0.68 | 0.87       | 0.38 | 0.13 |
| Delay/Veh:   | 36.6        | 0.0  | 32.5 | 16.8        | 0.0  | 0.0  | 31.5       | 52.2 | 17.2 | 39.0       | 27.7 | 6.0  |
| User DelAdj:   | 1.00        | 1.00 | 1.00 | 1.00        | 1.00 | 1.00 | 1.00       | 1.00 | 1.00 | 1.00       | 1.00 | 1.00 |
| AdjDel/Veh:  | 36.6        | 0.0  | 32.5 | 16.8        | 0.0  | 0.0  | 31.5       | 52.2 | 17.2 | 39.0       | 27.7 | 6.0  |
| LOS by Move:   | D           | A    | C    | B           | A    | A    | C          | D    | B    | D          | C    | A    |
| HCM2k95thQ:  | 34          | 0    | 22   | 1           | 0    | 0    | 3          | 13   | 24   | 28         | 9    | 3    |

Note: Queue reported is the number of cars per lane.

BART

Level Of Service Computation Report  
2000 HCM Operations (Future Volume Alternative)  
AM - Existing Conditions

Intersection #4047: COLEMAN/NEWHALL [Study Int 35]

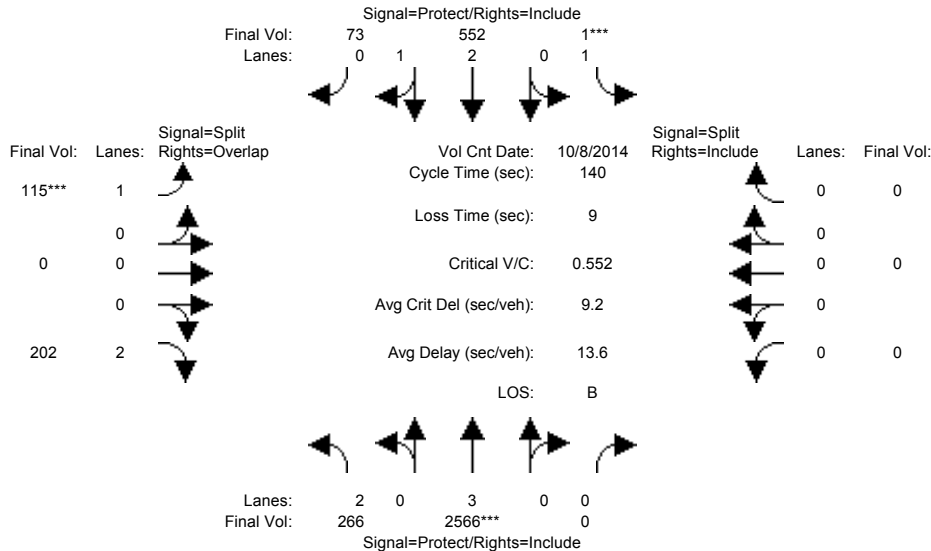

| Approach:                                   | North Bound |      |      | South Bound |      |      | East Bound |      |      | West Bound |      |      |
|---|-------------|------|------|-------------|------|------|------------|------|------|------------|------|------|
| Movement:                                   | L           | T    | R    | L           | T    | R    | L          | T    | R    | L          | T    | R    |
| Min. Green:                                 | 7           | 10   | 0    | 7           | 10   | 10   | 10         | 0    | 10   | 0          | 0    | 0    |
| Y+R:  | 4.0         | 4.0  | 4.0  | 4.0         | 4.0  | 4.0  | 4.0        | 4.0  | 4.0  | 4.0        | 4.0  | 4.0  |
| Volume Module: >> Count Date: 8 Oct 2014 << |             |      |      |             |      |      |            |      |      |            |      |      |
| Base Vol:                                   | 266         | 2566 | 0    | 1           | 552  | 73   | 115        | 0    | 202  | 0          | 0    | 0    |
| Growth Adj:                                 | 1.00        | 1.00 | 1.00 | 1.00        | 1.00 | 1.00 | 1.00       | 1.00 | 1.00 | 1.00       | 1.00 | 1.00 |
| Initial Bse:                                | 266         | 2566 | 0    | 1           | 552  | 73   | 115        | 0    | 202  | 0          | 0    | 0    |
| Added Vol:                                  | 0           | 0    | 0    | 0           | 0    | 0    | 0          | 0    | 0    | 0          | 0    | 0    |
| PasserByVol:                                | 0           | 0    | 0    | 0           | 0    | 0    | 0          | 0    | 0    | 0          | 0    | 0    |
| Initial Fut:                                | 266         | 2566 | 0    | 1           | 552  | 73   | 115        | 0    | 202  | 0          | 0    | 0    |
| User Adj:                                   | 1.00        | 1.00 | 1.00 | 1.00        | 1.00 | 1.00 | 1.00       | 1.00 | 1.00 | 1.00       | 1.00 | 1.00 |
| PHF Adj:                                    | 1.00        | 1.00 | 1.00 | 1.00        | 1.00 | 1.00 | 1.00       | 1.00 | 1.00 | 1.00       | 1.00 | 1.00 |
| PHF Volume:                                 | 266         | 2566 | 0    | 1           | 552  | 73   | 115        | 0    | 202  | 0          | 0    | 0    |
| Reduct Vol:                                 | 0           | 0    | 0    | 0           | 0    | 0    | 0          | 0    | 0    | 0          | 0    | 0    |
| Reduced Vol:                                | 266         | 2566 | 0    | 1           | 552  | 73   | 115        | 0    | 202  | 0          | 0    | 0    |
| PCE Adj:                                    | 1.00        | 1.00 | 1.00 | 1.00        | 1.00 | 1.00 | 1.00       | 1.00 | 1.00 | 1.00       | 1.00 | 1.00 |
| MLF Adj:                                    | 1.00        | 1.00 | 1.00 | 1.00        | 1.00 | 1.00 | 1.00       | 1.00 | 1.00 | 1.00       | 1.00 | 1.00 |
| Final Volume:                               | 266         | 2566 | 0    | 1           | 552  | 73   | 115        | 0    | 202  | 0          | 0    | 0    |
| Saturation Flow Module:                     |             |      |      |             |      |      |            |      |      |            |      |      |
| Sat/Lane:                                   | 1900        | 1900 | 1900 | 1900        | 1900 | 1900 | 1900       | 1900 | 1900 | 1900       | 1900 | 1900 |
| Adjustment:                                 | 0.83        | 1.00 | 0.92 | 0.92        | 0.99 | 0.95 | 0.92       | 1.00 | 0.83 | 0.92       | 1.00 | 0.92 |
| Lanes:                                      | 2.00        | 3.00 | 0.00 | 1.00        | 2.64 | 0.36 | 1.00       | 0.00 | 2.00 | 0.00       | 0.00 | 0.00 |
| Final Sat.:                                 | 3150        | 5700 | 0    | 1750        | 4945 | 654  | 1750       | 0    | 3150 | 0          | 0    | 0    |
| Capacity Analysis Module:                   |             |      |      |             |      |      |            |      |      |            |      |      |
| Vol/Sat:                                    | 0.08        | 0.45 | 0.00 | 0.00        | 0.11 | 0.11 | 0.07       | 0.00 | 0.06 | 0.00       | 0.00 | 0.00 |
| Crit Moves:                                 | ****        | **** | **** | ****        | **** | **** | ****       | **** | **** | ****       | **** | **** |
| Green Time:                                 | 49.6        | 108  | 0.0  | 7.0         | 65.6 | 65.6 | 15.8       | 0.0  | 65.4 | 0.0        | 0.0  | 0.0  |
| Volume/Cap:                                 | 0.24        | 0.58 | 0.00 | 0.01        | 0.24 | 0.24 | 0.58       | 0.00 | 0.14 | 0.00       | 0.00 | 0.00 |
| Delay/Veh:                                  | 32.0        | 6.8  | 0.0  | 63.3        | 22.3 | 22.3 | 63.3       | 0.0  | 21.3 | 0.0        | 0.0  | 0.0  |
| User DelAdj:                                | 1.00        | 1.00 | 1.00 | 1.00        | 1.00 | 1.00 | 1.00       | 1.00 | 1.00 | 1.00       | 1.00 | 1.00 |
| AdjDel/Veh:                                 | 32.0        | 6.8  | 0.0  | 63.3        | 22.3 | 22.3 | 63.3       | 0.0  | 21.3 | 0.0        | 0.0  | 0.0  |
| LOS by Move:                                | C           | A    | A    | E           | C    | C    | E          | A    | C    | A          | A    | A    |
| HCM2k95thQ:                                 | 9           | 27   | 0    | 0           | 10   | 10   | 11         | 0    | 6    | 0          | 0    | 0    |

Note: Queue reported is the number of cars per lane.

BART

Level Of Service Computation Report  
 2000 HCM Operations (Future Volume Alternative)  
 PM - Existing Conditions

Intersection #4047: COLEMAN/NEWHALL [Study Int 35]

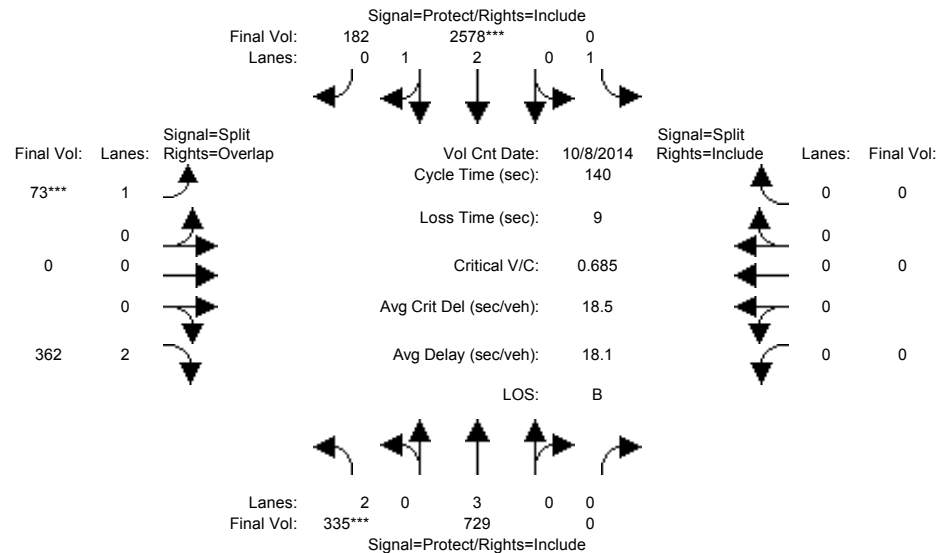

| Approach:                                   | North Bound |      |      | South Bound |      |      | East Bound |      |      | West Bound |      |      |
|---|-------------|------|------|-------------|------|------|------------|------|------|------------|------|------|
| Movement:                                   | L           | T    | R    | L           | T    | R    | L          | T    | R    | L          | T    | R    |
| Min. Green:                                 | 7           | 10   | 0    | 7           | 10   | 10   | 10         | 0    | 10   | 0          | 0    | 0    |
| Y+R:  | 4.0         | 4.0  | 4.0  | 4.0         | 4.0  | 4.0  | 4.0        | 4.0  | 4.0  | 4.0        | 4.0  | 4.0  |
| Volume Module: >> Count Date: 8 Oct 2014 << |             |      |      |             |      |      |            |      |      |            |      |      |
| Base Vol:                                   | 335         | 729  | 0    | 0           | 2578 | 182  | 73         | 0    | 362  | 0          | 0    | 0    |
| Growth Adj:                                 | 1.00        | 1.00 | 1.00 | 1.00        | 1.00 | 1.00 | 1.00       | 1.00 | 1.00 | 1.00       | 1.00 | 1.00 |
| Initial Bse:                                | 335         | 729  | 0    | 0           | 2578 | 182  | 73         | 0    | 362  | 0          | 0    | 0    |
| Added Vol:                                  | 0           | 0    | 0    | 0           | 0    | 0    | 0          | 0    | 0    | 0          | 0    | 0    |
| PasserByVol:                                | 0           | 0    | 0    | 0           | 0    | 0    | 0          | 0    | 0    | 0          | 0    | 0    |
| Initial Fut:                                | 335         | 729  | 0    | 0           | 2578 | 182  | 73         | 0    | 362  | 0          | 0    | 0    |
| User Adj:                                   | 1.00        | 1.00 | 1.00 | 1.00        | 1.00 | 1.00 | 1.00       | 1.00 | 1.00 | 1.00       | 1.00 | 1.00 |
| PHF Adj:                                    | 1.00        | 1.00 | 1.00 | 1.00        | 1.00 | 1.00 | 1.00       | 1.00 | 1.00 | 1.00       | 1.00 | 1.00 |
| PHF Volume:                                 | 335         | 729  | 0    | 0           | 2578 | 182  | 73         | 0    | 362  | 0          | 0    | 0    |
| Reduct Vol:                                 | 0           | 0    | 0    | 0           | 0    | 0    | 0          | 0    | 0    | 0          | 0    | 0    |
| Reduced Vol:                                | 335         | 729  | 0    | 0           | 2578 | 182  | 73         | 0    | 362  | 0          | 0    | 0    |
| PCE Adj:                                    | 1.00        | 1.00 | 1.00 | 1.00        | 1.00 | 1.00 | 1.00       | 1.00 | 1.00 | 1.00       | 1.00 | 1.00 |
| MLF Adj:                                    | 1.00        | 1.00 | 1.00 | 1.00        | 1.00 | 1.00 | 1.00       | 1.00 | 1.00 | 1.00       | 1.00 | 1.00 |
| Final Volume:                               | 335         | 729  | 0    | 0           | 2578 | 182  | 73         | 0    | 362  | 0          | 0    | 0    |
| Saturation Flow Module:                     |             |      |      |             |      |      |            |      |      |            |      |      |
| Sat/Lane:                                   | 1900        | 1900 | 1900 | 1900        | 1900 | 1900 | 1900       | 1900 | 1900 | 1900       | 1900 | 1900 |
| Adjustment:                                 | 0.83        | 1.00 | 0.92 | 0.92        | 0.98 | 0.95 | 0.92       | 1.00 | 0.83 | 0.92       | 1.00 | 0.92 |
| Lanes:                                      | 2.00        | 3.00 | 0.00 | 1.00        | 2.79 | 0.21 | 1.00       | 0.00 | 2.00 | 0.00       | 0.00 | 0.00 |
| Final Sat.:                                 | 3150        | 5700 | 0    | 1750        | 5230 | 369  | 1750       | 0    | 3150 | 0          | 0    | 0    |
| Capacity Analysis Module:                   |             |      |      |             |      |      |            |      |      |            |      |      |
| Vol/Sat:                                    | 0.11        | 0.13 | 0.00 | 0.00        | 0.49 | 0.49 | 0.04       | 0.00 | 0.11 | 0.00       | 0.00 | 0.00 |
| Crit Moves:                                 | ****        | **** | **** | ****        | **** | **** | ****       | **** | **** | ****       | **** | **** |
| Green Time:                                 | 21.5        | 121  | 0.0  | 0.0         | 99.5 | 99.5 | 10.0       | 0.0  | 31.5 | 0.0        | 0.0  | 0.0  |
| Volume/Cap:                                 | 0.69        | 0.15 | 0.00 | 0.00        | 0.69 | 0.69 | 0.58       | 0.00 | 0.51 | 0.00       | 0.00 | 0.00 |
| Delay/Veh:                                  | 60.5        | 1.5  | 0.0  | 0.0         | 12.1 | 12.1 | 69.9       | 0.0  | 48.2 | 0.0        | 0.0  | 0.0  |
| User DelAdj:                                | 1.00        | 1.00 | 1.00 | 1.00        | 1.00 | 1.00 | 1.00       | 1.00 | 1.00 | 1.00       | 1.00 | 1.00 |
| AdjDel/Veh:                                 | 60.5        | 1.5  | 0.0  | 0.0         | 12.1 | 12.1 | 69.9       | 0.0  | 48.2 | 0.0        | 0.0  | 0.0  |
| LOS by Move:                                | E           | A    | A    | A           | B    | B    | E          | A    | D    | A          | A    | A    |
| HCM2k95thQ:                                 | 17          | 3    | 0    | 0           | 38   | 38   | 8          | 0    | 16   | 0          | 0    | 0    |

Note: Queue reported is the number of cars per lane.

BART

Level Of Service Computation Report  
2000 HCM Operations (Future Volume Alternative)  
AM - Existing Conditions

Intersection #4069: 101/Trimble [Study Int 62]

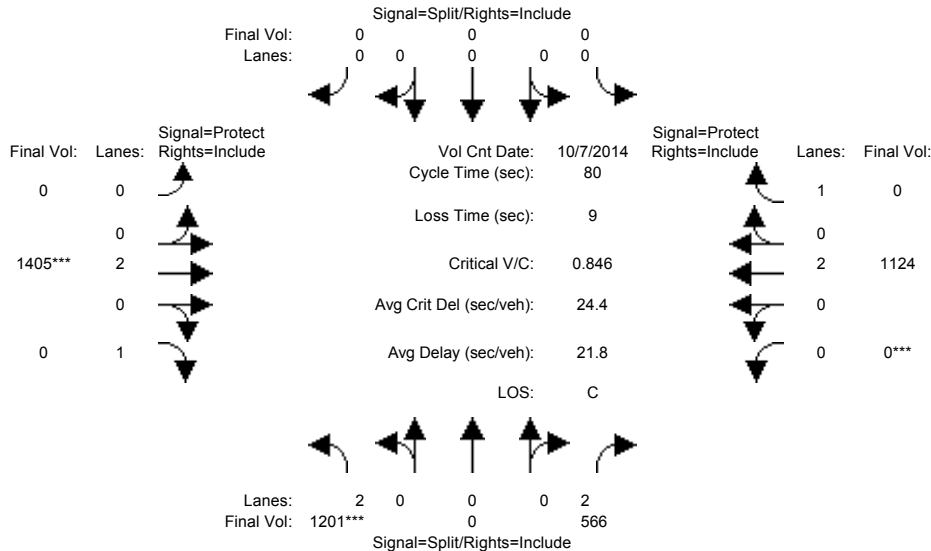

| Approach:   | North Bound |      |      | South Bound |      |      | East Bound |      |      | West Bound |      |      |
|---|-------------|------|------|-------------|------|------|------------|------|------|------------|------|------|
| Movement:   | L           | T    | R    | L           | T    | R    | L          | T    | R    | L          | T    | R    |
| Min. Green:   | 10          | 0    | 10   | 0           | 0    | 0    | 0          | 10   | 10   | 0          | 10   | 10   |
| Y+R:  | 4.0         | 4.0  | 4.0  | 4.0         | 4.0  | 4.0  | 4.0        | 4.0  | 4.0  | 4.0        | 4.0  | 4.0  |
| Volume Module: >> Count Date: 7 Oct 2014 << 7:55-8:55AM |             |      |      |             |      |      |            |      |      |            |      |      |
| Base Vol:   | 1201        | 0    | 566  | 0           | 0    | 0    | 0          | 1405 | 397  | 0          | 1124 | 320  |
| Growth Adj:   | 1.00        | 1.00 | 1.00 | 1.00        | 1.00 | 1.00 | 1.00       | 1.00 | 1.00 | 1.00       | 1.00 | 1.00 |
| Initial Bse:  | 1201        | 0    | 566  | 0           | 0    | 0    | 0          | 1405 | 397  | 0          | 1124 | 320  |
| Added Vol:  | 0           | 0    | 0    | 0           | 0    | 0    | 0          | 0    | 0    | 0          | 0    | 0    |
| PasserByVol:  | 0           | 0    | 0    | 0           | 0    | 0    | 0          | 0    | 0    | 0          | 0    | 0    |
| Initial Fut:  | 1201        | 0    | 566  | 0           | 0    | 0    | 0          | 1405 | 397  | 0          | 1124 | 320  |
| User Adj:   | 1.00        | 1.00 | 1.00 | 1.00        | 1.00 | 1.00 | 1.00       | 1.00 | 0.00 | 1.00       | 1.00 | 0.00 |
| PHF Adj:  | 1.00        | 1.00 | 1.00 | 1.00        | 1.00 | 1.00 | 1.00       | 1.00 | 1.00 | 1.00       | 1.00 | 1.00 |
| PHF Volume:   | 1201        | 0    | 566  | 0           | 0    | 0    | 0          | 1405 | 0    | 0          | 1124 | 0    |
| Reduct Vol:   | 0           | 0    | 0    | 0           | 0    | 0    | 0          | 0    | 0    | 0          | 0    | 0    |
| Reduced Vol:  | 1201        | 0    | 566  | 0           | 0    | 0    | 0          | 1405 | 0    | 0          | 1124 | 0    |
| PCE Adj:  | 1.00        | 1.00 | 1.00 | 1.00        | 1.00 | 1.00 | 1.00       | 1.00 | 1.00 | 1.00       | 1.00 | 1.00 |
| MLF Adj:  | 1.00        | 1.00 | 1.00 | 1.00        | 1.00 | 1.00 | 1.00       | 1.00 | 1.00 | 1.00       | 1.00 | 1.00 |
| Final Volume:   | 1201        | 0    | 566  | 0           | 0    | 0    | 0          | 1405 | 0    | 0          | 1124 | 0    |
| Saturation Flow Module:                                 |             |      |      |             |      |      |            |      |      |            |      |      |
| Sat/Lane:   | 1900        | 1900 | 1900 | 1900        | 1900 | 1900 | 1900       | 1900 | 1900 | 1900       | 1900 | 1900 |
| Adjustment:   | 0.83        | 1.00 | 0.83 | 0.92        | 1.00 | 0.92 | 0.92       | 1.00 | 0.92 | 0.92       | 1.00 | 0.92 |
| Lanes:  | 2.00        | 0.00 | 2.00 | 0.00        | 0.00 | 0.00 | 0.00       | 2.00 | 1.00 | 0.00       | 2.00 | 1.00 |
| Final Sat.:   | 3150        | 0    | 3150 | 0           | 0    | 0    | 0          | 3800 | 1750 | 0          | 3800 | 1750 |
| Capacity Analysis Module:                               |             |      |      |             |      |      |            |      |      |            |      |      |
| Vol/Sat:  | 0.38        | 0.00 | 0.18 | 0.00        | 0.00 | 0.00 | 0.00       | 0.37 | 0.00 | 0.00       | 0.30 | 0.00 |
| Crit Moves:   | ****        |      |      |             |      |      |            | **** |      |            | **** |      |
| Green Time:   | 36.0        | 0.0  | 36.0 | 0.0         | 0.0  | 0.0  | 0.0        | 35.0 | 0.0  | 0.0        | 35.0 | 0.0  |
| Volume/Cap:   | 0.85        | 0.00 | 0.40 | 0.00        | 0.00 | 0.00 | 0.00       | 0.85 | 0.00 | 0.00       | 0.68 | 0.00 |
| Delay/Veh:  | 24.4        | 0.0  | 14.9 | 0.0         | 0.0  | 0.0  | 0.0        | 24.4 | 0.0  | 0.0        | 19.1 | 0.0  |
| User DelAdj:  | 1.00        | 1.00 | 1.00 | 1.00        | 1.00 | 1.00 | 1.00       | 1.00 | 1.00 | 1.00       | 1.00 | 1.00 |
| AdjDel/Veh:   | 24.4        | 0.0  | 14.9 | 0.0         | 0.0  | 0.0  | 0.0        | 24.4 | 0.0  | 0.0        | 19.1 | 0.0  |
| LOS by Move:  | C           | A    | B    | A           | A    | A    | A          | C    | A    | A          | B    | A    |
| HCM2k95thQ:   | 32          | 0    | 11   | 0           | 0    | 0    | 0          | 29   | 0    | 0          | 22   | 0    |

Note: Queue reported is the number of cars per lane.

BART

Level Of Service Computation Report  
2000 HCM Operations (Future Volume Alternative)  
PM - Existing Conditions

Intersection #4069: 101/Trimble [Study Int 62]

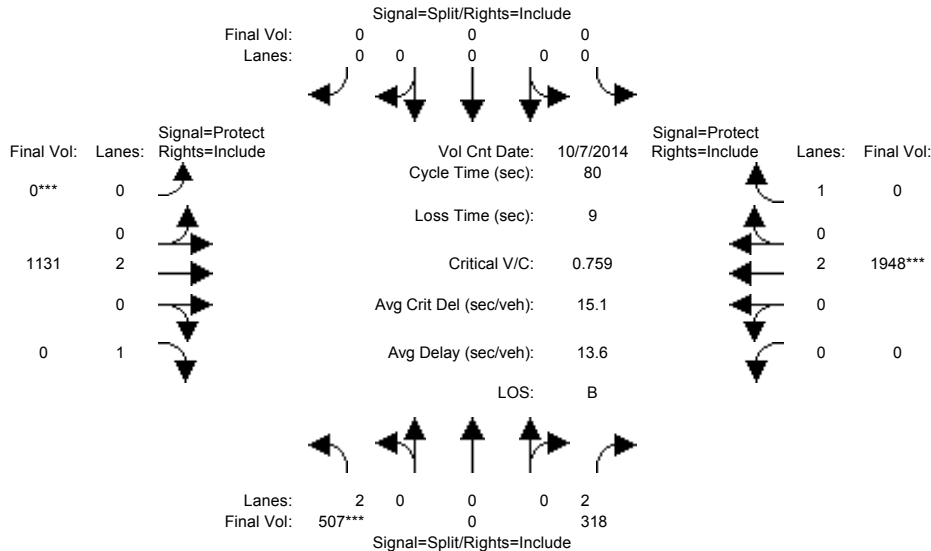

| Approach:   | North Bound |      |      | South Bound |      |      | East Bound |      |      | West Bound |      |      |
|---|-------------|------|------|-------------|------|------|------------|------|------|------------|------|------|
| Movement:   | L           | T    | R    | L           | T    | R    | L          | T    | R    | L          | T    | R    |
| Min. Green:   | 10          | 0    | 10   | 0           | 0    | 0    | 0          | 10   | 10   | 0          | 10   | 10   |
| Y+R:  | 4.0         | 4.0  | 4.0  | 4.0         | 4.0  | 4.0  | 4.0        | 4.0  | 4.0  | 4.0        | 4.0  | 4.0  |
| Volume Module: >> Count Date: 7 Oct 2014 << 5:00-6:00PM |             |      |      |             |      |      |            |      |      |            |      |      |
| Base Vol:   | 507         | 0    | 318  | 0           | 0    | 0    | 0          | 1131 | 205  | 0          | 1948 | 735  |
| Growth Adj:   | 1.00        | 1.00 | 1.00 | 1.00        | 1.00 | 1.00 | 1.00       | 1.00 | 1.00 | 1.00       | 1.00 | 1.00 |
| Initial Bse:  | 507         | 0    | 318  | 0           | 0    | 0    | 0          | 1131 | 205  | 0          | 1948 | 735  |
| Added Vol:  | 0           | 0    | 0    | 0           | 0    | 0    | 0          | 0    | 0    | 0          | 0    | 0    |
| PasserByVol:  | 0           | 0    | 0    | 0           | 0    | 0    | 0          | 0    | 0    | 0          | 0    | 0    |
| Initial Fut:  | 507         | 0    | 318  | 0           | 0    | 0    | 0          | 1131 | 205  | 0          | 1948 | 735  |
| User Adj:   | 1.00        | 1.00 | 1.00 | 1.00        | 1.00 | 1.00 | 1.00       | 1.00 | 0.00 | 1.00       | 1.00 | 0.00 |
| PHF Adj:  | 1.00        | 1.00 | 1.00 | 1.00        | 1.00 | 1.00 | 1.00       | 1.00 | 1.00 | 1.00       | 1.00 | 1.00 |
| PHF Volume:   | 507         | 0    | 318  | 0           | 0    | 0    | 0          | 1131 | 0    | 0          | 1948 | 0    |
| Reduct Vol:   | 0           | 0    | 0    | 0           | 0    | 0    | 0          | 0    | 0    | 0          | 0    | 0    |
| Reduced Vol:  | 507         | 0    | 318  | 0           | 0    | 0    | 0          | 1131 | 0    | 0          | 1948 | 0    |
| PCE Adj:  | 1.00        | 1.00 | 1.00 | 1.00        | 1.00 | 1.00 | 1.00       | 1.00 | 1.00 | 1.00       | 1.00 | 1.00 |
| MLF Adj:  | 1.00        | 1.00 | 1.00 | 1.00        | 1.00 | 1.00 | 1.00       | 1.00 | 1.00 | 1.00       | 1.00 | 1.00 |
| FinalVolume:  | 507         | 0    | 318  | 0           | 0    | 0    | 0          | 1131 | 0    | 0          | 1948 | 0    |
| Saturation Flow Module:                                 |             |      |      |             |      |      |            |      |      |            |      |      |
| Sat/Lane:   | 1900        | 1900 | 1900 | 1900        | 1900 | 1900 | 1900       | 1900 | 1900 | 1900       | 1900 | 1900 |
| Adjustment:   | 0.83        | 1.00 | 0.83 | 0.92        | 1.00 | 0.92 | 0.92       | 1.00 | 0.92 | 0.92       | 1.00 | 0.92 |
| Lanes:  | 2.00        | 0.00 | 2.00 | 0.00        | 0.00 | 0.00 | 0.00       | 2.00 | 1.00 | 0.00       | 2.00 | 1.00 |
| Final Sat.:   | 3150        | 0    | 3150 | 0           | 0    | 0    | 0          | 3800 | 1750 | 0          | 3800 | 1750 |
| Capacity Analysis Module:                               |             |      |      |             |      |      |            |      |      |            |      |      |
| Vol/Sat:  | 0.16        | 0.00 | 0.10 | 0.00        | 0.00 | 0.00 | 0.00       | 0.30 | 0.00 | 0.00       | 0.51 | 0.00 |
| Crit Moves:   | ****        |      |      |             |      |      | ****       |      |      | ****       |      |      |
| Green Time:   | 17.0        | 0.0  | 17.0 | 0.0         | 0.0  | 0.0  | 0.0        | 54.0 | 0.0  | 0.0        | 54.0 | 0.0  |
| Volume/Cap:   | 0.76        | 0.00 | 0.48 | 0.00        | 0.00 | 0.00 | 0.00       | 0.44 | 0.00 | 0.00       | 0.76 | 0.00 |
| Delay/Veh:  | 34.6        | 0.0  | 28.2 | 0.0         | 0.0  | 0.0  | 0.0        | 6.1  | 0.0  | 0.0        | 10.0 | 0.0  |
| User DelAdj:  | 1.00        | 1.00 | 1.00 | 1.00        | 1.00 | 1.00 | 1.00       | 1.00 | 1.00 | 1.00       | 1.00 | 1.00 |
| AdjDel/Veh:   | 34.6        | 0.0  | 28.2 | 0.0         | 0.0  | 0.0  | 0.0        | 6.1  | 0.0  | 0.0        | 10.0 | 0.0  |
| LOS by Move:  | C           | A    | C    | A           | A    | A    | A          | A    | A    | A          | B    | A    |
| HCM2k95thQ:   | 17          | 0    | 9    | 0           | 0    | 0    | 0          | 12   | 0    | 0          | 30   | 0    |

Note: Queue reported is the number of cars per lane.

BART

Level Of Service Computation Report  
2000 HCM Operations (Future Volume Alternative)  
AM - Existing Conditions

Intersection #5332: CENTRAL EXPWY/SCOTT BLVD [Study Int 28]

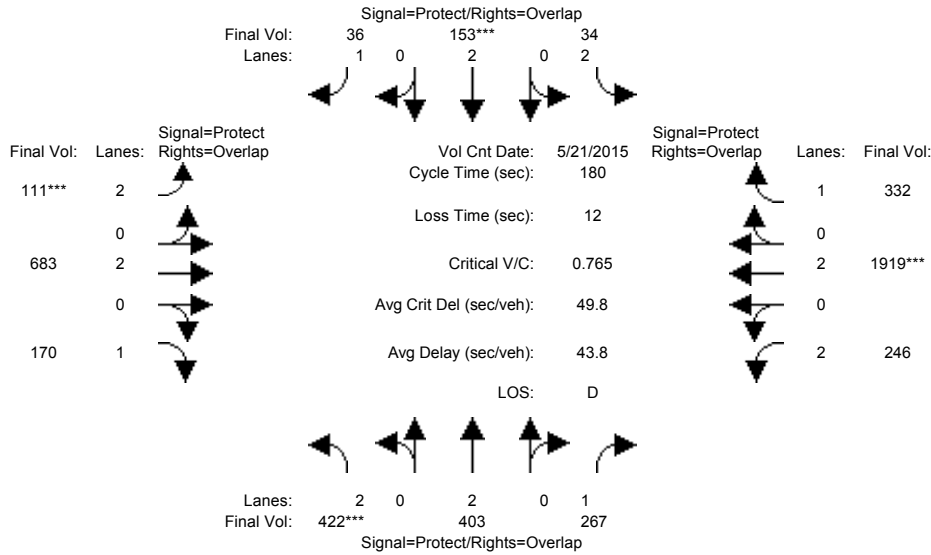

| Approach:  | North Bound |      |      | South Bound |      |      | East Bound |      |       | West Bound |      |       |
|--|-------------|------|------|-------------|------|------|------------|------|-------|------------|------|-------|
| Movement:  | L           | T    | R    | L           | T    | R    | L          | T    | R     | L          | T    | R     |
| Min. Green:  | 14          | 10   | 10   | 14          | 10   | 10   | 14         | 10   | 10    | 14         | 90   | 10    |
| Y+R:   | 4.0         | 4.0  | 4.0  | 4.0         | 4.0  | 4.0  | 4.0        | 4.0  | 4.0   | 4.0        | 4.0  | 4.0   |
| Volume Module: >> Count Date: 21 May 2015 << 5:00-6:00PM |             |      |      |             |      |      |            |      |       |            |      |       |
| Base Vol:  | 422         | 403  | 267  | 34          | 153  | 36   | 111        | 785  | 170   | 246        | 2156 | 332   |
| Growth Adj:  | 1.00        | 1.00 | 1.00 | 1.00        | 1.00 | 1.00 | 1.00       | 1.00 | 1.00  | 1.00       | 1.00 | 1.00  |
| Initial Bse:   | 422         | 403  | 267  | 34          | 153  | 36   | 111        | 785  | 170   | 246        | 2156 | 332   |
| Added Vol:   | 0           | 0    | 0    | 0           | 0    | 0    | 0          | 0    | 0     | 0          | 0    | 0     |
| PasserByVol:   | 0           | 0    | 0    | 0           | 0    | 0    | 0          | 0    | 0     | 0          | 0    | 0     |
| Initial Fut:   | 422         | 403  | 267  | 34          | 153  | 36   | 111        | 785  | 170   | 246        | 2156 | 332   |
| User Adj:  | 1.00        | 1.00 | 1.00 | 1.00        | 1.00 | 1.00 | 1.00       | 0.87 | 1.00  | 1.00       | 0.89 | 1.00  |
| PHF Adj:   | 1.00        | 1.00 | 1.00 | 1.00        | 1.00 | 1.00 | 1.00       | 1.00 | 1.00  | 1.00       | 1.00 | 1.00  |
| PHF Volume:  | 422         | 403  | 267  | 34          | 153  | 36   | 111        | 683  | 170   | 246        | 1919 | 332   |
| Reduct Vol:  | 0           | 0    | 0    | 0           | 0    | 0    | 0          | 0    | 0     | 0          | 0    | 0     |
| Reduced Vol:   | 422         | 403  | 267  | 34          | 153  | 36   | 111        | 683  | 170   | 246        | 1919 | 332   |
| PCE Adj:   | 1.00        | 1.00 | 1.00 | 1.00        | 1.00 | 1.00 | 1.00       | 1.00 | 1.00  | 1.00       | 1.00 | 1.00  |
| MLF Adj:   | 1.00        | 1.00 | 1.00 | 1.00        | 1.00 | 1.00 | 1.00       | 1.00 | 1.00  | 1.00       | 1.00 | 1.00  |
| Final Volume:  | 422         | 403  | 267  | 34          | 153  | 36   | 111        | 683  | 170   | 246        | 1919 | 332   |
| Saturation Flow Module:                                  |             |      |      |             |      |      |            |      |       |            |      |       |
| Sat/Lane:  | 1900        | 1900 | 1900 | 1900        | 1900 | 1900 | 1900       | 1900 | 1900  | 1900       | 1900 | 1900  |
| Adjustment:  | 0.83        | 1.00 | 0.92 | 0.83        | 1.00 | 0.92 | 0.83       | 1.00 | 0.92  | 0.83       | 1.00 | 0.92  |
| Lanes:   | 2.00        | 2.00 | 1.00 | 2.00        | 2.00 | 1.00 | 2.00       | 2.00 | 1.00  | 2.00       | 2.00 | 1.00  |
| Final Sat.:  | 3150        | 3800 | 1750 | 3150        | 3800 | 1750 | 3150       | 3800 | 1750  | 3150       | 3800 | 1750  |
| Capacity Analysis Module:                                |             |      |      |             |      |      |            |      |       |            |      |       |
| Vol/Sat:   | 0.13        | 0.11 | 0.15 | 0.01        | 0.04 | 0.02 | 0.04       | 0.18 | 0.10  | 0.08       | 0.50 | 0.19  |
| Crit Moves:  | ****        |      |      | ****        |      |      | ****       |      |       | ****       |      |       |
| Green Time:  | 30.2        | 23.2 | 61.9 | 17.0        | 10.0 | 24.0 | 14.0       | 89.1 | 119.3 | 38.7       | 114  | 130.8 |
| Volume/Cap:  | 0.80        | 0.82 | 0.44 | 0.11        | 0.72 | 0.15 | 0.45       | 0.36 | 0.15  | 0.36       | 0.80 | 0.26  |
| Delay/Veh:   | 80.4        | 87.2 | 46.2 | 74.8        | 95.4 | 69.3 | 76.2       | 9.8  | 0.1   | 61.4       | 37.9 | 14.7  |
| User DelAdj:   | 1.00        | 1.00 | 1.00 | 1.00        | 1.00 | 1.00 | 1.00       | 1.00 | 1.00  | 1.00       | 1.00 | 1.00  |
| AdjDel/Veh:  | 80.4        | 87.2 | 46.2 | 74.8        | 95.4 | 69.3 | 76.2       | 9.8  | 0.1   | 61.4       | 37.9 | 14.7  |
| LOS by Move:   | F           | F    | D    | E           | F    | E    | E          | A    | A     | E          | D    | B     |
| HCM2k95thQ:  | 25          | 21   | 23   | 2           | 9    | 4    | 8          | 9    | 0     | 13         | 68   | 20    |

Note: Queue reported is the number of cars per lane.



BART

Level Of Service Computation Report  
 2000 HCM Operations (Future Volume Alternative)  
 PM - Existing Conditions

Intersection #5332: CENTRAL EXPWY/SCOTT BLVD [Study Int 28]

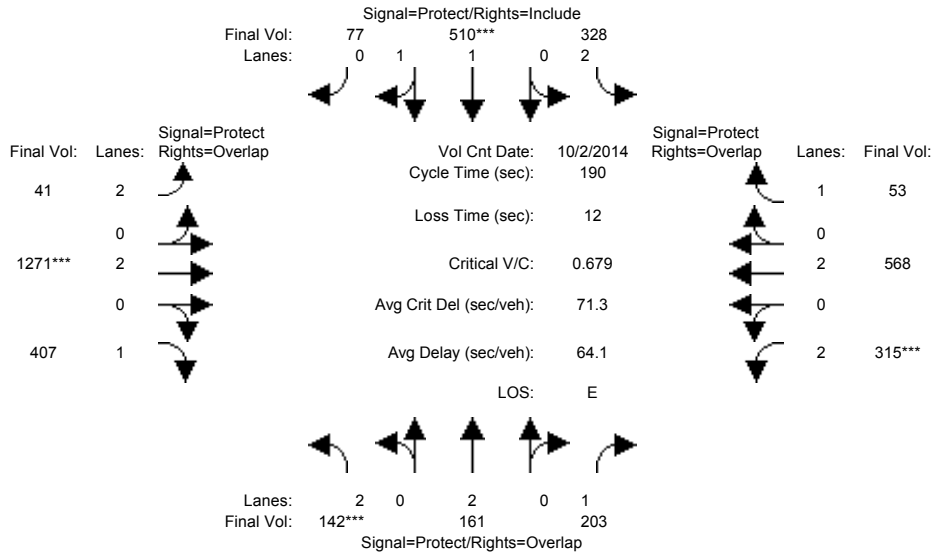

| Approach:   | North Bound |      |      | South Bound |      |       | East Bound |      |       | West Bound |      |       |
|---|-------------|------|------|-------------|------|-------|------------|------|-------|------------|------|-------|
| Movement:   | L           | T    | R    | L           | T    | R     | L          | T    | R     | L          | T    | R     |
| Min. Green:   | 28          | 42   | 42   | 20          | 34   | 34    | 19         | 105  | 105   | 23         | 109  | 109   |
| Y+R:  | 4.0         | 4.0  | 4.0  | 4.0         | 4.0  | 4.0   | 4.0        | 4.0  | 4.0   | 4.0        | 4.0  | 4.0   |
| Volume Module: >> Count Date: 2 Oct 2014 << 5:15-6:15PM |             |      |      |             |      |       |            |      |       |            |      |       |
| Base Vol:   | 142         | 161  | 203  | 328         | 510  | 77    | 41         | 2321 | 407   | 315        | 734  | 53    |
| Growth Adj:   | 1.00        | 1.00 | 1.00 | 1.00        | 1.00 | 1.00  | 1.00       | 0.74 | 1.00  | 1.00       | 0.88 | 1.00  |
| Initial Bse:  | 142         | 161  | 203  | 328         | 510  | 77    | 41         | 1718 | 407   | 315        | 646  | 53    |
| Added Vol:  | 0           | 0    | 0    | 0           | 0    | 0     | 0          | 0    | 0     | 0          | 0    | 0     |
| PasserByVol:  | 0           | 0    | 0    | 0           | 0    | 0     | 0          | 0    | 0     | 0          | 0    | 0     |
| Initial Fut:  | 142         | 161  | 203  | 328         | 510  | 77    | 41         | 1718 | 407   | 315        | 646  | 53    |
| User Adj:   | 1.00        | 1.00 | 1.00 | 1.00        | 1.00 | 1.00  | 1.00       | 0.74 | 1.00  | 1.00       | 0.88 | 1.00  |
| PHF Adj:  | 1.00        | 1.00 | 1.00 | 1.00        | 1.00 | 1.00  | 1.00       | 1.00 | 1.00  | 1.00       | 1.00 | 1.00  |
| PHF Volume:   | 142         | 161  | 203  | 328         | 510  | 77    | 41         | 1271 | 407   | 315        | 568  | 53    |
| Reduct Vol:   | 0           | 0    | 0    | 0           | 0    | 0     | 0          | 0    | 0     | 0          | 0    | 0     |
| Reduced Vol:  | 142         | 161  | 203  | 328         | 510  | 77    | 41         | 1271 | 407   | 315        | 568  | 53    |
| PCE Adj:  | 1.00        | 1.00 | 1.00 | 1.00        | 1.00 | 1.00  | 1.00       | 1.00 | 1.00  | 1.00       | 1.00 | 1.00  |
| MLF Adj:  | 1.00        | 1.00 | 1.00 | 1.00        | 1.00 | 1.00  | 1.00       | 1.00 | 1.00  | 1.00       | 1.00 | 1.00  |
| Final Volume:   | 142         | 161  | 203  | 328         | 510  | 77    | 41         | 1271 | 407   | 315        | 568  | 53    |
| Saturation Flow Module:                                 |             |      |      |             |      |       |            |      |       |            |      |       |
| Sat/Lane:   | 1900        | 1900 | 1900 | 1900        | 1900 | 1900  | 1900       | 1900 | 1900  | 1900       | 1900 | 1900  |
| Adjustment:   | 0.83        | 1.00 | 0.92 | 0.83        | 0.98 | 0.95  | 0.83       | 1.00 | 0.92  | 0.83       | 1.00 | 0.92  |
| Lanes:  | 2.00        | 2.00 | 1.00 | 2.00        | 1.73 | 0.27  | 2.00       | 2.00 | 1.00  | 2.00       | 2.00 | 1.00  |
| Final Sat.:   | 3150        | 3800 | 1750 | 3150        | 3214 | 485   | 3150       | 3800 | 1750  | 3150       | 3800 | 1750  |
| Capacity Analysis Module:                               |             |      |      |             |      |       |            |      |       |            |      |       |
| Vol/Sat:  | 0.05        | 0.04 | 0.12 | 0.10        | 0.16 | 0.16  | 0.01       | 0.33 | 0.23  | 0.10       | 0.15 | 0.03  |
| Crit Moves:   | ****        |      |      | ****        |      |       | ****       |      |       | ****       |      |       |
| Green Time:   | 26.3        | 39.5 | 61.1 | 18.8        | 32.0 | 32.0  | 17.9       | 98.8 | 125.1 | 21.6       | 103  | 121.3 |
| Volume/Cap:   | 0.33        | 0.20 | 0.36 | 1.05        | 0.94 | 0.94  | 0.14       | 0.64 | 0.35  | 0.88       | 0.28 | 0.05  |
| Delay/Veh:  | 78.9        | 66.3 | 53.0 | 156.2       | 106  | 105.9 | 84.2       | 45.0 | 23.6  | 109.2      | 17.7 | 6.4   |
| User DelAdj:  | 1.00        | 1.00 | 1.00 | 1.00        | 1.00 | 1.00  | 1.00       | 1.00 | 1.00  | 1.00       | 1.00 | 1.00  |
| AdjDel/Veh:   | 78.9        | 66.3 | 53.0 | 156.2       | 106  | 105.9 | 84.2       | 45.0 | 23.6  | 109.2      | 17.7 | 6.4   |
| LOS by Move:  | E           | E    | D    | F           | F    | F     | F          | D    | C     | F          | B    | A     |
| HCM2k95thQ:   | 9           | 8    | 18   | 26          | 34   | 34    | 3          | 51   | 29    | 22         | 12   | 1     |

Note: Queue reported is the number of cars per lane.

BART

Level Of Service Computation Report  
2000 HCM Operations (Future Volume Alternative)  
AM - Existing Conditions

Intersection #5334: CENTRAL EXPWY/LAFAYETTE ST [Study Int 29]

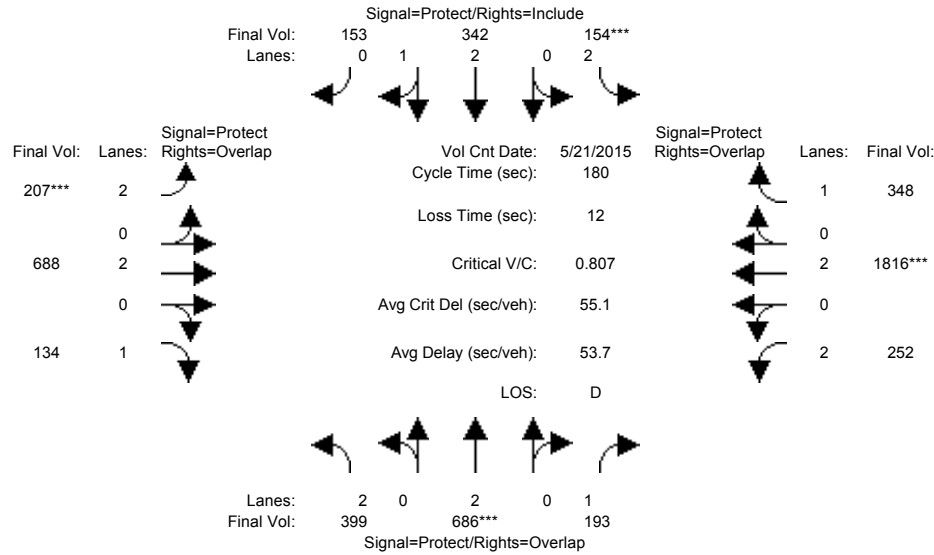

| Approach:  | North Bound |      |      | South Bound |      |      | East Bound |      |       | West Bound |      |       |
|--|-------------|------|------|-------------|------|------|------------|------|-------|------------|------|-------|
| Movement:  | L           | T    | R    | L           | T    | R    | L          | T    | R     | L          | T    | R     |
| Min. Green:  | 14          | 10   | 10   | 14          | 10   | 10   | 14         | 10   | 10    | 14         | 90   | 10    |
| Y+R:   | 4.0         | 4.0  | 4.0  | 4.0         | 4.0  | 4.0  | 4.0        | 4.0  | 4.0   | 4.0        | 4.0  | 4.0   |
| Volume Module: >> Count Date: 21 May 2015 << 7:00-9:00 |             |      |      |             |      |      |            |      |       |            |      |       |
| Base Vol:  | 399         | 686  | 193  | 154         | 342  | 153  | 207        | 791  | 134   | 252        | 2041 | 348   |
| Growth Adj:  | 1.00        | 1.00 | 1.00 | 1.00        | 1.00 | 1.00 | 1.00       | 1.00 | 1.00  | 1.00       | 1.00 | 1.00  |
| Initial Bse:   | 399         | 686  | 193  | 154         | 342  | 153  | 207        | 791  | 134   | 252        | 2041 | 348   |
| Added Vol:   | 0           | 0    | 0    | 0           | 0    | 0    | 0          | 0    | 0     | 0          | 0    | 0     |
| PasserByVol:   | 0           | 0    | 0    | 0           | 0    | 0    | 0          | 0    | 0     | 0          | 0    | 0     |
| Initial Fut:   | 399         | 686  | 193  | 154         | 342  | 153  | 207        | 791  | 134   | 252        | 2041 | 348   |
| User Adj:  | 1.00        | 1.00 | 1.00 | 1.00        | 1.00 | 1.00 | 1.00       | 0.87 | 1.00  | 1.00       | 0.89 | 1.00  |
| PHF Adj:   | 1.00        | 1.00 | 1.00 | 1.00        | 1.00 | 1.00 | 1.00       | 1.00 | 1.00  | 1.00       | 1.00 | 1.00  |
| PHF Volume:  | 399         | 686  | 193  | 154         | 342  | 153  | 207        | 688  | 134   | 252        | 1816 | 348   |
| Reduct Vol:  | 0           | 0    | 0    | 0           | 0    | 0    | 0          | 0    | 0     | 0          | 0    | 0     |
| Reduced Vol:   | 399         | 686  | 193  | 154         | 342  | 153  | 207        | 688  | 134   | 252        | 1816 | 348   |
| PCE Adj:   | 1.00        | 1.00 | 1.00 | 1.00        | 1.00 | 1.00 | 1.00       | 1.00 | 1.00  | 1.00       | 1.00 | 1.00  |
| MLF Adj:   | 1.00        | 1.00 | 1.00 | 1.00        | 1.00 | 1.00 | 1.00       | 1.00 | 1.00  | 1.00       | 1.00 | 1.00  |
| Final Volume:  | 399         | 686  | 193  | 154         | 342  | 153  | 207        | 688  | 134   | 252        | 1816 | 348   |
| Saturation Flow Module:                                |             |      |      |             |      |      |            |      |       |            |      |       |
| Sat/Lane:  | 1900        | 1900 | 1900 | 1900        | 1900 | 1900 | 1900       | 1900 | 1900  | 1900       | 1900 | 1900  |
| Adjustment:  | 1.00        | 1.00 | 1.00 | 1.00        | 1.00 | 1.00 | 1.00       | 0.85 | 1.00  | 1.00       | 1.00 | 1.00  |
| Lanes:   | 2.00        | 2.00 | 1.00 | 2.00        | 2.07 | 0.93 | 2.00       | 2.00 | 1.00  | 2.00       | 2.00 | 1.00  |
| Final Sat.:  | 3800        | 3800 | 1900 | 3800        | 3938 | 1762 | 3800       | 3230 | 1900  | 3800       | 3800 | 1900  |
| Capacity Analysis Module:                              |             |      |      |             |      |      |            |      |       |            |      |       |
| Vol/Sat:   | 0.11        | 0.18 | 0.10 | 0.04        | 0.09 | 0.09 | 0.05       | 0.21 | 0.07  | 0.07       | 0.48 | 0.18  |
| Crit Moves:  | ****        | **** | **** | ****        | **** | **** | ****       | **** | ****  | ****       | **** | ****  |
| Green Time:  | 28.7        | 38.4 | 69.3 | 14.0        | 23.7 | 23.7 | 14.0       | 84.7 | 113.4 | 30.9       | 102  | 115.6 |
| Volume/Cap:  | 0.66        | 0.85 | 0.26 | 0.52        | 0.66 | 0.66 | 0.70       | 0.45 | 0.11  | 0.39       | 0.85 | 0.29  |
| Delay/Veh:   | 82.7        | 88.5 | 53.9 | 85.9        | 84.0 | 84.0 | 88.3       | 32.3 | 13.3  | 66.5       | 36.0 | 14.2  |
| User DelAdj:   | 1.00        | 1.00 | 1.00 | 1.00        | 1.00 | 1.00 | 1.00       | 1.00 | 1.00  | 1.00       | 1.00 | 1.00  |
| AdjDel/Veh:  | 82.7        | 88.5 | 53.9 | 85.9        | 84.0 | 84.0 | 88.3       | 32.3 | 13.3  | 66.5       | 36.0 | 14.2  |
| LOS by Move:   | F           | F    | D    | F           | F    | F    | F          | C    | B     | E          | D    | B     |
| HCM2k95thQ:  | 19          | 33   | 17   | 8           | 17   | 17   | 11         | 22   | 6     | 12         | 72   | 21    |

Note: Queue reported is the number of cars per lane.

BART

Level Of Service Computation Report  
 2000 HCM Operations (Future Volume Alternative)  
 PM - Existing Conditions

Intersection #5334: CENTRAL EXPWY/LAFAYETTE ST [Study Int 29]

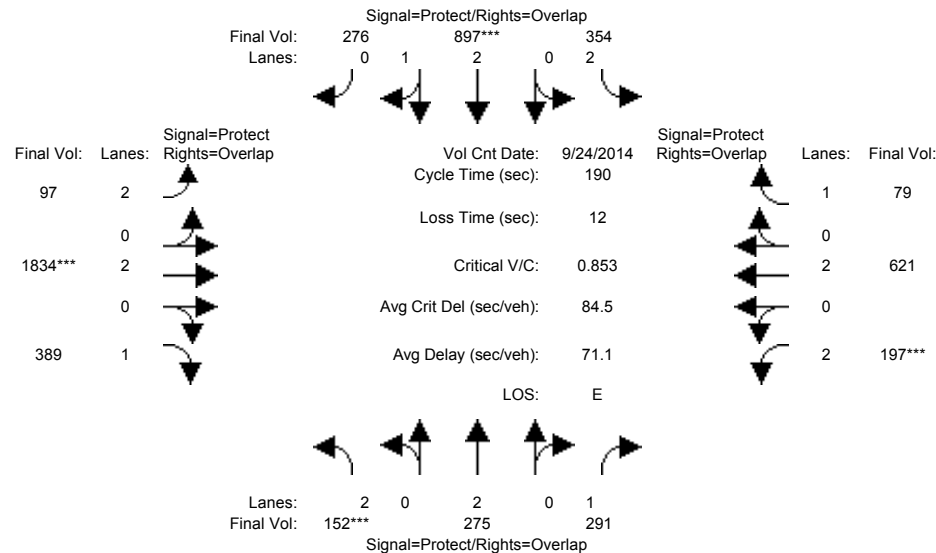

| Approach:  | North Bound |      |      | South Bound |      |      | East Bound |      |       | West Bound |      |       |
|--|-------------|------|------|-------------|------|------|------------|------|-------|------------|------|-------|
| Movement:  | L           | T    | R    | L           | T    | R    | L          | T    | R     | L          | T    | R     |
| Min. Green:  | 18          | 35   | 35   | 23          | 39   | 39   | 19         | 112  | 112   | 21         | 113  | 113   |
| Y+R:   | 4.0         | 4.0  | 4.0  | 4.0         | 4.0  | 4.0  | 4.0        | 4.0  | 4.0   | 4.0        | 4.0  | 4.0   |
| Volume Module: >> Count Date: 24 Sep 2014 << 5:00-6:00PM |             |      |      |             |      |      |            |      |       |            |      |       |
| Base Vol:  | 152         | 275  | 291  | 354         | 897  | 276  | 97         | 2478 | 389   | 197        | 706  | 79    |
| Growth Adj:  | 1.00        | 1.00 | 1.00 | 1.00        | 1.00 | 1.00 | 1.00       | 1.00 | 1.00  | 1.00       | 1.00 | 1.00  |
| Initial Bse:   | 152         | 275  | 291  | 354         | 897  | 276  | 97         | 2478 | 389   | 197        | 706  | 79    |
| Added Vol:   | 0           | 0    | 0    | 0           | 0    | 0    | 0          | 0    | 0     | 0          | 0    | 0     |
| PasserByVol:   | 0           | 0    | 0    | 0           | 0    | 0    | 0          | 0    | 0     | 0          | 0    | 0     |
| Initial Fut:   | 152         | 275  | 291  | 354         | 897  | 276  | 97         | 2478 | 389   | 197        | 706  | 79    |
| User Adj:  | 1.00        | 1.00 | 1.00 | 1.00        | 1.00 | 1.00 | 1.00       | 0.74 | 1.00  | 1.00       | 0.88 | 1.00  |
| PHF Adj:   | 1.00        | 1.00 | 1.00 | 1.00        | 1.00 | 1.00 | 1.00       | 1.00 | 1.00  | 1.00       | 1.00 | 1.00  |
| PHF Volume:  | 152         | 275  | 291  | 354         | 897  | 276  | 97         | 1834 | 389   | 197        | 621  | 79    |
| Reduct Vol:  | 0           | 0    | 0    | 0           | 0    | 0    | 0          | 0    | 0     | 0          | 0    | 0     |
| Reduced Vol:   | 152         | 275  | 291  | 354         | 897  | 276  | 97         | 1834 | 389   | 197        | 621  | 79    |
| PCE Adj:   | 1.00        | 1.00 | 1.00 | 1.00        | 1.00 | 1.00 | 1.00       | 1.00 | 1.00  | 1.00       | 1.00 | 1.00  |
| MLF Adj:   | 1.00        | 1.00 | 1.00 | 1.00        | 1.00 | 1.00 | 1.00       | 1.00 | 1.00  | 1.00       | 1.00 | 1.00  |
| Final Volume:  | 152         | 275  | 291  | 354         | 897  | 276  | 97         | 1834 | 389   | 197        | 621  | 79    |
| Saturation Flow Module:                                  |             |      |      |             |      |      |            |      |       |            |      |       |
| Sat/Lane:  | 1900        | 1900 | 1900 | 1900        | 1900 | 1900 | 1900       | 1900 | 1900  | 1900       | 1900 | 1900  |
| Adjustment:  | 0.83        | 1.00 | 0.92 | 0.83        | 0.99 | 0.95 | 0.83       | 1.00 | 0.92  | 0.83       | 1.00 | 0.92  |
| Lanes:   | 2.00        | 2.00 | 1.00 | 2.00        | 2.27 | 0.73 | 2.00       | 2.00 | 1.00  | 2.00       | 2.00 | 1.00  |
| Final Sat.:  | 3150        | 3800 | 1750 | 3150        | 4281 | 1317 | 3150       | 3800 | 1750  | 3150       | 3800 | 1750  |
| Capacity Analysis Module:                                |             |      |      |             |      |      |            |      |       |            |      |       |
| Vol/Sat:   | 0.05        | 0.07 | 0.17 | 0.11        | 0.21 | 0.21 | 0.03       | 0.48 | 0.22  | 0.06       | 0.16 | 0.05  |
| Crit Moves:  | ****        |      |      | ****        |      |      | ****       |      |       | ****       |      |       |
| Green Time:  | 16.8        | 32.8 | 52.4 | 21.5        | 37.4 | 55.4 | 17.9       | 105  | 121.7 | 19.7       | 107  | 128.1 |
| Volume/Cap:  | 0.54        | 0.42 | 0.60 | 0.99        | 1.06 | 0.72 | 0.33       | 0.87 | 0.35  | 0.60       | 0.29 | 0.07  |
| Delay/Veh:   | 90.8        | 75.4 | 66.0 | 135.3       | 127  | 66.1 | 86.5       | 56.1 | 25.2  | 90.2       | 23.5 | 11.3  |
| User DelAdj:   | 1.00        | 1.00 | 1.00 | 1.00        | 1.00 | 1.00 | 1.00       | 1.00 | 1.00  | 1.00       | 1.00 | 1.00  |
| AdjDel/Veh:  | 90.8        | 75.4 | 66.0 | 135.3       | 127  | 66.1 | 86.5       | 56.1 | 25.2  | 90.2       | 23.5 | 11.3  |
| LOS by Move:   | F           | E    | E    | F           | F    | E    | F          | E    | C     | F          | C    | B     |
| HCM2k95thQ:  | 10          | 14   | 29   | 27          | 48   | 37   | 7          | 81   | 29    | 13         | 18   | 4     |

Note: Queue reported is the number of cars per lane.

BART

Level Of Service Computation Report  
 2000 HCM Operations (Future Volume Alternative)  
 AM - Existing Conditions

Intersection #5335: CENTRAL EXPWY/DE LA CRUZ BLVD [Study Int 30]

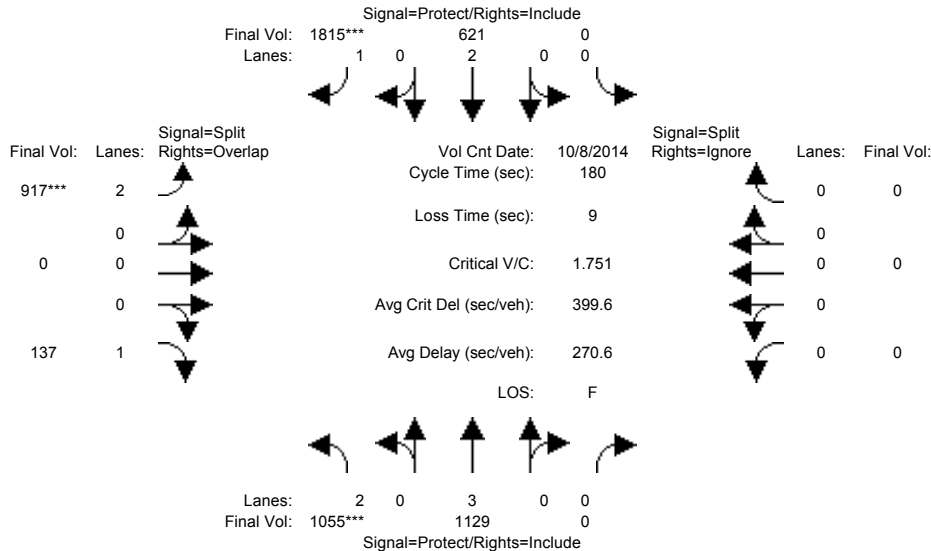

| Approach:                                   | North Bound |      |      | South Bound |      |       | East Bound |      |      | West Bound |      |      |
|---|-------------|------|------|-------------|------|-------|------------|------|------|------------|------|------|
| Movement:                                   | L           | T    | R    | L           | T    | R     | L          | T    | R    | L          | T    | R    |
| Min. Green:                                 | 7           | 10   | 0    | 0           | 10   | 10    | 10         | 0    | 10   | 0          | 0    | 0    |
| Y+R:  | 4.0         | 4.0  | 4.0  | 4.0         | 4.0  | 4.0   | 4.0        | 4.0  | 4.0  | 4.0        | 4.0  | 4.0  |
| Volume Module: >> Count Date: 8 Oct 2014 << |             |      |      |             |      |       |            |      |      |            |      |      |
| Base Vol:                                   | 1055        | 1129 | 0    | 0           | 621  | 1815  | 1054       | 0    | 137  | 0          | 0    | 0    |
| Growth Adj:                                 | 1.00        | 1.00 | 1.00 | 1.00        | 1.00 | 1.00  | 1.00       | 1.00 | 1.00 | 1.00       | 1.00 | 1.00 |
| Initial Bse:                                | 1055        | 1129 | 0    | 0           | 621  | 1815  | 1054       | 0    | 137  | 0          | 0    | 0    |
| Added Vol:                                  | 0           | 0    | 0    | 0           | 0    | 0     | 0          | 0    | 0    | 0          | 0    | 0    |
| PasserByVol:                                | 0           | 0    | 0    | 0           | 0    | 0     | 0          | 0    | 0    | 0          | 0    | 0    |
| Initial Fut:                                | 1055        | 1129 | 0    | 0           | 621  | 1815  | 1054       | 0    | 137  | 0          | 0    | 0    |
| User Adj:                                   | 1.00        | 1.00 | 1.00 | 1.00        | 1.00 | 1.00  | 0.87       | 1.00 | 1.00 | 1.00       | 1.00 | 0.00 |
| PHF Adj:                                    | 1.00        | 1.00 | 1.00 | 1.00        | 1.00 | 1.00  | 1.00       | 1.00 | 1.00 | 1.00       | 1.00 | 0.00 |
| PHF Volume:                                 | 1055        | 1129 | 0    | 0           | 621  | 1815  | 917        | 0    | 137  | 0          | 0    | 0    |
| Reduct Vol:                                 | 0           | 0    | 0    | 0           | 0    | 0     | 0          | 0    | 0    | 0          | 0    | 0    |
| Reduced Vol:                                | 1055        | 1129 | 0    | 0           | 621  | 1815  | 917        | 0    | 137  | 0          | 0    | 0    |
| PCE Adj:                                    | 1.00        | 1.00 | 1.00 | 1.00        | 1.00 | 1.00  | 1.00       | 1.00 | 1.00 | 1.00       | 1.00 | 0.00 |
| MLF Adj:                                    | 1.00        | 1.00 | 1.00 | 1.00        | 1.00 | 1.00  | 1.00       | 1.00 | 1.00 | 1.00       | 1.00 | 0.00 |
| Final Volume:                               | 1055        | 1129 | 0    | 0           | 621  | 1815  | 917        | 0    | 137  | 0          | 0    | 0    |
| Saturation Flow Module:                     |             |      |      |             |      |       |            |      |      |            |      |      |
| Sat/Lane:                                   | 1900        | 1900 | 1900 | 1900        | 1900 | 1900  | 1900       | 1900 | 1900 | 1900       | 1900 | 1900 |
| Adjustment:                                 | 0.83        | 1.00 | 0.92 | 0.92        | 1.00 | 0.92  | 0.83       | 1.00 | 0.92 | 0.92       | 1.00 | 0.92 |
| Lanes:                                      | 2.00        | 3.00 | 0.00 | 0.00        | 2.00 | 1.00  | 2.00       | 0.00 | 1.00 | 0.00       | 0.00 | 0.00 |
| Final Sat.:                                 | 3150        | 5700 | 0    | 0           | 3800 | 1750  | 3150       | 0    | 1750 | 0          | 0    | 0    |
| Capacity Analysis Module:                   |             |      |      |             |      |       |            |      |      |            |      |      |
| Vol/Sat:                                    | 0.33        | 0.20 | 0.00 | 0.00        | 0.16 | 1.04  | 0.29       | 0.00 | 0.08 | 0.00       | 0.00 | 0.00 |
| Crit Moves:                                 | ****        |      |      |             |      | ****  | ****       |      |      |            |      |      |
| Green Time:                                 | 34.4        | 141  | 0.0  | 0.0         | 107  | 106.6 | 29.9       | 0.0  | 64.4 | 0.0        | 0.0  | 0.0  |
| Volume/Cap:                                 | 1.75        | 0.25 | 0.00 | 0.00        | 0.28 | 1.75  | 1.75       | 0.00 | 0.22 | 0.00       | 0.00 | 0.00 |
| Delay/Veh:                                  | 417.4       | 5.3  | 0.0  | 0.0         | 17.9 | 378.5 | 420.7      | 0.0  | 37.9 | 0.0        | 0.0  | 0.0  |
| User DelAdj:                                | 1.00        | 1.00 | 1.00 | 1.00        | 1.00 | 1.00  | 1.00       | 1.00 | 1.00 | 1.00       | 1.00 | 1.00 |
| AdjDel/Veh:                                 | 417.4       | 5.3  | 0.0  | 0.0         | 17.9 | 378.5 | 420.7      | 0.0  | 37.9 | 0.0        | 0.0  | 0.0  |
| LOS by Move:                                | F           | A    | A    | A           | B    | F     | F          | A    | D    | A          | A    | A    |
| HCM2k95thQ:                                 | 102         | 11   | 0    | 0           | 15   | 310   | 89         | 0    | 9    | 0          | 0    | 0    |

Note: Queue reported is the number of cars per lane.

BART

Level Of Service Computation Report  
 2000 HCM Operations (Future Volume Alternative)  
 PM - Existing Conditions

Intersection #5335: CENTRAL EXPWY/DE LA CRUZ BLVD [Study Int 30]

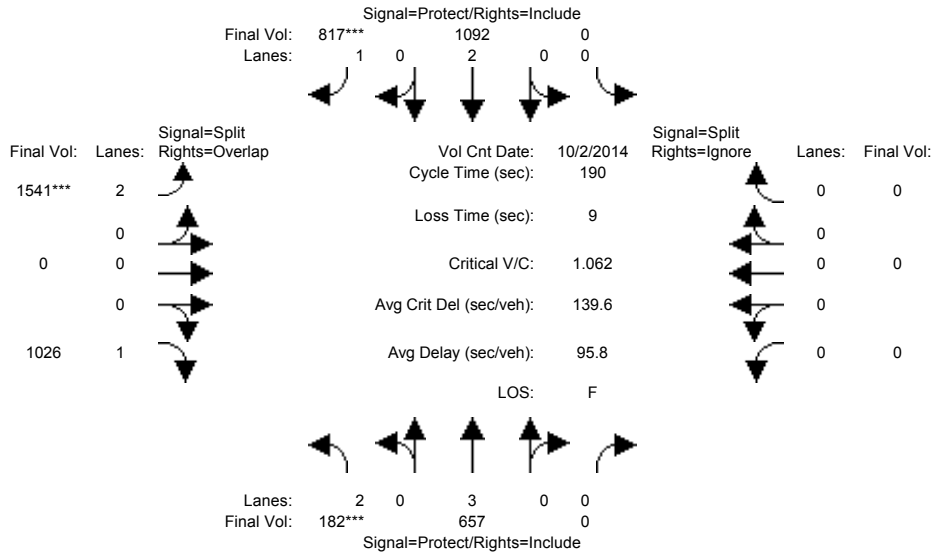

| Approach:                                   | North Bound |      |      | South Bound |      |       | East Bound |      |       | West Bound |      |      |
|---|-------------|------|------|-------------|------|-------|------------|------|-------|------------|------|------|
| Movement:                                   | L           | T    | R    | L           | T    | R     | L          | T    | R     | L          | T    | R    |
| Min. Green:                                 | 19          | 76   | 0    | 0           | 57   | 57    | 114        | 0    | 114   | 0          | 0    | 0    |
| Y+R:  | 4.0         | 4.0  | 4.0  | 4.0         | 4.0  | 4.0   | 4.0        | 4.0  | 4.0   | 4.0        | 4.0  | 4.0  |
| -----                                       |             |      |      |             |      |       |            |      |       |            |      |      |
| Volume Module: >> Count Date: 2 Oct 2014 << |             |      |      |             |      |       |            |      |       |            |      |      |
| Base Vol:                                   | 182         | 657  | 0    | 0           | 1092 | 817   | 2083       | 0    | 1026  | 0          | 0    | 0    |
| Growth Adj:                                 | 1.00        | 1.00 | 1.00 | 1.00        | 1.00 | 1.00  | 1.00       | 1.00 | 1.00  | 1.00       | 1.00 | 1.00 |
| Initial Bse:                                | 182         | 657  | 0    | 0           | 1092 | 817   | 2083       | 0    | 1026  | 0          | 0    | 0    |
| Added Vol:                                  | 0           | 0    | 0    | 0           | 0    | 0     | 0          | 0    | 0     | 0          | 0    | 0    |
| PasserByVol:                                | 0           | 0    | 0    | 0           | 0    | 0     | 0          | 0    | 0     | 0          | 0    | 0    |
| Initial Fut:                                | 182         | 657  | 0    | 0           | 1092 | 817   | 2083       | 0    | 1026  | 0          | 0    | 0    |
| User Adj:                                   | 1.00        | 1.00 | 1.00 | 1.00        | 1.00 | 1.00  | 0.74       | 1.00 | 1.00  | 1.00       | 1.00 | 0.00 |
| PHF Adj:                                    | 1.00        | 1.00 | 1.00 | 1.00        | 1.00 | 1.00  | 1.00       | 1.00 | 1.00  | 1.00       | 1.00 | 0.00 |
| PHF Volume:                                 | 182         | 657  | 0    | 0           | 1092 | 817   | 1541       | 0    | 1026  | 0          | 0    | 0    |
| Reduct Vol:                                 | 0           | 0    | 0    | 0           | 0    | 0     | 0          | 0    | 0     | 0          | 0    | 0    |
| Reduced Vol:                                | 182         | 657  | 0    | 0           | 1092 | 817   | 1541       | 0    | 1026  | 0          | 0    | 0    |
| PCE Adj:                                    | 1.00        | 1.00 | 1.00 | 1.00        | 1.00 | 1.00  | 1.00       | 1.00 | 1.00  | 1.00       | 1.00 | 0.00 |
| MLF Adj:                                    | 1.00        | 1.00 | 1.00 | 1.00        | 1.00 | 1.00  | 1.00       | 1.00 | 1.00  | 1.00       | 1.00 | 0.00 |
| Final Volume:                               | 182         | 657  | 0    | 0           | 1092 | 817   | 1541       | 0    | 1026  | 0          | 0    | 0    |
| -----                                       |             |      |      |             |      |       |            |      |       |            |      |      |
| Saturation Flow Module:                     |             |      |      |             |      |       |            |      |       |            |      |      |
| Sat/Lane:                                   | 1900        | 1900 | 1900 | 1900        | 1900 | 1900  | 1900       | 1900 | 1900  | 1900       | 1900 | 1900 |
| Adjustment:                                 | 0.83        | 1.00 | 0.92 | 0.92        | 1.00 | 0.92  | 0.83       | 1.00 | 0.92  | 0.92       | 1.00 | 0.92 |
| Lanes:                                      | 2.00        | 3.00 | 0.00 | 0.00        | 2.00 | 1.00  | 2.00       | 0.00 | 1.00  | 0.00       | 0.00 | 0.00 |
| Final Sat.:                                 | 3150        | 5700 | 0    | 0           | 3800 | 1750  | 3150       | 0    | 1750  | 0          | 0    | 0    |
| -----                                       |             |      |      |             |      |       |            |      |       |            |      |      |
| Capacity Analysis Module:                   |             |      |      |             |      |       |            |      |       |            |      |      |
| Vol/Sat:                                    | 0.06        | 0.12 | 0.00 | 0.00        | 0.29 | 0.47  | 0.49       | 0.00 | 0.59  | 0.00       | 0.00 | 0.00 |
| Crit Moves:                                 | ****        |      |      |             | **** | ****  |            |      |       |            |      |      |
| Green Time:                                 | 18.1        | 72.6 | 0.0  | 0.0         | 54.4 | 54.4  | 108.8      | 0.0  | 127.0 | 0.0        | 0.0  | 0.0  |
| Volume/Cap:                                 | 0.61        | 0.30 | 0.00 | 0.00        | 1.00 | 1.63  | 0.85       | 0.00 | 0.88  | 0.00       | 0.00 | 0.00 |
| Delay/Veh:                                  | 89.9        | 43.0 | 0.0  | 0.0         | 99.1 | 363.5 | 26.8       | 0.0  | 17.7  | 0.0        | 0.0  | 0.0  |
| User DelAdj:                                | 1.00        | 1.00 | 1.00 | 1.00        | 1.00 | 1.00  | 1.00       | 1.00 | 1.00  | 1.00       | 1.00 | 1.00 |
| AdjDel/Veh:                                 | 89.9        | 43.0 | 0.0  | 0.0         | 99.1 | 363.5 | 26.8       | 0.0  | 17.7  | 0.0        | 0.0  | 0.0  |
| LOS by Move:                                | F           | D    | A    | A           | F    | F     | C          | A    | B     | A          | A    | A    |
| HCM2k95thQ:                                 | 12          | 17   | 0    | 0           | 59   | 141   | 59         | 0    | 54    | 0          | 0    | 0    |

Note: Queue reported is the number of cars per lane.

BART

Level Of Service Computation Report  
2000 HCM Operations (Future Volume Alternative)  
AM - Existing Conditions

Intersection #5416: SAN TOMAS EXPWY/EL CAMINO REAL [Study Int 41]

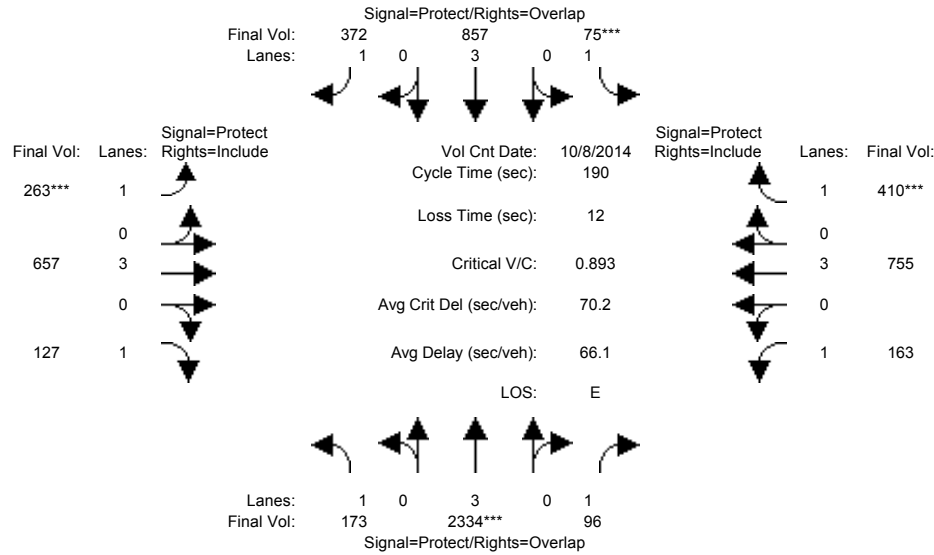

| Approach:                                   | North Bound |      |       | South Bound |      |      | East Bound |      |      | West Bound |      |      |
|---|-------------|------|-------|-------------|------|------|------------|------|------|------------|------|------|
| Movement:                                   | L           | T    | R     | L           | T    | R    | L          | T    | R    | L          | T    | R    |
| Min. Green:                                 | 7           | 10   | 10    | 7           | 10   | 10   | 7          | 10   | 10   | 7          | 10   | 10   |
| Y+R:  | 4.0         | 4.0  | 4.0   | 4.0         | 4.0  | 4.0  | 4.0        | 4.0  | 4.0  | 4.0        | 4.0  | 4.0  |
| Volume Module: >> Count Date: 8 Oct 2014 << |             |      |       |             |      |      |            |      |      |            |      |      |
| Base Vol:                                   | 173         | 2779 | 96    | 75          | 1020 | 372  | 263        | 657  | 127  | 163        | 755  | 410  |
| Growth Adj:                                 | 1.00        | 1.00 | 1.00  | 1.00        | 1.00 | 1.00 | 1.00       | 1.00 | 1.00 | 1.00       | 1.00 | 1.00 |
| Initial Bse:                                | 173         | 2779 | 96    | 75          | 1020 | 372  | 263        | 657  | 127  | 163        | 755  | 410  |
| Added Vol:                                  | 0           | 0    | 0     | 0           | 0    | 0    | 0          | 0    | 0    | 0          | 0    | 0    |
| PasserByVol:                                | 0           | 0    | 0     | 0           | 0    | 0    | 0          | 0    | 0    | 0          | 0    | 0    |
| Initial Fut:                                | 173         | 2779 | 96    | 75          | 1020 | 372  | 263        | 657  | 127  | 163        | 755  | 410  |
| User Adj:                                   | 1.00        | 0.84 | 1.00  | 1.00        | 0.84 | 1.00 | 1.00       | 1.00 | 1.00 | 1.00       | 1.00 | 1.00 |
| PHF Adj:                                    | 1.00        | 1.00 | 1.00  | 1.00        | 1.00 | 1.00 | 1.00       | 1.00 | 1.00 | 1.00       | 1.00 | 1.00 |
| PHF Volume:                                 | 173         | 2334 | 96    | 75          | 857  | 372  | 263        | 657  | 127  | 163        | 755  | 410  |
| Reduct Vol:                                 | 0           | 0    | 0     | 0           | 0    | 0    | 0          | 0    | 0    | 0          | 0    | 0    |
| Reduced Vol:                                | 173         | 2334 | 96    | 75          | 857  | 372  | 263        | 657  | 127  | 163        | 755  | 410  |
| PCE Adj:                                    | 1.00        | 1.00 | 1.00  | 1.00        | 1.00 | 1.00 | 1.00       | 1.00 | 1.00 | 1.00       | 1.00 | 1.00 |
| MLF Adj:                                    | 1.00        | 1.00 | 1.00  | 1.00        | 1.00 | 1.00 | 1.00       | 1.00 | 1.00 | 1.00       | 1.00 | 1.00 |
| Final Volume:                               | 173         | 2334 | 96    | 75          | 857  | 372  | 263        | 657  | 127  | 163        | 755  | 410  |
| Saturation Flow Module:                     |             |      |       |             |      |      |            |      |      |            |      |      |
| Sat/Lane:                                   | 1900        | 1900 | 1900  | 1900        | 1900 | 1900 | 1900       | 1900 | 1900 | 1900       | 1900 | 1900 |
| Adjustment:                                 | 0.92        | 1.00 | 0.92  | 0.92        | 1.00 | 0.92 | 0.92       | 1.00 | 0.92 | 0.92       | 1.00 | 0.92 |
| Lanes:                                      | 1.00        | 3.00 | 1.00  | 1.00        | 3.00 | 1.00 | 1.00       | 3.00 | 1.00 | 1.00       | 3.00 | 1.00 |
| Final Sat.:                                 | 1750        | 5700 | 1750  | 1750        | 5700 | 1750 | 1750       | 5700 | 1750 | 1750       | 5700 | 1750 |
| Capacity Analysis Module:                   |             |      |       |             |      |      |            |      |      |            |      |      |
| Vol/Sat:                                    | 0.10        | 0.41 | 0.05  | 0.04        | 0.15 | 0.21 | 0.15       | 0.12 | 0.07 | 0.09       | 0.13 | 0.23 |
| Crit Moves:                                 | ****        | **** | ****  | ****        | **** | **** | ****       | **** | **** | ****       | **** | **** |
| Green Time:                                 | 38.2        | 87.1 | 123.7 | 9.1         | 58.0 | 90.0 | 32.0       | 45.2 | 45.2 | 36.6       | 49.8 | 49.8 |
| Volume/Cap:                                 | 0.49        | 0.89 | 0.08  | 0.89        | 0.49 | 0.45 | 0.89       | 0.48 | 0.30 | 0.48       | 0.51 | 0.89 |
| Delay/Veh:                                  | 68.9        | 60.7 | 18.5  | 156.9       | 70.0 | 53.9 | 104.5      | 62.6 | 59.9 | 69.4       | 59.9 | 86.9 |
| User DelAdj:                                | 1.00        | 1.00 | 1.00  | 1.00        | 1.00 | 1.00 | 1.00       | 1.00 | 1.00 | 1.00       | 1.00 | 1.00 |
| AdjDel/Veh:                                 | 68.9        | 60.7 | 18.5  | 156.9       | 70.0 | 53.9 | 104.5      | 62.6 | 59.9 | 69.4       | 59.9 | 86.9 |
| LOS by Move:                                | E           | E    | B     | F           | E    | D    | F          | E    | E    | E          | E    | F    |
| HCM2k95thQ:                                 | 18          | 69   | 7     | 11          | 26   | 34   | 32         | 20   | 12   | 17         | 22   | 43   |

Note: Queue reported is the number of cars per lane.

BART

Level Of Service Computation Report  
2000 HCM Operations (Future Volume Alternative)  
PM - Existing Conditions

Intersection #5416: SAN TOMAS EXPWY/EL CAMINO REAL [Study Int 41]

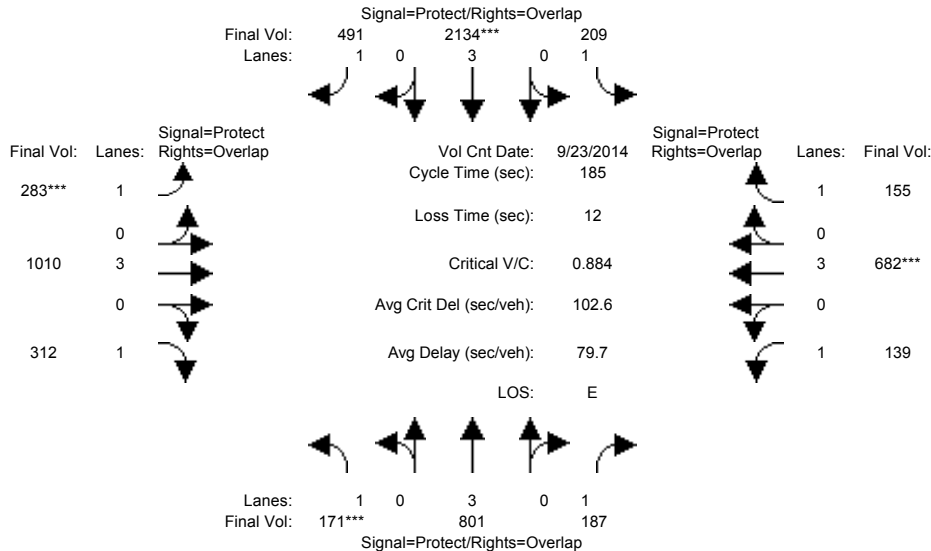

| Approach:   | North Bound |      |      | South Bound |      |       | East Bound |      |      | West Bound |      |      |
|---|-------------|------|------|-------------|------|-------|------------|------|------|------------|------|------|
| Movement:   | L           | T    | R    | L           | T    | R     | L          | T    | R    | L          | T    | R    |
| Min. Green:   | 12          | 72   | 72   | 33          | 93   | 93    | 39         | 50   | 50   | 29         | 41   | 41   |
| Y+R:  | 4.0         | 4.0  | 4.0  | 4.0         | 4.0  | 4.0   | 4.0        | 4.0  | 4.0  | 4.0        | 4.0  | 4.0  |
| ----- ----- ----- ----- ----- ----- ----- ----- ----- ----- ----- ----- ----- |             |      |      |             |      |       |            |      |      |            |      |      |
| Volume Module: >> Count Date: 23 Sep 2014 <<                                  |             |      |      |             |      |       |            |      |      |            |      |      |
| Base Vol:   | 171         | 1054 | 187  | 209         | 2771 | 491   | 283        | 1010 | 312  | 139        | 682  | 155  |
| Growth Adj:   | 1.00        | 1.00 | 1.00 | 1.00        | 1.00 | 1.00  | 1.00       | 1.00 | 1.00 | 1.00       | 1.00 | 1.00 |
| Initial Bse:  | 171         | 1054 | 187  | 209         | 2771 | 491   | 283        | 1010 | 312  | 139        | 682  | 155  |
| Added Vol:  | 0           | 0    | 0    | 0           | 0    | 0     | 0          | 0    | 0    | 0          | 0    | 0    |
| PasserByVol:  | 0           | 0    | 0    | 0           | 0    | 0     | 0          | 0    | 0    | 0          | 0    | 0    |
| Initial Fut:  | 171         | 1054 | 187  | 209         | 2771 | 491   | 283        | 1010 | 312  | 139        | 682  | 155  |
| User Adj:   | 1.00        | 0.76 | 1.00 | 1.00        | 0.77 | 1.00  | 1.00       | 1.00 | 1.00 | 1.00       | 1.00 | 1.00 |
| PHF Adj:  | 1.00        | 1.00 | 1.00 | 1.00        | 1.00 | 1.00  | 1.00       | 1.00 | 1.00 | 1.00       | 1.00 | 1.00 |
| PHF Volume:   | 171         | 801  | 187  | 209         | 2134 | 491   | 283        | 1010 | 312  | 139        | 682  | 155  |
| Reduct Vol:   | 0           | 0    | 0    | 0           | 0    | 0     | 0          | 0    | 0    | 0          | 0    | 0    |
| Reduced Vol:  | 171         | 801  | 187  | 209         | 2134 | 491   | 283        | 1010 | 312  | 139        | 682  | 155  |
| PCE Adj:  | 1.00        | 1.00 | 1.00 | 1.00        | 1.00 | 1.00  | 1.00       | 1.00 | 1.00 | 1.00       | 1.00 | 1.00 |
| MLF Adj:  | 1.00        | 1.00 | 1.00 | 1.00        | 1.00 | 1.00  | 1.00       | 1.00 | 1.00 | 1.00       | 1.00 | 1.00 |
| Final Volume:   | 171         | 801  | 187  | 209         | 2134 | 491   | 283        | 1010 | 312  | 139        | 682  | 155  |
| ----- ----- ----- ----- ----- ----- ----- ----- ----- ----- ----- -----       |             |      |      |             |      |       |            |      |      |            |      |      |
| Saturation Flow Module:   |             |      |      |             |      |       |            |      |      |            |      |      |
| Sat/Lane:   | 1900        | 1900 | 1900 | 1900        | 1900 | 1900  | 1900       | 1900 | 1900 | 1900       | 1900 | 1900 |
| Adjustment:   | 0.92        | 1.00 | 0.92 | 0.92        | 0.83 | 0.92  | 0.92       | 1.00 | 0.92 | 0.92       | 1.00 | 0.92 |
| Lanes:  | 1.00        | 3.00 | 1.00 | 1.00        | 3.00 | 1.00  | 1.00       | 3.00 | 1.00 | 1.00       | 3.00 | 1.00 |
| Final Sat.:   | 1750        | 5700 | 1750 | 1750        | 4731 | 1750  | 1750       | 5700 | 1750 | 1750       | 5700 | 1750 |
| ----- ----- ----- ----- ----- ----- ----- ----- ----- ----- ----- -----       |             |      |      |             |      |       |            |      |      |            |      |      |
| Capacity Analysis Module:   |             |      |      |             |      |       |            |      |      |            |      |      |
| Vol/Sat:  | 0.10        | 0.14 | 0.11 | 0.12        | 0.45 | 0.28  | 0.16       | 0.18 | 0.18 | 0.08       | 0.12 | 0.09 |
| Crit Moves:   | ****        |      |      | ****        |      |       | ****       |      |      | ****       |      |      |
| Green Time:   | 11.3        | 67.6 | 95.2 | 31.0        | 87.3 | 124.0 | 36.6       | 47.5 | 58.8 | 27.6       | 38.5 | 69.5 |
| Volume/Cap:   | 1.60        | 0.38 | 0.21 | 0.71        | 0.96 | 0.42  | 0.82       | 0.69 | 0.56 | 0.53       | 0.57 | 0.24 |
| Delay/Veh:  | 403.6       | 51.3 | 32.8 | 95.9        | 90.3 | 35.3  | 89.6       | 67.5 | 57.1 | 79.6       | 70.9 | 42.3 |
| User DelAdj:  | 1.00        | 1.00 | 1.00 | 1.00        | 1.00 | 1.00  | 1.00       | 1.00 | 1.00 | 1.00       | 1.00 | 1.00 |
| AdjDel/Veh:   | 403.6       | 51.3 | 32.8 | 95.9        | 90.3 | 35.3  | 89.6       | 67.5 | 57.1 | 79.6       | 70.9 | 42.3 |
| LOS by Move:  | F           | D    | C    | F           | F    | D     | F          | E    | E    | E          | E    | D    |
| HCM2k95thQ:   | 33          | 23   | 15   | 24          | 71   | 43    | 33         | 32   | 29   | 15         | 22   | 13   |

BART

Level Of Service Computation Report  
 2000 HCM Operations (Future Volume Alternative)  
 AM - Existing Conditions

Intersection #5444: Lafayette/Lewis [Study Int 47]

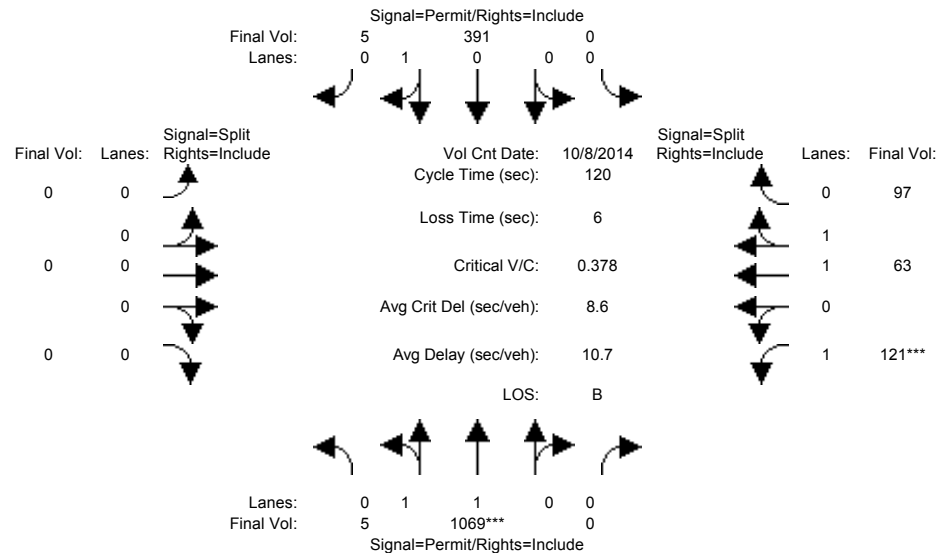

| Approach:                                   | North Bound |      |      | South Bound |      |      | East Bound |      |      | West Bound |      |      |
|---|-------------|------|------|-------------|------|------|------------|------|------|------------|------|------|
| Movement:                                   | L           | T    | R    | L           | T    | R    | L          | T    | R    | L          | T    | R    |
| Min. Green:                                 | 10          | 10   | 0    | 0           | 10   | 10   | 0          | 0    | 0    | 10         | 10   | 10   |
| Y+R:  | 4.0         | 4.0  | 4.0  | 4.0         | 4.0  | 4.0  | 4.0        | 4.0  | 4.0  | 4.0        | 4.0  | 4.0  |
| Volume Module: >> Count Date: 8 Oct 2014 << |             |      |      |             |      |      |            |      |      |            |      |      |
| Base Vol:                                   | 5           | 1069 | 0    | 0           | 391  | 5    | 0          | 0    | 0    | 121        | 63   | 97   |
| Growth Adj:                                 | 1.00        | 1.00 | 1.00 | 1.00        | 1.00 | 1.00 | 1.00       | 1.00 | 1.00 | 1.00       | 1.00 | 1.00 |
| Initial Bse:                                | 5           | 1069 | 0    | 0           | 391  | 5    | 0          | 0    | 0    | 121        | 63   | 97   |
| Added Vol:                                  | 0           | 0    | 0    | 0           | 0    | 0    | 0          | 0    | 0    | 0          | 0    | 0    |
| PasserByVol:                                | 0           | 0    | 0    | 0           | 0    | 0    | 0          | 0    | 0    | 0          | 0    | 0    |
| Initial Fut:                                | 5           | 1069 | 0    | 0           | 391  | 5    | 0          | 0    | 0    | 121        | 63   | 97   |
| User Adj:                                   | 1.00        | 1.00 | 1.00 | 1.00        | 1.00 | 1.00 | 1.00       | 1.00 | 1.00 | 1.00       | 1.00 | 1.00 |
| PHF Adj:                                    | 1.00        | 1.00 | 1.00 | 1.00        | 1.00 | 1.00 | 1.00       | 1.00 | 1.00 | 1.00       | 1.00 | 1.00 |
| PHF Volume:                                 | 5           | 1069 | 0    | 0           | 391  | 5    | 0          | 0    | 0    | 121        | 63   | 97   |
| Reduct Vol:                                 | 0           | 0    | 0    | 0           | 0    | 0    | 0          | 0    | 0    | 0          | 0    | 0    |
| Reduced Vol:                                | 5           | 1069 | 0    | 0           | 391  | 5    | 0          | 0    | 0    | 121        | 63   | 97   |
| PCE Adj:                                    | 1.00        | 1.00 | 1.00 | 1.00        | 1.00 | 1.00 | 1.00       | 1.00 | 1.00 | 1.00       | 1.00 | 1.00 |
| MLF Adj:                                    | 1.00        | 1.00 | 1.00 | 1.00        | 1.00 | 1.00 | 1.00       | 1.00 | 1.00 | 1.00       | 1.00 | 1.00 |
| Final Volume:                               | 5           | 1069 | 0    | 0           | 391  | 5    | 0          | 0    | 0    | 121        | 63   | 97   |
| Saturation Flow Module:                     |             |      |      |             |      |      |            |      |      |            |      |      |
| Sat/Lane:                                   | 1900        | 1900 | 1900 | 1900        | 1900 | 1900 | 1900       | 1900 | 1900 | 1900       | 1900 | 1900 |
| Adjustment:                                 | 0.95        | 0.97 | 0.92 | 0.92        | 0.95 | 0.95 | 0.92       | 1.00 | 0.92 | 0.92       | 1.00 | 0.92 |
| Lanes:                                      | 0.01        | 1.99 | 0.00 | 0.00        | 0.99 | 0.01 | 0.00       | 0.00 | 0.00 | 1.00       | 1.00 | 1.00 |
| Final Sat.:                                 | 17          | 3683 | 0    | 0           | 1777 | 23   | 0          | 0    | 0    | 1750       | 1900 | 1750 |
| Capacity Analysis Module:                   |             |      |      |             |      |      |            |      |      |            |      |      |
| Vol/Sat:                                    | 0.29        | 0.29 | 0.00 | 0.00        | 0.22 | 0.22 | 0.00       | 0.00 | 0.00 | 0.07       | 0.03 | 0.06 |
| Crit Moves:                                 | ****        |      |      | ****        |      |      | ****       |      |      | ****       |      |      |
| Green Time:                                 | 92.1        | 92.1 | 0.0  | 0.0         | 92.1 | 92.1 | 0.0        | 0.0  | 0.0  | 21.9       | 21.9 | 21.9 |
| Volume/Cap:                                 | 0.38        | 0.38 | 0.00 | 0.00        | 0.29 | 0.29 | 0.00       | 0.00 | 0.00 | 0.38       | 0.18 | 0.30 |
| Delay/Veh:                                  | 4.7         | 4.7  | 0.0  | 0.0         | 4.3  | 4.3  | 0.0        | 0.0  | 0.0  | 43.8       | 41.5 | 42.8 |
| User DelAdj:                                | 1.00        | 1.00 | 1.00 | 1.00        | 1.00 | 1.00 | 1.00       | 1.00 | 1.00 | 1.00       | 1.00 | 1.00 |
| AdjDel/Veh:                                 | 4.7         | 4.7  | 0.0  | 0.0         | 4.3  | 4.3  | 0.0        | 0.0  | 0.0  | 43.8       | 41.5 | 42.8 |
| LOS by Move:                                | A           | A    | A    | A           | A    | A    | A          | A    | A    | D          | D    | D    |
| HCM2k95thQ:                                 | 13          | 13   | 0    | 0           | 9    | 9    | 0          | 0    | 0    | 9          | 4    | 7    |

Note: Queue reported is the number of cars per lane.



BART

Level Of Service Computation Report  
2000 HCM Operations (Future Volume Alternative)  
PM - Existing Conditions

Intersection #5444: Lafayette/Lewis [Study Int 47]

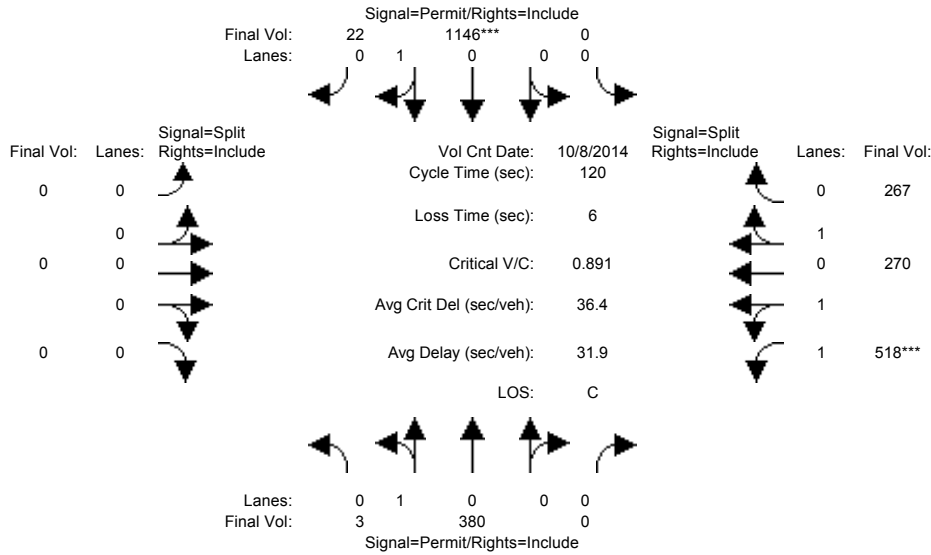

| Approach:                                   | North Bound |      |      | South Bound |      |      | East Bound |      |      | West Bound |      |      |
|---|-------------|------|------|-------------|------|------|------------|------|------|------------|------|------|
| Movement:                                   | L           | T    | R    | L           | T    | R    | L          | T    | R    | L          | T    | R    |
| Min. Green:                                 | 10          | 10   | 0    | 0           | 10   | 10   | 0          | 0    | 0    | 10         | 10   | 10   |
| Y+R:  | 4.0         | 4.0  | 4.0  | 4.0         | 4.0  | 4.0  | 4.0        | 4.0  | 4.0  | 4.0        | 4.0  | 4.0  |
| Volume Module: >> Count Date: 8 Oct 2014 << |             |      |      |             |      |      |            |      |      |            |      |      |
| Base Vol:                                   | 3           | 380  | 0    | 0           | 1146 | 22   | 0          | 0    | 0    | 518        | 270  | 267  |
| Growth Adj:                                 | 1.00        | 1.00 | 1.00 | 1.00        | 1.00 | 1.00 | 1.00       | 1.00 | 1.00 | 1.00       | 1.00 | 1.00 |
| Initial Bse:                                | 3           | 380  | 0    | 0           | 1146 | 22   | 0          | 0    | 0    | 518        | 270  | 267  |
| Added Vol:                                  | 0           | 0    | 0    | 0           | 0    | 0    | 0          | 0    | 0    | 0          | 0    | 0    |
| PasserByVol:                                | 0           | 0    | 0    | 0           | 0    | 0    | 0          | 0    | 0    | 0          | 0    | 0    |
| Initial Fut:                                | 3           | 380  | 0    | 0           | 1146 | 22   | 0          | 0    | 0    | 518        | 270  | 267  |
| User Adj:                                   | 1.00        | 1.00 | 1.00 | 1.00        | 1.00 | 1.00 | 1.00       | 1.00 | 1.00 | 1.00       | 1.00 | 1.00 |
| PHF Adj:                                    | 1.00        | 1.00 | 1.00 | 1.00        | 1.00 | 1.00 | 1.00       | 1.00 | 1.00 | 1.00       | 1.00 | 1.00 |
| PHF Volume:                                 | 3           | 380  | 0    | 0           | 1146 | 22   | 0          | 0    | 0    | 518        | 270  | 267  |
| Reduct Vol:                                 | 0           | 0    | 0    | 0           | 0    | 0    | 0          | 0    | 0    | 0          | 0    | 0    |
| Reduced Vol:                                | 3           | 380  | 0    | 0           | 1146 | 22   | 0          | 0    | 0    | 518        | 270  | 267  |
| PCE Adj:                                    | 1.00        | 1.00 | 1.00 | 1.00        | 1.00 | 1.00 | 1.00       | 1.00 | 1.00 | 1.00       | 1.00 | 1.00 |
| MLF Adj:                                    | 1.00        | 1.00 | 1.00 | 1.00        | 1.00 | 1.00 | 1.00       | 1.00 | 1.00 | 1.00       | 1.00 | 1.00 |
| Final Volume:                               | 3           | 380  | 0    | 0           | 1146 | 22   | 0          | 0    | 0    | 518        | 270  | 267  |
| Saturation Flow Module:                     |             |      |      |             |      |      |            |      |      |            |      |      |
| Sat/Lane:                                   | 1900        | 1900 | 1900 | 1900        | 1900 | 1900 | 1900       | 1900 | 1900 | 1900       | 1900 | 1900 |
| Adjustment:                                 | 0.95        | 0.95 | 0.92 | 0.92        | 0.95 | 0.95 | 0.92       | 1.00 | 0.92 | 0.93       | 0.95 | 0.95 |
| Lanes:                                      | 0.01        | 0.99 | 0.00 | 0.00        | 0.98 | 0.02 | 0.00       | 0.00 | 0.00 | 1.49       | 0.76 | 0.75 |
| Final Sat.:                                 | 14          | 1786 | 0    | 0           | 1766 | 34   | 0          | 0    | 0    | 2627       | 1369 | 1354 |
| Capacity Analysis Module:                   |             |      |      |             |      |      |            |      |      |            |      |      |
| Vol/Sat:                                    | 0.21        | 0.21 | 0.00 | 0.00        | 0.65 | 0.65 | 0.00       | 0.00 | 0.00 | 0.20       | 0.20 | 0.20 |
| Crit Moves:                                 | *****       |      |      |             |      |      |            |      |      |            |      |      |
| Green Time:                                 | 87.4        | 87.4 | 0.0  | 0.0         | 87.4 | 87.4 | 0.0        | 0.0  | 0.0  | 26.6       | 26.6 | 26.6 |
| Volume/Cap:                                 | 0.29        | 0.29 | 0.00 | 0.00        | 0.89 | 0.89 | 0.00       | 0.00 | 0.00 | 0.89       | 0.89 | 0.89 |
| Delay/Veh:                                  | 5.7         | 5.7  | 0.0  | 0.0         | 20.5 | 20.5 | 0.0        | 0.0  | 0.0  | 54.0       | 54.0 | 54.0 |
| User DelAdj:                                | 1.00        | 1.00 | 1.00 | 1.00        | 1.00 | 1.00 | 1.00       | 1.00 | 1.00 | 1.00       | 1.00 | 1.00 |
| AdjDel/Veh:                                 | 5.7         | 5.7  | 0.0  | 0.0         | 20.5 | 20.5 | 0.0        | 0.0  | 0.0  | 54.0       | 54.0 | 54.0 |
| LOS by Move:                                | A           | A    | A    | A           | C    | C    | A          | A    | A    | D          | D    | D    |
| HCM2k95thQ:                                 | 10          | 10   | 0    | 0           | 57   | 57   | 0          | 0    | 0    | 29         | 29   | 29   |

Note: Queue reported is the number of cars per lane.

BART

Level Of Service Computation Report  
 2000 HCM Operations (Future Volume Alternative)  
 AM - Exist + Proj Conditions

Intersection #6: DE LA CRUZ/MARTIN [Study Int 31]

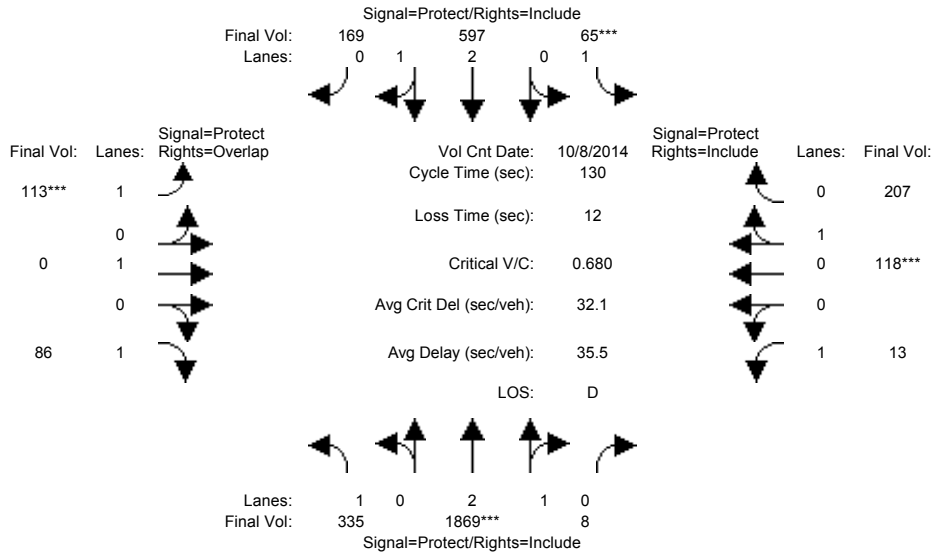

| Approach:                                   | North Bound |      |      | South Bound |      |      | East Bound |      |      | West Bound |      |      |
|---|-------------|------|------|-------------|------|------|------------|------|------|------------|------|------|
| Movement:                                   | L           | T    | R    | L           | T    | R    | L          | T    | R    | L          | T    | R    |
| Min. Green:                                 | 7           | 10   | 10   | 7           | 10   | 10   | 7          | 10   | 10   | 7          | 10   | 10   |
| Y+R:  | 4.0         | 4.0  | 4.0  | 4.0         | 4.0  | 4.0  | 4.0        | 4.0  | 4.0  | 4.0        | 4.0  | 4.0  |
| Volume Module: >> Count Date: 8 Oct 2014 << |             |      |      |             |      |      |            |      |      |            |      |      |
| Base Vol:                                   | 335         | 1869 | 8    | 65          | 597  | 169  | 113        | 0    | 86   | 13         | 118  | 207  |
| Growth Adj:                                 | 1.00        | 1.00 | 1.00 | 1.00        | 1.00 | 1.00 | 1.00       | 1.00 | 1.00 | 1.00       | 1.00 | 1.00 |
| Initial Bse:                                | 335         | 1869 | 8    | 65          | 597  | 169  | 113        | 0    | 86   | 13         | 118  | 207  |
| Added Vol:                                  | 0           | 0    | 0    | 0           | 0    | 0    | 0          | 0    | 0    | 0          | 0    | 0    |
| PasserByVol:                                | 0           | 0    | 0    | 0           | 0    | 0    | 0          | 0    | 0    | 0          | 0    | 0    |
| Initial Fut:                                | 335         | 1869 | 8    | 65          | 597  | 169  | 113        | 0    | 86   | 13         | 118  | 207  |
| User Adj:                                   | 1.00        | 1.00 | 1.00 | 1.00        | 1.00 | 1.00 | 1.00       | 1.00 | 1.00 | 1.00       | 1.00 | 1.00 |
| PHF Adj:                                    | 1.00        | 1.00 | 1.00 | 1.00        | 1.00 | 1.00 | 1.00       | 1.00 | 1.00 | 1.00       | 1.00 | 1.00 |
| PHF Volume:                                 | 335         | 1869 | 8    | 65          | 597  | 169  | 113        | 0    | 86   | 13         | 118  | 207  |
| Reduct Vol:                                 | 0           | 0    | 0    | 0           | 0    | 0    | 0          | 0    | 0    | 0          | 0    | 0    |
| Reduced Vol:                                | 335         | 1869 | 8    | 65          | 597  | 169  | 113        | 0    | 86   | 13         | 118  | 207  |
| PCE Adj:                                    | 1.00        | 1.00 | 1.00 | 1.00        | 1.00 | 1.00 | 1.00       | 1.00 | 1.00 | 1.00       | 1.00 | 1.00 |
| MLF Adj:                                    | 1.00        | 1.00 | 1.00 | 1.00        | 1.00 | 1.00 | 1.00       | 1.00 | 1.00 | 1.00       | 1.00 | 1.00 |
| FinalVolume:                                | 335         | 1869 | 8    | 65          | 597  | 169  | 113        | 0    | 86   | 13         | 118  | 207  |
| Saturation Flow Module:                     |             |      |      |             |      |      |            |      |      |            |      |      |
| Sat/Lane:                                   | 1900        | 1900 | 1900 | 1900        | 1900 | 1900 | 1900       | 1900 | 1900 | 1900       | 1900 | 1900 |
| Adjustment:                                 | 0.92        | 0.98 | 0.95 | 0.92        | 0.99 | 0.95 | 0.92       | 1.00 | 0.92 | 0.92       | 0.95 | 0.95 |
| Lanes:                                      | 1.00        | 2.99 | 0.01 | 1.00        | 2.31 | 0.69 | 1.00       | 1.00 | 1.00 | 1.00       | 0.36 | 0.64 |
| Final Sat.:                                 | 1750        | 5576 | 24   | 1750        | 4363 | 1235 | 1750       | 1900 | 1750 | 1750       | 654  | 1146 |
| Capacity Analysis Module:                   |             |      |      |             |      |      |            |      |      |            |      |      |
| Vol/Sat:                                    | 0.19        | 0.34 | 0.34 | 0.04        | 0.14 | 0.14 | 0.06       | 0.00 | 0.05 | 0.01       | 0.18 | 0.18 |
| Crit Moves:                                 | ****        | **** | **** | ****        | **** | **** | ****       | **** | **** | ****       | **** | **** |
| Green Time:                                 | 41.5        | 64.1 | 64.1 | 7.1         | 29.7 | 29.7 | 12.3       | 0.0  | 53.8 | 46.8       | 34.5 | 34.5 |
| Volume/Cap:                                 | 0.60        | 0.68 | 0.68 | 0.68        | 0.60 | 0.60 | 0.68       | 0.00 | 0.12 | 0.02       | 0.68 | 0.68 |
| Delay/Veh:                                  | 39.1        | 25.9 | 25.9 | 78.4        | 45.7 | 45.7 | 67.8       | 0.0  | 23.5 | 26.8       | 46.8 | 46.8 |
| User DelAdj:                                | 1.00        | 1.00 | 1.00 | 1.00        | 1.00 | 1.00 | 1.00       | 1.00 | 1.00 | 1.00       | 1.00 | 1.00 |
| AdjDel/Veh:                                 | 39.1        | 25.9 | 25.9 | 78.4        | 45.7 | 45.7 | 67.8       | 0.0  | 23.5 | 26.8       | 46.8 | 46.8 |
| LOS by Move:                                | D           | C    | C    | E           | D    | D    | E          | A    | C    | C          | D    | D    |
| HCM2k95thQ:                                 | 22          | 33   | 33   | 6           | 17   | 17   | 10         | 0    | 4    | 1          | 23   | 23   |

Note: Queue reported is the number of cars per lane.

BART

Level Of Service Computation Report  
2000 HCM Operations (Future Volume Alternative)  
PM - Exist + Proj Conditions

Intersection #6: DE LA CRUZ/MARTIN [Study Int 31]

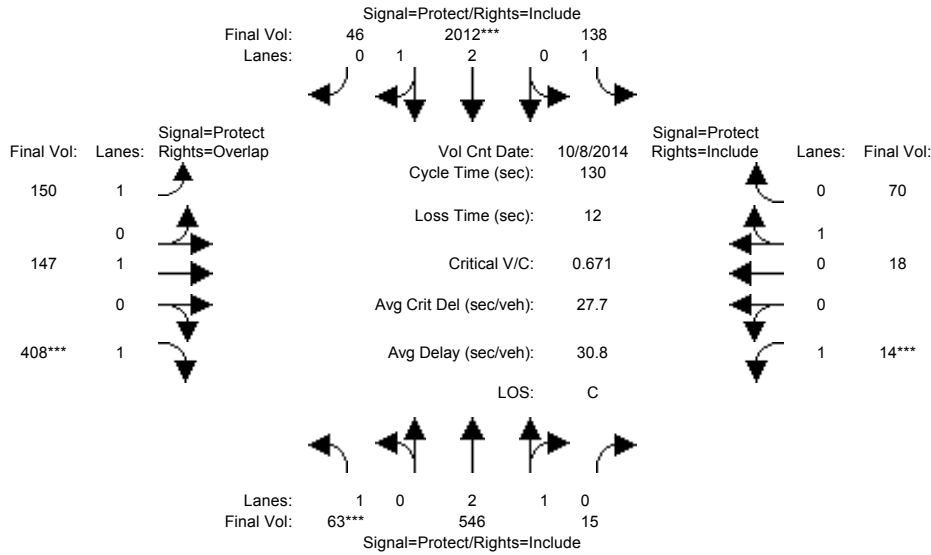

| Approach:                                   | North Bound |      |      | South Bound |      |      | East Bound |      |      | West Bound |      |      |
|---|-------------|------|------|-------------|------|------|------------|------|------|------------|------|------|
| Movement:                                   | L           | T    | R    | L           | T    | R    | L          | T    | R    | L          | T    | R    |
| Min. Green:                                 | 7           | 10   | 10   | 7           | 10   | 10   | 7          | 10   | 10   | 7          | 10   | 10   |
| Y+R:  | 4.0         | 4.0  | 4.0  | 4.0         | 4.0  | 4.0  | 4.0        | 4.0  | 4.0  | 4.0        | 4.0  | 4.0  |
| Volume Module: >> Count Date: 8 Oct 2014 << |             |      |      |             |      |      |            |      |      |            |      |      |
| Base Vol:                                   | 63          | 546  | 15   | 138         | 2012 | 46   | 150        | 147  | 408  | 14         | 18   | 70   |
| Growth Adj:                                 | 1.00        | 1.00 | 1.00 | 1.00        | 1.00 | 1.00 | 1.00       | 1.00 | 1.00 | 1.00       | 1.00 | 1.00 |
| Initial Bse:                                | 63          | 546  | 15   | 138         | 2012 | 46   | 150        | 147  | 408  | 14         | 18   | 70   |
| Added Vol:                                  | 0           | 0    | 0    | 0           | 0    | 0    | 0          | 0    | 0    | 0          | 0    | 0    |
| PasserByVol:                                | 0           | 0    | 0    | 0           | 0    | 0    | 0          | 0    | 0    | 0          | 0    | 0    |
| Initial Fut:                                | 63          | 546  | 15   | 138         | 2012 | 46   | 150        | 147  | 408  | 14         | 18   | 70   |
| User Adj:                                   | 1.00        | 1.00 | 1.00 | 1.00        | 1.00 | 1.00 | 1.00       | 1.00 | 1.00 | 1.00       | 1.00 | 1.00 |
| PHF Adj:                                    | 1.00        | 1.00 | 1.00 | 1.00        | 1.00 | 1.00 | 1.00       | 1.00 | 1.00 | 1.00       | 1.00 | 1.00 |
| PHF Volume:                                 | 63          | 546  | 15   | 138         | 2012 | 46   | 150        | 147  | 408  | 14         | 18   | 70   |
| Reduct Vol:                                 | 0           | 0    | 0    | 0           | 0    | 0    | 0          | 0    | 0    | 0          | 0    | 0    |
| Reduced Vol:                                | 63          | 546  | 15   | 138         | 2012 | 46   | 150        | 147  | 408  | 14         | 18   | 70   |
| PCE Adj:                                    | 1.00        | 1.00 | 1.00 | 1.00        | 1.00 | 1.00 | 1.00       | 1.00 | 1.00 | 1.00       | 1.00 | 1.00 |
| MLF Adj:                                    | 1.00        | 1.00 | 1.00 | 1.00        | 1.00 | 1.00 | 1.00       | 1.00 | 1.00 | 1.00       | 1.00 | 1.00 |
| Final Volume:                               | 63          | 546  | 15   | 138         | 2012 | 46   | 150        | 147  | 408  | 14         | 18   | 70   |
| Saturation Flow Module:                     |             |      |      |             |      |      |            |      |      |            |      |      |
| Sat/Lane:                                   | 1900        | 1900 | 1900 | 1900        | 1900 | 1900 | 1900       | 1900 | 1900 | 1900       | 1900 | 1900 |
| Adjustment:                                 | 0.92        | 0.98 | 0.95 | 0.92        | 0.98 | 0.95 | 0.92       | 1.00 | 0.92 | 0.92       | 0.95 | 0.95 |
| Lanes:                                      | 1.00        | 2.92 | 0.08 | 1.00        | 2.93 | 0.07 | 1.00       | 1.00 | 1.00 | 1.00       | 0.20 | 0.80 |
| Final Sat.:                                 | 1750        | 5450 | 150  | 1750        | 5475 | 125  | 1750       | 1900 | 1750 | 1750       | 368  | 1432 |
| Capacity Analysis Module:                   |             |      |      |             |      |      |            |      |      |            |      |      |
| Vol/Sat:                                    | 0.04        | 0.10 | 0.10 | 0.08        | 0.37 | 0.37 | 0.09       | 0.08 | 0.23 | 0.01       | 0.05 | 0.05 |
| Crit Moves:                                 | ****        |      |      | ****        |      |      | ****       |      | **** | ****       |      |      |
| Green Time:                                 | 7.0         | 43.0 | 43.0 | 33.9        | 69.9 | 69.9 | 21.7       | 34.1 | 41.1 | 7.0        | 19.4 | 19.4 |
| Volume/Cap:                                 | 0.67        | 0.30 | 0.30 | 0.30        | 0.68 | 0.68 | 0.51       | 0.29 | 0.74 | 0.15       | 0.33 | 0.33 |
| Delay/Veh:                                  | 77.3        | 32.4 | 32.4 | 39.0        | 22.6 | 22.6 | 51.0       | 38.7 | 44.8 | 59.4       | 50.1 | 50.1 |
| User DelAdj:                                | 1.00        | 1.00 | 1.00 | 1.00        | 1.00 | 1.00 | 1.00       | 1.00 | 1.00 | 1.00       | 1.00 | 1.00 |
| AdjDel/Veh:                                 | 77.3        | 32.4 | 32.4 | 39.0        | 22.6 | 22.6 | 51.0       | 38.7 | 44.8 | 59.4       | 50.1 | 50.1 |
| LOS by Move:                                | E           | C    | C    | D           | C    | C    | D          | D    | D    | E          | D    | D    |
| HCM2k95thQ:                                 | 6           | 10   | 10   | 9           | 34   | 34   | 11         | 9    | 28   | 1          | 7    | 7    |

Note: Queue reported is the number of cars per lane.

BART

Level Of Service Computation Report  
 2000 HCM Operations (Future Volume Alternative)  
 AM - Exist + Proj Conditions

Intersection #7: LAFAYETTE/REED [Study Int 45]

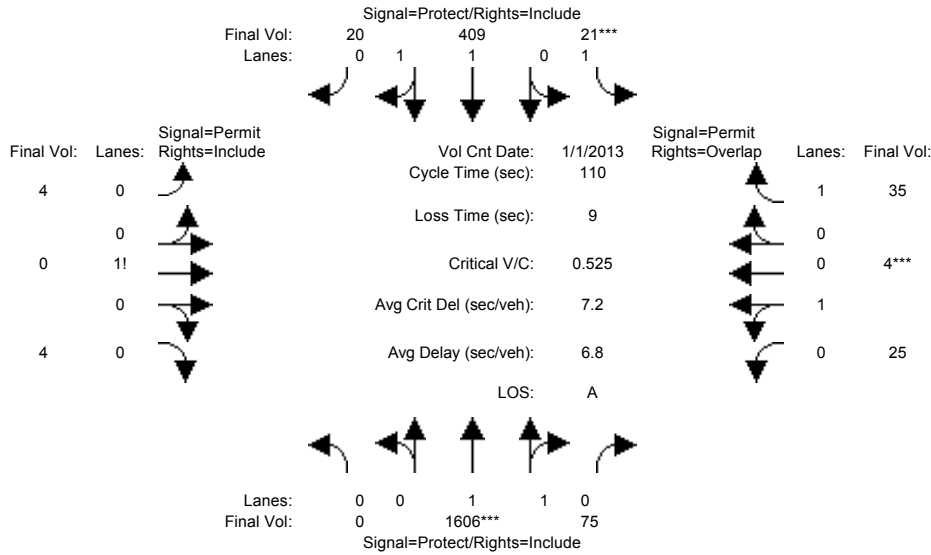

| Approach:                                   | North Bound |      |      | South Bound |      |      | East Bound |      |      | West Bound |      |      |
|---|-------------|------|------|-------------|------|------|------------|------|------|------------|------|------|
| Movement:                                   | L           | T    | R    | L           | T    | R    | L          | T    | R    | L          | T    | R    |
| Min. Green:                                 | 7           | 10   | 10   | 7           | 10   | 10   | 10         | 10   | 10   | 10         | 10   | 10   |
| Y+R:  | 4.0         | 4.0  | 4.0  | 4.0         | 4.0  | 4.0  | 4.0        | 4.0  | 4.0  | 4.0        | 4.0  | 4.0  |
| Volume Module: >> Count Date: 1 Jan 2013 << |             |      |      |             |      |      |            |      |      |            |      |      |
| Base Vol:                                   | 0           | 1606 | 75   | 21          | 409  | 20   | 4          | 0    | 4    | 25         | 4    | 35   |
| Growth Adj:                                 | 1.00        | 1.00 | 1.00 | 1.00        | 1.00 | 1.00 | 1.00       | 1.00 | 1.00 | 1.00       | 1.00 | 1.00 |
| Initial Bse:                                | 0           | 1606 | 75   | 21          | 409  | 20   | 4          | 0    | 4    | 25         | 4    | 35   |
| Added Vol:                                  | 0           | 0    | 0    | 0           | 0    | 0    | 0          | 0    | 0    | 0          | 0    | 0    |
| PasserByVol:                                | 0           | 0    | 0    | 0           | 0    | 0    | 0          | 0    | 0    | 0          | 0    | 0    |
| Initial Fut:                                | 0           | 1606 | 75   | 21          | 409  | 20   | 4          | 0    | 4    | 25         | 4    | 35   |
| User Adj:                                   | 1.00        | 1.00 | 1.00 | 1.00        | 1.00 | 1.00 | 1.00       | 1.00 | 1.00 | 1.00       | 1.00 | 1.00 |
| PHF Adj:                                    | 1.00        | 1.00 | 1.00 | 1.00        | 1.00 | 1.00 | 1.00       | 1.00 | 1.00 | 1.00       | 1.00 | 1.00 |
| PHF Volume:                                 | 0           | 1606 | 75   | 21          | 409  | 20   | 4          | 0    | 4    | 25         | 4    | 35   |
| Reduct Vol:                                 | 0           | 0    | 0    | 0           | 0    | 0    | 0          | 0    | 0    | 0          | 0    | 0    |
| Reduced Vol:                                | 0           | 1606 | 75   | 21          | 409  | 20   | 4          | 0    | 4    | 25         | 4    | 35   |
| PCE Adj:                                    | 1.00        | 1.00 | 1.00 | 1.00        | 1.00 | 1.00 | 1.00       | 1.00 | 1.00 | 1.00       | 1.00 | 1.00 |
| MLF Adj:                                    | 1.00        | 1.00 | 1.00 | 1.00        | 1.00 | 1.00 | 1.00       | 1.00 | 1.00 | 1.00       | 1.00 | 1.00 |
| Final Volume:                               | 0           | 1606 | 75   | 21          | 409  | 20   | 4          | 0    | 4    | 25         | 4    | 35   |
| Saturation Flow Module:                     |             |      |      |             |      |      |            |      |      |            |      |      |
| Sat/Lane:                                   | 1900        | 1900 | 1900 | 1900        | 1900 | 1900 | 1900       | 1900 | 1900 | 1900       | 1900 | 1900 |
| Adjustment:                                 | 0.92        | 0.97 | 0.95 | 0.92        | 0.97 | 0.95 | 0.92       | 0.92 | 0.92 | 0.95       | 0.95 | 0.92 |
| Lanes:                                      | 0.00        | 1.91 | 0.09 | 1.00        | 1.90 | 0.10 | 0.50       | 0.00 | 0.50 | 0.86       | 0.14 | 1.00 |
| Final Sat.:                                 | 0           | 3535 | 165  | 1750        | 3527 | 172  | 875        | 0    | 875  | 1552       | 248  | 1750 |
| Capacity Analysis Module:                   |             |      |      |             |      |      |            |      |      |            |      |      |
| Vol/Sat:                                    | 0.00        | 0.45 | 0.45 | 0.01        | 0.12 | 0.12 | 0.00       | 0.00 | 0.00 | 0.02       | 0.02 | 0.02 |
| Crit Moves:                                 | ****        | **** | **** | ****        | **** | **** | ****       | **** | **** | ****       | **** | **** |
| Green Time:                                 | 0.0         | 84.0 | 84.0 | 7.0         | 91.0 | 91.0 | 10.0       | 0.0  | 10.0 | 10.0       | 10.0 | 17.0 |
| Volume/Cap:                                 | 0.00        | 0.59 | 0.59 | 0.19        | 0.14 | 0.14 | 0.05       | 0.00 | 0.05 | 0.18       | 0.18 | 0.13 |
| Delay/Veh:                                  | 0.0         | 6.0  | 6.0  | 49.6        | 1.9  | 1.9  | 45.8       | 0.0  | 45.8 | 46.7       | 46.7 | 40.3 |
| User DelAdj:                                | 1.00        | 1.00 | 1.00 | 1.00        | 1.00 | 1.00 | 1.00       | 1.00 | 1.00 | 1.00       | 1.00 | 1.00 |
| AdjDel/Veh:                                 | 0.0         | 6.0  | 6.0  | 49.6        | 1.9  | 1.9  | 45.8       | 0.0  | 45.8 | 46.7       | 46.7 | 40.3 |
| LOS by Move:                                | A           | A    | A    | D           | A    | A    | D          | A    | D    | D          | D    | D    |
| HCM2k95thQ:                                 | 0           | 23   | 23   | 1           | 3    | 3    | 1          | 0    | 1    | 2          | 2    | 2    |

Note: Queue reported is the number of cars per lane.

BART

Level Of Service Computation Report  
 2000 HCM Operations (Future Volume Alternative)  
 PM - Exist + Proj Conditions

Intersection #7: LAFAYETTE/REED [Study Int 45]

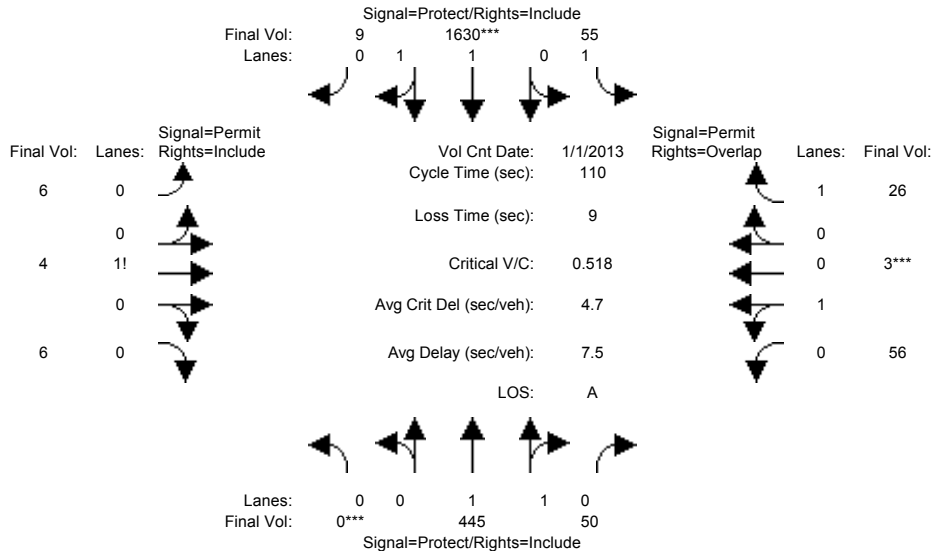

| Approach:                                   | North Bound |      |      | South Bound |      |      | East Bound |      |      | West Bound |      |      |
|---|-------------|------|------|-------------|------|------|------------|------|------|------------|------|------|
| Movement:                                   | L           | T    | R    | L           | T    | R    | L          | T    | R    | L          | T    | R    |
| Min. Green:                                 | 7           | 10   | 10   | 7           | 10   | 10   | 10         | 10   | 10   | 10         | 10   | 10   |
| Y+R:  | 4.0         | 4.0  | 4.0  | 4.0         | 4.0  | 4.0  | 4.0        | 4.0  | 4.0  | 4.0        | 4.0  | 4.0  |
| Volume Module: >> Count Date: 1 Jan 2013 << |             |      |      |             |      |      |            |      |      |            |      |      |
| Base Vol:                                   | 0           | 445  | 50   | 55          | 1630 | 9    | 6          | 4    | 6    | 56         | 3    | 26   |
| Growth Adj:                                 | 1.00        | 1.00 | 1.00 | 1.00        | 1.00 | 1.00 | 1.00       | 1.00 | 1.00 | 1.00       | 1.00 | 1.00 |
| Initial Bse:                                | 0           | 445  | 50   | 55          | 1630 | 9    | 6          | 4    | 6    | 56         | 3    | 26   |
| Added Vol:                                  | 0           | 0    | 0    | 0           | 0    | 0    | 0          | 0    | 0    | 0          | 0    | 0    |
| PasserByVol:                                | 0           | 0    | 0    | 0           | 0    | 0    | 0          | 0    | 0    | 0          | 0    | 0    |
| Initial Fut:                                | 0           | 445  | 50   | 55          | 1630 | 9    | 6          | 4    | 6    | 56         | 3    | 26   |
| User Adj:                                   | 1.00        | 1.00 | 1.00 | 1.00        | 1.00 | 1.00 | 1.00       | 1.00 | 1.00 | 1.00       | 1.00 | 1.00 |
| PHF Adj:                                    | 1.00        | 1.00 | 1.00 | 1.00        | 1.00 | 1.00 | 1.00       | 1.00 | 1.00 | 1.00       | 1.00 | 1.00 |
| PHF Volume:                                 | 0           | 445  | 50   | 55          | 1630 | 9    | 6          | 4    | 6    | 56         | 3    | 26   |
| Reduct Vol:                                 | 0           | 0    | 0    | 0           | 0    | 0    | 0          | 0    | 0    | 0          | 0    | 0    |
| Reduced Vol:                                | 0           | 445  | 50   | 55          | 1630 | 9    | 6          | 4    | 6    | 56         | 3    | 26   |
| PCE Adj:                                    | 1.00        | 1.00 | 1.00 | 1.00        | 1.00 | 1.00 | 1.00       | 1.00 | 1.00 | 1.00       | 1.00 | 1.00 |
| MLF Adj:                                    | 1.00        | 1.00 | 1.00 | 1.00        | 1.00 | 1.00 | 1.00       | 1.00 | 1.00 | 1.00       | 1.00 | 1.00 |
| FinalVolume:                                | 0           | 445  | 50   | 55          | 1630 | 9    | 6          | 4    | 6    | 56         | 3    | 26   |
| Saturation Flow Module:                     |             |      |      |             |      |      |            |      |      |            |      |      |
| Sat/Lane:                                   | 1900        | 1900 | 1900 | 1900        | 1900 | 1900 | 1900       | 1900 | 1900 | 1900       | 1900 | 1900 |
| Adjustment:                                 | 0.92        | 0.98 | 0.95 | 0.92        | 0.97 | 0.95 | 0.92       | 0.92 | 0.92 | 0.95       | 0.95 | 0.92 |
| Lanes:                                      | 0.00        | 1.79 | 0.21 | 1.00        | 1.99 | 0.01 | 0.37       | 0.25 | 0.38 | 0.95       | 0.05 | 1.00 |
| Final Sat.:                                 | 0           | 3326 | 374  | 1750        | 3680 | 20   | 656        | 438  | 656  | 1708       | 92   | 1750 |
| Capacity Analysis Module:                   |             |      |      |             |      |      |            |      |      |            |      |      |
| Vol/Sat:                                    | 0.00        | 0.13 | 0.13 | 0.03        | 0.44 | 0.44 | 0.01       | 0.01 | 0.01 | 0.03       | 0.03 | 0.01 |
| Crit Moves:                                 | ****        |      |      |             |      |      |            |      |      |            |      | **** |
| Green Time:                                 | 0.0         | 61.7 | 61.7 | 29.3        | 91.0 | 91.0 | 10.0       | 10.0 | 10.0 | 10.0       | 10.0 | 39.3 |
| Volume/Cap:                                 | 0.00        | 0.24 | 0.24 | 0.12        | 0.54 | 0.54 | 0.10       | 0.10 | 0.10 | 0.36       | 0.36 | 0.04 |
| Delay/Veh:                                  | 0.0         | 12.3 | 12.3 | 30.7        | 3.1  | 3.1  | 46.2       | 46.2 | 46.2 | 48.4       | 48.4 | 23.1 |
| User DelAdj:                                | 1.00        | 1.00 | 1.00 | 1.00        | 1.00 | 1.00 | 1.00       | 1.00 | 1.00 | 1.00       | 1.00 | 1.00 |
| AdjDel/Veh:                                 | 0.0         | 12.3 | 12.3 | 30.7        | 3.1  | 3.1  | 46.2       | 46.2 | 46.2 | 48.4       | 48.4 | 23.1 |
| LOS by Move:                                | A           | B    | B    | C           | A    | A    | D          | D    | D    | D          | D    | C    |
| HCM2k95thQ:                                 | 0           | 8    | 8    | 3           | 17   | 17   | 1          | 1    | 1    | 4          | 4    | 1    |

Note: Queue reported is the number of cars per lane.

BART

Level Of Service Computation Report  
 2000 HCM Operations (Future Volume Alternative)  
 AM - Exist + Proj Conditions

Intersection #9: Coleman/Brokaw [Study Int 33]

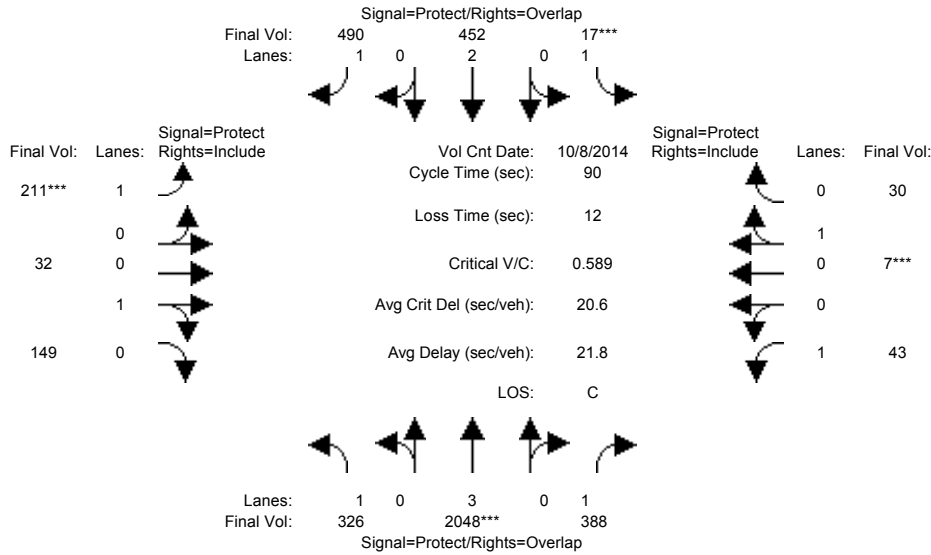

| Approach:                                   | North Bound |      |      | South Bound |      |      | East Bound |      |      | West Bound |      |      |
|---|-------------|------|------|-------------|------|------|------------|------|------|------------|------|------|
| Movement:                                   | L           | T    | R    | L           | T    | R    | L          | T    | R    | L          | T    | R    |
| Min. Green:                                 | 7           | 10   | 10   | 7           | 10   | 10   | 7          | 10   | 10   | 7          | 10   | 10   |
| Y+R:  | 4.0         | 4.0  | 4.0  | 4.0         | 4.0  | 4.0  | 4.0        | 4.0  | 4.0  | 4.0        | 4.0  | 4.0  |
| Volume Module: >> Count Date: 8 Oct 2014 << |             |      |      |             |      |      |            |      |      |            |      |      |
| Base Vol:                                   | 326         | 2048 | 388  | 17          | 452  | 490  | 211        | 32   | 149  | 43         | 7    | 30   |
| Growth Adj:                                 | 1.00        | 1.00 | 1.00 | 1.00        | 1.00 | 1.00 | 1.00       | 1.00 | 1.00 | 1.00       | 1.00 | 1.00 |
| Initial Bse:                                | 326         | 2048 | 388  | 17          | 452  | 490  | 211        | 32   | 149  | 43         | 7    | 30   |
| Added Vol:                                  | 0           | 0    | 0    | 0           | 0    | 0    | 0          | 0    | 0    | 0          | 0    | 0    |
| PasserByVol:                                | 0           | 0    | 0    | 0           | 0    | 0    | 0          | 0    | 0    | 0          | 0    | 0    |
| Initial Fut:                                | 326         | 2048 | 388  | 17          | 452  | 490  | 211        | 32   | 149  | 43         | 7    | 30   |
| User Adj:                                   | 1.00        | 1.00 | 1.00 | 1.00        | 1.00 | 1.00 | 1.00       | 1.00 | 1.00 | 1.00       | 1.00 | 1.00 |
| PHF Adj:                                    | 1.00        | 1.00 | 1.00 | 1.00        | 1.00 | 1.00 | 1.00       | 1.00 | 1.00 | 1.00       | 1.00 | 1.00 |
| PHF Volume:                                 | 326         | 2048 | 388  | 17          | 452  | 490  | 211        | 32   | 149  | 43         | 7    | 30   |
| Reduct Vol:                                 | 0           | 0    | 0    | 0           | 0    | 0    | 0          | 0    | 0    | 0          | 0    | 0    |
| Reduced Vol:                                | 326         | 2048 | 388  | 17          | 452  | 490  | 211        | 32   | 149  | 43         | 7    | 30   |
| PCE Adj:                                    | 1.00        | 1.00 | 1.00 | 1.00        | 1.00 | 1.00 | 1.00       | 1.00 | 1.00 | 1.00       | 1.00 | 1.00 |
| MLF Adj:                                    | 1.00        | 1.00 | 1.00 | 1.00        | 1.00 | 1.00 | 1.00       | 1.00 | 1.00 | 1.00       | 1.00 | 1.00 |
| Final Volume:                               | 326         | 2048 | 388  | 17          | 452  | 490  | 211        | 32   | 149  | 43         | 7    | 30   |
| Saturation Flow Module:                     |             |      |      |             |      |      |            |      |      |            |      |      |
| Sat/Lane:                                   | 1900        | 1900 | 1900 | 1900        | 1900 | 1900 | 1900       | 1900 | 1900 | 1900       | 1900 | 1900 |
| Adjustment:                                 | 0.92        | 1.00 | 0.92 | 0.92        | 1.00 | 0.92 | 0.92       | 0.95 | 0.95 | 0.92       | 0.95 | 0.95 |
| Lanes:                                      | 1.00        | 3.00 | 1.00 | 1.00        | 2.00 | 1.00 | 1.00       | 0.18 | 0.82 | 1.00       | 0.19 | 0.81 |
| Final Sat.:                                 | 1750        | 5700 | 1750 | 1750        | 3800 | 1750 | 1750       | 318  | 1482 | 1750       | 341  | 1459 |
| Capacity Analysis Module:                   |             |      |      |             |      |      |            |      |      |            |      |      |
| Vol/Sat:                                    | 0.19        | 0.36 | 0.22 | 0.01        | 0.12 | 0.28 | 0.12       | 0.10 | 0.10 | 0.02       | 0.02 | 0.02 |
| Crit Moves:                                 | ****        | **** | **** | ****        | **** | **** | ****       | **** | **** | ****       | **** | **** |
| Green Time:                                 | 28.4        | 45.7 | 56.1 | 7.0         | 24.3 | 39.6 | 15.3       | 14.9 | 14.9 | 10.4       | 10.0 | 10.0 |
| Volume/Cap:                                 | 0.59        | 0.71 | 0.36 | 0.12        | 0.44 | 0.64 | 0.71       | 0.61 | 0.61 | 0.21       | 0.19 | 0.19 |
| Delay/Veh:                                  | 27.6        | 17.9 | 8.4  | 39.1        | 27.5 | 21.4 | 42.9       | 38.4 | 38.4 | 36.6       | 36.8 | 36.8 |
| User DelAdj:                                | 1.00        | 1.00 | 1.00 | 1.00        | 1.00 | 1.00 | 1.00       | 1.00 | 1.00 | 1.00       | 1.00 | 1.00 |
| AdjDel/Veh:                                 | 27.6        | 17.9 | 8.4  | 39.1        | 27.5 | 21.4 | 42.9       | 38.4 | 38.4 | 36.6       | 36.8 | 36.8 |
| LOS by Move:                                | C           | B    | A    | D           | C    | C    | D          | D    | D    | D          | D    | D    |
| HCM2k95thQ:                                 | 14          | 24   | 10   | 1           | 10   | 21   | 14         | 11   | 11   | 2          | 2    | 2    |

Note: Queue reported is the number of cars per lane.

BART

Level Of Service Computation Report  
 2000 HCM Operations (Future Volume Alternative)  
 PM - Exist + Proj Conditions

Intersection #9: Coleman/Brokaw [Study Int 33]

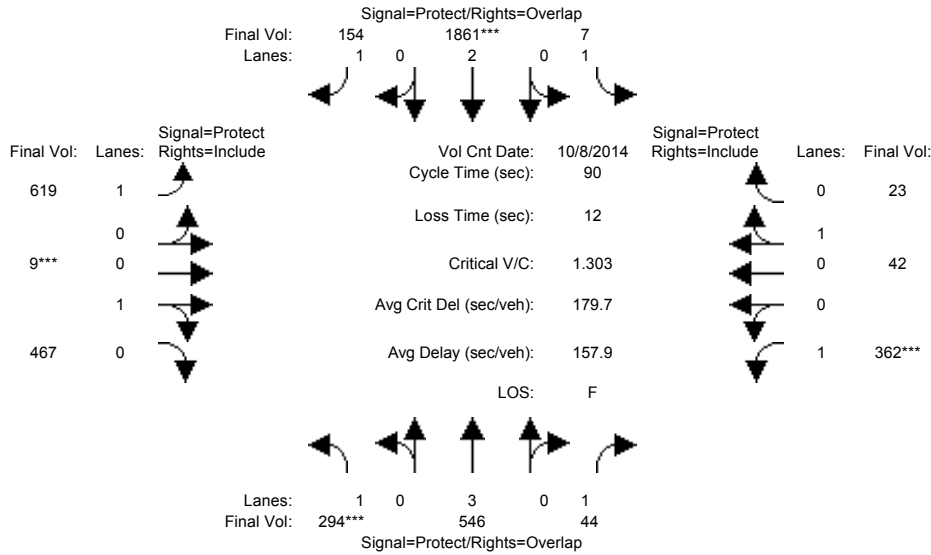

| Approach:                                   | North Bound |      |      | South Bound |      |      | East Bound |      |       | West Bound |      |      |
|---|-------------|------|------|-------------|------|------|------------|------|-------|------------|------|------|
| Movement:                                   | L           | T    | R    | L           | T    | R    | L          | T    | R     | L          | T    | R    |
| Min. Green:                                 | 7           | 10   | 10   | 7           | 10   | 10   | 7          | 10   | 10    | 7          | 10   | 10   |
| Y+R:  | 4.0         | 4.0  | 4.0  | 4.0         | 4.0  | 4.0  | 4.0        | 4.0  | 4.0   | 4.0        | 4.0  | 4.0  |
| Volume Module: >> Count Date: 8 Oct 2014 << |             |      |      |             |      |      |            |      |       |            |      |      |
| Base Vol:                                   | 294         | 546  | 44   | 7           | 1861 | 154  | 619        | 9    | 467   | 362        | 42   | 23   |
| Growth Adj:                                 | 1.00        | 1.00 | 1.00 | 1.00        | 1.00 | 1.00 | 1.00       | 1.00 | 1.00  | 1.00       | 1.00 | 1.00 |
| Initial Bse:                                | 294         | 546  | 44   | 7           | 1861 | 154  | 619        | 9    | 467   | 362        | 42   | 23   |
| Added Vol:                                  | 0           | 0    | 0    | 0           | 0    | 0    | 0          | 0    | 0     | 0          | 0    | 0    |
| PasserByVol:                                | 0           | 0    | 0    | 0           | 0    | 0    | 0          | 0    | 0     | 0          | 0    | 0    |
| Initial Fut:                                | 294         | 546  | 44   | 7           | 1861 | 154  | 619        | 9    | 467   | 362        | 42   | 23   |
| User Adj:                                   | 1.00        | 1.00 | 1.00 | 1.00        | 1.00 | 1.00 | 1.00       | 1.00 | 1.00  | 1.00       | 1.00 | 1.00 |
| PHF Adj:                                    | 1.00        | 1.00 | 1.00 | 1.00        | 1.00 | 1.00 | 1.00       | 1.00 | 1.00  | 1.00       | 1.00 | 1.00 |
| PHF Volume:                                 | 294         | 546  | 44   | 7           | 1861 | 154  | 619        | 9    | 467   | 362        | 42   | 23   |
| Reduct Vol:                                 | 0           | 0    | 0    | 0           | 0    | 0    | 0          | 0    | 0     | 0          | 0    | 0    |
| Reduced Vol:                                | 294         | 546  | 44   | 7           | 1861 | 154  | 619        | 9    | 467   | 362        | 42   | 23   |
| PCE Adj:                                    | 1.00        | 1.00 | 1.00 | 1.00        | 1.00 | 1.00 | 1.00       | 1.00 | 1.00  | 1.00       | 1.00 | 1.00 |
| MLF Adj:                                    | 1.00        | 1.00 | 1.00 | 1.00        | 1.00 | 1.00 | 1.00       | 1.00 | 1.00  | 1.00       | 1.00 | 1.00 |
| Final Volume:                               | 294         | 546  | 44   | 7           | 1861 | 154  | 619        | 9    | 467   | 362        | 42   | 23   |
| Saturation Flow Module:                     |             |      |      |             |      |      |            |      |       |            |      |      |
| Sat/Lane:                                   | 1900        | 1900 | 1900 | 1900        | 1900 | 1900 | 1900       | 1900 | 1900  | 1900       | 1900 | 1900 |
| Adjustment:                                 | 0.92        | 1.00 | 0.92 | 0.92        | 1.00 | 0.92 | 0.92       | 0.95 | 0.95  | 0.92       | 0.95 | 0.95 |
| Lanes:                                      | 1.00        | 3.00 | 1.00 | 1.00        | 2.00 | 1.00 | 1.00       | 0.02 | 0.98  | 1.00       | 0.65 | 0.35 |
| Final Sat.:                                 | 1750        | 5700 | 1750 | 1750        | 3800 | 1750 | 1750       | 34   | 1766  | 1750       | 1163 | 637  |
| Capacity Analysis Module:                   |             |      |      |             |      |      |            |      |       |            |      |      |
| Vol/Sat:                                    | 0.17        | 0.10 | 0.03 | 0.00        | 0.49 | 0.09 | 0.35       | 0.26 | 0.26  | 0.21       | 0.04 | 0.04 |
| Crit Moves:                                 | ****        |      |      | ****        |      |      | ****       |      |       | ****       |      |      |
| Green Time:                                 | 11.6        | 26.7 | 41.0 | 18.7        | 33.8 | 56.4 | 22.6       | 18.3 | 18.3  | 14.3       | 10.0 | 10.0 |
| Volume/Cap:                                 | 1.30        | 0.32 | 0.06 | 0.02        | 1.30 | 0.14 | 1.41       | 1.30 | 1.30  | 1.30       | 0.33 | 0.33 |
| Delay/Veh:                                  | 203.8       | 24.7 | 13.7 | 28.4        | 170  | 6.9  | 231.9      | 191  | 190.7 | 197.8      | 37.8 | 37.8 |
| User DelAdj:                                | 1.00        | 1.00 | 1.00 | 1.00        | 1.00 | 1.00 | 1.00       | 1.00 | 1.00  | 1.00       | 1.00 | 1.00 |
| AdjDel/Veh:                                 | 203.8       | 24.7 | 13.7 | 28.4        | 170  | 6.9  | 231.9      | 191  | 190.7 | 197.8      | 37.8 | 37.8 |
| LOS by Move:                                | F           | C    | B    | C           | F    | A    | F          | F    | F     | F          | D    | D    |
| HCM2k95thQ:                                 | 31          | 7    | 1    | 0           | 81   | 4    | 69         | 49   | 49    | 38         | 4    | 4    |

Note: Queue reported is the number of cars per lane.

BART

Level Of Service Computation Report  
 2000 HCM Operations (Future Volume Alternative)  
 AM - Exist + Proj Conditions

Intersection #106: Benton/E/ Camino Real [Study Int 52]

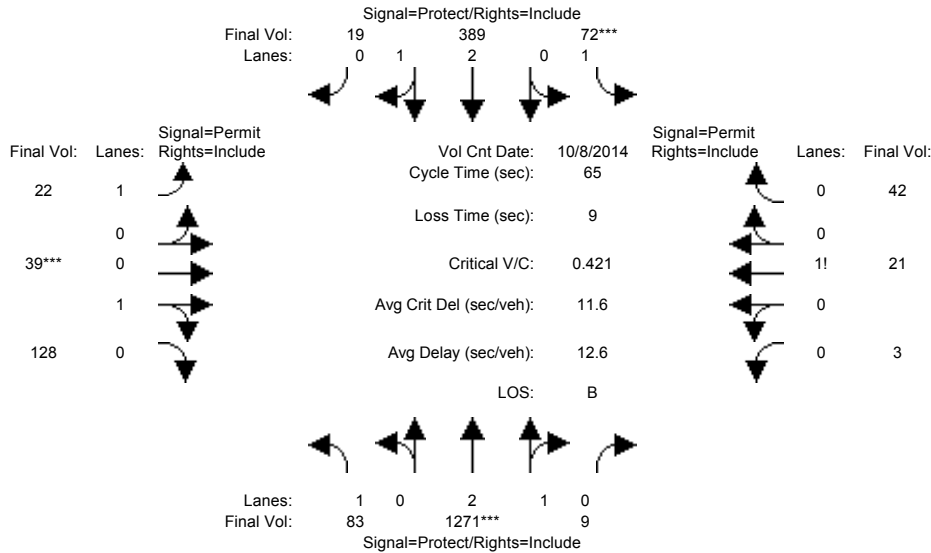

| Approach:                                   | North Bound |      |      | South Bound |      |      | East Bound |      |      | West Bound |      |      |
|---|-------------|------|------|-------------|------|------|------------|------|------|------------|------|------|
| Movement:                                   | L           | T    | R    | L           | T    | R    | L          | T    | R    | L          | T    | R    |
| Min. Green:                                 | 7           | 10   | 10   | 7           | 10   | 10   | 10         | 10   | 10   | 10         | 10   | 10   |
| Y+R:  | 4.0         | 4.0  | 4.0  | 4.0         | 4.0  | 4.0  | 4.0        | 4.0  | 4.0  | 4.0        | 4.0  | 4.0  |
| Volume Module: >> Count Date: 8 Oct 2014 << |             |      |      |             |      |      |            |      |      |            |      |      |
| Base Vol:                                   | 83          | 1271 | 9    | 72          | 389  | 19   | 22         | 39   | 128  | 3          | 21   | 42   |
| Growth Adj:                                 | 1.00        | 1.00 | 1.00 | 1.00        | 1.00 | 1.00 | 1.00       | 1.00 | 1.00 | 1.00       | 1.00 | 1.00 |
| Initial Bse:                                | 83          | 1271 | 9    | 72          | 389  | 19   | 22         | 39   | 128  | 3          | 21   | 42   |
| Added Vol:                                  | 0           | 0    | 0    | 0           | 0    | 0    | 0          | 0    | 0    | 0          | 0    | 0    |
| PasserByVol:                                | 0           | 0    | 0    | 0           | 0    | 0    | 0          | 0    | 0    | 0          | 0    | 0    |
| Initial Fut:                                | 83          | 1271 | 9    | 72          | 389  | 19   | 22         | 39   | 128  | 3          | 21   | 42   |
| User Adj:                                   | 1.00        | 1.00 | 1.00 | 1.00        | 1.00 | 1.00 | 1.00       | 1.00 | 1.00 | 1.00       | 1.00 | 1.00 |
| PHF Adj:                                    | 1.00        | 1.00 | 1.00 | 1.00        | 1.00 | 1.00 | 1.00       | 1.00 | 1.00 | 1.00       | 1.00 | 1.00 |
| PHF Volume:                                 | 83          | 1271 | 9    | 72          | 389  | 19   | 22         | 39   | 128  | 3          | 21   | 42   |
| Reduct Vol:                                 | 0           | 0    | 0    | 0           | 0    | 0    | 0          | 0    | 0    | 0          | 0    | 0    |
| Reduced Vol:                                | 83          | 1271 | 9    | 72          | 389  | 19   | 22         | 39   | 128  | 3          | 21   | 42   |
| PCE Adj:                                    | 1.00        | 1.00 | 1.00 | 1.00        | 1.00 | 1.00 | 1.00       | 1.00 | 1.00 | 1.00       | 1.00 | 1.00 |
| MLF Adj:                                    | 1.00        | 1.00 | 1.00 | 1.00        | 1.00 | 1.00 | 1.00       | 1.00 | 1.00 | 1.00       | 1.00 | 1.00 |
| FinalVolume:                                | 83          | 1271 | 9    | 72          | 389  | 19   | 22         | 39   | 128  | 3          | 21   | 42   |
| Saturation Flow Module:                     |             |      |      |             |      |      |            |      |      |            |      |      |
| Sat/Lane:                                   | 1900        | 1900 | 1900 | 1900        | 1900 | 1900 | 1900       | 1900 | 1900 | 1900       | 1900 | 1900 |
| Adjustment:                                 | 0.92        | 0.98 | 0.95 | 0.92        | 0.98 | 0.95 | 0.92       | 0.95 | 0.95 | 0.92       | 0.92 | 0.92 |
| Lanes:                                      | 1.00        | 2.98 | 0.02 | 1.00        | 2.86 | 0.14 | 1.00       | 0.23 | 0.77 | 0.04       | 0.32 | 0.64 |
| Final Sat.:                                 | 1750        | 5561 | 39   | 1750        | 5339 | 261  | 1750       | 420  | 1380 | 80         | 557  | 1114 |
| Capacity Analysis Module:                   |             |      |      |             |      |      |            |      |      |            |      |      |
| Vol/Sat:                                    | 0.05        | 0.23 | 0.23 | 0.04        | 0.07 | 0.07 | 0.01       | 0.09 | 0.09 | 0.04       | 0.04 | 0.04 |
| Crit Moves:                                 | ****        | **** | **** | ****        | **** | **** | ****       | **** | **** | ****       | **** | **** |
| Green Time:                                 | 17.2        | 34.9 | 34.9 | 7.0         | 24.6 | 24.6 | 14.1       | 14.1 | 14.1 | 14.1       | 14.1 | 14.1 |
| Volume/Cap:                                 | 0.18        | 0.43 | 0.43 | 0.38        | 0.19 | 0.19 | 0.06       | 0.43 | 0.43 | 0.17       | 0.17 | 0.17 |
| Delay/Veh:                                  | 18.6        | 9.2  | 9.2  | 28.3        | 13.6 | 13.6 | 20.2       | 22.7 | 22.7 | 20.9       | 20.9 | 20.9 |
| User DelAdj:                                | 1.00        | 1.00 | 1.00 | 1.00        | 1.00 | 1.00 | 1.00       | 1.00 | 1.00 | 1.00       | 1.00 | 1.00 |
| AdjDel/Veh:                                 | 18.6        | 9.2  | 9.2  | 28.3        | 13.6 | 13.6 | 20.2       | 22.7 | 22.7 | 20.9       | 20.9 | 20.9 |
| LOS by Move:                                | B           | A    | A    | C           | B    | B    | C          | C    | C    | C          | C    | C    |
| HCM2k95thQ:                                 | 3           | 10   | 10   | 3           | 4    | 4    | 1          | 6    | 6    | 3          | 3    | 3    |

Note: Queue reported is the number of cars per lane.



BART

Level Of Service Computation Report  
2000 HCM Operations (Future Volume Alternative)  
PM - Exist + Proj Conditions

Intersection #106: Benton/E/ Camino Real [Study Int 52]

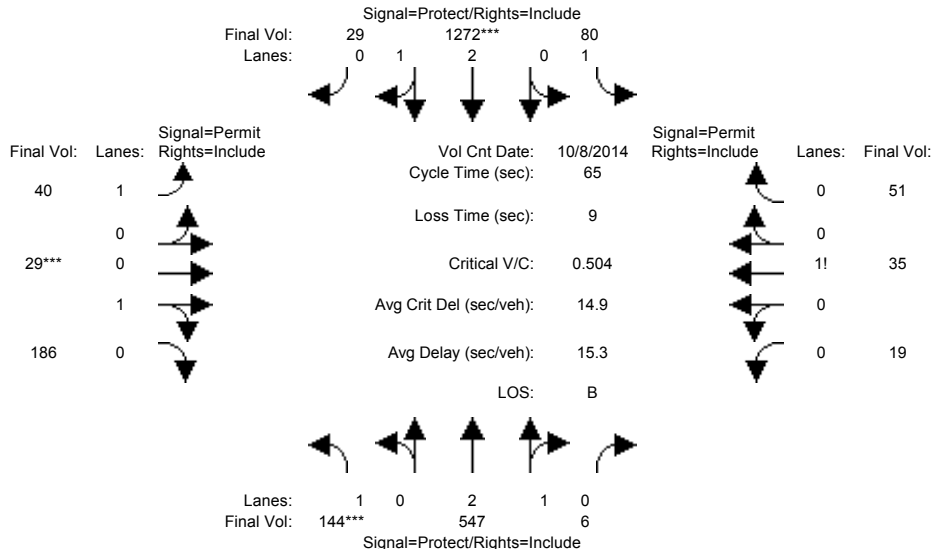

| Approach:                                   | North Bound |      |      | South Bound |      |      | East Bound |      |      | West Bound |      |      |
|---|-------------|------|------|-------------|------|------|------------|------|------|------------|------|------|
| Movement:                                   | L           | T    | R    | L           | T    | R    | L          | T    | R    | L          | T    | R    |
| Min. Green:                                 | 7           | 10   | 10   | 7           | 10   | 10   | 10         | 10   | 10   | 10         | 10   | 10   |
| Y+R:  | 4.0         | 4.0  | 4.0  | 4.0         | 4.0  | 4.0  | 4.0        | 4.0  | 4.0  | 4.0        | 4.0  | 4.0  |
| Volume Module: >> Count Date: 8 Oct 2014 << |             |      |      |             |      |      |            |      |      |            |      |      |
| Base Vol:                                   | 144         | 547  | 6    | 80          | 1272 | 29   | 40         | 29   | 186  | 19         | 35   | 51   |
| Growth Adj:                                 | 1.00        | 1.00 | 1.00 | 1.00        | 1.00 | 1.00 | 1.00       | 1.00 | 1.00 | 1.00       | 1.00 | 1.00 |
| Initial Bse:                                | 144         | 547  | 6    | 80          | 1272 | 29   | 40         | 29   | 186  | 19         | 35   | 51   |
| Added Vol:                                  | 0           | 0    | 0    | 0           | 0    | 0    | 0          | 0    | 0    | 0          | 0    | 0    |
| PasserByVol:                                | 0           | 0    | 0    | 0           | 0    | 0    | 0          | 0    | 0    | 0          | 0    | 0    |
| Initial Fut:                                | 144         | 547  | 6    | 80          | 1272 | 29   | 40         | 29   | 186  | 19         | 35   | 51   |
| User Adj:                                   | 1.00        | 1.00 | 1.00 | 1.00        | 1.00 | 1.00 | 1.00       | 1.00 | 1.00 | 1.00       | 1.00 | 1.00 |
| PHF Adj:                                    | 1.00        | 1.00 | 1.00 | 1.00        | 1.00 | 1.00 | 1.00       | 1.00 | 1.00 | 1.00       | 1.00 | 1.00 |
| PHF Volume:                                 | 144         | 547  | 6    | 80          | 1272 | 29   | 40         | 29   | 186  | 19         | 35   | 51   |
| Reduct Vol:                                 | 0           | 0    | 0    | 0           | 0    | 0    | 0          | 0    | 0    | 0          | 0    | 0    |
| Reduced Vol:                                | 144         | 547  | 6    | 80          | 1272 | 29   | 40         | 29   | 186  | 19         | 35   | 51   |
| PCE Adj:                                    | 1.00        | 1.00 | 1.00 | 1.00        | 1.00 | 1.00 | 1.00       | 1.00 | 1.00 | 1.00       | 1.00 | 1.00 |
| MLF Adj:                                    | 1.00        | 1.00 | 1.00 | 1.00        | 1.00 | 1.00 | 1.00       | 1.00 | 1.00 | 1.00       | 1.00 | 1.00 |
| Final Volume:                               | 144         | 547  | 6    | 80          | 1272 | 29   | 40         | 29   | 186  | 19         | 35   | 51   |
| Saturation Flow Module:                     |             |      |      |             |      |      |            |      |      |            |      |      |
| Sat/Lane:                                   | 1900        | 1900 | 1900 | 1900        | 1900 | 1900 | 1900       | 1900 | 1900 | 1900       | 1900 | 1900 |
| Adjustment:                                 | 0.92        | 0.98 | 0.95 | 0.92        | 0.98 | 0.95 | 0.92       | 0.95 | 0.95 | 0.92       | 0.92 | 0.92 |
| Lanes:                                      | 1.00        | 2.97 | 0.03 | 1.00        | 2.93 | 0.07 | 1.00       | 0.13 | 0.87 | 0.18       | 0.33 | 0.49 |
| Final Sat.:                                 | 1750        | 5539 | 61   | 1750        | 5475 | 125  | 1750       | 243  | 1557 | 317        | 583  | 850  |
| Capacity Analysis Module:                   |             |      |      |             |      |      |            |      |      |            |      |      |
| Vol/Sat:                                    | 0.08        | 0.10 | 0.10 | 0.05        | 0.23 | 0.23 | 0.02       | 0.12 | 0.12 | 0.06       | 0.06 | 0.06 |
| Crit Moves:                                 | ****        |      |      | ****        |      |      | ****       |      |      |            |      |      |
| Green Time:                                 | 10.6        | 23.9 | 23.9 | 16.7        | 30.0 | 30.0 | 15.4       | 15.4 | 15.4 | 15.4       | 15.4 | 15.4 |
| Volume/Cap:                                 | 0.50        | 0.27 | 0.27 | 0.18        | 0.50 | 0.50 | 0.10       | 0.50 | 0.50 | 0.25       | 0.25 | 0.25 |
| Delay/Veh:                                  | 26.2        | 14.5 | 14.5 | 19.0        | 12.5 | 12.5 | 19.5       | 22.4 | 22.4 | 20.4       | 20.4 | 20.4 |
| User DelAdj:                                | 1.00        | 1.00 | 1.00 | 1.00        | 1.00 | 1.00 | 1.00       | 1.00 | 1.00 | 1.00       | 1.00 | 1.00 |
| AdjDel/Veh:                                 | 26.2        | 14.5 | 14.5 | 19.0        | 12.5 | 12.5 | 19.5       | 22.4 | 22.4 | 20.4       | 20.4 | 20.4 |
| LOS by Move:                                | C           | B    | B    | B           | B    | B    | B          | C    | C    | C          | C    | C    |
| HCM2k95thQ:                                 | 6           | 5    | 5    | 3           | 12   | 12   | 1          | 8    | 8    | 4          | 4    | 4    |

Note: Queue reported is the number of cars per lane.

BART

Level Of Service Computation Report  
 2000 HCM Operations (Future Volume Alternative)  
 AM - Exist + Proj Conditions

Intersection #107: Lafayette/Benton [Study Int 49]

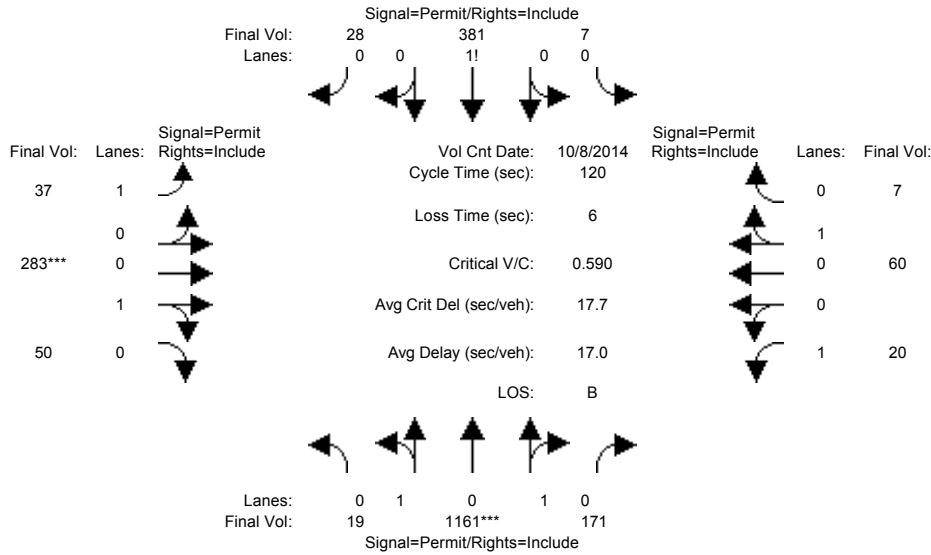

| Approach:                 | North Bound                  |      |      | South Bound |      |      | East Bound |      |      | West Bound |      |      |
|---------------------------|------------------------------|------|------|-------------|------|------|------------|------|------|------------|------|------|
| Movement:                 | L                            | T    | R    | L           | T    | R    | L          | T    | R    | L          | T    | R    |
| Min. Green:               | 10                           | 10   | 10   | 10          | 10   | 10   | 10         | 10   | 10   | 10         | 10   | 10   |
| Y+R:                      | 4.0                          | 4.0  | 4.0  | 4.0         | 4.0  | 4.0  | 4.0        | 4.0  | 4.0  | 4.0        | 4.0  | 4.0  |
| -----                     |                              |      |      |             |      |      |            |      |      |            |      |      |
| Volume Module:            | >> Count Date: 8 Oct 2014 << |      |      |             |      |      |            |      |      |            |      |      |
| Base Vol:                 | 19                           | 1161 | 171  | 7           | 381  | 28   | 37         | 283  | 50   | 20         | 60   | 7    |
| Growth Adj:               | 1.00                         | 1.00 | 1.00 | 1.00        | 1.00 | 1.00 | 1.00       | 1.00 | 1.00 | 1.00       | 1.00 | 1.00 |
| Initial Bse:              | 19                           | 1161 | 171  | 7           | 381  | 28   | 37         | 283  | 50   | 20         | 60   | 7    |
| Added Vol:                | 0                            | 0    | 0    | 0           | 0    | 0    | 0          | 0    | 0    | 0          | 0    | 0    |
| PasserByVol:              | 0                            | 0    | 0    | 0           | 0    | 0    | 0          | 0    | 0    | 0          | 0    | 0    |
| Initial Fut:              | 19                           | 1161 | 171  | 7           | 381  | 28   | 37         | 283  | 50   | 20         | 60   | 7    |
| User Adj:                 | 1.00                         | 1.00 | 1.00 | 1.00        | 1.00 | 1.00 | 1.00       | 1.00 | 1.00 | 1.00       | 1.00 | 1.00 |
| PHF Adj:                  | 1.00                         | 1.00 | 1.00 | 1.00        | 1.00 | 1.00 | 1.00       | 1.00 | 1.00 | 1.00       | 1.00 | 1.00 |
| PHF Volume:               | 19                           | 1161 | 171  | 7           | 381  | 28   | 37         | 283  | 50   | 20         | 60   | 7    |
| Reduct Vol:               | 0                            | 0    | 0    | 0           | 0    | 0    | 0          | 0    | 0    | 0          | 0    | 0    |
| Reduced Vol:              | 19                           | 1161 | 171  | 7           | 381  | 28   | 37         | 283  | 50   | 20         | 60   | 7    |
| PCE Adj:                  | 1.00                         | 1.00 | 1.00 | 1.00        | 1.00 | 1.00 | 1.00       | 1.00 | 1.00 | 1.00       | 1.00 | 1.00 |
| MLF Adj:                  | 1.00                         | 1.00 | 1.00 | 1.00        | 1.00 | 1.00 | 1.00       | 1.00 | 1.00 | 1.00       | 1.00 | 1.00 |
| Final Volume:             | 19                           | 1161 | 171  | 7           | 381  | 28   | 37         | 283  | 50   | 20         | 60   | 7    |
| -----                     |                              |      |      |             |      |      |            |      |      |            |      |      |
| Saturation Flow Module:   |                              |      |      |             |      |      |            |      |      |            |      |      |
| Sat/Lane:                 | 1900                         | 1900 | 1900 | 1900        | 1900 | 1900 | 1900       | 1900 | 1900 | 1900       | 1900 | 1900 |
| Adjustment:               | 0.95                         | 0.95 | 0.95 | 0.92        | 0.92 | 0.92 | 0.92       | 0.95 | 0.95 | 0.92       | 0.95 | 0.95 |
| Lanes:                    | 0.03                         | 1.72 | 0.25 | 0.02        | 0.91 | 0.07 | 1.00       | 0.85 | 0.15 | 1.00       | 0.90 | 0.10 |
| Final Sat.:               | 51                           | 3094 | 456  | 29          | 1603 | 118  | 1750       | 1530 | 270  | 1750       | 1612 | 188  |
| -----                     |                              |      |      |             |      |      |            |      |      |            |      |      |
| Capacity Analysis Module: |                              |      |      |             |      |      |            |      |      |            |      |      |
| Vol/Sat:                  | 0.38                         | 0.38 | 0.38 | 0.24        | 0.24 | 0.24 | 0.02       | 0.19 | 0.19 | 0.01       | 0.04 | 0.04 |
| Crit Moves:               | ****                         |      |      |             |      |      | ****       |      |      |            |      |      |
| Green Time:               | 76.4                         | 76.4 | 76.4 | 76.4        | 76.4 | 76.4 | 37.6       | 37.6 | 37.6 | 37.6       | 37.6 | 37.6 |
| Volume/Cap:               | 0.59                         | 0.59 | 0.59 | 0.37        | 0.37 | 0.37 | 0.07       | 0.59 | 0.59 | 0.04       | 0.12 | 0.12 |
| Delay/Veh:                | 13.1                         | 13.1 | 13.1 | 10.6        | 10.6 | 10.6 | 28.9       | 36.3 | 36.3 | 28.6       | 29.4 | 29.4 |
| User DelAdj:              | 1.00                         | 1.00 | 1.00 | 1.00        | 1.00 | 1.00 | 1.00       | 1.00 | 1.00 | 1.00       | 1.00 | 1.00 |
| AdjDel/Veh:               | 13.1                         | 13.1 | 13.1 | 10.6        | 10.6 | 10.6 | 28.9       | 36.3 | 36.3 | 28.6       | 29.4 | 29.4 |
| LOS by Move:              | B                            | B    | B    | B           | B    | B    | C          | D    | D    | C          | C    | C    |
| HCM2k95thQ:               | 25                           | 25   | 25   | 15          | 15   | 15   | 2          | 20   | 20   | 1          | 4    | 4    |

Note: Queue reported is the number of cars per lane.

BART

Level Of Service Computation Report  
 2000 HCM Operations (Future Volume Alternative)  
 PM - Exist + Proj Conditions

Intersection #107: Lafayette/Benton [Study Int 49]

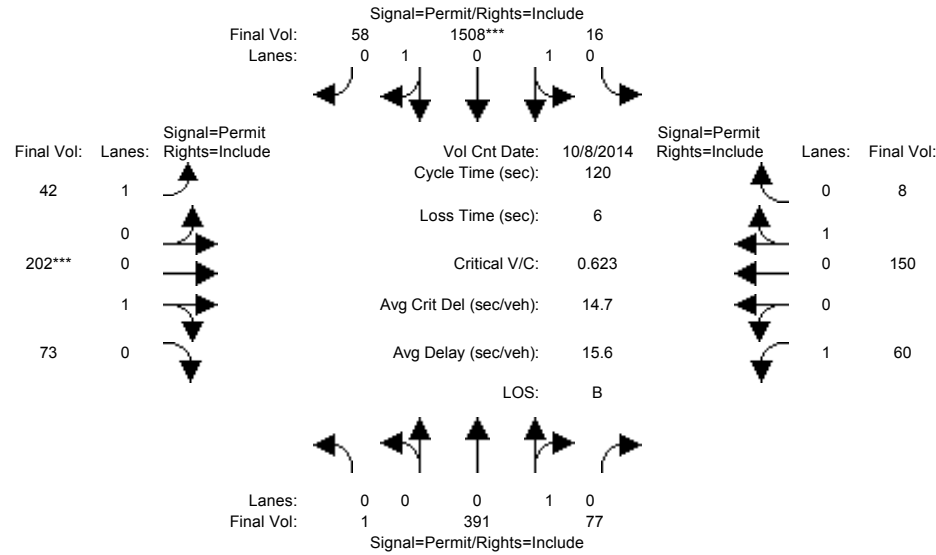

| Approach:                                   | North Bound |      |      | South Bound |      |      | East Bound |      |      | West Bound |      |      |
|---|-------------|------|------|-------------|------|------|------------|------|------|------------|------|------|
| Movement:                                   | L           | T    | R    | L           | T    | R    | L          | T    | R    | L          | T    | R    |
| Min. Green:                                 | 10          | 10   | 10   | 10          | 10   | 10   | 10         | 10   | 10   | 10         | 10   | 10   |
| Y+R:  | 4.0         | 4.0  | 4.0  | 4.0         | 4.0  | 4.0  | 4.0        | 4.0  | 4.0  | 4.0        | 4.0  | 4.0  |
| Volume Module: >> Count Date: 8 Oct 2014 << |             |      |      |             |      |      |            |      |      |            |      |      |
| Base Vol:                                   | 1           | 391  | 77   | 16          | 1508 | 58   | 42         | 202  | 73   | 60         | 150  | 8    |
| Growth Adj:                                 | 1.00        | 1.00 | 1.00 | 1.00        | 1.00 | 1.00 | 1.00       | 1.00 | 1.00 | 1.00       | 1.00 | 1.00 |
| Initial Bse:                                | 1           | 391  | 77   | 16          | 1508 | 58   | 42         | 202  | 73   | 60         | 150  | 8    |
| Added Vol:                                  | 0           | 0    | 0    | 0           | 0    | 0    | 0          | 0    | 0    | 0          | 0    | 0    |
| PasserByVol:                                | 0           | 0    | 0    | 0           | 0    | 0    | 0          | 0    | 0    | 0          | 0    | 0    |
| Initial Fut:                                | 1           | 391  | 77   | 16          | 1508 | 58   | 42         | 202  | 73   | 60         | 150  | 8    |
| User Adj:                                   | 1.00        | 1.00 | 1.00 | 1.00        | 1.00 | 1.00 | 1.00       | 1.00 | 1.00 | 1.00       | 1.00 | 1.00 |
| PHF Adj:                                    | 1.00        | 1.00 | 1.00 | 1.00        | 1.00 | 1.00 | 1.00       | 1.00 | 1.00 | 1.00       | 1.00 | 1.00 |
| PHF Volume:                                 | 1           | 391  | 77   | 16          | 1508 | 58   | 42         | 202  | 73   | 60         | 150  | 8    |
| Reduct Vol:                                 | 0           | 0    | 0    | 0           | 0    | 0    | 0          | 0    | 0    | 0          | 0    | 0    |
| Reduced Vol:                                | 1           | 391  | 77   | 16          | 1508 | 58   | 42         | 202  | 73   | 60         | 150  | 8    |
| PCE Adj:                                    | 1.00        | 1.00 | 1.00 | 1.00        | 1.00 | 1.00 | 1.00       | 1.00 | 1.00 | 1.00       | 1.00 | 1.00 |
| MLF Adj:                                    | 1.00        | 1.00 | 1.00 | 1.00        | 1.00 | 1.00 | 1.00       | 1.00 | 1.00 | 1.00       | 1.00 | 1.00 |
| Final Volume:                               | 1           | 391  | 77   | 16          | 1508 | 58   | 42         | 202  | 73   | 60         | 150  | 8    |
| Saturation Flow Module:                     |             |      |      |             |      |      |            |      |      |            |      |      |
| Sat/Lane:                                   | 1900        | 1900 | 1900 | 1900        | 1900 | 1900 | 1900       | 1900 | 1900 | 1900       | 1900 | 1900 |
| Adjustment:                                 | 0.92        | 0.92 | 0.92 | 0.95        | 0.95 | 0.95 | 0.92       | 0.95 | 0.95 | 0.92       | 0.95 | 0.95 |
| Lanes:                                      | 0.01        | 0.83 | 0.16 | 0.02        | 1.91 | 0.07 | 1.00       | 0.73 | 0.27 | 1.00       | 0.95 | 0.05 |
| Final Sat.:                                 | 4           | 1459 | 287  | 36          | 3432 | 132  | 1750       | 1322 | 478  | 1750       | 1709 | 91   |
| Capacity Analysis Module:                   |             |      |      |             |      |      |            |      |      |            |      |      |
| Vol/Sat:                                    | 0.27        | 0.27 | 0.27 | 0.44        | 0.44 | 0.44 | 0.02       | 0.15 | 0.15 | 0.03       | 0.09 | 0.09 |
| Crit Moves:                                 | *****       |      |      |             |      |      |            |      |      |            |      |      |
| Green Time:                                 | 84.6        | 84.6 | 84.6 | 84.6        | 84.6 | 84.6 | 29.4       | 29.4 | 29.4 | 29.4       | 29.4 | 29.4 |
| Volume/Cap:                                 | 0.38        | 0.38 | 0.38 | 0.62        | 0.62 | 0.62 | 0.10       | 0.62 | 0.62 | 0.14       | 0.36 | 0.36 |
| Delay/Veh:                                  | 7.3         | 7.3  | 7.3  | 9.8         | 9.8  | 9.8  | 35.1       | 43.1 | 43.1 | 35.6       | 38.0 | 38.0 |
| User DelAdj:                                | 1.00        | 1.00 | 1.00 | 1.00        | 1.00 | 1.00 | 1.00       | 1.00 | 1.00 | 1.00       | 1.00 | 1.00 |
| AdjDel/Veh:                                 | 7.3         | 7.3  | 7.3  | 9.8         | 9.8  | 9.8  | 35.1       | 43.1 | 43.1 | 35.6       | 38.0 | 38.0 |
| LOS by Move:                                | A           | A    | A    | A           | A    | A    | D          | D    | D    | D          | D    | D    |
| HCM2k95thQ:                                 | 14          | 14   | 14   | 27          | 27   | 27   | 3          | 18   | 18   | 4          | 10   | 10   |

Note: Queue reported is the number of cars per lane.

BART

Level Of Service Computation Report  
 2000 HCM Operations (Future Volume Alternative)  
 AM - Exist + Proj Conditions

Intersection #121: Market/Lafayette [Study Int 51]

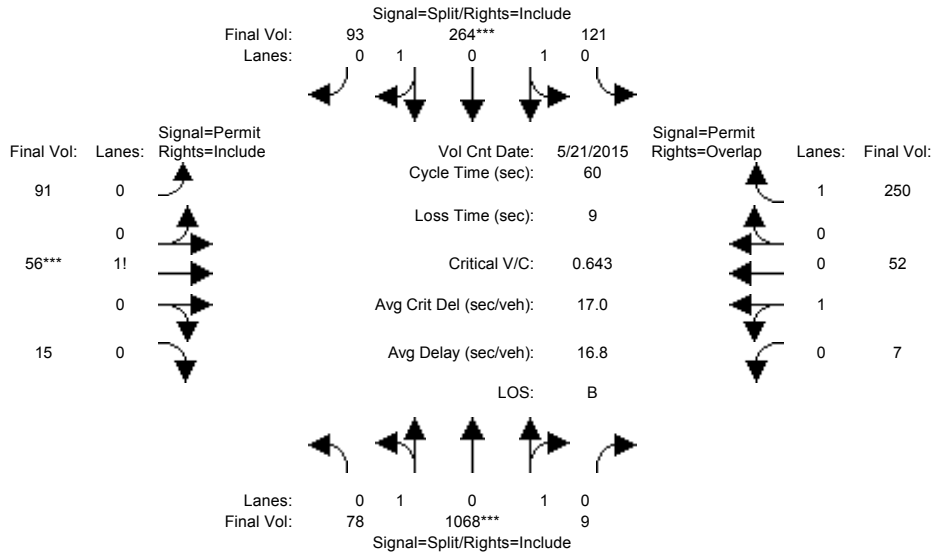

| Approach:                                    | North Bound |      |      | South Bound |      |      | East Bound |      |      | West Bound |      |      |
|--|-------------|------|------|-------------|------|------|------------|------|------|------------|------|------|
| Movement:                                    | L           | T    | R    | L           | T    | R    | L          | T    | R    | L          | T    | R    |
| Min. Green:                                  | 10          | 10   | 10   | 10          | 10   | 10   | 10         | 10   | 10   | 10         | 10   | 10   |
| Y+R:   | 4.0         | 4.0  | 4.0  | 4.0         | 4.0  | 4.0  | 4.0        | 4.0  | 4.0  | 4.0        | 4.0  | 4.0  |
| Volume Module: >> Count Date: 21 May 2015 << |             |      |      |             |      |      |            |      |      |            |      |      |
| Base Vol:                                    | 78          | 1068 | 9    | 121         | 264  | 93   | 91         | 56   | 15   | 7          | 52   | 250  |
| Growth Adj:                                  | 1.00        | 1.00 | 1.00 | 1.00        | 1.00 | 1.00 | 1.00       | 1.00 | 1.00 | 1.00       | 1.00 | 1.00 |
| Initial Bse:                                 | 78          | 1068 | 9    | 121         | 264  | 93   | 91         | 56   | 15   | 7          | 52   | 250  |
| Added Vol:                                   | 0           | 0    | 0    | 0           | 0    | 0    | 0          | 0    | 0    | 0          | 0    | 0    |
| PasserByVol:                                 | 0           | 0    | 0    | 0           | 0    | 0    | 0          | 0    | 0    | 0          | 0    | 0    |
| Initial Fut:                                 | 78          | 1068 | 9    | 121         | 264  | 93   | 91         | 56   | 15   | 7          | 52   | 250  |
| User Adj:                                    | 1.00        | 1.00 | 1.00 | 1.00        | 1.00 | 1.00 | 1.00       | 1.00 | 1.00 | 1.00       | 1.00 | 1.00 |
| PHF Adj:                                     | 1.00        | 1.00 | 1.00 | 1.00        | 1.00 | 1.00 | 1.00       | 1.00 | 1.00 | 1.00       | 1.00 | 1.00 |
| PHF Volume:                                  | 78          | 1068 | 9    | 121         | 264  | 93   | 91         | 56   | 15   | 7          | 52   | 250  |
| Reduct Vol:                                  | 0           | 0    | 0    | 0           | 0    | 0    | 0          | 0    | 0    | 0          | 0    | 0    |
| Reduced Vol:                                 | 78          | 1068 | 9    | 121         | 264  | 93   | 91         | 56   | 15   | 7          | 52   | 250  |
| PCE Adj:                                     | 1.00        | 1.00 | 1.00 | 1.00        | 1.00 | 1.00 | 1.00       | 1.00 | 1.00 | 1.00       | 1.00 | 1.00 |
| MLF Adj:                                     | 1.00        | 1.00 | 1.00 | 1.00        | 1.00 | 1.00 | 1.00       | 1.00 | 1.00 | 1.00       | 1.00 | 1.00 |
| FinalVolume:                                 | 78          | 1068 | 9    | 121         | 264  | 93   | 91         | 56   | 15   | 7          | 52   | 250  |
| Saturation Flow Module:                      |             |      |      |             |      |      |            |      |      |            |      |      |
| Sat/Lane:                                    | 1900        | 1900 | 1900 | 1900        | 1900 | 1900 | 1900       | 1900 | 1900 | 1900       | 1900 | 1900 |
| Adjustment:                                  | 0.95        | 0.95 | 0.95 | 0.95        | 0.95 | 0.95 | 0.92       | 0.92 | 0.92 | 0.95       | 0.95 | 0.92 |
| Lanes:                                       | 0.13        | 1.85 | 0.02 | 0.51        | 1.10 | 0.39 | 0.56       | 0.35 | 0.09 | 0.12       | 0.88 | 1.00 |
| Final Sat.:                                  | 243         | 3329 | 28   | 911         | 1988 | 700  | 983        | 605  | 162  | 214        | 1586 | 1750 |
| Capacity Analysis Module:                    |             |      |      |             |      |      |            |      |      |            |      |      |
| Vol/Sat:                                     | 0.32        | 0.32 | 0.32 | 0.13        | 0.13 | 0.13 | 0.09       | 0.09 | 0.09 | 0.03       | 0.03 | 0.14 |
| Crit Moves:                                  | ****        | **** | **** | ****        | **** | **** | ****       | **** | **** | ****       | **** | **** |
| Green Time:                                  | 29.0        | 29.0 | 29.0 | 12.0        | 12.0 | 12.0 | 10.0       | 10.0 | 10.0 | 10.0       | 10.0 | 22.0 |
| Volume/Cap:                                  | 0.66        | 0.66 | 0.66 | 0.66        | 0.66 | 0.66 | 0.56       | 0.56 | 0.56 | 0.20       | 0.20 | 0.39 |
| Delay/Veh:                                   | 12.8        | 12.8 | 12.8 | 24.5        | 24.5 | 24.5 | 25.3       | 25.3 | 25.3 | 21.9       | 21.9 | 14.4 |
| User DelAdj:                                 | 1.00        | 1.00 | 1.00 | 1.00        | 1.00 | 1.00 | 1.00       | 1.00 | 1.00 | 1.00       | 1.00 | 1.00 |
| AdjDel/Veh:                                  | 12.8        | 12.8 | 12.8 | 24.5        | 24.5 | 24.5 | 25.3       | 25.3 | 25.3 | 21.9       | 21.9 | 14.4 |
| LOS by Move:                                 | B           | B    | B    | C           | C    | C    | C          | C    | C    | C          | C    | B    |
| HCM2k95thQ:                                  | 16          | 16   | 16   | 9           | 9    | 9    | 6          | 6    | 6    | 2          | 2    | 8    |

Note: Queue reported is the number of cars per lane.

BART

Level Of Service Computation Report  
 2000 HCM Operations (Future Volume Alternative)  
 PM - Exist + Proj Conditions

Intersection #121: Market/Lafayette [Study Int 51]

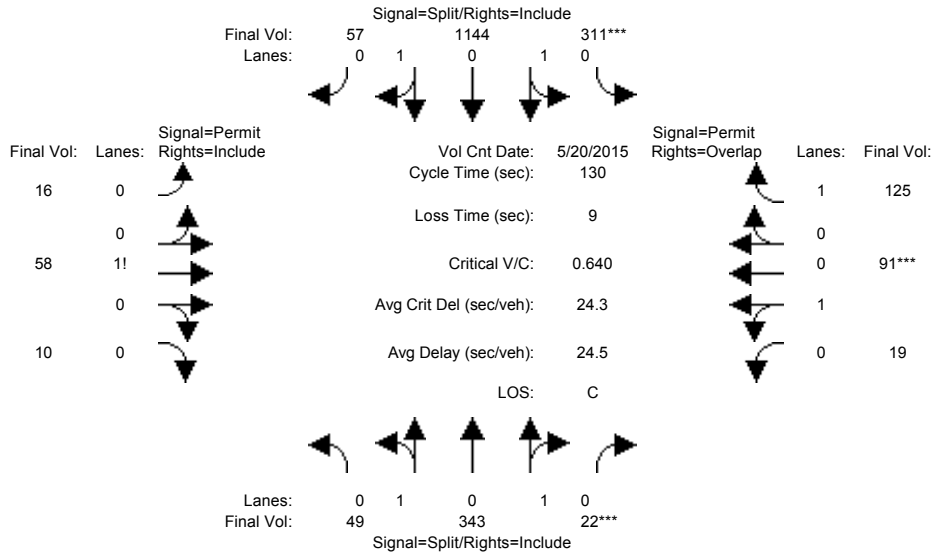

| Approach:                 | North Bound                   |      |      | South Bound |      |      | East Bound |      |      | West Bound |      |      |
|---------------------------|-------------------------------|------|------|-------------|------|------|------------|------|------|------------|------|------|
| Movement:                 | L                             | T    | R    | L           | T    | R    | L          | T    | R    | L          | T    | R    |
| Min. Green:               | 10                            | 10   | 10   | 10          | 10   | 10   | 10         | 10   | 10   | 10         | 10   | 10   |
| Y+R:                      | 4.0                           | 4.0  | 4.0  | 4.0         | 4.0  | 4.0  | 4.0        | 4.0  | 4.0  | 4.0        | 4.0  | 4.0  |
| -----                     |                               |      |      |             |      |      |            |      |      |            |      |      |
| Volume Module:            | >> Count Date: 20 May 2015 << |      |      |             |      |      |            |      |      |            |      |      |
| Base Vol:                 | 49                            | 343  | 22   | 311         | 1144 | 57   | 16         | 58   | 10   | 19         | 91   | 125  |
| Growth Adj:               | 1.00                          | 1.00 | 1.00 | 1.00        | 1.00 | 1.00 | 1.00       | 1.00 | 1.00 | 1.00       | 1.00 | 1.00 |
| Initial Bse:              | 49                            | 343  | 22   | 311         | 1144 | 57   | 16         | 58   | 10   | 19         | 91   | 125  |
| Added Vol:                | 0                             | 0    | 0    | 0           | 0    | 0    | 0          | 0    | 0    | 0          | 0    | 0    |
| PasserByVol:              | 0                             | 0    | 0    | 0           | 0    | 0    | 0          | 0    | 0    | 0          | 0    | 0    |
| Initial Fut:              | 49                            | 343  | 22   | 311         | 1144 | 57   | 16         | 58   | 10   | 19         | 91   | 125  |
| User Adj:                 | 1.00                          | 1.00 | 1.00 | 1.00        | 1.00 | 1.00 | 1.00       | 1.00 | 1.00 | 1.00       | 1.00 | 1.00 |
| PHF Adj:                  | 1.00                          | 1.00 | 1.00 | 1.00        | 1.00 | 1.00 | 1.00       | 1.00 | 1.00 | 1.00       | 1.00 | 1.00 |
| PHF Volume:               | 49                            | 343  | 22   | 311         | 1144 | 57   | 16         | 58   | 10   | 19         | 91   | 125  |
| Reduct Vol:               | 0                             | 0    | 0    | 0           | 0    | 0    | 0          | 0    | 0    | 0          | 0    | 0    |
| Reduced Vol:              | 49                            | 343  | 22   | 311         | 1144 | 57   | 16         | 58   | 10   | 19         | 91   | 125  |
| PCE Adj:                  | 1.00                          | 1.00 | 1.00 | 1.00        | 1.00 | 1.00 | 1.00       | 1.00 | 1.00 | 1.00       | 1.00 | 1.00 |
| MLF Adj:                  | 1.00                          | 1.00 | 1.00 | 1.00        | 1.00 | 1.00 | 1.00       | 1.00 | 1.00 | 1.00       | 1.00 | 1.00 |
| Final Volume:             | 49                            | 343  | 22   | 311         | 1144 | 57   | 16         | 58   | 10   | 19         | 91   | 125  |
| -----                     |                               |      |      |             |      |      |            |      |      |            |      |      |
| Saturation Flow Module:   |                               |      |      |             |      |      |            |      |      |            |      |      |
| Sat/Lane:                 | 1900                          | 1900 | 1900 | 1900        | 1900 | 1900 | 1900       | 1900 | 1900 | 1900       | 1900 | 1900 |
| Adjustment:               | 0.95                          | 0.95 | 0.95 | 0.95        | 0.95 | 0.95 | 0.92       | 0.92 | 0.92 | 0.95       | 0.95 | 0.92 |
| Lanes:                    | 0.24                          | 1.66 | 0.10 | 0.41        | 1.51 | 0.08 | 0.19       | 0.69 | 0.12 | 0.17       | 0.83 | 1.00 |
| Final Sat.:               | 426                           | 2983 | 191  | 740         | 2724 | 136  | 333        | 1208 | 208  | 311        | 1489 | 1750 |
| -----                     |                               |      |      |             |      |      |            |      |      |            |      |      |
| Capacity Analysis Module: |                               |      |      |             |      |      |            |      |      |            |      |      |
| Vol/Sat:                  | 0.12                          | 0.12 | 0.12 | 0.42        | 0.42 | 0.42 | 0.05       | 0.05 | 0.05 | 0.06       | 0.06 | 0.07 |
| Crit Moves:               | ****                          |      |      | ****        |      |      | ****       |      |      | ****       |      |      |
| Green Time:               | 23.3                          | 23.3 | 23.3 | 85.3        | 85.3 | 85.3 | 12.4       | 12.4 | 12.4 | 12.4       | 12.4 | 97.7 |
| Volume/Cap:               | 0.64                          | 0.64 | 0.64 | 0.64        | 0.64 | 0.64 | 0.50       | 0.50 | 0.50 | 0.64       | 0.64 | 0.10 |
| Delay/Veh:                | 51.6                          | 51.6 | 51.6 | 13.9        | 13.9 | 13.9 | 58.3       | 58.3 | 58.3 | 64.6       | 64.6 | 4.4  |
| User DelAdj:              | 1.00                          | 1.00 | 1.00 | 1.00        | 1.00 | 1.00 | 1.00       | 1.00 | 1.00 | 1.00       | 1.00 | 1.00 |
| AdjDel/Veh:               | 51.6                          | 51.6 | 51.6 | 13.9        | 13.9 | 13.9 | 58.3       | 58.3 | 58.3 | 64.6       | 64.6 | 4.4  |
| LOS by Move:              | D                             | D    | D    | B           | B    | B    | E          | E    | E    | E          | E    | A    |
| HCM2k95thQ:               | 15                            | 15   | 15   | 32          | 32   | 32   | 7          | 7    | 7    | 11         | 11   | 3    |

Note: Queue reported is the number of cars per lane.

BART

Level Of Service Computation Report  
 2000 HCM Operations (Future Volume Alternative)  
 AM - Exist + Proj Conditions

Intersection #123: Homestead/Monroe [Study Int 61]

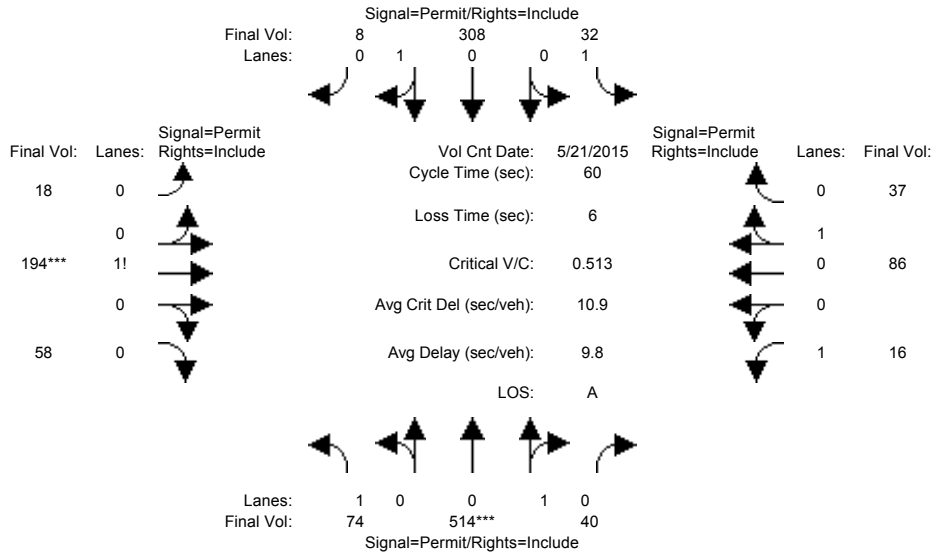

| Approach:                                    | North Bound |      |      | South Bound |      |      | East Bound |      |      | West Bound |      |      |
|--|-------------|------|------|-------------|------|------|------------|------|------|------------|------|------|
| Movement:                                    | L           | T    | R    | L           | T    | R    | L          | T    | R    | L          | T    | R    |
| Min. Green:                                  | 10          | 10   | 10   | 10          | 10   | 10   | 10         | 10   | 10   | 10         | 10   | 10   |
| Y+R:   | 4.0         | 4.0  | 4.0  | 4.0         | 4.0  | 4.0  | 4.0        | 4.0  | 4.0  | 4.0        | 4.0  | 4.0  |
| Volume Module: >> Count Date: 21 May 2015 << |             |      |      |             |      |      |            |      |      |            |      |      |
| Base Vol:                                    | 74          | 514  | 40   | 32          | 308  | 8    | 18         | 194  | 58   | 16         | 86   | 37   |
| Growth Adj:                                  | 1.00        | 1.00 | 1.00 | 1.00        | 1.00 | 1.00 | 1.00       | 1.00 | 1.00 | 1.00       | 1.00 | 1.00 |
| Initial Bse:                                 | 74          | 514  | 40   | 32          | 308  | 8    | 18         | 194  | 58   | 16         | 86   | 37   |
| Added Vol:                                   | 0           | 0    | 0    | 0           | 0    | 0    | 0          | 0    | 0    | 0          | 0    | 0    |
| PasserByVol:                                 | 0           | 0    | 0    | 0           | 0    | 0    | 0          | 0    | 0    | 0          | 0    | 0    |
| Initial Fut:                                 | 74          | 514  | 40   | 32          | 308  | 8    | 18         | 194  | 58   | 16         | 86   | 37   |
| User Adj:                                    | 1.00        | 1.00 | 1.00 | 1.00        | 1.00 | 1.00 | 1.00       | 1.00 | 1.00 | 1.00       | 1.00 | 1.00 |
| PHF Adj:                                     | 1.00        | 1.00 | 1.00 | 1.00        | 1.00 | 1.00 | 1.00       | 1.00 | 1.00 | 1.00       | 1.00 | 1.00 |
| PHF Volume:                                  | 74          | 514  | 40   | 32          | 308  | 8    | 18         | 194  | 58   | 16         | 86   | 37   |
| Reduct Vol:                                  | 0           | 0    | 0    | 0           | 0    | 0    | 0          | 0    | 0    | 0          | 0    | 0    |
| Reduced Vol:                                 | 74          | 514  | 40   | 32          | 308  | 8    | 18         | 194  | 58   | 16         | 86   | 37   |
| PCE Adj:                                     | 1.00        | 1.00 | 1.00 | 1.00        | 1.00 | 1.00 | 1.00       | 1.00 | 1.00 | 1.00       | 1.00 | 1.00 |
| MLF Adj:                                     | 1.00        | 1.00 | 1.00 | 1.00        | 1.00 | 1.00 | 1.00       | 1.00 | 1.00 | 1.00       | 1.00 | 1.00 |
| FinalVolume:                                 | 74          | 514  | 40   | 32          | 308  | 8    | 18         | 194  | 58   | 16         | 86   | 37   |
| Saturation Flow Module:                      |             |      |      |             |      |      |            |      |      |            |      |      |
| Sat/Lane:                                    | 1900        | 1900 | 1900 | 1900        | 1900 | 1900 | 1900       | 1900 | 1900 | 1900       | 1900 | 1900 |
| Adjustment:                                  | 0.92        | 0.95 | 0.95 | 0.92        | 0.95 | 0.95 | 0.92       | 0.92 | 0.92 | 0.92       | 0.95 | 0.95 |
| Lanes:                                       | 1.00        | 0.93 | 0.07 | 1.00        | 0.97 | 0.03 | 0.07       | 0.72 | 0.21 | 1.00       | 0.70 | 0.30 |
| Final Sat.:                                  | 1750        | 1670 | 130  | 1750        | 1754 | 46   | 117        | 1257 | 376  | 1750       | 1259 | 541  |
| Capacity Analysis Module:                    |             |      |      |             |      |      |            |      |      |            |      |      |
| Vol/Sat:                                     | 0.04        | 0.31 | 0.31 | 0.02        | 0.18 | 0.18 | 0.15       | 0.15 | 0.15 | 0.01       | 0.07 | 0.07 |
| Crit Moves:                                  | ****        |      |      | ****        |      |      | ****       |      |      | ****       |      |      |
| Green Time:                                  | 36.0        | 36.0 | 36.0 | 36.0        | 36.0 | 36.0 | 18.0       | 18.0 | 18.0 | 18.0       | 18.0 | 18.0 |
| Volume/Cap:                                  | 0.07        | 0.51 | 0.51 | 0.03        | 0.29 | 0.29 | 0.51       | 0.51 | 0.51 | 0.03       | 0.23 | 0.23 |
| Delay/Veh:                                   | 5.1         | 7.4  | 7.4  | 4.9         | 6.0  | 6.0  | 18.2       | 18.2 | 18.2 | 14.8       | 16.0 | 16.0 |
| User DelAdj:                                 | 1.00        | 1.00 | 1.00 | 1.00        | 1.00 | 1.00 | 1.00       | 1.00 | 1.00 | 1.00       | 1.00 | 1.00 |
| AdjDel/Veh:                                  | 5.1         | 7.4  | 7.4  | 4.9         | 6.0  | 6.0  | 18.2       | 18.2 | 18.2 | 14.8       | 16.0 | 16.0 |
| LOS by Move:                                 | A           | A    | A    | A           | A    | A    | B          | B    | B    | B          | B    | B    |
| HCM2k95thQ:                                  | 1           | 12   | 12   | 1           | 6    | 6    | 9          | 9    | 9    | 0          | 4    | 4    |

Note: Queue reported is the number of cars per lane.

BART

Level Of Service Computation Report  
 2000 HCM Operations (Future Volume Alternative)  
 PM - Exist + Proj Conditions

Intersection #123: Homestead/Monroe [Study Int 61]

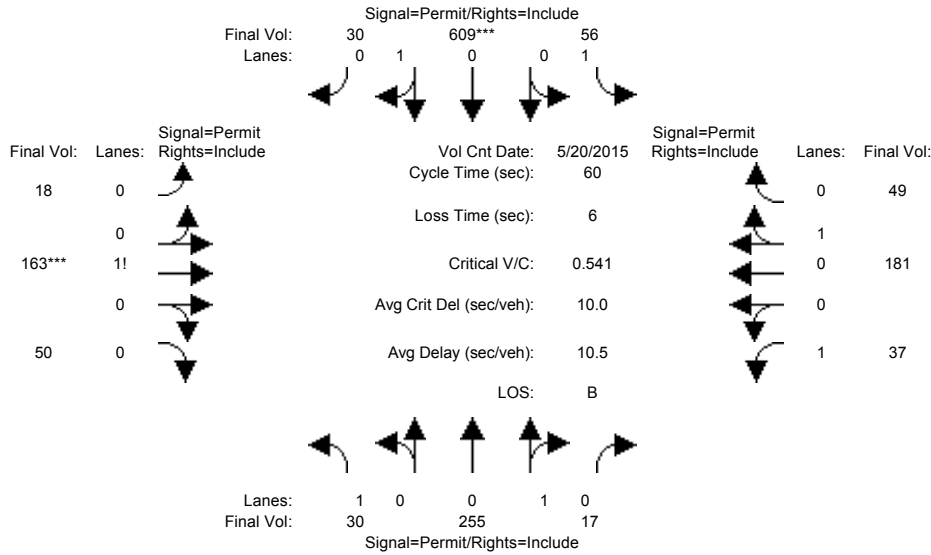

| Approach:                 | North Bound                   |      |      | South Bound |      |      | East Bound |      |      | West Bound |      |      |
|---------------------------|-------------------------------|------|------|-------------|------|------|------------|------|------|------------|------|------|
| Movement:                 | L                             | T    | R    | L           | T    | R    | L          | T    | R    | L          | T    | R    |
| Min. Green:               | 10                            | 10   | 10   | 10          | 10   | 10   | 10         | 10   | 10   | 10         | 10   | 10   |
| Y+R:                      | 4.0                           | 4.0  | 4.0  | 4.0         | 4.0  | 4.0  | 4.0        | 4.0  | 4.0  | 4.0        | 4.0  | 4.0  |
| -----                     |                               |      |      |             |      |      |            |      |      |            |      |      |
| Volume Module:            | >> Count Date: 20 May 2015 << |      |      |             |      |      |            |      |      |            |      |      |
| Base Vol:                 | 30                            | 255  | 17   | 56          | 609  | 30   | 18         | 163  | 50   | 37         | 181  | 49   |
| Growth Adj:               | 1.00                          | 1.00 | 1.00 | 1.00        | 1.00 | 1.00 | 1.00       | 1.00 | 1.00 | 1.00       | 1.00 | 1.00 |
| Initial Bse:              | 30                            | 255  | 17   | 56          | 609  | 30   | 18         | 163  | 50   | 37         | 181  | 49   |
| Added Vol:                | 0                             | 0    | 0    | 0           | 0    | 0    | 0          | 0    | 0    | 0          | 0    | 0    |
| PasserByVol:              | 0                             | 0    | 0    | 0           | 0    | 0    | 0          | 0    | 0    | 0          | 0    | 0    |
| Initial Fut:              | 30                            | 255  | 17   | 56          | 609  | 30   | 18         | 163  | 50   | 37         | 181  | 49   |
| User Adj:                 | 1.00                          | 1.00 | 1.00 | 1.00        | 1.00 | 1.00 | 1.00       | 1.00 | 1.00 | 1.00       | 1.00 | 1.00 |
| PHF Adj:                  | 1.00                          | 1.00 | 1.00 | 1.00        | 1.00 | 1.00 | 1.00       | 1.00 | 1.00 | 1.00       | 1.00 | 1.00 |
| PHF Volume:               | 30                            | 255  | 17   | 56          | 609  | 30   | 18         | 163  | 50   | 37         | 181  | 49   |
| Reduct Vol:               | 0                             | 0    | 0    | 0           | 0    | 0    | 0          | 0    | 0    | 0          | 0    | 0    |
| Reduced Vol:              | 30                            | 255  | 17   | 56          | 609  | 30   | 18         | 163  | 50   | 37         | 181  | 49   |
| PCE Adj:                  | 1.00                          | 1.00 | 1.00 | 1.00        | 1.00 | 1.00 | 1.00       | 1.00 | 1.00 | 1.00       | 1.00 | 1.00 |
| MLF Adj:                  | 1.00                          | 1.00 | 1.00 | 1.00        | 1.00 | 1.00 | 1.00       | 1.00 | 1.00 | 1.00       | 1.00 | 1.00 |
| Final Volume:             | 30                            | 255  | 17   | 56          | 609  | 30   | 18         | 163  | 50   | 37         | 181  | 49   |
| -----                     |                               |      |      |             |      |      |            |      |      |            |      |      |
| Saturation Flow Module:   |                               |      |      |             |      |      |            |      |      |            |      |      |
| Sat/Lane:                 | 1900                          | 1900 | 1900 | 1900        | 1900 | 1900 | 1900       | 1900 | 1900 | 1900       | 1900 | 1900 |
| Adjustment:               | 0.92                          | 0.95 | 0.95 | 0.92        | 0.95 | 0.95 | 0.92       | 0.92 | 0.92 | 0.92       | 0.95 | 0.95 |
| Lanes:                    | 1.00                          | 0.94 | 0.06 | 1.00        | 0.95 | 0.05 | 0.08       | 0.70 | 0.22 | 1.00       | 0.79 | 0.21 |
| Final Sat.:               | 1750                          | 1687 | 112  | 1750        | 1715 | 85   | 136        | 1235 | 379  | 1750       | 1417 | 383  |
| -----                     |                               |      |      |             |      |      |            |      |      |            |      |      |
| Capacity Analysis Module: |                               |      |      |             |      |      |            |      |      |            |      |      |
| Vol/Sat:                  | 0.02                          | 0.15 | 0.15 | 0.03        | 0.36 | 0.36 | 0.13       | 0.13 | 0.13 | 0.02       | 0.13 | 0.13 |
| Crit Moves:               | *****                         |      |      |             |      |      |            |      |      |            |      |      |
| Green Time:               | 39.4                          | 39.4 | 39.4 | 39.4        | 39.4 | 39.4 | 14.6       | 14.6 | 14.6 | 14.6       | 14.6 | 14.6 |
| Volume/Cap:               | 0.03                          | 0.23 | 0.23 | 0.05        | 0.54 | 0.54 | 0.54       | 0.54 | 0.54 | 0.09       | 0.52 | 0.52 |
| Delay/Veh:                | 3.6                           | 4.3  | 4.3  | 3.7         | 6.0  | 6.0  | 21.2       | 21.2 | 21.2 | 17.6       | 20.8 | 20.8 |
| User DelAdj:              | 1.00                          | 1.00 | 1.00 | 1.00        | 1.00 | 1.00 | 1.00       | 1.00 | 1.00 | 1.00       | 1.00 | 1.00 |
| AdjDel/Veh:               | 3.6                           | 4.3  | 4.3  | 3.7         | 6.0  | 6.0  | 21.2       | 21.2 | 21.2 | 17.6       | 20.8 | 20.8 |
| LOS by Move:              | A                             | A    | A    | A           | A    | A    | C          | C    | C    | B          | C    | C    |
| HCM2k95thQ:               | 0                             | 4    | 4    | 1           | 13   | 13   | 8          | 8    | 8    | 1          | 8    | 8    |

Note: Queue reported is the number of cars per lane.

BART

Level Of Service Computation Report  
 2000 HCM Operations (Future Volume Alternative)  
 AM - Exist + Proj Conditions

Intersection #127: Lincoln/Homestead [Study Int 60]

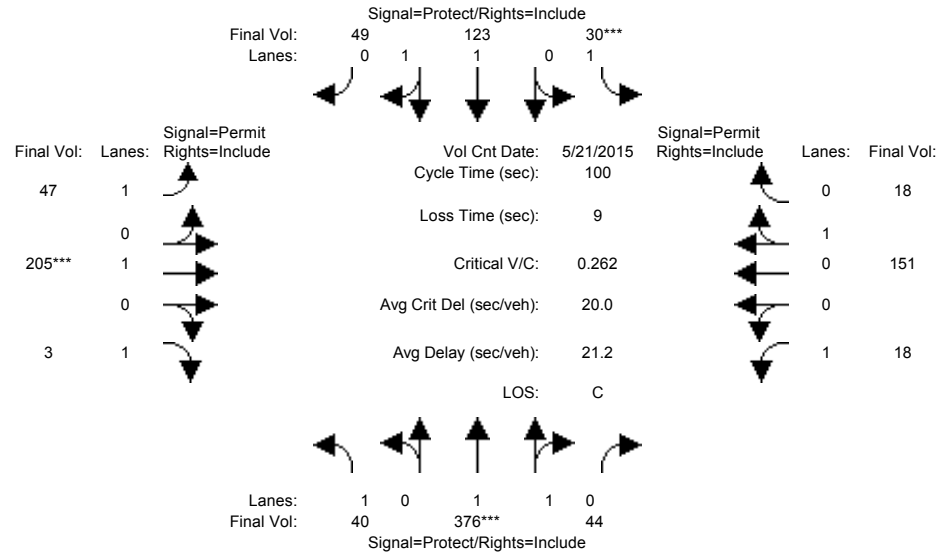

| Approach:                                    | North Bound |      |      | South Bound |      |      | East Bound |      |      | West Bound |      |      |
|--|-------------|------|------|-------------|------|------|------------|------|------|------------|------|------|
| Movement:                                    | L           | T    | R    | L           | T    | R    | L          | T    | R    | L          | T    | R    |
| Min. Green:                                  | 7           | 10   | 10   | 7           | 10   | 10   | 7          | 10   | 10   | 7          | 10   | 10   |
| Y+R:   | 4.0         | 4.0  | 4.0  | 4.0         | 4.0  | 4.0  | 4.0        | 4.0  | 4.0  | 4.0        | 4.0  | 4.0  |
| Volume Module: >> Count Date: 21 May 2015 << |             |      |      |             |      |      |            |      |      |            |      |      |
| Base Vol:                                    | 40          | 376  | 44   | 30          | 123  | 49   | 47         | 205  | 3    | 18         | 151  | 18   |
| Growth Adj:                                  | 1.00        | 1.00 | 1.00 | 1.00        | 1.00 | 1.00 | 1.00       | 1.00 | 1.00 | 1.00       | 1.00 | 1.00 |
| Initial Bse:                                 | 40          | 376  | 44   | 30          | 123  | 49   | 47         | 205  | 3    | 18         | 151  | 18   |
| Added Vol:                                   | 0           | 0    | 0    | 0           | 0    | 0    | 0          | 0    | 0    | 0          | 0    | 0    |
| PasserByVol:                                 | 0           | 0    | 0    | 0           | 0    | 0    | 0          | 0    | 0    | 0          | 0    | 0    |
| Initial Fut:                                 | 40          | 376  | 44   | 30          | 123  | 49   | 47         | 205  | 3    | 18         | 151  | 18   |
| User Adj:                                    | 1.00        | 1.00 | 1.00 | 1.00        | 1.00 | 1.00 | 1.00       | 1.00 | 1.00 | 1.00       | 1.00 | 1.00 |
| PHF Adj:                                     | 1.00        | 1.00 | 1.00 | 1.00        | 1.00 | 1.00 | 1.00       | 1.00 | 1.00 | 1.00       | 1.00 | 1.00 |
| PHF Volume:                                  | 40          | 376  | 44   | 30          | 123  | 49   | 47         | 205  | 3    | 18         | 151  | 18   |
| Reduct Vol:                                  | 0           | 0    | 0    | 0           | 0    | 0    | 0          | 0    | 0    | 0          | 0    | 0    |
| Reduced Vol:                                 | 40          | 376  | 44   | 30          | 123  | 49   | 47         | 205  | 3    | 18         | 151  | 18   |
| PCE Adj:                                     | 1.00        | 1.00 | 1.00 | 1.00        | 1.00 | 1.00 | 1.00       | 1.00 | 1.00 | 1.00       | 1.00 | 1.00 |
| MLF Adj:                                     | 1.00        | 1.00 | 1.00 | 1.00        | 1.00 | 1.00 | 1.00       | 1.00 | 1.00 | 1.00       | 1.00 | 1.00 |
| Final Volume:                                | 40          | 376  | 44   | 30          | 123  | 49   | 47         | 205  | 3    | 18         | 151  | 18   |
| Saturation Flow Module:                      |             |      |      |             |      |      |            |      |      |            |      |      |
| Sat/Lane:                                    | 1900        | 1900 | 1900 | 1900        | 1900 | 1900 | 1900       | 1900 | 1900 | 1900       | 1900 | 1900 |
| Adjustment:                                  | 0.92        | 0.98 | 0.95 | 0.92        | 0.98 | 0.95 | 0.92       | 1.00 | 0.92 | 0.92       | 0.95 | 0.95 |
| Lanes:                                       | 1.00        | 1.78 | 0.22 | 1.00        | 1.41 | 0.59 | 1.00       | 1.00 | 1.00 | 1.00       | 0.89 | 0.11 |
| Final Sat.:                                  | 1750        | 3312 | 388  | 1750        | 2645 | 1054 | 1750       | 1900 | 1750 | 1750       | 1608 | 192  |
| Capacity Analysis Module:                    |             |      |      |             |      |      |            |      |      |            |      |      |
| Vol/Sat:                                     | 0.02        | 0.11 | 0.11 | 0.02        | 0.05 | 0.05 | 0.03       | 0.11 | 0.00 | 0.01       | 0.09 | 0.09 |
| Crit Moves:                                  | ****        | **** | **** | ****        | **** | **** | ****       | **** | **** | ****       | **** | **** |
| Green Time:                                  | 20.6        | 43.1 | 43.1 | 7.0         | 29.5 | 29.5 | 40.9       | 40.9 | 40.9 | 40.9       | 40.9 | 40.9 |
| Volume/Cap:                                  | 0.11        | 0.26 | 0.26 | 0.24        | 0.16 | 0.16 | 0.07       | 0.26 | 0.00 | 0.03       | 0.23 | 0.23 |
| Delay/Veh:                                   | 32.4        | 18.4 | 18.4 | 45.0        | 26.2 | 26.2 | 18.0       | 19.7 | 17.5 | 17.6       | 19.4 | 19.4 |
| User DelAdj:                                 | 1.00        | 1.00 | 1.00 | 1.00        | 1.00 | 1.00 | 1.00       | 1.00 | 1.00 | 1.00       | 1.00 | 1.00 |
| AdjDel/Veh:                                  | 32.4        | 18.4 | 18.4 | 45.0        | 26.2 | 26.2 | 18.0       | 19.7 | 17.5 | 17.6       | 19.4 | 19.4 |
| LOS by Move:                                 | C           | B    | B    | D           | C    | C    | B          | B    | B    | B          | B    | B    |
| HCM2k95thQ:                                  | 2           | 8    | 8    | 2           | 4    | 4    | 2          | 8    | 0    | 1          | 7    | 7    |

Note: Queue reported is the number of cars per lane.



BART

Level Of Service Computation Report  
 2000 HCM Operations (Future Volume Alternative)  
 PM - Exist + Proj Conditions

Intersection #127: Lincoln/Homestead [Study Int 60]

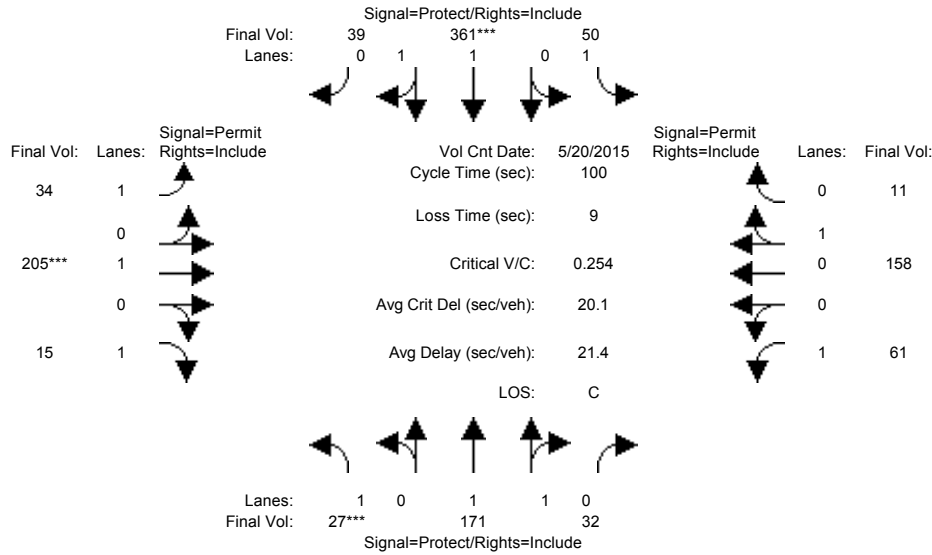

| Approach:                                    | North Bound |      |      | South Bound |      |      | East Bound |      |      | West Bound |      |      |
|--|-------------|------|------|-------------|------|------|------------|------|------|------------|------|------|
| Movement:                                    | L           | T    | R    | L           | T    | R    | L          | T    | R    | L          | T    | R    |
| Min. Green:                                  | 7           | 10   | 10   | 7           | 10   | 10   | 7          | 10   | 10   | 7          | 10   | 10   |
| Y+R:   | 4.0         | 4.0  | 4.0  | 4.0         | 4.0  | 4.0  | 4.0        | 4.0  | 4.0  | 4.0        | 4.0  | 4.0  |
| Volume Module: >> Count Date: 20 May 2015 << |             |      |      |             |      |      |            |      |      |            |      |      |
| Base Vol:                                    | 27          | 171  | 32   | 50          | 361  | 39   | 34         | 205  | 15   | 61         | 158  | 11   |
| Growth Adj:                                  | 1.00        | 1.00 | 1.00 | 1.00        | 1.00 | 1.00 | 1.00       | 1.00 | 1.00 | 1.00       | 1.00 | 1.00 |
| Initial Bse:                                 | 27          | 171  | 32   | 50          | 361  | 39   | 34         | 205  | 15   | 61         | 158  | 11   |
| Added Vol:                                   | 0           | 0    | 0    | 0           | 0    | 0    | 0          | 0    | 0    | 0          | 0    | 0    |
| PasserByVol:                                 | 0           | 0    | 0    | 0           | 0    | 0    | 0          | 0    | 0    | 0          | 0    | 0    |
| Initial Fut:                                 | 27          | 171  | 32   | 50          | 361  | 39   | 34         | 205  | 15   | 61         | 158  | 11   |
| User Adj:                                    | 1.00        | 1.00 | 1.00 | 1.00        | 1.00 | 1.00 | 1.00       | 1.00 | 1.00 | 1.00       | 1.00 | 1.00 |
| PHF Adj:                                     | 1.00        | 1.00 | 1.00 | 1.00        | 1.00 | 1.00 | 1.00       | 1.00 | 1.00 | 1.00       | 1.00 | 1.00 |
| PHF Volume:                                  | 27          | 171  | 32   | 50          | 361  | 39   | 34         | 205  | 15   | 61         | 158  | 11   |
| Reduct Vol:                                  | 0           | 0    | 0    | 0           | 0    | 0    | 0          | 0    | 0    | 0          | 0    | 0    |
| Reduced Vol:                                 | 27          | 171  | 32   | 50          | 361  | 39   | 34         | 205  | 15   | 61         | 158  | 11   |
| PCE Adj:                                     | 1.00        | 1.00 | 1.00 | 1.00        | 1.00 | 1.00 | 1.00       | 1.00 | 1.00 | 1.00       | 1.00 | 1.00 |
| MLF Adj:                                     | 1.00        | 1.00 | 1.00 | 1.00        | 1.00 | 1.00 | 1.00       | 1.00 | 1.00 | 1.00       | 1.00 | 1.00 |
| Final Volume:                                | 27          | 171  | 32   | 50          | 361  | 39   | 34         | 205  | 15   | 61         | 158  | 11   |
| Saturation Flow Module:                      |             |      |      |             |      |      |            |      |      |            |      |      |
| Sat/Lane:                                    | 1900        | 1900 | 1900 | 1900        | 1900 | 1900 | 1900       | 1900 | 1900 | 1900       | 1900 | 1900 |
| Adjustment:                                  | 0.92        | 0.98 | 0.95 | 0.92        | 0.98 | 0.95 | 0.92       | 1.00 | 0.92 | 0.92       | 0.95 | 0.95 |
| Lanes:                                       | 1.00        | 1.68 | 0.32 | 1.00        | 1.80 | 0.20 | 1.00       | 1.00 | 1.00 | 1.00       | 0.93 | 0.07 |
| Final Sat.:                                  | 1750        | 3116 | 583  | 1750        | 3339 | 361  | 1750       | 1900 | 1750 | 1750       | 1683 | 117  |
| Capacity Analysis Module:                    |             |      |      |             |      |      |            |      |      |            |      |      |
| Vol/Sat:                                     | 0.02        | 0.05 | 0.05 | 0.03        | 0.11 | 0.11 | 0.02       | 0.11 | 0.01 | 0.03       | 0.09 | 0.09 |
| Crit Moves:                                  | ****        |      |      | ****        |      |      | ****       |      |      | ****       |      |      |
| Green Time:                                  | 7.0         | 28.8 | 28.8 | 20.2        | 42.0 | 42.0 | 42.0       | 42.0 | 42.0 | 42.0       | 42.0 | 42.0 |
| Volume/Cap:                                  | 0.22        | 0.19 | 0.19 | 0.14        | 0.26 | 0.26 | 0.05       | 0.26 | 0.02 | 0.08       | 0.22 | 0.22 |
| Delay/Veh:                                   | 44.8        | 26.9 | 26.9 | 33.0        | 18.9 | 18.9 | 17.2       | 19.1 | 17.0 | 17.5       | 18.7 | 18.7 |
| User DelAdj:                                 | 1.00        | 1.00 | 1.00 | 1.00        | 1.00 | 1.00 | 1.00       | 1.00 | 1.00 | 1.00       | 1.00 | 1.00 |
| AdjDel/Veh:                                  | 44.8        | 26.9 | 26.9 | 33.0        | 18.9 | 18.9 | 17.2       | 19.1 | 17.0 | 17.5       | 18.7 | 18.7 |
| LOS by Move:                                 | D           | C    | C    | C           | B    | B    | B          | B    | B    | B          | B    | B    |
| HCM2k95thQ:                                  | 2           | 5    | 5    | 3           | 8    | 8    | 1          | 8    | 1    | 2          | 7    | 7    |

Note: Queue reported is the number of cars per lane.

BART

Level Of Service Computation Report  
 2000 HCM Operations (Future Volume Alternative)  
 AM - Exist + Proj Conditions

Intersection #128: Homestead/Lafayette [Study Int 50]

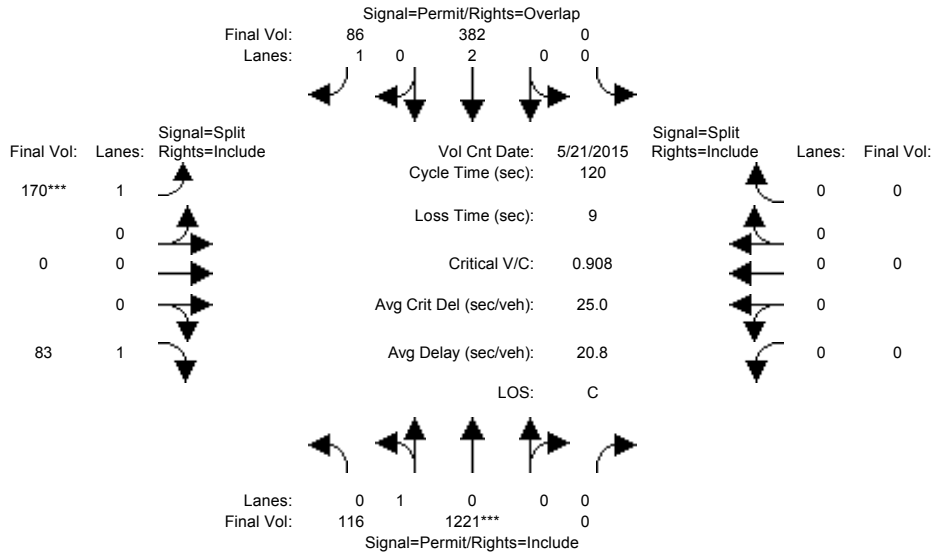

| Approach:                                    | North Bound |      |      | South Bound |      |       | East Bound |      |      | West Bound |      |      |
|--|-------------|------|------|-------------|------|-------|------------|------|------|------------|------|------|
| Movement:                                    | L           | T    | R    | L           | T    | R     | L          | T    | R    | L          | T    | R    |
| Min. Green:                                  | 10          | 10   | 10   | 10          | 10   | 10    | 10         | 10   | 10   | 10         | 10   | 10   |
| Y+R:   | 4.0         | 4.0  | 4.0  | 4.0         | 4.0  | 4.0   | 4.0        | 4.0  | 4.0  | 4.0        | 4.0  | 4.0  |
| Volume Module: >> Count Date: 21 May 2015 << |             |      |      |             |      |       |            |      |      |            |      |      |
| Base Vol:                                    | 116         | 1221 | 0    | 0           | 382  | 86    | 170        | 0    | 83   | 0          | 0    | 0    |
| Growth Adj:                                  | 1.00        | 1.00 | 1.00 | 1.00        | 1.00 | 1.00  | 1.00       | 1.00 | 1.00 | 1.00       | 1.00 | 1.00 |
| Initial Bse:                                 | 116         | 1221 | 0    | 0           | 382  | 86    | 170        | 0    | 83   | 0          | 0    | 0    |
| Added Vol:                                   | 0           | 0    | 0    | 0           | 0    | 0     | 0          | 0    | 0    | 0          | 0    | 0    |
| PasserByVol:                                 | 0           | 0    | 0    | 0           | 0    | 0     | 0          | 0    | 0    | 0          | 0    | 0    |
| Initial Fut:                                 | 116         | 1221 | 0    | 0           | 382  | 86    | 170        | 0    | 83   | 0          | 0    | 0    |
| User Adj:                                    | 1.00        | 1.00 | 1.00 | 1.00        | 1.00 | 1.00  | 1.00       | 1.00 | 1.00 | 1.00       | 1.00 | 1.00 |
| PHF Adj:                                     | 1.00        | 1.00 | 1.00 | 1.00        | 1.00 | 1.00  | 1.00       | 1.00 | 1.00 | 1.00       | 1.00 | 1.00 |
| PHF Volume:                                  | 116         | 1221 | 0    | 0           | 382  | 86    | 170        | 0    | 83   | 0          | 0    | 0    |
| Reduct Vol:                                  | 0           | 0    | 0    | 0           | 0    | 0     | 0          | 0    | 0    | 0          | 0    | 0    |
| Reduced Vol:                                 | 116         | 1221 | 0    | 0           | 382  | 86    | 170        | 0    | 83   | 0          | 0    | 0    |
| PCE Adj:                                     | 1.00        | 1.00 | 1.00 | 1.00        | 1.00 | 1.00  | 1.00       | 1.00 | 1.00 | 1.00       | 1.00 | 1.00 |
| MLF Adj:                                     | 1.00        | 1.00 | 1.00 | 1.00        | 1.00 | 1.00  | 1.00       | 1.00 | 1.00 | 1.00       | 1.00 | 1.00 |
| Final Volume:                                | 116         | 1221 | 0    | 0           | 382  | 86    | 170        | 0    | 83   | 0          | 0    | 0    |
| Saturation Flow Module:                      |             |      |      |             |      |       |            |      |      |            |      |      |
| Sat/Lane:                                    | 1900        | 1900 | 1900 | 1900        | 1900 | 1900  | 1900       | 1900 | 1900 | 1900       | 1900 | 1900 |
| Adjustment:                                  | 0.95        | 0.95 | 0.92 | 0.92        | 1.00 | 0.92  | 0.92       | 1.00 | 0.92 | 0.92       | 1.00 | 0.92 |
| Lanes:                                       | 0.09        | 0.91 | 0.00 | 0.00        | 2.00 | 1.00  | 1.00       | 0.00 | 1.00 | 0.00       | 0.00 | 0.00 |
| Final Sat.:                                  | 156         | 1644 | 0    | 0           | 3800 | 1750  | 1750       | 0    | 1750 | 0          | 0    | 0    |
| Capacity Analysis Module:                    |             |      |      |             |      |       |            |      |      |            |      |      |
| Vol/Sat:                                     | 0.74        | 0.74 | 0.00 | 0.00        | 0.10 | 0.05  | 0.10       | 0.00 | 0.05 | 0.00       | 0.00 | 0.00 |
| Crit Moves:                                  | ****        |      |      | ****        |      |       | ****       |      |      | ****       |      |      |
| Green Time:                                  | 98.2        | 98.2 | 0.0  | 0.0         | 98.2 | 111.0 | 12.8       | 0.0  | 12.8 | 0.0        | 0.0  | 0.0  |
| Volume/Cap:                                  | 0.91        | 0.91 | 0.00 | 0.00        | 0.12 | 0.05  | 0.91       | 0.00 | 0.44 | 0.00       | 0.00 | 0.00 |
| Delay/Veh:                                   | 16.3        | 16.3 | 0.0  | 0.0         | 2.2  | 0.4   | 93.8       | 0.0  | 51.9 | 0.0        | 0.0  | 0.0  |
| User DelAdj:                                 | 1.00        | 1.00 | 1.00 | 1.00        | 1.00 | 1.00  | 1.00       | 1.00 | 1.00 | 1.00       | 1.00 | 1.00 |
| AdjDel/Veh:                                  | 16.3        | 16.3 | 0.0  | 0.0         | 2.2  | 0.4   | 93.8       | 0.0  | 51.9 | 0.0        | 0.0  | 0.0  |
| LOS by Move:                                 | B           | B    | A    | A           | A    | A     | F          | A    | D    | A          | A    | A    |
| HCM2k95thQ:                                  | 64          | 64   | 0    | 0           | 3    | 1     | 15         | 0    | 6    | 0          | 0    | 0    |

Note: Queue reported is the number of cars per lane.

BART

Level Of Service Computation Report  
 2000 HCM Operations (Future Volume Alternative)  
 PM - Exist + Proj Conditions

Intersection #128: Homestead/Lafayette [Study Int 50]

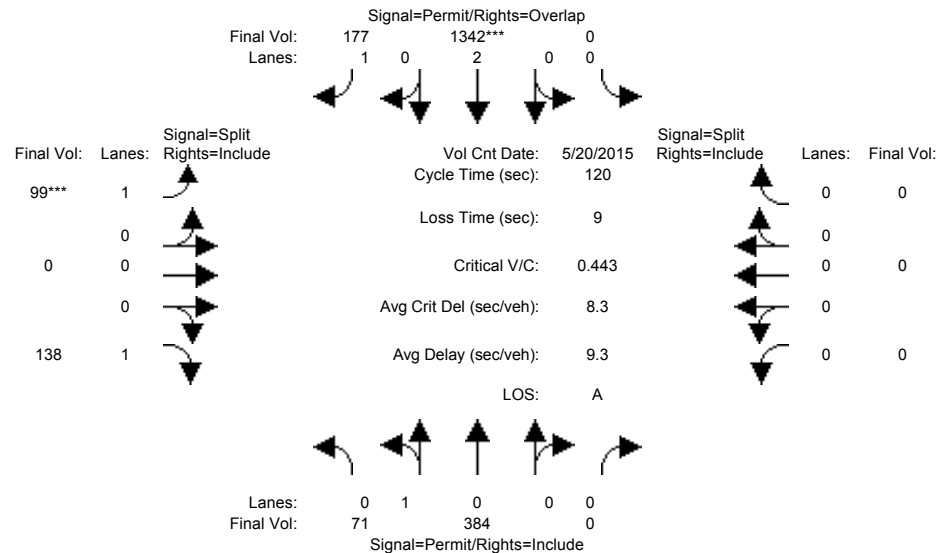

| Approach:                                    | North Bound |      |      | South Bound |      |       | East Bound |      |      | West Bound |      |      |
|--|-------------|------|------|-------------|------|-------|------------|------|------|------------|------|------|
| Movement:                                    | L           | T    | R    | L           | T    | R     | L          | T    | R    | L          | T    | R    |
| Min. Green:                                  | 10          | 10   | 10   | 10          | 10   | 10    | 10         | 10   | 10   | 10         | 10   | 10   |
| Y+R:   | 4.0         | 4.0  | 4.0  | 4.0         | 4.0  | 4.0   | 4.0        | 4.0  | 4.0  | 4.0        | 4.0  | 4.0  |
| Volume Module: >> Count Date: 20 May 2015 << |             |      |      |             |      |       |            |      |      |            |      |      |
| Base Vol:                                    | 71          | 384  | 0    | 0           | 1342 | 177   | 99         | 0    | 138  | 0          | 0    | 0    |
| Growth Adj:                                  | 1.00        | 1.00 | 1.00 | 1.00        | 1.00 | 1.00  | 1.00       | 1.00 | 1.00 | 1.00       | 1.00 | 1.00 |
| Initial Bse:                                 | 71          | 384  | 0    | 0           | 1342 | 177   | 99         | 0    | 138  | 0          | 0    | 0    |
| Added Vol:                                   | 0           | 0    | 0    | 0           | 0    | 0     | 0          | 0    | 0    | 0          | 0    | 0    |
| PasserByVol:                                 | 0           | 0    | 0    | 0           | 0    | 0     | 0          | 0    | 0    | 0          | 0    | 0    |
| Initial Fut:                                 | 71          | 384  | 0    | 0           | 1342 | 177   | 99         | 0    | 138  | 0          | 0    | 0    |
| User Adj:                                    | 1.00        | 1.00 | 1.00 | 1.00        | 1.00 | 1.00  | 1.00       | 1.00 | 1.00 | 1.00       | 1.00 | 1.00 |
| PHF Adj:                                     | 1.00        | 1.00 | 1.00 | 1.00        | 1.00 | 1.00  | 1.00       | 1.00 | 1.00 | 1.00       | 1.00 | 1.00 |
| PHF Volume:                                  | 71          | 384  | 0    | 0           | 1342 | 177   | 99         | 0    | 138  | 0          | 0    | 0    |
| Reduct Vol:                                  | 0           | 0    | 0    | 0           | 0    | 0     | 0          | 0    | 0    | 0          | 0    | 0    |
| Reduced Vol:                                 | 71          | 384  | 0    | 0           | 1342 | 177   | 99         | 0    | 138  | 0          | 0    | 0    |
| PCE Adj:                                     | 1.00        | 1.00 | 1.00 | 1.00        | 1.00 | 1.00  | 1.00       | 1.00 | 1.00 | 1.00       | 1.00 | 1.00 |
| MLF Adj:                                     | 1.00        | 1.00 | 1.00 | 1.00        | 1.00 | 1.00  | 1.00       | 1.00 | 1.00 | 1.00       | 1.00 | 1.00 |
| Final Volume:                                | 71          | 384  | 0    | 0           | 1342 | 177   | 99         | 0    | 138  | 0          | 0    | 0    |
| Saturation Flow Module:                      |             |      |      |             |      |       |            |      |      |            |      |      |
| Sat/Lane:                                    | 1900        | 1900 | 1900 | 1900        | 1900 | 1900  | 1900       | 1900 | 1900 | 1900       | 1900 | 1900 |
| Adjustment:                                  | 0.95        | 0.95 | 0.92 | 0.92        | 1.00 | 0.92  | 0.92       | 1.00 | 0.92 | 0.92       | 1.00 | 0.92 |
| Lanes:                                       | 0.16        | 0.84 | 0.00 | 0.00        | 2.00 | 1.00  | 1.00       | 0.00 | 1.00 | 0.00       | 0.00 | 0.00 |
| Final Sat.:                                  | 281         | 1519 | 0    | 0           | 3800 | 1750  | 1750       | 0    | 1750 | 0          | 0    | 0    |
| Capacity Analysis Module:                    |             |      |      |             |      |       |            |      |      |            |      |      |
| Vol/Sat:                                     | 0.25        | 0.25 | 0.00 | 0.00        | 0.35 | 0.10  | 0.06       | 0.00 | 0.08 | 0.00       | 0.00 | 0.00 |
| Crit Moves:                                  | *****       |      |      |             |      |       |            |      |      |            |      |      |
| Green Time:                                  | 90.7        | 90.7 | 0.0  | 0.0         | 90.7 | 111.0 | 20.3       | 0.0  | 20.3 | 0.0        | 0.0  | 0.0  |
| Volume/Cap:                                  | 0.33        | 0.33 | 0.00 | 0.00        | 0.47 | 0.11  | 0.34       | 0.00 | 0.47 | 0.00       | 0.00 | 0.00 |
| Delay/Veh:                                   | 4.9         | 4.9  | 0.0  | 0.0         | 5.6  | 0.4   | 44.6       | 0.0  | 46.2 | 0.0        | 0.0  | 0.0  |
| User DelAdj:                                 | 1.00        | 1.00 | 1.00 | 1.00        | 1.00 | 1.00  | 1.00       | 1.00 | 1.00 | 1.00       | 1.00 | 1.00 |
| AdjDel/Veh:                                  | 4.9         | 4.9  | 0.0  | 0.0         | 5.6  | 0.4   | 44.6       | 0.0  | 46.2 | 0.0        | 0.0  | 0.0  |
| LOS by Move:                                 | A           | A    | A    | A           | A    | A     | D          | A    | D    | A          | A    | A    |
| HCM2k95thQ:                                  | 11          | 11   | 0    | 0           | 17   | 1     | 7          | 0    | 10   | 0          | 0    | 0    |

Note: Queue reported is the number of cars per lane.

BART

Level Of Service Computation Report  
 2000 HCM Operations (Future Volume Alternative)  
 AM - Exist + Proj Conditions

Intersection #175: Reed/De La Cruz [Study Int 32]

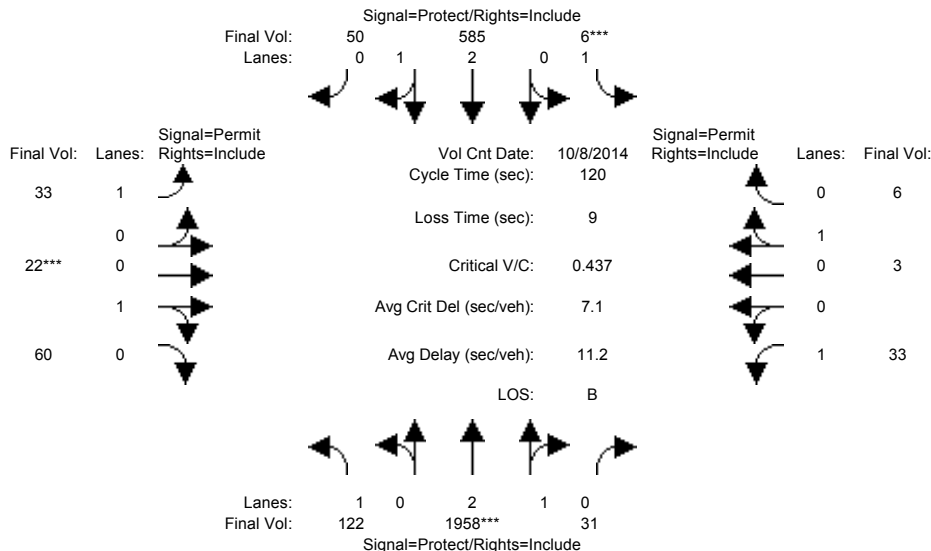

| Approach:                                   | North Bound |      |      | South Bound |      |      | East Bound |      |      | West Bound |      |      |
|---|-------------|------|------|-------------|------|------|------------|------|------|------------|------|------|
| Movement:                                   | L           | T    | R    | L           | T    | R    | L          | T    | R    | L          | T    | R    |
| Min. Green:                                 | 7           | 10   | 10   | 7           | 10   | 10   | 10         | 10   | 10   | 10         | 10   | 10   |
| Y+R:  | 4.0         | 4.0  | 4.0  | 4.0         | 4.0  | 4.0  | 4.0        | 4.0  | 4.0  | 4.0        | 4.0  | 4.0  |
| -----                                       |             |      |      |             |      |      |            |      |      |            |      |      |
| Volume Module: >> Count Date: 8 Oct 2014 << |             |      |      |             |      |      |            |      |      |            |      |      |
| Base Vol:                                   | 122         | 1958 | 31   | 6           | 585  | 50   | 33         | 22   | 60   | 33         | 3    | 6    |
| Growth Adj:                                 | 1.00        | 1.00 | 1.00 | 1.00        | 1.00 | 1.00 | 1.00       | 1.00 | 1.00 | 1.00       | 1.00 | 1.00 |
| Initial Bse:                                | 122         | 1958 | 31   | 6           | 585  | 50   | 33         | 22   | 60   | 33         | 3    | 6    |
| Added Vol:                                  | 0           | 0    | 0    | 0           | 0    | 0    | 0          | 0    | 0    | 0          | 0    | 0    |
| PasserByVol:                                | 0           | 0    | 0    | 0           | 0    | 0    | 0          | 0    | 0    | 0          | 0    | 0    |
| Initial Fut:                                | 122         | 1958 | 31   | 6           | 585  | 50   | 33         | 22   | 60   | 33         | 3    | 6    |
| User Adj:                                   | 1.00        | 1.00 | 1.00 | 1.00        | 1.00 | 1.00 | 1.00       | 1.00 | 1.00 | 1.00       | 1.00 | 1.00 |
| PHF Adj:                                    | 1.00        | 1.00 | 1.00 | 1.00        | 1.00 | 1.00 | 1.00       | 1.00 | 1.00 | 1.00       | 1.00 | 1.00 |
| PHF Volume:                                 | 122         | 1958 | 31   | 6           | 585  | 50   | 33         | 22   | 60   | 33         | 3    | 6    |
| Reduct Vol:                                 | 0           | 0    | 0    | 0           | 0    | 0    | 0          | 0    | 0    | 0          | 0    | 0    |
| Reduced Vol:                                | 122         | 1958 | 31   | 6           | 585  | 50   | 33         | 22   | 60   | 33         | 3    | 6    |
| PCE Adj:                                    | 1.00        | 1.00 | 1.00 | 1.00        | 1.00 | 1.00 | 1.00       | 1.00 | 1.00 | 1.00       | 1.00 | 1.00 |
| MLF Adj:                                    | 1.00        | 1.00 | 1.00 | 1.00        | 1.00 | 1.00 | 1.00       | 1.00 | 1.00 | 1.00       | 1.00 | 1.00 |
| Final Volume:                               | 122         | 1958 | 31   | 6           | 585  | 50   | 33         | 22   | 60   | 33         | 3    | 6    |
| -----                                       |             |      |      |             |      |      |            |      |      |            |      |      |
| Saturation Flow Module:                     |             |      |      |             |      |      |            |      |      |            |      |      |
| Sat/Lane:                                   | 1900        | 1900 | 1900 | 1900        | 1900 | 1900 | 1900       | 1900 | 1900 | 1900       | 1900 | 1900 |
| Adjustment:                                 | 0.92        | 0.98 | 0.95 | 0.92        | 0.99 | 0.95 | 0.92       | 0.95 | 0.95 | 0.92       | 0.95 | 0.95 |
| Lanes:                                      | 1.00        | 2.95 | 0.05 | 1.00        | 2.76 | 0.24 | 1.00       | 0.27 | 0.73 | 1.00       | 0.33 | 0.67 |
| Final Sat.:                                 | 1750        | 5513 | 87   | 1750        | 5158 | 441  | 1750       | 483  | 1317 | 1750       | 600  | 1200 |
| -----                                       |             |      |      |             |      |      |            |      |      |            |      |      |
| Capacity Analysis Module:                   |             |      |      |             |      |      |            |      |      |            |      |      |
| Vol/Sat:                                    | 0.07        | 0.36 | 0.36 | 0.00        | 0.11 | 0.11 | 0.02       | 0.05 | 0.05 | 0.02       | 0.01 | 0.01 |
| Crit Moves:                                 | ****        | **** | **** | ****        | **** | **** | ****       | **** | **** | ****       | **** | **** |
| Green Time:                                 | 37.8        | 92.2 | 92.2 | 7.0         | 61.4 | 61.4 | 11.8       | 11.8 | 11.8 | 11.8       | 11.8 | 11.8 |
| Volume/Cap:                                 | 0.22        | 0.46 | 0.46 | 0.06        | 0.22 | 0.22 | 0.19       | 0.46 | 0.46 | 0.19       | 0.05 | 0.05 |
| Delay/Veh:                                  | 30.5        | 5.1  | 5.1  | 53.6        | 16.2 | 16.2 | 50.2       | 53.0 | 53.0 | 50.2       | 49.1 | 49.1 |
| User DelAdj:                                | 1.00        | 1.00 | 1.00 | 1.00        | 1.00 | 1.00 | 1.00       | 1.00 | 1.00 | 1.00       | 1.00 | 1.00 |
| AdjDel/Veh:                                 | 30.5        | 5.1  | 5.1  | 53.6        | 16.2 | 16.2 | 50.2       | 53.0 | 53.0 | 50.2       | 49.1 | 49.1 |
| LOS by Move:                                | C           | A    | A    | D           | B    | B    | D          | D    | D    | D          | D    | D    |
| HCM2k95thQ:                                 | 7           | 17   | 17   | 0           | 8    | 8    | 2          | 6    | 6    | 3          | 1    | 1    |

Note: Queue reported is the number of cars per lane.

BART

Level Of Service Computation Report  
 2000 HCM Operations (Future Volume Alternative)  
 PM - Exist + Proj Conditions

Intersection #175: Reed/De La Cruz [Study Int 32]

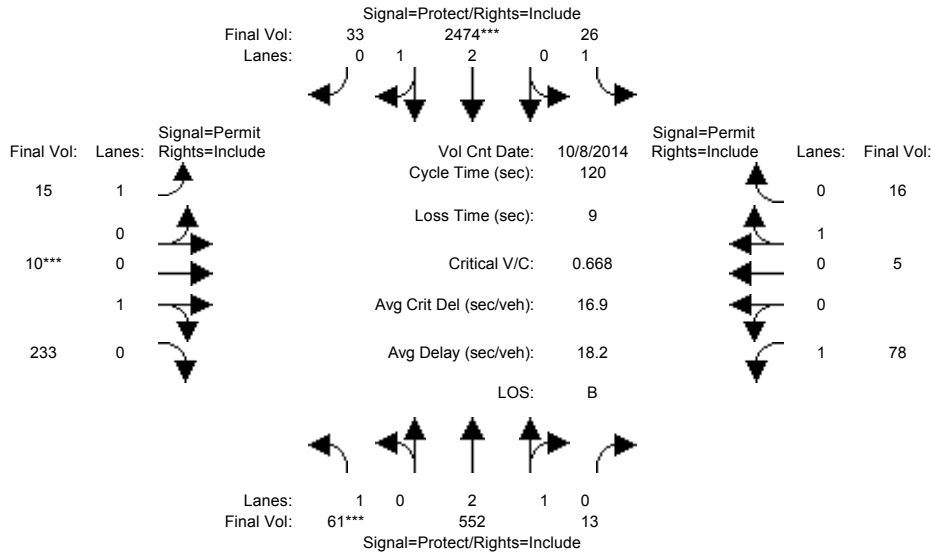

| Approach:                                   | North Bound |      |      | South Bound |      |      | East Bound |      |      | West Bound |      |      |
|---|-------------|------|------|-------------|------|------|------------|------|------|------------|------|------|
| Movement:                                   | L           | T    | R    | L           | T    | R    | L          | T    | R    | L          | T    | R    |
| Min. Green:                                 | 7           | 10   | 10   | 7           | 10   | 10   | 10         | 10   | 10   | 10         | 10   | 10   |
| Y+R:  | 4.0         | 4.0  | 4.0  | 4.0         | 4.0  | 4.0  | 4.0        | 4.0  | 4.0  | 4.0        | 4.0  | 4.0  |
| Volume Module: >> Count Date: 8 Oct 2014 << |             |      |      |             |      |      |            |      |      |            |      |      |
| Base Vol:                                   | 61          | 552  | 13   | 26          | 2474 | 33   | 15         | 10   | 233  | 78         | 5    | 16   |
| Growth Adj:                                 | 1.00        | 1.00 | 1.00 | 1.00        | 1.00 | 1.00 | 1.00       | 1.00 | 1.00 | 1.00       | 1.00 | 1.00 |
| Initial Bse:                                | 61          | 552  | 13   | 26          | 2474 | 33   | 15         | 10   | 233  | 78         | 5    | 16   |
| Added Vol:                                  | 0           | 0    | 0    | 0           | 0    | 0    | 0          | 0    | 0    | 0          | 0    | 0    |
| PasserByVol:                                | 0           | 0    | 0    | 0           | 0    | 0    | 0          | 0    | 0    | 0          | 0    | 0    |
| Initial Fut:                                | 61          | 552  | 13   | 26          | 2474 | 33   | 15         | 10   | 233  | 78         | 5    | 16   |
| User Adj:                                   | 1.00        | 1.00 | 1.00 | 1.00        | 1.00 | 1.00 | 1.00       | 1.00 | 1.00 | 1.00       | 1.00 | 1.00 |
| PHF Adj:                                    | 1.00        | 1.00 | 1.00 | 1.00        | 1.00 | 1.00 | 1.00       | 1.00 | 1.00 | 1.00       | 1.00 | 1.00 |
| PHF Volume:                                 | 61          | 552  | 13   | 26          | 2474 | 33   | 15         | 10   | 233  | 78         | 5    | 16   |
| Reduct Vol:                                 | 0           | 0    | 0    | 0           | 0    | 0    | 0          | 0    | 0    | 0          | 0    | 0    |
| Reduced Vol:                                | 61          | 552  | 13   | 26          | 2474 | 33   | 15         | 10   | 233  | 78         | 5    | 16   |
| PCE Adj:                                    | 1.00        | 1.00 | 1.00 | 1.00        | 1.00 | 1.00 | 1.00       | 1.00 | 1.00 | 1.00       | 1.00 | 1.00 |
| MLF Adj:                                    | 1.00        | 1.00 | 1.00 | 1.00        | 1.00 | 1.00 | 1.00       | 1.00 | 1.00 | 1.00       | 1.00 | 1.00 |
| Final Volume:                               | 61          | 552  | 13   | 26          | 2474 | 33   | 15         | 10   | 233  | 78         | 5    | 16   |
| Saturation Flow Module:                     |             |      |      |             |      |      |            |      |      |            |      |      |
| Sat/Lane:                                   | 1900        | 1900 | 1900 | 1900        | 1900 | 1900 | 1900       | 1900 | 1900 | 1900       | 1900 | 1900 |
| Adjustment:                                 | 0.92        | 0.98 | 0.95 | 0.92        | 0.98 | 0.95 | 0.92       | 0.95 | 0.95 | 0.92       | 0.95 | 0.95 |
| Lanes:                                      | 1.00        | 2.93 | 0.07 | 1.00        | 2.96 | 0.04 | 1.00       | 0.04 | 0.96 | 1.00       | 0.24 | 0.76 |
| Final Sat.:                                 | 1750        | 5471 | 129  | 1750        | 5526 | 74   | 1750       | 74   | 1726 | 1750       | 429  | 1371 |
| Capacity Analysis Module:                   |             |      |      |             |      |      |            |      |      |            |      |      |
| Vol/Sat:                                    | 0.03        | 0.10 | 0.10 | 0.01        | 0.45 | 0.45 | 0.01       | 0.14 | 0.14 | 0.04       | 0.01 | 0.01 |
| Crit Moves:                                 | ****        |      |      | ****        |      |      | ****       |      |      | ****       |      |      |
| Green Time:                                 | 7.0         | 55.1 | 55.1 | 31.8        | 79.9 | 79.9 | 24.1       | 24.1 | 24.1 | 24.1       | 24.1 | 24.1 |
| Volume/Cap:                                 | 0.60        | 0.22 | 0.22 | 0.06        | 0.67 | 0.67 | 0.04       | 0.67 | 0.67 | 0.22       | 0.06 | 0.06 |
| Delay/Veh:                                  | 64.5        | 19.6 | 19.6 | 32.9        | 12.6 | 12.6 | 38.7       | 49.2 | 49.2 | 40.4       | 38.8 | 38.8 |
| User DelAdj:                                | 1.00        | 1.00 | 1.00 | 1.00        | 1.00 | 1.00 | 1.00       | 1.00 | 1.00 | 1.00       | 1.00 | 1.00 |
| AdjDel/Veh:                                 | 64.5        | 19.6 | 19.6 | 32.9        | 12.6 | 12.6 | 38.7       | 49.2 | 49.2 | 40.4       | 38.8 | 38.8 |
| LOS by Move:                                | E           | B    | B    | C           | B    | B    | D          | D    | D    | D          | D    | D    |
| HCM2k95thQ:                                 | 7           | 8    | 8    | 2           | 33   | 33   | 1          | 16   | 16   | 5          | 1    | 1    |

Note: Queue reported is the number of cars per lane.

BART

Level Of Service Computation Report
2000 HCM Unsignalized (Future Volume Alternative)
AM - Exist + Proj Conditions

Intersection #1008: Lafayette/Harrison (unsignalized) [Study Int 48]

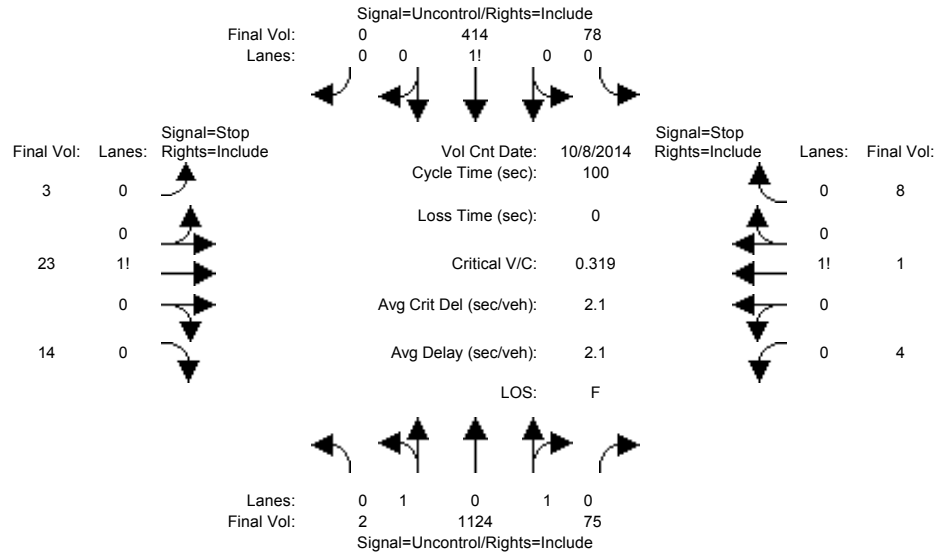

Table with 4 columns: Approach (North Bound, South Bound, East Bound, West Bound) and 4 sub-columns for movement types (L, T, R). Rows include Volume Module, Base Vol, Growth Adj, Initial Bse, Added Vol, PasserByVol, Initial Fut, User Adj, PHF Adj, PHF Volume, Reduct Vol, and FinalVolume.

Table for Critical Gap Module with columns for Critical Gap, FollowUpTim, and values for each approach and movement type.

Table for Capacity Module with columns for Conflict Vol, Potent Cap., Move Cap., and Volume/Cap. for each approach and movement type.

Table for Level Of Service Module with columns for 2Way95thQ, Control Del, LOS by Move, Movement, Shared Cap., Shared Queue, Shrd ConDel, Shared LOS, ApproachDel, and ApproachLOS.

Table for Pedestrian parameters including HevVeh, Grade, Peds/Hour, Pedestrian Walk Speed, LaneWidth, and Time Period.

Table for Signal and Computation parameters including Link Index, Dist(miles), Speed(mph), SignalIndex, Cycle Time, InitVolume, Saturation, ArrivalType, G/C, and various computation results for queue clearing and platoon blocking.

```
ConflictVol: 414 xxxxx xxxxx 1199 xxxxx xxxxx 1137 1773 414 1754 1736 600
*** Computation 5: Capacity for Subject Movement During Unblocked Period
InitPotCap: 1156 xxxxx xxxxx 589 xxxxx xxxxx 181 84 643 67 88 505
UpstreamAdj:1.00 x.xxx x.xxx 1.00 x.xxx x.xxx 1.00 1.000 1.000 1.00 1.000 1.000
Potent Cap.:1156 xxxxx xxxxx 589 xxxxx xxxxx 181 84 643 67 88 505
```

BART

Level Of Service Computation Report
2000 HCM Unsignalized (Future Volume Alternative)
PM - Exist + Proj Conditions

Intersection #1008: Lafayette/Harrison (unsignalized) [Study Int 48]

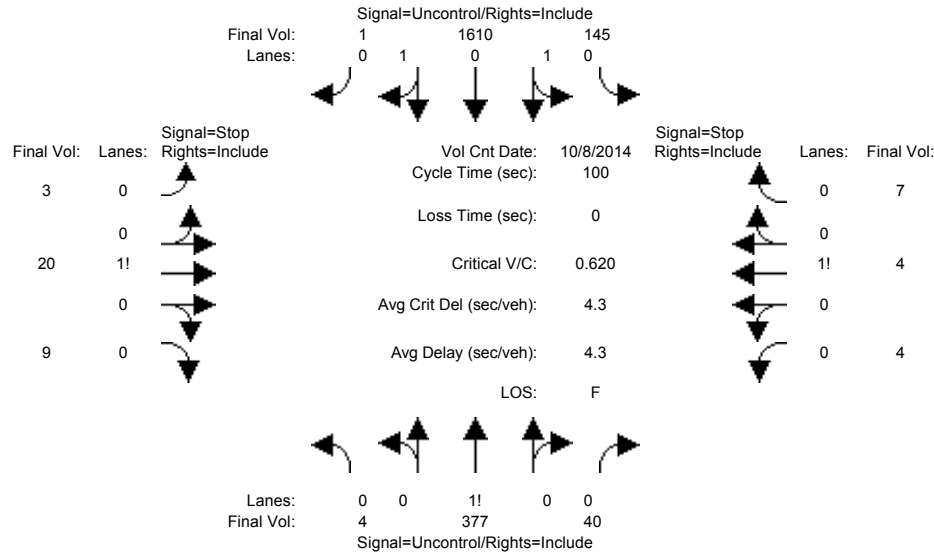

Table with columns for Approach (North, South, East, West Bound) and Movement (L, T, R). Rows include Volume Module, Critical Gap Module, Capacity Module, Level Of Service Module, and various performance metrics like HevVeh, Grade, Peds/Hour, etc.



```
ConflictVol:1611 xxxxx xxxxx 417 xxxxx xxxxx 2311 2326 806 1510 2306 397
*** Computation 5: Capacity for Subject Movement During Unblocked Period
InitPotCap: 411 xxxxx xxxxx 1153 xxxxx xxxxx 27 38 385 100 39 657
UpstreamAdj:1.00 x.xxx x.xxx 1.00 x.xxx x.xxx 1.00 1.000 1.000 1.00 1.000 1.000
Potent Cap.: 411 xxxxx xxxxx 1153 xxxxx xxxxx 27 38 385 100 39 657
```

BART

Level Of Service Computation Report  
 2000 HCM Operations (Future Volume Alternative)  
 AM - Exist + Proj Conditions

Intersection #1012: El Camino Real/Railroad Ave [Study Int 53]

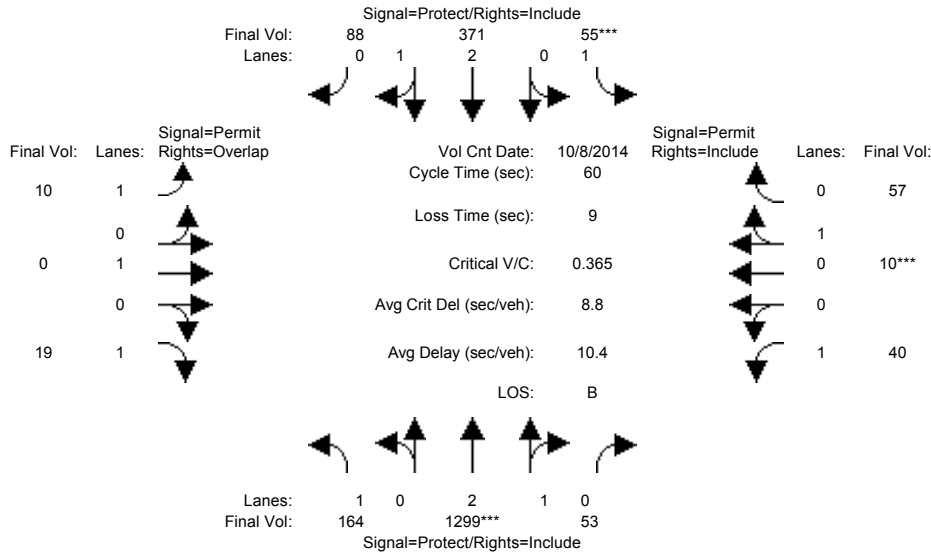

| Approach:                                   | North Bound |      |      | South Bound |      |      | East Bound |      |      | West Bound |      |      |
|---|-------------|------|------|-------------|------|------|------------|------|------|------------|------|------|
| Movement:                                   | L           | T    | R    | L           | T    | R    | L          | T    | R    | L          | T    | R    |
| Min. Green:                                 | 7           | 10   | 10   | 7           | 10   | 10   | 10         | 10   | 10   | 10         | 10   | 10   |
| Y+R:  | 4.0         | 4.0  | 4.0  | 4.0         | 4.0  | 4.0  | 4.0        | 4.0  | 4.0  | 4.0        | 4.0  | 4.0  |
| Volume Module: >> Count Date: 8 Oct 2014 << |             |      |      |             |      |      |            |      |      |            |      |      |
| Base Vol:                                   | 164         | 1299 | 53   | 55          | 371  | 88   | 10         | 0    | 19   | 40         | 10   | 57   |
| Growth Adj:                                 | 1.00        | 1.00 | 1.00 | 1.00        | 1.00 | 1.00 | 1.00       | 1.00 | 1.00 | 1.00       | 1.00 | 1.00 |
| Initial Bse:                                | 164         | 1299 | 53   | 55          | 371  | 88   | 10         | 0    | 19   | 40         | 10   | 57   |
| Added Vol:                                  | 0           | 0    | 0    | 0           | 0    | 0    | 0          | 0    | 0    | 0          | 0    | 0    |
| PasserByVol:                                | 0           | 0    | 0    | 0           | 0    | 0    | 0          | 0    | 0    | 0          | 0    | 0    |
| Initial Fut:                                | 164         | 1299 | 53   | 55          | 371  | 88   | 10         | 0    | 19   | 40         | 10   | 57   |
| User Adj:                                   | 1.00        | 1.00 | 1.00 | 1.00        | 1.00 | 1.00 | 1.00       | 1.00 | 1.00 | 1.00       | 1.00 | 1.00 |
| PHF Adj:                                    | 1.00        | 1.00 | 1.00 | 1.00        | 1.00 | 1.00 | 1.00       | 1.00 | 1.00 | 1.00       | 1.00 | 1.00 |
| PHF Volume:                                 | 164         | 1299 | 53   | 55          | 371  | 88   | 10         | 0    | 19   | 40         | 10   | 57   |
| Reduct Vol:                                 | 0           | 0    | 0    | 0           | 0    | 0    | 0          | 0    | 0    | 0          | 0    | 0    |
| Reduced Vol:                                | 164         | 1299 | 53   | 55          | 371  | 88   | 10         | 0    | 19   | 40         | 10   | 57   |
| PCE Adj:                                    | 1.00        | 1.00 | 1.00 | 1.00        | 1.00 | 1.00 | 1.00       | 1.00 | 1.00 | 1.00       | 1.00 | 1.00 |
| MLF Adj:                                    | 1.00        | 1.00 | 1.00 | 1.00        | 1.00 | 1.00 | 1.00       | 1.00 | 1.00 | 1.00       | 1.00 | 1.00 |
| Final Volume:                               | 164         | 1299 | 53   | 55          | 371  | 88   | 10         | 0    | 19   | 40         | 10   | 57   |
| Saturation Flow Module:                     |             |      |      |             |      |      |            |      |      |            |      |      |
| Sat/Lane:                                   | 1900        | 1900 | 1900 | 1900        | 1900 | 1900 | 1900       | 1900 | 1900 | 1900       | 1900 | 1900 |
| Adjustment:                                 | 0.92        | 0.98 | 0.95 | 0.92        | 0.99 | 0.95 | 0.92       | 1.00 | 0.92 | 0.92       | 0.95 | 0.95 |
| Lanes:                                      | 1.00        | 2.88 | 0.12 | 1.00        | 2.40 | 0.60 | 1.00       | 1.00 | 1.00 | 1.00       | 0.15 | 0.85 |
| Final Sat.:                                 | 1750        | 5380 | 220  | 1750        | 4525 | 1073 | 1750       | 1900 | 1750 | 1750       | 269  | 1531 |
| Capacity Analysis Module:                   |             |      |      |             |      |      |            |      |      |            |      |      |
| Vol/Sat:                                    | 0.09        | 0.24 | 0.24 | 0.03        | 0.08 | 0.08 | 0.01       | 0.00 | 0.01 | 0.02       | 0.04 | 0.04 |
| Crit Moves:                                 | ****        |      |      | ****        |      |      |            |      |      | ****       |      |      |
| Green Time:                                 | 16.9        | 34.0 | 34.0 | 7.0         | 24.1 | 24.1 | 10.0       | 0.0  | 26.9 | 10.0       | 10.0 | 10.0 |
| Volume/Cap:                                 | 0.33        | 0.43 | 0.43 | 0.27        | 0.20 | 0.20 | 0.03       | 0.00 | 0.02 | 0.14       | 0.22 | 0.22 |
| Delay/Veh:                                  | 17.5        | 7.5  | 7.5  | 24.9        | 11.7 | 11.7 | 21.0       | 0.0  | 9.3  | 21.5       | 22.0 | 22.0 |
| User DelAdj:                                | 1.00        | 1.00 | 1.00 | 1.00        | 1.00 | 1.00 | 1.00       | 1.00 | 1.00 | 1.00       | 1.00 | 1.00 |
| AdjDel/Veh:                                 | 17.5        | 7.5  | 7.5  | 24.9        | 11.7 | 11.7 | 21.0       | 0.0  | 9.3  | 21.5       | 22.0 | 22.0 |
| LOS by Move:                                | B           | A    | A    | C           | B    | B    | C          | A    | A    | C          | C    | C    |
| HCM2k95thQ:                                 | 6           | 10   | 10   | 2           | 4    | 4    | 0          | 0    | 0    | 2          | 3    | 3    |

Note: Queue reported is the number of cars per lane.

BART

Level Of Service Computation Report  
 2000 HCM Operations (Future Volume Alternative)  
 PM - Exist + Proj Conditions

Intersection #1012: El Camino Real/Railroad Ave [Study Int 53]

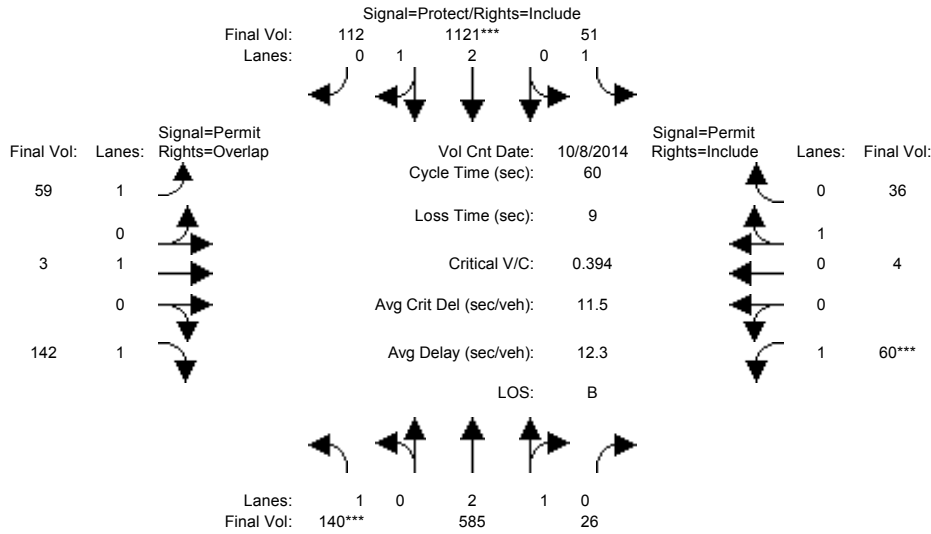

| Approach:                                   | North Bound |      |      | South Bound |      |      | East Bound |      |      | West Bound |      |      |
|---|-------------|------|------|-------------|------|------|------------|------|------|------------|------|------|
| Movement:                                   | L           | T    | R    | L           | T    | R    | L          | T    | R    | L          | T    | R    |
| Min. Green:                                 | 7           | 10   | 10   | 7           | 10   | 10   | 10         | 10   | 10   | 10         | 10   | 10   |
| Y+R:  | 4.0         | 4.0  | 4.0  | 4.0         | 4.0  | 4.0  | 4.0        | 4.0  | 4.0  | 4.0        | 4.0  | 4.0  |
| Volume Module: >> Count Date: 8 Oct 2014 << |             |      |      |             |      |      |            |      |      |            |      |      |
| Base Vol:                                   | 140         | 585  | 26   | 51          | 1121 | 112  | 59         | 3    | 142  | 60         | 4    | 36   |
| Growth Adj:                                 | 1.00        | 1.00 | 1.00 | 1.00        | 1.00 | 1.00 | 1.00       | 1.00 | 1.00 | 1.00       | 1.00 | 1.00 |
| Initial Bse:                                | 140         | 585  | 26   | 51          | 1121 | 112  | 59         | 3    | 142  | 60         | 4    | 36   |
| Added Vol:                                  | 0           | 0    | 0    | 0           | 0    | 0    | 0          | 0    | 0    | 0          | 0    | 0    |
| PasserByVol:                                | 0           | 0    | 0    | 0           | 0    | 0    | 0          | 0    | 0    | 0          | 0    | 0    |
| Initial Fut:                                | 140         | 585  | 26   | 51          | 1121 | 112  | 59         | 3    | 142  | 60         | 4    | 36   |
| User Adj:                                   | 1.00        | 1.00 | 1.00 | 1.00        | 1.00 | 1.00 | 1.00       | 1.00 | 1.00 | 1.00       | 1.00 | 1.00 |
| PHF Adj:                                    | 1.00        | 1.00 | 1.00 | 1.00        | 1.00 | 1.00 | 1.00       | 1.00 | 1.00 | 1.00       | 1.00 | 1.00 |
| PHF Volume:                                 | 140         | 585  | 26   | 51          | 1121 | 112  | 59         | 3    | 142  | 60         | 4    | 36   |
| Reduct Vol:                                 | 0           | 0    | 0    | 0           | 0    | 0    | 0          | 0    | 0    | 0          | 0    | 0    |
| Reduced Vol:                                | 140         | 585  | 26   | 51          | 1121 | 112  | 59         | 3    | 142  | 60         | 4    | 36   |
| PCE Adj:                                    | 1.00        | 1.00 | 1.00 | 1.00        | 1.00 | 1.00 | 1.00       | 1.00 | 1.00 | 1.00       | 1.00 | 1.00 |
| MLF Adj:                                    | 1.00        | 1.00 | 1.00 | 1.00        | 1.00 | 1.00 | 1.00       | 1.00 | 1.00 | 1.00       | 1.00 | 1.00 |
| Final Volume:                               | 140         | 585  | 26   | 51          | 1121 | 112  | 59         | 3    | 142  | 60         | 4    | 36   |
| Saturation Flow Module:                     |             |      |      |             |      |      |            |      |      |            |      |      |
| Sat/Lane:                                   | 1900        | 1900 | 1900 | 1900        | 1900 | 1900 | 1900       | 1900 | 1900 | 1900       | 1900 | 1900 |
| Adjustment:                                 | 0.92        | 0.98 | 0.95 | 0.92        | 0.99 | 0.95 | 0.92       | 1.00 | 0.92 | 0.92       | 0.95 | 0.95 |
| Lanes:                                      | 1.00        | 2.87 | 0.13 | 1.00        | 2.72 | 0.28 | 1.00       | 1.00 | 1.00 | 1.00       | 0.10 | 0.90 |
| Final Sat.:                                 | 1750        | 5361 | 238  | 1750        | 5091 | 509  | 1750       | 1900 | 1750 | 1750       | 180  | 1620 |
| Capacity Analysis Module:                   |             |      |      |             |      |      |            |      |      |            |      |      |
| Vol/Sat:                                    | 0.08        | 0.11 | 0.11 | 0.03        | 0.22 | 0.22 | 0.03       | 0.00 | 0.08 | 0.03       | 0.02 | 0.02 |
| Crit Moves:                                 | ****        |      |      | ****        |      |      |            |      | **** | ****       |      |      |
| Green Time:                                 | 10.9        | 24.1 | 24.1 | 16.9        | 30.1 | 30.1 | 10.0       | 10.0 | 20.9 | 10.0       | 10.0 | 10.0 |
| Volume/Cap:                                 | 0.44        | 0.27 | 0.27 | 0.10        | 0.44 | 0.44 | 0.20       | 0.01 | 0.23 | 0.21       | 0.13 | 0.13 |
| Delay/Veh:                                  | 22.8        | 12.1 | 12.1 | 16.1        | 9.7  | 9.7  | 21.9       | 20.9 | 14.0 | 21.9       | 21.5 | 21.5 |
| User DelAdj:                                | 1.00        | 1.00 | 1.00 | 1.00        | 1.00 | 1.00 | 1.00       | 1.00 | 1.00 | 1.00       | 1.00 | 1.00 |
| AdjDel/Veh:                                 | 22.8        | 12.1 | 12.1 | 16.1        | 9.7  | 9.7  | 21.9       | 20.9 | 14.0 | 21.9       | 21.5 | 21.5 |
| LOS by Move:                                | C           | B    | B    | B           | A    | A    | C          | C    | B    | C          | C    | C    |
| HCM2k95thQ:                                 | 6           | 5    | 5    | 1           | 9    | 9    | 2          | 0    | 4    | 2          | 2    | 2    |

Note: Queue reported is the number of cars per lane.

BART

Level Of Service Computation Report  
 2000 HCM Operations (Future Volume Alternative)  
 AM - Exist + Proj Conditions

Intersection #1202: LAFAYETTE/EL CAMINO REAL [Study Int 46]

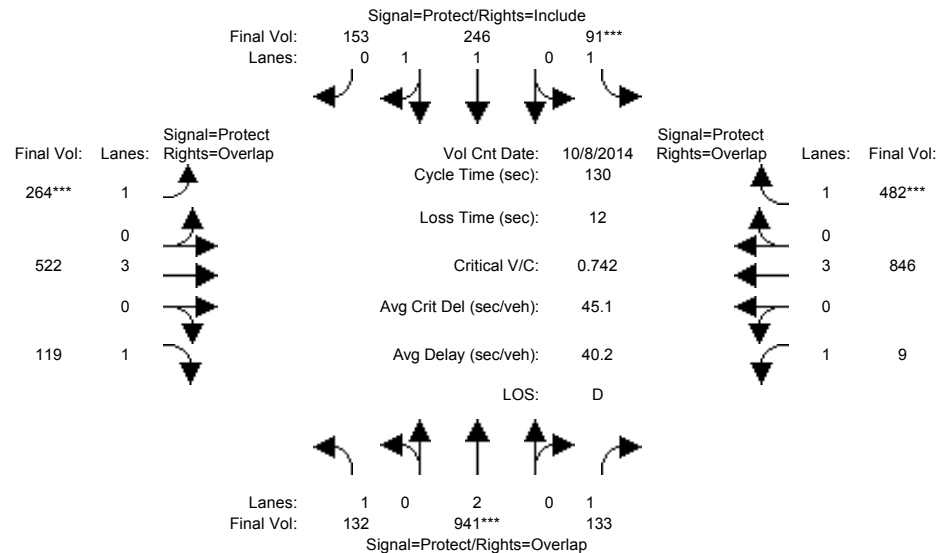

| Approach:                                   | North Bound |      |      | South Bound |      |      | East Bound |      |      | West Bound |      |      |
|---|-------------|------|------|-------------|------|------|------------|------|------|------------|------|------|
| Movement:                                   | L           | T    | R    | L           | T    | R    | L          | T    | R    | L          | T    | R    |
| Min. Green:                                 | 7           | 10   | 10   | 7           | 10   | 10   | 7          | 10   | 10   | 7          | 10   | 10   |
| Y+R:  | 4.0         | 4.0  | 4.0  | 4.0         | 4.0  | 4.0  | 4.0        | 4.0  | 4.0  | 4.0        | 4.0  | 4.0  |
| Volume Module: >> Count Date: 8 Oct 2014 << |             |      |      |             |      |      |            |      |      |            |      |      |
| Base Vol:                                   | 132         | 941  | 133  | 91          | 246  | 153  | 264        | 522  | 119  | 9          | 846  | 482  |
| Growth Adj:                                 | 1.00        | 1.00 | 1.00 | 1.00        | 1.00 | 1.00 | 1.00       | 1.00 | 1.00 | 1.00       | 1.00 | 1.00 |
| Initial Bse:                                | 132         | 941  | 133  | 91          | 246  | 153  | 264        | 522  | 119  | 9          | 846  | 482  |
| Added Vol:                                  | 0           | 0    | 0    | 0           | 0    | 0    | 0          | 0    | 0    | 0          | 0    | 0    |
| PasserByVol:                                | 0           | 0    | 0    | 0           | 0    | 0    | 0          | 0    | 0    | 0          | 0    | 0    |
| Initial Fut:                                | 132         | 941  | 133  | 91          | 246  | 153  | 264        | 522  | 119  | 9          | 846  | 482  |
| User Adj:                                   | 1.00        | 1.00 | 1.00 | 1.00        | 1.00 | 1.00 | 1.00       | 1.00 | 1.00 | 1.00       | 1.00 | 1.00 |
| PHF Adj:                                    | 1.00        | 1.00 | 1.00 | 1.00        | 1.00 | 1.00 | 1.00       | 1.00 | 1.00 | 1.00       | 1.00 | 1.00 |
| PHF Volume:                                 | 132         | 941  | 133  | 91          | 246  | 153  | 264        | 522  | 119  | 9          | 846  | 482  |
| Reduct Vol:                                 | 0           | 0    | 0    | 0           | 0    | 0    | 0          | 0    | 0    | 0          | 0    | 0    |
| Reduced Vol:                                | 132         | 941  | 133  | 91          | 246  | 153  | 264        | 522  | 119  | 9          | 846  | 482  |
| PCE Adj:                                    | 1.00        | 1.00 | 1.00 | 1.00        | 1.00 | 1.00 | 1.00       | 1.00 | 1.00 | 1.00       | 1.00 | 1.00 |
| MLF Adj:                                    | 1.00        | 1.00 | 1.00 | 1.00        | 1.00 | 1.00 | 1.00       | 1.00 | 1.00 | 1.00       | 1.00 | 1.00 |
| Final Volume:                               | 132         | 941  | 133  | 91          | 246  | 153  | 264        | 522  | 119  | 9          | 846  | 482  |
| Saturation Flow Module:                     |             |      |      |             |      |      |            |      |      |            |      |      |
| Sat/Lane:                                   | 1900        | 1900 | 1900 | 1900        | 1900 | 1900 | 1900       | 1900 | 1900 | 1900       | 1900 | 1900 |
| Adjustment:                                 | 0.92        | 1.00 | 0.92 | 0.92        | 0.99 | 0.95 | 0.92       | 1.00 | 0.92 | 0.92       | 1.00 | 0.92 |
| Lanes:                                      | 1.00        | 2.00 | 1.00 | 1.00        | 1.21 | 0.79 | 1.00       | 3.00 | 1.00 | 1.00       | 3.00 | 1.00 |
| Final Sat.:                                 | 1750        | 3800 | 1750 | 1750        | 2280 | 1418 | 1750       | 5700 | 1750 | 1750       | 5700 | 1750 |
| Capacity Analysis Module:                   |             |      |      |             |      |      |            |      |      |            |      |      |
| Vol/Sat:                                    | 0.08        | 0.25 | 0.08 | 0.05        | 0.11 | 0.11 | 0.15       | 0.09 | 0.07 | 0.01       | 0.15 | 0.28 |
| Crit Moves:                                 | ****        | **** | **** | ****        | **** | **** | ****       | **** | **** | ****       | **** | **** |
| Green Time:                                 | 21.6        | 43.4 | 67.5 | 9.1         | 30.9 | 30.9 | 26.4       | 41.1 | 62.7 | 24.1       | 38.8 | 47.9 |
| Volume/Cap:                                 | 0.45        | 0.74 | 0.15 | 0.74        | 0.45 | 0.45 | 0.74       | 0.29 | 0.14 | 0.03       | 0.50 | 0.75 |
| Delay/Veh:                                  | 50.0        | 40.8 | 16.3 | 80.7        | 42.7 | 42.7 | 56.8       | 33.6 | 18.8 | 43.4       | 37.8 | 40.6 |
| User DelAdj:                                | 1.00        | 1.00 | 1.00 | 1.00        | 1.00 | 1.00 | 1.00       | 1.00 | 1.00 | 1.00       | 1.00 | 1.00 |
| AdjDel/Veh:                                 | 50.0        | 40.8 | 16.3 | 80.7        | 42.7 | 42.7 | 56.8       | 33.6 | 18.8 | 43.4       | 37.8 | 40.6 |
| LOS by Move:                                | D           | D    | B    | F           | D    | D    | E          | C    | B    | D          | D    | D    |
| HCM2k95thQ:                                 | 10          | 29   | 6    | 8           | 13   | 13   | 20         | 10   | 5    | 1          | 17   | 33   |

Note: Queue reported is the number of cars per lane.

BART

Level Of Service Computation Report  
 2000 HCM Operations (Future Volume Alternative)  
 PM - Exist + Proj Conditions

Intersection #1202: LAFAYETTE/EL CAMINO REAL [Study Int 46]

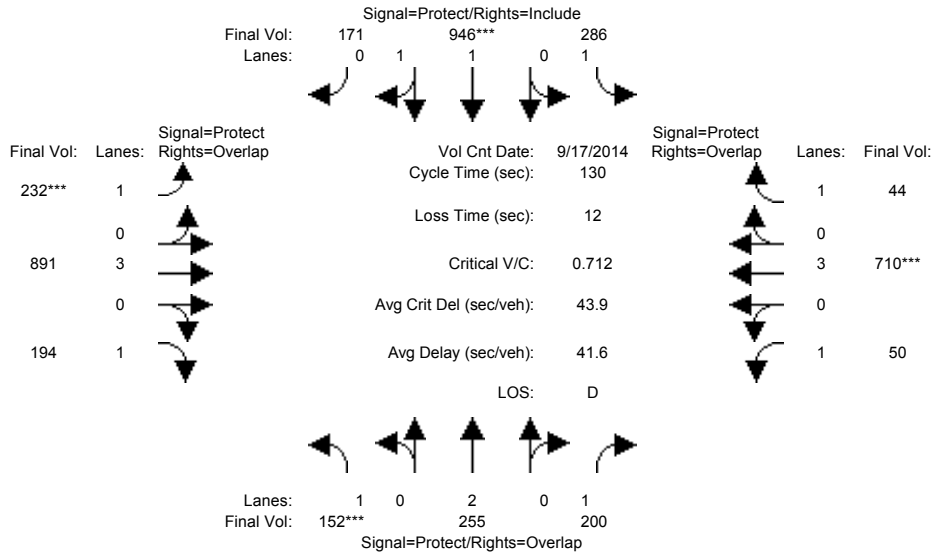

| Approach:                                    | North Bound |      |      | South Bound |      |      | East Bound |      |      | West Bound |      |      |
|--|-------------|------|------|-------------|------|------|------------|------|------|------------|------|------|
| Movement:                                    | L           | T    | R    | L           | T    | R    | L          | T    | R    | L          | T    | R    |
| Min. Green:                                  | 7           | 10   | 10   | 7           | 10   | 10   | 7          | 10   | 10   | 7          | 10   | 10   |
| Y+R:   | 4.0         | 4.0  | 4.0  | 4.0         | 4.0  | 4.0  | 4.0        | 4.0  | 4.0  | 4.0        | 4.0  | 4.0  |
| Volume Module: >> Count Date: 17 Sep 2014 << |             |      |      |             |      |      |            |      |      |            |      |      |
| Base Vol:                                    | 152         | 255  | 200  | 286         | 946  | 171  | 232        | 891  | 194  | 50         | 710  | 44   |
| Growth Adj:                                  | 1.00        | 1.00 | 1.00 | 1.00        | 1.00 | 1.00 | 1.00       | 1.00 | 1.00 | 1.00       | 1.00 | 1.00 |
| Initial Bse:                                 | 152         | 255  | 200  | 286         | 946  | 171  | 232        | 891  | 194  | 50         | 710  | 44   |
| Added Vol:                                   | 0           | 0    | 0    | 0           | 0    | 0    | 0          | 0    | 0    | 0          | 0    | 0    |
| PasserByVol:                                 | 0           | 0    | 0    | 0           | 0    | 0    | 0          | 0    | 0    | 0          | 0    | 0    |
| Initial Fut:                                 | 152         | 255  | 200  | 286         | 946  | 171  | 232        | 891  | 194  | 50         | 710  | 44   |
| User Adj:                                    | 1.00        | 1.00 | 1.00 | 1.00        | 1.00 | 1.00 | 1.00       | 1.00 | 1.00 | 1.00       | 1.00 | 1.00 |
| PHF Adj:                                     | 1.00        | 1.00 | 1.00 | 1.00        | 1.00 | 1.00 | 1.00       | 1.00 | 1.00 | 1.00       | 1.00 | 1.00 |
| PHF Volume:                                  | 152         | 255  | 200  | 286         | 946  | 171  | 232        | 891  | 194  | 50         | 710  | 44   |
| Reduct Vol:                                  | 0           | 0    | 0    | 0           | 0    | 0    | 0          | 0    | 0    | 0          | 0    | 0    |
| Reduced Vol:                                 | 152         | 255  | 200  | 286         | 946  | 171  | 232        | 891  | 194  | 50         | 710  | 44   |
| PCE Adj:                                     | 1.00        | 1.00 | 1.00 | 1.00        | 1.00 | 1.00 | 1.00       | 1.00 | 1.00 | 1.00       | 1.00 | 1.00 |
| MLF Adj:                                     | 1.00        | 1.00 | 1.00 | 1.00        | 1.00 | 1.00 | 1.00       | 1.00 | 1.00 | 1.00       | 1.00 | 1.00 |
| Final Volume:                                | 152         | 255  | 200  | 286         | 946  | 171  | 232        | 891  | 194  | 50         | 710  | 44   |
| Saturation Flow Module:                      |             |      |      |             |      |      |            |      |      |            |      |      |
| Sat/Lane:                                    | 1900        | 1900 | 1900 | 1900        | 1900 | 1900 | 1900       | 1900 | 1900 | 1900       | 1900 | 1900 |
| Adjustment:                                  | 0.92        | 1.00 | 0.92 | 0.92        | 0.98 | 0.95 | 0.92       | 1.00 | 0.92 | 0.92       | 1.00 | 0.92 |
| Lanes:                                       | 1.00        | 2.00 | 1.00 | 1.00        | 1.69 | 0.31 | 1.00       | 3.00 | 1.00 | 1.00       | 3.00 | 1.00 |
| Final Sat.:                                  | 1750        | 3800 | 1750 | 1750        | 3133 | 566  | 1750       | 5700 | 1750 | 1750       | 5700 | 1750 |
| Capacity Analysis Module:                    |             |      |      |             |      |      |            |      |      |            |      |      |
| Vol/Sat:                                     | 0.09        | 0.07 | 0.11 | 0.16        | 0.30 | 0.30 | 0.13       | 0.16 | 0.11 | 0.03       | 0.12 | 0.03 |
| Crit Moves:                                  | ****        |      |      | ****        |      |      | ****       |      |      | ****       |      |      |
| Green Time:                                  | 15.9        | 24.4 | 36.5 | 46.6        | 55.2 | 55.2 | 24.2       | 34.9 | 50.8 | 12.0       | 22.8 | 69.3 |
| Volume/Cap:                                  | 0.71        | 0.36 | 0.41 | 0.46        | 0.71 | 0.71 | 0.71       | 0.58 | 0.28 | 0.31       | 0.71 | 0.05 |
| Delay/Veh:                                   | 65.6        | 46.3 | 38.5 | 32.5        | 32.4 | 32.4 | 56.8       | 41.8 | 27.4 | 56.2       | 53.0 | 14.5 |
| User DelAdj:                                 | 1.00        | 1.00 | 1.00 | 1.00        | 1.00 | 1.00 | 1.00       | 1.00 | 1.00 | 1.00       | 1.00 | 1.00 |
| AdjDel/Veh:                                  | 65.6        | 46.3 | 38.5 | 32.5        | 32.4 | 32.4 | 56.8       | 41.8 | 27.4 | 56.2       | 53.0 | 14.5 |
| LOS by Move:                                 | E           | D    | D    | C           | C    | C    | E          | D    | C    | E          | D    | B    |
| HCM2k95thQ:                                  | 12          | 8    | 13   | 17          | 32   | 32   | 18         | 18   | 11   | 5          | 19   | 2    |

Note: Queue reported is the number of cars per lane.

BART

Level Of Service Computation Report  
2000 HCM Operations (Future Volume Alternative)  
AM - Exist + Proj Conditions

Intersection #1203: ECR/Lincoln 1203 [Study Int 43]

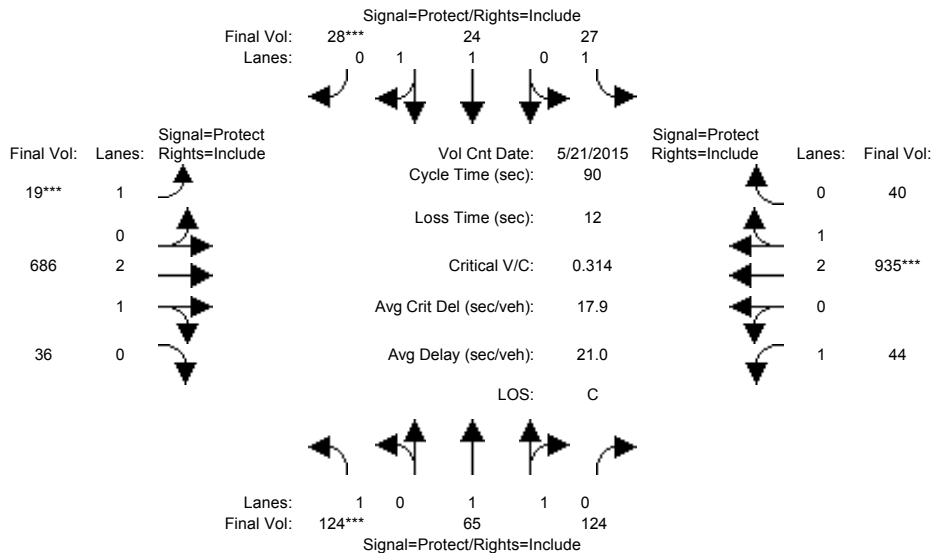

| Approach:                                    | North Bound |      |      | South Bound |      |      | East Bound |      |      | West Bound |      |      |
|--|-------------|------|------|-------------|------|------|------------|------|------|------------|------|------|
| Movement:                                    | L           | T    | R    | L           | T    | R    | L          | T    | R    | L          | T    | R    |
| Min. Green:                                  | 7           | 10   | 10   | 7           | 10   | 10   | 7          | 10   | 10   | 7          | 10   | 10   |
| Y+R:   | 4.0         | 4.0  | 4.0  | 4.0         | 4.0  | 4.0  | 4.0        | 4.0  | 4.0  | 4.0        | 4.0  | 4.0  |
| Volume Module: >> Count Date: 21 May 2015 << |             |      |      |             |      |      |            |      |      |            |      |      |
| Base Vol:                                    | 124         | 65   | 124  | 27          | 24   | 28   | 19         | 686  | 36   | 44         | 935  | 40   |
| Growth Adj:                                  | 1.00        | 1.00 | 1.00 | 1.00        | 1.00 | 1.00 | 1.00       | 1.00 | 1.00 | 1.00       | 1.00 | 1.00 |
| Initial Bse:                                 | 124         | 65   | 124  | 27          | 24   | 28   | 19         | 686  | 36   | 44         | 935  | 40   |
| Added Vol:                                   | 0           | 0    | 0    | 0           | 0    | 0    | 0          | 0    | 0    | 0          | 0    | 0    |
| PasserByVol:                                 | 0           | 0    | 0    | 0           | 0    | 0    | 0          | 0    | 0    | 0          | 0    | 0    |
| Initial Fut:                                 | 124         | 65   | 124  | 27          | 24   | 28   | 19         | 686  | 36   | 44         | 935  | 40   |
| User Adj:                                    | 1.00        | 1.00 | 1.00 | 1.00        | 1.00 | 1.00 | 1.00       | 1.00 | 1.00 | 1.00       | 1.00 | 1.00 |
| PHF Adj:                                     | 1.00        | 1.00 | 1.00 | 1.00        | 1.00 | 1.00 | 1.00       | 1.00 | 1.00 | 1.00       | 1.00 | 1.00 |
| PHF Volume:                                  | 124         | 65   | 124  | 27          | 24   | 28   | 19         | 686  | 36   | 44         | 935  | 40   |
| Reduct Vol:                                  | 0           | 0    | 0    | 0           | 0    | 0    | 0          | 0    | 0    | 0          | 0    | 0    |
| Reduced Vol:                                 | 124         | 65   | 124  | 27          | 24   | 28   | 19         | 686  | 36   | 44         | 935  | 40   |
| PCE Adj:                                     | 1.00        | 1.00 | 1.00 | 1.00        | 1.00 | 1.00 | 1.00       | 1.00 | 1.00 | 1.00       | 1.00 | 1.00 |
| MLF Adj:                                     | 1.00        | 1.00 | 1.00 | 1.00        | 1.00 | 1.00 | 1.00       | 1.00 | 1.00 | 1.00       | 1.00 | 1.00 |
| Final Volume:                                | 124         | 65   | 124  | 27          | 24   | 28   | 19         | 686  | 36   | 44         | 935  | 40   |
| Saturation Flow Module:                      |             |      |      |             |      |      |            |      |      |            |      |      |
| Sat/Lane:                                    | 1900        | 1900 | 1900 | 1900        | 1900 | 1900 | 1900       | 1900 | 1900 | 1900       | 1900 | 1900 |
| Adjustment:                                  | 0.92        | 1.00 | 0.92 | 0.92        | 1.00 | 0.92 | 0.92       | 0.98 | 0.95 | 0.92       | 0.98 | 0.95 |
| Lanes:                                       | 1.00        | 1.00 | 1.00 | 1.00        | 1.00 | 1.00 | 1.00       | 2.84 | 0.16 | 1.00       | 2.87 | 0.13 |
| Final Sat.:                                  | 1750        | 1900 | 1750 | 1750        | 1900 | 1750 | 1750       | 5320 | 279  | 1750       | 5370 | 230  |
| Capacity Analysis Module:                    |             |      |      |             |      |      |            |      |      |            |      |      |
| Vol/Sat:                                     | 0.07        | 0.03 | 0.07 | 0.02        | 0.01 | 0.02 | 0.01       | 0.13 | 0.13 | 0.03       | 0.17 | 0.17 |
| Crit Moves:                                  | ****        |      |      | ****        | **** |      |            |      |      | ****       |      |      |
| Green Time:                                  | 17.6        | 16.3 | 16.3 | 11.4        | 10.0 | 10.0 | 7.0        | 31.4 | 31.4 | 18.9       | 43.4 | 43.4 |
| Volume/Cap:                                  | 0.36        | 0.19 | 0.39 | 0.12        | 0.11 | 0.14 | 0.14       | 0.37 | 0.37 | 0.12       | 0.36 | 0.36 |
| Delay/Veh:                                   | 32.0        | 31.4 | 33.0 | 35.1        | 36.1 | 36.3 | 39.2       | 22.0 | 22.0 | 28.9       | 14.7 | 14.7 |
| User DelAdj:                                 | 1.00        | 1.00 | 1.00 | 1.00        | 1.00 | 1.00 | 1.00       | 1.00 | 1.00 | 1.00       | 1.00 | 1.00 |
| AdjDel/Veh:                                  | 32.0        | 31.4 | 33.0 | 35.1        | 36.1 | 36.3 | 39.2       | 22.0 | 22.0 | 28.9       | 14.7 | 14.7 |
| LOS by Move:                                 | C           | C    | C    | D           | D    | D    | D          | C    | C    | C          | B    | B    |
| HCM2k95thQ:                                  | 6           | 3    | 6    | 2           | 1    | 2    | 1          | 10   | 10   | 2          | 11   | 11   |

Note: Queue reported is the number of cars per lane.

BART

Level Of Service Computation Report  
 2000 HCM Operations (Future Volume Alternative)  
 PM - Exist + Proj Conditions

Intersection #1203: ECR/Lincoln 1203 [Study Int 43]

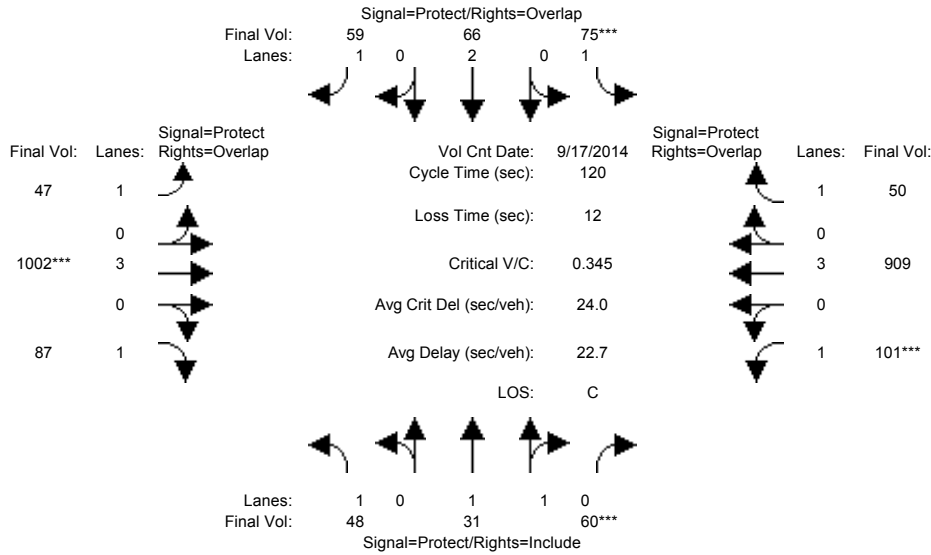

| Approach:  | North Bound |      |      | South Bound |      |      | East Bound |      |      | West Bound |      |      |
|--|-------------|------|------|-------------|------|------|------------|------|------|------------|------|------|
| Movement:  | L           | T    | R    | L           | T    | R    | L          | T    | R    | L          | T    | R    |
| Min. Green:  | 7           | 10   | 10   | 7           | 10   | 10   | 7          | 10   | 10   | 7          | 10   | 10   |
| Y+R:   | 4.0         | 4.0  | 4.0  | 4.0         | 4.0  | 4.0  | 4.0        | 4.0  | 4.0  | 4.0        | 4.0  | 4.0  |
| Volume Module: >> Count Date: 17 Sep 2014 << 4:45-5:45PM |             |      |      |             |      |      |            |      |      |            |      |      |
| Base Vol:  | 48          | 31   | 60   | 75          | 66   | 59   | 47         | 1002 | 87   | 101        | 909  | 50   |
| Growth Adj:  | 1.00        | 1.00 | 1.00 | 1.00        | 1.00 | 1.00 | 1.00       | 1.00 | 1.00 | 1.00       | 1.00 | 1.00 |
| Initial Bse:   | 48          | 31   | 60   | 75          | 66   | 59   | 47         | 1002 | 87   | 101        | 909  | 50   |
| Added Vol:   | 0           | 0    | 0    | 0           | 0    | 0    | 0          | 0    | 0    | 0          | 0    | 0    |
| PasserByVol:   | 0           | 0    | 0    | 0           | 0    | 0    | 0          | 0    | 0    | 0          | 0    | 0    |
| Initial Fut:   | 48          | 31   | 60   | 75          | 66   | 59   | 47         | 1002 | 87   | 101        | 909  | 50   |
| User Adj:  | 1.00        | 1.00 | 1.00 | 1.00        | 1.00 | 1.00 | 1.00       | 1.00 | 1.00 | 1.00       | 1.00 | 1.00 |
| PHF Adj:   | 1.00        | 1.00 | 1.00 | 1.00        | 1.00 | 1.00 | 1.00       | 1.00 | 1.00 | 1.00       | 1.00 | 1.00 |
| PHF Volume:  | 48          | 31   | 60   | 75          | 66   | 59   | 47         | 1002 | 87   | 101        | 909  | 50   |
| Reduct Vol:  | 0           | 0    | 0    | 0           | 0    | 0    | 0          | 0    | 0    | 0          | 0    | 0    |
| Reduced Vol:   | 48          | 31   | 60   | 75          | 66   | 59   | 47         | 1002 | 87   | 101        | 909  | 50   |
| PCE Adj:   | 1.00        | 1.00 | 1.00 | 1.00        | 1.00 | 1.00 | 1.00       | 1.00 | 1.00 | 1.00       | 1.00 | 1.00 |
| MLF Adj:   | 1.00        | 1.00 | 1.00 | 1.00        | 1.00 | 1.00 | 1.00       | 1.00 | 1.00 | 1.00       | 1.00 | 1.00 |
| FinalVolume:   | 48          | 31   | 60   | 75          | 66   | 59   | 47         | 1002 | 87   | 101        | 909  | 50   |
| Saturation Flow Module:                                  |             |      |      |             |      |      |            |      |      |            |      |      |
| Sat/Lane:  | 1900        | 1900 | 1900 | 1900        | 1900 | 1900 | 1900       | 1900 | 1900 | 1900       | 1900 | 1900 |
| Adjustment:  | 0.92        | 1.00 | 0.92 | 0.92        | 1.00 | 0.92 | 0.92       | 1.00 | 0.92 | 0.92       | 1.00 | 0.92 |
| Lanes:   | 1.00        | 1.00 | 1.00 | 1.00        | 2.00 | 1.00 | 1.00       | 3.00 | 1.00 | 1.00       | 3.00 | 1.00 |
| Final Sat.:  | 1750        | 1900 | 1750 | 1750        | 3800 | 1750 | 1750       | 5700 | 1750 | 1750       | 5700 | 1750 |
| Capacity Analysis Module:                                |             |      |      |             |      |      |            |      |      |            |      |      |
| Vol/Sat:   | 0.03        | 0.02 | 0.03 | 0.04        | 0.02 | 0.03 | 0.03       | 0.18 | 0.05 | 0.06       | 0.16 | 0.03 |
| Crit Moves:  | ****        | **** | **** | ****        | **** | **** | ****       | **** | **** | ****       | **** | **** |
| Green Time:  | 11.0        | 11.9 | 11.9 | 14.9        | 15.8 | 37.5 | 21.7       | 61.1 | 72.2 | 20.1       | 59.4 | 74.3 |
| Volume/Cap:  | 0.30        | 0.16 | 0.35 | 0.35        | 0.13 | 0.11 | 0.15       | 0.35 | 0.08 | 0.35       | 0.32 | 0.05 |
| Delay/Veh:   | 51.9        | 49.6 | 51.2 | 49.0        | 46.2 | 29.4 | 41.6       | 17.6 | 10.1 | 44.9       | 18.2 | 9.0  |
| User DelAdj:   | 1.00        | 1.00 | 1.00 | 1.00        | 1.00 | 1.00 | 1.00       | 1.00 | 1.00 | 1.00       | 1.00 | 1.00 |
| AdjDel/Veh:  | 51.9        | 49.6 | 51.2 | 49.0        | 46.2 | 29.4 | 41.6       | 17.6 | 10.1 | 44.9       | 18.2 | 9.0  |
| LOS by Move:   | D           | D    | D    | D           | D    | C    | D          | B    | B    | D          | B    | A    |
| HCM2k95thQ:  | 4           | 2    | 4    | 6           | 2    | 3    | 3          | 13   | 3    | 7          | 12   | 2    |

Note: Queue reported is the number of cars per lane.

BART

Level Of Service Computation Report  
2000 HCM Operations (Future Volume Alternative)  
AM - Exist + Proj Conditions

Intersection #1204: MONROE/EL CAMINO REAL [Study Int 44]

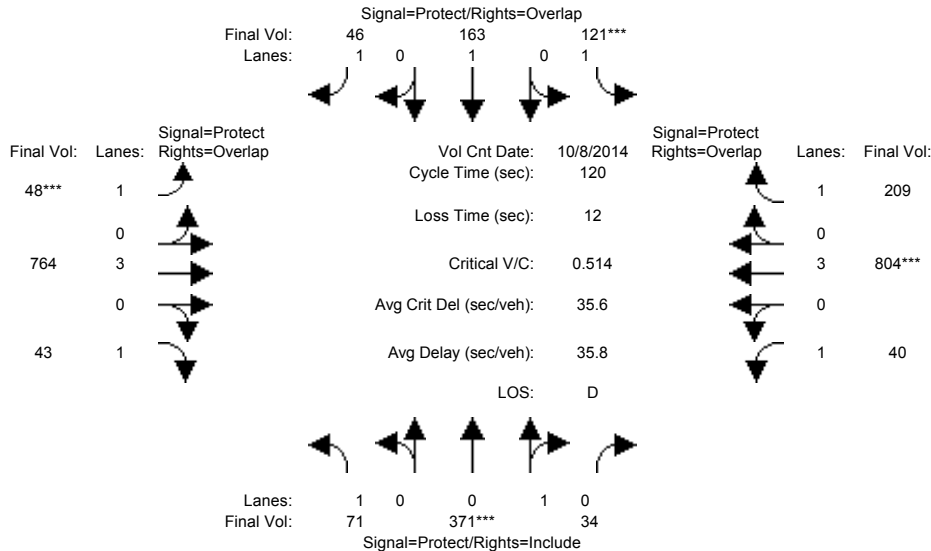

| Approach:                                   | North Bound |      |      | South Bound |      |      | East Bound |      |      | West Bound |      |      |
|---|-------------|------|------|-------------|------|------|------------|------|------|------------|------|------|
| Movement:                                   | L           | T    | R    | L           | T    | R    | L          | T    | R    | L          | T    | R    |
| Min. Green:                                 | 7           | 10   | 10   | 7           | 10   | 10   | 7          | 10   | 10   | 7          | 10   | 10   |
| Y+R:  | 4.0         | 4.0  | 4.0  | 4.0         | 4.0  | 4.0  | 4.0        | 4.0  | 4.0  | 4.0        | 4.0  | 4.0  |
| Volume Module: >> Count Date: 8 Oct 2014 << |             |      |      |             |      |      |            |      |      |            |      |      |
| Base Vol:                                   | 71          | 371  | 34   | 121         | 163  | 46   | 48         | 764  | 43   | 40         | 804  | 209  |
| Growth Adj:                                 | 1.00        | 1.00 | 1.00 | 1.00        | 1.00 | 1.00 | 1.00       | 1.00 | 1.00 | 1.00       | 1.00 | 1.00 |
| Initial Bse:                                | 71          | 371  | 34   | 121         | 163  | 46   | 48         | 764  | 43   | 40         | 804  | 209  |
| Added Vol:                                  | 0           | 0    | 0    | 0           | 0    | 0    | 0          | 0    | 0    | 0          | 0    | 0    |
| PasserByVol:                                | 0           | 0    | 0    | 0           | 0    | 0    | 0          | 0    | 0    | 0          | 0    | 0    |
| Initial Fut:                                | 71          | 371  | 34   | 121         | 163  | 46   | 48         | 764  | 43   | 40         | 804  | 209  |
| User Adj:                                   | 1.00        | 1.00 | 1.00 | 1.00        | 1.00 | 1.00 | 1.00       | 1.00 | 1.00 | 1.00       | 1.00 | 1.00 |
| PHF Adj:                                    | 1.00        | 1.00 | 1.00 | 1.00        | 1.00 | 1.00 | 1.00       | 1.00 | 1.00 | 1.00       | 1.00 | 1.00 |
| PHF Volume:                                 | 71          | 371  | 34   | 121         | 163  | 46   | 48         | 764  | 43   | 40         | 804  | 209  |
| Reduct Vol:                                 | 0           | 0    | 0    | 0           | 0    | 0    | 0          | 0    | 0    | 0          | 0    | 0    |
| Reduced Vol:                                | 71          | 371  | 34   | 121         | 163  | 46   | 48         | 764  | 43   | 40         | 804  | 209  |
| PCE Adj:                                    | 1.00        | 1.00 | 1.00 | 1.00        | 1.00 | 1.00 | 1.00       | 1.00 | 1.00 | 1.00       | 1.00 | 1.00 |
| MLF Adj:                                    | 1.00        | 1.00 | 1.00 | 1.00        | 1.00 | 1.00 | 1.00       | 1.00 | 1.00 | 1.00       | 1.00 | 1.00 |
| Final Volume:                               | 71          | 371  | 34   | 121         | 163  | 46   | 48         | 764  | 43   | 40         | 804  | 209  |
| Saturation Flow Module:                     |             |      |      |             |      |      |            |      |      |            |      |      |
| Sat/Lane:                                   | 1900        | 1900 | 1900 | 1900        | 1900 | 1900 | 1900       | 1900 | 1900 | 1900       | 1900 | 1900 |
| Adjustment:                                 | 0.92        | 0.95 | 0.95 | 0.92        | 1.00 | 0.92 | 0.92       | 1.00 | 0.92 | 0.92       | 1.00 | 0.92 |
| Lanes:                                      | 1.00        | 0.92 | 0.08 | 1.00        | 1.00 | 1.00 | 1.00       | 3.00 | 1.00 | 1.00       | 3.00 | 1.00 |
| Final Sat.:                                 | 1750        | 1649 | 151  | 1750        | 1900 | 1750 | 1750       | 5700 | 1750 | 1750       | 5700 | 1750 |
| Capacity Analysis Module:                   |             |      |      |             |      |      |            |      |      |            |      |      |
| Vol/Sat:                                    | 0.04        | 0.23 | 0.23 | 0.07        | 0.09 | 0.03 | 0.03       | 0.13 | 0.02 | 0.02       | 0.14 | 0.12 |
| Crit Moves:                                 | ****        | **** | **** | ****        | **** | **** | ****       | **** | **** | ****       | **** | **** |
| Green Time:                                 | 27.6        | 52.2 | 52.2 | 16.0        | 40.6 | 47.6 | 7.0        | 27.7 | 55.3 | 12.0       | 32.7 | 48.8 |
| Volume/Cap:                                 | 0.18        | 0.52 | 0.52 | 0.52        | 0.25 | 0.07 | 0.47       | 0.58 | 0.05 | 0.23       | 0.52 | 0.29 |
| Delay/Veh:                                  | 37.3        | 25.3 | 25.3 | 50.4        | 28.9 | 22.4 | 58.1       | 41.7 | 17.9 | 50.4       | 37.2 | 24.2 |
| User DelAdj:                                | 1.00        | 1.00 | 1.00 | 1.00        | 1.00 | 1.00 | 1.00       | 1.00 | 1.00 | 1.00       | 1.00 | 1.00 |
| AdjDel/Veh:                                 | 37.3        | 25.3 | 25.3 | 50.4        | 28.9 | 22.4 | 58.1       | 41.7 | 17.9 | 50.4       | 37.2 | 24.2 |
| LOS by Move:                                | D           | C    | C    | D           | C    | C    | E          | D    | B    | D          | D    | C    |
| HCM2k95thQ:                                 | 5           | 21   | 21   | 9           | 8    | 2    | 4          | 15   | 2    | 3          | 15   | 10   |

Note: Queue reported is the number of cars per lane.



BART

Level Of Service Computation Report  
2000 HCM Operations (Future Volume Alternative)  
PM - Exist + Proj Conditions

Intersection #1204: MONROE/EL CAMINO REAL [Study Int 44]

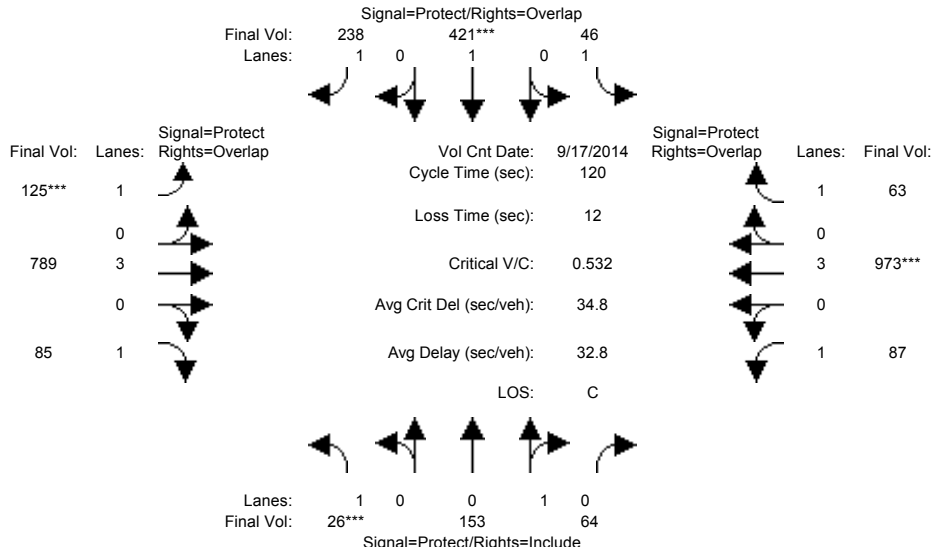

| Approach:                                    | North Bound |      |      | South Bound |      |      | East Bound |      |      | West Bound |      |      |
|--|-------------|------|------|-------------|------|------|------------|------|------|------------|------|------|
| Movement:                                    | L           | T    | R    | L           | T    | R    | L          | T    | R    | L          | T    | R    |
| Min. Green:                                  | 7           | 10   | 10   | 7           | 10   | 10   | 7          | 10   | 10   | 7          | 10   | 10   |
| Y+R:   | 4.0         | 4.0  | 4.0  | 4.0         | 4.0  | 4.0  | 4.0        | 4.0  | 4.0  | 4.0        | 4.0  | 4.0  |
| Volume Module: >> Count Date: 17 Sep 2014 << |             |      |      |             |      |      |            |      |      |            |      |      |
| Base Vol:                                    | 26          | 153  | 64   | 46          | 421  | 238  | 125        | 789  | 85   | 87         | 973  | 63   |
| Growth Adj:                                  | 1.00        | 1.00 | 1.00 | 1.00        | 1.00 | 1.00 | 1.00       | 1.00 | 1.00 | 1.00       | 1.00 | 1.00 |
| Initial Bse:                                 | 26          | 153  | 64   | 46          | 421  | 238  | 125        | 789  | 85   | 87         | 973  | 63   |
| Added Vol:                                   | 0           | 0    | 0    | 0           | 0    | 0    | 0          | 0    | 0    | 0          | 0    | 0    |
| PasserByVol:                                 | 0           | 0    | 0    | 0           | 0    | 0    | 0          | 0    | 0    | 0          | 0    | 0    |
| Initial Fut:                                 | 26          | 153  | 64   | 46          | 421  | 238  | 125        | 789  | 85   | 87         | 973  | 63   |
| User Adj:                                    | 1.00        | 1.00 | 1.00 | 1.00        | 1.00 | 1.00 | 1.00       | 1.00 | 1.00 | 1.00       | 1.00 | 1.00 |
| PHF Adj:                                     | 1.00        | 1.00 | 1.00 | 1.00        | 1.00 | 1.00 | 1.00       | 1.00 | 1.00 | 1.00       | 1.00 | 1.00 |
| PHF Volume:                                  | 26          | 153  | 64   | 46          | 421  | 238  | 125        | 789  | 85   | 87         | 973  | 63   |
| Reduct Vol:                                  | 0           | 0    | 0    | 0           | 0    | 0    | 0          | 0    | 0    | 0          | 0    | 0    |
| Reduced Vol:                                 | 26          | 153  | 64   | 46          | 421  | 238  | 125        | 789  | 85   | 87         | 973  | 63   |
| PCE Adj:                                     | 1.00        | 1.00 | 1.00 | 1.00        | 1.00 | 1.00 | 1.00       | 1.00 | 1.00 | 1.00       | 1.00 | 1.00 |
| MLF Adj:                                     | 1.00        | 1.00 | 1.00 | 1.00        | 1.00 | 1.00 | 1.00       | 1.00 | 1.00 | 1.00       | 1.00 | 1.00 |
| Final Volume:                                | 26          | 153  | 64   | 46          | 421  | 238  | 125        | 789  | 85   | 87         | 973  | 63   |
| Saturation Flow Module:                      |             |      |      |             |      |      |            |      |      |            |      |      |
| Sat/Lane:                                    | 1900        | 1900 | 1900 | 1900        | 1900 | 1900 | 1900       | 1900 | 1900 | 1900       | 1900 | 1900 |
| Adjustment:                                  | 0.92        | 0.95 | 0.95 | 0.92        | 1.00 | 0.92 | 0.92       | 1.00 | 0.92 | 0.92       | 1.00 | 0.92 |
| Lanes:                                       | 1.00        | 0.71 | 0.29 | 1.00        | 1.00 | 1.00 | 1.00       | 3.00 | 1.00 | 1.00       | 3.00 | 1.00 |
| Final Sat.:                                  | 1750        | 1269 | 531  | 1750        | 1900 | 1750 | 1750       | 5700 | 1750 | 1750       | 5700 | 1750 |
| Capacity Analysis Module:                    |             |      |      |             |      |      |            |      |      |            |      |      |
| Vol/Sat:                                     | 0.01        | 0.12 | 0.12 | 0.03        | 0.22 | 0.14 | 0.07       | 0.14 | 0.05 | 0.05       | 0.17 | 0.04 |
| Crit Moves:                                  | ****        |      |      | ****        |      |      | ****       |      |      | ****       |      |      |
| Green Time:                                  | 7.0         | 37.2 | 37.2 | 18.0        | 48.3 | 63.8 | 15.6       | 37.1 | 44.1 | 15.6       | 37.2 | 55.2 |
| Volume/Cap:                                  | 0.25        | 0.39 | 0.39 | 0.18        | 0.55 | 0.26 | 0.55       | 0.45 | 0.13 | 0.38       | 0.55 | 0.08 |
| Delay/Veh:                                   | 55.3        | 32.9 | 32.9 | 44.8        | 28.4 | 15.4 | 51.8       | 33.4 | 25.3 | 48.8       | 34.8 | 18.2 |
| User DelAdj:                                 | 1.00        | 1.00 | 1.00 | 1.00        | 1.00 | 1.00 | 1.00       | 1.00 | 1.00 | 1.00       | 1.00 | 1.00 |
| AdjDel/Veh:                                  | 55.3        | 32.9 | 32.9 | 44.8        | 28.4 | 15.4 | 51.8       | 33.4 | 25.3 | 48.8       | 34.8 | 18.2 |
| LOS by Move:                                 | E           | C    | C    | D           | C    | B    | D          | C    | C    | D          | C    | B    |
| HCM2k95thQ:                                  | 3           | 13   | 13   | 3           | 21   | 10   | 9          | 14   | 4    | 6          | 18   | 3    |

Note: Queue reported is the number of cars per lane.

BART

Level Of Service Computation Report  
 2000 HCM Operations (Future Volume Alternative)  
 AM - Exist + Proj Conditions

Intersection #1205: SCOTT/EL CAMINO REAL [Study Int 42]

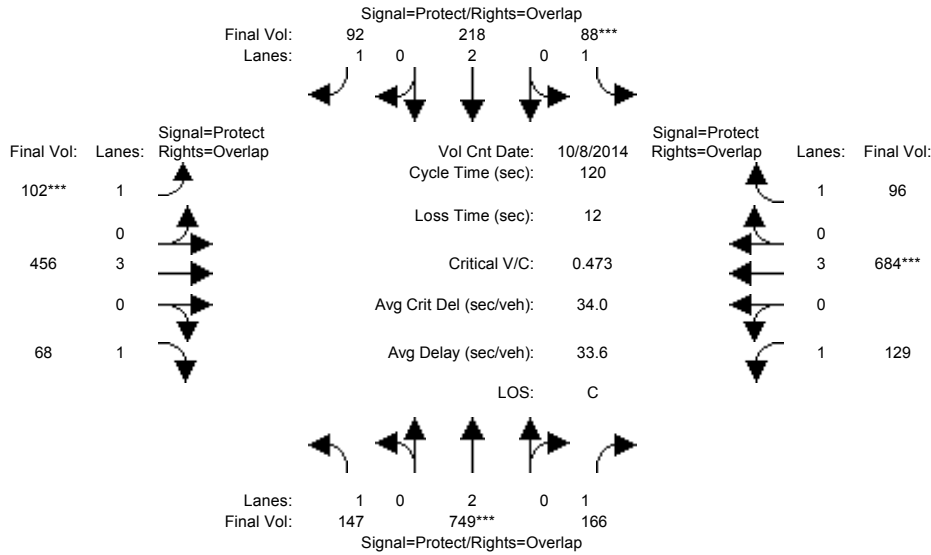

| Approach:                                   | North Bound |      |      | South Bound |      |      | East Bound |      |      | West Bound |      |      |
|---|-------------|------|------|-------------|------|------|------------|------|------|------------|------|------|
| Movement:                                   | L           | T    | R    | L           | T    | R    | L          | T    | R    | L          | T    | R    |
| Min. Green:                                 | 7           | 10   | 10   | 7           | 10   | 10   | 7          | 10   | 10   | 7          | 10   | 10   |
| Y+R:  | 4.0         | 4.0  | 4.0  | 4.0         | 4.0  | 4.0  | 4.0        | 4.0  | 4.0  | 4.0        | 4.0  | 4.0  |
| Volume Module: >> Count Date: 8 Oct 2014 << |             |      |      |             |      |      |            |      |      |            |      |      |
| Base Vol:                                   | 147         | 749  | 166  | 88          | 218  | 92   | 102        | 456  | 68   | 129        | 684  | 96   |
| Growth Adj:                                 | 1.00        | 1.00 | 1.00 | 1.00        | 1.00 | 1.00 | 1.00       | 1.00 | 1.00 | 1.00       | 1.00 | 1.00 |
| Initial Bse:                                | 147         | 749  | 166  | 88          | 218  | 92   | 102        | 456  | 68   | 129        | 684  | 96   |
| Added Vol:                                  | 0           | 0    | 0    | 0           | 0    | 0    | 0          | 0    | 0    | 0          | 0    | 0    |
| PasserByVol:                                | 0           | 0    | 0    | 0           | 0    | 0    | 0          | 0    | 0    | 0          | 0    | 0    |
| Initial Fut:                                | 147         | 749  | 166  | 88          | 218  | 92   | 102        | 456  | 68   | 129        | 684  | 96   |
| User Adj:                                   | 1.00        | 1.00 | 1.00 | 1.00        | 1.00 | 1.00 | 1.00       | 1.00 | 1.00 | 1.00       | 1.00 | 1.00 |
| PHF Adj:                                    | 1.00        | 1.00 | 1.00 | 1.00        | 1.00 | 1.00 | 1.00       | 1.00 | 1.00 | 1.00       | 1.00 | 1.00 |
| PHF Volume:                                 | 147         | 749  | 166  | 88          | 218  | 92   | 102        | 456  | 68   | 129        | 684  | 96   |
| Reduct Vol:                                 | 0           | 0    | 0    | 0           | 0    | 0    | 0          | 0    | 0    | 0          | 0    | 0    |
| Reduced Vol:                                | 147         | 749  | 166  | 88          | 218  | 92   | 102        | 456  | 68   | 129        | 684  | 96   |
| PCE Adj:                                    | 1.00        | 1.00 | 1.00 | 1.00        | 1.00 | 1.00 | 1.00       | 1.00 | 1.00 | 1.00       | 1.00 | 1.00 |
| MLF Adj:                                    | 1.00        | 1.00 | 1.00 | 1.00        | 1.00 | 1.00 | 1.00       | 1.00 | 1.00 | 1.00       | 1.00 | 1.00 |
| Final Volume:                               | 147         | 749  | 166  | 88          | 218  | 92   | 102        | 456  | 68   | 129        | 684  | 96   |
| Saturation Flow Module:                     |             |      |      |             |      |      |            |      |      |            |      |      |
| Sat/Lane:                                   | 1900        | 1900 | 1900 | 1900        | 1900 | 1900 | 1900       | 1900 | 1900 | 1900       | 1900 | 1900 |
| Adjustment:                                 | 0.92        | 1.00 | 0.92 | 0.92        | 1.00 | 0.92 | 0.92       | 1.00 | 0.92 | 0.92       | 1.00 | 0.92 |
| Lanes:                                      | 1.00        | 2.00 | 1.00 | 1.00        | 2.00 | 1.00 | 1.00       | 3.00 | 1.00 | 1.00       | 3.00 | 1.00 |
| Final Sat.:                                 | 1750        | 3800 | 1750 | 1750        | 3800 | 1750 | 1750       | 5700 | 1750 | 1750       | 5700 | 1750 |
| Capacity Analysis Module:                   |             |      |      |             |      |      |            |      |      |            |      |      |
| Vol/Sat:                                    | 0.08        | 0.20 | 0.09 | 0.05        | 0.06 | 0.05 | 0.06       | 0.08 | 0.04 | 0.07       | 0.12 | 0.05 |
| Crit Moves:                                 | ****        | **** | **** | ****        | **** | **** | ****       | **** | **** | ****       | **** | **** |
| Green Time:                                 | 31.5        | 50.0 | 71.2 | 12.8        | 31.3 | 46.0 | 14.8       | 24.0 | 55.5 | 21.2       | 30.4 | 43.2 |
| Volume/Cap:                                 | 0.32        | 0.47 | 0.16 | 0.47        | 0.22 | 0.14 | 0.47       | 0.40 | 0.08 | 0.42       | 0.47 | 0.15 |
| Delay/Veh:                                  | 36.0        | 25.6 | 11.0 | 52.4        | 34.9 | 24.1 | 50.6       | 42.0 | 18.1 | 44.8       | 38.2 | 26.1 |
| User DelAdj:                                | 1.00        | 1.00 | 1.00 | 1.00        | 1.00 | 1.00 | 1.00       | 1.00 | 1.00 | 1.00       | 1.00 | 1.00 |
| AdjDel/Veh:                                 | 36.0        | 25.6 | 11.0 | 52.4        | 34.9 | 24.1 | 50.6       | 42.0 | 18.1 | 44.8       | 38.2 | 26.1 |
| LOS by Move:                                | D           | C    | B    | D           | C    | C    | D          | D    | B    | D          | D    | C    |
| HCM2k95thQ:                                 | 9           | 18   | 6    | 7           | 6    | 5    | 7          | 9    | 3    | 9          | 13   | 5    |

Note: Queue reported is the number of cars per lane.

BART

Level Of Service Computation Report  
 2000 HCM Operations (Future Volume Alternative)  
 PM - Exist + Proj Conditions

Intersection #1205: SCOTT/EL CAMINO REAL [Study Int 42]

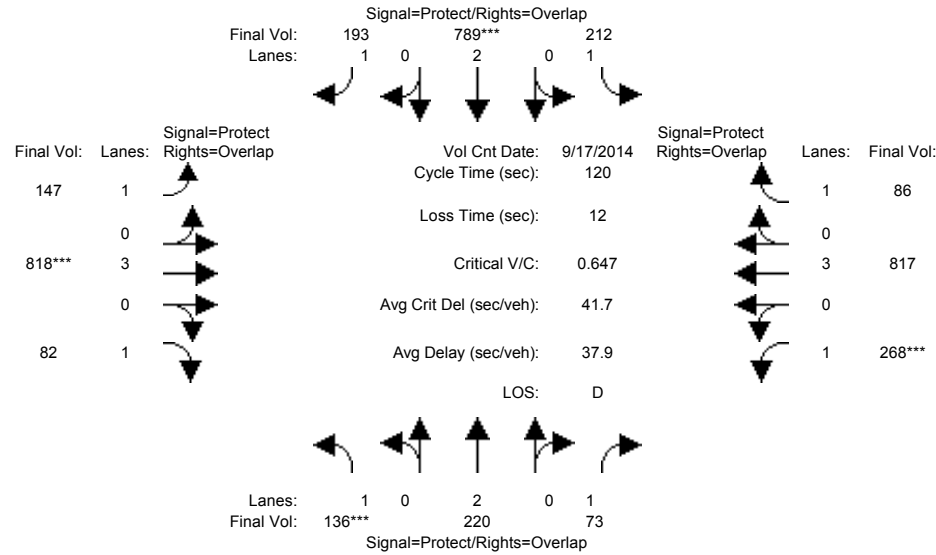

| Approach:                                    | North Bound |      |      | South Bound |      |      | East Bound |      |      | West Bound |      |      |
|--|-------------|------|------|-------------|------|------|------------|------|------|------------|------|------|
| Movement:                                    | L           | T    | R    | L           | T    | R    | L          | T    | R    | L          | T    | R    |
| Min. Green:                                  | 7           | 10   | 10   | 7           | 10   | 10   | 7          | 10   | 10   | 7          | 10   | 10   |
| Y+R:   | 4.0         | 4.0  | 4.0  | 4.0         | 4.0  | 4.0  | 4.0        | 4.0  | 4.0  | 4.0        | 4.0  | 4.0  |
| Volume Module: >> Count Date: 17 Sep 2014 << |             |      |      |             |      |      |            |      |      |            |      |      |
| Base Vol:                                    | 136         | 220  | 73   | 212         | 789  | 193  | 147        | 818  | 82   | 268        | 817  | 86   |
| Growth Adj:                                  | 1.00        | 1.00 | 1.00 | 1.00        | 1.00 | 1.00 | 1.00       | 1.00 | 1.00 | 1.00       | 1.00 | 1.00 |
| Initial Bse:                                 | 136         | 220  | 73   | 212         | 789  | 193  | 147        | 818  | 82   | 268        | 817  | 86   |
| Added Vol:                                   | 0           | 0    | 0    | 0           | 0    | 0    | 0          | 0    | 0    | 0          | 0    | 0    |
| PasserByVol:                                 | 0           | 0    | 0    | 0           | 0    | 0    | 0          | 0    | 0    | 0          | 0    | 0    |
| Initial Fut:                                 | 136         | 220  | 73   | 212         | 789  | 193  | 147        | 818  | 82   | 268        | 817  | 86   |
| User Adj:                                    | 1.00        | 1.00 | 1.00 | 1.00        | 1.00 | 1.00 | 1.00       | 1.00 | 1.00 | 1.00       | 1.00 | 1.00 |
| PHF Adj:                                     | 1.00        | 1.00 | 1.00 | 1.00        | 1.00 | 1.00 | 1.00       | 1.00 | 1.00 | 1.00       | 1.00 | 1.00 |
| PHF Volume:                                  | 136         | 220  | 73   | 212         | 789  | 193  | 147        | 818  | 82   | 268        | 817  | 86   |
| Reduct Vol:                                  | 0           | 0    | 0    | 0           | 0    | 0    | 0          | 0    | 0    | 0          | 0    | 0    |
| Reduced Vol:                                 | 136         | 220  | 73   | 212         | 789  | 193  | 147        | 818  | 82   | 268        | 817  | 86   |
| PCE Adj:                                     | 1.00        | 1.00 | 1.00 | 1.00        | 1.00 | 1.00 | 1.00       | 1.00 | 1.00 | 1.00       | 1.00 | 1.00 |
| MLF Adj:                                     | 1.00        | 1.00 | 1.00 | 1.00        | 1.00 | 1.00 | 1.00       | 1.00 | 1.00 | 1.00       | 1.00 | 1.00 |
| FinalVolume:                                 | 136         | 220  | 73   | 212         | 789  | 193  | 147        | 818  | 82   | 268        | 817  | 86   |
| Saturation Flow Module:                      |             |      |      |             |      |      |            |      |      |            |      |      |
| Sat/Lane:                                    | 1900        | 1900 | 1900 | 1900        | 1900 | 1900 | 1900       | 1900 | 1900 | 1900       | 1900 | 1900 |
| Adjustment:                                  | 0.92        | 1.00 | 0.92 | 0.92        | 1.00 | 0.92 | 0.92       | 1.00 | 0.92 | 0.92       | 1.00 | 0.92 |
| Lanes:                                       | 1.00        | 2.00 | 1.00 | 1.00        | 2.00 | 1.00 | 1.00       | 3.00 | 1.00 | 1.00       | 3.00 | 1.00 |
| Final Sat.:                                  | 1750        | 3800 | 1750 | 1750        | 3800 | 1750 | 1750       | 5700 | 1750 | 1750       | 5700 | 1750 |
| Capacity Analysis Module:                    |             |      |      |             |      |      |            |      |      |            |      |      |
| Vol/Sat:                                     | 0.08        | 0.06 | 0.04 | 0.12        | 0.21 | 0.11 | 0.08       | 0.14 | 0.05 | 0.15       | 0.14 | 0.05 |
| Crit Moves:                                  | ****        |      |      | ****        |      |      | ****       |      |      | ****       |      |      |
| Green Time:                                  | 14.4        | 21.6 | 50.0 | 31.4        | 38.5 | 58.9 | 20.3       | 26.6 | 41.1 | 28.4       | 34.7 | 66.1 |
| Volume/Cap:                                  | 0.65        | 0.32 | 0.10 | 0.46        | 0.65 | 0.22 | 0.50       | 0.65 | 0.14 | 0.65       | 0.50 | 0.09 |
| Delay/Veh:                                   | 57.2        | 43.1 | 21.4 | 38.0        | 36.1 | 17.6 | 46.5       | 43.6 | 27.4 | 44.8       | 35.6 | 12.8 |
| User DelAdj:                                 | 1.00        | 1.00 | 1.00 | 1.00        | 1.00 | 1.00 | 1.00       | 1.00 | 1.00 | 1.00       | 1.00 | 1.00 |
| AdjDel/Veh:                                  | 57.2        | 43.1 | 21.4 | 38.0        | 36.1 | 17.6 | 46.5       | 43.6 | 27.4 | 44.8       | 35.6 | 12.8 |
| LOS by Move:                                 | E           | D    | C    | D           | D    | B    | D          | D    | C    | D          | D    | B    |
| HCM2k95thQ:                                  | 10          | 7    | 3    | 13          | 22   | 8    | 10         | 17   | 4    | 18         | 15   | 3    |

Note: Queue reported is the number of cars per lane.

BART

Level Of Service Computation Report  
 2000 HCM Operations (Future Volume Alternative)  
 AM - Exist + Proj Conditions

Intersection #1213: THE ALAMEDA/EL CAMINO REAL [Study Int 54]

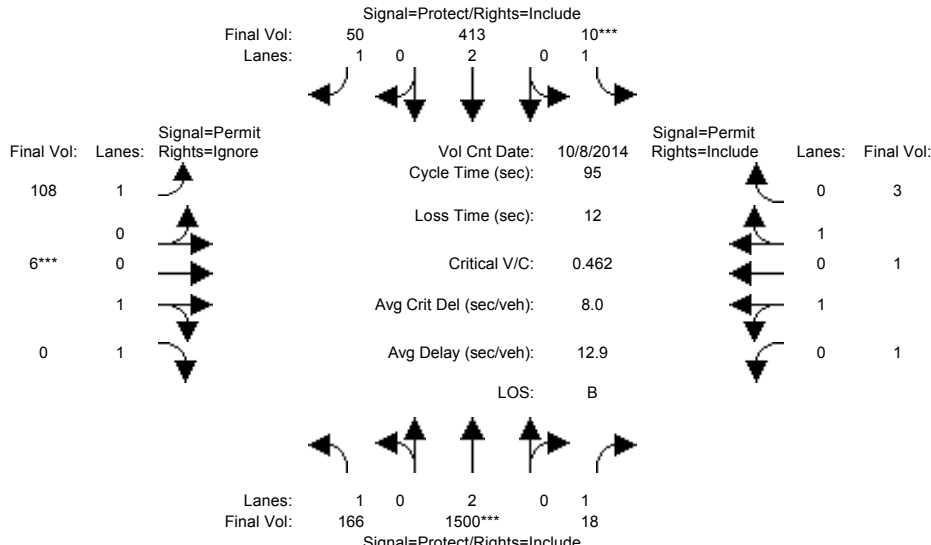

| Approach:                                   | North Bound |      |      | South Bound |      |      | East Bound |      |      | West Bound |      |      |
|---|-------------|------|------|-------------|------|------|------------|------|------|------------|------|------|
| Movement:                                   | L           | T    | R    | L           | T    | R    | L          | T    | R    | L          | T    | R    |
| Min. Green:                                 | 7           | 10   | 10   | 7           | 10   | 10   | 7          | 10   | 10   | 7          | 10   | 10   |
| Y+R:  | 4.0         | 4.0  | 4.0  | 4.0         | 4.0  | 4.0  | 4.0        | 4.0  | 4.0  | 4.0        | 4.0  | 4.0  |
| Volume Module: >> Count Date: 8 Oct 2014 << |             |      |      |             |      |      |            |      |      |            |      |      |
| Base Vol:                                   | 166         | 1500 | 18   | 10          | 413  | 50   | 108        | 6    | 100  | 1          | 1    | 3    |
| Growth Adj:                                 | 1.00        | 1.00 | 1.00 | 1.00        | 1.00 | 1.00 | 1.00       | 1.00 | 1.00 | 1.00       | 1.00 | 1.00 |
| Initial Bse:                                | 166         | 1500 | 18   | 10          | 413  | 50   | 108        | 6    | 100  | 1          | 1    | 3    |
| Added Vol:                                  | 0           | 0    | 0    | 0           | 0    | 0    | 0          | 0    | 0    | 0          | 0    | 0    |
| PasserByVol:                                | 0           | 0    | 0    | 0           | 0    | 0    | 0          | 0    | 0    | 0          | 0    | 0    |
| Initial Fut:                                | 166         | 1500 | 18   | 10          | 413  | 50   | 108        | 6    | 100  | 1          | 1    | 3    |
| User Adj:                                   | 1.00        | 1.00 | 1.00 | 1.00        | 1.00 | 1.00 | 1.00       | 1.00 | 0.00 | 1.00       | 1.00 | 1.00 |
| PHF Adj:                                    | 1.00        | 1.00 | 1.00 | 1.00        | 1.00 | 1.00 | 1.00       | 1.00 | 0.00 | 1.00       | 1.00 | 1.00 |
| PHF Volume:                                 | 166         | 1500 | 18   | 10          | 413  | 50   | 108        | 6    | 0    | 1          | 1    | 3    |
| Reduct Vol:                                 | 0           | 0    | 0    | 0           | 0    | 0    | 0          | 0    | 0    | 0          | 0    | 0    |
| Reduced Vol:                                | 166         | 1500 | 18   | 10          | 413  | 50   | 108        | 6    | 0    | 1          | 1    | 3    |
| PCE Adj:                                    | 1.00        | 1.00 | 1.00 | 1.00        | 1.00 | 1.00 | 1.00       | 1.00 | 0.00 | 1.00       | 1.00 | 1.00 |
| MLF Adj:                                    | 1.00        | 1.00 | 1.00 | 1.00        | 1.00 | 1.00 | 1.00       | 1.00 | 0.00 | 1.00       | 1.00 | 1.00 |
| FinalVolume:                                | 166         | 1500 | 18   | 10          | 413  | 50   | 108        | 6    | 0    | 1          | 1    | 3    |
| Saturation Flow Module:                     |             |      |      |             |      |      |            |      |      |            |      |      |
| Sat/Lane:                                   | 1900        | 1900 | 1900 | 1900        | 1900 | 1900 | 1900       | 1900 | 1900 | 1900       | 1900 | 1900 |
| Adjustment:                                 | 0.92        | 1.00 | 0.92 | 0.92        | 1.00 | 0.92 | 0.92       | 0.95 | 0.92 | 0.95       | 0.95 | 0.95 |
| Lanes:                                      | 1.00        | 2.00 | 1.00 | 1.00        | 2.00 | 1.00 | 1.00       | 1.00 | 1.00 | 0.50       | 0.50 | 1.00 |
| Final Sat.:                                 | 1750        | 3800 | 1750 | 1750        | 3800 | 1750 | 1750       | 1800 | 1750 | 900        | 900  | 1800 |
| Capacity Analysis Module:                   |             |      |      |             |      |      |            |      |      |            |      |      |
| Vol/Sat:                                    | 0.09        | 0.39 | 0.01 | 0.01        | 0.11 | 0.03 | 0.06       | 0.00 | 0.00 | 0.00       | 0.00 | 0.00 |
| Crit Moves:                                 | ****        | **** | **** | ****        | **** | **** | ****       | **** | **** | ****       | **** | **** |
| Green Time:                                 | 34.0        | 66.0 | 66.0 | 7.0         | 39.0 | 39.0 | 10.0       | 10.0 | 0.0  | 10.0       | 10.0 | 10.0 |
| Volume/Cap:                                 | 0.26        | 0.57 | 0.01 | 0.08        | 0.26 | 0.07 | 0.59       | 0.03 | 0.00 | 0.01       | 0.01 | 0.02 |
| Delay/Veh:                                  | 21.8        | 7.6  | 4.5  | 41.3        | 18.6 | 17.0 | 45.4       | 38.2 | 0.0  | 38.1       | 38.1 | 38.1 |
| User DelAdj:                                | 1.00        | 1.00 | 1.00 | 1.00        | 1.00 | 1.00 | 1.00       | 1.00 | 1.00 | 1.00       | 1.00 | 1.00 |
| AdjDel/Veh:                                 | 21.8        | 7.6  | 4.5  | 41.3        | 18.6 | 17.0 | 45.4       | 38.2 | 0.0  | 38.1       | 38.1 | 38.1 |
| LOS by Move:                                | C           | A    | A    | D           | B    | B    | D          | D    | A    | D          | D    | D    |
| HCM2k95thQ:                                 | 7           | 20   | 0    | 1           | 8    | 2    | 8          | 0    | 0    | 0          | 0    | 0    |

Note: Queue reported is the number of cars per lane.

BART

Level Of Service Computation Report  
2000 HCM Operations (Future Volume Alternative)  
PM - Exist + Proj Conditions

Intersection #1213: THE ALAMEDA/EL CAMINO REAL [Study Int 54]

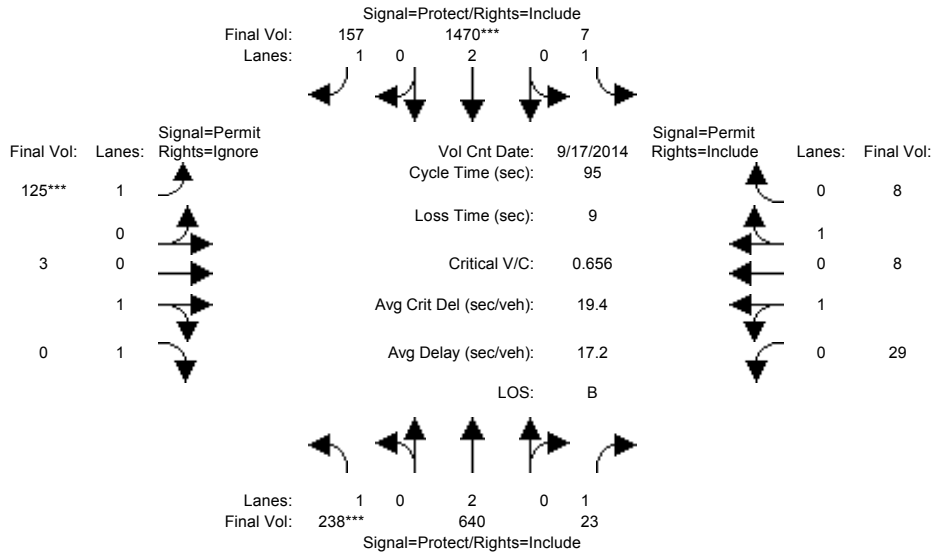

| Approach:                                    | North Bound |      |      | South Bound |      |      | East Bound |      |      | West Bound |      |      |
|--|-------------|------|------|-------------|------|------|------------|------|------|------------|------|------|
| Movement:                                    | L           | T    | R    | L           | T    | R    | L          | T    | R    | L          | T    | R    |
| Min. Green:                                  | 7           | 10   | 10   | 7           | 10   | 10   | 10         | 10   | 10   | 10         | 10   | 10   |
| Y+R:   | 4.0         | 4.0  | 4.0  | 4.0         | 4.0  | 4.0  | 4.0        | 4.0  | 4.0  | 4.0        | 4.0  | 4.0  |
| Volume Module: >> Count Date: 17 Sep 2014 << |             |      |      |             |      |      |            |      |      |            |      |      |
| Base Vol:                                    | 238         | 640  | 23   | 7           | 1470 | 157  | 125        | 3    | 275  | 29         | 8    | 8    |
| Growth Adj:                                  | 1.00        | 1.00 | 1.00 | 1.00        | 1.00 | 1.00 | 1.00       | 1.00 | 1.00 | 1.00       | 1.00 | 1.00 |
| Initial Bse:                                 | 238         | 640  | 23   | 7           | 1470 | 157  | 125        | 3    | 275  | 29         | 8    | 8    |
| Added Vol:                                   | 0           | 0    | 0    | 0           | 0    | 0    | 0          | 0    | 0    | 0          | 0    | 0    |
| PasserByVol:                                 | 0           | 0    | 0    | 0           | 0    | 0    | 0          | 0    | 0    | 0          | 0    | 0    |
| Initial Fut:                                 | 238         | 640  | 23   | 7           | 1470 | 157  | 125        | 3    | 275  | 29         | 8    | 8    |
| User Adj:                                    | 1.00        | 1.00 | 1.00 | 1.00        | 1.00 | 1.00 | 1.00       | 1.00 | 0.00 | 1.00       | 1.00 | 1.00 |
| PHF Adj:                                     | 1.00        | 1.00 | 1.00 | 1.00        | 1.00 | 1.00 | 1.00       | 1.00 | 0.00 | 1.00       | 1.00 | 1.00 |
| PHF Volume:                                  | 238         | 640  | 23   | 7           | 1470 | 157  | 125        | 3    | 0    | 29         | 8    | 8    |
| Reduct Vol:                                  | 0           | 0    | 0    | 0           | 0    | 0    | 0          | 0    | 0    | 0          | 0    | 0    |
| Reduced Vol:                                 | 238         | 640  | 23   | 7           | 1470 | 157  | 125        | 3    | 0    | 29         | 8    | 8    |
| PCE Adj:                                     | 1.00        | 1.00 | 1.00 | 1.00        | 1.00 | 1.00 | 1.00       | 1.00 | 0.00 | 1.00       | 1.00 | 1.00 |
| MLF Adj:                                     | 1.00        | 1.00 | 1.00 | 1.00        | 1.00 | 1.00 | 1.00       | 1.00 | 0.00 | 1.00       | 1.00 | 1.00 |
| Final Volume:                                | 238         | 640  | 23   | 7           | 1470 | 157  | 125        | 3    | 0    | 29         | 8    | 8    |
| Saturation Flow Module:                      |             |      |      |             |      |      |            |      |      |            |      |      |
| Sat/Lane:                                    | 1900        | 1900 | 1900 | 1900        | 1900 | 1900 | 1900       | 1900 | 1900 | 1900       | 1900 | 1900 |
| Adjustment:                                  | 0.92        | 1.00 | 0.92 | 0.92        | 1.00 | 0.92 | 0.92       | 0.95 | 0.92 | 0.95       | 0.95 | 0.95 |
| Lanes:                                       | 1.00        | 2.00 | 1.00 | 1.00        | 2.00 | 1.00 | 1.00       | 1.00 | 1.00 | 1.00       | 0.50 | 0.50 |
| Final Sat.:                                  | 1750        | 3800 | 1750 | 1750        | 3800 | 1750 | 1750       | 1800 | 1750 | 1800       | 900  | 900  |
| Capacity Analysis Module:                    |             |      |      |             |      |      |            |      |      |            |      |      |
| Vol/Sat:                                     | 0.14        | 0.17 | 0.01 | 0.00        | 0.39 | 0.09 | 0.07       | 0.00 | 0.00 | 0.02       | 0.01 | 0.01 |
| Crit Moves:                                  | ****        |      |      | ****        |      |      | ****       |      |      |            |      |      |
| Green Time:                                  | 19.7        | 52.6 | 52.6 | 23.0        | 56.0 | 56.0 | 10.3       | 10.3 | 0.0  | 10.3       | 10.3 | 10.3 |
| Volume/Cap:                                  | 0.66        | 0.30 | 0.02 | 0.02        | 0.66 | 0.15 | 0.66       | 0.02 | 0.00 | 0.15       | 0.08 | 0.08 |
| Delay/Veh:                                   | 38.9        | 11.4 | 9.6  | 27.4        | 13.8 | 8.9  | 48.7       | 37.8 | 0.0  | 38.6       | 38.1 | 38.1 |
| User DelAdj:                                 | 1.00        | 1.00 | 1.00 | 1.00        | 1.00 | 1.00 | 1.00       | 1.00 | 1.00 | 1.00       | 1.00 | 1.00 |
| AdjDel/Veh:                                  | 38.9        | 11.4 | 9.6  | 27.4        | 13.8 | 8.9  | 48.7       | 37.8 | 0.0  | 38.6       | 38.1 | 38.1 |
| LOS by Move:                                 | D           | B    | A    | C           | B    | A    | D          | D    | A    | D          | D    | D    |
| HCM2k95thQ:                                  | 13          | 9    | 1    | 0           | 26   | 4    | 10         | 0    | 0    | 2          | 1    | 1    |

Note: Queue reported is the number of cars per lane.

BART

Level Of Service Computation Report  
 2000 HCM Operations (Future Volume Alternative)  
 AM - Exist + Proj Conditions

Intersection #1214: THE ALAMEDA/NEWHALL [Study Int 55]

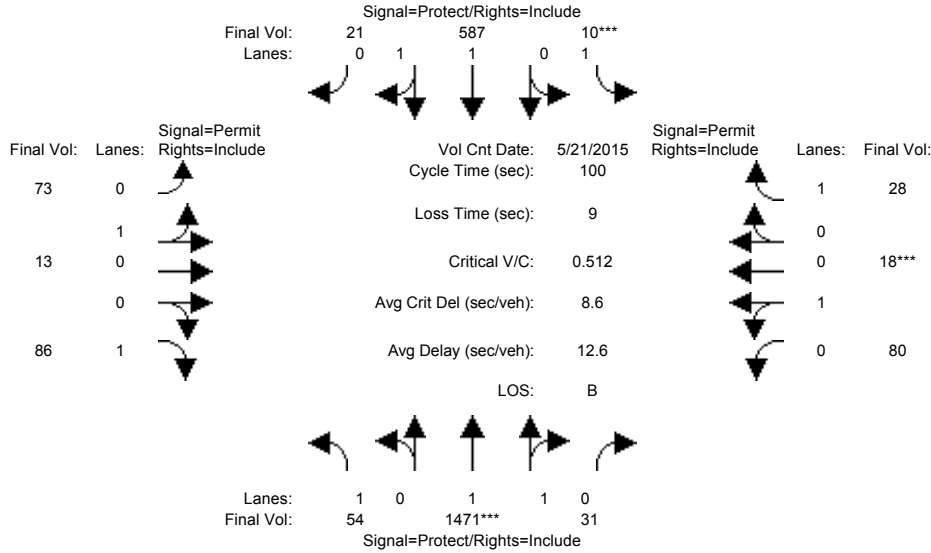

| Approach:                                    | North Bound |      |      | South Bound |      |      | East Bound |      |      | West Bound |      |      |
|--|-------------|------|------|-------------|------|------|------------|------|------|------------|------|------|
| Movement:                                    | L           | T    | R    | L           | T    | R    | L          | T    | R    | L          | T    | R    |
| Min. Green:                                  | 7           | 10   | 10   | 7           | 10   | 10   | 7          | 10   | 10   | 7          | 10   | 10   |
| Y+R:   | 4.0         | 4.0  | 4.0  | 4.0         | 4.0  | 4.0  | 4.0        | 4.0  | 4.0  | 4.0        | 4.0  | 4.0  |
| Volume Module: >> Count Date: 21 May 2015 << |             |      |      |             |      |      |            |      |      |            |      |      |
| Base Vol:                                    | 54          | 1471 | 31   | 10          | 587  | 21   | 73         | 13   | 86   | 80         | 18   | 28   |
| Growth Adj:                                  | 1.00        | 1.00 | 1.00 | 1.00        | 1.00 | 1.00 | 1.00       | 1.00 | 1.00 | 1.00       | 1.00 | 1.00 |
| Initial Bse:                                 | 54          | 1471 | 31   | 10          | 587  | 21   | 73         | 13   | 86   | 80         | 18   | 28   |
| Added Vol:                                   | 0           | 0    | 0    | 0           | 0    | 0    | 0          | 0    | 0    | 0          | 0    | 0    |
| PasserByVol:                                 | 0           | 0    | 0    | 0           | 0    | 0    | 0          | 0    | 0    | 0          | 0    | 0    |
| Initial Fut:                                 | 54          | 1471 | 31   | 10          | 587  | 21   | 73         | 13   | 86   | 80         | 18   | 28   |
| User Adj:                                    | 1.00        | 1.00 | 1.00 | 1.00        | 1.00 | 1.00 | 1.00       | 1.00 | 1.00 | 1.00       | 1.00 | 1.00 |
| PHF Adj:                                     | 1.00        | 1.00 | 1.00 | 1.00        | 1.00 | 1.00 | 1.00       | 1.00 | 1.00 | 1.00       | 1.00 | 1.00 |
| PHF Volume:                                  | 54          | 1471 | 31   | 10          | 587  | 21   | 73         | 13   | 86   | 80         | 18   | 28   |
| Reduct Vol:                                  | 0           | 0    | 0    | 0           | 0    | 0    | 0          | 0    | 0    | 0          | 0    | 0    |
| Reduced Vol:                                 | 54          | 1471 | 31   | 10          | 587  | 21   | 73         | 13   | 86   | 80         | 18   | 28   |
| PCE Adj:                                     | 1.00        | 1.00 | 1.00 | 1.00        | 1.00 | 1.00 | 1.00       | 1.00 | 1.00 | 1.00       | 1.00 | 1.00 |
| MLF Adj:                                     | 1.00        | 1.00 | 1.00 | 1.00        | 1.00 | 1.00 | 1.00       | 1.00 | 1.00 | 1.00       | 1.00 | 1.00 |
| Final Volume:                                | 54          | 1471 | 31   | 10          | 587  | 21   | 73         | 13   | 86   | 80         | 18   | 28   |
| Saturation Flow Module:                      |             |      |      |             |      |      |            |      |      |            |      |      |
| Sat/Lane:                                    | 1900        | 1900 | 1900 | 1900        | 1900 | 1900 | 1900       | 1900 | 1900 | 1900       | 1900 | 1900 |
| Adjustment:                                  | 0.92        | 0.97 | 0.95 | 0.92        | 0.97 | 0.95 | 0.95       | 0.95 | 0.92 | 0.95       | 0.95 | 0.92 |
| Lanes:                                       | 1.00        | 1.96 | 0.04 | 1.00        | 1.93 | 0.07 | 0.85       | 0.15 | 1.00 | 0.82       | 0.18 | 1.00 |
| Final Sat.:                                  | 1750        | 3624 | 76   | 1750        | 3572 | 128  | 1528       | 272  | 1750 | 1469       | 331  | 1750 |
| Capacity Analysis Module:                    |             |      |      |             |      |      |            |      |      |            |      |      |
| Vol/Sat:                                     | 0.03        | 0.41 | 0.41 | 0.01        | 0.16 | 0.16 | 0.05       | 0.05 | 0.05 | 0.05       | 0.05 | 0.02 |
| Crit Moves:                                  | ****        | **** | **** | ****        | **** | **** | ****       | **** | **** | ****       | **** | **** |
| Green Time:                                  | 24.2        | 74.0 | 74.0 | 7.0         | 56.8 | 56.8 | 10.0       | 10.0 | 10.0 | 10.0       | 10.0 | 10.0 |
| Volume/Cap:                                  | 0.13        | 0.55 | 0.55 | 0.08        | 0.29 | 0.29 | 0.48       | 0.48 | 0.49 | 0.54       | 0.54 | 0.16 |
| Delay/Veh:                                   | 29.8        | 5.9  | 5.9  | 43.8        | 11.2 | 11.2 | 44.5       | 44.5 | 44.8 | 46.3       | 46.3 | 41.6 |
| User DelAdj:                                 | 1.00        | 1.00 | 1.00 | 1.00        | 1.00 | 1.00 | 1.00       | 1.00 | 1.00 | 1.00       | 1.00 | 1.00 |
| AdjDel/Veh:                                  | 29.8        | 5.9  | 5.9  | 43.8        | 11.2 | 11.2 | 44.5       | 44.5 | 44.8 | 46.3       | 46.3 | 41.6 |
| LOS by Move:                                 | C           | A    | A    | D           | B    | B    | D          | D    | D    | D          | D    | D    |
| HCM2k95thQ:                                  | 3           | 19   | 19   | 1           | 9    | 9    | 5          | 5    | 5    | 8          | 8    | 2    |

Note: Queue reported is the number of cars per lane.

BART

Level Of Service Computation Report  
 2000 HCM Operations (Future Volume Alternative)  
 PM - Exist + Proj Conditions

Intersection #1214: THE ALAMEDA/NEWHALL [Study Int 55]

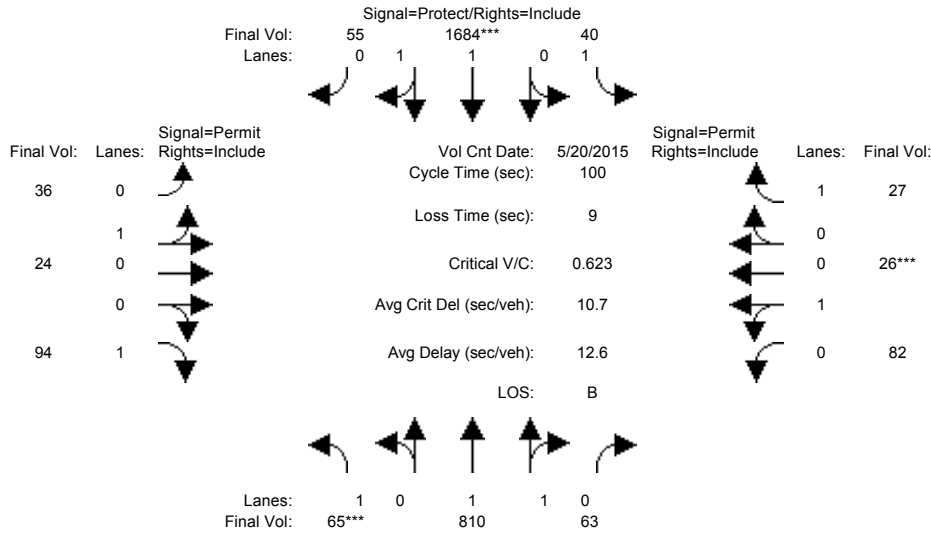

| Approach:                                    | North Bound |      |      | South Bound |      |      | East Bound |      |      | West Bound |      |      |
|--|-------------|------|------|-------------|------|------|------------|------|------|------------|------|------|
| Movement:                                    | L           | T    | R    | L           | T    | R    | L          | T    | R    | L          | T    | R    |
| Min. Green:                                  | 7           | 10   | 10   | 7           | 10   | 10   | 7          | 10   | 10   | 7          | 10   | 10   |
| Y+R:   | 4.0         | 4.0  | 4.0  | 4.0         | 4.0  | 4.0  | 4.0        | 4.0  | 4.0  | 4.0        | 4.0  | 4.0  |
| Volume Module: >> Count Date: 20 May 2015 << |             |      |      |             |      |      |            |      |      |            |      |      |
| Base Vol:                                    | 65          | 810  | 63   | 40          | 1684 | 55   | 36         | 24   | 94   | 82         | 26   | 27   |
| Growth Adj:                                  | 1.00        | 1.00 | 1.00 | 1.00        | 1.00 | 1.00 | 1.00       | 1.00 | 1.00 | 1.00       | 1.00 | 1.00 |
| Initial Bse:                                 | 65          | 810  | 63   | 40          | 1684 | 55   | 36         | 24   | 94   | 82         | 26   | 27   |
| Added Vol:                                   | 0           | 0    | 0    | 0           | 0    | 0    | 0          | 0    | 0    | 0          | 0    | 0    |
| PasserByVol:                                 | 0           | 0    | 0    | 0           | 0    | 0    | 0          | 0    | 0    | 0          | 0    | 0    |
| Initial Fut:                                 | 65          | 810  | 63   | 40          | 1684 | 55   | 36         | 24   | 94   | 82         | 26   | 27   |
| User Adj:                                    | 1.00        | 1.00 | 1.00 | 1.00        | 1.00 | 1.00 | 1.00       | 1.00 | 1.00 | 1.00       | 1.00 | 1.00 |
| PHF Adj:                                     | 1.00        | 1.00 | 1.00 | 1.00        | 1.00 | 1.00 | 1.00       | 1.00 | 1.00 | 1.00       | 1.00 | 1.00 |
| PHF Volume:                                  | 65          | 810  | 63   | 40          | 1684 | 55   | 36         | 24   | 94   | 82         | 26   | 27   |
| Reduct Vol:                                  | 0           | 0    | 0    | 0           | 0    | 0    | 0          | 0    | 0    | 0          | 0    | 0    |
| Reduced Vol:                                 | 65          | 810  | 63   | 40          | 1684 | 55   | 36         | 24   | 94   | 82         | 26   | 27   |
| PCE Adj:                                     | 1.00        | 1.00 | 1.00 | 1.00        | 1.00 | 1.00 | 1.00       | 1.00 | 1.00 | 1.00       | 1.00 | 1.00 |
| MLF Adj:                                     | 1.00        | 1.00 | 1.00 | 1.00        | 1.00 | 1.00 | 1.00       | 1.00 | 1.00 | 1.00       | 1.00 | 1.00 |
| FinalVolume:                                 | 65          | 810  | 63   | 40          | 1684 | 55   | 36         | 24   | 94   | 82         | 26   | 27   |
| Saturation Flow Module:                      |             |      |      |             |      |      |            |      |      |            |      |      |
| Sat/Lane:                                    | 1900        | 1900 | 1900 | 1900        | 1900 | 1900 | 1900       | 1900 | 1900 | 1900       | 1900 | 1900 |
| Adjustment:                                  | 0.92        | 0.98 | 0.95 | 0.92        | 0.97 | 0.95 | 0.95       | 0.95 | 0.92 | 0.95       | 0.95 | 0.92 |
| Lanes:                                       | 1.00        | 1.85 | 0.15 | 1.00        | 1.93 | 0.07 | 0.60       | 0.40 | 1.00 | 0.76       | 0.24 | 1.00 |
| Final Sat.:                                  | 1750        | 3433 | 267  | 1750        | 3583 | 117  | 1080       | 720  | 1750 | 1367       | 433  | 1750 |
| Capacity Analysis Module:                    |             |      |      |             |      |      |            |      |      |            |      |      |
| Vol/Sat:                                     | 0.04        | 0.24 | 0.24 | 0.02        | 0.47 | 0.47 | 0.03       | 0.03 | 0.05 | 0.06       | 0.06 | 0.02 |
| Crit Moves:                                  | ****        |      |      | ****        |      |      |            |      |      | ****       |      |      |
| Green Time:                                  | 7.0         | 62.5 | 62.5 | 18.5        | 74.0 | 74.0 | 10.0       | 10.0 | 10.0 | 10.0       | 10.0 | 10.0 |
| Volume/Cap:                                  | 0.53        | 0.38 | 0.38 | 0.12        | 0.64 | 0.64 | 0.33       | 0.33 | 0.54 | 0.60       | 0.60 | 0.15 |
| Delay/Veh:                                   | 49.3        | 9.3  | 9.3  | 34.1        | 6.9  | 6.9  | 43.0       | 43.0 | 46.1 | 48.6       | 48.6 | 41.5 |
| User DelAdj:                                 | 1.00        | 1.00 | 1.00 | 1.00        | 1.00 | 1.00 | 1.00       | 1.00 | 1.00 | 1.00       | 1.00 | 1.00 |
| AdjDel/Veh:                                  | 49.3        | 9.3  | 9.3  | 34.1        | 6.9  | 6.9  | 43.0       | 43.0 | 46.1 | 48.6       | 48.6 | 41.5 |
| LOS by Move:                                 | D           | A    | A    | C           | A    | A    | D          | D    | D    | D          | D    | D    |
| HCM2k95thQ:                                  | 4           | 13   | 13   | 2           | 24   | 24   | 4          | 4    | 6    | 9          | 9    | 2    |

Note: Queue reported is the number of cars per lane.

BART

Level Of Service Computation Report  
 2000 HCM Operations (Future Volume Alternative)  
 AM - Exist + Proj Conditions

Intersection #3016: 101/ALUM ROCK [Study Int 15]

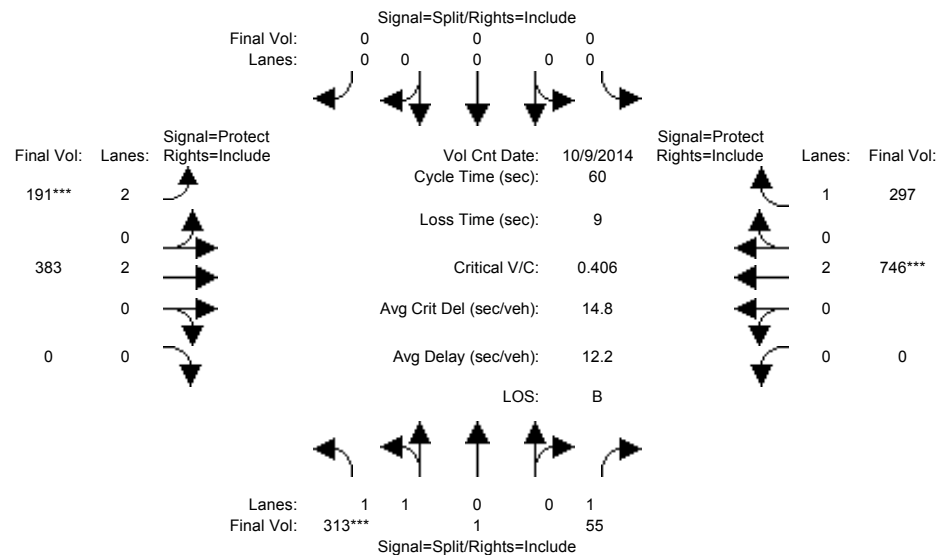

| Approach:                                   | North Bound |      |      | South Bound |      |      | East Bound |      |      | West Bound |      |      |  |
|---|-------------|------|------|-------------|------|------|------------|------|------|------------|------|------|--|
| Movement:                                   | L           | T    | R    | L           | T    | R    | L          | T    | R    | L          | T    | R    |  |
| Min. Green:                                 | 10          | 10   | 10   | 0           | 0    | 0    | 7          | 10   | 0    | 0          | 10   | 10   |  |
| Y+R:  | 4.0         | 4.0  | 4.0  | 4.0         | 4.0  | 4.0  | 4.0        | 4.0  | 4.0  | 4.0        | 4.0  | 4.0  |  |
| Volume Module: >> Count Date: 9 Oct 2014 << |             |      |      |             |      |      |            |      |      |            |      |      |  |
| Base Vol:                                   | 313         | 1    | 55   | 0           | 0    | 0    | 191        | 383  | 0    | 0          | 746  | 297  |  |
| Growth Adj:                                 | 1.00        | 1.00 | 1.00 | 1.00        | 1.00 | 1.00 | 1.00       | 1.00 | 1.00 | 1.00       | 1.00 | 1.00 |  |
| Initial Bse:                                | 313         | 1    | 55   | 0           | 0    | 0    | 191        | 383  | 0    | 0          | 746  | 297  |  |
| Added Vol:                                  | 0           | 0    | 0    | 0           | 0    | 0    | 0          | 0    | 0    | 0          | 0    | 0    |  |
| PasserByVol:                                | 0           | 0    | 0    | 0           | 0    | 0    | 0          | 0    | 0    | 0          | 0    | 0    |  |
| Initial Fut:                                | 313         | 1    | 55   | 0           | 0    | 0    | 191        | 383  | 0    | 0          | 746  | 297  |  |
| User Adj:                                   | 1.00        | 1.00 | 1.00 | 1.00        | 1.00 | 1.00 | 1.00       | 1.00 | 1.00 | 1.00       | 1.00 | 1.00 |  |
| PHF Adj:                                    | 1.00        | 1.00 | 1.00 | 1.00        | 1.00 | 1.00 | 1.00       | 1.00 | 1.00 | 1.00       | 1.00 | 1.00 |  |
| PHF Volume:                                 | 313         | 1    | 55   | 0           | 0    | 0    | 191        | 383  | 0    | 0          | 746  | 297  |  |
| Reduct Vol:                                 | 0           | 0    | 0    | 0           | 0    | 0    | 0          | 0    | 0    | 0          | 0    | 0    |  |
| Reduced Vol:                                | 313         | 1    | 55   | 0           | 0    | 0    | 191        | 383  | 0    | 0          | 746  | 297  |  |
| PCE Adj:                                    | 1.00        | 1.00 | 1.00 | 1.00        | 1.00 | 1.00 | 1.00       | 1.00 | 1.00 | 1.00       | 1.00 | 1.00 |  |
| MLF Adj:                                    | 1.00        | 1.00 | 1.00 | 1.00        | 1.00 | 1.00 | 1.00       | 1.00 | 1.00 | 1.00       | 1.00 | 1.00 |  |
| Final Volume:                               | 313         | 1    | 55   | 0           | 0    | 0    | 191        | 383  | 0    | 0          | 746  | 297  |  |
| Saturation Flow Module:                     |             |      |      |             |      |      |            |      |      |            |      |      |  |
| Sat/Lane:                                   | 1900        | 1900 | 1900 | 1900        | 1900 | 1900 | 1900       | 1900 | 1900 | 1900       | 1900 | 1900 |  |
| Adjustment:                                 | 0.93        | 0.95 | 0.92 | 0.92        | 1.00 | 0.92 | 0.83       | 1.00 | 0.92 | 0.92       | 1.00 | 0.92 |  |
| Lanes:                                      | 1.99        | 0.01 | 1.00 | 0.00        | 0.00 | 0.00 | 2.00       | 2.00 | 0.00 | 0.00       | 2.00 | 1.00 |  |
| Final Sat.:                                 | 3539        | 11   | 1750 | 0           | 0    | 0    | 3150       | 3800 | 0    | 0          | 3800 | 1750 |  |
| Capacity Analysis Module:                   |             |      |      |             |      |      |            |      |      |            |      |      |  |
| Vol/Sat:                                    | 0.09        | 0.09 | 0.03 | 0.00        | 0.00 | 0.00 | 0.06       | 0.10 | 0.00 | 0.00       | 0.20 | 0.17 |  |
| Crit Moves:                                 | ****        |      |      |             |      |      |            | **** |      |            |      |      |  |
| Green Time:                                 | 13.1        | 13.1 | 13.1 | 0.0         | 0.0  | 0.0  | 9.0        | 37.9 | 0.0  | 0.0        | 29.0 | 29.0 |  |
| Volume/Cap:                                 | 0.41        | 0.41 | 0.14 | 0.00        | 0.00 | 0.00 | 0.41       | 0.16 | 0.00 | 0.00       | 0.41 | 0.35 |  |
| Delay/Veh:                                  | 20.5        | 20.5 | 19.1 | 0.0         | 0.0  | 0.0  | 23.7       | 4.5  | 0.0  | 0.0        | 10.1 | 9.9  |  |
| User DelAdj:                                | 1.00        | 1.00 | 1.00 | 1.00        | 1.00 | 1.00 | 1.00       | 1.00 | 1.00 | 1.00       | 1.00 | 1.00 |  |
| AdjDel/Veh:                                 | 20.5        | 20.5 | 19.1 | 0.0         | 0.0  | 0.0  | 23.7       | 4.5  | 0.0  | 0.0        | 10.1 | 9.9  |  |
| LOS by Move:                                | C           | C    | B    | A           | A    | A    | C          | A    | A    | A          | B    | A    |  |
| HCM2k95thQ:                                 | 6           | 6    | 2    | 0           | 0    | 0    | 4          | 3    | 0    | 0          | 9    | 7    |  |

Note: Queue reported is the number of cars per lane.



BART

Level Of Service Computation Report  
 2000 HCM Operations (Future Volume Alternative)  
 PM - Exist + Proj Conditions

Intersection #3016: 101/ALUM ROCK [Study Int 15]

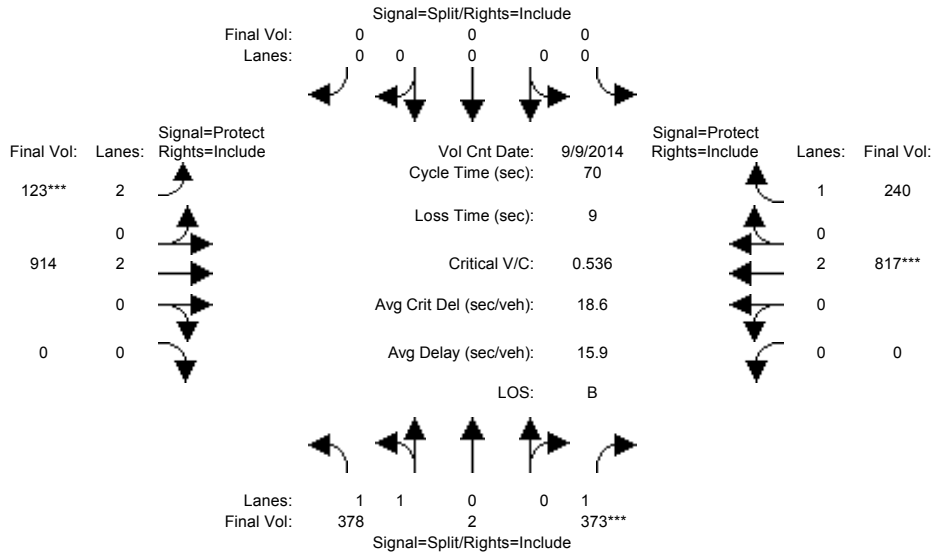

| Approach:                                   | North Bound |      |      | South Bound |      |      | East Bound |      |      | West Bound |      |      |
|---|-------------|------|------|-------------|------|------|------------|------|------|------------|------|------|
| Movement:                                   | L           | T    | R    | L           | T    | R    | L          | T    | R    | L          | T    | R    |
| Min. Green:                                 | 10          | 10   | 10   | 0           | 0    | 0    | 7          | 10   | 0    | 0          | 10   | 10   |
| Y+R:  | 4.0         | 4.0  | 4.0  | 4.0         | 4.0  | 4.0  | 4.0        | 4.0  | 4.0  | 4.0        | 4.0  | 4.0  |
| Volume Module: >> Count Date: 9 Sep 2014 << |             |      |      |             |      |      |            |      |      |            |      |      |
| Base Vol:                                   | 378         | 2    | 373  | 0           | 0    | 0    | 123        | 914  | 0    | 0          | 817  | 240  |
| Growth Adj:                                 | 1.00        | 1.00 | 1.00 | 1.00        | 1.00 | 1.00 | 1.00       | 1.00 | 1.00 | 1.00       | 1.00 | 1.00 |
| Initial Bse:                                | 378         | 2    | 373  | 0           | 0    | 0    | 123        | 914  | 0    | 0          | 817  | 240  |
| Added Vol:                                  | 0           | 0    | 0    | 0           | 0    | 0    | 0          | 0    | 0    | 0          | 0    | 0    |
| PasserByVol:                                | 0           | 0    | 0    | 0           | 0    | 0    | 0          | 0    | 0    | 0          | 0    | 0    |
| Initial Fut:                                | 378         | 2    | 373  | 0           | 0    | 0    | 123        | 914  | 0    | 0          | 817  | 240  |
| User Adj:                                   | 1.00        | 1.00 | 1.00 | 1.00        | 1.00 | 1.00 | 1.00       | 1.00 | 1.00 | 1.00       | 1.00 | 1.00 |
| PHF Adj:                                    | 1.00        | 1.00 | 1.00 | 1.00        | 1.00 | 1.00 | 1.00       | 1.00 | 1.00 | 1.00       | 1.00 | 1.00 |
| PHF Volume:                                 | 378         | 2    | 373  | 0           | 0    | 0    | 123        | 914  | 0    | 0          | 817  | 240  |
| Reduct Vol:                                 | 0           | 0    | 0    | 0           | 0    | 0    | 0          | 0    | 0    | 0          | 0    | 0    |
| Reduced Vol:                                | 378         | 2    | 373  | 0           | 0    | 0    | 123        | 914  | 0    | 0          | 817  | 240  |
| PCE Adj:                                    | 1.00        | 1.00 | 1.00 | 1.00        | 1.00 | 1.00 | 1.00       | 1.00 | 1.00 | 1.00       | 1.00 | 1.00 |
| MLF Adj:                                    | 1.00        | 1.00 | 1.00 | 1.00        | 1.00 | 1.00 | 1.00       | 1.00 | 1.00 | 1.00       | 1.00 | 1.00 |
| FinalVolume:                                | 378         | 2    | 373  | 0           | 0    | 0    | 123        | 914  | 0    | 0          | 817  | 240  |
| Saturation Flow Module:                     |             |      |      |             |      |      |            |      |      |            |      |      |
| Sat/Lane:                                   | 1900        | 1900 | 1900 | 1900        | 1900 | 1900 | 1900       | 1900 | 1900 | 1900       | 1900 | 1900 |
| Adjustment:                                 | 0.93        | 0.95 | 0.92 | 0.92        | 1.00 | 0.92 | 0.83       | 1.00 | 0.92 | 0.92       | 1.00 | 0.92 |
| Lanes:                                      | 1.99        | 0.01 | 1.00 | 0.00        | 0.00 | 0.00 | 2.00       | 2.00 | 0.00 | 0.00       | 2.00 | 1.00 |
| Final Sat.:                                 | 3531        | 19   | 1750 | 0           | 0    | 0    | 3150       | 3800 | 0    | 0          | 3800 | 1750 |
| Capacity Analysis Module:                   |             |      |      |             |      |      |            |      |      |            |      |      |
| Vol/Sat:                                    | 0.11        | 0.11 | 0.21 | 0.00        | 0.00 | 0.00 | 0.04       | 0.24 | 0.00 | 0.00       | 0.22 | 0.14 |
| Crit Moves:                                 | ****        |      |      | ****        |      |      | ****       |      |      | ****       |      |      |
| Green Time:                                 | 26.9        | 26.9 | 26.9 | 0.0         | 0.0  | 0.0  | 7.0        | 34.1 | 0.0  | 0.0        | 27.1 | 27.1 |
| Volume/Cap:                                 | 0.28        | 0.28 | 0.55 | 0.00        | 0.00 | 0.00 | 0.39       | 0.49 | 0.00 | 0.00       | 0.55 | 0.35 |
| Delay/Veh:                                  | 15.0        | 15.0 | 17.9 | 0.0         | 0.0  | 0.0  | 30.3       | 12.3 | 0.0  | 0.0        | 17.2 | 15.5 |
| User DelAdj:                                | 1.00        | 1.00 | 1.00 | 1.00        | 1.00 | 1.00 | 1.00       | 1.00 | 1.00 | 1.00       | 1.00 | 1.00 |
| AdjDel/Veh:                                 | 15.0        | 15.0 | 17.9 | 0.0         | 0.0  | 0.0  | 30.3       | 12.3 | 0.0  | 0.0        | 17.2 | 15.5 |
| LOS by Move:                                | B           | B    | B    | A           | A    | A    | C          | B    | A    | A          | B    | B    |
| HCM2k95thQ:                                 | 6           | 6    | 14   | 0           | 0    | 0    | 3          | 12   | 0    | 0          | 13   | 8    |

Note: Queue reported is the number of cars per lane.

BART

Level Of Service Computation Report  
 2000 HCM Operations (Future Volume Alternative)  
 AM - Exist + Proj Conditions

Intersection #3023: 101/SANTA CLARA [Study Int 14]

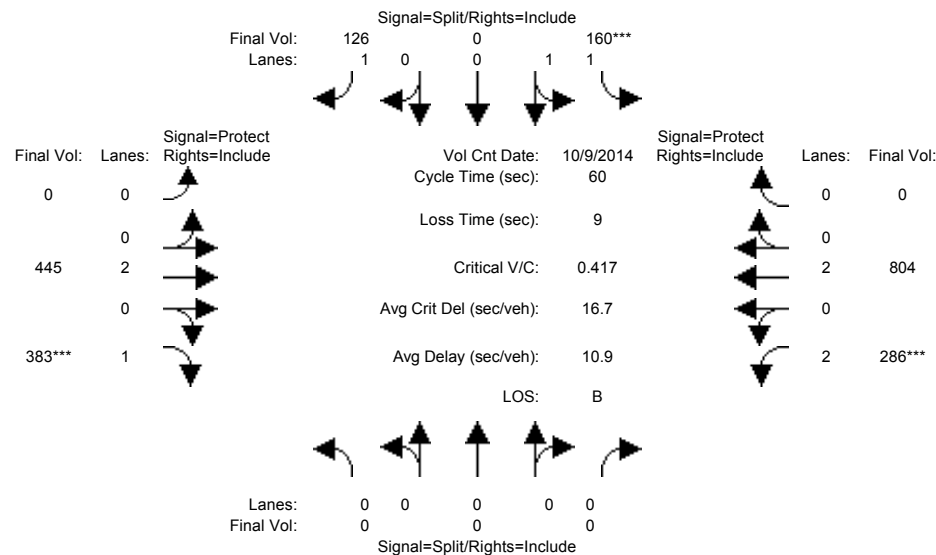

| Approach:                                   | North Bound |      |      | South Bound |      |      | East Bound |      |      | West Bound |      |      |
|---|-------------|------|------|-------------|------|------|------------|------|------|------------|------|------|
| Movement:                                   | L           | T    | R    | L           | T    | R    | L          | T    | R    | L          | T    | R    |
| Min. Green:                                 | 0           | 0    | 0    | 10          | 10   | 10   | 0          | 10   | 10   | 7          | 10   | 0    |
| Y+R:  | 4.0         | 4.0  | 4.0  | 4.0         | 4.0  | 4.0  | 4.0        | 4.0  | 4.0  | 4.0        | 4.0  | 4.0  |
| Volume Module: >> Count Date: 9 Oct 2014 << |             |      |      |             |      |      |            |      |      |            |      |      |
| Base Vol:                                   | 0           | 0    | 0    | 160         | 0    | 126  | 0          | 445  | 383  | 286        | 804  | 0    |
| Growth Adj:                                 | 1.00        | 1.00 | 1.00 | 1.00        | 1.00 | 1.00 | 1.00       | 1.00 | 1.00 | 1.00       | 1.00 | 1.00 |
| Initial Bse:                                | 0           | 0    | 0    | 160         | 0    | 126  | 0          | 445  | 383  | 286        | 804  | 0    |
| Added Vol:                                  | 0           | 0    | 0    | 0           | 0    | 0    | 0          | 0    | 0    | 0          | 0    | 0    |
| PasserByVol:                                | 0           | 0    | 0    | 0           | 0    | 0    | 0          | 0    | 0    | 0          | 0    | 0    |
| Initial Fut:                                | 0           | 0    | 0    | 160         | 0    | 126  | 0          | 445  | 383  | 286        | 804  | 0    |
| User Adj:                                   | 1.00        | 1.00 | 1.00 | 1.00        | 1.00 | 1.00 | 1.00       | 1.00 | 1.00 | 1.00       | 1.00 | 1.00 |
| PHF Adj:                                    | 1.00        | 1.00 | 1.00 | 1.00        | 1.00 | 1.00 | 1.00       | 1.00 | 1.00 | 1.00       | 1.00 | 1.00 |
| PHF Volume:                                 | 0           | 0    | 0    | 160         | 0    | 126  | 0          | 445  | 383  | 286        | 804  | 0    |
| Reduct Vol:                                 | 0           | 0    | 0    | 0           | 0    | 0    | 0          | 0    | 0    | 0          | 0    | 0    |
| Reduced Vol:                                | 0           | 0    | 0    | 160         | 0    | 126  | 0          | 445  | 383  | 286        | 804  | 0    |
| PCE Adj:                                    | 1.00        | 1.00 | 1.00 | 1.00        | 1.00 | 1.00 | 1.00       | 1.00 | 1.00 | 1.00       | 1.00 | 1.00 |
| MLF Adj:                                    | 1.00        | 1.00 | 1.00 | 1.00        | 1.00 | 1.00 | 1.00       | 1.00 | 1.00 | 1.00       | 1.00 | 1.00 |
| FinalVolume:                                | 0           | 0    | 0    | 160         | 0    | 126  | 0          | 445  | 383  | 286        | 804  | 0    |
| Saturation Flow Module:                     |             |      |      |             |      |      |            |      |      |            |      |      |
| Sat/Lane:                                   | 1900        | 1900 | 1900 | 1900        | 1900 | 1900 | 1900       | 1900 | 1900 | 1900       | 1900 | 1900 |
| Adjustment:                                 | 0.92        | 1.00 | 0.92 | 0.93        | 1.00 | 0.92 | 0.92       | 1.00 | 0.92 | 0.83       | 1.00 | 0.92 |
| Lanes:                                      | 0.00        | 0.00 | 0.00 | 2.00        | 0.00 | 1.00 | 0.00       | 2.00 | 1.00 | 2.00       | 2.00 | 0.00 |
| Final Sat.:                                 | 0           | 0    | 0    | 3550        | 0    | 1750 | 0          | 3800 | 1750 | 3150       | 3800 | 0    |
| Capacity Analysis Module:                   |             |      |      |             |      |      |            |      |      |            |      |      |
| Vol/Sat:                                    | 0.00        | 0.00 | 0.00 | 0.05        | 0.00 | 0.07 | 0.00       | 0.12 | 0.22 | 0.09       | 0.21 | 0.00 |
| Crit Moves:                                 |             |      |      | ****        |      |      | ****       |      | **** | ****       |      |      |
| Green Time:                                 | 0.0         | 0.0  | 0.0  | 10.4        | 0.0  | 10.4 | 0.0        | 28.7 | 28.7 | 11.9       | 40.6 | 0.0  |
| Volume/Cap:                                 | 0.00        | 0.00 | 0.00 | 0.26        | 0.00 | 0.42 | 0.00       | 0.24 | 0.46 | 0.46       | 0.31 | 0.00 |
| Delay/Veh:                                  | 0.0         | 0.0  | 0.0  | 21.7        | 0.0  | 23.1 | 0.0        | 9.3  | 10.8 | 21.7       | 4.0  | 0.0  |
| User DelAdj:                                | 1.00        | 1.00 | 1.00 | 1.00        | 1.00 | 1.00 | 1.00       | 1.00 | 1.00 | 1.00       | 1.00 | 1.00 |
| AdjDel/Veh:                                 | 0.0         | 0.0  | 0.0  | 21.7        | 0.0  | 23.1 | 0.0        | 9.3  | 10.8 | 21.7       | 4.0  | 0.0  |
| LOS by Move:                                | A           | A    | A    | C           | A    | C    | A          | A    | B    | C          | A    | A    |
| HCM2k95thQ:                                 | 0           | 0    | 0    | 3           | 0    | 6    | 0          | 5    | 10   | 6          | 6    | 0    |

Note: Queue reported is the number of cars per lane.

BART

Level Of Service Computation Report  
2000 HCM Operations (Future Volume Alternative)  
PM - Exist + Proj Conditions

Intersection #3023: 101/SANTA CLARA [Study Int 14]

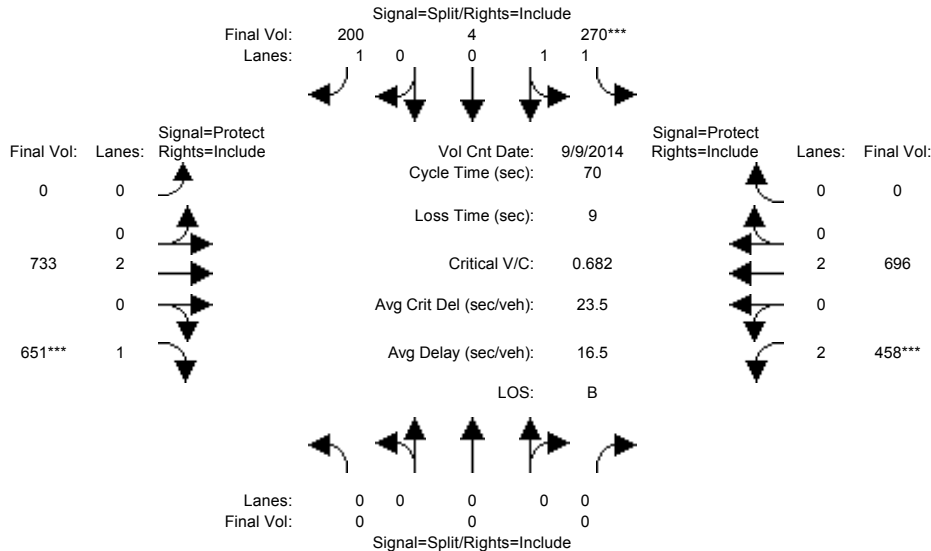

| Approach:                                   | North Bound |      |      | South Bound |      |      | East Bound |      |      | West Bound |      |      |
|---|-------------|------|------|-------------|------|------|------------|------|------|------------|------|------|
| Movement:                                   | L           | T    | R    | L           | T    | R    | L          | T    | R    | L          | T    | R    |
| Min. Green:                                 | 0           | 0    | 0    | 10          | 10   | 10   | 0          | 10   | 10   | 7          | 10   | 0    |
| Y+R:  | 4.0         | 4.0  | 4.0  | 4.0         | 4.0  | 4.0  | 4.0        | 4.0  | 4.0  | 4.0        | 4.0  | 4.0  |
| Volume Module: >> Count Date: 9 Sep 2014 << |             |      |      |             |      |      |            |      |      |            |      |      |
| Base Vol:                                   | 0           | 0    | 0    | 270         | 4    | 200  | 0          | 733  | 651  | 458        | 696  | 0    |
| Growth Adj:                                 | 1.00        | 1.00 | 1.00 | 1.00        | 1.00 | 1.00 | 1.00       | 1.00 | 1.00 | 1.00       | 1.00 | 1.00 |
| Initial Bse:                                | 0           | 0    | 0    | 270         | 4    | 200  | 0          | 733  | 651  | 458        | 696  | 0    |
| Added Vol:                                  | 0           | 0    | 0    | 0           | 0    | 0    | 0          | 0    | 0    | 0          | 0    | 0    |
| PasserByVol:                                | 0           | 0    | 0    | 0           | 0    | 0    | 0          | 0    | 0    | 0          | 0    | 0    |
| Initial Fut:                                | 0           | 0    | 0    | 270         | 4    | 200  | 0          | 733  | 651  | 458        | 696  | 0    |
| User Adj:                                   | 1.00        | 1.00 | 1.00 | 1.00        | 1.00 | 1.00 | 1.00       | 1.00 | 1.00 | 1.00       | 1.00 | 1.00 |
| PHF Adj:                                    | 1.00        | 1.00 | 1.00 | 1.00        | 1.00 | 1.00 | 1.00       | 1.00 | 1.00 | 1.00       | 1.00 | 1.00 |
| PHF Volume:                                 | 0           | 0    | 0    | 270         | 4    | 200  | 0          | 733  | 651  | 458        | 696  | 0    |
| Reduct Vol:                                 | 0           | 0    | 0    | 0           | 0    | 0    | 0          | 0    | 0    | 0          | 0    | 0    |
| Reduced Vol:                                | 0           | 0    | 0    | 270         | 4    | 200  | 0          | 733  | 651  | 458        | 696  | 0    |
| PCE Adj:                                    | 1.00        | 1.00 | 1.00 | 1.00        | 1.00 | 1.00 | 1.00       | 1.00 | 1.00 | 1.00       | 1.00 | 1.00 |
| MLF Adj:                                    | 1.00        | 1.00 | 1.00 | 1.00        | 1.00 | 1.00 | 1.00       | 1.00 | 1.00 | 1.00       | 1.00 | 1.00 |
| FinalVolume:                                | 0           | 0    | 0    | 270         | 4    | 200  | 0          | 733  | 651  | 458        | 696  | 0    |
| Saturation Flow Module:                     |             |      |      |             |      |      |            |      |      |            |      |      |
| Sat/Lane:                                   | 1900        | 1900 | 1900 | 1900        | 1900 | 1900 | 1900       | 1900 | 1900 | 1900       | 1900 | 1900 |
| Adjustment:                                 | 0.92        | 1.00 | 0.92 | 0.93        | 0.95 | 0.92 | 0.92       | 1.00 | 0.92 | 0.83       | 1.00 | 0.92 |
| Lanes:                                      | 0.00        | 0.00 | 0.00 | 1.97        | 0.03 | 1.00 | 0.00       | 2.00 | 1.00 | 2.00       | 2.00 | 0.00 |
| Final Sat.:                                 | 0           | 0    | 0    | 3498        | 52   | 1750 | 0          | 3800 | 1750 | 3150       | 3800 | 0    |
| Capacity Analysis Module:                   |             |      |      |             |      |      |            |      |      |            |      |      |
| Vol/Sat:                                    | 0.00        | 0.00 | 0.00 | 0.08        | 0.08 | 0.11 | 0.00       | 0.19 | 0.37 | 0.15       | 0.18 | 0.00 |
| Crit Moves:                                 |             |      |      | ****        |      |      | ****       |      | **** | ****       |      |      |
| Green Time:                                 | 0.0         | 0.0  | 0.0  | 11.7        | 11.7 | 11.7 | 0.0        | 35.4 | 35.4 | 13.8       | 49.3 | 0.0  |
| Volume/Cap:                                 | 0.00        | 0.00 | 0.00 | 0.46        | 0.46 | 0.68 | 0.00       | 0.38 | 0.74 | 0.74       | 0.26 | 0.00 |
| Delay/Veh:                                  | 0.0         | 0.0  | 0.0  | 26.9        | 26.9 | 33.8 | 0.0        | 10.7 | 16.8 | 30.9       | 3.8  | 0.0  |
| User DelAdj:                                | 1.00        | 1.00 | 1.00 | 1.00        | 1.00 | 1.00 | 1.00       | 1.00 | 1.00 | 1.00       | 1.00 | 1.00 |
| AdjDel/Veh:                                 | 0.0         | 0.0  | 0.0  | 26.9        | 26.9 | 33.8 | 0.0        | 10.7 | 16.8 | 30.9       | 3.8  | 0.0  |
| LOS by Move:                                | A           | A    | A    | C           | C    | C    | A          | B    | B    | C          | A    | A    |
| HCM2k95thQ:                                 | 0           | 0    | 0    | 7           | 7    | 11   | 0          | 9    | 22   | 11         | 5    | 0    |

Note: Queue reported is the number of cars per lane.

BART

Level Of Service Computation Report  
 2000 HCM Operations (Future Volume Alternative)  
 AM - Exist + Proj Conditions

Intersection #3036: 280/MCLAUGHLIN [Study Int 25]

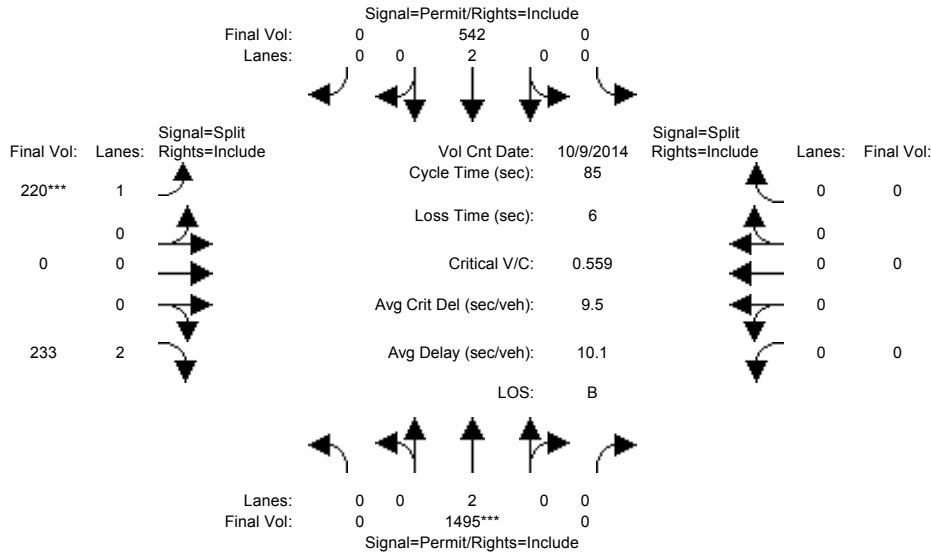

| Approach:                                   | North Bound |      |      | South Bound |      |      | East Bound |      |      | West Bound |      |      |
|---|-------------|------|------|-------------|------|------|------------|------|------|------------|------|------|
| Movement:                                   | L           | T    | R    | L           | T    | R    | L          | T    | R    | L          | T    | R    |
| Min. Green:                                 | 0           | 10   | 0    | 0           | 10   | 0    | 10         | 0    | 10   | 0          | 0    | 0    |
| Y+R:  | 4.0         | 4.0  | 4.0  | 4.0         | 4.0  | 4.0  | 4.0        | 4.0  | 4.0  | 4.0        | 4.0  | 4.0  |
| Volume Module: >> Count Date: 9 Oct 2014 << |             |      |      |             |      |      |            |      |      |            |      |      |
| Base Vol:                                   | 0           | 1495 | 0    | 0           | 542  | 0    | 220        | 0    | 233  | 0          | 0    | 0    |
| Growth Adj:                                 | 1.00        | 1.00 | 1.00 | 1.00        | 1.00 | 1.00 | 1.00       | 1.00 | 1.00 | 1.00       | 1.00 | 1.00 |
| Initial Bse:                                | 0           | 1495 | 0    | 0           | 542  | 0    | 220        | 0    | 233  | 0          | 0    | 0    |
| Added Vol:                                  | 0           | 0    | 0    | 0           | 0    | 0    | 0          | 0    | 0    | 0          | 0    | 0    |
| PasserByVol:                                | 0           | 0    | 0    | 0           | 0    | 0    | 0          | 0    | 0    | 0          | 0    | 0    |
| Initial Fut:                                | 0           | 1495 | 0    | 0           | 542  | 0    | 220        | 0    | 233  | 0          | 0    | 0    |
| User Adj:                                   | 1.00        | 1.00 | 1.00 | 1.00        | 1.00 | 1.00 | 1.00       | 1.00 | 1.00 | 1.00       | 1.00 | 1.00 |
| PHF Adj:                                    | 1.00        | 1.00 | 1.00 | 1.00        | 1.00 | 1.00 | 1.00       | 1.00 | 1.00 | 1.00       | 1.00 | 1.00 |
| PHF Volume:                                 | 0           | 1495 | 0    | 0           | 542  | 0    | 220        | 0    | 233  | 0          | 0    | 0    |
| Reduct Vol:                                 | 0           | 0    | 0    | 0           | 0    | 0    | 0          | 0    | 0    | 0          | 0    | 0    |
| Reduced Vol:                                | 0           | 1495 | 0    | 0           | 542  | 0    | 220        | 0    | 233  | 0          | 0    | 0    |
| PCE Adj:                                    | 1.00        | 1.00 | 1.00 | 1.00        | 1.00 | 1.00 | 1.00       | 1.00 | 1.00 | 1.00       | 1.00 | 1.00 |
| MLF Adj:                                    | 1.00        | 1.00 | 1.00 | 1.00        | 1.00 | 1.00 | 1.00       | 1.00 | 1.00 | 1.00       | 1.00 | 1.00 |
| FinalVolume:                                | 0           | 1495 | 0    | 0           | 542  | 0    | 220        | 0    | 233  | 0          | 0    | 0    |
| Saturation Flow Module:                     |             |      |      |             |      |      |            |      |      |            |      |      |
| Sat/Lane:                                   | 1900        | 1900 | 1900 | 1900        | 1900 | 1900 | 1900       | 1900 | 1900 | 1900       | 1900 | 1900 |
| Adjustment:                                 | 0.92        | 1.00 | 0.92 | 0.92        | 1.00 | 0.92 | 0.92       | 1.00 | 0.83 | 0.92       | 1.00 | 0.92 |
| Lanes:                                      | 0.00        | 2.00 | 0.00 | 0.00        | 2.00 | 0.00 | 1.00       | 0.00 | 2.00 | 0.00       | 0.00 | 0.00 |
| Final Sat.:                                 | 0           | 3800 | 0    | 0           | 3800 | 0    | 1750       | 0    | 3150 | 0          | 0    | 0    |
| Capacity Analysis Module:                   |             |      |      |             |      |      |            |      |      |            |      |      |
| Vol/Sat:                                    | 0.00        | 0.39 | 0.00 | 0.00        | 0.14 | 0.00 | 0.13       | 0.00 | 0.07 | 0.00       | 0.00 | 0.00 |
| Crit Moves:                                 | ****        |      |      | ****        |      |      | ****       |      |      | ****       |      |      |
| Green Time:                                 | 0.0         | 59.9 | 0.0  | 0.0         | 59.9 | 0.0  | 19.1       | 0.0  | 19.1 | 0.0        | 0.0  | 0.0  |
| Volume/Cap:                                 | 0.00        | 0.56 | 0.00 | 0.00        | 0.20 | 0.00 | 0.56       | 0.00 | 0.33 | 0.00       | 0.00 | 0.00 |
| Delay/Veh:                                  | 0.0         | 6.4  | 0.0  | 0.0         | 4.4  | 0.0  | 31.0       | 0.0  | 27.8 | 0.0        | 0.0  | 0.0  |
| User DelAdj:                                | 1.00        | 1.00 | 1.00 | 1.00        | 1.00 | 1.00 | 1.00       | 1.00 | 1.00 | 1.00       | 1.00 | 1.00 |
| AdjDel/Veh:                                 | 0.0         | 6.4  | 0.0  | 0.0         | 4.4  | 0.0  | 31.0       | 0.0  | 27.8 | 0.0        | 0.0  | 0.0  |
| LOS by Move:                                | A           | A    | A    | A           | A    | A    | C          | A    | C    | A          | A    | A    |
| HCM2k95thQ:                                 | 0           | 18   | 0    | 0           | 5    | 0    | 12         | 0    | 7    | 0          | 0    | 0    |

Note: Queue reported is the number of cars per lane.

BART

Level Of Service Computation Report  
 2000 HCM Operations (Future Volume Alternative)  
 PM - Exist + Proj Conditions

Intersection #3036: 280/MCLAUGHLIN [Study Int 25]

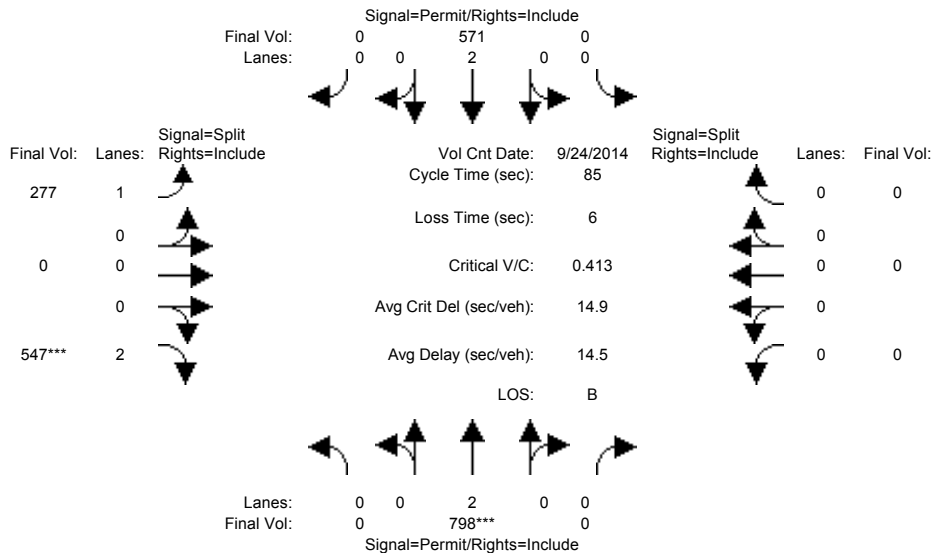

| Approach:                                    | North Bound |      |      | South Bound |      |      | East Bound |      |      | West Bound |      |      |
|--|-------------|------|------|-------------|------|------|------------|------|------|------------|------|------|
| Movement:                                    | L           | T    | R    | L           | T    | R    | L          | T    | R    | L          | T    | R    |
| Min. Green:                                  | 0           | 10   | 0    | 0           | 10   | 0    | 10         | 0    | 10   | 0          | 0    | 0    |
| Y+R:   | 4.0         | 4.0  | 4.0  | 4.0         | 4.0  | 4.0  | 4.0        | 4.0  | 4.0  | 4.0        | 4.0  | 4.0  |
| Volume Module: >> Count Date: 24 Sep 2014 << |             |      |      |             |      |      |            |      |      |            |      |      |
| Base Vol:                                    | 0           | 798  | 0    | 0           | 571  | 0    | 277        | 0    | 547  | 0          | 0    | 0    |
| Growth Adj:                                  | 1.00        | 1.00 | 1.00 | 1.00        | 1.00 | 1.00 | 1.00       | 1.00 | 1.00 | 1.00       | 1.00 | 1.00 |
| Initial Bse:                                 | 0           | 798  | 0    | 0           | 571  | 0    | 277        | 0    | 547  | 0          | 0    | 0    |
| Added Vol:                                   | 0           | 0    | 0    | 0           | 0    | 0    | 0          | 0    | 0    | 0          | 0    | 0    |
| PasserByVol:                                 | 0           | 0    | 0    | 0           | 0    | 0    | 0          | 0    | 0    | 0          | 0    | 0    |
| Initial Fut:                                 | 0           | 798  | 0    | 0           | 571  | 0    | 277        | 0    | 547  | 0          | 0    | 0    |
| User Adj:                                    | 1.00        | 1.00 | 1.00 | 1.00        | 1.00 | 1.00 | 1.00       | 1.00 | 1.00 | 1.00       | 1.00 | 1.00 |
| PHF Adj:                                     | 1.00        | 1.00 | 1.00 | 1.00        | 1.00 | 1.00 | 1.00       | 1.00 | 1.00 | 1.00       | 1.00 | 1.00 |
| PHF Volume:                                  | 0           | 798  | 0    | 0           | 571  | 0    | 277        | 0    | 547  | 0          | 0    | 0    |
| Reduct Vol:                                  | 0           | 0    | 0    | 0           | 0    | 0    | 0          | 0    | 0    | 0          | 0    | 0    |
| Reduced Vol:                                 | 0           | 798  | 0    | 0           | 571  | 0    | 277        | 0    | 547  | 0          | 0    | 0    |
| PCE Adj:                                     | 1.00        | 1.00 | 1.00 | 1.00        | 1.00 | 1.00 | 1.00       | 1.00 | 1.00 | 1.00       | 1.00 | 1.00 |
| MLF Adj:                                     | 1.00        | 1.00 | 1.00 | 1.00        | 1.00 | 1.00 | 1.00       | 1.00 | 1.00 | 1.00       | 1.00 | 1.00 |
| FinalVolume:                                 | 0           | 798  | 0    | 0           | 571  | 0    | 277        | 0    | 547  | 0          | 0    | 0    |
| Saturation Flow Module:                      |             |      |      |             |      |      |            |      |      |            |      |      |
| Sat/Lane:                                    | 1900        | 1900 | 1900 | 1900        | 1900 | 1900 | 1900       | 1900 | 1900 | 1900       | 1900 | 1900 |
| Adjustment:                                  | 0.92        | 1.00 | 0.92 | 0.92        | 1.00 | 0.92 | 0.92       | 1.00 | 0.83 | 0.92       | 1.00 | 0.92 |
| Lanes:                                       | 0.00        | 2.00 | 0.00 | 0.00        | 2.00 | 0.00 | 1.00       | 0.00 | 2.00 | 0.00       | 0.00 | 0.00 |
| Final Sat.:                                  | 0           | 3800 | 0    | 0           | 3800 | 0    | 1750       | 0    | 3150 | 0          | 0    | 0    |
| Capacity Analysis Module:                    |             |      |      |             |      |      |            |      |      |            |      |      |
| Vol/Sat:                                     | 0.00        | 0.21 | 0.00 | 0.00        | 0.15 | 0.00 | 0.16       | 0.00 | 0.17 | 0.00       | 0.00 | 0.00 |
| Crit Moves:                                  | ****        |      |      | ****        |      |      | ****       |      |      | ****       |      |      |
| Green Time:                                  | 0.0         | 43.2 | 0.0  | 0.0         | 43.2 | 0.0  | 35.8       | 0.0  | 35.8 | 0.0        | 0.0  | 0.0  |
| Volume/Cap:                                  | 0.00        | 0.41 | 0.00 | 0.00        | 0.30 | 0.00 | 0.38       | 0.00 | 0.41 | 0.00       | 0.00 | 0.00 |
| Delay/Veh:                                   | 0.0         | 13.1 | 0.0  | 0.0         | 12.2 | 0.0  | 17.3       | 0.0  | 17.5 | 0.0        | 0.0  | 0.0  |
| User DelAdj:                                 | 1.00        | 1.00 | 1.00 | 1.00        | 1.00 | 1.00 | 1.00       | 1.00 | 1.00 | 1.00       | 1.00 | 1.00 |
| AdjDel/Veh:                                  | 0.0         | 13.1 | 0.0  | 0.0         | 12.2 | 0.0  | 17.3       | 0.0  | 17.5 | 0.0        | 0.0  | 0.0  |
| LOS by Move:                                 | A           | B    | A    | A           | B    | A    | B          | A    | B    | A          | A    | A    |
| HCM2k95thQ:                                  | 0           | 12   | 0    | 0           | 9    | 0    | 11         | 0    | 12   | 0          | 0    | 0    |

Note: Queue reported is the number of cars per lane.

BART

Level Of Service Computation Report  
 2000 HCM Operations (Future Volume Alternative)  
 AM - Exist + Proj Conditions

Intersection #3042: 680N/ALUM ROCK (E) [Study Int 20]

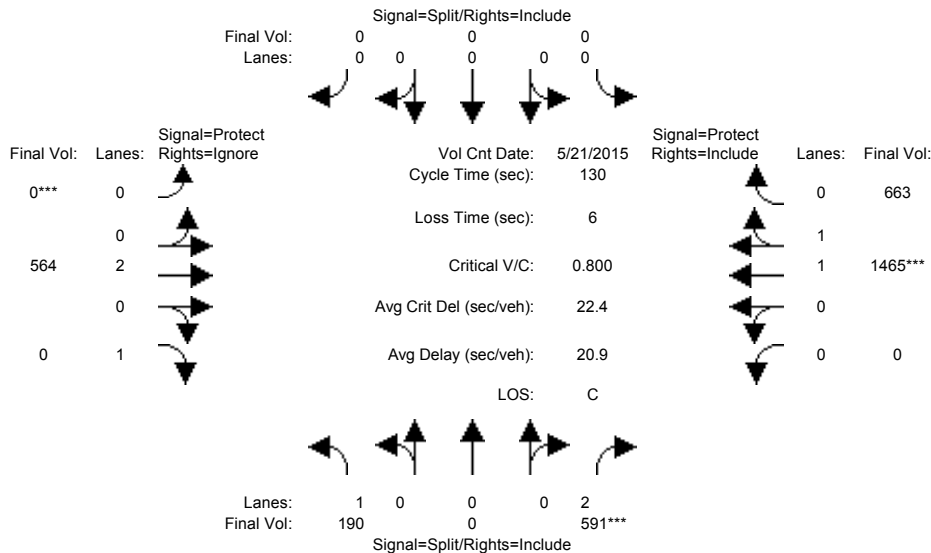

| Approach:  | North Bound |      |      | South Bound |      |      | East Bound |      |      | West Bound |      |      |
|--|-------------|------|------|-------------|------|------|------------|------|------|------------|------|------|
| Movement:  | L           | T    | R    | L           | T    | R    | L          | T    | R    | L          | T    | R    |
| Min. Green:  | 10          | 0    | 10   | 0           | 0    | 0    | 0          | 10   | 10   | 0          | 10   | 10   |
| Y+R:   | 4.0         | 4.0  | 4.0  | 4.0         | 4.0  | 4.0  | 4.0        | 4.0  | 4.0  | 4.0        | 4.0  | 4.0  |
| Volume Module: >> Count Date: 21 May 2015 << 7:30-8:30AM |             |      |      |             |      |      |            |      |      |            |      |      |
| Base Vol:  | 190         | 0    | 591  | 0           | 0    | 0    | 0          | 564  | 335  | 0          | 1465 | 663  |
| Growth Adj:  | 1.00        | 1.00 | 1.00 | 1.00        | 1.00 | 1.00 | 1.00       | 1.00 | 1.00 | 1.00       | 1.00 | 1.00 |
| Initial Bse:   | 190         | 0    | 591  | 0           | 0    | 0    | 0          | 564  | 335  | 0          | 1465 | 663  |
| Added Vol:   | 0           | 0    | 0    | 0           | 0    | 0    | 0          | 0    | 0    | 0          | 0    | 0    |
| PasserByVol:   | 0           | 0    | 0    | 0           | 0    | 0    | 0          | 0    | 0    | 0          | 0    | 0    |
| Initial Fut:   | 190         | 0    | 591  | 0           | 0    | 0    | 0          | 564  | 335  | 0          | 1465 | 663  |
| User Adj:  | 1.00        | 1.00 | 1.00 | 1.00        | 1.00 | 1.00 | 1.00       | 1.00 | 0.00 | 1.00       | 1.00 | 1.00 |
| PHF Adj:   | 1.00        | 1.00 | 1.00 | 1.00        | 1.00 | 1.00 | 1.00       | 1.00 | 0.00 | 1.00       | 1.00 | 1.00 |
| PHF Volume:  | 190         | 0    | 591  | 0           | 0    | 0    | 0          | 564  | 0    | 0          | 1465 | 663  |
| Reduct Vol:  | 0           | 0    | 0    | 0           | 0    | 0    | 0          | 0    | 0    | 0          | 0    | 0    |
| Reduced Vol:   | 190         | 0    | 591  | 0           | 0    | 0    | 0          | 564  | 0    | 0          | 1465 | 663  |
| PCE Adj:   | 1.00        | 1.00 | 1.00 | 1.00        | 1.00 | 1.00 | 1.00       | 1.00 | 0.00 | 1.00       | 1.00 | 1.00 |
| MLF Adj:   | 1.00        | 1.00 | 1.00 | 1.00        | 1.00 | 1.00 | 1.00       | 1.00 | 0.00 | 1.00       | 1.00 | 1.00 |
| Final Volume:  | 190         | 0    | 591  | 0           | 0    | 0    | 0          | 564  | 0    | 0          | 1465 | 663  |
| Saturation Flow Module:                                  |             |      |      |             |      |      |            |      |      |            |      |      |
| Sat/Lane:  | 1900        | 1900 | 1900 | 1900        | 1900 | 1900 | 1900       | 1900 | 1900 | 1900       | 1900 | 1900 |
| Adjustment:  | 0.92        | 1.00 | 0.83 | 0.92        | 1.00 | 0.92 | 0.92       | 1.00 | 0.92 | 0.92       | 0.99 | 0.95 |
| Lanes:   | 1.00        | 0.00 | 2.00 | 0.00        | 0.00 | 0.00 | 0.00       | 2.00 | 1.00 | 0.00       | 1.36 | 0.64 |
| Final Sat.:  | 1750        | 0    | 3150 | 0           | 0    | 0    | 0          | 3800 | 1750 | 0          | 2546 | 1152 |
| Capacity Analysis Module:                                |             |      |      |             |      |      |            |      |      |            |      |      |
| Vol/Sat:   | 0.11        | 0.00 | 0.19 | 0.00        | 0.00 | 0.00 | 0.00       | 0.15 | 0.00 | 0.00       | 0.58 | 0.58 |
| Crit Moves:  | ****        |      |      | ****        |      |      | ****       |      |      | ****       |      |      |
| Green Time:  | 30.5        | 0.0  | 30.5 | 0.0         | 0.0  | 0.0  | 0.0        | 93.5 | 0.0  | 0.0        | 93.5 | 93.5 |
| Volume/Cap:  | 0.46        | 0.00 | 0.80 | 0.00        | 0.00 | 0.00 | 0.00       | 0.21 | 0.00 | 0.00       | 0.80 | 0.80 |
| Delay/Veh:   | 43.5        | 0.0  | 53.1 | 0.0         | 0.0  | 0.0  | 0.0        | 6.1  | 0.0  | 0.0        | 13.9 | 13.9 |
| User DelAdj:   | 1.00        | 1.00 | 1.00 | 1.00        | 1.00 | 1.00 | 1.00       | 1.00 | 1.00 | 1.00       | 1.00 | 1.00 |
| AdjDel/Veh:  | 43.5        | 0.0  | 53.1 | 0.0         | 0.0  | 0.0  | 0.0        | 6.1  | 0.0  | 0.0        | 13.9 | 13.9 |
| LOS by Move:   | D           | A    | D    | A           | A    | A    | A          | A    | A    | A          | B    | B    |
| HCM2k95thQ:  | 14          | 0    | 27   | 0           | 0    | 0    | 0          | 7    | 0    | 0          | 48   | 48   |

Note: Queue reported is the number of cars per lane.

BART

Level Of Service Computation Report  
 2000 HCM Operations (Future Volume Alternative)  
 PM - Exist + Proj Conditions

Intersection #3042: 680N/ALUM ROCK (E) [Study Int 20]

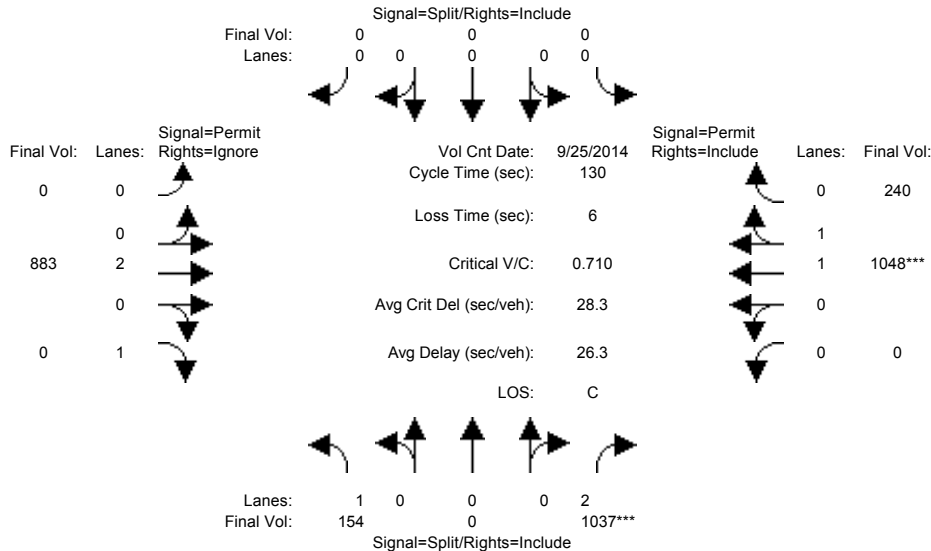

| Approach:  | North Bound |      |      | South Bound |      |      | East Bound |      |      | West Bound |      |      |
|--|-------------|------|------|-------------|------|------|------------|------|------|------------|------|------|
| Movement:  | L           | T    | R    | L           | T    | R    | L          | T    | R    | L          | T    | R    |
| Min. Green:  | 10          | 0    | 10   | 0           | 0    | 0    | 0          | 10   | 10   | 0          | 10   | 10   |
| Y+R:   | 4.0         | 4.0  | 4.0  | 4.0         | 4.0  | 4.0  | 4.0        | 4.0  | 4.0  | 4.0        | 4.0  | 4.0  |
| Volume Module: >> Count Date: 25 Sep 2014 << 4:45-5:45PM |             |      |      |             |      |      |            |      |      |            |      |      |
| Base Vol:  | 154         | 0    | 1037 | 0           | 0    | 0    | 0          | 883  | 0    | 0          | 1048 | 240  |
| Growth Adj:  | 1.00        | 1.00 | 1.00 | 1.00        | 1.00 | 1.00 | 1.00       | 1.00 | 1.00 | 1.00       | 1.00 | 1.00 |
| Initial Bse:   | 154         | 0    | 1037 | 0           | 0    | 0    | 0          | 883  | 0    | 0          | 1048 | 240  |
| Added Vol:   | 0           | 0    | 0    | 0           | 0    | 0    | 0          | 0    | 0    | 0          | 0    | 0    |
| PasserByVol:   | 0           | 0    | 0    | 0           | 0    | 0    | 0          | 0    | 0    | 0          | 0    | 0    |
| Initial Fut:   | 154         | 0    | 1037 | 0           | 0    | 0    | 0          | 883  | 0    | 0          | 1048 | 240  |
| User Adj:  | 1.00        | 1.00 | 1.00 | 1.00        | 1.00 | 1.00 | 1.00       | 1.00 | 0.00 | 1.00       | 1.00 | 1.00 |
| PHF Adj:   | 1.00        | 1.00 | 1.00 | 1.00        | 1.00 | 1.00 | 1.00       | 1.00 | 0.00 | 1.00       | 1.00 | 1.00 |
| PHF Volume:  | 154         | 0    | 1037 | 0           | 0    | 0    | 0          | 883  | 0    | 0          | 1048 | 240  |
| Reduct Vol:  | 0           | 0    | 0    | 0           | 0    | 0    | 0          | 0    | 0    | 0          | 0    | 0    |
| Reduced Vol:   | 154         | 0    | 1037 | 0           | 0    | 0    | 0          | 883  | 0    | 0          | 1048 | 240  |
| PCE Adj:   | 1.00        | 1.00 | 1.00 | 1.00        | 1.00 | 1.00 | 1.00       | 1.00 | 0.00 | 1.00       | 1.00 | 1.00 |
| MLF Adj:   | 1.00        | 1.00 | 1.00 | 1.00        | 1.00 | 1.00 | 1.00       | 1.00 | 0.00 | 1.00       | 1.00 | 1.00 |
| FinalVolume:   | 154         | 0    | 1037 | 0           | 0    | 0    | 0          | 883  | 0    | 0          | 1048 | 240  |
| Saturation Flow Module:                                  |             |      |      |             |      |      |            |      |      |            |      |      |
| Sat/Lane:  | 1900        | 1900 | 1900 | 1900        | 1900 | 1900 | 1900       | 1900 | 1900 | 1900       | 1900 | 1900 |
| Adjustment:  | 0.92        | 1.00 | 0.83 | 0.92        | 1.00 | 0.92 | 0.92       | 1.00 | 0.92 | 0.92       | 0.98 | 0.95 |
| Lanes:   | 1.00        | 0.00 | 2.00 | 0.00        | 0.00 | 0.00 | 0.00       | 2.00 | 1.00 | 0.00       | 1.62 | 0.38 |
| Final Sat.:  | 1750        | 0    | 3150 | 0           | 0    | 0    | 0          | 3800 | 1750 | 0          | 3010 | 689  |
| Capacity Analysis Module:                                |             |      |      |             |      |      |            |      |      |            |      |      |
| Vol/Sat:   | 0.09        | 0.00 | 0.33 | 0.00        | 0.00 | 0.00 | 0.00       | 0.23 | 0.00 | 0.00       | 0.35 | 0.35 |
| Crit Moves:  | ****        |      |      |             |      |      |            |      |      |            |      |      |
| Green Time:  | 60.3        | 0.0  | 60.3 | 0.0         | 0.0  | 0.0  | 0.0        | 63.7 | 0.0  | 0.0        | 63.7 | 63.7 |
| Volume/Cap:  | 0.19        | 0.00 | 0.71 | 0.00        | 0.00 | 0.00 | 0.00       | 0.47 | 0.00 | 0.00       | 0.71 | 0.71 |
| Delay/Veh:   | 20.6        | 0.0  | 29.5 | 0.0         | 0.0  | 0.0  | 0.0        | 22.2 | 0.0  | 0.0        | 27.2 | 27.2 |
| User DelAdj:   | 1.00        | 1.00 | 1.00 | 1.00        | 1.00 | 1.00 | 1.00       | 1.00 | 1.00 | 1.00       | 1.00 | 1.00 |
| AdjDel/Veh:  | 20.6        | 0.0  | 29.5 | 0.0         | 0.0  | 0.0  | 0.0        | 22.2 | 0.0  | 0.0        | 27.2 | 27.2 |
| LOS by Move:   | C           | A    | C    | A           | A    | A    | A          | C    | A    | A          | C    | C    |
| HCM2k95thQ:  | 8           | 0    | 34   | 0           | 0    | 0    | 0          | 21   | 0    | 0          | 35   | 35   |

Note: Queue reported is the number of cars per lane.

BART

Level Of Service Computation Report  
2000 HCM Operations (Future Volume Alternative)  
AM - Exist + Proj Conditions

Intersection #3043: 680S/ALUM ROCK (W) [Study Int 19]

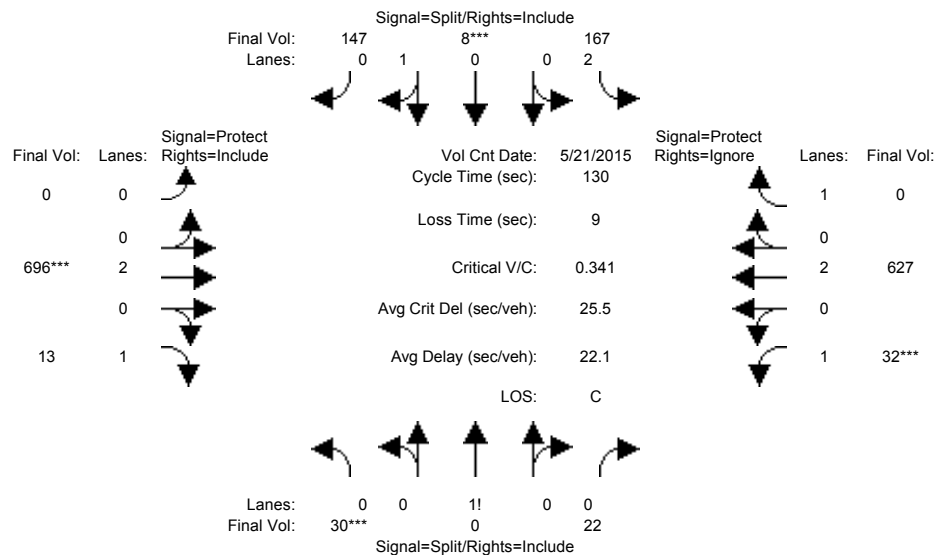

| Approach:  | North Bound |      |      | South Bound |      |      | East Bound |      |      | West Bound |      |      |
|--|-------------|------|------|-------------|------|------|------------|------|------|------------|------|------|
| Movement:  | L           | T    | R    | L           | T    | R    | L          | T    | R    | L          | T    | R    |
| Min. Green:  | 10          | 0    | 10   | 10          | 10   | 10   | 0          | 10   | 10   | 10         | 10   | 10   |
| Y+R:   | 4.0         | 4.0  | 4.0  | 4.0         | 4.0  | 4.0  | 4.0        | 4.0  | 4.0  | 4.0        | 4.0  | 4.0  |
| Volume Module: >> Count Date: 21 May 2015 << 7:30-8:30AM |             |      |      |             |      |      |            |      |      |            |      |      |
| Base Vol:  | 30          | 0    | 22   | 167         | 8    | 147  | 0          | 696  | 13   | 32         | 627  | 0    |
| Growth Adj:  | 1.00        | 1.00 | 1.00 | 1.00        | 1.00 | 1.00 | 1.00       | 1.00 | 1.00 | 1.00       | 1.00 | 1.00 |
| Initial Bse:   | 30          | 0    | 22   | 167         | 8    | 147  | 0          | 696  | 13   | 32         | 627  | 0    |
| Added Vol:   | 0           | 0    | 0    | 0           | 0    | 0    | 0          | 0    | 0    | 0          | 0    | 0    |
| PasserByVol:   | 0           | 0    | 0    | 0           | 0    | 0    | 0          | 0    | 0    | 0          | 0    | 0    |
| Initial Fut:   | 30          | 0    | 22   | 167         | 8    | 147  | 0          | 696  | 13   | 32         | 627  | 0    |
| User Adj:  | 1.00        | 1.00 | 1.00 | 1.00        | 1.00 | 1.00 | 1.00       | 1.00 | 1.00 | 1.00       | 1.00 | 0.00 |
| PHF Adj:   | 1.00        | 1.00 | 1.00 | 1.00        | 1.00 | 1.00 | 1.00       | 1.00 | 1.00 | 1.00       | 1.00 | 0.00 |
| PHF Volume:  | 30          | 0    | 22   | 167         | 8    | 147  | 0          | 696  | 13   | 32         | 627  | 0    |
| Reduct Vol:  | 0           | 0    | 0    | 0           | 0    | 0    | 0          | 0    | 0    | 0          | 0    | 0    |
| Reduced Vol:   | 30          | 0    | 22   | 167         | 8    | 147  | 0          | 696  | 13   | 32         | 627  | 0    |
| PCE Adj:   | 1.00        | 1.00 | 1.00 | 1.00        | 1.00 | 1.00 | 1.00       | 1.00 | 1.00 | 1.00       | 1.00 | 0.00 |
| MLF Adj:   | 1.00        | 1.00 | 1.00 | 1.00        | 1.00 | 1.00 | 1.00       | 1.00 | 1.00 | 1.00       | 1.00 | 0.00 |
| Final Volume:  | 30          | 0    | 22   | 167         | 8    | 147  | 0          | 696  | 13   | 32         | 627  | 0    |
| Saturation Flow Module:                                  |             |      |      |             |      |      |            |      |      |            |      |      |
| Sat/Lane:  | 1900        | 1900 | 1900 | 1900        | 1900 | 1900 | 1900       | 1900 | 1900 | 1900       | 1900 | 1900 |
| Adjustment:  | 0.92        | 0.92 | 0.92 | 0.83        | 0.95 | 0.95 | 0.92       | 1.00 | 0.92 | 0.92       | 1.00 | 0.92 |
| Lanes:   | 0.58        | 0.00 | 0.42 | 2.00        | 0.05 | 0.95 | 0.00       | 2.00 | 1.00 | 1.00       | 2.00 | 1.00 |
| Final Sat.:  | 1010        | 0    | 740  | 3150        | 93   | 1707 | 0          | 3800 | 1750 | 1750       | 3800 | 1750 |
| Capacity Analysis Module:                                |             |      |      |             |      |      |            |      |      |            |      |      |
| Vol/Sat:   | 0.03        | 0.00 | 0.03 | 0.05        | 0.09 | 0.09 | 0.00       | 0.18 | 0.01 | 0.02       | 0.17 | 0.00 |
| Crit Moves:  | ****        |      |      | ****        |      |      | ****       |      |      | ****       |      |      |
| Green Time:  | 11.0        | 0.0  | 11.0 | 32.0        | 32.0 | 32.0 | 0.0        | 68.0 | 68.0 | 10.0       | 78.0 | 0.0  |
| Volume/Cap:  | 0.35        | 0.00 | 0.35 | 0.22        | 0.35 | 0.35 | 0.00       | 0.35 | 0.01 | 0.24       | 0.28 | 0.00 |
| Delay/Veh:   | 57.5        | 0.0  | 57.5 | 39.2        | 40.9 | 40.9 | 0.0        | 18.2 | 14.9 | 57.3       | 12.5 | 0.0  |
| User DelAdj:   | 1.00        | 1.00 | 1.00 | 1.00        | 1.00 | 1.00 | 1.00       | 1.00 | 1.00 | 1.00       | 1.00 | 1.00 |
| AdjDel/Veh:  | 57.5        | 0.0  | 57.5 | 39.2        | 40.9 | 40.9 | 0.0        | 18.2 | 14.9 | 57.3       | 12.5 | 0.0  |
| LOS by Move:   | E           | A    | E    | D           | D    | D    | A          | B    | B    | E          | B    | A    |
| HCM2k95thQ:  | 5           | 0    | 5    | 6           | 11   | 11   | 0          | 15   | 1    | 3          | 11   | 0    |

Note: Queue reported is the number of cars per lane.



BART

Level Of Service Computation Report  
2000 HCM Operations (Future Volume Alternative)  
PM - Exist + Proj Conditions

Intersection #3043: 680S/ALUM ROCK (W) [Study Int 19]

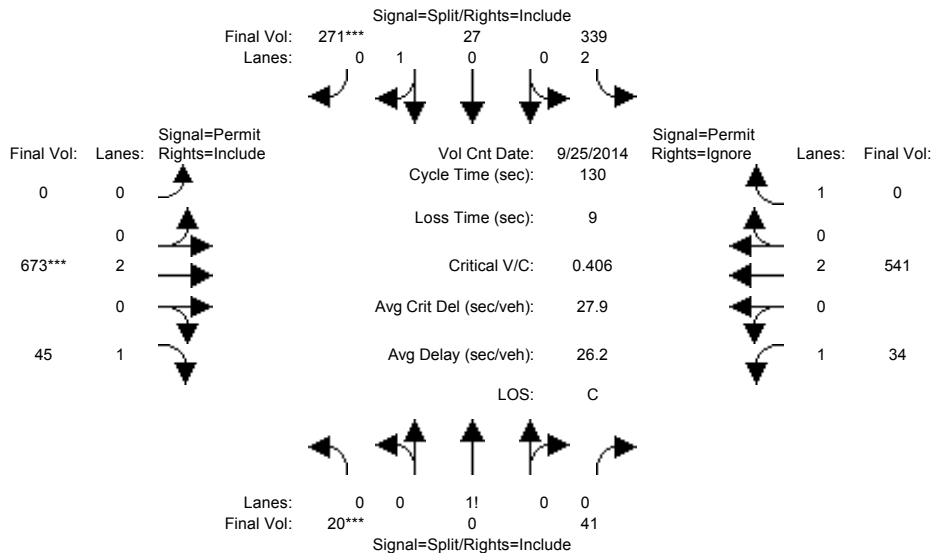

| Approach:  | North Bound |      |      | South Bound |      |      | East Bound |      |      | West Bound |      |      |
|--|-------------|------|------|-------------|------|------|------------|------|------|------------|------|------|
| Movement:  | L           | T    | R    | L           | T    | R    | L          | T    | R    | L          | T    | R    |
| Min. Green:  | 10          | 0    | 10   | 10          | 10   | 10   | 0          | 10   | 10   | 10         | 10   | 10   |
| Y+R:   | 4.0         | 4.0  | 4.0  | 4.0         | 4.0  | 4.0  | 4.0        | 4.0  | 4.0  | 4.0        | 4.0  | 4.0  |
| Volume Module: >> Count Date: 25 Sep 2014 << 4:15-5:15PM |             |      |      |             |      |      |            |      |      |            |      |      |
| Base Vol:  | 20          | 0    | 41   | 339         | 27   | 271  | 0          | 673  | 45   | 34         | 541  | 592  |
| Growth Adj:  | 1.00        | 1.00 | 1.00 | 1.00        | 1.00 | 1.00 | 1.00       | 1.00 | 1.00 | 1.00       | 1.00 | 1.00 |
| Initial Bse:   | 20          | 0    | 41   | 339         | 27   | 271  | 0          | 673  | 45   | 34         | 541  | 592  |
| Added Vol:   | 0           | 0    | 0    | 0           | 0    | 0    | 0          | 0    | 0    | 0          | 0    | 0    |
| PasserByVol:   | 0           | 0    | 0    | 0           | 0    | 0    | 0          | 0    | 0    | 0          | 0    | 0    |
| Initial Fut:   | 20          | 0    | 41   | 339         | 27   | 271  | 0          | 673  | 45   | 34         | 541  | 592  |
| User Adj:  | 1.00        | 1.00 | 1.00 | 1.00        | 1.00 | 1.00 | 1.00       | 1.00 | 1.00 | 1.00       | 1.00 | 0.00 |
| PHF Adj:   | 1.00        | 1.00 | 1.00 | 1.00        | 1.00 | 1.00 | 1.00       | 1.00 | 1.00 | 1.00       | 1.00 | 0.00 |
| PHF Volume:  | 20          | 0    | 41   | 339         | 27   | 271  | 0          | 673  | 45   | 34         | 541  | 0    |
| Reduct Vol:  | 0           | 0    | 0    | 0           | 0    | 0    | 0          | 0    | 0    | 0          | 0    | 0    |
| Reduced Vol:   | 20          | 0    | 41   | 339         | 27   | 271  | 0          | 673  | 45   | 34         | 541  | 0    |
| PCE Adj:   | 1.00        | 1.00 | 1.00 | 1.00        | 1.00 | 1.00 | 1.00       | 1.00 | 1.00 | 1.00       | 1.00 | 0.00 |
| MLF Adj:   | 1.00        | 1.00 | 1.00 | 1.00        | 1.00 | 1.00 | 1.00       | 1.00 | 1.00 | 1.00       | 1.00 | 0.00 |
| Final Volume:  | 20          | 0    | 41   | 339         | 27   | 271  | 0          | 673  | 45   | 34         | 541  | 0    |
| Saturation Flow Module:                                  |             |      |      |             |      |      |            |      |      |            |      |      |
| Sat/Lane:  | 1900        | 1900 | 1900 | 1900        | 1900 | 1900 | 1900       | 1900 | 1900 | 1900       | 1900 | 1900 |
| Adjustment:  | 0.92        | 0.92 | 0.92 | 0.83        | 0.95 | 0.95 | 0.92       | 1.00 | 0.92 | 0.92       | 1.00 | 0.92 |
| Lanes:   | 0.33        | 0.00 | 0.67 | 2.00        | 0.09 | 0.91 | 0.00       | 2.00 | 1.00 | 1.00       | 2.00 | 1.00 |
| Final Sat.:  | 574         | 0    | 1176 | 3150        | 163  | 1637 | 0          | 3800 | 1750 | 1750       | 3800 | 1750 |
| Capacity Analysis Module:                                |             |      |      |             |      |      |            |      |      |            |      |      |
| Vol/Sat:   | 0.03        | 0.00 | 0.03 | 0.11        | 0.17 | 0.17 | 0.00       | 0.18 | 0.03 | 0.02       | 0.14 | 0.00 |
| Crit Moves:  | ****        |      |      | ****        |      |      | ****       |      |      |            |      |      |
| Green Time:  | 11.2        | 0.0  | 11.2 | 53.1        | 53.1 | 53.1 | 0.0        | 56.8 | 56.8 | 56.8       | 56.8 | 0.0  |
| Volume/Cap:  | 0.41        | 0.00 | 0.41 | 0.26        | 0.41 | 0.41 | 0.00       | 0.41 | 0.06 | 0.04       | 0.33 | 0.00 |
| Delay/Veh:   | 58.1        | 0.0  | 58.1 | 25.6        | 27.7 | 27.7 | 0.0        | 25.2 | 21.2 | 21.1       | 24.2 | 0.0  |
| User DelAdj:   | 1.00        | 1.00 | 1.00 | 1.00        | 1.00 | 1.00 | 1.00       | 1.00 | 1.00 | 1.00       | 1.00 | 1.00 |
| AdjDel/Veh:  | 58.1        | 0.0  | 58.1 | 25.6        | 27.7 | 27.7 | 0.0        | 25.2 | 21.2 | 21.1       | 24.2 | 0.0  |
| LOS by Move:   | E           | A    | E    | C           | C    | C    | A          | C    | C    | C          | C    | A    |
| HCM2k95thQ:  | 6           | 0    | 6    | 10          | 16   | 16   | 0          | 16   | 2    | 2          | 13   | 0    |

Note: Queue reported is the number of cars per lane.

BART

Level Of Service Computation Report  
2000 HCM Operations (Future Volume Alternative)  
AM - Exist + Proj Conditions

Intersection #3046: The Alameda/880 SB Ramps [Study Int 56]

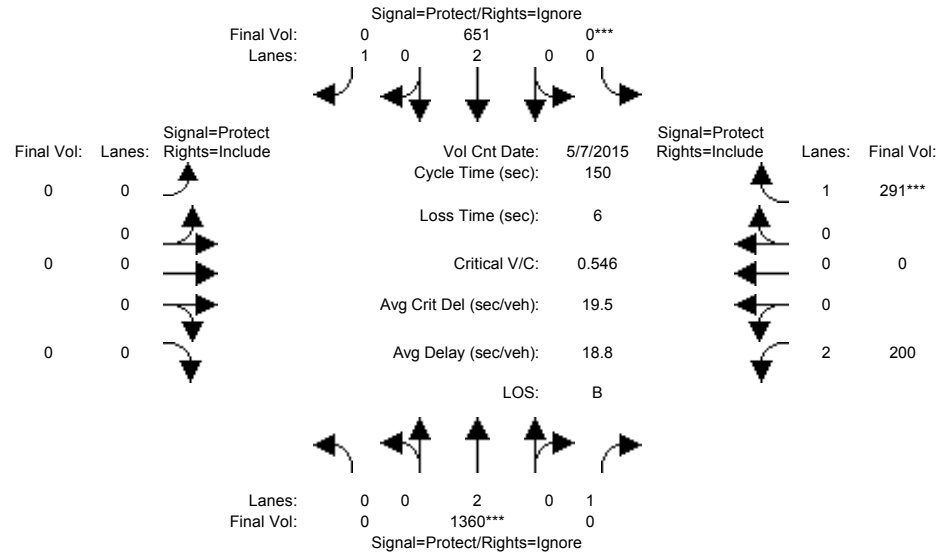

| Approach:   | North Bound |      |      | South Bound |      |      | East Bound |      |      | West Bound |      |      |
|---|-------------|------|------|-------------|------|------|------------|------|------|------------|------|------|
| Movement:   | L           | T    | R    | L           | T    | R    | L          | T    | R    | L          | T    | R    |
| Min. Green:   | 0           | 10   | 10   | 0           | 10   | 10   | 0          | 0    | 0    | 10         | 0    | 10   |
| Y+R:  | 4.0         | 4.0  | 4.0  | 4.0         | 4.0  | 4.0  | 4.0        | 4.0  | 4.0  | 4.0        | 4.0  | 4.0  |
| Volume Module: >> Count Date: 7 May 2015 << 7:35-8:35AM |             |      |      |             |      |      |            |      |      |            |      |      |
| Base Vol:   | 0           | 1360 | 308  | 0           | 651  | 176  | 0          | 0    | 0    | 200        | 0    | 291  |
| Growth Adj:   | 1.00        | 1.00 | 1.00 | 1.00        | 1.00 | 1.00 | 1.00       | 1.00 | 1.00 | 1.00       | 1.00 | 1.00 |
| Initial Bse:  | 0           | 1360 | 308  | 0           | 651  | 176  | 0          | 0    | 0    | 200        | 0    | 291  |
| Added Vol:  | 0           | 0    | 0    | 0           | 0    | 0    | 0          | 0    | 0    | 0          | 0    | 0    |
| PasserByVol:  | 0           | 0    | 0    | 0           | 0    | 0    | 0          | 0    | 0    | 0          | 0    | 0    |
| Initial Fut:  | 0           | 1360 | 308  | 0           | 651  | 176  | 0          | 0    | 0    | 200        | 0    | 291  |
| User Adj:   | 1.00        | 1.00 | 0.00 | 1.00        | 1.00 | 0.00 | 1.00       | 1.00 | 1.00 | 1.00       | 1.00 | 1.00 |
| PHF Adj:  | 1.00        | 1.00 | 0.00 | 1.00        | 1.00 | 0.00 | 1.00       | 1.00 | 1.00 | 1.00       | 1.00 | 1.00 |
| PHF Volume:   | 0           | 1360 | 0    | 0           | 651  | 0    | 0          | 0    | 0    | 200        | 0    | 291  |
| Reduct Vol:   | 0           | 0    | 0    | 0           | 0    | 0    | 0          | 0    | 0    | 0          | 0    | 0    |
| Reduced Vol:  | 0           | 1360 | 0    | 0           | 651  | 0    | 0          | 0    | 0    | 200        | 0    | 291  |
| PCE Adj:  | 1.00        | 1.00 | 0.00 | 1.00        | 1.00 | 0.00 | 1.00       | 1.00 | 1.00 | 1.00       | 1.00 | 1.00 |
| MLF Adj:  | 1.00        | 1.00 | 0.00 | 1.00        | 1.00 | 0.00 | 1.00       | 1.00 | 1.00 | 1.00       | 1.00 | 1.00 |
| Final Volume:   | 0           | 1360 | 0    | 0           | 651  | 0    | 0          | 0    | 0    | 200        | 0    | 291  |
| Saturation Flow Module:                                 |             |      |      |             |      |      |            |      |      |            |      |      |
| Sat/Lane:   | 1900        | 1900 | 1900 | 1900        | 1900 | 1900 | 1900       | 1900 | 1900 | 1900       | 1900 | 1900 |
| Adjustment:   | 0.92        | 1.00 | 0.92 | 0.92        | 1.00 | 0.92 | 0.92       | 1.00 | 0.92 | 0.83       | 1.00 | 0.92 |
| Lanes:  | 0.00        | 2.00 | 1.00 | 0.00        | 2.00 | 1.00 | 0.00       | 0.00 | 0.00 | 2.00       | 0.00 | 1.00 |
| Final Sat.:   | 0           | 3800 | 1750 | 0           | 3800 | 1750 | 0          | 0    | 0    | 3150       | 0    | 1750 |
| Capacity Analysis Module:                               |             |      |      |             |      |      |            |      |      |            |      |      |
| Vol/Sat:  | 0.00        | 0.36 | 0.00 | 0.00        | 0.17 | 0.00 | 0.00       | 0.00 | 0.00 | 0.06       | 0.00 | 0.17 |
| Crit Moves:   | ****        | **** | **** | ****        | **** | **** | ****       | **** | **** | ****       | **** | **** |
| Green Time:   | 0.0         | 98.3 | 0.0  | 0.0         | 98.3 | 0.0  | 0.0        | 0.0  | 0.0  | 45.7       | 0.0  | 45.7 |
| Volume/Cap:   | 0.00        | 0.55 | 0.00 | 0.00        | 0.26 | 0.00 | 0.00       | 0.00 | 0.00 | 0.21       | 0.00 | 0.55 |
| Delay/Veh:  | 0.0         | 14.1 | 0.0  | 0.0         | 10.8 | 0.0  | 0.0        | 0.0  | 0.0  | 38.8       | 0.0  | 44.7 |
| User DelAdj:  | 1.00        | 1.00 | 1.00 | 1.00        | 1.00 | 1.00 | 1.00       | 1.00 | 1.00 | 1.00       | 1.00 | 1.00 |
| AdjDel/Veh:   | 0.0         | 14.1 | 0.0  | 0.0         | 10.8 | 0.0  | 0.0        | 0.0  | 0.0  | 38.8       | 0.0  | 44.7 |
| LOS by Move:  | A           | B    | A    | A           | B    | A    | A          | A    | A    | D          | A    | D    |
| HCM2k95thQ:   | 0           | 29   | 0    | 0           | 12   | 0    | 0          | 0    | 0    | 8          | 0    | 22   |

Note: Queue reported is the number of cars per lane.

BART

Level Of Service Computation Report  
 2000 HCM Operations (Future Volume Alternative)  
 PM - Exist + Proj Conditions

Intersection #3046: The Alameda/880 SB Ramps [Study Int 56]

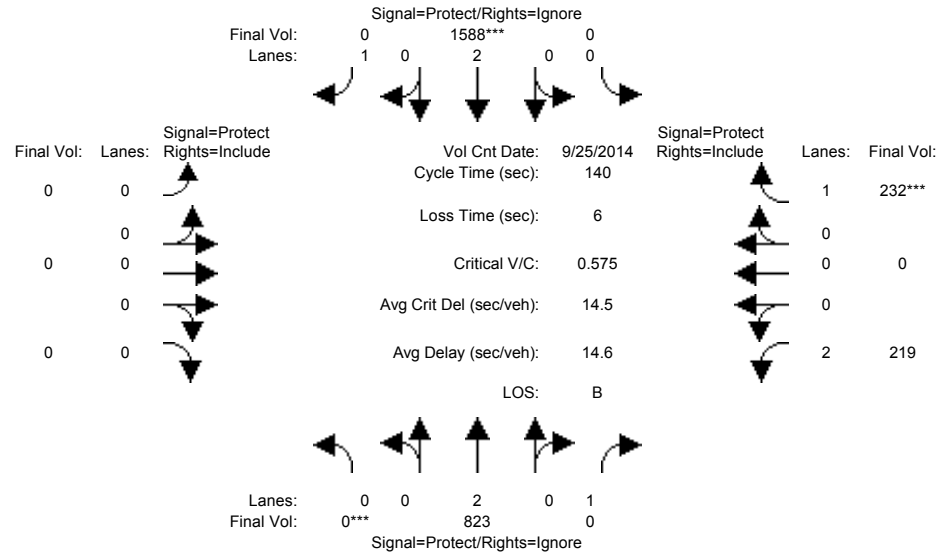

| Approach:  | North Bound |      |      | South Bound |      |      | East Bound |      |      | West Bound |      |      |
|--|-------------|------|------|-------------|------|------|------------|------|------|------------|------|------|
| Movement:  | L           | T    | R    | L           | T    | R    | L          | T    | R    | L          | T    | R    |
| Min. Green:  | 0           | 10   | 10   | 0           | 10   | 10   | 0          | 0    | 0    | 10         | 0    | 10   |
| Y+R:   | 4.0         | 4.0  | 4.0  | 4.0         | 4.0  | 4.0  | 4.0        | 4.0  | 4.0  | 4.0        | 4.0  | 4.0  |
| Volume Module: >> Count Date: 25 Sep 2014 << 4:45-5:00PM |             |      |      |             |      |      |            |      |      |            |      |      |
| Base Vol:  | 0           | 823  | 389  | 0           | 1588 | 322  | 0          | 0    | 0    | 219        | 0    | 232  |
| Growth Adj:  | 1.00        | 1.00 | 1.00 | 1.00        | 1.00 | 1.00 | 1.00       | 1.00 | 1.00 | 1.00       | 1.00 | 1.00 |
| Initial Bse:   | 0           | 823  | 389  | 0           | 1588 | 322  | 0          | 0    | 0    | 219        | 0    | 232  |
| Added Vol:   | 0           | 0    | 0    | 0           | 0    | 0    | 0          | 0    | 0    | 0          | 0    | 0    |
| PasserByVol:   | 0           | 0    | 0    | 0           | 0    | 0    | 0          | 0    | 0    | 0          | 0    | 0    |
| Initial Fut:   | 0           | 823  | 389  | 0           | 1588 | 322  | 0          | 0    | 0    | 219        | 0    | 232  |
| User Adj:  | 1.00        | 1.00 | 0.00 | 1.00        | 1.00 | 0.00 | 1.00       | 1.00 | 1.00 | 1.00       | 1.00 | 1.00 |
| PHF Adj:   | 1.00        | 1.00 | 0.00 | 1.00        | 1.00 | 0.00 | 1.00       | 1.00 | 1.00 | 1.00       | 1.00 | 1.00 |
| PHF Volume:  | 0           | 823  | 0    | 0           | 1588 | 0    | 0          | 0    | 0    | 219        | 0    | 232  |
| Reduct Vol:  | 0           | 0    | 0    | 0           | 0    | 0    | 0          | 0    | 0    | 0          | 0    | 0    |
| Reduced Vol:   | 0           | 823  | 0    | 0           | 1588 | 0    | 0          | 0    | 0    | 219        | 0    | 232  |
| PCE Adj:   | 1.00        | 1.00 | 0.00 | 1.00        | 1.00 | 0.00 | 1.00       | 1.00 | 1.00 | 1.00       | 1.00 | 1.00 |
| MLF Adj:   | 1.00        | 1.00 | 0.00 | 1.00        | 1.00 | 0.00 | 1.00       | 1.00 | 1.00 | 1.00       | 1.00 | 1.00 |
| Final Volume:  | 0           | 823  | 0    | 0           | 1588 | 0    | 0          | 0    | 0    | 219        | 0    | 232  |
| Saturation Flow Module:                                  |             |      |      |             |      |      |            |      |      |            |      |      |
| Sat/Lane:  | 1900        | 1900 | 1900 | 1900        | 1900 | 1900 | 1900       | 1900 | 1900 | 1900       | 1900 | 1900 |
| Adjustment:  | 0.92        | 1.00 | 0.92 | 0.92        | 1.00 | 0.92 | 0.92       | 1.00 | 0.92 | 0.83       | 1.00 | 0.92 |
| Lanes:   | 0.00        | 2.00 | 1.00 | 0.00        | 2.00 | 1.00 | 0.00       | 0.00 | 0.00 | 2.00       | 0.00 | 1.00 |
| Final Sat.:  | 0           | 3800 | 1750 | 0           | 3800 | 1750 | 0          | 0    | 0    | 3150       | 0    | 1750 |
| Capacity Analysis Module:                                |             |      |      |             |      |      |            |      |      |            |      |      |
| Vol/Sat:   | 0.00        | 0.22 | 0.00 | 0.00        | 0.42 | 0.00 | 0.00       | 0.00 | 0.00 | 0.07       | 0.00 | 0.13 |
| Crit Moves:  | ****        |      |      | ****        |      |      | ****       |      |      | ****       |      |      |
| Green Time:  | 0.0         | 102  | 0.0  | 0.0         | 102  | 0.0  | 0.0        | 0.0  | 0.0  | 32.3       | 0.0  | 32.3 |
| Volume/Cap:  | 0.00        | 0.30 | 0.00 | 0.00        | 0.58 | 0.00 | 0.00       | 0.00 | 0.00 | 0.30       | 0.00 | 0.58 |
| Delay/Veh:   | 0.0         | 6.7  | 0.0  | 0.0         | 9.3  | 0.0  | 0.0        | 0.0  | 0.0  | 44.8       | 0.0  | 49.8 |
| User DelAdj:   | 1.00        | 1.00 | 1.00 | 1.00        | 1.00 | 1.00 | 1.00       | 1.00 | 1.00 | 1.00       | 1.00 | 1.00 |
| AdjDel/Veh:  | 0.0         | 6.7  | 0.0  | 0.0         | 9.3  | 0.0  | 0.0        | 0.0  | 0.0  | 44.8       | 0.0  | 49.8 |
| LOS by Move:   | A           | A    | A    | A           | A    | A    | A          | A    | A    | D          | A    | D    |
| HCM2k95thQ:  | 0           | 12   | 0    | 0           | 27   | 0    | 0          | 0    | 0    | 9          | 0    | 18   |

Note: Queue reported is the number of cars per lane.

BART

Level Of Service Computation Report  
 2000 HCM Operations (Future Volume Alternative)  
 AM - Exist + Proj Conditions

Intersection #3047: The Alameda/880 NB Ramps [Study Int 57]

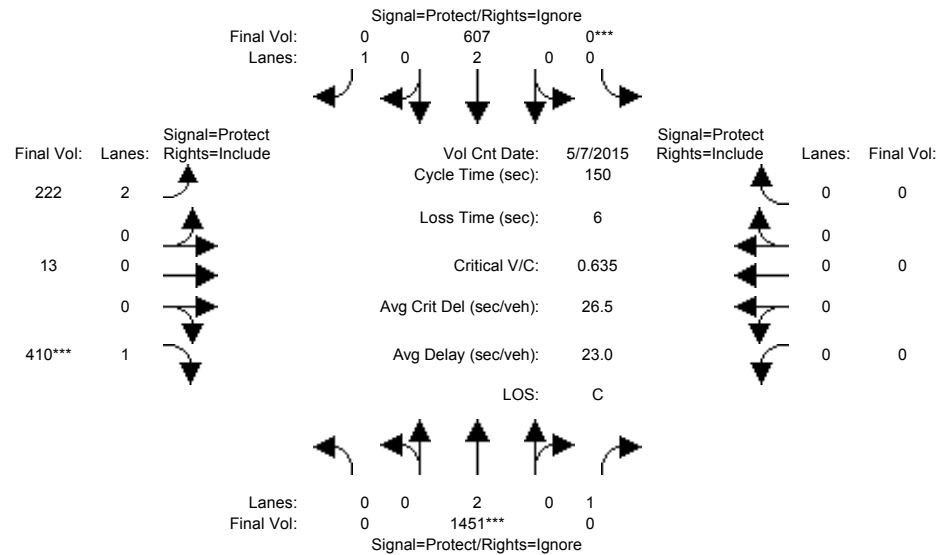

| Approach:   | North Bound |      |      | South Bound |      |      | East Bound |      |      | West Bound |      |      |
|---|-------------|------|------|-------------|------|------|------------|------|------|------------|------|------|
| Movement:   | L           | T    | R    | L           | T    | R    | L          | T    | R    | L          | T    | R    |
| Min. Green:   | 0           | 10   | 10   | 0           | 10   | 10   | 10         | 0    | 10   | 0          | 0    | 0    |
| Y+R:  | 4.0         | 4.0  | 4.0  | 4.0         | 4.0  | 4.0  | 4.0        | 4.0  | 4.0  | 4.0        | 4.0  | 4.0  |
| Volume Module: >> Count Date: 7 May 2015 << 7:50-8:50AM |             |      |      |             |      |      |            |      |      |            |      |      |
| Base Vol:   | 0           | 1451 | 469  | 0           | 607  | 250  | 222        | 13   | 410  | 0          | 0    | 0    |
| Growth Adj:   | 1.00        | 1.00 | 1.00 | 1.00        | 1.00 | 1.00 | 1.00       | 1.00 | 1.00 | 1.00       | 1.00 | 1.00 |
| Initial Bse:  | 0           | 1451 | 469  | 0           | 607  | 250  | 222        | 13   | 410  | 0          | 0    | 0    |
| Added Vol:  | 0           | 0    | 0    | 0           | 0    | 0    | 0          | 0    | 0    | 0          | 0    | 0    |
| PasserByVol:  | 0           | 0    | 0    | 0           | 0    | 0    | 0          | 0    | 0    | 0          | 0    | 0    |
| Initial Fut:  | 0           | 1451 | 469  | 0           | 607  | 250  | 222        | 13   | 410  | 0          | 0    | 0    |
| User Adj:   | 1.00        | 1.00 | 0.00 | 1.00        | 1.00 | 0.00 | 1.00       | 1.00 | 1.00 | 1.00       | 1.00 | 1.00 |
| PHF Adj:  | 1.00        | 1.00 | 0.00 | 1.00        | 1.00 | 0.00 | 1.00       | 1.00 | 1.00 | 1.00       | 1.00 | 1.00 |
| PHF Volume:   | 0           | 1451 | 0    | 0           | 607  | 0    | 222        | 13   | 410  | 0          | 0    | 0    |
| Reduct Vol:   | 0           | 0    | 0    | 0           | 0    | 0    | 0          | 0    | 0    | 0          | 0    | 0    |
| Reduced Vol:  | 0           | 1451 | 0    | 0           | 607  | 0    | 222        | 13   | 410  | 0          | 0    | 0    |
| PCE Adj:  | 1.00        | 1.00 | 0.00 | 1.00        | 1.00 | 0.00 | 1.00       | 1.00 | 1.00 | 1.00       | 1.00 | 1.00 |
| MLF Adj:  | 1.00        | 1.00 | 0.00 | 1.00        | 1.00 | 0.00 | 1.00       | 1.00 | 1.00 | 1.00       | 1.00 | 1.00 |
| Final Volume:   | 0           | 1451 | 0    | 0           | 607  | 0    | 222        | 13   | 410  | 0          | 0    | 0    |
| Saturation Flow Module:                                 |             |      |      |             |      |      |            |      |      |            |      |      |
| Sat/Lane:   | 1900        | 1900 | 1900 | 1900        | 1900 | 1900 | 1900       | 1900 | 1900 | 1900       | 1900 | 1900 |
| Adjustment:   | 0.92        | 1.00 | 0.92 | 0.92        | 1.00 | 0.92 | 0.92       | 0.95 | 0.95 | 0.92       | 1.00 | 0.92 |
| Lanes:  | 0.00        | 2.00 | 1.00 | 0.00        | 2.00 | 1.00 | 1.89       | 0.11 | 1.00 | 0.00       | 0.00 | 0.00 |
| Final Sat.:   | 0           | 3800 | 1750 | 0           | 3800 | 1750 | 3314       | 194  | 1800 | 0          | 0    | 0    |
| Capacity Analysis Module:                               |             |      |      |             |      |      |            |      |      |            |      |      |
| Vol/Sat:  | 0.00        | 0.38 | 0.00 | 0.00        | 0.16 | 0.00 | 0.07       | 0.07 | 0.23 | 0.00       | 0.00 | 0.00 |
| Crit Moves:   | ****        | **** | **** | ****        | **** | **** | ****       | **** | **** | ****       | **** | **** |
| Green Time:   | 0.0         | 90.2 | 0.0  | 0.0         | 90.2 | 0.0  | 53.8       | 53.8 | 53.8 | 0.0        | 0.0  | 0.0  |
| Volume/Cap:   | 0.00        | 0.64 | 0.00 | 0.00        | 0.27 | 0.00 | 0.19       | 0.19 | 0.64 | 0.00       | 0.00 | 0.00 |
| Delay/Veh:  | 0.0         | 19.9 | 0.0  | 0.0         | 14.3 | 0.0  | 33.1       | 33.1 | 41.3 | 0.0        | 0.0  | 0.0  |
| User DelAdj:  | 1.00        | 1.00 | 1.00 | 1.00        | 1.00 | 1.00 | 1.00       | 1.00 | 1.00 | 1.00       | 1.00 | 1.00 |
| AdjDel/Veh:   | 0.0         | 19.9 | 0.0  | 0.0         | 14.3 | 0.0  | 33.1       | 33.1 | 41.3 | 0.0        | 0.0  | 0.0  |
| LOS by Move:  | A           | B    | A    | A           | B    | A    | C          | C    | D    | A          | A    | A    |
| HCM2k95thQ:   | 0           | 35   | 0    | 0           | 12   | 0    | 8          | 8    | 29   | 0          | 0    | 0    |

Note: Queue reported is the number of cars per lane.

BART

Level Of Service Computation Report  
 2000 HCM Operations (Future Volume Alternative)  
 PM - Exist + Proj Conditions

Intersection #3047: The Alameda/880 NB Ramps [Study Int 57]

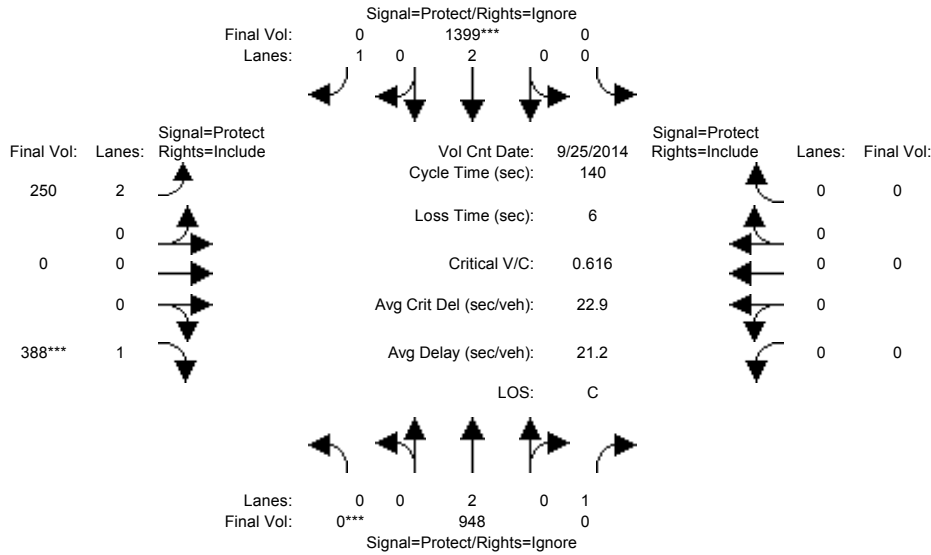

| Approach:  | North Bound |      |      | South Bound |      |      | East Bound |      |      | West Bound |      |      |
|--|-------------|------|------|-------------|------|------|------------|------|------|------------|------|------|
| Movement:  | L           | T    | R    | L           | T    | R    | L          | T    | R    | L          | T    | R    |
| Min. Green:  | 0           | 10   | 10   | 0           | 10   | 10   | 10         | 0    | 10   | 0          | 0    | 0    |
| Y+R:   | 4.0         | 4.0  | 4.0  | 4.0         | 4.0  | 4.0  | 4.0        | 4.0  | 4.0  | 4.0        | 4.0  | 4.0  |
| Volume Module: >> Count Date: 25 Sep 2014 << 4:45-5:45PM |             |      |      |             |      |      |            |      |      |            |      |      |
| Base Vol:  | 0           | 948  | 224  | 0           | 1399 | 424  | 250        | 0    | 388  | 0          | 0    | 0    |
| Growth Adj:  | 1.00        | 1.00 | 1.00 | 1.00        | 1.00 | 1.00 | 1.00       | 1.00 | 1.00 | 1.00       | 1.00 | 1.00 |
| Initial Bse:   | 0           | 948  | 224  | 0           | 1399 | 424  | 250        | 0    | 388  | 0          | 0    | 0    |
| Added Vol:   | 0           | 0    | 0    | 0           | 0    | 0    | 0          | 0    | 0    | 0          | 0    | 0    |
| PasserByVol:   | 0           | 0    | 0    | 0           | 0    | 0    | 0          | 0    | 0    | 0          | 0    | 0    |
| Initial Fut:   | 0           | 948  | 224  | 0           | 1399 | 424  | 250        | 0    | 388  | 0          | 0    | 0    |
| User Adj:  | 1.00        | 1.00 | 0.00 | 1.00        | 1.00 | 0.00 | 1.00       | 1.00 | 1.00 | 1.00       | 1.00 | 1.00 |
| PHF Adj:   | 1.00        | 1.00 | 0.00 | 1.00        | 1.00 | 0.00 | 1.00       | 1.00 | 1.00 | 1.00       | 1.00 | 1.00 |
| PHF Volume:  | 0           | 948  | 0    | 0           | 1399 | 0    | 250        | 0    | 388  | 0          | 0    | 0    |
| Reduct Vol:  | 0           | 0    | 0    | 0           | 0    | 0    | 0          | 0    | 0    | 0          | 0    | 0    |
| Reduced Vol:   | 0           | 948  | 0    | 0           | 1399 | 0    | 250        | 0    | 388  | 0          | 0    | 0    |
| PCE Adj:   | 1.00        | 1.00 | 0.00 | 1.00        | 1.00 | 0.00 | 1.00       | 1.00 | 1.00 | 1.00       | 1.00 | 1.00 |
| MLF Adj:   | 1.00        | 1.00 | 0.00 | 1.00        | 1.00 | 0.00 | 1.00       | 1.00 | 1.00 | 1.00       | 1.00 | 1.00 |
| Final Volume:  | 0           | 948  | 0    | 0           | 1399 | 0    | 250        | 0    | 388  | 0          | 0    | 0    |
| Saturation Flow Module:                                  |             |      |      |             |      |      |            |      |      |            |      |      |
| Sat/Lane:  | 1900        | 1900 | 1900 | 1900        | 1900 | 1900 | 1900       | 1900 | 1900 | 1900       | 1900 | 1900 |
| Adjustment:  | 0.92        | 1.00 | 0.92 | 0.92        | 1.00 | 0.92 | 0.83       | 1.00 | 0.92 | 0.92       | 1.00 | 0.92 |
| Lanes:   | 0.00        | 2.00 | 1.00 | 0.00        | 2.00 | 1.00 | 2.00       | 0.00 | 1.00 | 0.00       | 0.00 | 0.00 |
| Final Sat.:  | 0           | 3800 | 1750 | 0           | 3800 | 1750 | 3150       | 0    | 1750 | 0          | 0    | 0    |
| Capacity Analysis Module:                                |             |      |      |             |      |      |            |      |      |            |      |      |
| Vol/Sat:   | 0.00        | 0.25 | 0.00 | 0.00        | 0.37 | 0.00 | 0.08       | 0.00 | 0.22 | 0.00       | 0.00 | 0.00 |
| Crit Moves:  | ****        |      |      | ****        |      |      | ****       |      |      | ****       |      |      |
| Green Time:  | 0.0         | 83.6 | 0.0  | 0.0         | 83.6 | 0.0  | 50.4       | 0.0  | 50.4 | 0.0        | 0.0  | 0.0  |
| Volume/Cap:  | 0.00        | 0.42 | 0.00 | 0.00        | 0.62 | 0.00 | 0.22       | 0.00 | 0.62 | 0.00       | 0.00 | 0.00 |
| Delay/Veh:   | 0.0         | 15.2 | 0.0  | 0.0         | 18.5 | 0.0  | 31.3       | 0.0  | 38.7 | 0.0        | 0.0  | 0.0  |
| User DelAdj:   | 1.00        | 1.00 | 1.00 | 1.00        | 1.00 | 1.00 | 1.00       | 1.00 | 1.00 | 1.00       | 1.00 | 1.00 |
| AdjDel/Veh:  | 0.0         | 15.2 | 0.0  | 0.0         | 18.5 | 0.0  | 31.3       | 0.0  | 38.7 | 0.0        | 0.0  | 0.0  |
| LOS by Move:   | A           | B    | A    | A           | B    | A    | C          | A    | D    | A          | A    | A    |
| HCM2k95thQ:  | 0           | 19   | 0    | 0           | 32   | 0    | 9          | 0    | 26   | 0          | 0    | 0    |

Note: Queue reported is the number of cars per lane.

BART

Level Of Service Computation Report  
 2000 HCM Operations (Future Volume Alternative)  
 AM - Exist + Proj Conditions

Intersection #3052: 880 SB Ramps/Coleman [Study Int 36]

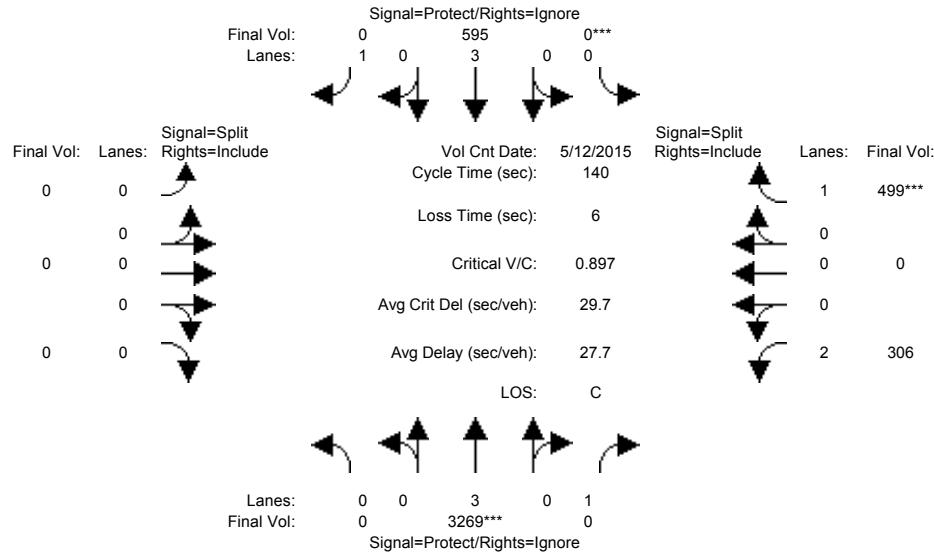

| Approach:  | North Bound |      |      | South Bound |      |      | East Bound |      |      | West Bound |      |      |
|--|-------------|------|------|-------------|------|------|------------|------|------|------------|------|------|
| Movement:  | L           | T    | R    | L           | T    | R    | L          | T    | R    | L          | T    | R    |
| Min. Green:  | 0           | 10   | 10   | 0           | 10   | 10   | 0          | 0    | 0    | 10         | 0    | 10   |
| Y+R:   | 4.0         | 4.0  | 4.0  | 4.0         | 4.0  | 4.0  | 4.0        | 4.0  | 4.0  | 4.0        | 4.0  | 4.0  |
| Volume Module: >> Count Date: 12 May 2015 << 7:45-8:45AM |             |      |      |             |      |      |            |      |      |            |      |      |
| Base Vol:  | 0           | 3269 | 178  | 0           | 595  | 183  | 0          | 0    | 0    | 306        | 0    | 499  |
| Growth Adj:  | 1.00        | 1.00 | 1.00 | 1.00        | 1.00 | 1.00 | 1.00       | 1.00 | 1.00 | 1.00       | 1.00 | 1.00 |
| Initial Bse:   | 0           | 3269 | 178  | 0           | 595  | 183  | 0          | 0    | 0    | 306        | 0    | 499  |
| Added Vol:   | 0           | 0    | 0    | 0           | 0    | 0    | 0          | 0    | 0    | 0          | 0    | 0    |
| PasserByVol:   | 0           | 0    | 0    | 0           | 0    | 0    | 0          | 0    | 0    | 0          | 0    | 0    |
| Initial Fut:   | 0           | 3269 | 178  | 0           | 595  | 183  | 0          | 0    | 0    | 306        | 0    | 499  |
| User Adj:  | 1.00        | 1.00 | 0.00 | 1.00        | 1.00 | 0.00 | 1.00       | 1.00 | 1.00 | 1.00       | 1.00 | 1.00 |
| PHF Adj:   | 1.00        | 1.00 | 0.00 | 1.00        | 1.00 | 0.00 | 1.00       | 1.00 | 1.00 | 1.00       | 1.00 | 1.00 |
| PHF Volume:  | 0           | 3269 | 0    | 0           | 595  | 0    | 0          | 0    | 0    | 306        | 0    | 499  |
| Reduct Vol:  | 0           | 0    | 0    | 0           | 0    | 0    | 0          | 0    | 0    | 0          | 0    | 0    |
| Reduced Vol:   | 0           | 3269 | 0    | 0           | 595  | 0    | 0          | 0    | 0    | 306        | 0    | 499  |
| PCE Adj:   | 1.00        | 1.00 | 0.00 | 1.00        | 1.00 | 0.00 | 1.00       | 1.00 | 1.00 | 1.00       | 1.00 | 1.00 |
| MLF Adj:   | 1.00        | 1.00 | 0.00 | 1.00        | 1.00 | 0.00 | 1.00       | 1.00 | 1.00 | 1.00       | 1.00 | 1.00 |
| Final Volume:  | 0           | 3269 | 0    | 0           | 595  | 0    | 0          | 0    | 0    | 306        | 0    | 499  |
| Saturation Flow Module:                                  |             |      |      |             |      |      |            |      |      |            |      |      |
| Sat/Lane:  | 1900        | 1900 | 1900 | 1900        | 1900 | 1900 | 1900       | 1900 | 1900 | 1900       | 1900 | 1900 |
| Adjustment:  | 0.92        | 1.00 | 0.92 | 0.92        | 1.00 | 0.92 | 0.92       | 1.00 | 0.92 | 0.83       | 1.00 | 0.92 |
| Lanes:   | 0.00        | 3.00 | 1.00 | 0.00        | 3.00 | 1.00 | 0.00       | 0.00 | 0.00 | 2.00       | 0.00 | 1.00 |
| Final Sat.:  | 0           | 5700 | 1750 | 0           | 5700 | 1750 | 0          | 0    | 0    | 3150       | 0    | 1750 |
| Capacity Analysis Module:                                |             |      |      |             |      |      |            |      |      |            |      |      |
| Vol/Sat:   | 0.00        | 0.57 | 0.00 | 0.00        | 0.10 | 0.00 | 0.00       | 0.00 | 0.00 | 0.10       | 0.00 | 0.29 |
| Crit Moves:  | ****        | **** | **** | ****        | **** | **** | ****       | **** | **** | ****       | **** | **** |
| Green Time:  | 0.0         | 89.5 | 0.0  | 0.0         | 89.5 | 0.0  | 0.0        | 0.0  | 0.0  | 44.5       | 0.0  | 44.5 |
| Volume/Cap:  | 0.00        | 0.90 | 0.00 | 0.00        | 0.16 | 0.00 | 0.00       | 0.00 | 0.00 | 0.31       | 0.00 | 0.90 |
| Delay/Veh:   | 0.0         | 24.7 | 0.0  | 0.0         | 10.2 | 0.0  | 0.0        | 0.0  | 0.0  | 36.3       | 0.0  | 62.8 |
| User DelAdj:   | 1.00        | 1.00 | 1.00 | 1.00        | 1.00 | 1.00 | 1.00       | 1.00 | 1.00 | 1.00       | 1.00 | 1.00 |
| AdjDel/Veh:  | 0.0         | 24.7 | 0.0  | 0.0         | 10.2 | 0.0  | 0.0        | 0.0  | 0.0  | 36.3       | 0.0  | 62.8 |
| LOS by Move:   | A           | C    | A    | A           | B    | A    | A          | A    | A    | D          | A    | E    |
| HCM2k95thQ:  | 0           | 66   | 0    | 0           | 7    | 0    | 0          | 0    | 0    | 11         | 0    | 42   |

Note: Queue reported is the number of cars per lane.

BART

Level Of Service Computation Report  
 2000 HCM Operations (Future Volume Alternative)  
 PM - Exist + Proj Conditions

Intersection #3052: 880 SB Ramps/Coleman [Study Int 36]

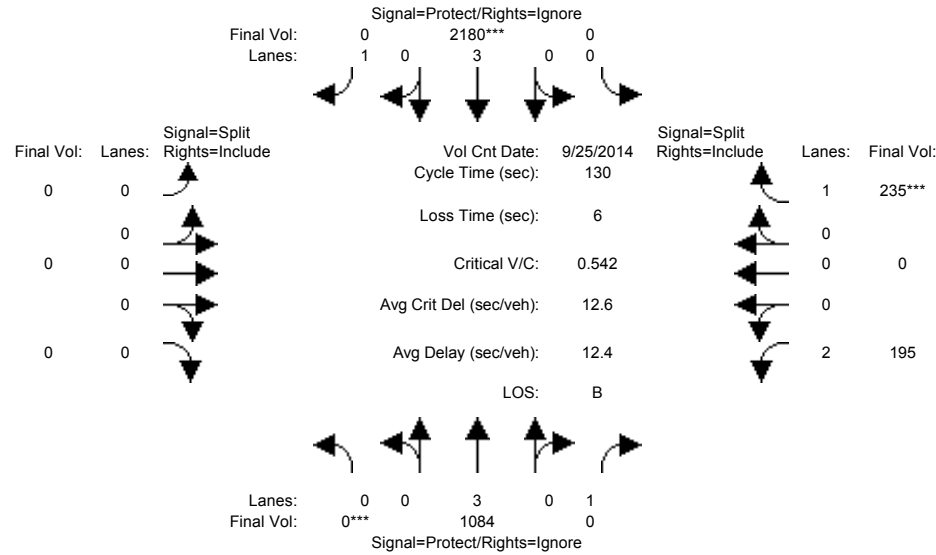

| Approach:   | North Bound |      |      | South Bound |      |      | East Bound |      |      | West Bound |      |      |
|---|-------------|------|------|-------------|------|------|------------|------|------|------------|------|------|
| Movement:   | L           | T    | R    | L           | T    | R    | L          | T    | R    | L          | T    | R    |
| Min. Green:   | 0           | 10   | 10   | 0           | 10   | 10   | 0          | 0    | 0    | 10         | 0    | 10   |
| Y+R:  | 4.0         | 4.0  | 4.0  | 4.0         | 4.0  | 4.0  | 4.0        | 4.0  | 4.0  | 4.0        | 4.0  | 4.0  |
| Volume Module: >> Count Date: 25 Sep 2014 << 4:30 PM to 5:30 PM |             |      |      |             |      |      |            |      |      |            |      |      |
| Base Vol:   | 0           | 1084 | 291  | 0           | 2180 | 709  | 0          | 0    | 0    | 195        | 0    | 235  |
| Growth Adj:   | 1.00        | 1.00 | 1.00 | 1.00        | 1.00 | 1.00 | 1.00       | 1.00 | 1.00 | 1.00       | 1.00 | 1.00 |
| Initial Bse:  | 0           | 1084 | 291  | 0           | 2180 | 709  | 0          | 0    | 0    | 195        | 0    | 235  |
| Added Vol:  | 0           | 0    | 0    | 0           | 0    | 0    | 0          | 0    | 0    | 0          | 0    | 0    |
| PasserByVol:  | 0           | 0    | 0    | 0           | 0    | 0    | 0          | 0    | 0    | 0          | 0    | 0    |
| Initial Fut:  | 0           | 1084 | 291  | 0           | 2180 | 709  | 0          | 0    | 0    | 195        | 0    | 235  |
| User Adj:   | 1.00        | 1.00 | 0.00 | 1.00        | 1.00 | 0.00 | 1.00       | 1.00 | 1.00 | 1.00       | 1.00 | 1.00 |
| PHF Adj:  | 1.00        | 1.00 | 0.00 | 1.00        | 1.00 | 0.00 | 1.00       | 1.00 | 1.00 | 1.00       | 1.00 | 1.00 |
| PHF Volume:   | 0           | 1084 | 0    | 0           | 2180 | 0    | 0          | 0    | 0    | 195        | 0    | 235  |
| Reduct Vol:   | 0           | 0    | 0    | 0           | 0    | 0    | 0          | 0    | 0    | 0          | 0    | 0    |
| Reduced Vol:  | 0           | 1084 | 0    | 0           | 2180 | 0    | 0          | 0    | 0    | 195        | 0    | 235  |
| PCE Adj:  | 1.00        | 1.00 | 0.00 | 1.00        | 1.00 | 0.00 | 1.00       | 1.00 | 1.00 | 1.00       | 1.00 | 1.00 |
| MLF Adj:  | 1.00        | 1.00 | 0.00 | 1.00        | 1.00 | 0.00 | 1.00       | 1.00 | 1.00 | 1.00       | 1.00 | 1.00 |
| Final Volume:   | 0           | 1084 | 0    | 0           | 2180 | 0    | 0          | 0    | 0    | 195        | 0    | 235  |
| Saturation Flow Module:   |             |      |      |             |      |      |            |      |      |            |      |      |
| Sat/Lane:   | 1900        | 1900 | 1900 | 1900        | 1900 | 1900 | 1900       | 1900 | 1900 | 1900       | 1900 | 1900 |
| Adjustment:   | 0.92        | 1.00 | 0.92 | 0.92        | 1.00 | 0.92 | 0.92       | 1.00 | 0.92 | 0.83       | 1.00 | 0.92 |
| Lanes:  | 0.00        | 3.00 | 1.00 | 0.00        | 3.00 | 1.00 | 0.00       | 0.00 | 0.00 | 2.00       | 0.00 | 1.00 |
| Final Sat.:   | 0           | 5700 | 1750 | 0           | 5700 | 1750 | 0          | 0    | 0    | 3150       | 0    | 1750 |
| Capacity Analysis Module:                                       |             |      |      |             |      |      |            |      |      |            |      |      |
| Vol/Sat:  | 0.00        | 0.19 | 0.00 | 0.00        | 0.38 | 0.00 | 0.00       | 0.00 | 0.00 | 0.06       | 0.00 | 0.13 |
| Crit Moves:   | ****        |      |      | ****        |      |      |            |      |      |            |      | **** |
| Green Time:   | 0.0         | 91.8 | 0.0  | 0.0         | 91.8 | 0.0  | 0.0        | 0.0  | 0.0  | 32.2       | 0.0  | 32.2 |
| Volume/Cap:   | 0.00        | 0.27 | 0.00 | 0.00        | 0.54 | 0.00 | 0.00       | 0.00 | 0.00 | 0.25       | 0.00 | 0.54 |
| Delay/Veh:  | 0.0         | 7.0  | 0.0  | 0.0         | 9.3  | 0.0  | 0.0        | 0.0  | 0.0  | 39.4       | 0.0  | 43.9 |
| User DelAdj:  | 1.00        | 1.00 | 1.00 | 1.00        | 1.00 | 1.00 | 1.00       | 1.00 | 1.00 | 1.00       | 1.00 | 1.00 |
| AdjDel/Veh:   | 0.0         | 7.0  | 0.0  | 0.0         | 9.3  | 0.0  | 0.0        | 0.0  | 0.0  | 39.4       | 0.0  | 43.9 |
| LOS by Move:  | A           | A    | A    | A           | A    | A    | A          | A    | A    | D          | A    | D    |
| HCM2k95thQ:   | 0           | 10   | 0    | 0           | 24   | 0    | 0          | 0    | 0    | 7          | 0    | 17   |

Note: Queue reported is the number of cars per lane.

BART

Level Of Service Computation Report  
 2000 HCM Operations (Future Volume Alternative)  
 AM - Exist + Proj Conditions

Intersection #3053: 880 NB Ramps/Coleman [Study Int 37]

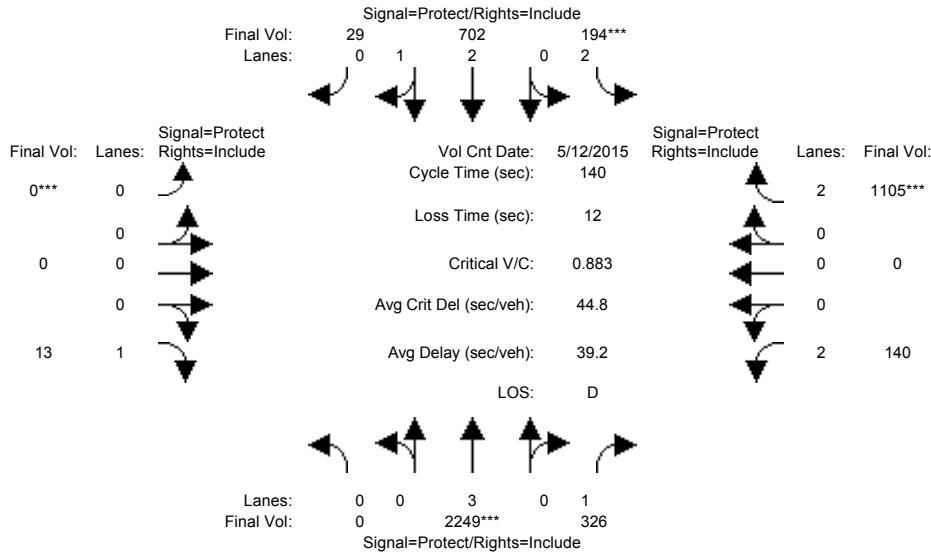

| Approach:  | North Bound |      |      | South Bound |      |      | East Bound |      |      | West Bound |      |      |
|--|-------------|------|------|-------------|------|------|------------|------|------|------------|------|------|
| Movement:  | L           | T    | R    | L           | T    | R    | L          | T    | R    | L          | T    | R    |
| Min. Green:  | 0           | 10   | 10   | 7           | 10   | 10   | 0          | 0    | 10   | 10         | 0    | 10   |
| Y+R:   | 4.0         | 4.0  | 4.0  | 4.0         | 4.0  | 4.0  | 4.0        | 4.0  | 4.0  | 4.0        | 4.0  | 4.0  |
| Volume Module: >> Count Date: 12 May 2015 << 7:45-8:45AM |             |      |      |             |      |      |            |      |      |            |      |      |
| Base Vol:  | 0           | 2249 | 326  | 194         | 702  | 29   | 0          | 0    | 13   | 140        | 0    | 1105 |
| Growth Adj:  | 1.00        | 1.00 | 1.00 | 1.00        | 1.00 | 1.00 | 1.00       | 1.00 | 1.00 | 1.00       | 1.00 | 1.00 |
| Initial Bse:   | 0           | 2249 | 326  | 194         | 702  | 29   | 0          | 0    | 13   | 140        | 0    | 1105 |
| Added Vol:   | 0           | 0    | 0    | 0           | 0    | 0    | 0          | 0    | 0    | 0          | 0    | 0    |
| PasserByVol:   | 0           | 0    | 0    | 0           | 0    | 0    | 0          | 0    | 0    | 0          | 0    | 0    |
| Initial Fut:   | 0           | 2249 | 326  | 194         | 702  | 29   | 0          | 0    | 13   | 140        | 0    | 1105 |
| User Adj:  | 1.00        | 1.00 | 1.00 | 1.00        | 1.00 | 1.00 | 1.00       | 1.00 | 1.00 | 1.00       | 1.00 | 1.00 |
| PHF Adj:   | 1.00        | 1.00 | 1.00 | 1.00        | 1.00 | 1.00 | 1.00       | 1.00 | 1.00 | 1.00       | 1.00 | 1.00 |
| PHF Volume:  | 0           | 2249 | 326  | 194         | 702  | 29   | 0          | 0    | 13   | 140        | 0    | 1105 |
| Reduct Vol:  | 0           | 0    | 0    | 0           | 0    | 0    | 0          | 0    | 0    | 0          | 0    | 0    |
| Reduced Vol:   | 0           | 2249 | 326  | 194         | 702  | 29   | 0          | 0    | 13   | 140        | 0    | 1105 |
| PCE Adj:   | 1.00        | 1.00 | 1.00 | 1.00        | 1.00 | 1.00 | 1.00       | 1.00 | 1.00 | 1.00       | 1.00 | 1.00 |
| MLF Adj:   | 1.00        | 1.00 | 1.00 | 1.00        | 1.00 | 1.00 | 1.00       | 1.00 | 1.00 | 1.00       | 1.00 | 1.00 |
| Final Volume:  | 0           | 2249 | 326  | 194         | 702  | 29   | 0          | 0    | 13   | 140        | 0    | 1105 |
| Saturation Flow Module:                                  |             |      |      |             |      |      |            |      |      |            |      |      |
| Sat/Lane:  | 1900        | 1900 | 1900 | 1900        | 1900 | 1900 | 1900       | 1900 | 1900 | 1900       | 1900 | 1900 |
| Adjustment:  | 0.92        | 1.00 | 0.92 | 0.83        | 0.98 | 0.95 | 0.92       | 1.00 | 0.92 | 0.83       | 1.00 | 0.83 |
| Lanes:   | 0.00        | 3.00 | 1.00 | 2.00        | 2.88 | 0.12 | 0.00       | 0.00 | 1.00 | 2.00       | 0.00 | 2.00 |
| Final Sat.:  | 0           | 5700 | 1750 | 3150        | 5378 | 222  | 0          | 0    | 1750 | 3150       | 0    | 3150 |
| Capacity Analysis Module:                                |             |      |      |             |      |      |            |      |      |            |      |      |
| Vol/Sat:   | 0.00        | 0.39 | 0.19 | 0.06        | 0.13 | 0.13 | 0.00       | 0.00 | 0.01 | 0.04       | 0.00 | 0.35 |
| Crit Moves:  | ****        | **** | **** | ****        | **** | **** | ****       | **** | **** | ****       | **** | **** |
| Green Time:  | 0.0         | 62.6 | 62.6 | 9.8         | 72.4 | 72.4 | 0.0        | 0.0  | 5.2  | 50.4       | 0.0  | 55.6 |
| Volume/Cap:  | 0.00        | 0.88 | 0.42 | 0.88        | 0.25 | 0.25 | 0.00       | 0.00 | 0.20 | 0.12       | 0.00 | 0.88 |
| Delay/Veh:   | 0.0         | 39.4 | 26.7 | 95.9        | 18.8 | 18.8 | 0.0        | 0.0  | 66.8 | 30.1       | 0.0  | 46.8 |
| User DelAdj:   | 1.00        | 1.00 | 1.00 | 1.00        | 1.00 | 1.00 | 1.00       | 1.00 | 1.00 | 1.00       | 1.00 | 1.00 |
| AdjDel/Veh:  | 0.0         | 39.4 | 26.7 | 95.9        | 18.8 | 18.8 | 0.0        | 0.0  | 66.8 | 30.1       | 0.0  | 46.8 |
| LOS by Move:   | A           | D    | C    | F           | B    | B    | A          | A    | E    | C          | A    | D    |
| HCM2k95thQ:  | 0           | 47   | 18   | 14          | 11   | 11   | 0          | 0    | 2    | 5          | 0    | 47   |

Note: Queue reported is the number of cars per lane.



BART

Level Of Service Computation Report  
 2000 HCM Operations (Future Volume Alternative)  
 PM - Exist + Proj Conditions

Intersection #3053: 880 NB Ramps/Coleman [Study Int 37]

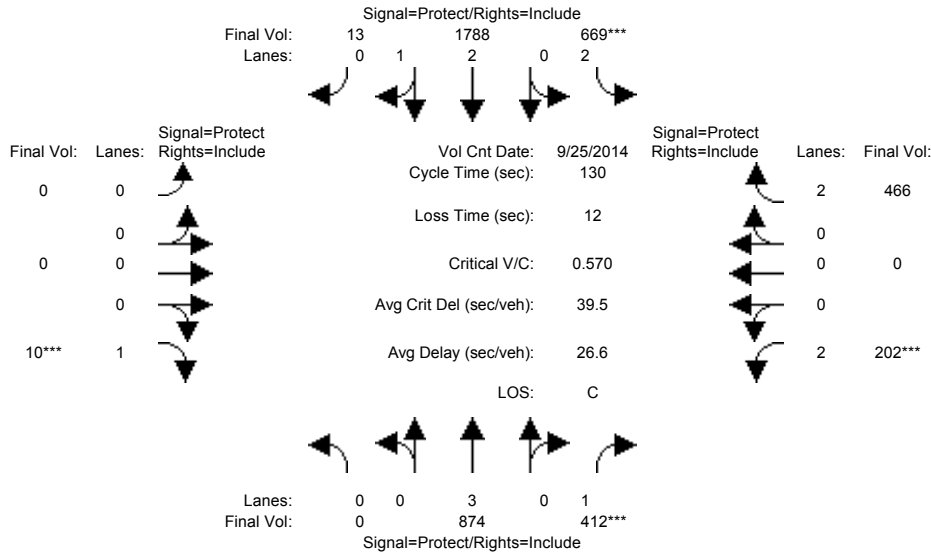

| Approach:  | North Bound |      |      | South Bound |      |      | East Bound |      |      | West Bound |      |      |
|--|-------------|------|------|-------------|------|------|------------|------|------|------------|------|------|
| Movement:  | L           | T    | R    | L           | T    | R    | L          | T    | R    | L          | T    | R    |
| Min. Green:  | 0           | 10   | 10   | 7           | 10   | 10   | 0          | 0    | 10   | 10         | 0    | 10   |
| Y+R:   | 4.0         | 4.0  | 4.0  | 4.0         | 4.0  | 4.0  | 4.0        | 4.0  | 4.0  | 4.0        | 4.0  | 4.0  |
| Volume Module: >> Count Date: 25 Sep 2014 << 5:00-6:00PM |             |      |      |             |      |      |            |      |      |            |      |      |
| Base Vol:  | 0           | 874  | 412  | 669         | 1788 | 13   | 0          | 0    | 10   | 202        | 0    | 466  |
| Growth Adj:  | 1.00        | 1.00 | 1.00 | 1.00        | 1.00 | 1.00 | 1.00       | 1.00 | 1.00 | 1.00       | 1.00 | 1.00 |
| Initial Bse:   | 0           | 874  | 412  | 669         | 1788 | 13   | 0          | 0    | 10   | 202        | 0    | 466  |
| Added Vol:   | 0           | 0    | 0    | 0           | 0    | 0    | 0          | 0    | 0    | 0          | 0    | 0    |
| PasserByVol:   | 0           | 0    | 0    | 0           | 0    | 0    | 0          | 0    | 0    | 0          | 0    | 0    |
| Initial Fut:   | 0           | 874  | 412  | 669         | 1788 | 13   | 0          | 0    | 10   | 202        | 0    | 466  |
| User Adj:  | 1.00        | 1.00 | 1.00 | 1.00        | 1.00 | 1.00 | 1.00       | 1.00 | 1.00 | 1.00       | 1.00 | 1.00 |
| PHF Adj:   | 1.00        | 1.00 | 1.00 | 1.00        | 1.00 | 1.00 | 1.00       | 1.00 | 1.00 | 1.00       | 1.00 | 1.00 |
| PHF Volume:  | 0           | 874  | 412  | 669         | 1788 | 13   | 0          | 0    | 10   | 202        | 0    | 466  |
| Reduct Vol:  | 0           | 0    | 0    | 0           | 0    | 0    | 0          | 0    | 0    | 0          | 0    | 0    |
| Reduced Vol:   | 0           | 874  | 412  | 669         | 1788 | 13   | 0          | 0    | 10   | 202        | 0    | 466  |
| PCE Adj:   | 1.00        | 1.00 | 1.00 | 1.00        | 1.00 | 1.00 | 1.00       | 1.00 | 1.00 | 1.00       | 1.00 | 1.00 |
| MLF Adj:   | 1.00        | 1.00 | 1.00 | 1.00        | 1.00 | 1.00 | 1.00       | 1.00 | 1.00 | 1.00       | 1.00 | 1.00 |
| Final Volume:  | 0           | 874  | 412  | 669         | 1788 | 13   | 0          | 0    | 10   | 202        | 0    | 466  |
| Saturation Flow Module:                                  |             |      |      |             |      |      |            |      |      |            |      |      |
| Sat/Lane:  | 1900        | 1900 | 1900 | 1900        | 1900 | 1900 | 1900       | 1900 | 1900 | 1900       | 1900 | 1900 |
| Adjustment:  | 0.92        | 1.00 | 0.92 | 0.83        | 0.98 | 0.95 | 0.92       | 1.00 | 0.92 | 0.83       | 1.00 | 0.83 |
| Lanes:   | 0.00        | 3.00 | 1.00 | 2.00        | 2.98 | 0.02 | 0.00       | 0.00 | 1.00 | 2.00       | 0.00 | 2.00 |
| Final Sat.:  | 0           | 5700 | 1750 | 3150        | 5560 | 40   | 0          | 0    | 1750 | 3150       | 0    | 3150 |
| Capacity Analysis Module:                                |             |      |      |             |      |      |            |      |      |            |      |      |
| Vol/Sat:   | 0.00        | 0.15 | 0.24 | 0.21        | 0.32 | 0.32 | 0.00       | 0.00 | 0.01 | 0.06       | 0.00 | 0.15 |
| Crit Moves:  | ****        | **** | **** | ****        | **** | **** | ****       | **** | **** | ****       | **** | **** |
| Green Time:  | 0.0         | 49.7 | 49.7 | 44.8        | 94.5 | 94.5 | 0.0        | 0.0  | 10.0 | 13.5       | 0.0  | 23.5 |
| Volume/Cap:  | 0.00        | 0.40 | 0.62 | 0.62        | 0.44 | 0.44 | 0.00       | 0.00 | 0.07 | 0.62       | 0.00 | 0.82 |
| Delay/Veh:   | 0.0         | 29.4 | 34.2 | 36.5        | 7.2  | 7.2  | 0.0        | 0.0  | 55.9 | 59.3       | 0.0  | 60.2 |
| User DelAdj:   | 1.00        | 1.00 | 1.00 | 1.00        | 1.00 | 1.00 | 1.00       | 1.00 | 1.00 | 1.00       | 1.00 | 1.00 |
| AdjDel/Veh:  | 0.0         | 29.4 | 34.2 | 36.5        | 7.2  | 7.2  | 0.0        | 0.0  | 55.9 | 59.3       | 0.0  | 60.2 |
| LOS by Move:   | A           | C    | C    | D           | A    | A    | A          | A    | E    | E          | A    | E    |
| HCM2k95thQ:  | 0           | 15   | 25   | 24          | 18   | 18   | 0          | 0    | 1    | 11         | 0    | 23   |

Note: Queue reported is the number of cars per lane.

BART

Level Of Service Computation Report  
 2000 HCM Operations (Future Volume Alternative)  
 AM - Exist + Proj Conditions

Intersection #3057: The Alameda/Hedding [Study Int 58]

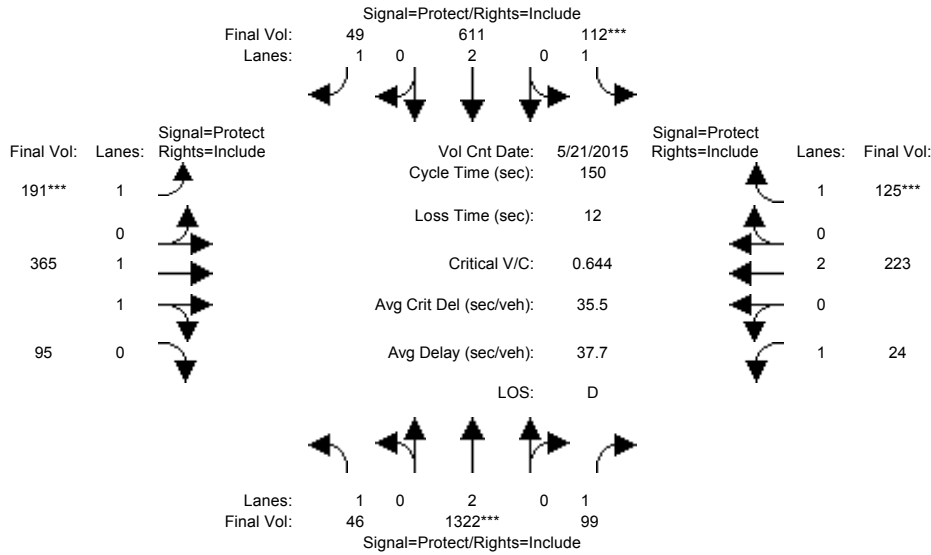

| Approach:  | North Bound |      |      | South Bound |      |      | East Bound |      |      | West Bound |      |      |
|--|-------------|------|------|-------------|------|------|------------|------|------|------------|------|------|
| Movement:  | L           | T    | R    | L           | T    | R    | L          | T    | R    | L          | T    | R    |
| Min. Green:  | 7           | 10   | 10   | 7           | 10   | 10   | 7          | 10   | 10   | 7          | 10   | 10   |
| Y+R:   | 4.0         | 4.0  | 4.0  | 4.0         | 4.0  | 4.0  | 4.0        | 4.0  | 4.0  | 4.0        | 4.0  | 4.0  |
| Volume Module: >> Count Date: 21 May 2015 << 7:30-8:30AM |             |      |      |             |      |      |            |      |      |            |      |      |
| Base Vol:  | 46          | 1322 | 99   | 112         | 611  | 49   | 191        | 365  | 95   | 24         | 223  | 125  |
| Growth Adj:  | 1.00        | 1.00 | 1.00 | 1.00        | 1.00 | 1.00 | 1.00       | 1.00 | 1.00 | 1.00       | 1.00 | 1.00 |
| Initial Bse:   | 46          | 1322 | 99   | 112         | 611  | 49   | 191        | 365  | 95   | 24         | 223  | 125  |
| Added Vol:   | 0           | 0    | 0    | 0           | 0    | 0    | 0          | 0    | 0    | 0          | 0    | 0    |
| PasserByVol:   | 0           | 0    | 0    | 0           | 0    | 0    | 0          | 0    | 0    | 0          | 0    | 0    |
| Initial Fut:   | 46          | 1322 | 99   | 112         | 611  | 49   | 191        | 365  | 95   | 24         | 223  | 125  |
| User Adj:  | 1.00        | 1.00 | 1.00 | 1.00        | 1.00 | 1.00 | 1.00       | 1.00 | 1.00 | 1.00       | 1.00 | 1.00 |
| PHF Adj:   | 1.00        | 1.00 | 1.00 | 1.00        | 1.00 | 1.00 | 1.00       | 1.00 | 1.00 | 1.00       | 1.00 | 1.00 |
| PHF Volume:  | 46          | 1322 | 99   | 112         | 611  | 49   | 191        | 365  | 95   | 24         | 223  | 125  |
| Reduct Vol:  | 0           | 0    | 0    | 0           | 0    | 0    | 0          | 0    | 0    | 0          | 0    | 0    |
| Reduced Vol:   | 46          | 1322 | 99   | 112         | 611  | 49   | 191        | 365  | 95   | 24         | 223  | 125  |
| PCE Adj:   | 1.00        | 1.00 | 1.00 | 1.00        | 1.00 | 1.00 | 1.00       | 1.00 | 1.00 | 1.00       | 1.00 | 1.00 |
| MLF Adj:   | 1.00        | 1.00 | 1.00 | 1.00        | 1.00 | 1.00 | 1.00       | 1.00 | 1.00 | 1.00       | 1.00 | 1.00 |
| Final Volume:  | 46          | 1322 | 99   | 112         | 611  | 49   | 191        | 365  | 95   | 24         | 223  | 125  |
| Saturation Flow Module:                                  |             |      |      |             |      |      |            |      |      |            |      |      |
| Sat/Lane:  | 1900        | 1900 | 1900 | 1900        | 1900 | 1900 | 1900       | 1900 | 1900 | 1900       | 1900 | 1900 |
| Adjustment:  | 0.92        | 1.00 | 0.92 | 0.92        | 1.00 | 0.92 | 0.92       | 0.98 | 0.95 | 0.92       | 1.00 | 0.92 |
| Lanes:   | 1.00        | 2.00 | 1.00 | 1.00        | 2.00 | 1.00 | 1.00       | 1.58 | 0.42 | 1.00       | 2.00 | 1.00 |
| Final Sat.:  | 1750        | 3800 | 1750 | 1750        | 3800 | 1750 | 1750       | 2935 | 764  | 1750       | 3800 | 1750 |
| Capacity Analysis Module:                                |             |      |      |             |      |      |            |      |      |            |      |      |
| Vol/Sat:   | 0.03        | 0.35 | 0.06 | 0.06        | 0.16 | 0.03 | 0.11       | 0.12 | 0.12 | 0.01       | 0.06 | 0.07 |
| Crit Moves:  | ****        | **** | **** | ****        | **** | **** | ****       | **** | **** | ****       | **** | **** |
| Green Time:  | 21.6        | 81.0 | 81.0 | 14.9        | 74.4 | 74.4 | 25.4       | 30.6 | 30.6 | 11.5       | 16.6 | 16.6 |
| Volume/Cap:  | 0.18        | 0.64 | 0.10 | 0.64        | 0.32 | 0.06 | 0.64       | 0.61 | 0.61 | 0.18       | 0.53 | 0.64 |
| Delay/Veh:   | 56.8        | 25.0 | 16.9 | 73.0        | 22.8 | 19.6 | 62.9       | 55.8 | 55.8 | 65.5       | 64.3 | 71.1 |
| User DelAdj:   | 1.00        | 1.00 | 1.00 | 1.00        | 1.00 | 1.00 | 1.00       | 1.00 | 1.00 | 1.00       | 1.00 | 1.00 |
| AdjDel/Veh:  | 56.8        | 25.0 | 16.9 | 73.0        | 22.8 | 19.6 | 62.9       | 55.8 | 55.8 | 65.5       | 64.3 | 71.1 |
| LOS by Move:   | E           | C    | B    | E           | C    | B    | E          | E    | E    | E          | E    | E    |
| HCM2k95thQ:  | 4           | 35   | 5    | 11          | 15   | 2    | 18         | 19   | 19   | 2          | 9    | 11   |

Note: Queue reported is the number of cars per lane.

BART

Level Of Service Computation Report  
 2000 HCM Operations (Future Volume Alternative)  
 PM - Exist + Proj Conditions

Intersection #3057: The Alameda/Hedding [Study Int 58]

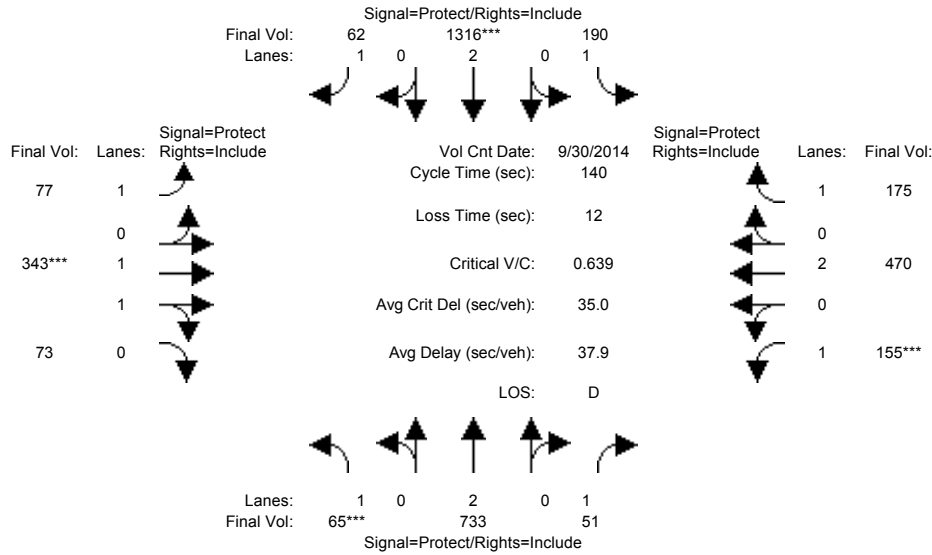

| Approach:  | North Bound |      |      | South Bound |      |      | East Bound |      |      | West Bound |      |      |
|--|-------------|------|------|-------------|------|------|------------|------|------|------------|------|------|
| Movement:  | L           | T    | R    | L           | T    | R    | L          | T    | R    | L          | T    | R    |
| Min. Green:  | 7           | 10   | 10   | 7           | 10   | 10   | 7          | 10   | 10   | 7          | 10   | 10   |
| Y+R:   | 4.0         | 4.0  | 4.0  | 4.0         | 4.0  | 4.0  | 4.0        | 4.0  | 4.0  | 4.0        | 4.0  | 4.0  |
| Volume Module: >> Count Date: 30 Sep 2014 << 5:00-6:00PM |             |      |      |             |      |      |            |      |      |            |      |      |
| Base Vol:  | 65          | 733  | 51   | 190         | 1316 | 62   | 77         | 343  | 73   | 155        | 470  | 175  |
| Growth Adj:  | 1.00        | 1.00 | 1.00 | 1.00        | 1.00 | 1.00 | 1.00       | 1.00 | 1.00 | 1.00       | 1.00 | 1.00 |
| Initial Bse:   | 65          | 733  | 51   | 190         | 1316 | 62   | 77         | 343  | 73   | 155        | 470  | 175  |
| Added Vol:   | 0           | 0    | 0    | 0           | 0    | 0    | 0          | 0    | 0    | 0          | 0    | 0    |
| PasserByVol:   | 0           | 0    | 0    | 0           | 0    | 0    | 0          | 0    | 0    | 0          | 0    | 0    |
| Initial Fut:   | 65          | 733  | 51   | 190         | 1316 | 62   | 77         | 343  | 73   | 155        | 470  | 175  |
| User Adj:  | 1.00        | 1.00 | 1.00 | 1.00        | 1.00 | 1.00 | 1.00       | 1.00 | 1.00 | 1.00       | 1.00 | 1.00 |
| PHF Adj:   | 1.00        | 1.00 | 1.00 | 1.00        | 1.00 | 1.00 | 1.00       | 1.00 | 1.00 | 1.00       | 1.00 | 1.00 |
| PHF Volume:  | 65          | 733  | 51   | 190         | 1316 | 62   | 77         | 343  | 73   | 155        | 470  | 175  |
| Reduct Vol:  | 0           | 0    | 0    | 0           | 0    | 0    | 0          | 0    | 0    | 0          | 0    | 0    |
| Reduced Vol:   | 65          | 733  | 51   | 190         | 1316 | 62   | 77         | 343  | 73   | 155        | 470  | 175  |
| PCE Adj:   | 1.00        | 1.00 | 1.00 | 1.00        | 1.00 | 1.00 | 1.00       | 1.00 | 1.00 | 1.00       | 1.00 | 1.00 |
| MLF Adj:   | 1.00        | 1.00 | 1.00 | 1.00        | 1.00 | 1.00 | 1.00       | 1.00 | 1.00 | 1.00       | 1.00 | 1.00 |
| FinalVolume:   | 65          | 733  | 51   | 190         | 1316 | 62   | 77         | 343  | 73   | 155        | 470  | 175  |
| Saturation Flow Module:                                  |             |      |      |             |      |      |            |      |      |            |      |      |
| Sat/Lane:  | 1900        | 1900 | 1900 | 1900        | 1900 | 1900 | 1900       | 1900 | 1900 | 1900       | 1900 | 1900 |
| Adjustment:  | 0.92        | 1.00 | 0.92 | 0.92        | 1.00 | 0.92 | 0.92       | 0.98 | 0.95 | 0.92       | 1.00 | 0.92 |
| Lanes:   | 1.00        | 2.00 | 1.00 | 1.00        | 2.00 | 1.00 | 1.00       | 1.64 | 0.36 | 1.00       | 2.00 | 1.00 |
| Final Sat.:  | 1750        | 3800 | 1750 | 1750        | 3800 | 1750 | 1750       | 3050 | 649  | 1750       | 3800 | 1750 |
| Capacity Analysis Module:                                |             |      |      |             |      |      |            |      |      |            |      |      |
| Vol/Sat:   | 0.04        | 0.19 | 0.03 | 0.11        | 0.35 | 0.04 | 0.04       | 0.11 | 0.11 | 0.09       | 0.12 | 0.10 |
| Crit Moves:  | ****        |      |      | ****        |      |      | ****       |      |      | ****       |      |      |
| Green Time:  | 8.1         | 53.7 | 53.7 | 30.2        | 75.8 | 75.8 | 12.7       | 24.6 | 24.6 | 19.4       | 31.3 | 31.3 |
| Volume/Cap:  | 0.64        | 0.50 | 0.08 | 0.50        | 0.64 | 0.07 | 0.49       | 0.64 | 0.64 | 0.64       | 0.55 | 0.45 |
| Delay/Veh:   | 77.4        | 33.2 | 27.4 | 49.3        | 23.2 | 15.3 | 62.9       | 55.7 | 55.7 | 62.6       | 48.9 | 47.7 |
| User DelAdj:   | 1.00        | 1.00 | 1.00 | 1.00        | 1.00 | 1.00 | 1.00       | 1.00 | 1.00 | 1.00       | 1.00 | 1.00 |
| AdjDel/Veh:  | 77.4        | 33.2 | 27.4 | 49.3        | 23.2 | 15.3 | 62.9       | 55.7 | 55.7 | 62.6       | 48.9 | 47.7 |
| LOS by Move:   | E           | C    | C    | D           | C    | B    | E          | E    | E    | E          | D    | D    |
| HCM2k95thQ:  | 6           | 21   | 3    | 14          | 33   | 3    | 8          | 17   | 17   | 13         | 16   | 13   |

Note: Queue reported is the number of cars per lane.

BART

Level Of Service Computation Report  
 2000 HCM Operations (Future Volume Alternative)  
 AM - Exist + Proj Conditions

Intersection #3058: The Alameda/Naglee [Study Int 59]

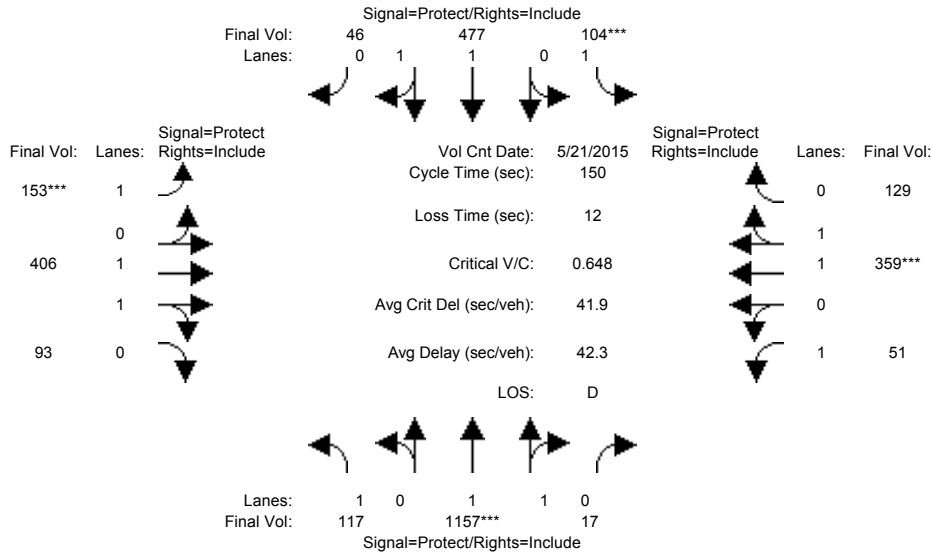

| Approach:  | North Bound |      |      | South Bound |      |      | East Bound |      |      | West Bound |      |      |
|--|-------------|------|------|-------------|------|------|------------|------|------|------------|------|------|
| Movement:  | L           | T    | R    | L           | T    | R    | L          | T    | R    | L          | T    | R    |
| Min. Green:  | 7           | 10   | 10   | 7           | 10   | 10   | 7          | 10   | 10   | 7          | 10   | 10   |
| Y+R:   | 4.0         | 4.0  | 4.0  | 4.0         | 4.0  | 4.0  | 4.0        | 4.0  | 4.0  | 4.0        | 4.0  | 4.0  |
| Volume Module: >> Count Date: 21 May 2015 << 7:30-8:30AM |             |      |      |             |      |      |            |      |      |            |      |      |
| Base Vol:  | 117         | 1157 | 17   | 104         | 477  | 46   | 153        | 406  | 93   | 51         | 359  | 129  |
| Growth Adj:  | 1.00        | 1.00 | 1.00 | 1.00        | 1.00 | 1.00 | 1.00       | 1.00 | 1.00 | 1.00       | 1.00 | 1.00 |
| Initial Bse:   | 117         | 1157 | 17   | 104         | 477  | 46   | 153        | 406  | 93   | 51         | 359  | 129  |
| Added Vol:   | 0           | 0    | 0    | 0           | 0    | 0    | 0          | 0    | 0    | 0          | 0    | 0    |
| PasserByVol:   | 0           | 0    | 0    | 0           | 0    | 0    | 0          | 0    | 0    | 0          | 0    | 0    |
| Initial Fut:   | 117         | 1157 | 17   | 104         | 477  | 46   | 153        | 406  | 93   | 51         | 359  | 129  |
| User Adj:  | 1.00        | 1.00 | 1.00 | 1.00        | 1.00 | 1.00 | 1.00       | 1.00 | 1.00 | 1.00       | 1.00 | 1.00 |
| PHF Adj:   | 1.00        | 1.00 | 1.00 | 1.00        | 1.00 | 1.00 | 1.00       | 1.00 | 1.00 | 1.00       | 1.00 | 1.00 |
| PHF Volume:  | 117         | 1157 | 17   | 104         | 477  | 46   | 153        | 406  | 93   | 51         | 359  | 129  |
| Reduct Vol:  | 0           | 0    | 0    | 0           | 0    | 0    | 0          | 0    | 0    | 0          | 0    | 0    |
| Reduced Vol:   | 117         | 1157 | 17   | 104         | 477  | 46   | 153        | 406  | 93   | 51         | 359  | 129  |
| PCE Adj:   | 1.00        | 1.00 | 1.00 | 1.00        | 1.00 | 1.00 | 1.00       | 1.00 | 1.00 | 1.00       | 1.00 | 1.00 |
| MLF Adj:   | 1.00        | 1.00 | 1.00 | 1.00        | 1.00 | 1.00 | 1.00       | 1.00 | 1.00 | 1.00       | 1.00 | 1.00 |
| Final Volume:  | 117         | 1157 | 17   | 104         | 477  | 46   | 153        | 406  | 93   | 51         | 359  | 129  |
| Saturation Flow Module:                                  |             |      |      |             |      |      |            |      |      |            |      |      |
| Sat/Lane:  | 1900        | 1900 | 1900 | 1900        | 1900 | 1900 | 1900       | 1900 | 1900 | 1900       | 1900 | 1900 |
| Adjustment:  | 0.92        | 0.97 | 0.95 | 0.92        | 0.98 | 0.95 | 0.92       | 0.98 | 0.95 | 0.92       | 0.98 | 0.95 |
| Lanes:   | 1.00        | 1.97 | 0.03 | 1.00        | 1.82 | 0.18 | 1.00       | 1.62 | 0.38 | 1.00       | 1.46 | 0.54 |
| Final Sat.:  | 1750        | 3646 | 54   | 1750        | 3374 | 325  | 1750       | 3010 | 689  | 1750       | 2721 | 978  |
| Capacity Analysis Module:                                |             |      |      |             |      |      |            |      |      |            |      |      |
| Vol/Sat:   | 0.07        | 0.32 | 0.32 | 0.06        | 0.14 | 0.14 | 0.09       | 0.13 | 0.13 | 0.03       | 0.13 | 0.13 |
| Crit Moves:  | ****        | **** | **** | ****        | **** | **** | ****       | **** | **** | ****       | **** | **** |
| Green Time:  | 28.0        | 73.5 | 73.5 | 13.8        | 59.2 | 59.2 | 20.2       | 37.7 | 37.7 | 13.1       | 30.5 | 30.5 |
| Volume/Cap:  | 0.36        | 0.65 | 0.65 | 0.65        | 0.36 | 0.36 | 0.65       | 0.54 | 0.54 | 0.33       | 0.65 | 0.65 |
| Delay/Veh:   | 53.8        | 29.4 | 29.4 | 74.7        | 32.1 | 32.1 | 67.7       | 49.2 | 49.2 | 65.7       | 56.8 | 56.8 |
| User DelAdj:   | 1.00        | 1.00 | 1.00 | 1.00        | 1.00 | 1.00 | 1.00       | 1.00 | 1.00 | 1.00       | 1.00 | 1.00 |
| AdjDel/Veh:  | 53.8        | 29.4 | 29.4 | 74.7        | 32.1 | 32.1 | 67.7       | 49.2 | 49.2 | 65.7       | 56.8 | 56.8 |
| LOS by Move:   | D           | C    | C    | E           | C    | C    | E          | D    | D    | E          | E    | E    |
| HCM2k95thQ:  | 10          | 35   | 35   | 10          | 16   | 16   | 15         | 19   | 19   | 5          | 19   | 19   |

Note: Queue reported is the number of cars per lane.

BART

Level Of Service Computation Report  
 2000 HCM Operations (Future Volume Alternative)  
 PM - Exist + Proj Conditions

Intersection #3058: The Alameda/Naglee [Study Int 59]

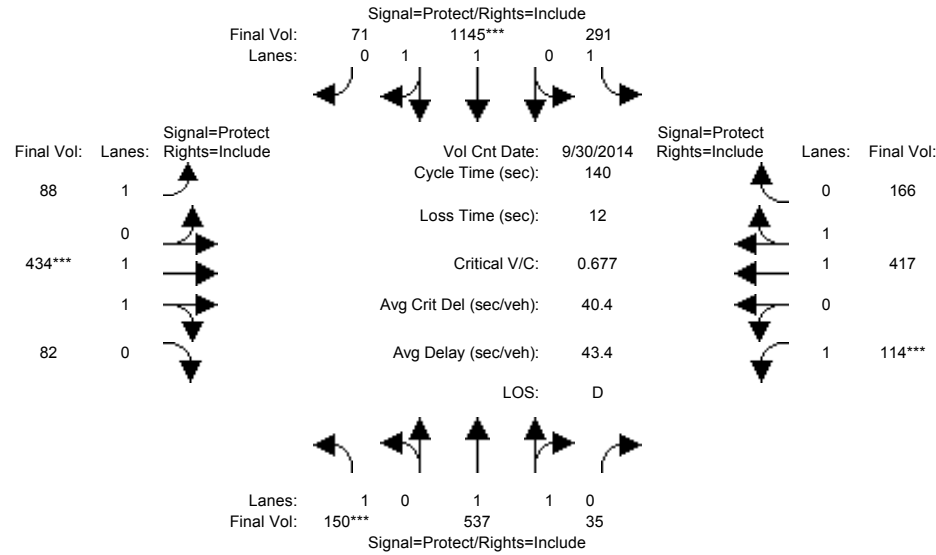

| Approach:  | North Bound |      |      | South Bound |      |      | East Bound |      |      | West Bound |      |      |
|--|-------------|------|------|-------------|------|------|------------|------|------|------------|------|------|
| Movement:  | L           | T    | R    | L           | T    | R    | L          | T    | R    | L          | T    | R    |
| Min. Green:  | 7           | 10   | 10   | 7           | 10   | 10   | 7          | 10   | 10   | 7          | 10   | 10   |
| Y+R:   | 4.0         | 4.0  | 4.0  | 4.0         | 4.0  | 4.0  | 4.0        | 4.0  | 4.0  | 4.0        | 4.0  | 4.0  |
| Volume Module: >> Count Date: 30 Sep 2014 << 500-600PM |             |      |      |             |      |      |            |      |      |            |      |      |
| Base Vol:  | 150         | 537  | 35   | 291         | 1145 | 71   | 88         | 434  | 82   | 114        | 417  | 166  |
| Growth Adj:  | 1.00        | 1.00 | 1.00 | 1.00        | 1.00 | 1.00 | 1.00       | 1.00 | 1.00 | 1.00       | 1.00 | 1.00 |
| Initial Bse:   | 150         | 537  | 35   | 291         | 1145 | 71   | 88         | 434  | 82   | 114        | 417  | 166  |
| Added Vol:   | 0           | 0    | 0    | 0           | 0    | 0    | 0          | 0    | 0    | 0          | 0    | 0    |
| PasserByVol:   | 0           | 0    | 0    | 0           | 0    | 0    | 0          | 0    | 0    | 0          | 0    | 0    |
| Initial Fut:   | 150         | 537  | 35   | 291         | 1145 | 71   | 88         | 434  | 82   | 114        | 417  | 166  |
| User Adj:  | 1.00        | 1.00 | 1.00 | 1.00        | 1.00 | 1.00 | 1.00       | 1.00 | 1.00 | 1.00       | 1.00 | 1.00 |
| PHF Adj:   | 1.00        | 1.00 | 1.00 | 1.00        | 1.00 | 1.00 | 1.00       | 1.00 | 1.00 | 1.00       | 1.00 | 1.00 |
| PHF Volume:  | 150         | 537  | 35   | 291         | 1145 | 71   | 88         | 434  | 82   | 114        | 417  | 166  |
| Reduct Vol:  | 0           | 0    | 0    | 0           | 0    | 0    | 0          | 0    | 0    | 0          | 0    | 0    |
| Reduced Vol:   | 150         | 537  | 35   | 291         | 1145 | 71   | 88         | 434  | 82   | 114        | 417  | 166  |
| PCE Adj:   | 1.00        | 1.00 | 1.00 | 1.00        | 1.00 | 1.00 | 1.00       | 1.00 | 1.00 | 1.00       | 1.00 | 1.00 |
| MLF Adj:   | 1.00        | 1.00 | 1.00 | 1.00        | 1.00 | 1.00 | 1.00       | 1.00 | 1.00 | 1.00       | 1.00 | 1.00 |
| Final Volume:  | 150         | 537  | 35   | 291         | 1145 | 71   | 88         | 434  | 82   | 114        | 417  | 166  |
| Saturation Flow Module:                                |             |      |      |             |      |      |            |      |      |            |      |      |
| Sat/Lane:  | 1900        | 1900 | 1900 | 1900        | 1900 | 1900 | 1900       | 1900 | 1900 | 1900       | 1900 | 1900 |
| Adjustment:  | 0.92        | 0.98 | 0.95 | 0.92        | 0.98 | 0.95 | 0.92       | 0.98 | 0.95 | 0.92       | 0.98 | 0.95 |
| Lanes:   | 1.00        | 1.87 | 0.13 | 1.00        | 1.88 | 0.12 | 1.00       | 1.67 | 0.33 | 1.00       | 1.41 | 0.59 |
| Final Sat.:  | 1750        | 3473 | 226  | 1750        | 3484 | 216  | 1750       | 3112 | 588  | 1750       | 2646 | 1053 |
| Capacity Analysis Module:                              |             |      |      |             |      |      |            |      |      |            |      |      |
| Vol/Sat:   | 0.09        | 0.15 | 0.15 | 0.17        | 0.33 | 0.33 | 0.05       | 0.14 | 0.14 | 0.07       | 0.16 | 0.16 |
| Crit Moves:  | ****        |      |      | ****        |      |      | ****       |      |      | ****       |      |      |
| Green Time:  | 17.7        | 41.3 | 41.3 | 44.4        | 68.0 | 68.0 | 10.2       | 28.8 | 28.8 | 13.5       | 32.1 | 32.1 |
| Volume/Cap:  | 0.68        | 0.52 | 0.52 | 0.52        | 0.68 | 0.68 | 0.69       | 0.68 | 0.68 | 0.68       | 0.69 | 0.69 |
| Delay/Veh:   | 66.5        | 41.6 | 41.6 | 40.1        | 28.7 | 28.7 | 77.9       | 53.7 | 53.7 | 71.7       | 51.8 | 51.8 |
| User DelAdj:   | 1.00        | 1.00 | 1.00 | 1.00        | 1.00 | 1.00 | 1.00       | 1.00 | 1.00 | 1.00       | 1.00 | 1.00 |
| AdjDel/Veh:  | 66.5        | 41.6 | 41.6 | 40.1        | 28.7 | 28.7 | 77.9       | 53.7 | 53.7 | 71.7       | 51.8 | 51.8 |
| LOS by Move:   | E           | D    | D    | D           | C    | C    | E          | D    | D    | E          | D    | D    |
| HCM2k95thQ:  | 15          | 19   | 19   | 19          | 34   | 34   | 10         | 21   | 21   | 10         | 21   | 21   |

Note: Queue reported is the number of cars per lane.

BART

Level Of Service Computation Report  
2000 HCM Operations (Future Volume Alternative)  
AM - Exist + Proj Conditions

Intersection #3063: ALUM ROCK/JACKSON [Study Int 18]

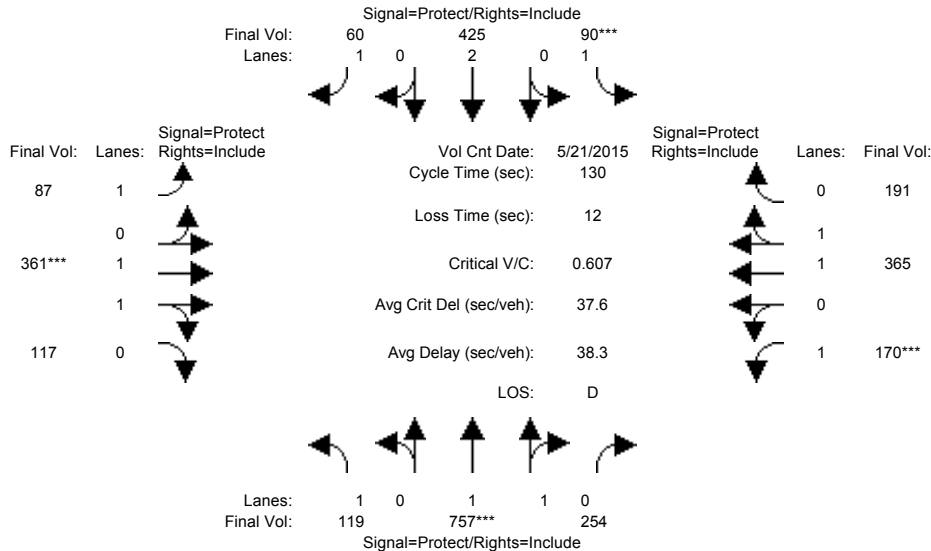

| Approach:  | North Bound |      |      | South Bound |      |      | East Bound |      |      | West Bound |      |      |
|--|-------------|------|------|-------------|------|------|------------|------|------|------------|------|------|
| Movement:  | L           | T    | R    | L           | T    | R    | L          | T    | R    | L          | T    | R    |
| Min. Green:  | 7           | 10   | 10   | 7           | 10   | 10   | 7          | 10   | 10   | 7          | 10   | 10   |
| Y+R:   | 4.0         | 4.0  | 4.0  | 4.0         | 4.0  | 4.0  | 4.0        | 4.0  | 4.0  | 4.0        | 4.0  | 4.0  |
| Volume Module: >> Count Date: 21 May 2015 << 7:45-8:45AM |             |      |      |             |      |      |            |      |      |            |      |      |
| Base Vol:  | 119         | 757  | 254  | 90          | 425  | 60   | 87         | 361  | 117  | 170        | 365  | 191  |
| Growth Adj:  | 1.00        | 1.00 | 1.00 | 1.00        | 1.00 | 1.00 | 1.00       | 1.00 | 1.00 | 1.00       | 1.00 | 1.00 |
| Initial Bse:   | 119         | 757  | 254  | 90          | 425  | 60   | 87         | 361  | 117  | 170        | 365  | 191  |
| Added Vol:   | 0           | 0    | 0    | 0           | 0    | 0    | 0          | 0    | 0    | 0          | 0    | 0    |
| PasserByVol:   | 0           | 0    | 0    | 0           | 0    | 0    | 0          | 0    | 0    | 0          | 0    | 0    |
| Initial Fut:   | 119         | 757  | 254  | 90          | 425  | 60   | 87         | 361  | 117  | 170        | 365  | 191  |
| User Adj:  | 1.00        | 1.00 | 1.00 | 1.00        | 1.00 | 1.00 | 1.00       | 1.00 | 1.00 | 1.00       | 1.00 | 1.00 |
| PHF Adj:   | 1.00        | 1.00 | 1.00 | 1.00        | 1.00 | 1.00 | 1.00       | 1.00 | 1.00 | 1.00       | 1.00 | 1.00 |
| PHF Volume:  | 119         | 757  | 254  | 90          | 425  | 60   | 87         | 361  | 117  | 170        | 365  | 191  |
| Reduct Vol:  | 0           | 0    | 0    | 0           | 0    | 0    | 0          | 0    | 0    | 0          | 0    | 0    |
| Reduced Vol:   | 119         | 757  | 254  | 90          | 425  | 60   | 87         | 361  | 117  | 170        | 365  | 191  |
| PCE Adj:   | 1.00        | 1.00 | 1.00 | 1.00        | 1.00 | 1.00 | 1.00       | 1.00 | 1.00 | 1.00       | 1.00 | 1.00 |
| MLF Adj:   | 1.00        | 1.00 | 1.00 | 1.00        | 1.00 | 1.00 | 1.00       | 1.00 | 1.00 | 1.00       | 1.00 | 1.00 |
| FinalVolume:   | 119         | 757  | 254  | 90          | 425  | 60   | 87         | 361  | 117  | 170        | 365  | 191  |
| Saturation Flow Module:                                  |             |      |      |             |      |      |            |      |      |            |      |      |
| Sat/Lane:  | 1900        | 1900 | 1900 | 1900        | 1900 | 1900 | 1900       | 1900 | 1900 | 1900       | 1900 | 1900 |
| Adjustment:  | 0.92        | 0.98 | 0.95 | 0.92        | 1.00 | 0.92 | 0.92       | 0.98 | 0.95 | 0.92       | 0.99 | 0.95 |
| Lanes:   | 1.00        | 1.48 | 0.52 | 1.00        | 2.00 | 1.00 | 1.00       | 1.50 | 0.50 | 1.00       | 1.29 | 0.71 |
| Final Sat.:  | 1750        | 2770 | 929  | 1750        | 3800 | 1750 | 1750       | 2794 | 905  | 1750       | 2428 | 1271 |
| Capacity Analysis Module:                                |             |      |      |             |      |      |            |      |      |            |      |      |
| Vol/Sat:   | 0.07        | 0.27 | 0.27 | 0.05        | 0.11 | 0.03 | 0.05       | 0.13 | 0.13 | 0.10       | 0.15 | 0.15 |
| Crit Moves:  | ****        | **** | **** | ****        | **** | **** | ****       | **** | **** | ****       | **** | **** |
| Green Time:  | 26.3        | 58.5 | 58.5 | 11.0        | 43.2 | 43.2 | 12.8       | 27.7 | 27.7 | 20.8       | 35.7 | 35.7 |
| Volume/Cap:  | 0.34        | 0.61 | 0.61 | 0.61        | 0.34 | 0.10 | 0.51       | 0.61 | 0.61 | 0.61       | 0.55 | 0.55 |
| Delay/Veh:   | 45.0        | 27.7 | 27.7 | 64.5        | 32.8 | 30.1 | 58.0       | 47.6 | 47.6 | 54.6       | 40.9 | 40.9 |
| User DelAdj:   | 1.00        | 1.00 | 1.00 | 1.00        | 1.00 | 1.00 | 1.00       | 1.00 | 1.00 | 1.00       | 1.00 | 1.00 |
| AdjDel/Veh:  | 45.0        | 27.7 | 27.7 | 64.5        | 32.8 | 30.1 | 58.0       | 47.6 | 47.6 | 54.6       | 40.9 | 40.9 |
| LOS by Move:   | D           | C    | C    | E           | C    | C    | E          | D    | D    | D          | D    | D    |
| HCM2k95thQ:  | 9           | 27   | 27   | 9           | 12   | 4    | 7          | 16   | 16   | 13         | 18   | 18   |

Note: Queue reported is the number of cars per lane.

BART

Level Of Service Computation Report  
 2000 HCM Operations (Future Volume Alternative)  
 PM - Exist + Proj Conditions

Intersection #3063: ALUM ROCK/JACKSON [Study Int 18]

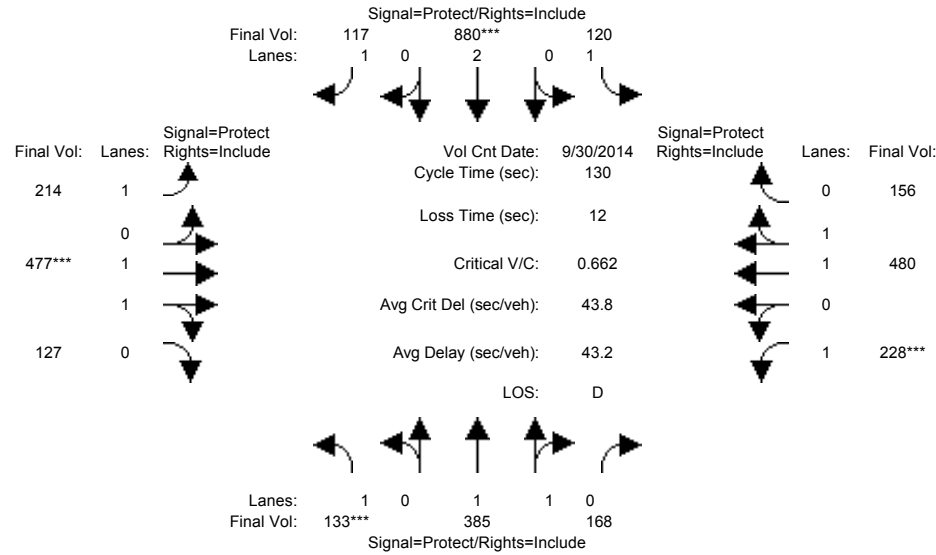

| Approach:  | North Bound |      |      | South Bound |      |      | East Bound |      |      | West Bound |      |      |
|--|-------------|------|------|-------------|------|------|------------|------|------|------------|------|------|
| Movement:  | L           | T    | R    | L           | T    | R    | L          | T    | R    | L          | T    | R    |
| Min. Green:  | 7           | 10   | 10   | 7           | 10   | 10   | 7          | 10   | 10   | 7          | 10   | 10   |
| Y+R:   | 4.0         | 4.0  | 4.0  | 4.0         | 4.0  | 4.0  | 4.0        | 4.0  | 4.0  | 4.0        | 4.0  | 4.0  |
| Volume Module: >> Count Date: 30 Sep 2014 << 4:15-5:15PM |             |      |      |             |      |      |            |      |      |            |      |      |
| Base Vol:  | 133         | 385  | 168  | 120         | 880  | 117  | 214        | 477  | 127  | 228        | 480  | 156  |
| Growth Adj:  | 1.00        | 1.00 | 1.00 | 1.00        | 1.00 | 1.00 | 1.00       | 1.00 | 1.00 | 1.00       | 1.00 | 1.00 |
| Initial Bse:   | 133         | 385  | 168  | 120         | 880  | 117  | 214        | 477  | 127  | 228        | 480  | 156  |
| Added Vol:   | 0           | 0    | 0    | 0           | 0    | 0    | 0          | 0    | 0    | 0          | 0    | 0    |
| PasserByVol:   | 0           | 0    | 0    | 0           | 0    | 0    | 0          | 0    | 0    | 0          | 0    | 0    |
| Initial Fut:   | 133         | 385  | 168  | 120         | 880  | 117  | 214        | 477  | 127  | 228        | 480  | 156  |
| User Adj:  | 1.00        | 1.00 | 1.00 | 1.00        | 1.00 | 1.00 | 1.00       | 1.00 | 1.00 | 1.00       | 1.00 | 1.00 |
| PHF Adj:   | 1.00        | 1.00 | 1.00 | 1.00        | 1.00 | 1.00 | 1.00       | 1.00 | 1.00 | 1.00       | 1.00 | 1.00 |
| PHF Volume:  | 133         | 385  | 168  | 120         | 880  | 117  | 214        | 477  | 127  | 228        | 480  | 156  |
| Reduct Vol:  | 0           | 0    | 0    | 0           | 0    | 0    | 0          | 0    | 0    | 0          | 0    | 0    |
| Reduced Vol:   | 133         | 385  | 168  | 120         | 880  | 117  | 214        | 477  | 127  | 228        | 480  | 156  |
| PCE Adj:   | 1.00        | 1.00 | 1.00 | 1.00        | 1.00 | 1.00 | 1.00       | 1.00 | 1.00 | 1.00       | 1.00 | 1.00 |
| MLF Adj:   | 1.00        | 1.00 | 1.00 | 1.00        | 1.00 | 1.00 | 1.00       | 1.00 | 1.00 | 1.00       | 1.00 | 1.00 |
| Final Volume:  | 133         | 385  | 168  | 120         | 880  | 117  | 214        | 477  | 127  | 228        | 480  | 156  |
| Saturation Flow Module:                                  |             |      |      |             |      |      |            |      |      |            |      |      |
| Sat/Lane:  | 1900        | 1900 | 1900 | 1900        | 1900 | 1900 | 1900       | 1900 | 1900 | 1900       | 1900 | 1900 |
| Adjustment:  | 0.92        | 0.99 | 0.95 | 0.92        | 1.00 | 0.92 | 0.92       | 0.98 | 0.95 | 0.92       | 0.98 | 0.95 |
| Lanes:   | 1.00        | 1.38 | 0.62 | 1.00        | 2.00 | 1.00 | 1.00       | 1.57 | 0.43 | 1.00       | 1.50 | 0.50 |
| Final Sat.:  | 1750        | 2575 | 1124 | 1750        | 3800 | 1750 | 1750       | 2921 | 778  | 1750       | 2792 | 907  |
| Capacity Analysis Module:                                |             |      |      |             |      |      |            |      |      |            |      |      |
| Vol/Sat:   | 0.08        | 0.15 | 0.15 | 0.07        | 0.23 | 0.07 | 0.12       | 0.16 | 0.16 | 0.13       | 0.17 | 0.17 |
| Crit Moves:  | ****        |      |      | ****        |      |      | ****       |      |      | ****       |      |      |
| Green Time:  | 14.9        | 41.4 | 41.4 | 19.0        | 45.5 | 45.5 | 24.0       | 32.0 | 32.0 | 25.6       | 33.7 | 33.7 |
| Volume/Cap:  | 0.66        | 0.47 | 0.47 | 0.47        | 0.66 | 0.19 | 0.66       | 0.66 | 0.66 | 0.66       | 0.66 | 0.66 |
| Delay/Veh:   | 63.1        | 35.8 | 35.8 | 52.3        | 37.0 | 29.6 | 54.4       | 45.9 | 45.9 | 53.0       | 44.9 | 44.9 |
| User DelAdj:   | 1.00        | 1.00 | 1.00 | 1.00        | 1.00 | 1.00 | 1.00       | 1.00 | 1.00 | 1.00       | 1.00 | 1.00 |
| AdjDel/Veh:  | 63.1        | 35.8 | 35.8 | 52.3        | 37.0 | 29.6 | 54.4       | 45.9 | 45.9 | 53.0       | 44.9 | 44.9 |
| LOS by Move:   | E           | D    | D    | D           | D    | C    | D          | D    | D    | D          | D    | D    |
| HCM2k95thQ:  | 13          | 17   | 17   | 10          | 27   | 7    | 16         | 20   | 20   | 17         | 21   | 21   |

Note: Queue reported is the number of cars per lane.

BART

Level Of Service Computation Report  
 2000 HCM Operations (Future Volume Alternative)  
 AM - Exist + Proj Conditions

Intersection #3064: ALUM ROCK/KING [Study Int 17]

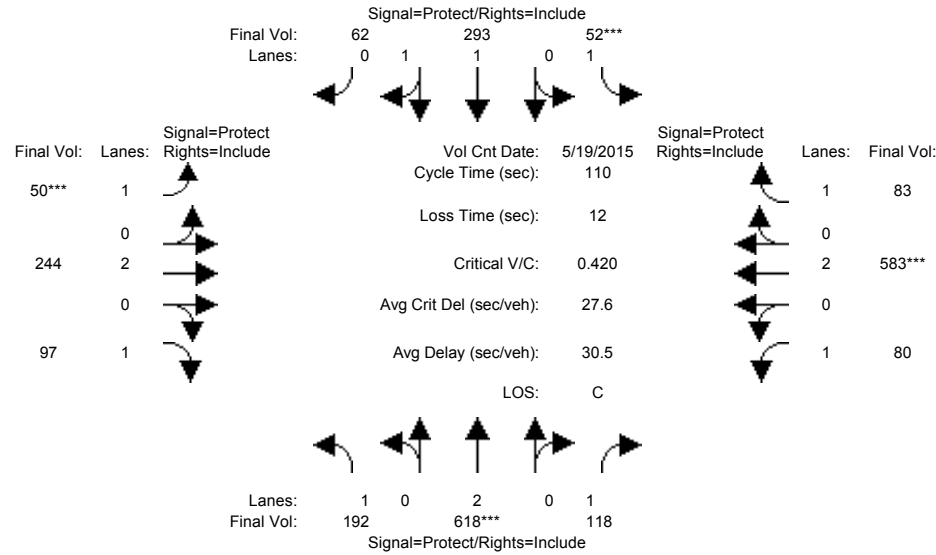

| Approach:  | North Bound |      |      | South Bound |      |      | East Bound |      |      | West Bound |      |      |
|--|-------------|------|------|-------------|------|------|------------|------|------|------------|------|------|
| Movement:  | L           | T    | R    | L           | T    | R    | L          | T    | R    | L          | T    | R    |
| Min. Green:  | 7           | 10   | 10   | 7           | 10   | 10   | 7          | 10   | 10   | 7          | 10   | 10   |
| Y+R:   | 4.0         | 4.0  | 4.0  | 4.0         | 4.0  | 4.0  | 4.0        | 4.0  | 4.0  | 4.0        | 4.0  | 4.0  |
| Volume Module: >> Count Date: 19 May 2015 << 7:45-8:45AM |             |      |      |             |      |      |            |      |      |            |      |      |
| Base Vol:  | 192         | 618  | 118  | 52          | 293  | 62   | 50         | 244  | 97   | 80         | 583  | 83   |
| Growth Adj:  | 1.00        | 1.00 | 1.00 | 1.00        | 1.00 | 1.00 | 1.00       | 1.00 | 1.00 | 1.00       | 1.00 | 1.00 |
| Initial Bse:   | 192         | 618  | 118  | 52          | 293  | 62   | 50         | 244  | 97   | 80         | 583  | 83   |
| Added Vol:   | 0           | 0    | 0    | 0           | 0    | 0    | 0          | 0    | 0    | 0          | 0    | 0    |
| PasserByVol:   | 0           | 0    | 0    | 0           | 0    | 0    | 0          | 0    | 0    | 0          | 0    | 0    |
| Initial Fut:   | 192         | 618  | 118  | 52          | 293  | 62   | 50         | 244  | 97   | 80         | 583  | 83   |
| User Adj:  | 1.00        | 1.00 | 1.00 | 1.00        | 1.00 | 1.00 | 1.00       | 1.00 | 1.00 | 1.00       | 1.00 | 1.00 |
| PHF Adj:   | 1.00        | 1.00 | 1.00 | 1.00        | 1.00 | 1.00 | 1.00       | 1.00 | 1.00 | 1.00       | 1.00 | 1.00 |
| PHF Volume:  | 192         | 618  | 118  | 52          | 293  | 62   | 50         | 244  | 97   | 80         | 583  | 83   |
| Reduct Vol:  | 0           | 0    | 0    | 0           | 0    | 0    | 0          | 0    | 0    | 0          | 0    | 0    |
| Reduced Vol:   | 192         | 618  | 118  | 52          | 293  | 62   | 50         | 244  | 97   | 80         | 583  | 83   |
| PCE Adj:   | 1.00        | 1.00 | 1.00 | 1.00        | 1.00 | 1.00 | 1.00       | 1.00 | 1.00 | 1.00       | 1.00 | 1.00 |
| MLF Adj:   | 1.00        | 1.00 | 1.00 | 1.00        | 1.00 | 1.00 | 1.00       | 1.00 | 1.00 | 1.00       | 1.00 | 1.00 |
| Final Volume:  | 192         | 618  | 118  | 52          | 293  | 62   | 50         | 244  | 97   | 80         | 583  | 83   |
| Saturation Flow Module:                                  |             |      |      |             |      |      |            |      |      |            |      |      |
| Sat/Lane:  | 1900        | 1900 | 1900 | 1900        | 1900 | 1900 | 1900       | 1900 | 1900 | 1900       | 1900 | 1900 |
| Adjustment:  | 0.92        | 1.00 | 0.92 | 0.92        | 0.98 | 0.95 | 0.92       | 1.00 | 0.92 | 0.92       | 1.00 | 0.92 |
| Lanes:   | 1.00        | 2.00 | 1.00 | 1.00        | 1.64 | 0.36 | 1.00       | 2.00 | 1.00 | 1.00       | 2.00 | 1.00 |
| Final Sat.:  | 1750        | 3800 | 1750 | 1750        | 3053 | 646  | 1750       | 3800 | 1750 | 1750       | 3800 | 1750 |
| Capacity Analysis Module:                                |             |      |      |             |      |      |            |      |      |            |      |      |
| Vol/Sat:   | 0.11        | 0.16 | 0.07 | 0.03        | 0.10 | 0.10 | 0.03       | 0.06 | 0.06 | 0.05       | 0.15 | 0.05 |
| Crit Moves:  | ****        | **** | **** | ****        | **** | **** | ****       | **** | **** | ****       | **** | **** |
| Green Time:  | 26.9        | 42.6 | 42.6 | 7.8         | 23.5 | 23.5 | 7.5        | 28.0 | 28.0 | 19.6       | 40.2 | 40.2 |
| Volume/Cap:  | 0.45        | 0.42 | 0.17 | 0.42        | 0.45 | 0.45 | 0.42       | 0.25 | 0.22 | 0.26       | 0.42 | 0.13 |
| Delay/Veh:   | 36.0        | 24.9 | 22.3 | 51.2        | 38.0 | 38.0 | 51.6       | 32.8 | 32.6 | 39.3       | 26.4 | 23.4 |
| User DelAdj:   | 1.00        | 1.00 | 1.00 | 1.00        | 1.00 | 1.00 | 1.00       | 1.00 | 1.00 | 1.00       | 1.00 | 1.00 |
| AdjDel/Veh:  | 36.0        | 24.9 | 22.3 | 51.2        | 38.0 | 38.0 | 51.6       | 32.8 | 32.6 | 39.3       | 26.4 | 23.4 |
| LOS by Move:   | D           | C    | C    | D           | D    | D    | D          | C    | C    | D          | C    | C    |
| HCM2k95thQ:  | 11          | 14   | 5    | 4           | 10   | 10   | 4          | 6    | 5    | 5          | 14   | 4    |

Note: Queue reported is the number of cars per lane.



BART

Level Of Service Computation Report  
2000 HCM Operations (Future Volume Alternative)  
PM - Exist + Proj Conditions

Intersection #3064: ALUM ROCK/KING [Study Int 17]

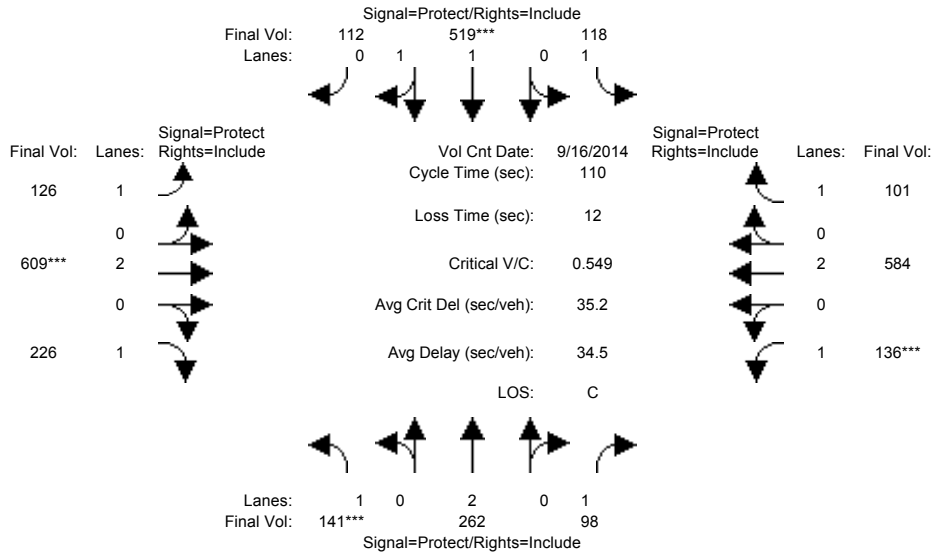

| Approach:   | North Bound |      |      | South Bound |      |      | East Bound |      |      | West Bound |      |      |
|---|-------------|------|------|-------------|------|------|------------|------|------|------------|------|------|
| Movement:   | L           | T    | R    | L           | T    | R    | L          | T    | R    | L          | T    | R    |
| Min. Green:   | 7           | 10   | 10   | 7           | 10   | 10   | 7          | 10   | 10   | 7          | 10   | 10   |
| Y+R:  | 4.0         | 4.0  | 4.0  | 4.0         | 4.0  | 4.0  | 4.0        | 4.0  | 4.0  | 4.0        | 4.0  | 4.0  |
| Volume Module: >> Count Date: 16 Sep 2014 << 5:00 - 6:00 PM |             |      |      |             |      |      |            |      |      |            |      |      |
| Base Vol:   | 141         | 262  | 98   | 118         | 519  | 112  | 126        | 609  | 226  | 136        | 584  | 101  |
| Growth Adj:   | 1.00        | 1.00 | 1.00 | 1.00        | 1.00 | 1.00 | 1.00       | 1.00 | 1.00 | 1.00       | 1.00 | 1.00 |
| Initial Bse:  | 141         | 262  | 98   | 118         | 519  | 112  | 126        | 609  | 226  | 136        | 584  | 101  |
| Added Vol:  | 0           | 0    | 0    | 0           | 0    | 0    | 0          | 0    | 0    | 0          | 0    | 0    |
| PasserByVol:  | 0           | 0    | 0    | 0           | 0    | 0    | 0          | 0    | 0    | 0          | 0    | 0    |
| Initial Fut:  | 141         | 262  | 98   | 118         | 519  | 112  | 126        | 609  | 226  | 136        | 584  | 101  |
| User Adj:   | 1.00        | 1.00 | 1.00 | 1.00        | 1.00 | 1.00 | 1.00       | 1.00 | 1.00 | 1.00       | 1.00 | 1.00 |
| PHF Adj:  | 1.00        | 1.00 | 1.00 | 1.00        | 1.00 | 1.00 | 1.00       | 1.00 | 1.00 | 1.00       | 1.00 | 1.00 |
| PHF Volume:   | 141         | 262  | 98   | 118         | 519  | 112  | 126        | 609  | 226  | 136        | 584  | 101  |
| Reduct Vol:   | 0           | 0    | 0    | 0           | 0    | 0    | 0          | 0    | 0    | 0          | 0    | 0    |
| Reduced Vol:  | 141         | 262  | 98   | 118         | 519  | 112  | 126        | 609  | 226  | 136        | 584  | 101  |
| PCE Adj:  | 1.00        | 1.00 | 1.00 | 1.00        | 1.00 | 1.00 | 1.00       | 1.00 | 1.00 | 1.00       | 1.00 | 1.00 |
| MLF Adj:  | 1.00        | 1.00 | 1.00 | 1.00        | 1.00 | 1.00 | 1.00       | 1.00 | 1.00 | 1.00       | 1.00 | 1.00 |
| Final Volume:   | 141         | 262  | 98   | 118         | 519  | 112  | 126        | 609  | 226  | 136        | 584  | 101  |
| Saturation Flow Module:                                     |             |      |      |             |      |      |            |      |      |            |      |      |
| Sat/Lane:   | 1900        | 1900 | 1900 | 1900        | 1900 | 1900 | 1900       | 1900 | 1900 | 1900       | 1900 | 1900 |
| Adjustment:   | 0.92        | 1.00 | 0.92 | 0.92        | 0.98 | 0.95 | 0.92       | 1.00 | 0.92 | 0.92       | 1.00 | 0.92 |
| Lanes:  | 1.00        | 2.00 | 1.00 | 1.00        | 1.64 | 0.36 | 1.00       | 2.00 | 1.00 | 1.00       | 2.00 | 1.00 |
| Final Sat.:   | 1750        | 3800 | 1750 | 1750        | 3043 | 657  | 1750       | 3800 | 1750 | 1750       | 3800 | 1750 |
| Capacity Analysis Module:                                   |             |      |      |             |      |      |            |      |      |            |      |      |
| Vol/Sat:  | 0.08        | 0.07 | 0.06 | 0.07        | 0.17 | 0.17 | 0.07       | 0.16 | 0.13 | 0.08       | 0.15 | 0.06 |
| Crit Moves:   | ****        |      |      | ****        |      |      | ****       |      |      | ****       |      |      |
| Green Time:   | 16.1        | 28.9 | 28.9 | 21.4        | 34.2 | 34.2 | 15.2       | 32.1 | 32.1 | 15.6       | 32.5 | 32.5 |
| Volume/Cap:   | 0.55        | 0.26 | 0.21 | 0.35        | 0.55 | 0.55 | 0.52       | 0.55 | 0.44 | 0.55       | 0.52 | 0.20 |
| Delay/Veh:  | 46.1        | 32.3 | 31.9 | 38.9        | 32.1 | 32.1 | 46.0       | 33.4 | 32.3 | 46.6       | 32.7 | 29.2 |
| User DelAdj:  | 1.00        | 1.00 | 1.00 | 1.00        | 1.00 | 1.00 | 1.00       | 1.00 | 1.00 | 1.00       | 1.00 | 1.00 |
| AdjDel/Veh:   | 46.1        | 32.3 | 31.9 | 38.9        | 32.1 | 32.1 | 46.0       | 33.4 | 32.3 | 46.6       | 32.7 | 29.2 |
| LOS by Move:  | D           | C    | C    | D           | C    | C    | D          | C    | C    | D          | C    | C    |
| HCM2k95thQ:   | 9           | 7    | 5    | 7           | 17   | 17   | 8          | 16   | 13   | 10         | 16   | 6    |

Note: Queue reported is the number of cars per lane.

BART

Level Of Service Computation Report  
2000 HCM Operations (Future Volume Alternative)  
AM - Exist + Proj Conditions

Intersection #3210: 101/Julian-McKee (W) [Study Int 4]

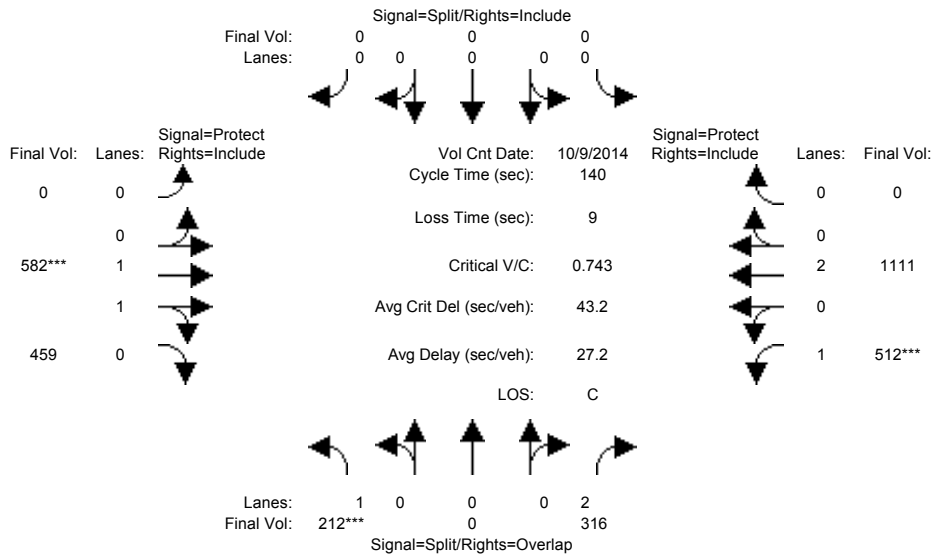

| Approach:                                   | North Bound |      |      | South Bound |      |      | East Bound |      |      | West Bound |      |      |
|---|-------------|------|------|-------------|------|------|------------|------|------|------------|------|------|
| Movement:                                   | L           | T    | R    | L           | T    | R    | L          | T    | R    | L          | T    | R    |
| Min. Green:                                 | 10          | 0    | 10   | 0           | 0    | 0    | 0          | 10   | 10   | 7          | 10   | 0    |
| Y+R:  | 4.0         | 4.0  | 4.0  | 4.0         | 4.0  | 4.0  | 4.0        | 4.0  | 4.0  | 4.0        | 4.0  | 4.0  |
| -----                                       |             |      |      |             |      |      |            |      |      |            |      |      |
| Volume Module: >> Count Date: 9 Oct 2014 << |             |      |      |             |      |      |            |      |      |            |      |      |
| Base Vol:                                   | 212         | 0    | 316  | 0           | 0    | 0    | 0          | 582  | 459  | 512        | 1111 | 0    |
| Growth Adj:                                 | 1.00        | 1.00 | 1.00 | 1.00        | 1.00 | 1.00 | 1.00       | 1.00 | 1.00 | 1.00       | 1.00 | 1.00 |
| Initial Bse:                                | 212         | 0    | 316  | 0           | 0    | 0    | 0          | 582  | 459  | 512        | 1111 | 0    |
| Added Vol:                                  | 0           | 0    | 0    | 0           | 0    | 0    | 0          | 0    | 0    | 0          | 0    | 0    |
| PasserByVol:                                | 0           | 0    | 0    | 0           | 0    | 0    | 0          | 0    | 0    | 0          | 0    | 0    |
| Initial Fut:                                | 212         | 0    | 316  | 0           | 0    | 0    | 0          | 582  | 459  | 512        | 1111 | 0    |
| User Adj:                                   | 1.00        | 1.00 | 1.00 | 1.00        | 1.00 | 1.00 | 1.00       | 1.00 | 1.00 | 1.00       | 1.00 | 1.00 |
| PHF Adj:                                    | 1.00        | 1.00 | 1.00 | 1.00        | 1.00 | 1.00 | 1.00       | 1.00 | 1.00 | 1.00       | 1.00 | 1.00 |
| PHF Volume:                                 | 212         | 0    | 316  | 0           | 0    | 0    | 0          | 582  | 459  | 512        | 1111 | 0    |
| Reduct Vol:                                 | 0           | 0    | 0    | 0           | 0    | 0    | 0          | 0    | 0    | 0          | 0    | 0    |
| Reduced Vol:                                | 212         | 0    | 316  | 0           | 0    | 0    | 0          | 582  | 459  | 512        | 1111 | 0    |
| PCE Adj:                                    | 1.00        | 1.00 | 1.00 | 1.00        | 1.00 | 1.00 | 1.00       | 1.00 | 1.00 | 1.00       | 1.00 | 1.00 |
| MLF Adj:                                    | 1.00        | 1.00 | 1.00 | 1.00        | 1.00 | 1.00 | 1.00       | 1.00 | 1.00 | 1.00       | 1.00 | 1.00 |
| FinalVolume:                                | 212         | 0    | 316  | 0           | 0    | 0    | 0          | 582  | 459  | 512        | 1111 | 0    |
| -----                                       |             |      |      |             |      |      |            |      |      |            |      |      |
| Saturation Flow Module:                     |             |      |      |             |      |      |            |      |      |            |      |      |
| Sat/Lane:                                   | 1900        | 1900 | 1900 | 1900        | 1900 | 1900 | 1900       | 1900 | 1900 | 1900       | 1900 | 1900 |
| Adjustment:                                 | 0.92        | 1.00 | 0.83 | 0.92        | 1.00 | 0.92 | 0.92       | 0.99 | 0.95 | 0.92       | 1.00 | 0.92 |
| Lanes:                                      | 1.00        | 0.00 | 2.00 | 0.00        | 0.00 | 0.00 | 0.00       | 1.09 | 0.91 | 1.00       | 2.00 | 0.00 |
| Final Sat.:                                 | 1750        | 0    | 3150 | 0           | 0    | 0    | 0          | 2067 | 1630 | 1750       | 3800 | 0    |
| -----                                       |             |      |      |             |      |      |            |      |      |            |      |      |
| Capacity Analysis Module:                   |             |      |      |             |      |      |            |      |      |            |      |      |
| Vol/Sat:                                    | 0.12        | 0.00 | 0.10 | 0.00        | 0.00 | 0.00 | 0.00       | 0.28 | 0.28 | 0.29       | 0.29 | 0.00 |
| Crit Moves:                                 | ****        |      |      |             |      |      | ****       |      |      | ****       |      |      |
| Green Time:                                 | 22.8        | 0.0  | 78.0 | 0.0         | 0.0  | 0.0  | 0.0        | 53.0 | 53.0 | 55.1       | 108  | 0.0  |
| Volume/Cap:                                 | 0.74        | 0.00 | 0.18 | 0.00        | 0.00 | 0.00 | 0.00       | 0.74 | 0.74 | 0.74       | 0.38 | 0.00 |
| Delay/Veh:                                  | 65.9        | 0.0  | 15.3 | 0.0         | 0.0  | 0.0  | 0.0        | 39.8 | 39.8 | 40.7       | 5.2  | 0.0  |
| User DelAdj:                                | 1.00        | 1.00 | 1.00 | 1.00        | 1.00 | 1.00 | 1.00       | 1.00 | 1.00 | 1.00       | 1.00 | 1.00 |
| AdjDel/Veh:                                 | 65.9        | 0.0  | 15.3 | 0.0         | 0.0  | 0.0  | 0.0        | 39.8 | 39.8 | 40.7       | 5.2  | 0.0  |
| LOS by Move:                                | E           | A    | B    | A           | A    | A    | A          | D    | D    | D          | A    | A    |
| HCM2k95thQ:                                 | 20          | 0    | 8    | 0           | 0    | 0    | 0          | 33   | 33   | 36         | 14   | 0    |

Note: Queue reported is the number of cars per lane.

BART

Level Of Service Computation Report  
 2000 HCM Operations (Future Volume Alternative)  
 PM - Exist + Proj Conditions

Intersection #3210: 101/Julian-McKee (W) [Study Int 4]

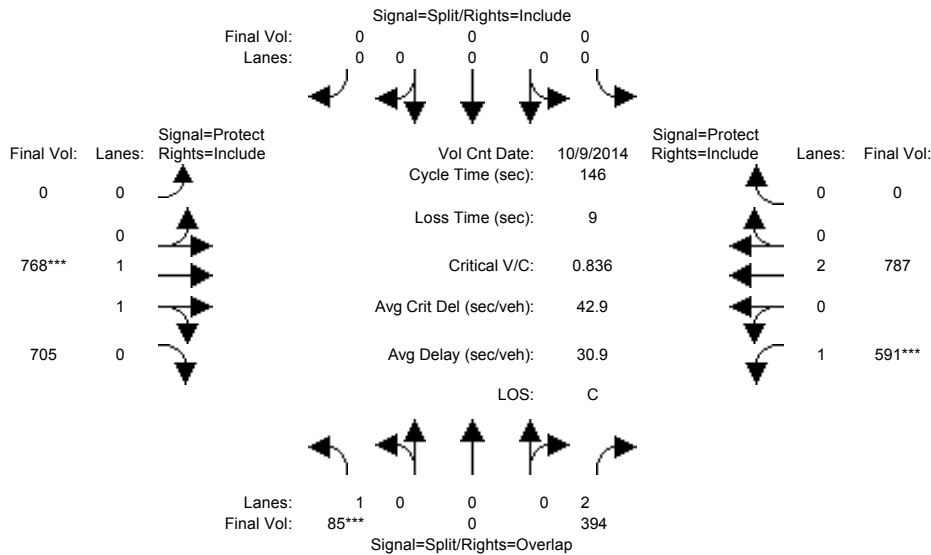

| Approach:                                   | North Bound |      |      | South Bound |      |      | East Bound |      |      | West Bound |      |      |
|---|-------------|------|------|-------------|------|------|------------|------|------|------------|------|------|
| Movement:                                   | L           | T    | R    | L           | T    | R    | L          | T    | R    | L          | T    | R    |
| Min. Green:                                 | 10          | 0    | 10   | 0           | 0    | 0    | 0          | 10   | 10   | 7          | 10   | 0    |
| Y+R:  | 4.0         | 4.0  | 4.0  | 4.0         | 4.0  | 4.0  | 4.0        | 4.0  | 4.0  | 4.0        | 4.0  | 4.0  |
| -----                                       |             |      |      |             |      |      |            |      |      |            |      |      |
| Volume Module: >> Count Date: 9 Oct 2014 << |             |      |      |             |      |      |            |      |      |            |      |      |
| Base Vol:                                   | 85          | 0    | 394  | 0           | 0    | 0    | 0          | 768  | 705  | 591        | 787  | 0    |
| Growth Adj:                                 | 1.00        | 1.00 | 1.00 | 1.00        | 1.00 | 1.00 | 1.00       | 1.00 | 1.00 | 1.00       | 1.00 | 1.00 |
| Initial Bse:                                | 85          | 0    | 394  | 0           | 0    | 0    | 0          | 768  | 705  | 591        | 787  | 0    |
| Added Vol:                                  | 0           | 0    | 0    | 0           | 0    | 0    | 0          | 0    | 0    | 0          | 0    | 0    |
| PasserByVol:                                | 0           | 0    | 0    | 0           | 0    | 0    | 0          | 0    | 0    | 0          | 0    | 0    |
| Initial Fut:                                | 85          | 0    | 394  | 0           | 0    | 0    | 0          | 768  | 705  | 591        | 787  | 0    |
| User Adj:                                   | 1.00        | 1.00 | 1.00 | 1.00        | 1.00 | 1.00 | 1.00       | 1.00 | 1.00 | 1.00       | 1.00 | 1.00 |
| PHF Adj:                                    | 1.00        | 1.00 | 1.00 | 1.00        | 1.00 | 1.00 | 1.00       | 1.00 | 1.00 | 1.00       | 1.00 | 1.00 |
| PHF Volume:                                 | 85          | 0    | 394  | 0           | 0    | 0    | 0          | 768  | 705  | 591        | 787  | 0    |
| Reduct Vol:                                 | 0           | 0    | 0    | 0           | 0    | 0    | 0          | 0    | 0    | 0          | 0    | 0    |
| Reduced Vol:                                | 85          | 0    | 394  | 0           | 0    | 0    | 0          | 768  | 705  | 591        | 787  | 0    |
| PCE Adj:                                    | 1.00        | 1.00 | 1.00 | 1.00        | 1.00 | 1.00 | 1.00       | 1.00 | 1.00 | 1.00       | 1.00 | 1.00 |
| MLF Adj:                                    | 1.00        | 1.00 | 1.00 | 1.00        | 1.00 | 1.00 | 1.00       | 1.00 | 1.00 | 1.00       | 1.00 | 1.00 |
| FinalVolume:                                | 85          | 0    | 394  | 0           | 0    | 0    | 0          | 768  | 705  | 591        | 787  | 0    |
| -----                                       |             |      |      |             |      |      |            |      |      |            |      |      |
| Saturation Flow Module:                     |             |      |      |             |      |      |            |      |      |            |      |      |
| Sat/Lane:                                   | 1900        | 1900 | 1900 | 1900        | 1900 | 1900 | 1900       | 1900 | 1900 | 1900       | 1900 | 1900 |
| Adjustment:                                 | 0.92        | 1.00 | 0.83 | 0.92        | 1.00 | 0.92 | 0.92       | 1.00 | 0.95 | 0.92       | 1.00 | 0.92 |
| Lanes:                                      | 1.00        | 0.00 | 2.00 | 0.00        | 0.00 | 0.00 | 0.00       | 1.02 | 0.98 | 1.00       | 2.00 | 0.00 |
| Final Sat.:                                 | 1750        | 0    | 3150 | 0           | 0    | 0    | 0          | 1928 | 1770 | 1750       | 3800 | 0    |
| -----                                       |             |      |      |             |      |      |            |      |      |            |      |      |
| Capacity Analysis Module:                   |             |      |      |             |      |      |            |      |      |            |      |      |
| Vol/Sat:                                    | 0.05        | 0.00 | 0.13 | 0.00        | 0.00 | 0.00 | 0.00       | 0.40 | 0.40 | 0.34       | 0.21 | 0.00 |
| Crit Moves:                                 | ****        |      |      |             |      |      | ****       |      |      | ****       |      |      |
| Green Time:                                 | 10.0        | 0.0  | 68.3 | 0.0         | 0.0  | 0.0  | 0.0        | 68.7 | 68.7 | 58.3       | 127  | 0.0  |
| Volume/Cap:                                 | 0.71        | 0.00 | 0.27 | 0.00        | 0.00 | 0.00 | 0.00       | 0.85 | 0.85 | 0.85       | 0.24 | 0.00 |
| Delay/Veh:                                  | 84.4        | 0.0  | 23.7 | 0.0         | 0.0  | 0.0  | 0.0        | 38.0 | 38.0 | 49.2       | 1.6  | 0.0  |
| User DelAdj:                                | 1.00        | 1.00 | 1.00 | 1.00        | 1.00 | 1.00 | 1.00       | 1.00 | 1.00 | 1.00       | 1.00 | 1.00 |
| AdjDel/Veh:                                 | 84.4        | 0.0  | 23.7 | 0.0         | 0.0  | 0.0  | 0.0        | 38.0 | 38.0 | 49.2       | 1.6  | 0.0  |
| LOS by Move:                                | F           | A    | C    | A           | A    | A    | A          | D    | D    | D          | A    | A    |
| HCM2k95thQ:                                 | 11          | 0    | 12   | 0           | 0    | 0    | 0          | 49   | 49   | 45         | 6    | 0    |

Note: Queue reported is the number of cars per lane.

BART

Level Of Service Computation Report  
 2000 HCM Operations (Future Volume Alternative)  
 AM - Exist + Proj Conditions

Intersection #3211: 101/McKee(E) [Study Int 5]

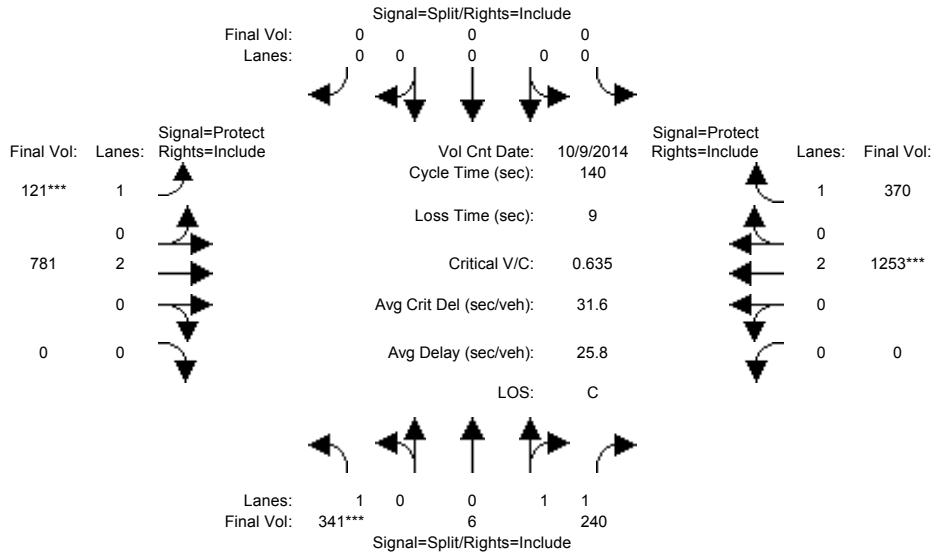

| Approach:                                   | North Bound |      |      | South Bound |      |      | East Bound |      |      | West Bound |      |      |
|---|-------------|------|------|-------------|------|------|------------|------|------|------------|------|------|
| Movement:                                   | L           | T    | R    | L           | T    | R    | L          | T    | R    | L          | T    | R    |
| Min. Green:                                 | 10          | 10   | 10   | 0           | 0    | 0    | 7          | 10   | 0    | 0          | 10   | 10   |
| Y+R:  | 4.0         | 4.0  | 4.0  | 4.0         | 4.0  | 4.0  | 4.0        | 4.0  | 4.0  | 4.0        | 4.0  | 4.0  |
| Volume Module: >> Count Date: 9 Oct 2014 << |             |      |      |             |      |      |            |      |      |            |      |      |
| Base Vol:                                   | 341         | 6    | 240  | 0           | 0    | 0    | 121        | 781  | 0    | 0          | 1253 | 370  |
| Growth Adj:                                 | 1.00        | 1.00 | 1.00 | 1.00        | 1.00 | 1.00 | 1.00       | 1.00 | 1.00 | 1.00       | 1.00 | 1.00 |
| Initial Bse:                                | 341         | 6    | 240  | 0           | 0    | 0    | 121        | 781  | 0    | 0          | 1253 | 370  |
| Added Vol:                                  | 0           | 0    | 0    | 0           | 0    | 0    | 0          | 0    | 0    | 0          | 0    | 0    |
| PasserByVol:                                | 0           | 0    | 0    | 0           | 0    | 0    | 0          | 0    | 0    | 0          | 0    | 0    |
| Initial Fut:                                | 341         | 6    | 240  | 0           | 0    | 0    | 121        | 781  | 0    | 0          | 1253 | 370  |
| User Adj:                                   | 1.00        | 1.00 | 1.00 | 1.00        | 1.00 | 1.00 | 1.00       | 1.00 | 1.00 | 1.00       | 1.00 | 1.00 |
| PHF Adj:                                    | 1.00        | 1.00 | 1.00 | 1.00        | 1.00 | 1.00 | 1.00       | 1.00 | 1.00 | 1.00       | 1.00 | 1.00 |
| PHF Volume:                                 | 341         | 6    | 240  | 0           | 0    | 0    | 121        | 781  | 0    | 0          | 1253 | 370  |
| Reduct Vol:                                 | 0           | 0    | 0    | 0           | 0    | 0    | 0          | 0    | 0    | 0          | 0    | 0    |
| Reduced Vol:                                | 341         | 6    | 240  | 0           | 0    | 0    | 121        | 781  | 0    | 0          | 1253 | 370  |
| PCE Adj:                                    | 1.00        | 1.00 | 1.00 | 1.00        | 1.00 | 1.00 | 1.00       | 1.00 | 1.00 | 1.00       | 1.00 | 1.00 |
| MLF Adj:                                    | 1.00        | 1.00 | 1.00 | 1.00        | 1.00 | 1.00 | 1.00       | 1.00 | 1.00 | 1.00       | 1.00 | 1.00 |
| FinalVolume:                                | 341         | 6    | 240  | 0           | 0    | 0    | 121        | 781  | 0    | 0          | 1253 | 370  |
| Saturation Flow Module:                     |             |      |      |             |      |      |            |      |      |            |      |      |
| Sat/Lane:                                   | 1900        | 1900 | 1900 | 1900        | 1900 | 1900 | 1900       | 1900 | 1900 | 1900       | 1900 | 1900 |
| Adjustment:                                 | 0.92        | 0.95 | 0.95 | 0.92        | 1.00 | 0.92 | 0.92       | 1.00 | 0.92 | 0.92       | 1.00 | 0.92 |
| Lanes:                                      | 1.00        | 0.05 | 1.95 | 0.00        | 0.00 | 0.00 | 1.00       | 2.00 | 0.00 | 0.00       | 2.00 | 1.00 |
| Final Sat.:                                 | 1750        | 88   | 3512 | 0           | 0    | 0    | 1750       | 3800 | 0    | 0          | 3800 | 1750 |
| Capacity Analysis Module:                   |             |      |      |             |      |      |            |      |      |            |      |      |
| Vol/Sat:                                    | 0.19        | 0.07 | 0.07 | 0.00        | 0.00 | 0.00 | 0.07       | 0.21 | 0.00 | 0.00       | 0.33 | 0.21 |
| Crit Moves:                                 | ****        |      |      |             |      |      | ****       |      |      | ****       |      |      |
| Green Time:                                 | 43.0        | 43.0 | 43.0 | 0.0         | 0.0  | 0.0  | 15.3       | 88.0 | 0.0  | 0.0        | 72.8 | 72.8 |
| Volume/Cap:                                 | 0.63        | 0.22 | 0.22 | 0.00        | 0.00 | 0.00 | 0.63       | 0.33 | 0.00 | 0.00       | 0.63 | 0.41 |
| Delay/Veh:                                  | 44.2        | 36.2 | 36.2 | 0.0         | 0.0  | 0.0  | 66.6       | 12.2 | 0.0  | 0.0        | 24.8 | 20.8 |
| User DelAdj:                                | 1.00        | 1.00 | 1.00 | 1.00        | 1.00 | 1.00 | 1.00       | 1.00 | 1.00 | 1.00       | 1.00 | 1.00 |
| AdjDel/Veh:                                 | 44.2        | 36.2 | 36.2 | 0.0         | 0.0  | 0.0  | 66.6       | 12.2 | 0.0  | 0.0        | 24.8 | 20.8 |
| LOS by Move:                                | D           | D    | D    | A           | A    | A    | E          | B    | A    | A          | C    | C    |
| HCM2k95thQ:                                 | 25          | 8    | 8    | 0           | 0    | 0    | 12         | 14   | 0    | 0          | 32   | 18   |

Note: Queue reported is the number of cars per lane.

BART

Level Of Service Computation Report  
 2000 HCM Operations (Future Volume Alternative)  
 PM - Exist + Proj Conditions

Intersection #3211: 101/McKee(E) [Study Int 5]

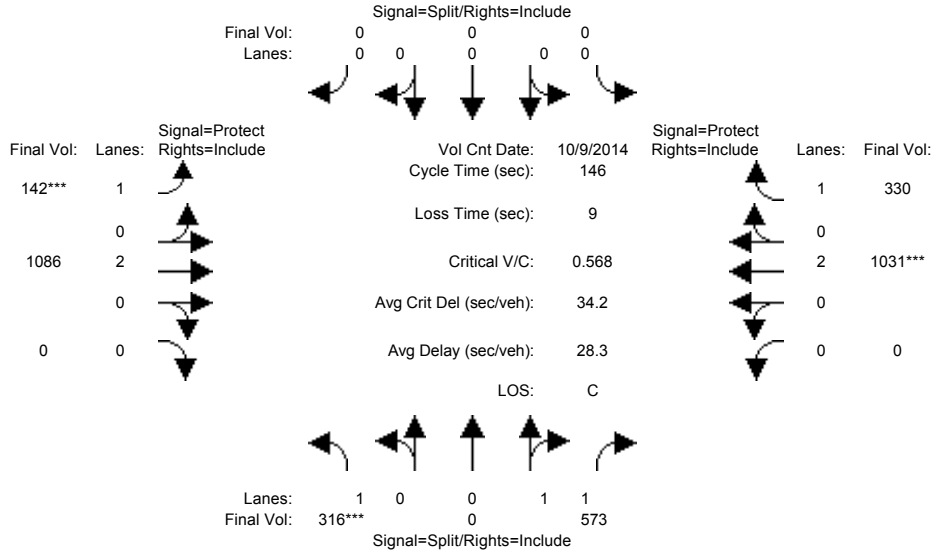

| Approach:                 | North Bound                  |      |      | South Bound |      |      | East Bound |      |      | West Bound |      |      |
|---------------------------|------------------------------|------|------|-------------|------|------|------------|------|------|------------|------|------|
| Movement:                 | L                            | T    | R    | L           | T    | R    | L          | T    | R    | L          | T    | R    |
| Min. Green:               | 10                           | 10   | 10   | 0           | 0    | 0    | 7          | 10   | 0    | 0          | 10   | 10   |
| Y+R:                      | 4.0                          | 4.0  | 4.0  | 4.0         | 4.0  | 4.0  | 4.0        | 4.0  | 4.0  | 4.0        | 4.0  | 4.0  |
| -----                     |                              |      |      |             |      |      |            |      |      |            |      |      |
| Volume Module:            | >> Count Date: 9 Oct 2014 << |      |      |             |      |      |            |      |      |            |      |      |
| Base Vol:                 | 316                          | 0    | 573  | 0           | 0    | 0    | 142        | 1086 | 0    | 0          | 1031 | 330  |
| Growth Adj:               | 1.00                         | 1.00 | 1.00 | 1.00        | 1.00 | 1.00 | 1.00       | 1.00 | 1.00 | 1.00       | 1.00 | 1.00 |
| Initial Bse:              | 316                          | 0    | 573  | 0           | 0    | 0    | 142        | 1086 | 0    | 0          | 1031 | 330  |
| Added Vol:                | 0                            | 0    | 0    | 0           | 0    | 0    | 0          | 0    | 0    | 0          | 0    | 0    |
| PasserByVol:              | 0                            | 0    | 0    | 0           | 0    | 0    | 0          | 0    | 0    | 0          | 0    | 0    |
| Initial Fut:              | 316                          | 0    | 573  | 0           | 0    | 0    | 142        | 1086 | 0    | 0          | 1031 | 330  |
| User Adj:                 | 1.00                         | 1.00 | 1.00 | 1.00        | 1.00 | 1.00 | 1.00       | 1.00 | 1.00 | 1.00       | 1.00 | 1.00 |
| PHF Adj:                  | 1.00                         | 1.00 | 1.00 | 1.00        | 1.00 | 1.00 | 1.00       | 1.00 | 1.00 | 1.00       | 1.00 | 1.00 |
| PHF Volume:               | 316                          | 0    | 573  | 0           | 0    | 0    | 142        | 1086 | 0    | 0          | 1031 | 330  |
| Reduct Vol:               | 0                            | 0    | 0    | 0           | 0    | 0    | 0          | 0    | 0    | 0          | 0    | 0    |
| Reduced Vol:              | 316                          | 0    | 573  | 0           | 0    | 0    | 142        | 1086 | 0    | 0          | 1031 | 330  |
| PCE Adj:                  | 1.00                         | 1.00 | 1.00 | 1.00        | 1.00 | 1.00 | 1.00       | 1.00 | 1.00 | 1.00       | 1.00 | 1.00 |
| MLF Adj:                  | 1.00                         | 1.00 | 1.00 | 1.00        | 1.00 | 1.00 | 1.00       | 1.00 | 1.00 | 1.00       | 1.00 | 1.00 |
| Final Volume:             | 316                          | 0    | 573  | 0           | 0    | 0    | 142        | 1086 | 0    | 0          | 1031 | 330  |
| -----                     |                              |      |      |             |      |      |            |      |      |            |      |      |
| Saturation Flow Module:   |                              |      |      |             |      |      |            |      |      |            |      |      |
| Sat/Lane:                 | 1900                         | 1900 | 1900 | 1900        | 1900 | 1900 | 1900       | 1900 | 1900 | 1900       | 1900 | 1900 |
| Adjustment:               | 0.92                         | 1.00 | 0.95 | 0.92        | 1.00 | 0.92 | 0.92       | 1.00 | 0.92 | 0.92       | 1.00 | 0.92 |
| Lanes:                    | 1.00                         | 0.00 | 2.00 | 0.00        | 0.00 | 0.00 | 1.00       | 2.00 | 0.00 | 0.00       | 2.00 | 1.00 |
| Final Sat.:               | 1750                         | 0    | 3600 | 0           | 0    | 0    | 1750       | 3800 | 0    | 0          | 3800 | 1750 |
| -----                     |                              |      |      |             |      |      |            |      |      |            |      |      |
| Capacity Analysis Module: |                              |      |      |             |      |      |            |      |      |            |      |      |
| Vol/Sat:                  | 0.18                         | 0.00 | 0.16 | 0.00        | 0.00 | 0.00 | 0.08       | 0.29 | 0.00 | 0.00       | 0.27 | 0.19 |
| Crit Moves:               | ****                         |      |      | ****        |      |      | ****       |      |      | ****       |      |      |
| Green Time:               | 46.4                         | 0.0  | 46.4 | 0.0         | 0.0  | 0.0  | 20.9       | 90.6 | 0.0  | 0.0        | 69.7 | 69.7 |
| Volume/Cap:               | 0.57                         | 0.00 | 0.50 | 0.00        | 0.00 | 0.00 | 0.57       | 0.46 | 0.00 | 0.00       | 0.57 | 0.39 |
| Delay/Veh:                | 42.8                         | 0.0  | 40.7 | 0.0         | 0.0  | 0.0  | 61.4       | 14.9 | 0.0  | 0.0        | 27.8 | 24.9 |
| User DelAdj:              | 1.00                         | 1.00 | 1.00 | 1.00        | 1.00 | 1.00 | 1.00       | 1.00 | 1.00 | 1.00       | 1.00 | 1.00 |
| AdjDel/Veh:               | 42.8                         | 0.0  | 40.7 | 0.0         | 0.0  | 0.0  | 61.4       | 14.9 | 0.0  | 0.0        | 27.8 | 24.9 |
| LOS by Move:              | D                            | A    | D    | A           | A    | A    | E          | B    | A    | A          | C    | C    |
| HCM2k95thQ:               | 23                           | 0    | 20   | 0           | 0    | 0    | 13         | 23   | 0    | 0          | 28   | 18   |

Note: Queue reported is the number of cars per lane.

BART

Level Of Service Computation Report  
 2000 HCM Operations (Future Volume Alternative)  
 AM - Exist + Proj Conditions

Intersection #3260: ALUM ROCK/33rd [Study Int 16]

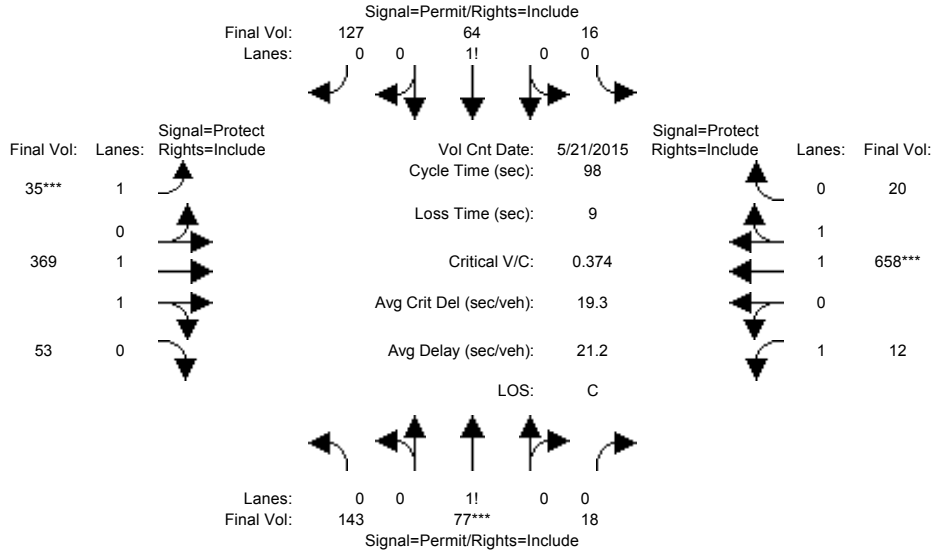

| Approach:  | North Bound |      |      | South Bound |      |      | East Bound |      |      | West Bound |      |      |
|--|-------------|------|------|-------------|------|------|------------|------|------|------------|------|------|
| Movement:  | L           | T    | R    | L           | T    | R    | L          | T    | R    | L          | T    | R    |
| Min. Green:  | 10          | 10   | 10   | 10          | 10   | 10   | 7          | 10   | 10   | 7          | 10   | 10   |
| Y+R:   | 4.0         | 4.0  | 4.0  | 4.0         | 4.0  | 4.0  | 4.0        | 4.0  | 4.0  | 4.0        | 4.0  | 4.0  |
| Volume Module: >> Count Date: 21 May 2015 << 7:30-8:30AM |             |      |      |             |      |      |            |      |      |            |      |      |
| Base Vol:  | 143         | 77   | 18   | 16          | 64   | 127  | 35         | 369  | 53   | 12         | 658  | 20   |
| Growth Adj:  | 1.00        | 1.00 | 1.00 | 1.00        | 1.00 | 1.00 | 1.00       | 1.00 | 1.00 | 1.00       | 1.00 | 1.00 |
| Initial Bse:   | 143         | 77   | 18   | 16          | 64   | 127  | 35         | 369  | 53   | 12         | 658  | 20   |
| Added Vol:   | 0           | 0    | 0    | 0           | 0    | 0    | 0          | 0    | 0    | 0          | 0    | 0    |
| PasserByVol:   | 0           | 0    | 0    | 0           | 0    | 0    | 0          | 0    | 0    | 0          | 0    | 0    |
| Initial Fut:   | 143         | 77   | 18   | 16          | 64   | 127  | 35         | 369  | 53   | 12         | 658  | 20   |
| User Adj:  | 1.00        | 1.00 | 1.00 | 1.00        | 1.00 | 1.00 | 1.00       | 1.00 | 1.00 | 1.00       | 1.00 | 1.00 |
| PHF Adj:   | 1.00        | 1.00 | 1.00 | 1.00        | 1.00 | 1.00 | 1.00       | 1.00 | 1.00 | 1.00       | 1.00 | 1.00 |
| PHF Volume:  | 143         | 77   | 18   | 16          | 64   | 127  | 35         | 369  | 53   | 12         | 658  | 20   |
| Reduct Vol:  | 0           | 0    | 0    | 0           | 0    | 0    | 0          | 0    | 0    | 0          | 0    | 0    |
| Reduced Vol:   | 143         | 77   | 18   | 16          | 64   | 127  | 35         | 369  | 53   | 12         | 658  | 20   |
| PCE Adj:   | 1.00        | 1.00 | 1.00 | 1.00        | 1.00 | 1.00 | 1.00       | 1.00 | 1.00 | 1.00       | 1.00 | 1.00 |
| MLF Adj:   | 1.00        | 1.00 | 1.00 | 1.00        | 1.00 | 1.00 | 1.00       | 1.00 | 1.00 | 1.00       | 1.00 | 1.00 |
| Final Volume:  | 143         | 77   | 18   | 16          | 64   | 127  | 35         | 369  | 53   | 12         | 658  | 20   |
| Saturation Flow Module:                                  |             |      |      |             |      |      |            |      |      |            |      |      |
| Sat/Lane:  | 1900        | 1900 | 1900 | 1900        | 1900 | 1900 | 1900       | 1900 | 1900 | 1900       | 1900 | 1900 |
| Adjustment:  | 0.92        | 0.92 | 0.92 | 0.92        | 0.92 | 0.92 | 0.92       | 0.98 | 0.95 | 0.92       | 0.97 | 0.95 |
| Lanes:   | 0.60        | 0.32 | 0.08 | 0.08        | 0.31 | 0.61 | 1.00       | 1.74 | 0.26 | 1.00       | 1.94 | 0.06 |
| Final Sat.:  | 1051        | 566  | 132  | 135         | 541  | 1074 | 1750       | 3235 | 465  | 1750       | 3591 | 109  |
| Capacity Analysis Module:                                |             |      |      |             |      |      |            |      |      |            |      |      |
| Vol/Sat:   | 0.14        | 0.14 | 0.14 | 0.12        | 0.12 | 0.12 | 0.02       | 0.11 | 0.11 | 0.01       | 0.18 | 0.18 |
| Crit Moves:  | ****        |      |      | ****        |      |      | ****       |      |      | ****       |      |      |
| Green Time:  | 34.9        | 34.9 | 34.9 | 34.9        | 34.9 | 34.9 | 7.0        | 33.2 | 33.2 | 20.8       | 47.1 | 47.1 |
| Volume/Cap:  | 0.38        | 0.38 | 0.38 | 0.33        | 0.33 | 0.33 | 0.28       | 0.34 | 0.34 | 0.03       | 0.38 | 0.38 |
| Delay/Veh:   | 23.9        | 23.9 | 23.9 | 23.3        | 23.3 | 23.3 | 44.3       | 24.3 | 24.3 | 30.6       | 16.3 | 16.3 |
| User DelAdj:   | 1.00        | 1.00 | 1.00 | 1.00        | 1.00 | 1.00 | 1.00       | 1.00 | 1.00 | 1.00       | 1.00 | 1.00 |
| AdjDel/Veh:  | 23.9        | 23.9 | 23.9 | 23.3        | 23.3 | 23.3 | 44.3       | 24.3 | 24.3 | 30.6       | 16.3 | 16.3 |
| LOS by Move:   | C           | C    | C    | C           | C    | C    | D          | C    | C    | C          | B    | B    |
| HCM2k95thQ:  | 11          | 11   | 11   | 9           | 9    | 9    | 2          | 9    | 9    | 1          | 12   | 12   |

Note: Queue reported is the number of cars per lane.

BART

Level Of Service Computation Report  
 2000 HCM Operations (Future Volume Alternative)  
 PM - Exist + Proj Conditions

Intersection #3260: ALUM ROCK/33rd [Study Int 16]

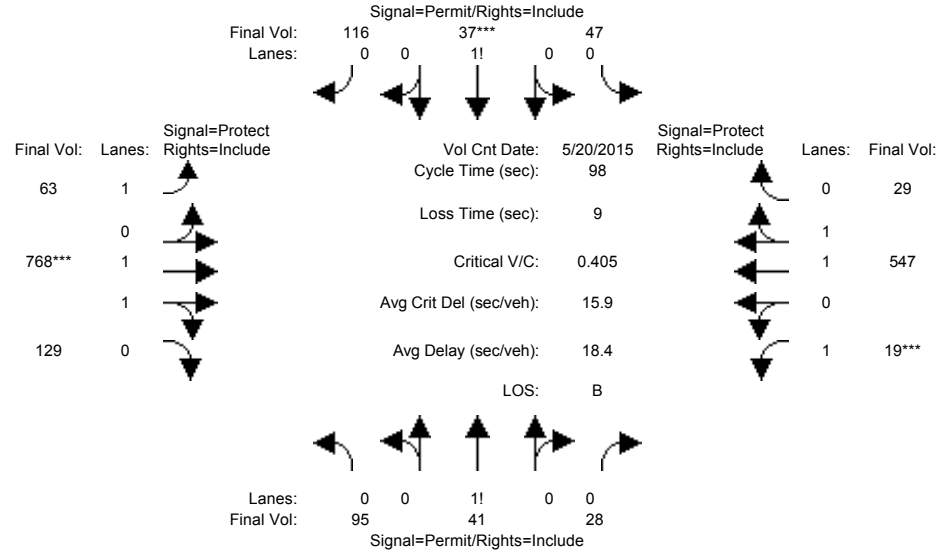

| Approach:                 | North Bound                               |      |      | South Bound |      |      | East Bound |      |      | West Bound |      |      |
|---------------------------|---|------|------|-------------|------|------|------------|------|------|------------|------|------|
| Movement:                 | L   | T    | R    | L           | T    | R    | L          | T    | R    | L          | T    | R    |
| Min. Green:               | 10  | 10   | 10   | 10          | 10   | 10   | 7          | 10   | 10   | 7          | 10   | 10   |
| Y+R:                      | 4.0                                       | 4.0  | 4.0  | 4.0         | 4.0  | 4.0  | 4.0        | 4.0  | 4.0  | 4.0        | 4.0  | 4.0  |
| Volume Module:            | >> Count Date: 20 May 2015 << 4:15-5:15PM |      |      |             |      |      |            |      |      |            |      |      |
| Base Vol:                 | 95  | 41   | 28   | 47          | 37   | 116  | 63         | 768  | 129  | 19         | 547  | 29   |
| Growth Adj:               | 1.00                                      | 1.00 | 1.00 | 1.00        | 1.00 | 1.00 | 1.00       | 1.00 | 1.00 | 1.00       | 1.00 | 1.00 |
| Initial Bse:              | 95  | 41   | 28   | 47          | 37   | 116  | 63         | 768  | 129  | 19         | 547  | 29   |
| Added Vol:                | 0   | 0    | 0    | 0           | 0    | 0    | 0          | 0    | 0    | 0          | 0    | 0    |
| PasserByVol:              | 0   | 0    | 0    | 0           | 0    | 0    | 0          | 0    | 0    | 0          | 0    | 0    |
| Initial Fut:              | 95  | 41   | 28   | 47          | 37   | 116  | 63         | 768  | 129  | 19         | 547  | 29   |
| User Adj:                 | 1.00                                      | 1.00 | 1.00 | 1.00        | 1.00 | 1.00 | 1.00       | 1.00 | 1.00 | 1.00       | 1.00 | 1.00 |
| PHF Adj:                  | 1.00                                      | 1.00 | 1.00 | 1.00        | 1.00 | 1.00 | 1.00       | 1.00 | 1.00 | 1.00       | 1.00 | 1.00 |
| PHF Volume:               | 95  | 41   | 28   | 47          | 37   | 116  | 63         | 768  | 129  | 19         | 547  | 29   |
| Reduct Vol:               | 0   | 0    | 0    | 0           | 0    | 0    | 0          | 0    | 0    | 0          | 0    | 0    |
| Reduced Vol:              | 95  | 41   | 28   | 47          | 37   | 116  | 63         | 768  | 129  | 19         | 547  | 29   |
| PCE Adj:                  | 1.00                                      | 1.00 | 1.00 | 1.00        | 1.00 | 1.00 | 1.00       | 1.00 | 1.00 | 1.00       | 1.00 | 1.00 |
| MLF Adj:                  | 1.00                                      | 1.00 | 1.00 | 1.00        | 1.00 | 1.00 | 1.00       | 1.00 | 1.00 | 1.00       | 1.00 | 1.00 |
| Final Volume:             | 95  | 41   | 28   | 47          | 37   | 116  | 63         | 768  | 129  | 19         | 547  | 29   |
| Saturation Flow Module:   |   |      |      |             |      |      |            |      |      |            |      |      |
| Sat/Lane:                 | 1900                                      | 1900 | 1900 | 1900        | 1900 | 1900 | 1900       | 1900 | 1900 | 1900       | 1900 | 1900 |
| Adjustment:               | 0.92                                      | 0.92 | 0.92 | 0.92        | 0.92 | 0.92 | 0.92       | 0.98 | 0.95 | 0.92       | 0.98 | 0.95 |
| Lanes:                    | 0.58                                      | 0.25 | 0.17 | 0.23        | 0.19 | 0.58 | 1.00       | 1.70 | 0.30 | 1.00       | 1.90 | 0.10 |
| Final Sat.:               | 1014                                      | 438  | 299  | 411         | 324  | 1015 | 1750       | 3167 | 532  | 1750       | 3514 | 186  |
| Capacity Analysis Module: |   |      |      |             |      |      |            |      |      |            |      |      |
| Vol/Sat:                  | 0.09                                      | 0.09 | 0.09 | 0.11        | 0.11 | 0.11 | 0.04       | 0.24 | 0.24 | 0.01       | 0.16 | 0.16 |
| Crit Moves:               | *****                                     |      |      |             |      |      |            |      |      |            |      |      |
| Green Time:               | 26.3                                      | 26.3 | 26.3 | 26.3        | 26.3 | 26.3 | 19.7       | 55.7 | 55.7 | 7.0        | 43.0 | 43.0 |
| Volume/Cap:               | 0.35                                      | 0.35 | 0.35 | 0.43        | 0.43 | 0.43 | 0.18       | 0.43 | 0.43 | 0.15       | 0.35 | 0.35 |
| Delay/Veh:                | 29.4                                      | 29.4 | 29.4 | 30.3        | 30.3 | 30.3 | 32.7       | 12.2 | 12.2 | 43.3       | 18.4 | 18.4 |
| User DelAdj:              | 1.00                                      | 1.00 | 1.00 | 1.00        | 1.00 | 1.00 | 1.00       | 1.00 | 1.00 | 1.00       | 1.00 | 1.00 |
| AdjDel/Veh:               | 29.4                                      | 29.4 | 29.4 | 30.3        | 30.3 | 30.3 | 32.7       | 12.2 | 12.2 | 43.3       | 18.4 | 18.4 |
| LOS by Move:              | C   | C    | C    | C           | C    | C    | C          | B    | B    | D          | B    | B    |
| HCM2k95thQ:               | 9   | 9    | 9    | 10          | 10   | 10   | 3          | 14   | 14   | 1          | 11   | 11   |

Note: Queue reported is the number of cars per lane.

BART

Level Of Service Computation Report  
 2000 HCM Operations (Future Volume Alternative)  
 AM - Exist + Proj Conditions

Intersection #3384: JACKSON/CAPITOL/SAN ANTONIO [Study Int 23]

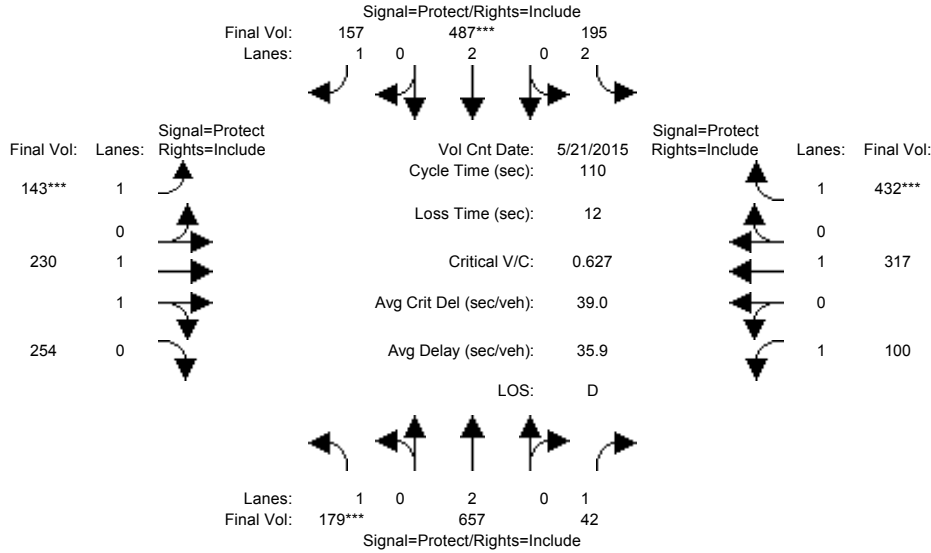

| Approach:  | North Bound |      |      | South Bound |      |      | East Bound |      |      | West Bound |      |      |
|--|-------------|------|------|-------------|------|------|------------|------|------|------------|------|------|
| Movement:  | L           | T    | R    | L           | T    | R    | L          | T    | R    | L          | T    | R    |
| Min. Green:  | 7           | 10   | 10   | 7           | 10   | 10   | 7          | 10   | 10   | 7          | 10   | 10   |
| Y+R:   | 4.0         | 4.0  | 4.0  | 4.0         | 4.0  | 4.0  | 4.0        | 4.0  | 4.0  | 4.0        | 4.0  | 4.0  |
| Volume Module: >> Count Date: 21 May 2015 << 7:30-8:30AM |             |      |      |             |      |      |            |      |      |            |      |      |
| Base Vol:  | 179         | 657  | 42   | 195         | 487  | 157  | 143        | 230  | 254  | 100        | 317  | 432  |
| Growth Adj:  | 1.00        | 1.00 | 1.00 | 1.00        | 1.00 | 1.00 | 1.00       | 1.00 | 1.00 | 1.00       | 1.00 | 1.00 |
| Initial Bse:   | 179         | 657  | 42   | 195         | 487  | 157  | 143        | 230  | 254  | 100        | 317  | 432  |
| Added Vol:   | 0           | 0    | 0    | 0           | 0    | 0    | 0          | 0    | 0    | 0          | 0    | 0    |
| PasserByVol:   | 0           | 0    | 0    | 0           | 0    | 0    | 0          | 0    | 0    | 0          | 0    | 0    |
| Initial Fut:   | 179         | 657  | 42   | 195         | 487  | 157  | 143        | 230  | 254  | 100        | 317  | 432  |
| User Adj:  | 1.00        | 1.00 | 1.00 | 1.00        | 1.00 | 1.00 | 1.00       | 1.00 | 1.00 | 1.00       | 1.00 | 1.00 |
| PHF Adj:   | 1.00        | 1.00 | 1.00 | 1.00        | 1.00 | 1.00 | 1.00       | 1.00 | 1.00 | 1.00       | 1.00 | 1.00 |
| PHF Volume:  | 179         | 657  | 42   | 195         | 487  | 157  | 143        | 230  | 254  | 100        | 317  | 432  |
| Reduct Vol:  | 0           | 0    | 0    | 0           | 0    | 0    | 0          | 0    | 0    | 0          | 0    | 0    |
| Reduced Vol:   | 179         | 657  | 42   | 195         | 487  | 157  | 143        | 230  | 254  | 100        | 317  | 432  |
| PCE Adj:   | 1.00        | 1.00 | 1.00 | 1.00        | 1.00 | 1.00 | 1.00       | 1.00 | 1.00 | 1.00       | 1.00 | 1.00 |
| MLF Adj:   | 1.00        | 1.00 | 1.00 | 1.00        | 1.00 | 1.00 | 1.00       | 1.00 | 1.00 | 1.00       | 1.00 | 1.00 |
| Final Volume:  | 179         | 657  | 42   | 195         | 487  | 157  | 143        | 230  | 254  | 100        | 317  | 432  |
| Saturation Flow Module:                                  |             |      |      |             |      |      |            |      |      |            |      |      |
| Sat/Lane:  | 1900        | 1900 | 1900 | 1900        | 1900 | 1900 | 1900       | 1900 | 1900 | 1900       | 1900 | 1900 |
| Adjustment:  | 0.92        | 1.00 | 0.92 | 0.83        | 1.00 | 0.92 | 0.92       | 1.00 | 0.92 | 0.92       | 1.00 | 0.92 |
| Lanes:   | 1.00        | 2.00 | 1.00 | 2.00        | 2.00 | 1.00 | 1.00       | 1.00 | 1.00 | 1.00       | 1.00 | 1.00 |
| Final Sat.:  | 1750        | 3800 | 1750 | 3150        | 3800 | 1750 | 1750       | 1900 | 1750 | 1750       | 1900 | 1750 |
| Capacity Analysis Module:                                |             |      |      |             |      |      |            |      |      |            |      |      |
| Vol/Sat:   | 0.10        | 0.17 | 0.02 | 0.06        | 0.13 | 0.09 | 0.08       | 0.12 | 0.15 | 0.06       | 0.17 | 0.25 |
| Crit Moves:  | ****        |      |      | ****        |      |      | ****       |      |      | ****       |      |      |
| Green Time:  | 17.9        | 29.5 | 29.5 | 10.9        | 22.5 | 22.5 | 14.3       | 40.0 | 40.0 | 17.6       | 43.3 | 43.3 |
| Volume/Cap:  | 0.63        | 0.64 | 0.09 | 0.63        | 0.63 | 0.44 | 0.63       | 0.33 | 0.40 | 0.36       | 0.42 | 0.63 |
| Delay/Veh:   | 47.3        | 37.0 | 30.2 | 51.6        | 41.6 | 39.1 | 50.8       | 25.4 | 26.2 | 42.0       | 24.7 | 28.7 |
| User DelAdj:   | 1.00        | 1.00 | 1.00 | 1.00        | 1.00 | 1.00 | 1.00       | 1.00 | 1.00 | 1.00       | 1.00 | 1.00 |
| AdjDel/Veh:  | 47.3        | 37.0 | 30.2 | 51.6        | 41.6 | 39.1 | 50.8       | 25.4 | 26.2 | 42.0       | 24.7 | 28.7 |
| LOS by Move:   | D           | D    | C    | D           | D    | D    | D          | C    | C    | D          | C    | C    |
| HCM2k95thQ:  | 12          | 18   | 2    | 10          | 16   | 10   | 10         | 10   | 13   | 7          | 15   | 24   |

Note: Queue reported is the number of cars per lane.



BART

Level Of Service Computation Report  
 2000 HCM Operations (Future Volume Alternative)  
 PM - Exist + Proj Conditions

Intersection #3384: JACKSON/CAPITOL/SAN ANTONIO [Study Int 23]

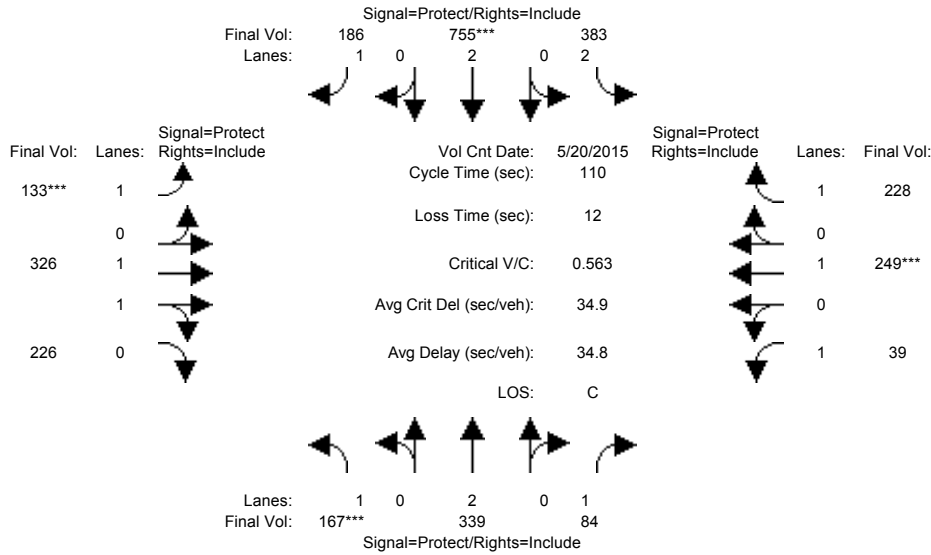

| Approach:  | North Bound |      |      | South Bound |      |      | East Bound |      |      | West Bound |      |      |
|--|-------------|------|------|-------------|------|------|------------|------|------|------------|------|------|
| Movement:  | L           | T    | R    | L           | T    | R    | L          | T    | R    | L          | T    | R    |
| Min. Green:  | 7           | 10   | 10   | 7           | 10   | 10   | 7          | 10   | 10   | 7          | 10   | 10   |
| Y+R:   | 4.0         | 4.0  | 4.0  | 4.0         | 4.0  | 4.0  | 4.0        | 4.0  | 4.0  | 4.0        | 4.0  | 4.0  |
| Volume Module: >> Count Date: 20 May 2015 << 5:00-6:00PM |             |      |      |             |      |      |            |      |      |            |      |      |
| Base Vol:  | 167         | 339  | 84   | 383         | 755  | 186  | 133        | 326  | 226  | 39         | 249  | 228  |
| Growth Adj:  | 1.00        | 1.00 | 1.00 | 1.00        | 1.00 | 1.00 | 1.00       | 1.00 | 1.00 | 1.00       | 1.00 | 1.00 |
| Initial Bse:   | 167         | 339  | 84   | 383         | 755  | 186  | 133        | 326  | 226  | 39         | 249  | 228  |
| Added Vol:   | 0           | 0    | 0    | 0           | 0    | 0    | 0          | 0    | 0    | 0          | 0    | 0    |
| PasserByVol:   | 0           | 0    | 0    | 0           | 0    | 0    | 0          | 0    | 0    | 0          | 0    | 0    |
| Initial Fut:   | 167         | 339  | 84   | 383         | 755  | 186  | 133        | 326  | 226  | 39         | 249  | 228  |
| User Adj:  | 1.00        | 1.00 | 1.00 | 1.00        | 1.00 | 1.00 | 1.00       | 1.00 | 1.00 | 1.00       | 1.00 | 1.00 |
| PHF Adj:   | 1.00        | 1.00 | 1.00 | 1.00        | 1.00 | 1.00 | 1.00       | 1.00 | 1.00 | 1.00       | 1.00 | 1.00 |
| PHF Volume:  | 167         | 339  | 84   | 383         | 755  | 186  | 133        | 326  | 226  | 39         | 249  | 228  |
| Reduct Vol:  | 0           | 0    | 0    | 0           | 0    | 0    | 0          | 0    | 0    | 0          | 0    | 0    |
| Reduced Vol:   | 167         | 339  | 84   | 383         | 755  | 186  | 133        | 326  | 226  | 39         | 249  | 228  |
| PCE Adj:   | 1.00        | 1.00 | 1.00 | 1.00        | 1.00 | 1.00 | 1.00       | 1.00 | 1.00 | 1.00       | 1.00 | 1.00 |
| MLF Adj:   | 1.00        | 1.00 | 1.00 | 1.00        | 1.00 | 1.00 | 1.00       | 1.00 | 1.00 | 1.00       | 1.00 | 1.00 |
| Final Volume:  | 167         | 339  | 84   | 383         | 755  | 186  | 133        | 326  | 226  | 39         | 249  | 228  |
| Saturation Flow Module:                                  |             |      |      |             |      |      |            |      |      |            |      |      |
| Sat/Lane:  | 1900        | 1900 | 1900 | 1900        | 1900 | 1900 | 1900       | 1900 | 1900 | 1900       | 1900 | 1900 |
| Adjustment:  | 0.92        | 1.00 | 0.92 | 0.83        | 1.00 | 0.92 | 0.92       | 0.99 | 0.95 | 0.92       | 1.00 | 0.92 |
| Lanes:   | 1.00        | 2.00 | 1.00 | 2.00        | 2.00 | 1.00 | 1.00       | 1.16 | 0.84 | 1.00       | 1.00 | 1.00 |
| Final Sat.:  | 1750        | 3800 | 1750 | 3150        | 3800 | 1750 | 1750       | 2184 | 1514 | 1750       | 1900 | 1750 |
| Capacity Analysis Module:                                |             |      |      |             |      |      |            |      |      |            |      |      |
| Vol/Sat:   | 0.10        | 0.09 | 0.05 | 0.12        | 0.20 | 0.11 | 0.08       | 0.15 | 0.15 | 0.02       | 0.13 | 0.13 |
| Crit Moves:  | ****        |      |      | ****        |      |      | ****       |      |      | ****       |      |      |
| Green Time:  | 18.7        | 24.6 | 24.6 | 32.9        | 38.9 | 38.9 | 14.9       | 28.4 | 28.4 | 12.1       | 25.6 | 25.6 |
| Volume/Cap:  | 0.56        | 0.40 | 0.21 | 0.41        | 0.56 | 0.30 | 0.56       | 0.58 | 0.58 | 0.20       | 0.56 | 0.56 |
| Delay/Veh:   | 44.4        | 36.7 | 35.1 | 31.0        | 29.3 | 26.0 | 47.6       | 36.5 | 36.5 | 45.1       | 38.9 | 39.0 |
| User DelAdj:   | 1.00        | 1.00 | 1.00 | 1.00        | 1.00 | 1.00 | 1.00       | 1.00 | 1.00 | 1.00       | 1.00 | 1.00 |
| AdjDel/Veh:  | 44.4        | 36.7 | 35.1 | 31.0        | 29.3 | 26.0 | 47.6       | 36.5 | 36.5 | 45.1       | 38.9 | 39.0 |
| LOS by Move:   | D           | D    | D    | C           | C    | C    | D          | D    | D    | D          | D    | D    |
| HCM2k95thQ:  | 11          | 9    | 5    | 12          | 19   | 10   | 9          | 15   | 15   | 3          | 15   | 15   |

Note: Queue reported is the number of cars per lane.

BART

Level Of Service Computation Report  
 2000 HCM Operations (Future Volume Alternative)  
 AM - Exist + Proj Conditions

Intersection #3411: AVIATION/COLEMAN [Study Int 34]

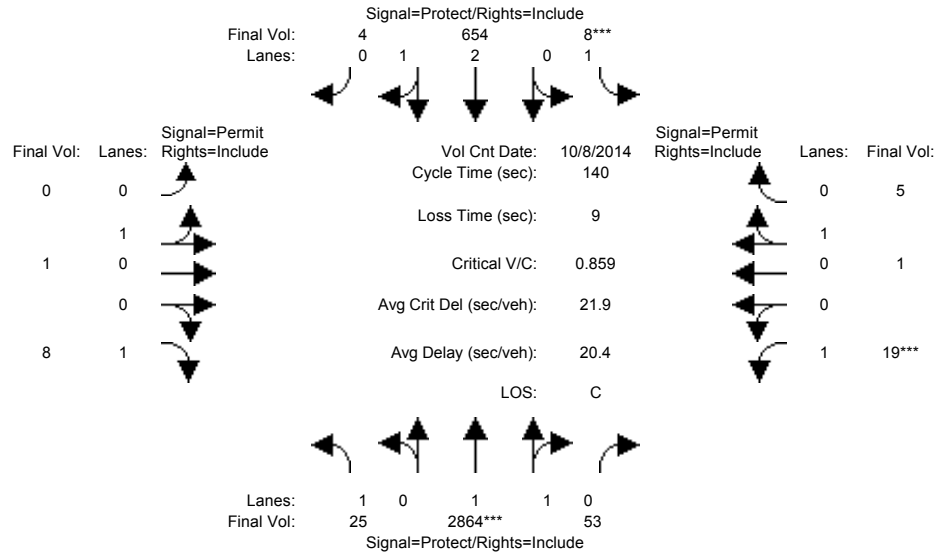

| Approach:                                   | North Bound |      |       | South Bound |      |      | East Bound |      |      | West Bound |      |      |
|---|-------------|------|-------|-------------|------|------|------------|------|------|------------|------|------|
| Movement:                                   | L           | T    | R     | L           | T    | R    | L          | T    | R    | L          | T    | R    |
| Min. Green:                                 | 7           | 10   | 10    | 7           | 10   | 10   | 10         | 10   | 10   | 10         | 10   | 10   |
| Y+R:  | 4.0         | 4.0  | 4.0   | 4.0         | 4.0  | 4.0  | 4.0        | 4.0  | 4.0  | 4.0        | 4.0  | 4.0  |
| Volume Module: >> Count Date: 8 Oct 2014 << |             |      |       |             |      |      |            |      |      |            |      |      |
| Base Vol:                                   | 25          | 2864 | 53    | 8           | 654  | 4    | 0          | 1    | 8    | 19         | 1    | 5    |
| Growth Adj:                                 | 1.00        | 1.00 | 1.00  | 1.00        | 1.00 | 1.00 | 1.00       | 1.00 | 1.00 | 1.00       | 1.00 | 1.00 |
| Initial Bse:                                | 25          | 2864 | 53    | 8           | 654  | 4    | 0          | 1    | 8    | 19         | 1    | 5    |
| Added Vol:                                  | 0           | 0    | 0     | 0           | 0    | 0    | 0          | 0    | 0    | 0          | 0    | 0    |
| PasserByVol:                                | 0           | 0    | 0     | 0           | 0    | 0    | 0          | 0    | 0    | 0          | 0    | 0    |
| Initial Fut:                                | 25          | 2864 | 53    | 8           | 654  | 4    | 0          | 1    | 8    | 19         | 1    | 5    |
| User Adj:                                   | 1.00        | 1.00 | 1.00  | 1.00        | 1.00 | 1.00 | 1.00       | 1.00 | 1.00 | 1.00       | 1.00 | 1.00 |
| PHF Adj:                                    | 1.00        | 1.00 | 1.00  | 1.00        | 1.00 | 1.00 | 1.00       | 1.00 | 1.00 | 1.00       | 1.00 | 1.00 |
| PHF Volume:                                 | 25          | 2864 | 53    | 8           | 654  | 4    | 0          | 1    | 8    | 19         | 1    | 5    |
| Reduct Vol:                                 | 0           | 0    | 0     | 0           | 0    | 0    | 0          | 0    | 0    | 0          | 0    | 0    |
| Reduced Vol:                                | 25          | 2864 | 53    | 8           | 654  | 4    | 0          | 1    | 8    | 19         | 1    | 5    |
| PCE Adj:                                    | 1.00        | 1.00 | 1.00  | 1.00        | 1.00 | 1.00 | 1.00       | 1.00 | 1.00 | 1.00       | 1.00 | 1.00 |
| MLF Adj:                                    | 1.00        | 1.00 | 1.00  | 1.00        | 1.00 | 1.00 | 1.00       | 1.00 | 1.00 | 1.00       | 1.00 | 1.00 |
| FinalVolume:                                | 25          | 2864 | 53    | 8           | 654  | 4    | 0          | 1    | 8    | 19         | 1    | 5    |
| Saturation Flow Module:                     |             |      |       |             |      |      |            |      |      |            |      |      |
| Sat/Lane:                                   | 1900        | 1900 | 1900  | 1900        | 1900 | 1900 | 1900       | 1900 | 1900 | 1900       | 1900 | 1900 |
| Adjustment:                                 | 0.92        | 0.97 | 0.95  | 0.92        | 0.98 | 0.95 | 0.95       | 0.95 | 0.92 | 0.92       | 0.95 | 0.95 |
| Lanes:                                      | 1.00        | 1.96 | 0.04  | 1.00        | 2.98 | 0.02 | 0.00       | 1.00 | 1.00 | 1.00       | 0.17 | 0.83 |
| Final Sat.:                                 | 1750        | 3633 | 67    | 1750        | 5566 | 34   | 0          | 1800 | 1750 | 1750       | 300  | 1500 |
| Capacity Analysis Module:                   |             |      |       |             |      |      |            |      |      |            |      |      |
| Vol/Sat:                                    | 0.01        | 0.79 | 0.79  | 0.00        | 0.12 | 0.12 | 0.00       | 0.00 | 0.00 | 0.01       | 0.00 | 0.00 |
| Crit Moves:                                 | ****        | **** | ****  | ****        | **** | **** | ****       | **** | **** | ****       | **** | **** |
| Green Time:                                 | 36.1        | 114  | 114.0 | 7.0         | 84.9 | 84.9 | 0.0        | 10.0 | 10.0 | 10.0       | 10.0 | 10.0 |
| Volume/Cap:                                 | 0.06        | 0.97 | 0.97  | 0.09        | 0.19 | 0.19 | 0.00       | 0.01 | 0.06 | 0.15       | 0.05 | 0.05 |
| Delay/Veh:                                  | 39.2        | 21.5 | 21.5  | 63.9        | 12.3 | 12.3 | 0.0        | 60.4 | 60.9 | 61.6       | 60.7 | 60.7 |
| User DelAdj:                                | 1.00        | 1.00 | 1.00  | 1.00        | 1.00 | 1.00 | 1.00       | 1.00 | 1.00 | 1.00       | 1.00 | 1.00 |
| AdjDel/Veh:                                 | 39.2        | 21.5 | 21.5  | 63.9        | 12.3 | 12.3 | 0.0        | 60.4 | 60.9 | 61.6       | 60.7 | 60.7 |
| LOS by Move:                                | D           | C    | C     | E           | B    | B    | A          | E    | E    | E          | E    | E    |
| HCM2k95thQ:                                 | 2           | 93   | 93    | 1           | 8    | 8    | 0          | 0    | 1    | 2          | 1    | 1    |

Note: Queue reported is the number of cars per lane.

BART

Level Of Service Computation Report  
 2000 HCM Operations (Future Volume Alternative)  
 PM - Exist + Proj Conditions

Intersection #3411: AVIATION/COLEMAN [Study Int 34]

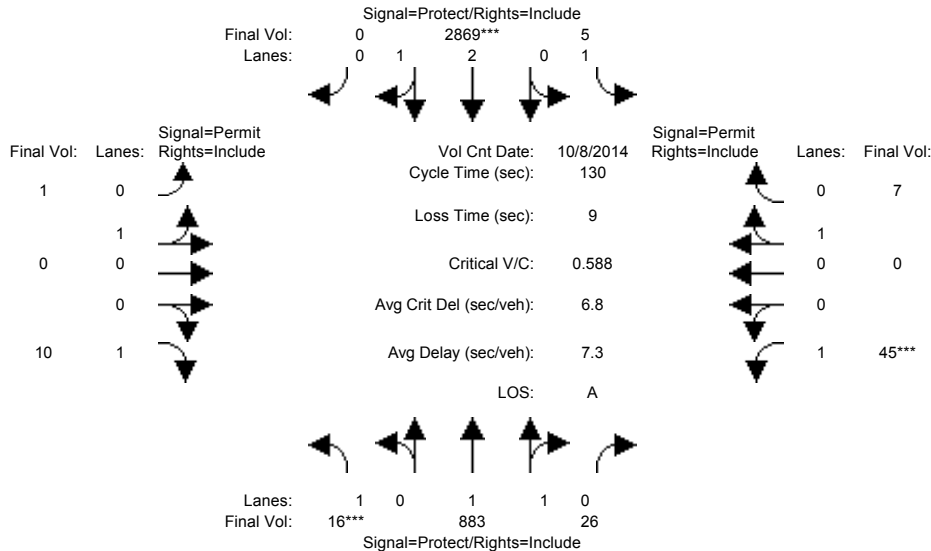

| Approach:                                   | North Bound |      |      | South Bound |      |      | East Bound |      |      | West Bound |      |      |
|---|-------------|------|------|-------------|------|------|------------|------|------|------------|------|------|
| Movement:                                   | L           | T    | R    | L           | T    | R    | L          | T    | R    | L          | T    | R    |
| Min. Green:                                 | 7           | 10   | 10   | 7           | 10   | 10   | 10         | 10   | 10   | 10         | 10   | 10   |
| Y+R:  | 4.0         | 4.0  | 4.0  | 4.0         | 4.0  | 4.0  | 4.0        | 4.0  | 4.0  | 4.0        | 4.0  | 4.0  |
| Volume Module: >> Count Date: 8 Oct 2014 << |             |      |      |             |      |      |            |      |      |            |      |      |
| Base Vol:                                   | 16          | 883  | 26   | 5           | 2869 | 0    | 1          | 0    | 10   | 45         | 0    | 7    |
| Growth Adj:                                 | 1.00        | 1.00 | 1.00 | 1.00        | 1.00 | 1.00 | 1.00       | 1.00 | 1.00 | 1.00       | 1.00 | 1.00 |
| Initial Bse:                                | 16          | 883  | 26   | 5           | 2869 | 0    | 1          | 0    | 10   | 45         | 0    | 7    |
| Added Vol:                                  | 0           | 0    | 0    | 0           | 0    | 0    | 0          | 0    | 0    | 0          | 0    | 0    |
| PasserByVol:                                | 0           | 0    | 0    | 0           | 0    | 0    | 0          | 0    | 0    | 0          | 0    | 0    |
| Initial Fut:                                | 16          | 883  | 26   | 5           | 2869 | 0    | 1          | 0    | 10   | 45         | 0    | 7    |
| User Adj:                                   | 1.00        | 1.00 | 1.00 | 1.00        | 1.00 | 1.00 | 1.00       | 1.00 | 1.00 | 1.00       | 1.00 | 1.00 |
| PHF Adj:                                    | 1.00        | 1.00 | 1.00 | 1.00        | 1.00 | 1.00 | 1.00       | 1.00 | 1.00 | 1.00       | 1.00 | 1.00 |
| PHF Volume:                                 | 16          | 883  | 26   | 5           | 2869 | 0    | 1          | 0    | 10   | 45         | 0    | 7    |
| Reduct Vol:                                 | 0           | 0    | 0    | 0           | 0    | 0    | 0          | 0    | 0    | 0          | 0    | 0    |
| Reduced Vol:                                | 16          | 883  | 26   | 5           | 2869 | 0    | 1          | 0    | 10   | 45         | 0    | 7    |
| PCE Adj:                                    | 1.00        | 1.00 | 1.00 | 1.00        | 1.00 | 1.00 | 1.00       | 1.00 | 1.00 | 1.00       | 1.00 | 1.00 |
| MLF Adj:                                    | 1.00        | 1.00 | 1.00 | 1.00        | 1.00 | 1.00 | 1.00       | 1.00 | 1.00 | 1.00       | 1.00 | 1.00 |
| Final Volume:                               | 16          | 883  | 26   | 5           | 2869 | 0    | 1          | 0    | 10   | 45         | 0    | 7    |
| Saturation Flow Module:                     |             |      |      |             |      |      |            |      |      |            |      |      |
| Sat/Lane:                                   | 1900        | 1900 | 1900 | 1900        | 1900 | 1900 | 1900       | 1900 | 1900 | 1900       | 1900 | 1900 |
| Adjustment:                                 | 0.92        | 0.97 | 0.95 | 0.92        | 0.98 | 0.92 | 0.95       | 0.95 | 0.92 | 0.92       | 1.00 | 0.95 |
| Lanes:                                      | 1.00        | 1.94 | 0.06 | 1.00        | 3.00 | 0.00 | 1.00       | 0.00 | 1.00 | 1.00       | 0.00 | 1.00 |
| Final Sat.:                                 | 1750        | 3594 | 106  | 1750        | 5600 | 0    | 1800       | 0    | 1750 | 1750       | 0    | 1800 |
| Capacity Analysis Module:                   |             |      |      |             |      |      |            |      |      |            |      |      |
| Vol/Sat:                                    | 0.01        | 0.25 | 0.25 | 0.00        | 0.51 | 0.00 | 0.00       | 0.00 | 0.01 | 0.03       | 0.00 | 0.00 |
| Crit Moves:                                 | ****        | **** | **** | ****        | **** | **** | ****       | **** | **** | ****       | **** | **** |
| Green Time:                                 | 7.0         | 91.0 | 91.0 | 20.0        | 104  | 0.0  | 10.0       | 0.0  | 10.0 | 10.0       | 0.0  | 10.0 |
| Volume/Cap:                                 | 0.17        | 0.35 | 0.35 | 0.02        | 0.64 | 0.00 | 0.01       | 0.00 | 0.07 | 0.33       | 0.00 | 0.05 |
| Delay/Veh:                                  | 59.6        | 7.8  | 7.8  | 46.7        | 5.6  | 0.0  | 55.4       | 0.0  | 55.9 | 58.3       | 0.0  | 55.8 |
| User DelAdj:                                | 1.00        | 1.00 | 1.00 | 1.00        | 1.00 | 1.00 | 1.00       | 1.00 | 1.00 | 1.00       | 1.00 | 1.00 |
| AdjDel/Veh:                                 | 59.6        | 7.8  | 7.8  | 46.7        | 5.6  | 0.0  | 55.4       | 0.0  | 55.9 | 58.3       | 0.0  | 55.8 |
| LOS by Move:                                | E           | A    | A    | D           | A    | A    | E          | A    | E    | E          | A    | E    |
| HCM2k95thQ:                                 | 1           | 14   | 14   | 0           | 26   | 0    | 0          | 0    | 1    | 4          | 0    | 1    |

Note: Queue reported is the number of cars per lane.

BART

Level Of Service Computation Report  
 2000 HCM Operations (Future Volume Alternative)  
 AM - Exist + Proj Conditions

Intersection #3413: Coleman/Hedding [Study Int 38]

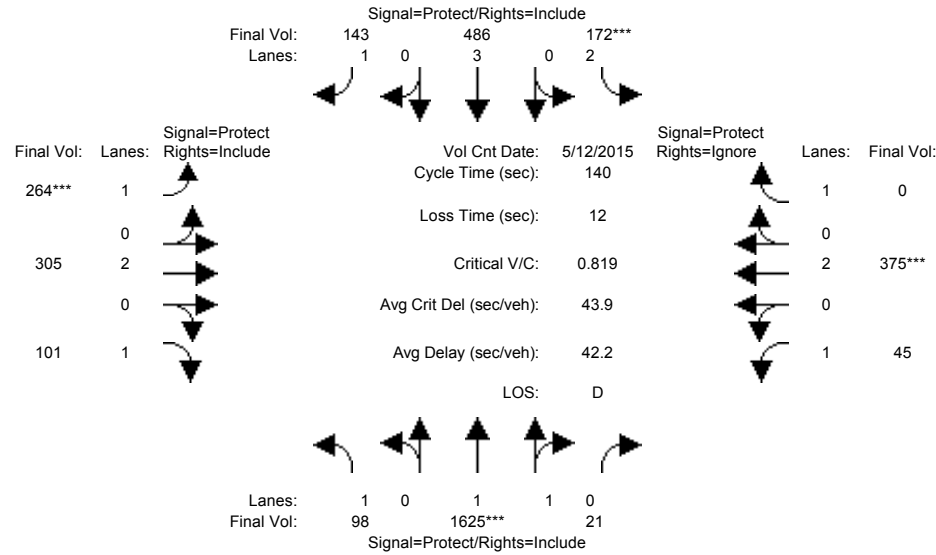

| Approach:  | North Bound |      |      | South Bound |      |      | East Bound |      |      | West Bound |      |      |
|--|-------------|------|------|-------------|------|------|------------|------|------|------------|------|------|
| Movement:  | L           | T    | R    | L           | T    | R    | L          | T    | R    | L          | T    | R    |
| Min. Green:  | 7           | 10   | 10   | 7           | 10   | 10   | 7          | 10   | 10   | 7          | 10   | 10   |
| Y+R:   | 4.0         | 4.0  | 4.0  | 4.0         | 4.0  | 4.0  | 4.0        | 4.0  | 4.0  | 4.0        | 4.0  | 4.0  |
| Volume Module: >> Count Date: 12 May 2015 << 7:45-8:45AM |             |      |      |             |      |      |            |      |      |            |      |      |
| Base Vol:  | 98          | 1625 | 21   | 172         | 486  | 143  | 264        | 305  | 101  | 45         | 375  | 760  |
| Growth Adj:  | 1.00        | 1.00 | 1.00 | 1.00        | 1.00 | 1.00 | 1.00       | 1.00 | 1.00 | 1.00       | 1.00 | 1.00 |
| Initial Bse:   | 98          | 1625 | 21   | 172         | 486  | 143  | 264        | 305  | 101  | 45         | 375  | 760  |
| Added Vol:   | 0           | 0    | 0    | 0           | 0    | 0    | 0          | 0    | 0    | 0          | 0    | 0    |
| PasserByVol:   | 0           | 0    | 0    | 0           | 0    | 0    | 0          | 0    | 0    | 0          | 0    | 0    |
| Initial Fut:   | 98          | 1625 | 21   | 172         | 486  | 143  | 264        | 305  | 101  | 45         | 375  | 760  |
| User Adj:  | 1.00        | 1.00 | 1.00 | 1.00        | 1.00 | 1.00 | 1.00       | 1.00 | 1.00 | 1.00       | 1.00 | 0.00 |
| PHF Adj:   | 1.00        | 1.00 | 1.00 | 1.00        | 1.00 | 1.00 | 1.00       | 1.00 | 1.00 | 1.00       | 1.00 | 0.00 |
| PHF Volume:  | 98          | 1625 | 21   | 172         | 486  | 143  | 264        | 305  | 101  | 45         | 375  | 0    |
| Reduct Vol:  | 0           | 0    | 0    | 0           | 0    | 0    | 0          | 0    | 0    | 0          | 0    | 0    |
| Reduced Vol:   | 98          | 1625 | 21   | 172         | 486  | 143  | 264        | 305  | 101  | 45         | 375  | 0    |
| PCE Adj:   | 1.00        | 1.00 | 1.00 | 1.00        | 1.00 | 1.00 | 1.00       | 1.00 | 1.00 | 1.00       | 1.00 | 0.00 |
| MLF Adj:   | 1.00        | 1.00 | 1.00 | 1.00        | 1.00 | 1.00 | 1.00       | 1.00 | 1.00 | 1.00       | 1.00 | 0.00 |
| Final Volume:  | 98          | 1625 | 21   | 172         | 486  | 143  | 264        | 305  | 101  | 45         | 375  | 0    |
| Saturation Flow Module:                                  |             |      |      |             |      |      |            |      |      |            |      |      |
| Sat/Lane:  | 1900        | 1900 | 1900 | 1900        | 1900 | 1900 | 1900       | 1900 | 1900 | 1900       | 1900 | 1900 |
| Adjustment:  | 0.92        | 0.97 | 0.95 | 0.83        | 0.83 | 0.92 | 0.92       | 1.00 | 0.92 | 0.92       | 1.00 | 0.92 |
| Lanes:   | 1.00        | 1.97 | 0.03 | 2.00        | 3.00 | 1.00 | 1.00       | 2.00 | 1.00 | 1.00       | 2.00 | 1.00 |
| Final Sat.:  | 1750        | 3653 | 47   | 3150        | 4750 | 1750 | 1750       | 3800 | 1750 | 1750       | 3800 | 1750 |
| Capacity Analysis Module:                                |             |      |      |             |      |      |            |      |      |            |      |      |
| Vol/Sat:   | 0.06        | 0.44 | 0.44 | 0.05        | 0.10 | 0.08 | 0.15       | 0.08 | 0.06 | 0.03       | 0.10 | 0.00 |
| Crit Moves:  | ****        | **** | **** | ****        | **** | **** | ****       | **** | **** | ****       | **** | **** |
| Green Time:  | 30.2        | 76.0 | 76.0 | 9.3         | 55.2 | 55.2 | 25.8       | 26.3 | 26.3 | 16.4       | 16.9 | 0.0  |
| Volume/Cap:  | 0.26        | 0.82 | 0.82 | 0.82        | 0.26 | 0.21 | 0.82       | 0.43 | 0.31 | 0.22       | 0.82 | 0.00 |
| Delay/Veh:   | 46.0        | 29.1 | 29.1 | 86.3        | 28.7 | 28.1 | 70.0       | 50.6 | 49.6 | 56.6       | 71.2 | 0.0  |
| User DelAdj:   | 1.00        | 1.00 | 1.00 | 1.00        | 1.00 | 1.00 | 1.00       | 1.00 | 1.00 | 1.00       | 1.00 | 1.00 |
| AdjDel/Veh:  | 46.0        | 29.1 | 29.1 | 86.3        | 28.7 | 28.1 | 70.0       | 50.6 | 49.6 | 56.6       | 71.2 | 0.0  |
| LOS by Move:   | D           | C    | C    | F           | C    | C    | E          | D    | D    | E          | E    | A    |
| HCM2k95thQ:  | 7           | 47   | 47   | 10          | 9    | 8    | 22         | 11   | 8    | 4          | 18   | 0    |

Note: Queue reported is the number of cars per lane.

BART

Level Of Service Computation Report  
 2000 HCM Operations (Future Volume Alternative)  
 PM - Exist + Proj Conditions

Intersection #3413: Coleman/Hedding [Study Int 38]

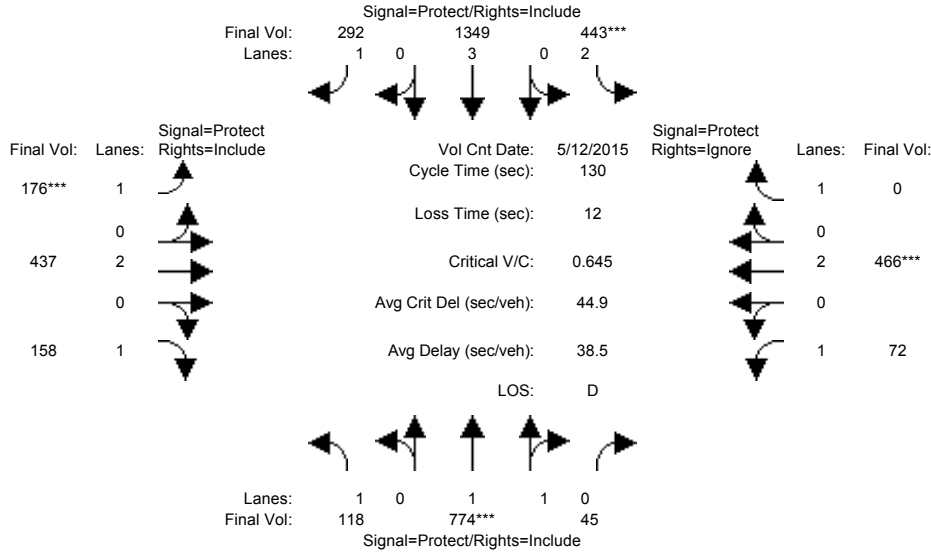

| Approach:  | North Bound |      |      | South Bound |      |      | East Bound |      |      | West Bound |      |      |
|--|-------------|------|------|-------------|------|------|------------|------|------|------------|------|------|
| Movement:  | L           | T    | R    | L           | T    | R    | L          | T    | R    | L          | T    | R    |
| Min. Green:  | 7           | 10   | 10   | 7           | 10   | 10   | 7          | 10   | 10   | 7          | 10   | 10   |
| Y+R:   | 4.0         | 4.0  | 4.0  | 4.0         | 4.0  | 4.0  | 4.0        | 4.0  | 4.0  | 4.0        | 4.0  | 4.0  |
| Volume Module: >> Count Date: 12 May 2015 << 5:00-6:00PM |             |      |      |             |      |      |            |      |      |            |      |      |
| Base Vol:  | 118         | 774  | 45   | 443         | 1349 | 292  | 176        | 437  | 158  | 72         | 466  | 348  |
| Growth Adj:  | 1.00        | 1.00 | 1.00 | 1.00        | 1.00 | 1.00 | 1.00       | 1.00 | 1.00 | 1.00       | 1.00 | 1.00 |
| Initial Bse:   | 118         | 774  | 45   | 443         | 1349 | 292  | 176        | 437  | 158  | 72         | 466  | 348  |
| Added Vol:   | 0           | 0    | 0    | 0           | 0    | 0    | 0          | 0    | 0    | 0          | 0    | 0    |
| PasserByVol:   | 0           | 0    | 0    | 0           | 0    | 0    | 0          | 0    | 0    | 0          | 0    | 0    |
| Initial Fut:   | 118         | 774  | 45   | 443         | 1349 | 292  | 176        | 437  | 158  | 72         | 466  | 348  |
| User Adj:  | 1.00        | 1.00 | 1.00 | 1.00        | 1.00 | 1.00 | 1.00       | 1.00 | 1.00 | 1.00       | 1.00 | 0.00 |
| PHF Adj:   | 1.00        | 1.00 | 1.00 | 1.00        | 1.00 | 1.00 | 1.00       | 1.00 | 1.00 | 1.00       | 1.00 | 0.00 |
| PHF Volume:  | 118         | 774  | 45   | 443         | 1349 | 292  | 176        | 437  | 158  | 72         | 466  | 0    |
| Reduct Vol:  | 0           | 0    | 0    | 0           | 0    | 0    | 0          | 0    | 0    | 0          | 0    | 0    |
| Reduced Vol:   | 118         | 774  | 45   | 443         | 1349 | 292  | 176        | 437  | 158  | 72         | 466  | 0    |
| PCE Adj:   | 1.00        | 1.00 | 1.00 | 1.00        | 1.00 | 1.00 | 1.00       | 1.00 | 1.00 | 1.00       | 1.00 | 0.00 |
| MLF Adj:   | 1.00        | 1.00 | 1.00 | 1.00        | 1.00 | 1.00 | 1.00       | 1.00 | 1.00 | 1.00       | 1.00 | 0.00 |
| Final Volume:  | 118         | 774  | 45   | 443         | 1349 | 292  | 176        | 437  | 158  | 72         | 466  | 0    |
| Saturation Flow Module:                                  |             |      |      |             |      |      |            |      |      |            |      |      |
| Sat/Lane:  | 1900        | 1900 | 1900 | 1900        | 1900 | 1900 | 1900       | 1900 | 1900 | 1900       | 1900 | 1900 |
| Adjustment:  | 0.92        | 0.98 | 0.95 | 0.83        | 0.83 | 0.92 | 0.92       | 1.00 | 0.92 | 0.92       | 1.00 | 0.92 |
| Lanes:   | 1.00        | 1.89 | 0.11 | 2.00        | 3.00 | 1.00 | 1.00       | 2.00 | 1.00 | 1.00       | 2.00 | 1.00 |
| Final Sat.:  | 1750        | 3497 | 203  | 3150        | 4750 | 1750 | 1750       | 3800 | 1750 | 1750       | 3800 | 1750 |
| Capacity Analysis Module:                                |             |      |      |             |      |      |            |      |      |            |      |      |
| Vol/Sat:   | 0.07        | 0.22 | 0.22 | 0.14        | 0.28 | 0.17 | 0.10       | 0.12 | 0.09 | 0.04       | 0.12 | 0.00 |
| Crit Moves:  | ****        | **** | **** | ****        | **** | **** | ****       | **** | **** | ****       | **** | **** |
| Green Time:  | 14.0        | 44.6 | 44.6 | 28.4        | 59.0 | 59.0 | 20.3       | 30.7 | 30.7 | 14.4       | 24.7 | 0.0  |
| Volume/Cap:  | 0.63        | 0.64 | 0.64 | 0.64        | 0.63 | 0.37 | 0.64       | 0.49 | 0.38 | 0.37       | 0.64 | 0.00 |
| Delay/Veh:   | 62.0        | 37.1 | 37.1 | 48.4        | 27.7 | 23.6 | 56.7       | 43.3 | 42.3 | 54.9       | 50.6 | 0.0  |
| User DelAdj:   | 1.00        | 1.00 | 1.00 | 1.00        | 1.00 | 1.00 | 1.00       | 1.00 | 1.00 | 1.00       | 1.00 | 1.00 |
| AdjDel/Veh:  | 62.0        | 37.1 | 37.1 | 48.4        | 27.7 | 23.6 | 56.7       | 43.3 | 42.3 | 54.9       | 50.6 | 0.0  |
| LOS by Move:   | E           | D    | D    | D           | C    | C    | E          | D    | D    | D          | D    | A    |
| HCM2k95thQ:  | 10          | 25   | 25   | 18          | 24   | 15   | 13         | 14   | 11   | 6          | 17   | 0    |

Note: Queue reported is the number of cars per lane.

BART

Level Of Service Computation Report  
 2000 HCM Operations (Future Volume Alternative)  
 AM - Exist + Proj Conditions

Intersection #3417: Coleman/Taylor [Study Int 39]

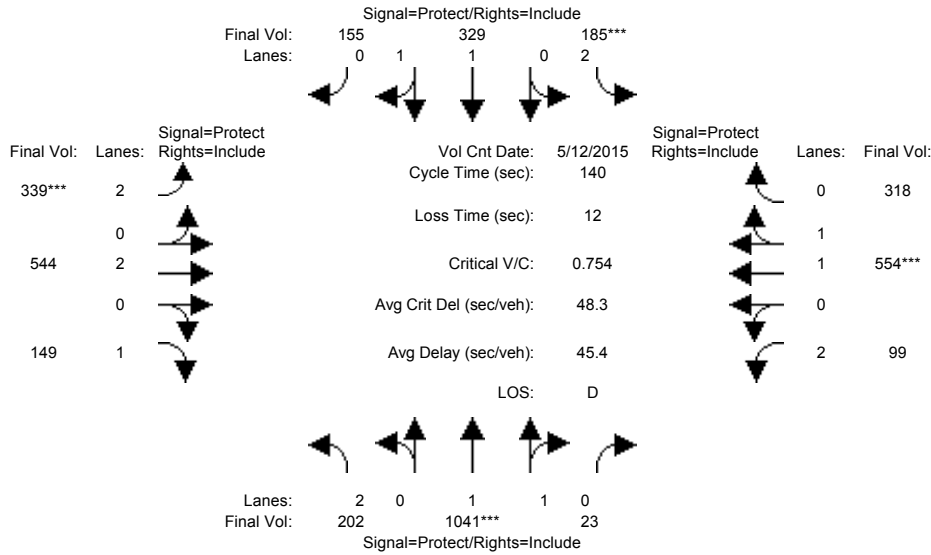

| Approach:  | North Bound |      |      | South Bound |      |      | East Bound |      |      | West Bound |      |      |
|--|-------------|------|------|-------------|------|------|------------|------|------|------------|------|------|
| Movement:  | L           | T    | R    | L           | T    | R    | L          | T    | R    | L          | T    | R    |
| Min. Green:  | 7           | 10   | 10   | 7           | 10   | 10   | 7          | 10   | 10   | 7          | 10   | 10   |
| Y+R:   | 4.0         | 4.0  | 4.0  | 4.0         | 4.0  | 4.0  | 4.0        | 4.0  | 4.0  | 4.0        | 4.0  | 4.0  |
| Volume Module: >> Count Date: 12 May 2015 << 7:30-8:30AM |             |      |      |             |      |      |            |      |      |            |      |      |
| Base Vol:  | 202         | 1041 | 23   | 185         | 329  | 155  | 339        | 544  | 149  | 99         | 554  | 318  |
| Growth Adj:  | 1.00        | 1.00 | 1.00 | 1.00        | 1.00 | 1.00 | 1.00       | 1.00 | 1.00 | 1.00       | 1.00 | 1.00 |
| Initial Bse:   | 202         | 1041 | 23   | 185         | 329  | 155  | 339        | 544  | 149  | 99         | 554  | 318  |
| Added Vol:   | 0           | 0    | 0    | 0           | 0    | 0    | 0          | 0    | 0    | 0          | 0    | 0    |
| PasserByVol:   | 0           | 0    | 0    | 0           | 0    | 0    | 0          | 0    | 0    | 0          | 0    | 0    |
| Initial Fut:   | 202         | 1041 | 23   | 185         | 329  | 155  | 339        | 544  | 149  | 99         | 554  | 318  |
| User Adj:  | 1.00        | 1.00 | 1.00 | 1.00        | 1.00 | 1.00 | 1.00       | 1.00 | 1.00 | 1.00       | 1.00 | 1.00 |
| PHF Adj:   | 1.00        | 1.00 | 1.00 | 1.00        | 1.00 | 1.00 | 1.00       | 1.00 | 1.00 | 1.00       | 1.00 | 1.00 |
| PHF Volume:  | 202         | 1041 | 23   | 185         | 329  | 155  | 339        | 544  | 149  | 99         | 554  | 318  |
| Reduct Vol:  | 0           | 0    | 0    | 0           | 0    | 0    | 0          | 0    | 0    | 0          | 0    | 0    |
| Reduced Vol:   | 202         | 1041 | 23   | 185         | 329  | 155  | 339        | 544  | 149  | 99         | 554  | 318  |
| PCE Adj:   | 1.00        | 1.00 | 1.00 | 1.00        | 1.00 | 1.00 | 1.00       | 1.00 | 1.00 | 1.00       | 1.00 | 1.00 |
| MLF Adj:   | 1.00        | 1.00 | 1.00 | 1.00        | 1.00 | 1.00 | 1.00       | 1.00 | 1.00 | 1.00       | 1.00 | 1.00 |
| FinalVolume:   | 202         | 1041 | 23   | 185         | 329  | 155  | 339        | 544  | 149  | 99         | 554  | 318  |
| Saturation Flow Module:                                  |             |      |      |             |      |      |            |      |      |            |      |      |
| Sat/Lane:  | 1900        | 1900 | 1900 | 1900        | 1900 | 1900 | 1900       | 1900 | 1900 | 1900       | 1900 | 1900 |
| Adjustment:  | 0.83        | 0.97 | 0.95 | 0.83        | 0.99 | 0.95 | 0.83       | 1.00 | 0.92 | 0.83       | 0.99 | 0.95 |
| Lanes:   | 2.00        | 1.96 | 0.04 | 2.00        | 1.34 | 0.66 | 2.00       | 2.00 | 1.00 | 2.00       | 1.25 | 0.75 |
| Final Sat.:  | 3150        | 3620 | 80   | 3150        | 2514 | 1185 | 3150       | 3800 | 1750 | 3150       | 2350 | 1349 |
| Capacity Analysis Module:                                |             |      |      |             |      |      |            |      |      |            |      |      |
| Vol/Sat:   | 0.06        | 0.29 | 0.29 | 0.06        | 0.13 | 0.13 | 0.11       | 0.14 | 0.09 | 0.03       | 0.24 | 0.24 |
| Crit Moves:  | ****        | **** | **** | ****        | **** | **** | ****       | **** | **** | ****       | **** | **** |
| Green Time:  | 21.1        | 53.4 | 53.4 | 10.9        | 43.1 | 43.1 | 20.0       | 47.2 | 47.2 | 16.5       | 43.8 | 43.8 |
| Volume/Cap:  | 0.42        | 0.75 | 0.75 | 0.75        | 0.42 | 0.42 | 0.75       | 0.42 | 0.25 | 0.27       | 0.75 | 0.75 |
| Delay/Veh:   | 54.5        | 40.0 | 40.0 | 75.7        | 38.8 | 38.8 | 64.8       | 36.1 | 33.8 | 56.6       | 46.2 | 46.2 |
| User DelAdj:   | 1.00        | 1.00 | 1.00 | 1.00        | 1.00 | 1.00 | 1.00       | 1.00 | 1.00 | 1.00       | 1.00 | 1.00 |
| AdjDel/Veh:  | 54.5        | 40.0 | 40.0 | 75.7        | 38.8 | 38.8 | 64.8       | 36.1 | 33.8 | 56.6       | 46.2 | 46.2 |
| LOS by Move:   | D           | D    | D    | E           | D    | D    | E          | D    | C    | E          | D    | D    |
| HCM2k95thQ:  | 10          | 36   | 36   | 10          | 15   | 15   | 16         | 16   | 9    | 5          | 30   | 30   |

Note: Queue reported is the number of cars per lane.

BART

Level Of Service Computation Report  
 2000 HCM Operations (Future Volume Alternative)  
 PM - Exist + Proj Conditions

Intersection #3417: Coleman/Taylor [Study Int 39]

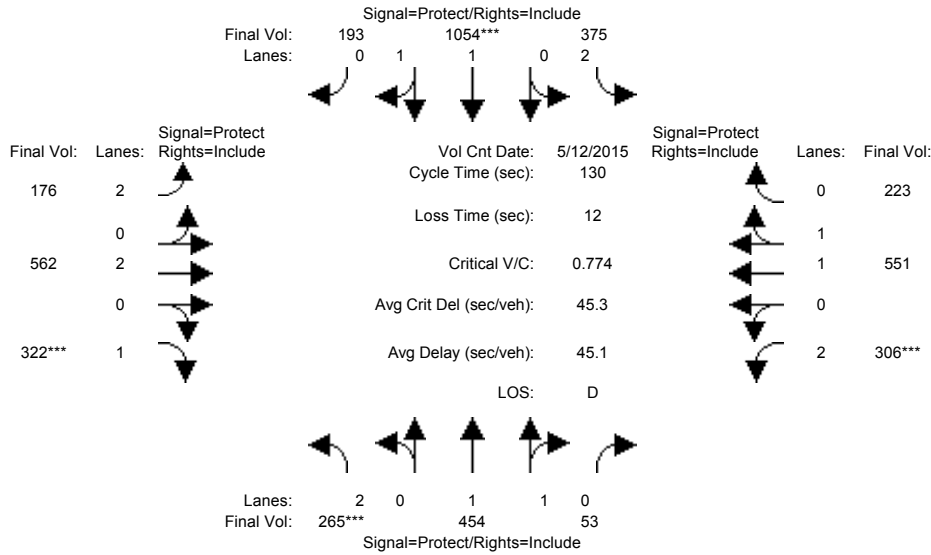

| Approach:  | North Bound |      |      | South Bound |      |      | East Bound |      |      | West Bound |      |      |
|--|-------------|------|------|-------------|------|------|------------|------|------|------------|------|------|
| Movement:  | L           | T    | R    | L           | T    | R    | L          | T    | R    | L          | T    | R    |
| Min. Green:  | 7           | 10   | 10   | 7           | 10   | 10   | 7          | 10   | 10   | 7          | 10   | 10   |
| Y+R:   | 4.0         | 4.0  | 4.0  | 4.0         | 4.0  | 4.0  | 4.0        | 4.0  | 4.0  | 4.0        | 4.0  | 4.0  |
| Volume Module: >> Count Date: 12 May 2015 << 5:00-6:00PM |             |      |      |             |      |      |            |      |      |            |      |      |
| Base Vol:  | 265         | 454  | 53   | 375         | 1054 | 193  | 176        | 562  | 322  | 306        | 551  | 223  |
| Growth Adj:  | 1.00        | 1.00 | 1.00 | 1.00        | 1.00 | 1.00 | 1.00       | 1.00 | 1.00 | 1.00       | 1.00 | 1.00 |
| Initial Bse:   | 265         | 454  | 53   | 375         | 1054 | 193  | 176        | 562  | 322  | 306        | 551  | 223  |
| Added Vol:   | 0           | 0    | 0    | 0           | 0    | 0    | 0          | 0    | 0    | 0          | 0    | 0    |
| PasserByVol:   | 0           | 0    | 0    | 0           | 0    | 0    | 0          | 0    | 0    | 0          | 0    | 0    |
| Initial Fut:   | 265         | 454  | 53   | 375         | 1054 | 193  | 176        | 562  | 322  | 306        | 551  | 223  |
| User Adj:  | 1.00        | 1.00 | 1.00 | 1.00        | 1.00 | 1.00 | 1.00       | 1.00 | 1.00 | 1.00       | 1.00 | 1.00 |
| PHF Adj:   | 1.00        | 1.00 | 1.00 | 1.00        | 1.00 | 1.00 | 1.00       | 1.00 | 1.00 | 1.00       | 1.00 | 1.00 |
| PHF Volume:  | 265         | 454  | 53   | 375         | 1054 | 193  | 176        | 562  | 322  | 306        | 551  | 223  |
| Reduct Vol:  | 0           | 0    | 0    | 0           | 0    | 0    | 0          | 0    | 0    | 0          | 0    | 0    |
| Reduced Vol:   | 265         | 454  | 53   | 375         | 1054 | 193  | 176        | 562  | 322  | 306        | 551  | 223  |
| PCE Adj:   | 1.00        | 1.00 | 1.00 | 1.00        | 1.00 | 1.00 | 1.00       | 1.00 | 1.00 | 1.00       | 1.00 | 1.00 |
| MLF Adj:   | 1.00        | 1.00 | 1.00 | 1.00        | 1.00 | 1.00 | 1.00       | 1.00 | 1.00 | 1.00       | 1.00 | 1.00 |
| Final Volume:  | 265         | 454  | 53   | 375         | 1054 | 193  | 176        | 562  | 322  | 306        | 551  | 223  |
| Saturation Flow Module:                                  |             |      |      |             |      |      |            |      |      |            |      |      |
| Sat/Lane:  | 1900        | 1900 | 1900 | 1900        | 1900 | 1900 | 1900       | 1900 | 1900 | 1900       | 1900 | 1900 |
| Adjustment:  | 0.83        | 0.98 | 0.95 | 0.83        | 0.98 | 0.95 | 0.83       | 1.00 | 0.92 | 0.83       | 0.98 | 0.95 |
| Lanes:   | 2.00        | 1.79 | 0.21 | 2.00        | 1.68 | 0.32 | 2.00       | 2.00 | 1.00 | 2.00       | 1.41 | 0.59 |
| Final Sat.:  | 3150        | 3313 | 387  | 3150        | 3127 | 573  | 3150       | 3800 | 1750 | 3150       | 2633 | 1066 |
| Capacity Analysis Module:                                |             |      |      |             |      |      |            |      |      |            |      |      |
| Vol/Sat:   | 0.08        | 0.14 | 0.14 | 0.12        | 0.34 | 0.34 | 0.06       | 0.15 | 0.18 | 0.10       | 0.21 | 0.21 |
| Crit Moves:  | ****        |      |      | ****        |      |      | ****       |      | **** | ****       |      |      |
| Green Time:  | 14.1        | 37.9 | 37.9 | 32.9        | 56.6 | 56.6 | 10.0       | 30.9 | 30.9 | 16.3       | 37.3 | 37.3 |
| Volume/Cap:  | 0.77        | 0.47 | 0.47 | 0.47        | 0.77 | 0.77 | 0.73       | 0.62 | 0.77 | 0.77       | 0.73 | 0.73 |
| Delay/Veh:   | 66.9        | 38.2 | 38.2 | 41.6        | 33.6 | 33.6 | 69.5       | 45.7 | 55.0 | 64.2       | 44.4 | 44.4 |
| User DelAdj:   | 1.00        | 1.00 | 1.00 | 1.00        | 1.00 | 1.00 | 1.00       | 1.00 | 1.00 | 1.00       | 1.00 | 1.00 |
| AdjDel/Veh:  | 66.9        | 38.2 | 38.2 | 41.6        | 33.6 | 33.6 | 69.5       | 45.7 | 55.0 | 64.2       | 44.4 | 44.4 |
| LOS by Move:   | E           | D    | D    | D           | C    | C    | E          | D    | E    | E          | D    | D    |
| HCM2k95thQ:  | 15          | 16   | 16   | 14          | 36   | 36   | 8          | 18   | 23   | 14         | 25   | 25   |

Note: Queue reported is the number of cars per lane.

BART

Level Of Service Computation Report  
 2000 HCM Operations (Future Volume Alternative)  
 AM - Exist + Proj Conditions

Intersection #3596: JACKSON/McKEE [Study Int 8]

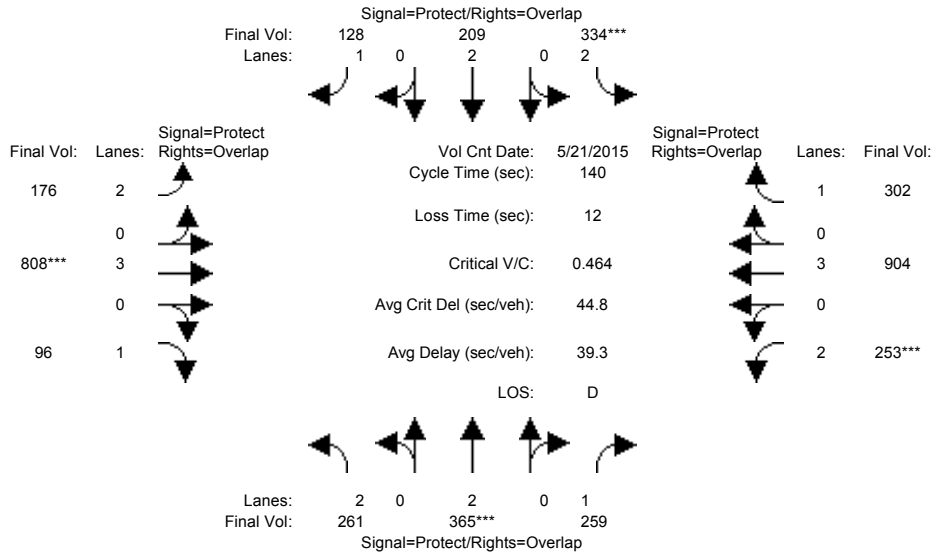

| Approach:  | North Bound |      |      | South Bound |      |      | East Bound |      |      | West Bound |      |      |
|--|-------------|------|------|-------------|------|------|------------|------|------|------------|------|------|
| Movement:  | L           | T    | R    | L           | T    | R    | L          | T    | R    | L          | T    | R    |
| Min. Green:  | 7           | 10   | 10   | 7           | 10   | 10   | 7          | 10   | 10   | 7          | 10   | 10   |
| Y+R:   | 4.0         | 4.0  | 4.0  | 4.0         | 4.0  | 4.0  | 4.0        | 4.0  | 4.0  | 4.0        | 4.0  | 4.0  |
| Volume Module: >> Count Date: 21 May 2015 << 7:30-8:30AM |             |      |      |             |      |      |            |      |      |            |      |      |
| Base Vol:  | 261         | 365  | 259  | 334         | 209  | 128  | 176        | 808  | 96   | 253        | 904  | 302  |
| Growth Adj:  | 1.00        | 1.00 | 1.00 | 1.00        | 1.00 | 1.00 | 1.00       | 1.00 | 1.00 | 1.00       | 1.00 | 1.00 |
| Initial Bse:   | 261         | 365  | 259  | 334         | 209  | 128  | 176        | 808  | 96   | 253        | 904  | 302  |
| Added Vol:   | 0           | 0    | 0    | 0           | 0    | 0    | 0          | 0    | 0    | 0          | 0    | 0    |
| PasserByVol:   | 0           | 0    | 0    | 0           | 0    | 0    | 0          | 0    | 0    | 0          | 0    | 0    |
| Initial Fut:   | 261         | 365  | 259  | 334         | 209  | 128  | 176        | 808  | 96   | 253        | 904  | 302  |
| User Adj:  | 1.00        | 1.00 | 1.00 | 1.00        | 1.00 | 1.00 | 1.00       | 1.00 | 1.00 | 1.00       | 1.00 | 1.00 |
| PHF Adj:   | 1.00        | 1.00 | 1.00 | 1.00        | 1.00 | 1.00 | 1.00       | 1.00 | 1.00 | 1.00       | 1.00 | 1.00 |
| PHF Volume:  | 261         | 365  | 259  | 334         | 209  | 128  | 176        | 808  | 96   | 253        | 904  | 302  |
| Reduct Vol:  | 0           | 0    | 0    | 0           | 0    | 0    | 0          | 0    | 0    | 0          | 0    | 0    |
| Reduced Vol:   | 261         | 365  | 259  | 334         | 209  | 128  | 176        | 808  | 96   | 253        | 904  | 302  |
| PCE Adj:   | 1.00        | 1.00 | 1.00 | 1.00        | 1.00 | 1.00 | 1.00       | 1.00 | 1.00 | 1.00       | 1.00 | 1.00 |
| MLF Adj:   | 1.00        | 1.00 | 1.00 | 1.00        | 1.00 | 1.00 | 1.00       | 1.00 | 1.00 | 1.00       | 1.00 | 1.00 |
| Final Volume:  | 261         | 365  | 259  | 334         | 209  | 128  | 176        | 808  | 96   | 253        | 904  | 302  |
| Saturation Flow Module:                                  |             |      |      |             |      |      |            |      |      |            |      |      |
| Sat/Lane:  | 1900        | 1900 | 1900 | 1900        | 1900 | 1900 | 1900       | 1900 | 1900 | 1900       | 1900 | 1900 |
| Adjustment:  | 0.83        | 1.00 | 0.92 | 0.83        | 1.00 | 0.92 | 0.83       | 1.00 | 0.92 | 0.83       | 1.00 | 0.92 |
| Lanes:   | 2.00        | 2.00 | 1.00 | 2.00        | 2.00 | 1.00 | 2.00       | 3.00 | 1.00 | 2.00       | 3.00 | 1.00 |
| Final Sat.:  | 3150        | 3800 | 1750 | 3150        | 3800 | 1750 | 3150       | 5700 | 1750 | 3150       | 5700 | 1750 |
| Capacity Analysis Module:                                |             |      |      |             |      |      |            |      |      |            |      |      |
| Vol/Sat:   | 0.08        | 0.10 | 0.15 | 0.11        | 0.06 | 0.07 | 0.06       | 0.14 | 0.05 | 0.08       | 0.16 | 0.17 |
| Crit Moves:  | ****        | **** | **** | ****        | **** | **** | ****       | **** | **** | ****       | **** | **** |
| Green Time:  | 32.8        | 29.0 | 53.2 | 32.0        | 28.2 | 45.7 | 17.5       | 42.8 | 75.5 | 24.2       | 49.6 | 81.6 |
| Volume/Cap:  | 0.35        | 0.46 | 0.39 | 0.46        | 0.27 | 0.22 | 0.45       | 0.46 | 0.10 | 0.46       | 0.45 | 0.30 |
| Delay/Veh:   | 45.1        | 49.1 | 31.9 | 47.1        | 47.4 | 34.5 | 57.6       | 39.5 | 15.8 | 52.7       | 34.9 | 14.9 |
| User DelAdj:   | 1.00        | 1.00 | 1.00 | 1.00        | 1.00 | 1.00 | 1.00       | 1.00 | 1.00 | 1.00       | 1.00 | 1.00 |
| AdjDel/Veh:  | 45.1        | 49.1 | 31.9 | 47.1        | 47.4 | 34.5 | 57.6       | 39.5 | 15.8 | 52.7       | 34.9 | 14.9 |
| LOS by Move:   | D           | D    | C    | D           | D    | C    | E          | D    | B    | D          | C    | B    |
| HCM2k95thQ:  | 11          | 13   | 16   | 14          | 7    | 8    | 8          | 17   | 4    | 12         | 18   | 13   |

Note: Queue reported is the number of cars per lane.



BART

Level Of Service Computation Report  
2000 HCM Operations (Future Volume Alternative)  
PM - Exist + Proj Conditions

Intersection #3596: JACKSON/McKEE [Study Int 8]

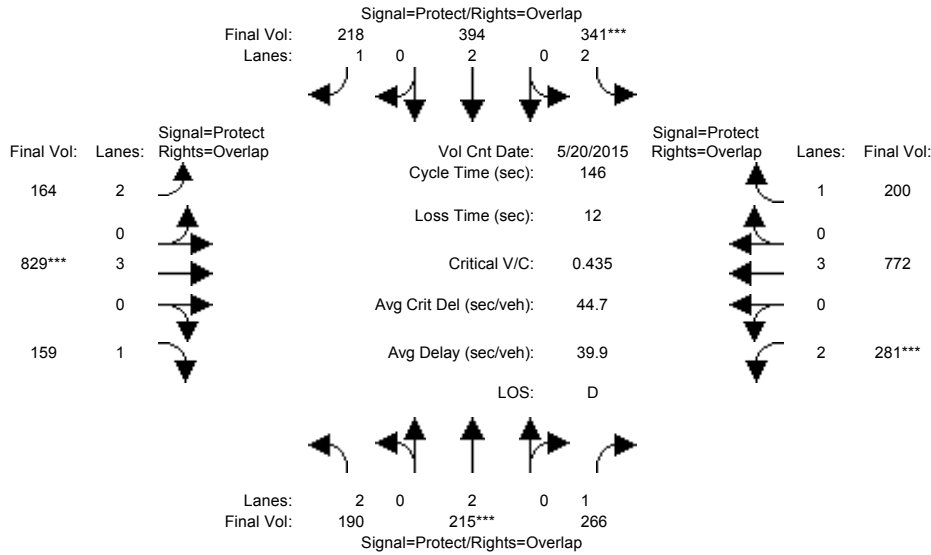

| Approach:  | North Bound |      |      | South Bound |      |      | East Bound |      |      | West Bound |      |      |
|--|-------------|------|------|-------------|------|------|------------|------|------|------------|------|------|
| Movement:  | L           | T    | R    | L           | T    | R    | L          | T    | R    | L          | T    | R    |
| Min. Green:  | 7           | 10   | 10   | 7           | 10   | 10   | 7          | 10   | 10   | 7          | 10   | 10   |
| Y+R:   | 4.0         | 4.0  | 4.0  | 4.0         | 4.0  | 4.0  | 4.0        | 4.0  | 4.0  | 4.0        | 4.0  | 4.0  |
| Volume Module: >> Count Date: 20 May 2015 << 5:00-6:00PM |             |      |      |             |      |      |            |      |      |            |      |      |
| Base Vol:  | 190         | 215  | 266  | 341         | 394  | 218  | 164        | 829  | 159  | 281        | 772  | 200  |
| Growth Adj:  | 1.00        | 1.00 | 1.00 | 1.00        | 1.00 | 1.00 | 1.00       | 1.00 | 1.00 | 1.00       | 1.00 | 1.00 |
| Initial Bse:   | 190         | 215  | 266  | 341         | 394  | 218  | 164        | 829  | 159  | 281        | 772  | 200  |
| Added Vol:   | 0           | 0    | 0    | 0           | 0    | 0    | 0          | 0    | 0    | 0          | 0    | 0    |
| PasserByVol:   | 0           | 0    | 0    | 0           | 0    | 0    | 0          | 0    | 0    | 0          | 0    | 0    |
| Initial Fut:   | 190         | 215  | 266  | 341         | 394  | 218  | 164        | 829  | 159  | 281        | 772  | 200  |
| User Adj:  | 1.00        | 1.00 | 1.00 | 1.00        | 1.00 | 1.00 | 1.00       | 1.00 | 1.00 | 1.00       | 1.00 | 1.00 |
| PHF Adj:   | 1.00        | 1.00 | 1.00 | 1.00        | 1.00 | 1.00 | 1.00       | 1.00 | 1.00 | 1.00       | 1.00 | 1.00 |
| PHF Volume:  | 190         | 215  | 266  | 341         | 394  | 218  | 164        | 829  | 159  | 281        | 772  | 200  |
| Reduct Vol:  | 0           | 0    | 0    | 0           | 0    | 0    | 0          | 0    | 0    | 0          | 0    | 0    |
| Reduced Vol:   | 190         | 215  | 266  | 341         | 394  | 218  | 164        | 829  | 159  | 281        | 772  | 200  |
| PCE Adj:   | 1.00        | 1.00 | 1.00 | 1.00        | 1.00 | 1.00 | 1.00       | 1.00 | 1.00 | 1.00       | 1.00 | 1.00 |
| MLF Adj:   | 1.00        | 1.00 | 1.00 | 1.00        | 1.00 | 1.00 | 1.00       | 1.00 | 1.00 | 1.00       | 1.00 | 1.00 |
| Final Volume:  | 190         | 215  | 266  | 341         | 394  | 218  | 164        | 829  | 159  | 281        | 772  | 200  |
| Saturation Flow Module:                                  |             |      |      |             |      |      |            |      |      |            |      |      |
| Sat/Lane:  | 1900        | 1900 | 1900 | 1900        | 1900 | 1900 | 1900       | 1900 | 1900 | 1900       | 1900 | 1900 |
| Adjustment:  | 0.83        | 1.00 | 0.92 | 0.83        | 1.00 | 0.92 | 0.83       | 1.00 | 0.92 | 0.83       | 1.00 | 0.92 |
| Lanes:   | 2.00        | 2.00 | 1.00 | 2.00        | 2.00 | 1.00 | 2.00       | 3.00 | 1.00 | 2.00       | 3.00 | 1.00 |
| Final Sat.:  | 3150        | 3800 | 1750 | 3150        | 3800 | 1750 | 3150       | 5700 | 1750 | 3150       | 5700 | 1750 |
| Capacity Analysis Module:                                |             |      |      |             |      |      |            |      |      |            |      |      |
| Vol/Sat:   | 0.06        | 0.06 | 0.15 | 0.11        | 0.10 | 0.12 | 0.05       | 0.15 | 0.09 | 0.09       | 0.14 | 0.11 |
| Crit Moves:  | ****        | **** | **** | ****        | **** | **** | ****       | **** | **** | ****       | **** | **** |
| Green Time:  | 20.3        | 19.0 | 48.9 | 36.3        | 35.0 | 56.8 | 21.9       | 48.8 | 69.1 | 29.9       | 56.9 | 93.2 |
| Volume/Cap:  | 0.43        | 0.44 | 0.45 | 0.44        | 0.43 | 0.32 | 0.35       | 0.44 | 0.19 | 0.44       | 0.35 | 0.18 |
| Delay/Veh:   | 58.2        | 59.2 | 38.6 | 46.6        | 47.4 | 31.4 | 56.1       | 38.0 | 22.4 | 51.1       | 31.6 | 10.9 |
| User DelAdj:   | 1.00        | 1.00 | 1.00 | 1.00        | 1.00 | 1.00 | 1.00       | 1.00 | 1.00 | 1.00       | 1.00 | 1.00 |
| AdjDel/Veh:  | 58.2        | 59.2 | 38.6 | 46.6        | 47.4 | 31.4 | 56.1       | 38.0 | 22.4 | 51.1       | 31.6 | 10.9 |
| LOS by Move:   | E           | E    | D    | D           | D    | C    | E          | D    | C    | D          | C    | B    |
| HCM2k95thQ:  | 10          | 9    | 18   | 14          | 14   | 13   | 8          | 17   | 8    | 13         | 15   | 8    |

Note: Queue reported is the number of cars per lane.

BART

Level Of Service Computation Report  
2000 HCM Operations (Future Volume Alternative)  
AM - Exist + Proj Conditions

Intersection #3612: JULIAN/21ST [Study Int 1]

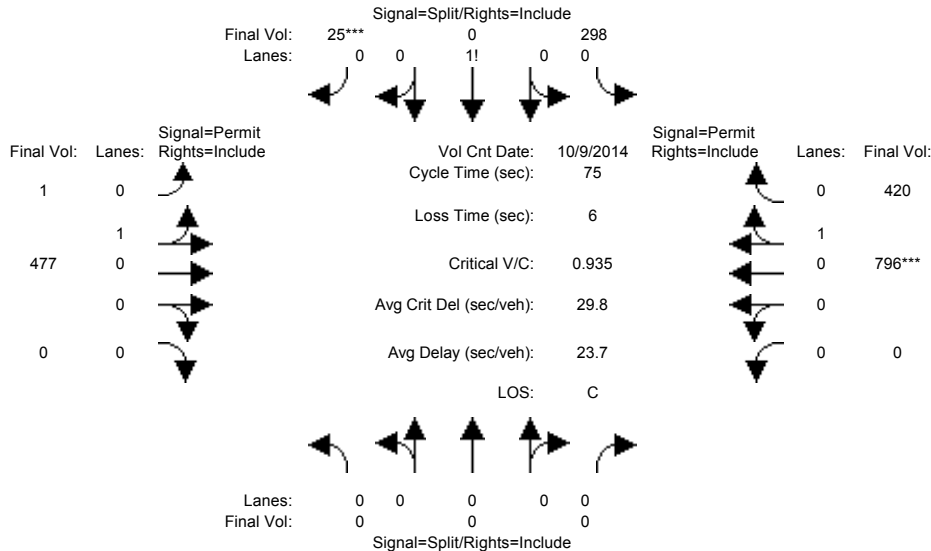

| Approach:                                   | North Bound |      |      | South Bound |      |      | East Bound |      |      | West Bound |      |      |
|---|-------------|------|------|-------------|------|------|------------|------|------|------------|------|------|
| Movement:                                   | L           | T    | R    | L           | T    | R    | L          | T    | R    | L          | T    | R    |
| Min. Green:                                 | 0           | 0    | 0    | 10          | 0    | 10   | 10         | 10   | 0    | 0          | 10   | 10   |
| Y+R:  | 4.0         | 4.0  | 4.0  | 4.0         | 4.0  | 4.0  | 4.0        | 4.0  | 4.0  | 4.0        | 4.0  | 4.0  |
| Volume Module: >> Count Date: 9 Oct 2014 << |             |      |      |             |      |      |            |      |      |            |      |      |
| Base Vol:                                   | 0           | 0    | 0    | 298         | 0    | 25   | 1          | 477  | 0    | 0          | 796  | 420  |
| Growth Adj:                                 | 1.00        | 1.00 | 1.00 | 1.00        | 1.00 | 1.00 | 1.00       | 1.00 | 1.00 | 1.00       | 1.00 | 1.00 |
| Initial Bse:                                | 0           | 0    | 0    | 298         | 0    | 25   | 1          | 477  | 0    | 0          | 796  | 420  |
| Added Vol:                                  | 0           | 0    | 0    | 0           | 0    | 0    | 0          | 0    | 0    | 0          | 0    | 0    |
| PasserByVol:                                | 0           | 0    | 0    | 0           | 0    | 0    | 0          | 0    | 0    | 0          | 0    | 0    |
| Initial Fut:                                | 0           | 0    | 0    | 298         | 0    | 25   | 1          | 477  | 0    | 0          | 796  | 420  |
| User Adj:                                   | 1.00        | 1.00 | 1.00 | 1.00        | 1.00 | 1.00 | 1.00       | 1.00 | 1.00 | 1.00       | 1.00 | 1.00 |
| PHF Adj:                                    | 1.00        | 1.00 | 1.00 | 1.00        | 1.00 | 1.00 | 1.00       | 1.00 | 1.00 | 1.00       | 1.00 | 1.00 |
| PHF Volume:                                 | 0           | 0    | 0    | 298         | 0    | 25   | 1          | 477  | 0    | 0          | 796  | 420  |
| Reduct Vol:                                 | 0           | 0    | 0    | 0           | 0    | 0    | 0          | 0    | 0    | 0          | 0    | 0    |
| Reduced Vol:                                | 0           | 0    | 0    | 298         | 0    | 25   | 1          | 477  | 0    | 0          | 796  | 420  |
| PCE Adj:                                    | 1.00        | 1.00 | 1.00 | 1.00        | 1.00 | 1.00 | 1.00       | 1.00 | 1.00 | 1.00       | 1.00 | 1.00 |
| MLF Adj:                                    | 1.00        | 1.00 | 1.00 | 1.00        | 1.00 | 1.00 | 1.00       | 1.00 | 1.00 | 1.00       | 1.00 | 1.00 |
| Final Volume:                               | 0           | 0    | 0    | 298         | 0    | 25   | 1          | 477  | 0    | 0          | 796  | 420  |
| Saturation Flow Module:                     |             |      |      |             |      |      |            |      |      |            |      |      |
| Sat/Lane:                                   | 1900        | 1900 | 1900 | 1900        | 1900 | 1900 | 1900       | 1900 | 1900 | 1900       | 1900 | 1900 |
| Adjustment:                                 | 0.92        | 1.00 | 0.92 | 0.92        | 0.92 | 0.92 | 0.95       | 0.95 | 0.92 | 0.92       | 0.95 | 0.95 |
| Lanes:                                      | 0.00        | 0.00 | 0.00 | 0.92        | 0.00 | 0.08 | 0.01       | 0.99 | 0.00 | 0.00       | 0.65 | 0.35 |
| Final Sat.:                                 | 0           | 0    | 0    | 1615        | 0    | 135  | 4          | 1796 | 0    | 0          | 1178 | 622  |
| Capacity Analysis Module:                   |             |      |      |             |      |      |            |      |      |            |      |      |
| Vol/Sat:                                    | 0.00        | 0.00 | 0.00 | 0.18        | 0.00 | 0.18 | 0.27       | 0.27 | 0.00 | 0.00       | 0.68 | 0.68 |
| Crit Moves:                                 | *****       |      |      |             |      |      |            |      |      |            |      |      |
| Green Time:                                 | 0.0         | 0.0  | 0.0  | 14.8        | 0.0  | 14.8 | 54.2       | 54.2 | 0.0  | 0.0        | 54.2 | 54.2 |
| Volume/Cap:                                 | 0.00        | 0.00 | 0.00 | 0.93        | 0.00 | 0.93 | 0.37       | 0.37 | 0.00 | 0.00       | 0.93 | 0.93 |
| Delay/Veh:                                  | 0.0         | 0.0  | 0.0  | 61.7        | 0.0  | 61.7 | 4.1        | 4.1  | 0.0  | 0.0        | 21.4 | 21.4 |
| User DelAdj:                                | 1.00        | 1.00 | 1.00 | 1.00        | 1.00 | 1.00 | 1.00       | 1.00 | 1.00 | 1.00       | 1.00 | 1.00 |
| AdjDel/Veh:                                 | 0.0         | 0.0  | 0.0  | 61.7        | 0.0  | 61.7 | 4.1        | 4.1  | 0.0  | 0.0        | 21.4 | 21.4 |
| LOS by Move:                                | A           | A    | A    | E           | A    | E    | A          | A    | A    | A          | C    | C    |
| HCM2k95thQ:                                 | 0           | 0    | 0    | 22          | 0    | 22   | 9          | 9    | 0    | 0          | 47   | 47   |

Note: Queue reported is the number of cars per lane.

BART

Level Of Service Computation Report  
 2000 HCM Operations (Future Volume Alternative)  
 PM - Exist + Proj Conditions

Intersection #3612: JULIAN/21ST [Study Int 1]

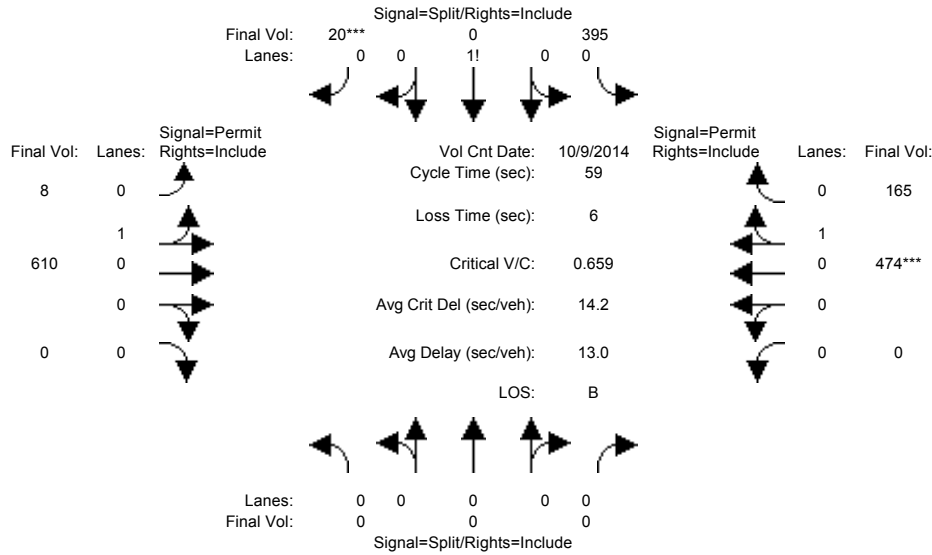

| Approach:                                   | North Bound |      |      | South Bound |      |      | East Bound |      |      | West Bound |      |      |
|---|-------------|------|------|-------------|------|------|------------|------|------|------------|------|------|
| Movement:                                   | L           | T    | R    | L           | T    | R    | L          | T    | R    | L          | T    | R    |
| Min. Green:                                 | 0           | 0    | 0    | 10          | 0    | 10   | 10         | 10   | 0    | 0          | 10   | 10   |
| Y+R:  | 4.0         | 4.0  | 4.0  | 4.0         | 4.0  | 4.0  | 4.0        | 4.0  | 4.0  | 4.0        | 4.0  | 4.0  |
| Volume Module: >> Count Date: 9 Oct 2014 << |             |      |      |             |      |      |            |      |      |            |      |      |
| Base Vol:                                   | 0           | 0    | 0    | 395         | 0    | 20   | 8          | 610  | 0    | 0          | 474  | 165  |
| Growth Adj:                                 | 1.00        | 1.00 | 1.00 | 1.00        | 1.00 | 1.00 | 1.00       | 1.00 | 1.00 | 1.00       | 1.00 | 1.00 |
| Initial Bse:                                | 0           | 0    | 0    | 395         | 0    | 20   | 8          | 610  | 0    | 0          | 474  | 165  |
| Added Vol:                                  | 0           | 0    | 0    | 0           | 0    | 0    | 0          | 0    | 0    | 0          | 0    | 0    |
| PasserByVol:                                | 0           | 0    | 0    | 0           | 0    | 0    | 0          | 0    | 0    | 0          | 0    | 0    |
| Initial Fut:                                | 0           | 0    | 0    | 395         | 0    | 20   | 8          | 610  | 0    | 0          | 474  | 165  |
| User Adj:                                   | 1.00        | 1.00 | 1.00 | 1.00        | 1.00 | 1.00 | 1.00       | 1.00 | 1.00 | 1.00       | 1.00 | 1.00 |
| PHF Adj:                                    | 1.00        | 1.00 | 1.00 | 1.00        | 1.00 | 1.00 | 1.00       | 1.00 | 1.00 | 1.00       | 1.00 | 1.00 |
| PHF Volume:                                 | 0           | 0    | 0    | 395         | 0    | 20   | 8          | 610  | 0    | 0          | 474  | 165  |
| Reduct Vol:                                 | 0           | 0    | 0    | 0           | 0    | 0    | 0          | 0    | 0    | 0          | 0    | 0    |
| Reduced Vol:                                | 0           | 0    | 0    | 395         | 0    | 20   | 8          | 610  | 0    | 0          | 474  | 165  |
| PCE Adj:                                    | 1.00        | 1.00 | 1.00 | 1.00        | 1.00 | 1.00 | 1.00       | 1.00 | 1.00 | 1.00       | 1.00 | 1.00 |
| MLF Adj:                                    | 1.00        | 1.00 | 1.00 | 1.00        | 1.00 | 1.00 | 1.00       | 1.00 | 1.00 | 1.00       | 1.00 | 1.00 |
| Final Volume:                               | 0           | 0    | 0    | 395         | 0    | 20   | 8          | 610  | 0    | 0          | 474  | 165  |
| Saturation Flow Module:                     |             |      |      |             |      |      |            |      |      |            |      |      |
| Sat/Lane:                                   | 1900        | 1900 | 1900 | 1900        | 1900 | 1900 | 1900       | 1900 | 1900 | 1900       | 1900 | 1900 |
| Adjustment:                                 | 0.92        | 1.00 | 0.92 | 0.92        | 0.92 | 0.92 | 0.95       | 0.95 | 0.92 | 0.92       | 0.95 | 0.95 |
| Lanes:                                      | 0.00        | 0.00 | 0.00 | 0.95        | 0.00 | 0.05 | 0.01       | 0.99 | 0.00 | 0.00       | 0.74 | 0.26 |
| Final Sat.:                                 | 0           | 0    | 0    | 1666        | 0    | 84   | 23         | 1777 | 0    | 0          | 1335 | 465  |
| Capacity Analysis Module:                   |             |      |      |             |      |      |            |      |      |            |      |      |
| Vol/Sat:                                    | 0.00        | 0.00 | 0.00 | 0.24        | 0.00 | 0.24 | 0.34       | 0.34 | 0.00 | 0.00       | 0.36 | 0.36 |
| Crit Moves:                                 | *****       |      |      |             |      |      |            |      |      |            |      |      |
| Green Time:                                 | 0.0         | 0.0  | 0.0  | 21.2        | 0.0  | 21.2 | 31.8       | 31.8 | 0.0  | 0.0        | 31.8 | 31.8 |
| Volume/Cap:                                 | 0.00        | 0.00 | 0.00 | 0.66        | 0.00 | 0.66 | 0.64       | 0.64 | 0.00 | 0.00       | 0.66 | 0.66 |
| Delay/Veh:                                  | 0.0         | 0.0  | 0.0  | 18.4        | 0.0  | 18.4 | 11.0       | 11.0 | 0.0  | 0.0        | 11.4 | 11.4 |
| User DelAdj:                                | 1.00        | 1.00 | 1.00 | 1.00        | 1.00 | 1.00 | 1.00       | 1.00 | 1.00 | 1.00       | 1.00 | 1.00 |
| AdjDel/Veh:                                 | 0.0         | 0.0  | 0.0  | 18.4        | 0.0  | 18.4 | 11.0       | 11.0 | 0.0  | 0.0        | 11.4 | 11.4 |
| LOS by Move:                                | A           | A    | A    | B           | A    | B    | B          | B    | A    | A          | B    | B    |
| HCM2k95thQ:                                 | 0           | 0    | 0    | 15          | 0    | 15   | 16         | 16   | 0    | 0          | 17   | 17   |

Note: Queue reported is the number of cars per lane.

BART

Level Of Service Computation Report  
 2000 HCM Operations (Future Volume Alternative)  
 AM - Exist + Proj Conditions

Intersection #3613: JULIAN/24TH [Study Int 2]

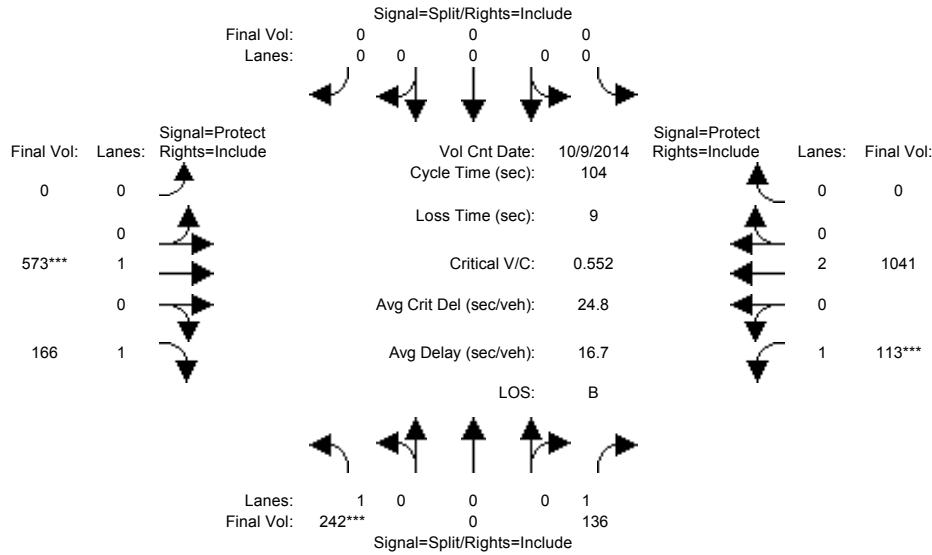

| Approach:                                   | North Bound |      |      | South Bound |      |      | East Bound |      |      | West Bound |      |      |
|---|-------------|------|------|-------------|------|------|------------|------|------|------------|------|------|
| Movement:                                   | L           | T    | R    | L           | T    | R    | L          | T    | R    | L          | T    | R    |
| Min. Green:                                 | 10          | 0    | 10   | 0           | 0    | 0    | 0          | 10   | 10   | 7          | 10   | 0    |
| Y+R:  | 4.0         | 4.0  | 4.0  | 4.0         | 4.0  | 4.0  | 4.0        | 4.0  | 4.0  | 4.0        | 4.0  | 0    |
| Volume Module: >> Count Date: 9 Oct 2014 << |             |      |      |             |      |      |            |      |      |            |      |      |
| Base Vol:                                   | 242         | 0    | 136  | 0           | 0    | 0    | 0          | 573  | 166  | 113        | 1041 | 0    |
| Growth Adj:                                 | 1.00        | 1.00 | 1.00 | 1.00        | 1.00 | 1.00 | 1.00       | 1.00 | 1.00 | 1.00       | 1.00 | 1.00 |
| Initial Bse:                                | 242         | 0    | 136  | 0           | 0    | 0    | 0          | 573  | 166  | 113        | 1041 | 0    |
| Added Vol:                                  | 0           | 0    | 0    | 0           | 0    | 0    | 0          | 0    | 0    | 0          | 0    | 0    |
| PasserByVol:                                | 0           | 0    | 0    | 0           | 0    | 0    | 0          | 0    | 0    | 0          | 0    | 0    |
| Initial Fut:                                | 242         | 0    | 136  | 0           | 0    | 0    | 0          | 573  | 166  | 113        | 1041 | 0    |
| User Adj:                                   | 1.00        | 1.00 | 1.00 | 1.00        | 1.00 | 1.00 | 1.00       | 1.00 | 1.00 | 1.00       | 1.00 | 1.00 |
| PHF Adj:                                    | 1.00        | 1.00 | 1.00 | 1.00        | 1.00 | 1.00 | 1.00       | 1.00 | 1.00 | 1.00       | 1.00 | 1.00 |
| PHF Volume:                                 | 242         | 0    | 136  | 0           | 0    | 0    | 0          | 573  | 166  | 113        | 1041 | 0    |
| Reduct Vol:                                 | 0           | 0    | 0    | 0           | 0    | 0    | 0          | 0    | 0    | 0          | 0    | 0    |
| Reduced Vol:                                | 242         | 0    | 136  | 0           | 0    | 0    | 0          | 573  | 166  | 113        | 1041 | 0    |
| PCE Adj:                                    | 1.00        | 1.00 | 1.00 | 1.00        | 1.00 | 1.00 | 1.00       | 1.00 | 1.00 | 1.00       | 1.00 | 1.00 |
| MLF Adj:                                    | 1.00        | 1.00 | 1.00 | 1.00        | 1.00 | 1.00 | 1.00       | 1.00 | 1.00 | 1.00       | 1.00 | 1.00 |
| Final Volume:                               | 242         | 0    | 136  | 0           | 0    | 0    | 0          | 573  | 166  | 113        | 1041 | 0    |
| Saturation Flow Module:                     |             |      |      |             |      |      |            |      |      |            |      |      |
| Sat/Lane:                                   | 1900        | 1900 | 1900 | 1900        | 1900 | 1900 | 1900       | 1900 | 1900 | 1900       | 1900 | 1900 |
| Adjustment:                                 | 0.92        | 1.00 | 0.92 | 0.92        | 1.00 | 0.92 | 0.92       | 1.00 | 0.92 | 0.92       | 1.00 | 0.92 |
| Lanes:                                      | 1.00        | 0.00 | 1.00 | 0.00        | 0.00 | 0.00 | 0.00       | 1.00 | 1.00 | 1.00       | 2.00 | 0.00 |
| Final Sat.:                                 | 1750        | 0    | 1750 | 0           | 0    | 0    | 0          | 1900 | 1750 | 1750       | 3800 | 0    |
| Capacity Analysis Module:                   |             |      |      |             |      |      |            |      |      |            |      |      |
| Vol/Sat:                                    | 0.14        | 0.00 | 0.08 | 0.00        | 0.00 | 0.00 | 0.00       | 0.30 | 0.09 | 0.06       | 0.27 | 0.00 |
| Crit Moves:                                 | ****        |      |      |             |      |      | ****       |      |      | ****       |      |      |
| Green Time:                                 | 26.0        | 0.0  | 26.0 | 0.0         | 0.0  | 0.0  | 0.0        | 56.8 | 56.8 | 12.2       | 69.0 | 0.0  |
| Volume/Cap:                                 | 0.55        | 0.00 | 0.31 | 0.00        | 0.00 | 0.00 | 0.00       | 0.55 | 0.17 | 0.55       | 0.41 | 0.00 |
| Delay/Veh:                                  | 35.4        | 0.0  | 32.1 | 0.0         | 0.0  | 0.0  | 0.0        | 16.0 | 11.9 | 46.6       | 8.2  | 0.0  |
| User DelAdj:                                | 1.00        | 1.00 | 1.00 | 1.00        | 1.00 | 1.00 | 1.00       | 1.00 | 1.00 | 1.00       | 1.00 | 1.00 |
| AdjDel/Veh:                                 | 35.4        | 0.0  | 32.1 | 0.0         | 0.0  | 0.0  | 0.0        | 16.0 | 11.9 | 46.6       | 8.2  | 0.0  |
| LOS by Move:                                | D           | A    | C    | A           | A    | A    | A          | B    | B    | D          | A    | A    |
| HCM2k95thQ:                                 | 15          | 0    | 8    | 0           | 0    | 0    | 0          | 21   | 6    | 9          | 15   | 0    |

Note: Queue reported is the number of cars per lane.

BART

Level Of Service Computation Report  
 2000 HCM Operations (Future Volume Alternative)  
 PM - Exist + Proj Conditions

Intersection #3613: JULIAN/24TH [Study Int 2]

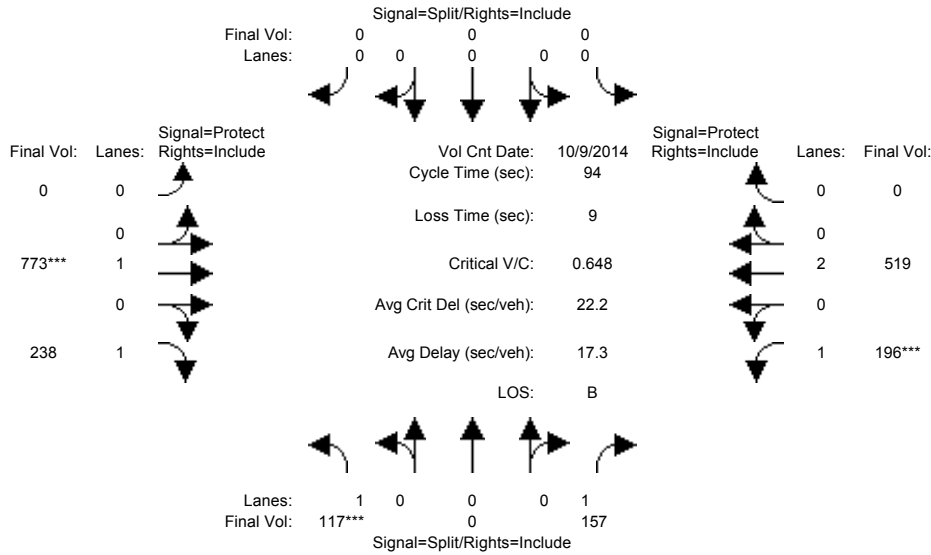

| Approach:                                   | North Bound |      |      | South Bound |      |      | East Bound |      |      | West Bound |      |      |
|---|-------------|------|------|-------------|------|------|------------|------|------|------------|------|------|
| Movement:                                   | L           | T    | R    | L           | T    | R    | L          | T    | R    | L          | T    | R    |
| Min. Green:                                 | 10          | 0    | 10   | 0           | 0    | 0    | 0          | 10   | 10   | 7          | 10   | 0    |
| Y+R:  | 4.0         | 4.0  | 4.0  | 4.0         | 4.0  | 4.0  | 4.0        | 4.0  | 4.0  | 4.0        | 4.0  | 0    |
| Volume Module: >> Count Date: 9 Oct 2014 << |             |      |      |             |      |      |            |      |      |            |      |      |
| Base Vol:                                   | 117         | 0    | 157  | 0           | 0    | 0    | 0          | 773  | 238  | 196        | 519  | 0    |
| Growth Adj:                                 | 1.00        | 1.00 | 1.00 | 1.00        | 1.00 | 1.00 | 1.00       | 1.00 | 1.00 | 1.00       | 1.00 | 1.00 |
| Initial Bse:                                | 117         | 0    | 157  | 0           | 0    | 0    | 0          | 773  | 238  | 196        | 519  | 0    |
| Added Vol:                                  | 0           | 0    | 0    | 0           | 0    | 0    | 0          | 0    | 0    | 0          | 0    | 0    |
| PasserByVol:                                | 0           | 0    | 0    | 0           | 0    | 0    | 0          | 0    | 0    | 0          | 0    | 0    |
| Initial Fut:                                | 117         | 0    | 157  | 0           | 0    | 0    | 0          | 773  | 238  | 196        | 519  | 0    |
| User Adj:                                   | 1.00        | 1.00 | 1.00 | 1.00        | 1.00 | 1.00 | 1.00       | 1.00 | 1.00 | 1.00       | 1.00 | 1.00 |
| PHF Adj:                                    | 1.00        | 1.00 | 1.00 | 1.00        | 1.00 | 1.00 | 1.00       | 1.00 | 1.00 | 1.00       | 1.00 | 1.00 |
| PHF Volume:                                 | 117         | 0    | 157  | 0           | 0    | 0    | 0          | 773  | 238  | 196        | 519  | 0    |
| Reduct Vol:                                 | 0           | 0    | 0    | 0           | 0    | 0    | 0          | 0    | 0    | 0          | 0    | 0    |
| Reduced Vol:                                | 117         | 0    | 157  | 0           | 0    | 0    | 0          | 773  | 238  | 196        | 519  | 0    |
| PCE Adj:                                    | 1.00        | 1.00 | 1.00 | 1.00        | 1.00 | 1.00 | 1.00       | 1.00 | 1.00 | 1.00       | 1.00 | 1.00 |
| MLF Adj:                                    | 1.00        | 1.00 | 1.00 | 1.00        | 1.00 | 1.00 | 1.00       | 1.00 | 1.00 | 1.00       | 1.00 | 1.00 |
| Final Volume:                               | 117         | 0    | 157  | 0           | 0    | 0    | 0          | 773  | 238  | 196        | 519  | 0    |
| Saturation Flow Module:                     |             |      |      |             |      |      |            |      |      |            |      |      |
| Sat/Lane:                                   | 1900        | 1900 | 1900 | 1900        | 1900 | 1900 | 1900       | 1900 | 1900 | 1900       | 1900 | 1900 |
| Adjustment:                                 | 0.92        | 1.00 | 0.92 | 0.92        | 1.00 | 0.92 | 0.92       | 1.00 | 0.92 | 0.92       | 1.00 | 0.92 |
| Lanes:                                      | 1.00        | 0.00 | 1.00 | 0.00        | 0.00 | 0.00 | 0.00       | 1.00 | 1.00 | 1.00       | 2.00 | 0.00 |
| Final Sat.:                                 | 1750        | 0    | 1750 | 0           | 0    | 0    | 0          | 1900 | 1750 | 1750       | 3800 | 0    |
| Capacity Analysis Module:                   |             |      |      |             |      |      |            |      |      |            |      |      |
| Vol/Sat:                                    | 0.07        | 0.00 | 0.09 | 0.00        | 0.00 | 0.00 | 0.00       | 0.41 | 0.14 | 0.11       | 0.14 | 0.00 |
| Crit Moves:                                 | ****        |      |      |             |      |      |            | **** |      | ****       |      |      |
| Green Time:                                 | 13.0        | 0.0  | 13.0 | 0.0         | 0.0  | 0.0  | 0.0        | 56.4 | 56.4 | 15.5       | 72.0 | 0.0  |
| Volume/Cap:                                 | 0.48        | 0.00 | 0.65 | 0.00        | 0.00 | 0.00 | 0.00       | 0.68 | 0.23 | 0.68       | 0.18 | 0.00 |
| Delay/Veh:                                  | 38.9        | 0.0  | 44.3 | 0.0         | 0.0  | 0.0  | 0.0        | 14.3 | 8.8  | 43.2       | 3.0  | 0.0  |
| User DelAdj:                                | 1.00        | 1.00 | 1.00 | 1.00        | 1.00 | 1.00 | 1.00       | 1.00 | 1.00 | 1.00       | 1.00 | 1.00 |
| AdjDel/Veh:                                 | 38.9        | 0.0  | 44.3 | 0.0         | 0.0  | 0.0  | 0.0        | 14.3 | 8.8  | 43.2       | 3.0  | 0.0  |
| LOS by Move:                                | D           | A    | D    | A           | A    | A    | A          | B    | A    | D          | A    | A    |
| HCM2k95thQ:                                 | 8           | 0    | 11   | 0           | 0    | 0    | 0          | 26   | 7    | 13         | 4    | 0    |

Note: Queue reported is the number of cars per lane.

BART

Level Of Service Computation Report  
 2000 HCM Operations (Future Volume Alternative)  
 AM - Exist + Proj Conditions

Intersection #3623: KING/MABURY [Study Int 27]

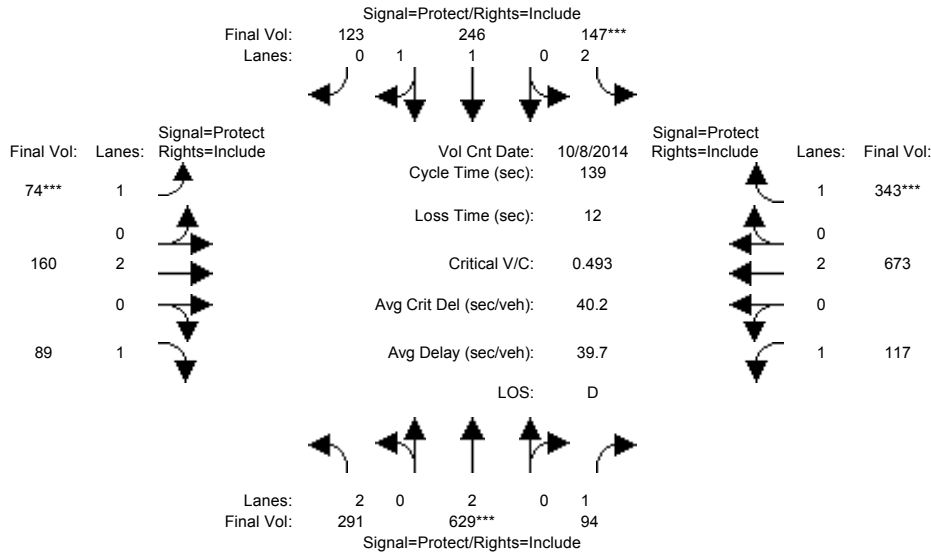

| Approach:                                   | North Bound |      |      | South Bound |      |      | East Bound |      |      | West Bound |      |      |
|---|-------------|------|------|-------------|------|------|------------|------|------|------------|------|------|
| Movement:                                   | L           | T    | R    | L           | T    | R    | L          | T    | R    | L          | T    | R    |
| Min. Green:                                 | 7           | 10   | 10   | 7           | 10   | 10   | 7          | 10   | 10   | 7          | 10   | 10   |
| Y+R:  | 4.0         | 4.0  | 4.0  | 4.0         | 4.0  | 4.0  | 4.0        | 4.0  | 4.0  | 4.0        | 4.0  | 4.0  |
| Volume Module: >> Count Date: 8 Oct 2014 << |             |      |      |             |      |      |            |      |      |            |      |      |
| Base Vol:                                   | 291         | 629  | 94   | 147         | 246  | 123  | 74         | 160  | 89   | 117        | 673  | 343  |
| Growth Adj:                                 | 1.00        | 1.00 | 1.00 | 1.00        | 1.00 | 1.00 | 1.00       | 1.00 | 1.00 | 1.00       | 1.00 | 1.00 |
| Initial Bse:                                | 291         | 629  | 94   | 147         | 246  | 123  | 74         | 160  | 89   | 117        | 673  | 343  |
| Added Vol:                                  | 0           | 0    | 0    | 0           | 0    | 0    | 0          | 0    | 0    | 0          | 0    | 0    |
| PasserByVol:                                | 0           | 0    | 0    | 0           | 0    | 0    | 0          | 0    | 0    | 0          | 0    | 0    |
| Initial Fut:                                | 291         | 629  | 94   | 147         | 246  | 123  | 74         | 160  | 89   | 117        | 673  | 343  |
| User Adj:                                   | 1.00        | 1.00 | 1.00 | 1.00        | 1.00 | 1.00 | 1.00       | 1.00 | 1.00 | 1.00       | 1.00 | 1.00 |
| PHF Adj:                                    | 1.00        | 1.00 | 1.00 | 1.00        | 1.00 | 1.00 | 1.00       | 1.00 | 1.00 | 1.00       | 1.00 | 1.00 |
| PHF Volume:                                 | 291         | 629  | 94   | 147         | 246  | 123  | 74         | 160  | 89   | 117        | 673  | 343  |
| Reduct Vol:                                 | 0           | 0    | 0    | 0           | 0    | 0    | 0          | 0    | 0    | 0          | 0    | 0    |
| Reduced Vol:                                | 291         | 629  | 94   | 147         | 246  | 123  | 74         | 160  | 89   | 117        | 673  | 343  |
| PCE Adj:                                    | 1.00        | 1.00 | 1.00 | 1.00        | 1.00 | 1.00 | 1.00       | 1.00 | 1.00 | 1.00       | 1.00 | 1.00 |
| MLF Adj:                                    | 1.00        | 1.00 | 1.00 | 1.00        | 1.00 | 1.00 | 1.00       | 1.00 | 1.00 | 1.00       | 1.00 | 1.00 |
| Final Volume:                               | 291         | 629  | 94   | 147         | 246  | 123  | 74         | 160  | 89   | 117        | 673  | 343  |
| Saturation Flow Module:                     |             |      |      |             |      |      |            |      |      |            |      |      |
| Sat/Lane:                                   | 1900        | 1900 | 1900 | 1900        | 1900 | 1900 | 1900       | 1900 | 1900 | 1900       | 1900 | 1900 |
| Adjustment:                                 | 0.83        | 1.00 | 0.92 | 0.83        | 0.99 | 0.95 | 0.92       | 1.00 | 0.92 | 0.92       | 1.00 | 0.92 |
| Lanes:                                      | 2.00        | 2.00 | 1.00 | 2.00        | 1.32 | 0.68 | 1.00       | 2.00 | 1.00 | 1.00       | 2.00 | 1.00 |
| Final Sat.:                                 | 3150        | 3800 | 1750 | 3150        | 2466 | 1233 | 1750       | 3800 | 1750 | 1750       | 3800 | 1750 |
| Capacity Analysis Module:                   |             |      |      |             |      |      |            |      |      |            |      |      |
| Vol/Sat:                                    | 0.09        | 0.17 | 0.05 | 0.05        | 0.10 | 0.10 | 0.04       | 0.04 | 0.05 | 0.07       | 0.18 | 0.20 |
| Crit Moves:                                 | ****        | **** | **** | ****        | **** | **** | ****       | **** | **** | ****       | **** | **** |
| Green Time:                                 | 28.8        | 46.7 | 46.7 | 13.2        | 31.1 | 31.1 | 11.9       | 34.8 | 34.8 | 32.4       | 55.3 | 55.3 |
| Volume/Cap:                                 | 0.45        | 0.49 | 0.16 | 0.49        | 0.45 | 0.45 | 0.49       | 0.17 | 0.20 | 0.29       | 0.45 | 0.49 |
| Delay/Veh:                                  | 48.7        | 37.1 | 32.5 | 61.0        | 46.9 | 46.9 | 63.2       | 40.8 | 41.4 | 44.2       | 30.9 | 31.9 |
| User DelAdj:                                | 1.00        | 1.00 | 1.00 | 1.00        | 1.00 | 1.00 | 1.00       | 1.00 | 1.00 | 1.00       | 1.00 | 1.00 |
| AdjDel/Veh:                                 | 48.7        | 37.1 | 32.5 | 61.0        | 46.9 | 46.9 | 63.2       | 40.8 | 41.4 | 44.2       | 30.9 | 31.9 |
| LOS by Move:                                | D           | D    | C    | E           | D    | D    | E          | D    | D    | D          | C    | C    |
| HCM2k95thQ:                                 | 12          | 19   | 6    | 7           | 13   | 13   | 6          | 5    | 6    | 8          | 19   | 21   |

Note: Queue reported is the number of cars per lane.

BART

Level Of Service Computation Report  
 2000 HCM Operations (Future Volume Alternative)  
 PM - Exist + Proj Conditions

Intersection #3623: KING/MABURY [Study Int 27]

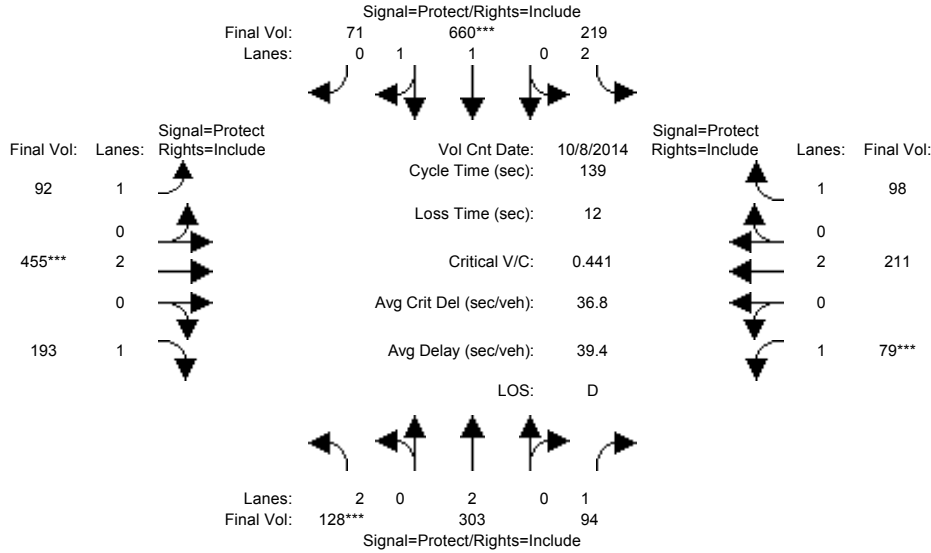

| Approach:   | North Bound |      |      | South Bound |      |      | East Bound |      |      | West Bound |      |      |
|---|-------------|------|------|-------------|------|------|------------|------|------|------------|------|------|
| Movement:   | L           | T    | R    | L           | T    | R    | L          | T    | R    | L          | T    | R    |
| Min. Green:   | 7           | 10   | 10   | 7           | 10   | 10   | 7          | 10   | 10   | 7          | 10   | 10   |
| Y+R:  | 4.0         | 4.0  | 4.0  | 4.0         | 4.0  | 4.0  | 4.0        | 4.0  | 4.0  | 4.0        | 4.0  | 4.0  |
| ----- ----- ----- ----- ----- ----- ----- ----- ----- ----- ----- ----- ----- |             |      |      |             |      |      |            |      |      |            |      |      |
| Volume Module: >> Count Date: 8 Oct 2014 <<                                   |             |      |      |             |      |      |            |      |      |            |      |      |
| Base Vol:   | 128         | 303  | 94   | 219         | 660  | 71   | 92         | 455  | 193  | 79         | 211  | 98   |
| Growth Adj:   | 1.00        | 1.00 | 1.00 | 1.00        | 1.00 | 1.00 | 1.00       | 1.00 | 1.00 | 1.00       | 1.00 | 1.00 |
| Initial Bse:  | 128         | 303  | 94   | 219         | 660  | 71   | 92         | 455  | 193  | 79         | 211  | 98   |
| Added Vol:  | 0           | 0    | 0    | 0           | 0    | 0    | 0          | 0    | 0    | 0          | 0    | 0    |
| PasserByVol:  | 0           | 0    | 0    | 0           | 0    | 0    | 0          | 0    | 0    | 0          | 0    | 0    |
| Initial Fut:  | 128         | 303  | 94   | 219         | 660  | 71   | 92         | 455  | 193  | 79         | 211  | 98   |
| User Adj:   | 1.00        | 1.00 | 1.00 | 1.00        | 1.00 | 1.00 | 1.00       | 1.00 | 1.00 | 1.00       | 1.00 | 1.00 |
| PHF Adj:  | 1.00        | 1.00 | 1.00 | 1.00        | 1.00 | 1.00 | 1.00       | 1.00 | 1.00 | 1.00       | 1.00 | 1.00 |
| PHF Volume:   | 128         | 303  | 94   | 219         | 660  | 71   | 92         | 455  | 193  | 79         | 211  | 98   |
| Reduct Vol:   | 0           | 0    | 0    | 0           | 0    | 0    | 0          | 0    | 0    | 0          | 0    | 0    |
| Reduced Vol:  | 128         | 303  | 94   | 219         | 660  | 71   | 92         | 455  | 193  | 79         | 211  | 98   |
| PCE Adj:  | 1.00        | 1.00 | 1.00 | 1.00        | 1.00 | 1.00 | 1.00       | 1.00 | 1.00 | 1.00       | 1.00 | 1.00 |
| MLF Adj:  | 1.00        | 1.00 | 1.00 | 1.00        | 1.00 | 1.00 | 1.00       | 1.00 | 1.00 | 1.00       | 1.00 | 1.00 |
| FinalVolume:  | 128         | 303  | 94   | 219         | 660  | 71   | 92         | 455  | 193  | 79         | 211  | 98   |
| ----- ----- ----- ----- ----- ----- ----- ----- ----- ----- ----- -----       |             |      |      |             |      |      |            |      |      |            |      |      |
| Saturation Flow Module:   |             |      |      |             |      |      |            |      |      |            |      |      |
| Sat/Lane:   | 1900        | 1900 | 1900 | 1900        | 1900 | 1900 | 1900       | 1900 | 1900 | 1900       | 1900 | 1900 |
| Adjustment:   | 0.83        | 1.00 | 0.92 | 0.83        | 0.98 | 0.95 | 0.92       | 1.00 | 0.92 | 0.92       | 1.00 | 0.92 |
| Lanes:  | 2.00        | 2.00 | 1.00 | 2.00        | 1.80 | 0.20 | 1.00       | 2.00 | 1.00 | 1.00       | 2.00 | 1.00 |
| Final Sat.:   | 3150        | 3800 | 1750 | 3150        | 3340 | 359  | 1750       | 3800 | 1750 | 1750       | 3800 | 1750 |
| ----- ----- ----- ----- ----- ----- ----- ----- ----- ----- ----- -----       |             |      |      |             |      |      |            |      |      |            |      |      |
| Capacity Analysis Module:   |             |      |      |             |      |      |            |      |      |            |      |      |
| Vol/Sat:  | 0.04        | 0.08 | 0.05 | 0.07        | 0.20 | 0.20 | 0.05       | 0.12 | 0.11 | 0.05       | 0.06 | 0.06 |
| Crit Moves:   | ****        |      |      | ****        |      |      | ****       |      |      | ****       |      |      |
| Green Time:   | 12.8        | 40.1 | 40.1 | 35.0        | 62.3 | 62.3 | 21.9       | 37.7 | 37.7 | 14.2       | 30.0 | 30.0 |
| Volume/Cap:   | 0.44        | 0.28 | 0.19 | 0.28        | 0.44 | 0.44 | 0.33       | 0.44 | 0.41 | 0.44       | 0.26 | 0.26 |
| Delay/Veh:  | 60.8        | 38.4 | 37.4 | 42.0        | 26.6 | 26.6 | 52.7       | 42.2 | 42.0 | 60.4       | 45.4 | 45.6 |
| User DelAdj:  | 1.00        | 1.00 | 1.00 | 1.00        | 1.00 | 1.00 | 1.00       | 1.00 | 1.00 | 1.00       | 1.00 | 1.00 |
| AdjDel/Veh:   | 60.8        | 38.4 | 37.4 | 42.0        | 26.6 | 26.6 | 52.7       | 42.2 | 42.0 | 60.4       | 45.4 | 45.6 |
| LOS by Move:  | E           | D    | D    | D           | C    | C    | D          | D    | D    | E          | D    | D    |
| HCM2k95thQ:   | 6           | 9    | 6    | 9           | 19   | 19   | 7          | 15   | 13   | 7          | 7    | 7    |

Note: Queue reported is the number of cars per lane.

BART

Level Of Service Computation Report  
 2000 HCM Operations (Future Volume Alternative)  
 AM - Exist + Proj Conditions

Intersection #3625: KING/McKEE [Study Int 7]

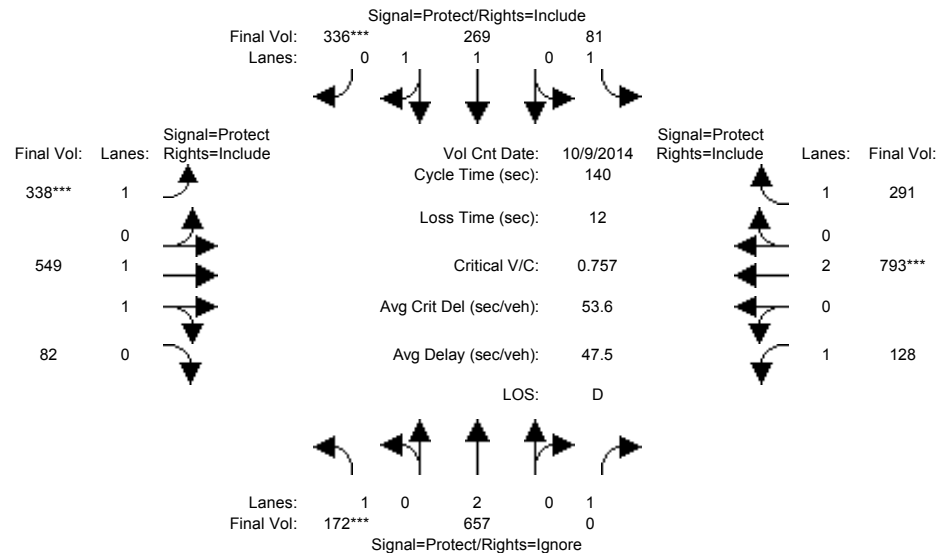

| Approach:                                   | North Bound |      |      | South Bound |      |      | East Bound |      |      | West Bound |      |      |
|---|-------------|------|------|-------------|------|------|------------|------|------|------------|------|------|
| Movement:                                   | L           | T    | R    | L           | T    | R    | L          | T    | R    | L          | T    | R    |
| Min. Green:                                 | 7           | 10   | 10   | 7           | 10   | 10   | 7          | 10   | 10   | 7          | 10   | 10   |
| Y+R:  | 4.0         | 4.0  | 4.0  | 4.0         | 4.0  | 4.0  | 4.0        | 4.0  | 4.0  | 4.0        | 4.0  | 4.0  |
| Volume Module: >> Count Date: 9 Oct 2014 << |             |      |      |             |      |      |            |      |      |            |      |      |
| Base Vol:                                   | 172         | 657  | 161  | 81          | 269  | 336  | 338        | 549  | 82   | 128        | 793  | 291  |
| Growth Adj:                                 | 1.00        | 1.00 | 1.00 | 1.00        | 1.00 | 1.00 | 1.00       | 1.00 | 1.00 | 1.00       | 1.00 | 1.00 |
| Initial Bse:                                | 172         | 657  | 161  | 81          | 269  | 336  | 338        | 549  | 82   | 128        | 793  | 291  |
| Added Vol:                                  | 0           | 0    | 0    | 0           | 0    | 0    | 0          | 0    | 0    | 0          | 0    | 0    |
| PasserByVol:                                | 0           | 0    | 0    | 0           | 0    | 0    | 0          | 0    | 0    | 0          | 0    | 0    |
| Initial Fut:                                | 172         | 657  | 161  | 81          | 269  | 336  | 338        | 549  | 82   | 128        | 793  | 291  |
| User Adj:                                   | 1.00        | 1.00 | 0.00 | 1.00        | 1.00 | 1.00 | 1.00       | 1.00 | 1.00 | 1.00       | 1.00 | 1.00 |
| PHF Adj:                                    | 1.00        | 1.00 | 0.00 | 1.00        | 1.00 | 1.00 | 1.00       | 1.00 | 1.00 | 1.00       | 1.00 | 1.00 |
| PHF Volume:                                 | 172         | 657  | 0    | 81          | 269  | 336  | 338        | 549  | 82   | 128        | 793  | 291  |
| Reduct Vol:                                 | 0           | 0    | 0    | 0           | 0    | 0    | 0          | 0    | 0    | 0          | 0    | 0    |
| Reduced Vol:                                | 172         | 657  | 0    | 81          | 269  | 336  | 338        | 549  | 82   | 128        | 793  | 291  |
| PCE Adj:                                    | 1.00        | 1.00 | 0.00 | 1.00        | 1.00 | 1.00 | 1.00       | 1.00 | 1.00 | 1.00       | 1.00 | 1.00 |
| MLF Adj:                                    | 1.00        | 1.00 | 0.00 | 1.00        | 1.00 | 1.00 | 1.00       | 1.00 | 1.00 | 1.00       | 1.00 | 1.00 |
| Final Volume:                               | 172         | 657  | 0    | 81          | 269  | 336  | 338        | 549  | 82   | 128        | 793  | 291  |
| Saturation Flow Module:                     |             |      |      |             |      |      |            |      |      |            |      |      |
| Sat/Lane:                                   | 1900        | 1900 | 1900 | 1900        | 1900 | 1900 | 1900       | 1900 | 1900 | 1900       | 1900 | 1900 |
| Adjustment:                                 | 0.92        | 1.00 | 0.92 | 0.92        | 1.00 | 0.92 | 0.92       | 0.98 | 0.95 | 0.92       | 1.00 | 0.92 |
| Lanes:                                      | 1.00        | 2.00 | 1.00 | 1.00        | 1.00 | 1.00 | 1.00       | 1.73 | 0.27 | 1.00       | 2.00 | 1.00 |
| Final Sat.:                                 | 1750        | 3800 | 1750 | 1750        | 1900 | 1750 | 1750       | 3219 | 481  | 1750       | 3800 | 1750 |
| Capacity Analysis Module:                   |             |      |      |             |      |      |            |      |      |            |      |      |
| Vol/Sat:                                    | 0.10        | 0.17 | 0.00 | 0.05        | 0.14 | 0.19 | 0.19       | 0.17 | 0.17 | 0.07       | 0.21 | 0.17 |
| Crit Moves:                                 | ****        |      |      | ****        | **** | **** | ****       | **** | **** | ****       |      |      |
| Green Time:                                 | 18.2        | 41.6 | 0.0  | 12.0        | 35.5 | 35.5 | 35.7       | 52.0 | 52.0 | 22.3       | 38.6 | 38.6 |
| Volume/Cap:                                 | 0.76        | 0.58 | 0.00 | 0.54        | 0.56 | 0.76 | 0.76       | 0.46 | 0.46 | 0.46       | 0.76 | 0.60 |
| Delay/Veh:                                  | 72.4        | 42.5 | 0.0  | 65.2        | 46.1 | 52.4 | 55.4       | 33.6 | 33.6 | 54.6       | 49.6 | 46.2 |
| User DelAdj:                                | 1.00        | 1.00 | 1.00 | 1.00        | 1.00 | 1.00 | 1.00       | 1.00 | 1.00 | 1.00       | 1.00 | 1.00 |
| AdjDel/Veh:                                 | 72.4        | 42.5 | 0.0  | 65.2        | 46.1 | 52.4 | 55.4       | 33.6 | 33.6 | 54.6       | 49.6 | 46.2 |
| LOS by Move:                                | E           | D    | A    | E           | D    | D    | E          | C    | C    | D          | D    | D    |
| HCM2k95thQ:                                 | 15          | 21   | 0    | 7           | 18   | 26   | 26         | 19   | 19   | 10         | 28   | 21   |

Note: Queue reported is the number of cars per lane.



BART

Level Of Service Computation Report  
2000 HCM Operations (Future Volume Alternative)  
PM - Exist + Proj Conditions

Intersection #3625: KING/McKEE [Study Int 7]

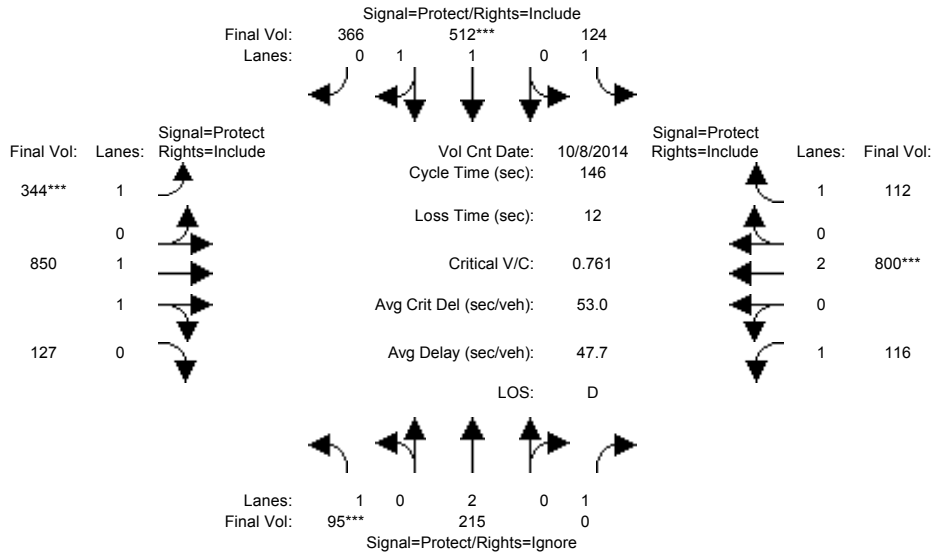

| Approach:                                   | North Bound |      |      | South Bound |      |      | East Bound |      |      | West Bound |      |      |
|---|-------------|------|------|-------------|------|------|------------|------|------|------------|------|------|
| Movement:                                   | L           | T    | R    | L           | T    | R    | L          | T    | R    | L          | T    | R    |
| Min. Green:                                 | 7           | 10   | 10   | 7           | 10   | 10   | 7          | 10   | 10   | 7          | 10   | 10   |
| Y+R:  | 4.0         | 4.0  | 4.0  | 4.0         | 4.0  | 4.0  | 4.0        | 4.0  | 4.0  | 4.0        | 4.0  | 4.0  |
| Volume Module: >> Count Date: 8 Oct 2014 << |             |      |      |             |      |      |            |      |      |            |      |      |
| Base Vol:                                   | 95          | 215  | 104  | 124         | 512  | 366  | 344        | 850  | 127  | 116        | 800  | 112  |
| Growth Adj:                                 | 1.00        | 1.00 | 1.00 | 1.00        | 1.00 | 1.00 | 1.00       | 1.00 | 1.00 | 1.00       | 1.00 | 1.00 |
| Initial Bse:                                | 95          | 215  | 104  | 124         | 512  | 366  | 344        | 850  | 127  | 116        | 800  | 112  |
| Added Vol:                                  | 0           | 0    | 0    | 0           | 0    | 0    | 0          | 0    | 0    | 0          | 0    | 0    |
| PasserByVol:                                | 0           | 0    | 0    | 0           | 0    | 0    | 0          | 0    | 0    | 0          | 0    | 0    |
| Initial Fut:                                | 95          | 215  | 104  | 124         | 512  | 366  | 344        | 850  | 127  | 116        | 800  | 112  |
| User Adj:                                   | 1.00        | 1.00 | 0.00 | 1.00        | 1.00 | 1.00 | 1.00       | 1.00 | 1.00 | 1.00       | 1.00 | 1.00 |
| PHF Adj:                                    | 1.00        | 1.00 | 0.00 | 1.00        | 1.00 | 1.00 | 1.00       | 1.00 | 1.00 | 1.00       | 1.00 | 1.00 |
| PHF Volume:                                 | 95          | 215  | 0    | 124         | 512  | 366  | 344        | 850  | 127  | 116        | 800  | 112  |
| Reduct Vol:                                 | 0           | 0    | 0    | 0           | 0    | 0    | 0          | 0    | 0    | 0          | 0    | 0    |
| Reduced Vol:                                | 95          | 215  | 0    | 124         | 512  | 366  | 344        | 850  | 127  | 116        | 800  | 112  |
| PCE Adj:                                    | 1.00        | 1.00 | 0.00 | 1.00        | 1.00 | 1.00 | 1.00       | 1.00 | 1.00 | 1.00       | 1.00 | 1.00 |
| MLF Adj:                                    | 1.00        | 1.00 | 0.00 | 1.00        | 1.00 | 1.00 | 1.00       | 1.00 | 1.00 | 1.00       | 1.00 | 1.00 |
| Final Volume:                               | 95          | 215  | 0    | 124         | 512  | 366  | 344        | 850  | 127  | 116        | 800  | 112  |
| Saturation Flow Module:                     |             |      |      |             |      |      |            |      |      |            |      |      |
| Sat/Lane:                                   | 1900        | 1900 | 1900 | 1900        | 1900 | 1900 | 1900       | 1900 | 1900 | 1900       | 1900 | 1900 |
| Adjustment:                                 | 0.92        | 1.00 | 0.92 | 0.92        | 0.99 | 0.95 | 0.92       | 0.98 | 0.95 | 0.92       | 1.00 | 0.92 |
| Lanes:                                      | 1.00        | 2.00 | 1.00 | 1.00        | 1.14 | 0.86 | 1.00       | 1.73 | 0.27 | 1.00       | 2.00 | 1.00 |
| Final Sat.:                                 | 1750        | 3800 | 1750 | 1750        | 2156 | 1542 | 1750       | 3219 | 481  | 1750       | 3800 | 1750 |
| Capacity Analysis Module:                   |             |      |      |             |      |      |            |      |      |            |      |      |
| Vol/Sat:                                    | 0.05        | 0.06 | 0.00 | 0.07        | 0.24 | 0.24 | 0.20       | 0.26 | 0.26 | 0.07       | 0.21 | 0.06 |
| Crit Moves:                                 | ****        |      |      | ****        |      |      | ****       |      |      | ****       |      |      |
| Green Time:                                 | 10.4        | 27.5 | 0.0  | 28.4        | 45.5 | 45.5 | 37.7       | 62.4 | 62.4 | 15.7       | 40.4 | 40.4 |
| Volume/Cap:                                 | 0.76        | 0.30 | 0.00 | 0.36        | 0.76 | 0.76 | 0.76       | 0.62 | 0.62 | 0.62       | 0.76 | 0.23 |
| Delay/Veh:                                  | 90.2        | 51.2 | 0.0  | 51.6        | 48.4 | 48.4 | 57.4       | 33.3 | 33.3 | 68.4       | 51.7 | 41.1 |
| User DelAdj:                                | 1.00        | 1.00 | 1.00 | 1.00        | 1.00 | 1.00 | 1.00       | 1.00 | 1.00 | 1.00       | 1.00 | 1.00 |
| AdjDel/Veh:                                 | 90.2        | 51.2 | 0.0  | 51.6        | 48.4 | 48.4 | 57.4       | 33.3 | 33.3 | 68.4       | 51.7 | 41.1 |
| LOS by Move:                                | F           | D    | A    | D           | D    | D    | E          | C    | C    | E          | D    | D    |
| HCM2k95thQ:                                 | 10          | 8    | 0    | 10          | 32   | 32   | 27         | 29   | 29   | 11         | 29   | 8    |

Note: Queue reported is the number of cars per lane.

BART

Level Of Service Computation Report  
 2000 HCM Operations (Future Volume Alternative)  
 AM - Exist + Proj Conditions

Intersection #3627: KING/SAN ANTONIO [Study Int 22]

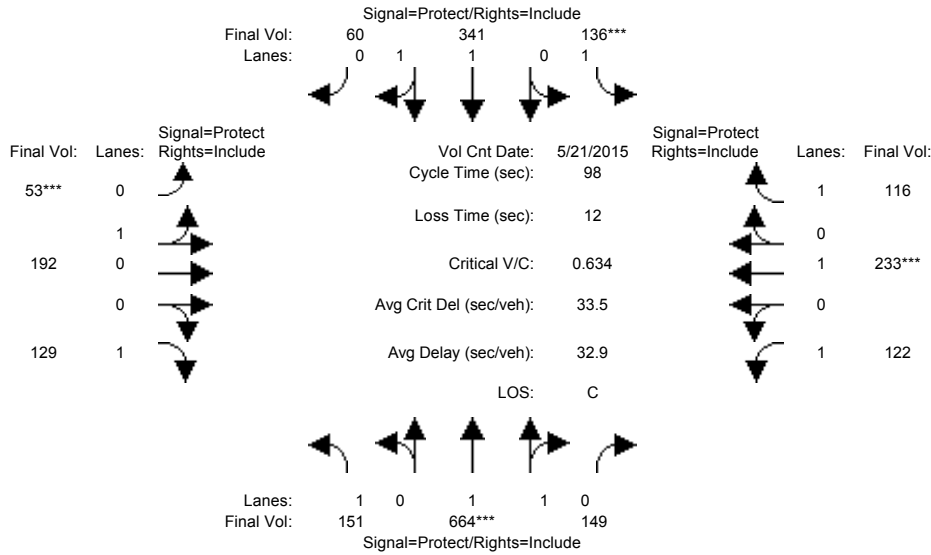

| Approach:  | North Bound |      |      | South Bound |      |      | East Bound |      |      | West Bound |      |      |
|--|-------------|------|------|-------------|------|------|------------|------|------|------------|------|------|
| Movement:  | L           | T    | R    | L           | T    | R    | L          | T    | R    | L          | T    | R    |
| Min. Green:  | 7           | 10   | 10   | 7           | 10   | 10   | 10         | 10   | 10   | 10         | 10   | 10   |
| Y+R:   | 4.0         | 4.0  | 4.0  | 4.0         | 4.0  | 4.0  | 4.0        | 4.0  | 4.0  | 4.0        | 4.0  | 4.0  |
| Volume Module: >> Count Date: 21 May 2015 << 7:30-8:30AM |             |      |      |             |      |      |            |      |      |            |      |      |
| Base Vol:  | 151         | 664  | 149  | 136         | 341  | 60   | 53         | 192  | 129  | 122        | 233  | 116  |
| Growth Adj:  | 1.00        | 1.00 | 1.00 | 1.00        | 1.00 | 1.00 | 1.00       | 1.00 | 1.00 | 1.00       | 1.00 | 1.00 |
| Initial Bse:   | 151         | 664  | 149  | 136         | 341  | 60   | 53         | 192  | 129  | 122        | 233  | 116  |
| Added Vol:   | 0           | 0    | 0    | 0           | 0    | 0    | 0          | 0    | 0    | 0          | 0    | 0    |
| PasserByVol:   | 0           | 0    | 0    | 0           | 0    | 0    | 0          | 0    | 0    | 0          | 0    | 0    |
| Initial Fut:   | 151         | 664  | 149  | 136         | 341  | 60   | 53         | 192  | 129  | 122        | 233  | 116  |
| User Adj:  | 1.00        | 1.00 | 1.00 | 1.00        | 1.00 | 1.00 | 1.00       | 1.00 | 1.00 | 1.00       | 1.00 | 1.00 |
| PHF Adj:   | 1.00        | 1.00 | 1.00 | 1.00        | 1.00 | 1.00 | 1.00       | 1.00 | 1.00 | 1.00       | 1.00 | 1.00 |
| PHF Volume:  | 151         | 664  | 149  | 136         | 341  | 60   | 53         | 192  | 129  | 122        | 233  | 116  |
| Reduct Vol:  | 0           | 0    | 0    | 0           | 0    | 0    | 0          | 0    | 0    | 0          | 0    | 0    |
| Reduced Vol:   | 151         | 664  | 149  | 136         | 341  | 60   | 53         | 192  | 129  | 122        | 233  | 116  |
| PCE Adj:   | 1.00        | 1.00 | 1.00 | 1.00        | 1.00 | 1.00 | 1.00       | 1.00 | 1.00 | 1.00       | 1.00 | 1.00 |
| MLF Adj:   | 1.00        | 1.00 | 1.00 | 1.00        | 1.00 | 1.00 | 1.00       | 1.00 | 1.00 | 1.00       | 1.00 | 1.00 |
| Final Volume:  | 151         | 664  | 149  | 136         | 341  | 60   | 53         | 192  | 129  | 122        | 233  | 116  |
| Saturation Flow Module:                                  |             |      |      |             |      |      |            |      |      |            |      |      |
| Sat/Lane:  | 1900        | 1900 | 1900 | 1900        | 1900 | 1900 | 1900       | 1900 | 1900 | 1900       | 1900 | 1900 |
| Adjustment:  | 0.92        | 0.98 | 0.95 | 0.92        | 0.98 | 0.95 | 0.95       | 0.95 | 0.92 | 0.92       | 1.00 | 0.92 |
| Lanes:   | 1.00        | 1.62 | 0.38 | 1.00        | 1.69 | 0.31 | 0.22       | 0.78 | 1.00 | 1.00       | 1.00 | 1.00 |
| Final Sat.:  | 1750        | 3021 | 678  | 1750        | 3146 | 554  | 389        | 1411 | 1750 | 1750       | 1900 | 1750 |
| Capacity Analysis Module:                                |             |      |      |             |      |      |            |      |      |            |      |      |
| Vol/Sat:   | 0.09        | 0.22 | 0.22 | 0.08        | 0.11 | 0.11 | 0.14       | 0.14 | 0.07 | 0.07       | 0.12 | 0.07 |
| Crit Moves:  | ****        | **** | **** | ****        | **** | **** | ****       | **** | **** | ****       | **** | **** |
| Green Time:  | 20.4        | 34.0 | 34.0 | 12.0        | 25.6 | 25.6 | 21.0       | 22.9 | 22.9 | 17.1       | 19.0 | 19.0 |
| Volume/Cap:  | 0.41        | 0.63 | 0.63 | 0.63        | 0.41 | 0.41 | 0.63       | 0.58 | 0.32 | 0.40       | 0.63 | 0.34 |
| Delay/Veh:   | 34.4        | 27.8 | 27.8 | 47.0        | 30.3 | 30.3 | 38.4       | 35.4 | 31.5 | 36.7       | 39.9 | 34.7 |
| User DelAdj:   | 1.00        | 1.00 | 1.00 | 1.00        | 1.00 | 1.00 | 1.00       | 1.00 | 1.00 | 1.00       | 1.00 | 1.00 |
| AdjDel/Veh:  | 34.4        | 27.8 | 27.8 | 47.0        | 30.3 | 30.3 | 38.4       | 35.4 | 31.5 | 36.7       | 39.9 | 34.7 |
| LOS by Move:   | C           | C    | C    | D           | C    | C    | D          | D    | C    | D          | D    | C    |
| HCM2k95thQ:  | 8           | 19   | 19   | 9           | 10   | 10   | 15         | 14   | 7    | 8          | 14   | 7    |

Note: Queue reported is the number of cars per lane.

BART

Level Of Service Computation Report  
2000 HCM Operations (Future Volume Alternative)  
PM - Exist + Proj Conditions

Intersection #3627: KING/SAN ANTONIO [Study Int 22]

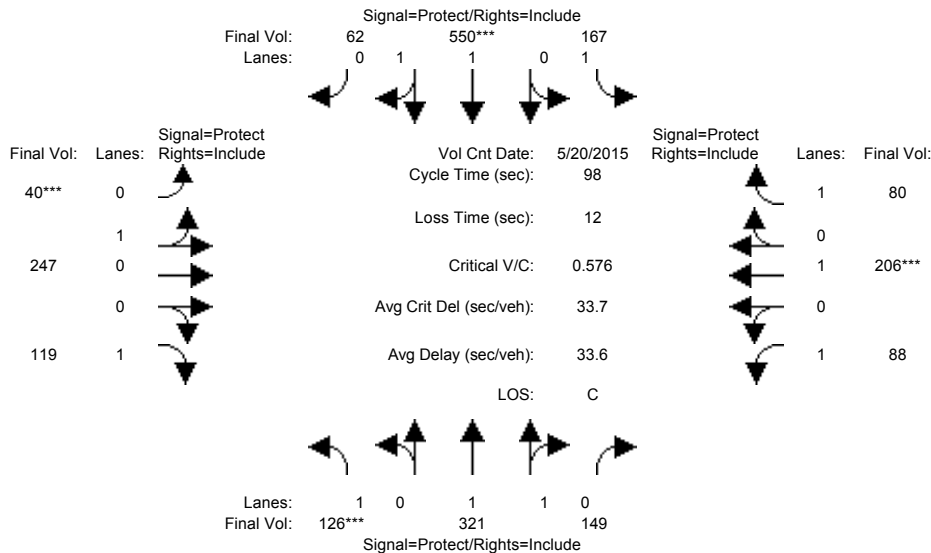

| Approach:  | North Bound |      |      | South Bound |      |      | East Bound |      |      | West Bound |      |      |
|--|-------------|------|------|-------------|------|------|------------|------|------|------------|------|------|
| Movement:  | L           | T    | R    | L           | T    | R    | L          | T    | R    | L          | T    | R    |
| Min. Green:  | 7           | 10   | 10   | 7           | 10   | 10   | 10         | 10   | 10   | 10         | 10   | 10   |
| Y+R:   | 4.0         | 4.0  | 4.0  | 4.0         | 4.0  | 4.0  | 4.0        | 4.0  | 4.0  | 4.0        | 4.0  | 4.0  |
| Volume Module: >> Count Date: 20 May 2015 << 4:45-5:45PM |             |      |      |             |      |      |            |      |      |            |      |      |
| Base Vol:  | 126         | 321  | 149  | 167         | 550  | 62   | 40         | 247  | 119  | 88         | 206  | 80   |
| Growth Adj:  | 1.00        | 1.00 | 1.00 | 1.00        | 1.00 | 1.00 | 1.00       | 1.00 | 1.00 | 1.00       | 1.00 | 1.00 |
| Initial Bse:   | 126         | 321  | 149  | 167         | 550  | 62   | 40         | 247  | 119  | 88         | 206  | 80   |
| Added Vol:   | 0           | 0    | 0    | 0           | 0    | 0    | 0          | 0    | 0    | 0          | 0    | 0    |
| PasserByVol:   | 0           | 0    | 0    | 0           | 0    | 0    | 0          | 0    | 0    | 0          | 0    | 0    |
| Initial Fut:   | 126         | 321  | 149  | 167         | 550  | 62   | 40         | 247  | 119  | 88         | 206  | 80   |
| User Adj:  | 1.00        | 1.00 | 1.00 | 1.00        | 1.00 | 1.00 | 1.00       | 1.00 | 1.00 | 1.00       | 1.00 | 1.00 |
| PHF Adj:   | 1.00        | 1.00 | 1.00 | 1.00        | 1.00 | 1.00 | 1.00       | 1.00 | 1.00 | 1.00       | 1.00 | 1.00 |
| PHF Volume:  | 126         | 321  | 149  | 167         | 550  | 62   | 40         | 247  | 119  | 88         | 206  | 80   |
| Reduct Vol:  | 0           | 0    | 0    | 0           | 0    | 0    | 0          | 0    | 0    | 0          | 0    | 0    |
| Reduced Vol:   | 126         | 321  | 149  | 167         | 550  | 62   | 40         | 247  | 119  | 88         | 206  | 80   |
| PCE Adj:   | 1.00        | 1.00 | 1.00 | 1.00        | 1.00 | 1.00 | 1.00       | 1.00 | 1.00 | 1.00       | 1.00 | 1.00 |
| MLF Adj:   | 1.00        | 1.00 | 1.00 | 1.00        | 1.00 | 1.00 | 1.00       | 1.00 | 1.00 | 1.00       | 1.00 | 1.00 |
| FinalVolume:   | 126         | 321  | 149  | 167         | 550  | 62   | 40         | 247  | 119  | 88         | 206  | 80   |
| Saturation Flow Module:                                  |             |      |      |             |      |      |            |      |      |            |      |      |
| Sat/Lane:  | 1900        | 1900 | 1900 | 1900        | 1900 | 1900 | 1900       | 1900 | 1900 | 1900       | 1900 | 1900 |
| Adjustment:  | 0.92        | 0.99 | 0.95 | 0.92        | 0.98 | 0.95 | 0.95       | 0.95 | 0.92 | 0.92       | 1.00 | 0.92 |
| Lanes:   | 1.00        | 1.35 | 0.65 | 1.00        | 1.79 | 0.21 | 0.14       | 0.86 | 1.00 | 1.00       | 1.00 | 1.00 |
| Final Sat.:  | 1750        | 2526 | 1173 | 1750        | 3325 | 375  | 251        | 1549 | 1750 | 1750       | 1900 | 1750 |
| Capacity Analysis Module:                                |             |      |      |             |      |      |            |      |      |            |      |      |
| Vol/Sat:   | 0.07        | 0.13 | 0.13 | 0.10        | 0.17 | 0.17 | 0.16       | 0.16 | 0.07 | 0.05       | 0.11 | 0.05 |
| Crit Moves:  | ****        |      |      | ****        |      |      | ****       |      |      | ****       |      |      |
| Green Time:  | 12.3        | 23.1 | 23.1 | 17.3        | 28.2 | 28.2 | 27.1       | 27.8 | 27.8 | 17.8       | 18.5 | 18.5 |
| Volume/Cap:  | 0.58        | 0.54 | 0.54 | 0.54        | 0.58 | 0.58 | 0.58       | 0.56 | 0.24 | 0.28       | 0.58 | 0.24 |
| Delay/Veh:   | 44.2        | 33.5 | 33.5 | 38.6        | 30.6 | 30.6 | 32.1       | 31.3 | 27.2 | 35.0       | 38.5 | 34.2 |
| User DelAdj:   | 1.00        | 1.00 | 1.00 | 1.00        | 1.00 | 1.00 | 1.00       | 1.00 | 1.00 | 1.00       | 1.00 | 1.00 |
| AdjDel/Veh:  | 44.2        | 33.5 | 33.5 | 38.6        | 30.6 | 30.6 | 32.1       | 31.3 | 27.2 | 35.0       | 38.5 | 34.2 |
| LOS by Move:   | D           | C    | C    | D           | C    | C    | C          | C    | C    | D          | D    | C    |
| HCM2k95thQ:  | 8           | 12   | 12   | 10          | 15   | 15   | 16         | 16   | 6    | 5          | 12   | 5    |

Note: Queue reported is the number of cars per lane.

BART

Level Of Service Computation Report  
2000 HCM Operations (Future Volume Alternative)  
AM - Exist + Proj Conditions

Intersection #3678: MCKEE/33RD [Study Int 6]

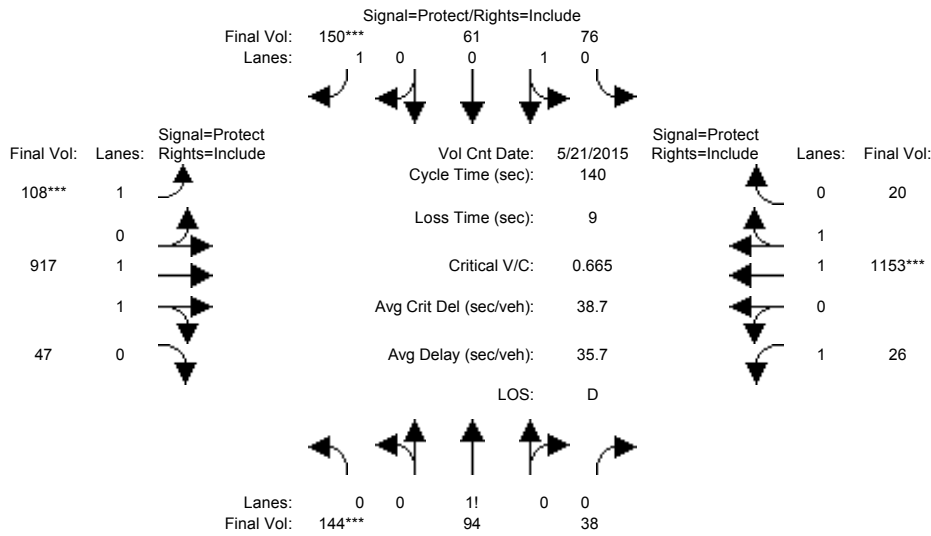

| Approach:  | North Bound |      |      | South Bound |      |      | East Bound |      |      | West Bound |      |      |
|--|-------------|------|------|-------------|------|------|------------|------|------|------------|------|------|
| Movement:  | L           | T    | R    | L           | T    | R    | L          | T    | R    | L          | T    | R    |
| Min. Green:  | 10          | 10   | 10   | 10          | 10   | 10   | 7          | 10   | 10   | 7          | 10   | 10   |
| Y+R:   | 4.0         | 4.0  | 4.0  | 4.0         | 4.0  | 4.0  | 4.0        | 4.0  | 4.0  | 4.0        | 4.0  | 4.0  |
| Volume Module: >> Count Date: 21 May 2015 << 7:30-8:30AM |             |      |      |             |      |      |            |      |      |            |      |      |
| Base Vol:  | 144         | 94   | 38   | 76          | 61   | 150  | 108        | 917  | 47   | 26         | 1153 | 20   |
| Growth Adj:  | 1.00        | 1.00 | 1.00 | 1.00        | 1.00 | 1.00 | 1.00       | 1.00 | 1.00 | 1.00       | 1.00 | 1.00 |
| Initial Bse:   | 144         | 94   | 38   | 76          | 61   | 150  | 108        | 917  | 47   | 26         | 1153 | 20   |
| Added Vol:   | 0           | 0    | 0    | 0           | 0    | 0    | 0          | 0    | 0    | 0          | 0    | 0    |
| PasserByVol:   | 0           | 0    | 0    | 0           | 0    | 0    | 0          | 0    | 0    | 0          | 0    | 0    |
| Initial Fut:   | 144         | 94   | 38   | 76          | 61   | 150  | 108        | 917  | 47   | 26         | 1153 | 20   |
| User Adj:  | 1.00        | 1.00 | 1.00 | 1.00        | 1.00 | 1.00 | 1.00       | 1.00 | 1.00 | 1.00       | 1.00 | 1.00 |
| PHF Adj:   | 1.00        | 1.00 | 1.00 | 1.00        | 1.00 | 1.00 | 1.00       | 1.00 | 1.00 | 1.00       | 1.00 | 1.00 |
| PHF Volume:  | 144         | 94   | 38   | 76          | 61   | 150  | 108        | 917  | 47   | 26         | 1153 | 20   |
| Reduct Vol:  | 0           | 0    | 0    | 0           | 0    | 0    | 0          | 0    | 0    | 0          | 0    | 0    |
| Reduced Vol:   | 144         | 94   | 38   | 76          | 61   | 150  | 108        | 917  | 47   | 26         | 1153 | 20   |
| PCE Adj:   | 1.00        | 1.00 | 1.00 | 1.00        | 1.00 | 1.00 | 1.00       | 1.00 | 1.00 | 1.00       | 1.00 | 1.00 |
| MLF Adj:   | 1.00        | 1.00 | 1.00 | 1.00        | 1.00 | 1.00 | 1.00       | 1.00 | 1.00 | 1.00       | 1.00 | 1.00 |
| FinalVolume:   | 144         | 94   | 38   | 76          | 61   | 150  | 108        | 917  | 47   | 26         | 1153 | 20   |
| Saturation Flow Module:                                  |             |      |      |             |      |      |            |      |      |            |      |      |
| Sat/Lane:  | 1900        | 1900 | 1900 | 1900        | 1900 | 1900 | 1900       | 1900 | 1900 | 1900       | 1900 | 1900 |
| Adjustment:  | 0.92        | 0.92 | 0.92 | 0.95        | 0.95 | 0.92 | 0.92       | 0.98 | 0.95 | 0.92       | 0.97 | 0.95 |
| Lanes:   | 0.52        | 0.34 | 0.14 | 0.55        | 0.45 | 1.00 | 1.00       | 1.90 | 0.10 | 1.00       | 1.96 | 0.04 |
| Final Sat.:  | 913         | 596  | 241  | 999         | 801  | 1750 | 1750       | 3519 | 180  | 1750       | 3637 | 63   |
| Capacity Analysis Module:                                |             |      |      |             |      |      |            |      |      |            |      |      |
| Vol/Sat:   | 0.16        | 0.16 | 0.16 | 0.08        | 0.08 | 0.09 | 0.06       | 0.26 | 0.26 | 0.01       | 0.32 | 0.32 |
| Crit Moves:  | ****        |      |      | ****        | **** | **** | ****       | **** | **** | ****       | **** | **** |
| Green Time:  | 33.2        | 34.6 | 34.6 | 16.7        | 18.0 | 18.0 | 13.0       | 66.9 | 66.9 | 12.8       | 66.8 | 66.8 |
| Volume/Cap:  | 0.66        | 0.64 | 0.64 | 0.64        | 0.59 | 0.66 | 0.66       | 0.55 | 0.55 | 0.16       | 0.66 | 0.66 |
| Delay/Veh:   | 52.4        | 50.3 | 50.3 | 65.1        | 61.5 | 65.4 | 71.4       | 26.2 | 26.2 | 59.1       | 29.0 | 29.0 |
| User DelAdj:   | 1.00        | 1.00 | 1.00 | 1.00        | 1.00 | 1.00 | 1.00       | 1.00 | 1.00 | 1.00       | 1.00 | 1.00 |
| AdjDel/Veh:  | 52.4        | 50.3 | 50.3 | 65.1        | 61.5 | 65.4 | 71.4       | 26.2 | 26.2 | 59.1       | 29.0 | 29.0 |
| LOS by Move:   | D           | D    | D    | E           | E    | E    | E          | C    | C    | E          | C    | C    |
| HCM2k95thQ:  | 21          | 21   | 21   | 13          | 13   | 15   | 10         | 26   | 26   | 2          | 32   | 32   |

Note: Queue reported is the number of cars per lane.

BART

Level Of Service Computation Report  
 2000 HCM Operations (Future Volume Alternative)  
 PM - Exist + Proj Conditions

Intersection #3678: MCKEE/33RD [Study Int 6]

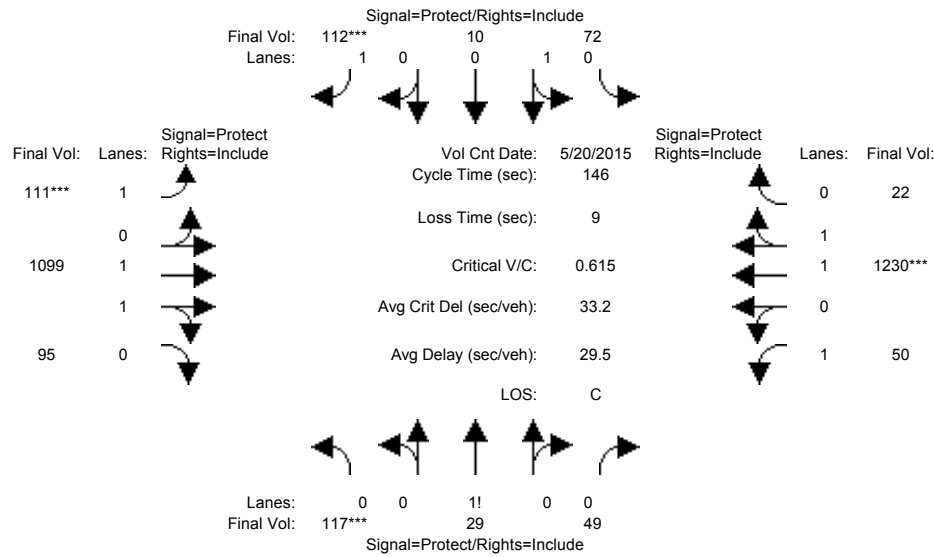

| Approach:  | North Bound |      |      | South Bound |      |      | East Bound |      |      | West Bound |      |      |
|--|-------------|------|------|-------------|------|------|------------|------|------|------------|------|------|
| Movement:  | L           | T    | R    | L           | T    | R    | L          | T    | R    | L          | T    | R    |
| Min. Green:  | 10          | 10   | 10   | 10          | 10   | 10   | 7          | 10   | 10   | 7          | 10   | 10   |
| Y+R:   | 4.0         | 4.0  | 4.0  | 4.0         | 4.0  | 4.0  | 4.0        | 4.0  | 4.0  | 4.0        | 4.0  | 4.0  |
| Volume Module: >> Count Date: 20 May 2015 << 5:00-6:00PM |             |      |      |             |      |      |            |      |      |            |      |      |
| Base Vol:  | 117         | 29   | 49   | 72          | 10   | 112  | 111        | 1099 | 95   | 50         | 1230 | 22   |
| Growth Adj:  | 1.00        | 1.00 | 1.00 | 1.00        | 1.00 | 1.00 | 1.00       | 1.00 | 1.00 | 1.00       | 1.00 | 1.00 |
| Initial Bse:   | 117         | 29   | 49   | 72          | 10   | 112  | 111        | 1099 | 95   | 50         | 1230 | 22   |
| Added Vol:   | 0           | 0    | 0    | 0           | 0    | 0    | 0          | 0    | 0    | 0          | 0    | 0    |
| PasserByVol:   | 0           | 0    | 0    | 0           | 0    | 0    | 0          | 0    | 0    | 0          | 0    | 0    |
| Initial Fut:   | 117         | 29   | 49   | 72          | 10   | 112  | 111        | 1099 | 95   | 50         | 1230 | 22   |
| User Adj:  | 1.00        | 1.00 | 1.00 | 1.00        | 1.00 | 1.00 | 1.00       | 1.00 | 1.00 | 1.00       | 1.00 | 1.00 |
| PHF Adj:   | 1.00        | 1.00 | 1.00 | 1.00        | 1.00 | 1.00 | 1.00       | 1.00 | 1.00 | 1.00       | 1.00 | 1.00 |
| PHF Volume:  | 117         | 29   | 49   | 72          | 10   | 112  | 111        | 1099 | 95   | 50         | 1230 | 22   |
| Reduct Vol:  | 0           | 0    | 0    | 0           | 0    | 0    | 0          | 0    | 0    | 0          | 0    | 0    |
| Reduced Vol:   | 117         | 29   | 49   | 72          | 10   | 112  | 111        | 1099 | 95   | 50         | 1230 | 22   |
| PCE Adj:   | 1.00        | 1.00 | 1.00 | 1.00        | 1.00 | 1.00 | 1.00       | 1.00 | 1.00 | 1.00       | 1.00 | 1.00 |
| MLF Adj:   | 1.00        | 1.00 | 1.00 | 1.00        | 1.00 | 1.00 | 1.00       | 1.00 | 1.00 | 1.00       | 1.00 | 1.00 |
| Final Volume:  | 117         | 29   | 49   | 72          | 10   | 112  | 111        | 1099 | 95   | 50         | 1230 | 22   |
| Saturation Flow Module:                                  |             |      |      |             |      |      |            |      |      |            |      |      |
| Sat/Lane:  | 1900        | 1900 | 1900 | 1900        | 1900 | 1900 | 1900       | 1900 | 1900 | 1900       | 1900 | 1900 |
| Adjustment:  | 0.92        | 0.92 | 0.92 | 0.95        | 0.95 | 0.92 | 0.92       | 0.98 | 0.95 | 0.92       | 0.97 | 0.95 |
| Lanes:   | 0.60        | 0.15 | 0.25 | 0.88        | 0.12 | 1.00 | 1.00       | 1.84 | 0.16 | 1.00       | 1.96 | 0.04 |
| Final Sat.:  | 1050        | 260  | 440  | 1580        | 220  | 1750 | 1750       | 3405 | 294  | 1750       | 3635 | 65   |
| Capacity Analysis Module:                                |             |      |      |             |      |      |            |      |      |            |      |      |
| Vol/Sat:   | 0.11        | 0.11 | 0.11 | 0.05        | 0.05 | 0.06 | 0.06       | 0.32 | 0.32 | 0.03       | 0.34 | 0.34 |
| Crit Moves:  | ****        |      |      | ****        | **** | **** | ****       | **** | **** | ****       | **** | **** |
| Green Time:  | 26.4        | 25.8 | 25.8 | 15.8        | 15.2 | 15.2 | 15.1       | 83.0 | 83.0 | 12.3       | 80.3 | 80.3 |
| Volume/Cap:  | 0.62        | 0.63 | 0.63 | 0.42        | 0.44 | 0.62 | 0.62       | 0.57 | 0.57 | 0.34       | 0.62 | 0.62 |
| Delay/Veh:   | 58.7        | 59.9 | 59.9 | 62.2        | 63.0 | 68.8 | 68.9       | 20.4 | 20.4 | 64.3       | 22.9 | 22.9 |
| User DelAdj:   | 1.00        | 1.00 | 1.00 | 1.00        | 1.00 | 1.00 | 1.00       | 1.00 | 1.00 | 1.00       | 1.00 | 1.00 |
| AdjDel/Veh:  | 58.7        | 59.9 | 59.9 | 62.2        | 63.0 | 68.8 | 68.9       | 20.4 | 20.4 | 64.3       | 22.9 | 22.9 |
| LOS by Move:   | E           | E    | E    | E           | E    | E    | E          | C    | C    | E          | C    | C    |
| HCM2k95thQ:  | 16          | 16   | 16   | 8           | 8    | 12   | 10         | 29   | 29   | 4          | 32   | 32   |

Note: Queue reported is the number of cars per lane.

BART

Level Of Service Computation Report  
 2000 HCM Operations (Future Volume Alternative)  
 AM - Exist + Proj Conditions

Intersection #3683: McLAUGHLIN/STORY [Study Int 26]

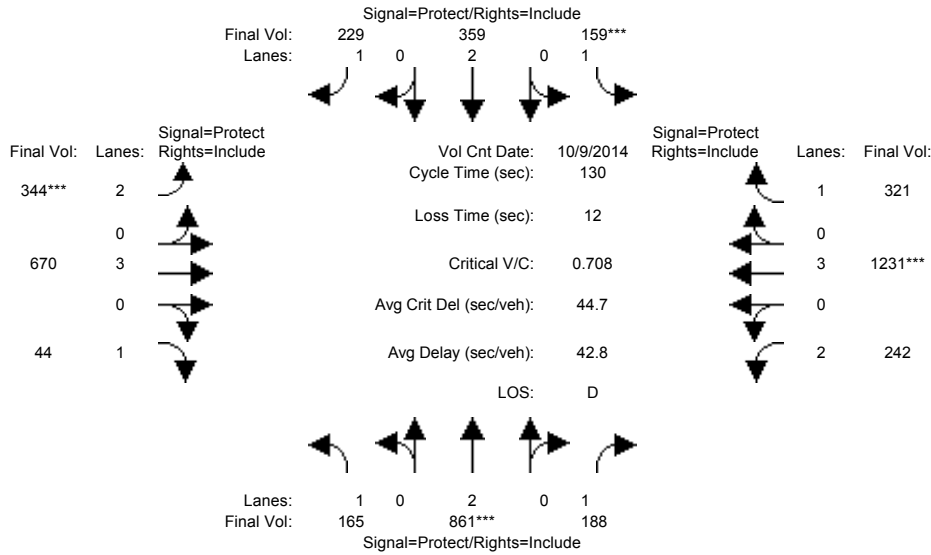

| Approach:                                   | North Bound |      |      | South Bound |      |      | East Bound |      |      | West Bound |      |      |
|---|-------------|------|------|-------------|------|------|------------|------|------|------------|------|------|
| Movement:                                   | L           | T    | R    | L           | T    | R    | L          | T    | R    | L          | T    | R    |
| Min. Green:                                 | 7           | 10   | 10   | 7           | 10   | 10   | 7          | 10   | 10   | 7          | 10   | 10   |
| Y+R:  | 4.0         | 4.0  | 4.0  | 4.0         | 4.0  | 4.0  | 4.0        | 4.0  | 4.0  | 4.0        | 4.0  | 4.0  |
| Volume Module: >> Count Date: 9 Oct 2014 << |             |      |      |             |      |      |            |      |      |            |      |      |
| Base Vol:                                   | 165         | 861  | 188  | 159         | 359  | 229  | 344        | 670  | 44   | 242        | 1231 | 321  |
| Growth Adj:                                 | 1.00        | 1.00 | 1.00 | 1.00        | 1.00 | 1.00 | 1.00       | 1.00 | 1.00 | 1.00       | 1.00 | 1.00 |
| Initial Bse:                                | 165         | 861  | 188  | 159         | 359  | 229  | 344        | 670  | 44   | 242        | 1231 | 321  |
| Added Vol:                                  | 0           | 0    | 0    | 0           | 0    | 0    | 0          | 0    | 0    | 0          | 0    | 0    |
| PasserByVol:                                | 0           | 0    | 0    | 0           | 0    | 0    | 0          | 0    | 0    | 0          | 0    | 0    |
| Initial Fut:                                | 165         | 861  | 188  | 159         | 359  | 229  | 344        | 670  | 44   | 242        | 1231 | 321  |
| User Adj:                                   | 1.00        | 1.00 | 1.00 | 1.00        | 1.00 | 1.00 | 1.00       | 1.00 | 1.00 | 1.00       | 1.00 | 1.00 |
| PHF Adj:                                    | 1.00        | 1.00 | 1.00 | 1.00        | 1.00 | 1.00 | 1.00       | 1.00 | 1.00 | 1.00       | 1.00 | 1.00 |
| PHF Volume:                                 | 165         | 861  | 188  | 159         | 359  | 229  | 344        | 670  | 44   | 242        | 1231 | 321  |
| Reduct Vol:                                 | 0           | 0    | 0    | 0           | 0    | 0    | 0          | 0    | 0    | 0          | 0    | 0    |
| Reduced Vol:                                | 165         | 861  | 188  | 159         | 359  | 229  | 344        | 670  | 44   | 242        | 1231 | 321  |
| PCE Adj:                                    | 1.00        | 1.00 | 1.00 | 1.00        | 1.00 | 1.00 | 1.00       | 1.00 | 1.00 | 1.00       | 1.00 | 1.00 |
| MLF Adj:                                    | 1.00        | 1.00 | 1.00 | 1.00        | 1.00 | 1.00 | 1.00       | 1.00 | 1.00 | 1.00       | 1.00 | 1.00 |
| Final Volume:                               | 165         | 861  | 188  | 159         | 359  | 229  | 344        | 670  | 44   | 242        | 1231 | 321  |
| Saturation Flow Module:                     |             |      |      |             |      |      |            |      |      |            |      |      |
| Sat/Lane:                                   | 1900        | 1900 | 1900 | 1900        | 1900 | 1900 | 1900       | 1900 | 1900 | 1900       | 1900 | 1900 |
| Adjustment:                                 | 0.92        | 1.00 | 0.92 | 0.92        | 1.00 | 0.92 | 0.83       | 1.00 | 0.92 | 0.83       | 1.00 | 0.92 |
| Lanes:                                      | 1.00        | 2.00 | 1.00 | 1.00        | 2.00 | 1.00 | 2.00       | 3.00 | 1.00 | 2.00       | 3.00 | 1.00 |
| Final Sat.:                                 | 1750        | 3800 | 1750 | 1750        | 3800 | 1750 | 3150       | 5700 | 1750 | 3150       | 5700 | 1750 |
| Capacity Analysis Module:                   |             |      |      |             |      |      |            |      |      |            |      |      |
| Vol/Sat:                                    | 0.09        | 0.23 | 0.11 | 0.09        | 0.09 | 0.13 | 0.11       | 0.12 | 0.03 | 0.08       | 0.22 | 0.18 |
| Crit Moves:                                 | ****        | **** | **** | ****        | **** | **** | ****       | **** | **** | ****       | **** | **** |
| Green Time:                                 | 24.4        | 41.6 | 41.6 | 16.7        | 33.9 | 33.9 | 20.1       | 36.1 | 36.1 | 23.6       | 39.7 | 39.7 |
| Volume/Cap:                                 | 0.50        | 0.71 | 0.34 | 0.71        | 0.36 | 0.50 | 0.71       | 0.42 | 0.09 | 0.42       | 0.71 | 0.60 |
| Delay/Veh:                                  | 48.6        | 40.8 | 34.0 | 64.3        | 39.5 | 41.8 | 57.0       | 38.6 | 34.9 | 47.7       | 41.4 | 40.4 |
| User DelAdj:                                | 1.00        | 1.00 | 1.00 | 1.00        | 1.00 | 1.00 | 1.00       | 1.00 | 1.00 | 1.00       | 1.00 | 1.00 |
| AdjDel/Veh:                                 | 48.6        | 40.8 | 34.0 | 64.3        | 39.5 | 41.8 | 57.0       | 38.6 | 34.9 | 47.7       | 41.4 | 40.4 |
| LOS by Move:                                | D           | D    | C    | E           | D    | D    | E          | D    | C    | D          | D    | D    |
| HCM2k95thQ:                                 | 13          | 28   | 12   | 13          | 11   | 15   | 17         | 14   | 3    | 10         | 26   | 21   |

Note: Queue reported is the number of cars per lane.

BART

Level Of Service Computation Report  
 2000 HCM Operations (Future Volume Alternative)  
 PM - Exist + Proj Conditions

Intersection #3683: McLAUGHLIN/STORY [Study Int 26]

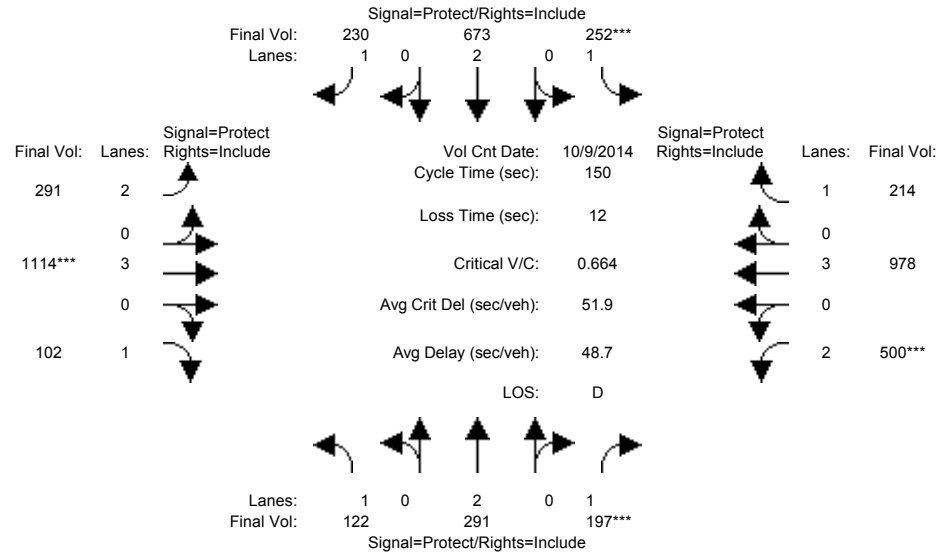

| Approach:                                   | North Bound |      |      | South Bound |      |      | East Bound |      |      | West Bound |      |      |
|---|-------------|------|------|-------------|------|------|------------|------|------|------------|------|------|
| Movement:                                   | L           | T    | R    | L           | T    | R    | L          | T    | R    | L          | T    | R    |
| Min. Green:                                 | 7           | 10   | 10   | 7           | 10   | 10   | 7          | 10   | 10   | 7          | 10   | 10   |
| Y+R:  | 4.0         | 4.0  | 4.0  | 4.0         | 4.0  | 4.0  | 4.0        | 4.0  | 4.0  | 4.0        | 4.0  | 4.0  |
| Volume Module: >> Count Date: 9 Oct 2014 << |             |      |      |             |      |      |            |      |      |            |      |      |
| Base Vol:                                   | 122         | 291  | 197  | 252         | 673  | 230  | 291        | 1114 | 102  | 500        | 978  | 214  |
| Growth Adj:                                 | 1.00        | 1.00 | 1.00 | 1.00        | 1.00 | 1.00 | 1.00       | 1.00 | 1.00 | 1.00       | 1.00 | 1.00 |
| Initial Bse:                                | 122         | 291  | 197  | 252         | 673  | 230  | 291        | 1114 | 102  | 500        | 978  | 214  |
| Added Vol:                                  | 0           | 0    | 0    | 0           | 0    | 0    | 0          | 0    | 0    | 0          | 0    | 0    |
| PasserByVol:                                | 0           | 0    | 0    | 0           | 0    | 0    | 0          | 0    | 0    | 0          | 0    | 0    |
| Initial Fut:                                | 122         | 291  | 197  | 252         | 673  | 230  | 291        | 1114 | 102  | 500        | 978  | 214  |
| User Adj:                                   | 1.00        | 1.00 | 1.00 | 1.00        | 1.00 | 1.00 | 1.00       | 1.00 | 1.00 | 1.00       | 1.00 | 1.00 |
| PHF Adj:                                    | 1.00        | 1.00 | 1.00 | 1.00        | 1.00 | 1.00 | 1.00       | 1.00 | 1.00 | 1.00       | 1.00 | 1.00 |
| PHF Volume:                                 | 122         | 291  | 197  | 252         | 673  | 230  | 291        | 1114 | 102  | 500        | 978  | 214  |
| Reduct Vol:                                 | 0           | 0    | 0    | 0           | 0    | 0    | 0          | 0    | 0    | 0          | 0    | 0    |
| Reduced Vol:                                | 122         | 291  | 197  | 252         | 673  | 230  | 291        | 1114 | 102  | 500        | 978  | 214  |
| PCE Adj:                                    | 1.00        | 1.00 | 1.00 | 1.00        | 1.00 | 1.00 | 1.00       | 1.00 | 1.00 | 1.00       | 1.00 | 1.00 |
| MLF Adj:                                    | 1.00        | 1.00 | 1.00 | 1.00        | 1.00 | 1.00 | 1.00       | 1.00 | 1.00 | 1.00       | 1.00 | 1.00 |
| Final Volume:                               | 122         | 291  | 197  | 252         | 673  | 230  | 291        | 1114 | 102  | 500        | 978  | 214  |
| Saturation Flow Module:                     |             |      |      |             |      |      |            |      |      |            |      |      |
| Sat/Lane:                                   | 1900        | 1900 | 1900 | 1900        | 1900 | 1900 | 1900       | 1900 | 1900 | 1900       | 1900 | 1900 |
| Adjustment:                                 | 0.92        | 1.00 | 0.92 | 0.92        | 1.00 | 0.92 | 0.83       | 1.00 | 0.92 | 0.83       | 1.00 | 0.92 |
| Lanes:                                      | 1.00        | 2.00 | 1.00 | 1.00        | 2.00 | 1.00 | 2.00       | 3.00 | 1.00 | 2.00       | 3.00 | 1.00 |
| Final Sat.:                                 | 1750        | 3800 | 1750 | 1750        | 3800 | 1750 | 3150       | 5700 | 1750 | 3150       | 5700 | 1750 |
| Capacity Analysis Module:                   |             |      |      |             |      |      |            |      |      |            |      |      |
| Vol/Sat:                                    | 0.07        | 0.08 | 0.11 | 0.14        | 0.18 | 0.13 | 0.09       | 0.20 | 0.06 | 0.16       | 0.17 | 0.12 |
| Crit Moves:                                 | ****        | **** | **** | ****        | **** | **** | ****       | **** | **** | ****       | **** | **** |
| Green Time:                                 | 16.4        | 25.4 | 25.4 | 32.5        | 41.6 | 41.6 | 28.0       | 44.2 | 44.2 | 35.9       | 52.0 | 52.0 |
| Volume/Cap:                                 | 0.64        | 0.45 | 0.66 | 0.66        | 0.64 | 0.47 | 0.49       | 0.66 | 0.20 | 0.66       | 0.49 | 0.35 |
| Delay/Veh:                                  | 71.0        | 56.5 | 63.9 | 58.1        | 48.9 | 45.8 | 55.3       | 47.4 | 39.8 | 53.9       | 38.8 | 36.8 |
| User DelAdj:                                | 1.00        | 1.00 | 1.00 | 1.00        | 1.00 | 1.00 | 1.00       | 1.00 | 1.00 | 1.00       | 1.00 | 1.00 |
| AdjDel/Veh:                                 | 71.0        | 56.5 | 63.9 | 58.1        | 48.9 | 45.8 | 55.3       | 47.4 | 39.8 | 53.9       | 38.8 | 36.8 |
| LOS by Move:                                | E           | E    | E    | E           | D    | D    | E          | D    | D    | D          | D    | D    |
| HCM2k95thQ:                                 | 13          | 12   | 19   | 21          | 24   | 17   | 14         | 27   | 7    | 22         | 21   | 14   |

Note: Queue reported is the number of cars per lane.

BART

Level Of Service Computation Report  
 2000 HCM Operations (Future Volume Alternative)  
 AM - Exist + Proj Conditions

Intersection #3762: SAN ANTONIO/24TH [Study Int 21]

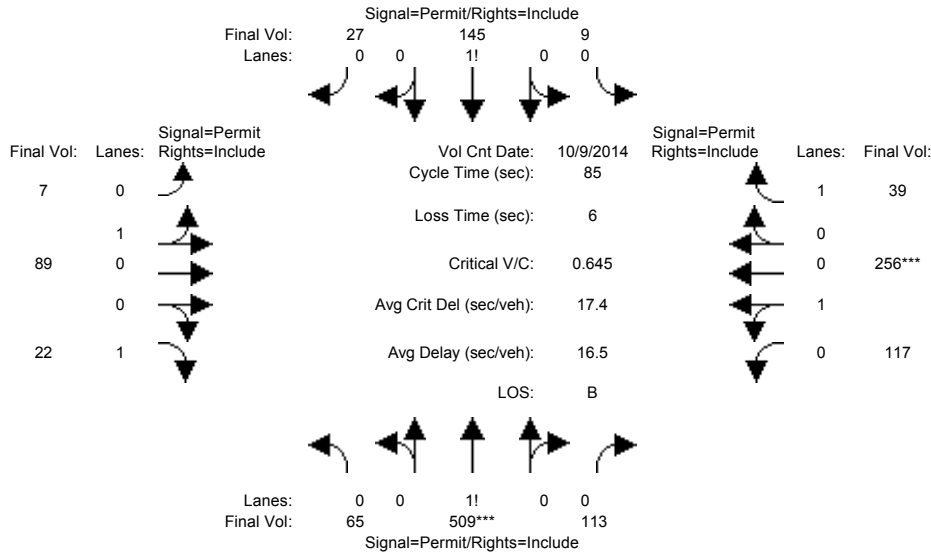

| Approach:                                   | North Bound |      |      | South Bound |      |      | East Bound |      |      | West Bound |      |      |
|---|-------------|------|------|-------------|------|------|------------|------|------|------------|------|------|
| Movement:                                   | L           | T    | R    | L           | T    | R    | L          | T    | R    | L          | T    | R    |
| Min. Green:                                 | 10          | 10   | 10   | 10          | 10   | 10   | 10         | 10   | 10   | 10         | 10   | 10   |
| Y+R:  | 4.0         | 4.0  | 4.0  | 4.0         | 4.0  | 4.0  | 4.0        | 4.0  | 4.0  | 4.0        | 4.0  | 4.0  |
| Volume Module: >> Count Date: 9 Oct 2014 << |             |      |      |             |      |      |            |      |      |            |      |      |
| Base Vol:                                   | 65          | 509  | 113  | 9           | 145  | 27   | 7          | 89   | 22   | 117        | 256  | 39   |
| Growth Adj:                                 | 1.00        | 1.00 | 1.00 | 1.00        | 1.00 | 1.00 | 1.00       | 1.00 | 1.00 | 1.00       | 1.00 | 1.00 |
| Initial Bse:                                | 65          | 509  | 113  | 9           | 145  | 27   | 7          | 89   | 22   | 117        | 256  | 39   |
| Added Vol:                                  | 0           | 0    | 0    | 0           | 0    | 0    | 0          | 0    | 0    | 0          | 0    | 0    |
| PasserByVol:                                | 0           | 0    | 0    | 0           | 0    | 0    | 0          | 0    | 0    | 0          | 0    | 0    |
| Initial Fut:                                | 65          | 509  | 113  | 9           | 145  | 27   | 7          | 89   | 22   | 117        | 256  | 39   |
| User Adj:                                   | 1.00        | 1.00 | 1.00 | 1.00        | 1.00 | 1.00 | 1.00       | 1.00 | 1.00 | 1.00       | 1.00 | 1.00 |
| PHF Adj:                                    | 1.00        | 1.00 | 1.00 | 1.00        | 1.00 | 1.00 | 1.00       | 1.00 | 1.00 | 1.00       | 1.00 | 1.00 |
| PHF Volume:                                 | 65          | 509  | 113  | 9           | 145  | 27   | 7          | 89   | 22   | 117        | 256  | 39   |
| Reduct Vol:                                 | 0           | 0    | 0    | 0           | 0    | 0    | 0          | 0    | 0    | 0          | 0    | 0    |
| Reduced Vol:                                | 65          | 509  | 113  | 9           | 145  | 27   | 7          | 89   | 22   | 117        | 256  | 39   |
| PCE Adj:                                    | 1.00        | 1.00 | 1.00 | 1.00        | 1.00 | 1.00 | 1.00       | 1.00 | 1.00 | 1.00       | 1.00 | 1.00 |
| MLF Adj:                                    | 1.00        | 1.00 | 1.00 | 1.00        | 1.00 | 1.00 | 1.00       | 1.00 | 1.00 | 1.00       | 1.00 | 1.00 |
| FinalVolume:                                | 65          | 509  | 113  | 9           | 145  | 27   | 7          | 89   | 22   | 117        | 256  | 39   |
| Saturation Flow Module:                     |             |      |      |             |      |      |            |      |      |            |      |      |
| Sat/Lane:                                   | 1900        | 1900 | 1900 | 1900        | 1900 | 1900 | 1900       | 1900 | 1900 | 1900       | 1900 | 1900 |
| Adjustment:                                 | 0.92        | 0.92 | 0.92 | 0.92        | 0.92 | 0.92 | 0.95       | 0.95 | 0.92 | 0.95       | 0.95 | 0.92 |
| Lanes:                                      | 0.09        | 0.75 | 0.16 | 0.05        | 0.80 | 0.15 | 0.07       | 0.93 | 1.00 | 0.31       | 0.69 | 1.00 |
| Final Sat.:                                 | 166         | 1297 | 288  | 87          | 1402 | 261  | 131        | 1669 | 1750 | 565        | 1235 | 1750 |
| Capacity Analysis Module:                   |             |      |      |             |      |      |            |      |      |            |      |      |
| Vol/Sat:                                    | 0.39        | 0.39 | 0.39 | 0.10        | 0.10 | 0.10 | 0.05       | 0.05 | 0.01 | 0.21       | 0.21 | 0.02 |
| Crit Moves:                                 | ****        |      |      |             |      |      |            |      |      | ****       |      |      |
| Green Time:                                 | 51.7        | 51.7 | 51.7 | 51.7        | 51.7 | 51.7 | 27.3       | 27.3 | 27.3 | 27.3       | 27.3 | 27.3 |
| Volume/Cap:                                 | 0.65        | 0.65 | 0.65 | 0.17        | 0.17 | 0.17 | 0.17       | 0.17 | 0.04 | 0.65       | 0.65 | 0.07 |
| Delay/Veh:                                  | 12.1        | 12.1 | 12.1 | 7.3         | 7.3  | 7.3  | 20.8       | 20.8 | 19.9 | 27.2       | 27.2 | 20.1 |
| User DelAdj:                                | 1.00        | 1.00 | 1.00 | 1.00        | 1.00 | 1.00 | 1.00       | 1.00 | 1.00 | 1.00       | 1.00 | 1.00 |
| AdjDel/Veh:                                 | 12.1        | 12.1 | 12.1 | 7.3         | 7.3  | 7.3  | 20.8       | 20.8 | 19.9 | 27.2       | 27.2 | 20.1 |
| LOS by Move:                                | B           | B    | B    | A           | A    | A    | C          | C    | B    | C          | C    | C    |
| HCM2k95thQ:                                 | 22          | 22   | 22   | 5           | 5    | 5    | 4          | 4    | 1    | 16         | 16   | 2    |

Note: Queue reported is the number of cars per lane.



BART

Level Of Service Computation Report  
2000 HCM Operations (Future Volume Alternative)  
PM - Exist + Proj Conditions

Intersection #3762: SAN ANTONIO/24TH [Study Int 21]

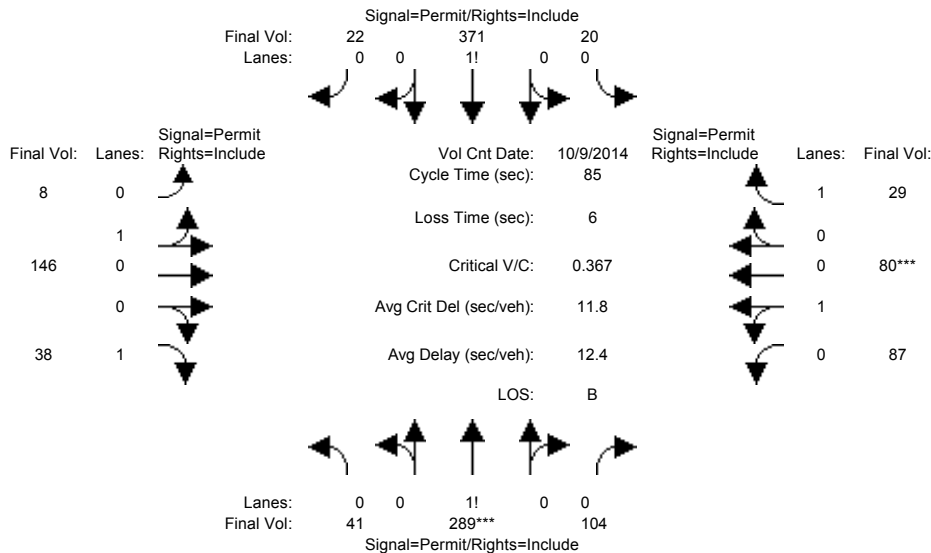

| Approach:                                   | North Bound |      |      | South Bound |      |      | East Bound |      |      | West Bound |      |      |
|---|-------------|------|------|-------------|------|------|------------|------|------|------------|------|------|
| Movement:                                   | L           | T    | R    | L           | T    | R    | L          | T    | R    | L          | T    | R    |
| Min. Green:                                 | 10          | 10   | 10   | 10          | 10   | 10   | 10         | 10   | 10   | 10         | 10   | 10   |
| Y+R:  | 4.0         | 4.0  | 4.0  | 4.0         | 4.0  | 4.0  | 4.0        | 4.0  | 4.0  | 4.0        | 4.0  | 4.0  |
| Volume Module: >> Count Date: 9 Oct 2014 << |             |      |      |             |      |      |            |      |      |            |      |      |
| Base Vol:                                   | 41          | 289  | 104  | 20          | 371  | 22   | 8          | 146  | 38   | 87         | 80   | 29   |
| Growth Adj:                                 | 1.00        | 1.00 | 1.00 | 1.00        | 1.00 | 1.00 | 1.00       | 1.00 | 1.00 | 1.00       | 1.00 | 1.00 |
| Initial Bse:                                | 41          | 289  | 104  | 20          | 371  | 22   | 8          | 146  | 38   | 87         | 80   | 29   |
| Added Vol:                                  | 0           | 0    | 0    | 0           | 0    | 0    | 0          | 0    | 0    | 0          | 0    | 0    |
| PasserByVol:                                | 0           | 0    | 0    | 0           | 0    | 0    | 0          | 0    | 0    | 0          | 0    | 0    |
| Initial Fut:                                | 41          | 289  | 104  | 20          | 371  | 22   | 8          | 146  | 38   | 87         | 80   | 29   |
| User Adj:                                   | 1.00        | 1.00 | 1.00 | 1.00        | 1.00 | 1.00 | 1.00       | 1.00 | 1.00 | 1.00       | 1.00 | 1.00 |
| PHF Adj:                                    | 1.00        | 1.00 | 1.00 | 1.00        | 1.00 | 1.00 | 1.00       | 1.00 | 1.00 | 1.00       | 1.00 | 1.00 |
| PHF Volume:                                 | 41          | 289  | 104  | 20          | 371  | 22   | 8          | 146  | 38   | 87         | 80   | 29   |
| Reduct Vol:                                 | 0           | 0    | 0    | 0           | 0    | 0    | 0          | 0    | 0    | 0          | 0    | 0    |
| Reduced Vol:                                | 41          | 289  | 104  | 20          | 371  | 22   | 8          | 146  | 38   | 87         | 80   | 29   |
| PCE Adj:                                    | 1.00        | 1.00 | 1.00 | 1.00        | 1.00 | 1.00 | 1.00       | 1.00 | 1.00 | 1.00       | 1.00 | 1.00 |
| MLF Adj:                                    | 1.00        | 1.00 | 1.00 | 1.00        | 1.00 | 1.00 | 1.00       | 1.00 | 1.00 | 1.00       | 1.00 | 1.00 |
| Final Volume:                               | 41          | 289  | 104  | 20          | 371  | 22   | 8          | 146  | 38   | 87         | 80   | 29   |
| Saturation Flow Module:                     |             |      |      |             |      |      |            |      |      |            |      |      |
| Sat/Lane:                                   | 1900        | 1900 | 1900 | 1900        | 1900 | 1900 | 1900       | 1900 | 1900 | 1900       | 1900 | 1900 |
| Adjustment:                                 | 0.92        | 0.92 | 0.92 | 0.92        | 0.92 | 0.92 | 0.95       | 0.95 | 0.92 | 0.95       | 0.95 | 0.92 |
| Lanes:                                      | 0.09        | 0.67 | 0.24 | 0.05        | 0.90 | 0.05 | 0.05       | 0.95 | 1.00 | 0.52       | 0.48 | 1.00 |
| Final Sat.:                                 | 165         | 1165 | 419  | 85          | 1572 | 93   | 94         | 1706 | 1750 | 938        | 862  | 1750 |
| Capacity Analysis Module:                   |             |      |      |             |      |      |            |      |      |            |      |      |
| Vol/Sat:                                    | 0.25        | 0.25 | 0.25 | 0.24        | 0.24 | 0.24 | 0.09       | 0.09 | 0.02 | 0.09       | 0.09 | 0.02 |
| Crit Moves:                                 | ****        |      |      |             |      |      |            |      |      |            |      |      |
| Green Time:                                 | 57.5        | 57.5 | 57.5 | 57.5        | 57.5 | 57.5 | 21.5       | 21.5 | 21.5 | 21.5       | 21.5 | 21.5 |
| Volume/Cap:                                 | 0.37        | 0.37 | 0.37 | 0.35        | 0.35 | 0.35 | 0.34       | 0.34 | 0.09 | 0.37       | 0.37 | 0.07 |
| Delay/Veh:                                  | 6.1         | 6.1  | 6.1  | 6.0         | 6.0  | 6.0  | 26.4       | 26.4 | 24.3 | 26.6       | 26.6 | 24.2 |
| User DelAdj:                                | 1.00        | 1.00 | 1.00 | 1.00        | 1.00 | 1.00 | 1.00       | 1.00 | 1.00 | 1.00       | 1.00 | 1.00 |
| AdjDel/Veh:                                 | 6.1         | 6.1  | 6.1  | 6.0         | 6.0  | 6.0  | 26.4       | 26.4 | 24.3 | 26.6       | 26.6 | 24.2 |
| LOS by Move:                                | A           | A    | A    | A           | A    | A    | C          | C    | C    | C          | C    | C    |
| HCM2k95thQ:                                 | 10          | 10   | 10   | 10          | 10   | 10   | 7          | 7    | 2    | 7          | 7    | 1    |

Note: Queue reported is the number of cars per lane.

BART

Level Of Service Computation Report  
2000 HCM Operations (Future Volume Alternative)  
AM - Exist + Proj Conditions

Intersection #3783: SANTA CLARA/17TH [Study Int 9]

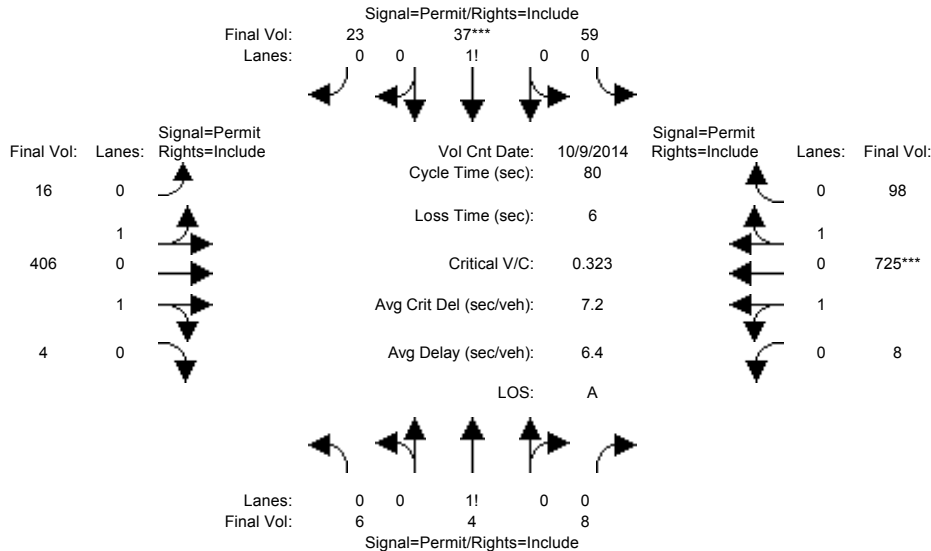

| Approach:                                   | North Bound |      |      | South Bound |      |      | East Bound |      |      | West Bound |      |      |
|---|-------------|------|------|-------------|------|------|------------|------|------|------------|------|------|
| Movement:                                   | L           | T    | R    | L           | T    | R    | L          | T    | R    | L          | T    | R    |
| Min. Green:                                 | 10          | 10   | 10   | 10          | 10   | 10   | 10         | 10   | 10   | 10         | 10   | 10   |
| Y+R:  | 4.0         | 4.0  | 4.0  | 4.0         | 4.0  | 4.0  | 4.0        | 4.0  | 4.0  | 4.0        | 4.0  | 4.0  |
| -----                                       |             |      |      |             |      |      |            |      |      |            |      |      |
| Volume Module: >> Count Date: 9 Oct 2014 << |             |      |      |             |      |      |            |      |      |            |      |      |
| Base Vol:                                   | 6           | 4    | 8    | 59          | 37   | 23   | 16         | 406  | 4    | 8          | 725  | 98   |
| Growth Adj:                                 | 1.00        | 1.00 | 1.00 | 1.00        | 1.00 | 1.00 | 1.00       | 1.00 | 1.00 | 1.00       | 1.00 | 1.00 |
| Initial Bse:                                | 6           | 4    | 8    | 59          | 37   | 23   | 16         | 406  | 4    | 8          | 725  | 98   |
| Added Vol:                                  | 0           | 0    | 0    | 0           | 0    | 0    | 0          | 0    | 0    | 0          | 0    | 0    |
| PasserByVol:                                | 0           | 0    | 0    | 0           | 0    | 0    | 0          | 0    | 0    | 0          | 0    | 0    |
| Initial Fut:                                | 6           | 4    | 8    | 59          | 37   | 23   | 16         | 406  | 4    | 8          | 725  | 98   |
| User Adj:                                   | 1.00        | 1.00 | 1.00 | 1.00        | 1.00 | 1.00 | 1.00       | 1.00 | 1.00 | 1.00       | 1.00 | 1.00 |
| PHF Adj:                                    | 1.00        | 1.00 | 1.00 | 1.00        | 1.00 | 1.00 | 1.00       | 1.00 | 1.00 | 1.00       | 1.00 | 1.00 |
| PHF Volume:                                 | 6           | 4    | 8    | 59          | 37   | 23   | 16         | 406  | 4    | 8          | 725  | 98   |
| Reduct Vol:                                 | 0           | 0    | 0    | 0           | 0    | 0    | 0          | 0    | 0    | 0          | 0    | 0    |
| Reduced Vol:                                | 6           | 4    | 8    | 59          | 37   | 23   | 16         | 406  | 4    | 8          | 725  | 98   |
| PCE Adj:                                    | 1.00        | 1.00 | 1.00 | 1.00        | 1.00 | 1.00 | 1.00       | 1.00 | 1.00 | 1.00       | 1.00 | 1.00 |
| MLF Adj:                                    | 1.00        | 1.00 | 1.00 | 1.00        | 1.00 | 1.00 | 1.00       | 1.00 | 1.00 | 1.00       | 1.00 | 1.00 |
| Final Volume:                               | 6           | 4    | 8    | 59          | 37   | 23   | 16         | 406  | 4    | 8          | 725  | 98   |
| -----                                       |             |      |      |             |      |      |            |      |      |            |      |      |
| Saturation Flow Module:                     |             |      |      |             |      |      |            |      |      |            |      |      |
| Sat/Lane:                                   | 1900        | 1900 | 1900 | 1900        | 1900 | 1900 | 1900       | 1900 | 1900 | 1900       | 1900 | 1900 |
| Adjustment:                                 | 0.92        | 0.92 | 0.92 | 0.92        | 0.92 | 0.92 | 0.95       | 0.95 | 0.95 | 0.95       | 0.95 | 0.95 |
| Lanes:                                      | 0.33        | 0.22 | 0.45 | 0.50        | 0.31 | 0.19 | 0.07       | 1.91 | 0.02 | 0.02       | 1.74 | 0.24 |
| Final Sat.:                                 | 583         | 389  | 778  | 868         | 544  | 338  | 135        | 3431 | 34   | 35         | 3141 | 425  |
| -----                                       |             |      |      |             |      |      |            |      |      |            |      |      |
| Capacity Analysis Module:                   |             |      |      |             |      |      |            |      |      |            |      |      |
| Vol/Sat:                                    | 0.01        | 0.01 | 0.01 | 0.07        | 0.07 | 0.07 | 0.12       | 0.12 | 0.12 | 0.23       | 0.23 | 0.23 |
| Crit Moves:                                 | *****       |      |      |             |      |      |            |      |      |            |      |      |
| Green Time:                                 | 16.8        | 16.8 | 16.8 | 16.8        | 16.8 | 16.8 | 57.2       | 57.2 | 57.2 | 57.2       | 57.2 | 57.2 |
| Volume/Cap:                                 | 0.05        | 0.05 | 0.05 | 0.32        | 0.32 | 0.32 | 0.17       | 0.17 | 0.17 | 0.32       | 0.32 | 0.32 |
| Delay/Veh:                                  | 25.2        | 25.2 | 25.2 | 27.3        | 27.3 | 27.3 | 3.7        | 3.7  | 3.7  | 4.3        | 4.3  | 4.3  |
| User DelAdj:                                | 1.00        | 1.00 | 1.00 | 1.00        | 1.00 | 1.00 | 1.00       | 1.00 | 1.00 | 1.00       | 1.00 | 1.00 |
| AdjDel/Veh:                                 | 25.2        | 25.2 | 25.2 | 27.3        | 27.3 | 27.3 | 3.7        | 3.7  | 3.7  | 4.3        | 4.3  | 4.3  |
| LOS by Move:                                | C           | C    | C    | C           | C    | C    | A          | A    | A    | A          | A    | A    |
| HCM2k95thQ:                                 | 1           | 1    | 1    | 6           | 6    | 6    | 4          | 4    | 4    | 8          | 8    | 8    |

Note: Queue reported is the number of cars per lane.

BART

Level Of Service Computation Report  
2000 HCM Operations (Future Volume Alternative)  
PM - Exist + Proj Conditions

Intersection #3783: SANTA CLARA/17TH [Study Int 9]

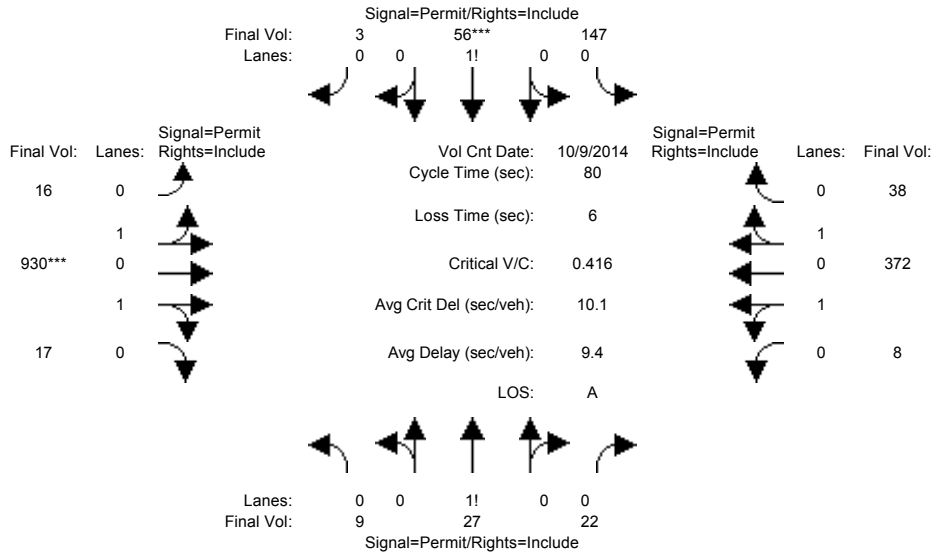

| Approach:                                   | North Bound |      |      | South Bound |      |      | East Bound |      |      | West Bound |      |      |
|---|-------------|------|------|-------------|------|------|------------|------|------|------------|------|------|
| Movement:                                   | L           | T    | R    | L           | T    | R    | L          | T    | R    | L          | T    | R    |
| Min. Green:                                 | 10          | 10   | 10   | 10          | 10   | 10   | 10         | 10   | 10   | 10         | 10   | 10   |
| Y+R:  | 4.0         | 4.0  | 4.0  | 4.0         | 4.0  | 4.0  | 4.0        | 4.0  | 4.0  | 4.0        | 4.0  | 4.0  |
| Volume Module: >> Count Date: 9 Oct 2014 << |             |      |      |             |      |      |            |      |      |            |      |      |
| Base Vol:                                   | 9           | 27   | 22   | 147         | 56   | 3    | 16         | 930  | 17   | 8          | 372  | 38   |
| Growth Adj:                                 | 1.00        | 1.00 | 1.00 | 1.00        | 1.00 | 1.00 | 1.00       | 1.00 | 1.00 | 1.00       | 1.00 | 1.00 |
| Initial Bse:                                | 9           | 27   | 22   | 147         | 56   | 3    | 16         | 930  | 17   | 8          | 372  | 38   |
| Added Vol:                                  | 0           | 0    | 0    | 0           | 0    | 0    | 0          | 0    | 0    | 0          | 0    | 0    |
| PasserByVol:                                | 0           | 0    | 0    | 0           | 0    | 0    | 0          | 0    | 0    | 0          | 0    | 0    |
| Initial Fut:                                | 9           | 27   | 22   | 147         | 56   | 3    | 16         | 930  | 17   | 8          | 372  | 38   |
| User Adj:                                   | 1.00        | 1.00 | 1.00 | 1.00        | 1.00 | 1.00 | 1.00       | 1.00 | 1.00 | 1.00       | 1.00 | 1.00 |
| PHF Adj:                                    | 1.00        | 1.00 | 1.00 | 1.00        | 1.00 | 1.00 | 1.00       | 1.00 | 1.00 | 1.00       | 1.00 | 1.00 |
| PHF Volume:                                 | 9           | 27   | 22   | 147         | 56   | 3    | 16         | 930  | 17   | 8          | 372  | 38   |
| Reduct Vol:                                 | 0           | 0    | 0    | 0           | 0    | 0    | 0          | 0    | 0    | 0          | 0    | 0    |
| Reduced Vol:                                | 9           | 27   | 22   | 147         | 56   | 3    | 16         | 930  | 17   | 8          | 372  | 38   |
| PCE Adj:                                    | 1.00        | 1.00 | 1.00 | 1.00        | 1.00 | 1.00 | 1.00       | 1.00 | 1.00 | 1.00       | 1.00 | 1.00 |
| MLF Adj:                                    | 1.00        | 1.00 | 1.00 | 1.00        | 1.00 | 1.00 | 1.00       | 1.00 | 1.00 | 1.00       | 1.00 | 1.00 |
| FinalVolume:                                | 9           | 27   | 22   | 147         | 56   | 3    | 16         | 930  | 17   | 8          | 372  | 38   |
| Saturation Flow Module:                     |             |      |      |             |      |      |            |      |      |            |      |      |
| Sat/Lane:                                   | 1900        | 1900 | 1900 | 1900        | 1900 | 1900 | 1900       | 1900 | 1900 | 1900       | 1900 | 1900 |
| Adjustment:                                 | 0.92        | 0.92 | 0.92 | 0.92        | 0.92 | 0.92 | 0.95       | 0.95 | 0.95 | 0.95       | 0.95 | 0.95 |
| Lanes:                                      | 0.15        | 0.47 | 0.38 | 0.72        | 0.27 | 0.01 | 0.03       | 1.93 | 0.04 | 0.04       | 1.78 | 0.18 |
| Final Sat.:                                 | 272         | 815  | 664  | 1249        | 476  | 25   | 60         | 3477 | 64   | 69         | 3204 | 327  |
| Capacity Analysis Module:                   |             |      |      |             |      |      |            |      |      |            |      |      |
| Vol/Sat:                                    | 0.03        | 0.03 | 0.03 | 0.12        | 0.12 | 0.12 | 0.27       | 0.27 | 0.27 | 0.12       | 0.12 | 0.12 |
| Crit Moves:                                 |             |      |      | ****        |      |      |            | **** |      |            |      |      |
| Green Time:                                 | 22.6        | 22.6 | 22.6 | 22.6        | 22.6 | 22.6 | 51.4       | 51.4 | 51.4 | 51.4       | 51.4 | 51.4 |
| Volume/Cap:                                 | 0.12        | 0.12 | 0.12 | 0.42        | 0.42 | 0.42 | 0.42       | 0.42 | 0.42 | 0.18       | 0.18 | 0.18 |
| Delay/Veh:                                  | 21.4        | 21.4 | 21.4 | 23.9        | 23.9 | 23.9 | 7.1        | 7.1  | 7.1  | 5.8        | 5.8  | 5.8  |
| User DelAdj:                                | 1.00        | 1.00 | 1.00 | 1.00        | 1.00 | 1.00 | 1.00       | 1.00 | 1.00 | 1.00       | 1.00 | 1.00 |
| AdjDel/Veh:                                 | 21.4        | 21.4 | 21.4 | 23.9        | 23.9 | 23.9 | 7.1        | 7.1  | 7.1  | 5.8        | 5.8  | 5.8  |
| LOS by Move:                                | C           | C    | C    | C           | C    | C    | A          | A    | A    | A          | A    | A    |
| HCM2k95thQ:                                 | 2           | 2    | 2    | 9           | 9    | 9    | 12         | 12   | 12   | 4          | 4    | 4    |

Note: Queue reported is the number of cars per lane.

BART

Level Of Service Computation Report  
2000 HCM Operations (Future Volume Alternative)  
AM - Exist + Proj Conditions

Intersection #3788: SANTA CLARA/28TH [Study Int 13]

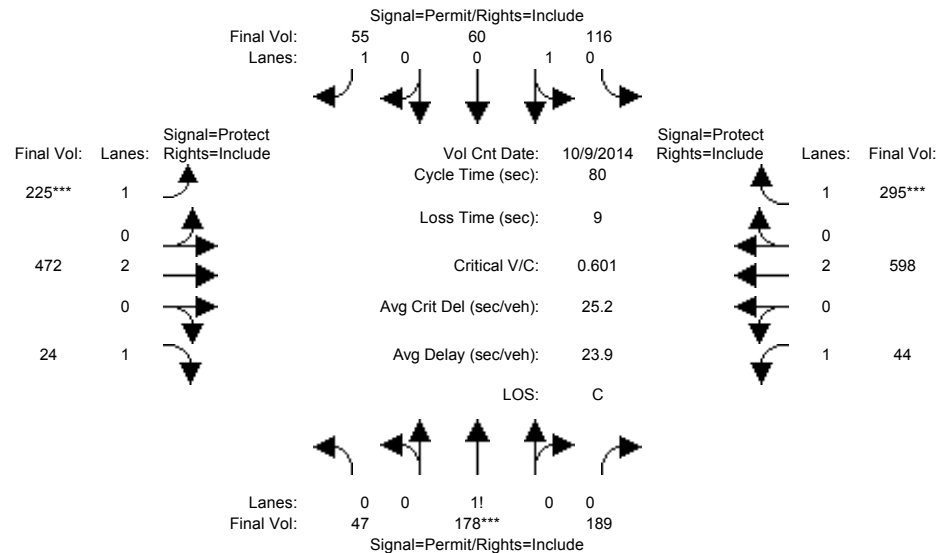

| Approach:                                   | North Bound |      |      | South Bound |      |      | East Bound |      |      | West Bound |      |      |
|---|-------------|------|------|-------------|------|------|------------|------|------|------------|------|------|
| Movement:                                   | L           | T    | R    | L           | T    | R    | L          | T    | R    | L          | T    | R    |
| Min. Green:                                 | 10          | 10   | 10   | 10          | 10   | 10   | 7          | 10   | 10   | 7          | 10   | 10   |
| Y+R:  | 4.0         | 4.0  | 4.0  | 4.0         | 4.0  | 4.0  | 4.0        | 4.0  | 4.0  | 4.0        | 4.0  | 4.0  |
| Volume Module: >> Count Date: 9 Oct 2014 << |             |      |      |             |      |      |            |      |      |            |      |      |
| Base Vol:                                   | 47          | 178  | 189  | 116         | 60   | 55   | 225        | 472  | 24   | 44         | 598  | 295  |
| Growth Adj:                                 | 1.00        | 1.00 | 1.00 | 1.00        | 1.00 | 1.00 | 1.00       | 1.00 | 1.00 | 1.00       | 1.00 | 1.00 |
| Initial Bse:                                | 47          | 178  | 189  | 116         | 60   | 55   | 225        | 472  | 24   | 44         | 598  | 295  |
| Added Vol:                                  | 0           | 0    | 0    | 0           | 0    | 0    | 0          | 0    | 0    | 0          | 0    | 0    |
| PasserByVol:                                | 0           | 0    | 0    | 0           | 0    | 0    | 0          | 0    | 0    | 0          | 0    | 0    |
| Initial Fut:                                | 47          | 178  | 189  | 116         | 60   | 55   | 225        | 472  | 24   | 44         | 598  | 295  |
| User Adj:                                   | 1.00        | 1.00 | 1.00 | 1.00        | 1.00 | 1.00 | 1.00       | 1.00 | 1.00 | 1.00       | 1.00 | 1.00 |
| PHF Adj:                                    | 1.00        | 1.00 | 1.00 | 1.00        | 1.00 | 1.00 | 1.00       | 1.00 | 1.00 | 1.00       | 1.00 | 1.00 |
| PHF Volume:                                 | 47          | 178  | 189  | 116         | 60   | 55   | 225        | 472  | 24   | 44         | 598  | 295  |
| Reduct Vol:                                 | 0           | 0    | 0    | 0           | 0    | 0    | 0          | 0    | 0    | 0          | 0    | 0    |
| Reduced Vol:                                | 47          | 178  | 189  | 116         | 60   | 55   | 225        | 472  | 24   | 44         | 598  | 295  |
| PCE Adj:                                    | 1.00        | 1.00 | 1.00 | 1.00        | 1.00 | 1.00 | 1.00       | 1.00 | 1.00 | 1.00       | 1.00 | 1.00 |
| MLF Adj:                                    | 1.00        | 1.00 | 1.00 | 1.00        | 1.00 | 1.00 | 1.00       | 1.00 | 1.00 | 1.00       | 1.00 | 1.00 |
| Final Volume:                               | 47          | 178  | 189  | 116         | 60   | 55   | 225        | 472  | 24   | 44         | 598  | 295  |
| Saturation Flow Module:                     |             |      |      |             |      |      |            |      |      |            |      |      |
| Sat/Lane:                                   | 1900        | 1900 | 1900 | 1900        | 1900 | 1900 | 1900       | 1900 | 1900 | 1900       | 1900 | 1900 |
| Adjustment:                                 | 0.92        | 0.92 | 0.92 | 0.95        | 0.95 | 0.92 | 0.92       | 1.00 | 0.92 | 0.92       | 1.00 | 0.92 |
| Lanes:                                      | 0.11        | 0.43 | 0.46 | 0.66        | 0.34 | 1.00 | 1.00       | 2.00 | 1.00 | 1.00       | 2.00 | 1.00 |
| Final Sat.:                                 | 199         | 752  | 799  | 1186        | 614  | 1750 | 1750       | 3800 | 1750 | 1750       | 3800 | 1750 |
| Capacity Analysis Module:                   |             |      |      |             |      |      |            |      |      |            |      |      |
| Vol/Sat:                                    | 0.24        | 0.24 | 0.24 | 0.10        | 0.10 | 0.03 | 0.13       | 0.12 | 0.01 | 0.03       | 0.16 | 0.17 |
| Crit Moves:                                 | ****        | **** | **** | ****        | **** | **** | ****       | **** | **** | ****       | **** | **** |
| Green Time:                                 | 31.5        | 31.5 | 31.5 | 31.5        | 31.5 | 31.5 | 17.1       | 23.3 | 23.3 | 16.3       | 22.4 | 22.4 |
| Volume/Cap:                                 | 0.60        | 0.60 | 0.60 | 0.25        | 0.25 | 0.08 | 0.60       | 0.43 | 0.05 | 0.12       | 0.56 | 0.60 |
| Delay/Veh:                                  | 20.8        | 20.8 | 20.8 | 16.5        | 16.5 | 15.2 | 31.1       | 23.2 | 20.4 | 26.2       | 25.3 | 27.0 |
| User DelAdj:                                | 1.00        | 1.00 | 1.00 | 1.00        | 1.00 | 1.00 | 1.00       | 1.00 | 1.00 | 1.00       | 1.00 | 1.00 |
| AdjDel/Veh:                                 | 20.8        | 20.8 | 20.8 | 16.5        | 16.5 | 15.2 | 31.1       | 23.2 | 20.4 | 26.2       | 25.3 | 27.0 |
| LOS by Move:                                | C           | C    | C    | B           | B    | B    | C          | C    | C    | C          | C    | C    |
| HCM2k95thQ:                                 | 16          | 16   | 16   | 6           | 6    | 2    | 11         | 9    | 1    | 2          | 12   | 13   |

Note: Queue reported is the number of cars per lane.

BART

Level Of Service Computation Report  
 2000 HCM Operations (Future Volume Alternative)  
 PM - Exist + Proj Conditions

Intersection #3788: SANTA CLARA/28TH [Study Int 13]

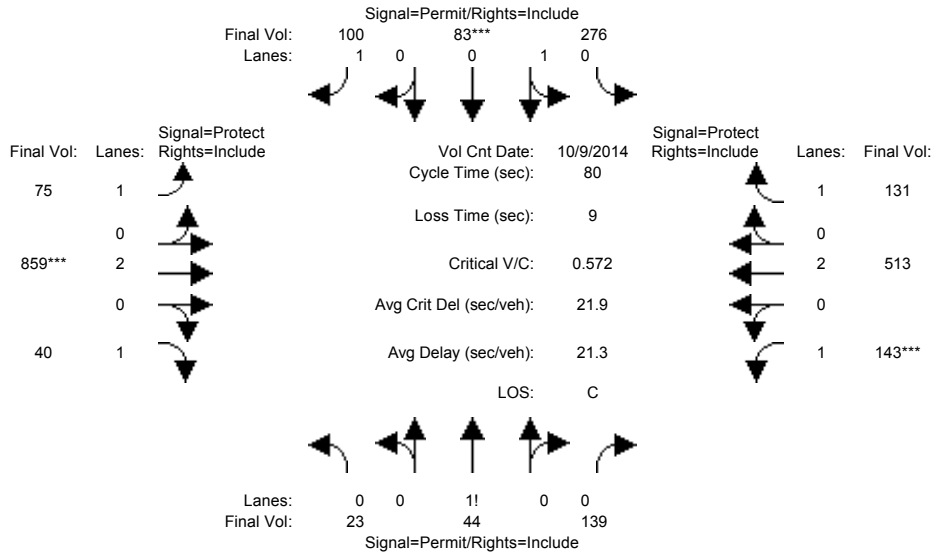

| Approach:                                   | North Bound |      |      | South Bound |      |      | East Bound |      |      | West Bound |      |      |
|---|-------------|------|------|-------------|------|------|------------|------|------|------------|------|------|
| Movement:                                   | L           | T    | R    | L           | T    | R    | L          | T    | R    | L          | T    | R    |
| Min. Green:                                 | 10          | 10   | 10   | 10          | 10   | 10   | 7          | 10   | 10   | 7          | 10   | 10   |
| Y+R:  | 4.0         | 4.0  | 4.0  | 4.0         | 4.0  | 4.0  | 4.0        | 4.0  | 4.0  | 4.0        | 4.0  | 4.0  |
| Volume Module: >> Count Date: 9 Oct 2014 << |             |      |      |             |      |      |            |      |      |            |      |      |
| Base Vol:                                   | 23          | 44   | 139  | 276         | 83   | 100  | 75         | 859  | 40   | 143        | 513  | 131  |
| Growth Adj:                                 | 1.00        | 1.00 | 1.00 | 1.00        | 1.00 | 1.00 | 1.00       | 1.00 | 1.00 | 1.00       | 1.00 | 1.00 |
| Initial Bse:                                | 23          | 44   | 139  | 276         | 83   | 100  | 75         | 859  | 40   | 143        | 513  | 131  |
| Added Vol:                                  | 0           | 0    | 0    | 0           | 0    | 0    | 0          | 0    | 0    | 0          | 0    | 0    |
| PasserByVol:                                | 0           | 0    | 0    | 0           | 0    | 0    | 0          | 0    | 0    | 0          | 0    | 0    |
| Initial Fut:                                | 23          | 44   | 139  | 276         | 83   | 100  | 75         | 859  | 40   | 143        | 513  | 131  |
| User Adj:                                   | 1.00        | 1.00 | 1.00 | 1.00        | 1.00 | 1.00 | 1.00       | 1.00 | 1.00 | 1.00       | 1.00 | 1.00 |
| PHF Adj:                                    | 1.00        | 1.00 | 1.00 | 1.00        | 1.00 | 1.00 | 1.00       | 1.00 | 1.00 | 1.00       | 1.00 | 1.00 |
| PHF Volume:                                 | 23          | 44   | 139  | 276         | 83   | 100  | 75         | 859  | 40   | 143        | 513  | 131  |
| Reduct Vol:                                 | 0           | 0    | 0    | 0           | 0    | 0    | 0          | 0    | 0    | 0          | 0    | 0    |
| Reduced Vol:                                | 23          | 44   | 139  | 276         | 83   | 100  | 75         | 859  | 40   | 143        | 513  | 131  |
| PCE Adj:                                    | 1.00        | 1.00 | 1.00 | 1.00        | 1.00 | 1.00 | 1.00       | 1.00 | 1.00 | 1.00       | 1.00 | 1.00 |
| MLF Adj:                                    | 1.00        | 1.00 | 1.00 | 1.00        | 1.00 | 1.00 | 1.00       | 1.00 | 1.00 | 1.00       | 1.00 | 1.00 |
| Final Volume:                               | 23          | 44   | 139  | 276         | 83   | 100  | 75         | 859  | 40   | 143        | 513  | 131  |
| Saturation Flow Module:                     |             |      |      |             |      |      |            |      |      |            |      |      |
| Sat/Lane:                                   | 1900        | 1900 | 1900 | 1900        | 1900 | 1900 | 1900       | 1900 | 1900 | 1900       | 1900 | 1900 |
| Adjustment:                                 | 0.92        | 0.92 | 0.92 | 0.95        | 0.95 | 0.92 | 0.92       | 1.00 | 0.92 | 0.92       | 1.00 | 0.92 |
| Lanes:                                      | 0.11        | 0.21 | 0.68 | 0.77        | 0.23 | 1.00 | 1.00       | 2.00 | 1.00 | 1.00       | 2.00 | 1.00 |
| Final Sat.:                                 | 195         | 374  | 1181 | 1384        | 416  | 1750 | 1750       | 3800 | 1750 | 1750       | 3800 | 1750 |
| Capacity Analysis Module:                   |             |      |      |             |      |      |            |      |      |            |      |      |
| Vol/Sat:                                    | 0.12        | 0.12 | 0.12 | 0.20        | 0.20 | 0.06 | 0.04       | 0.23 | 0.02 | 0.08       | 0.14 | 0.07 |
| Crit Moves:                                 | *****       |      |      |             |      |      |            |      |      |            |      |      |
| Green Time:                                 | 27.9        | 27.9 | 27.9 | 27.9        | 27.9 | 27.9 | 16.9       | 31.6 | 31.6 | 11.4       | 26.1 | 26.1 |
| Volume/Cap:                                 | 0.34        | 0.34 | 0.34 | 0.57        | 0.57 | 0.16 | 0.20       | 0.57 | 0.06 | 0.57       | 0.41 | 0.23 |
| Delay/Veh:                                  | 19.5        | 19.5 | 19.5 | 22.4        | 22.4 | 18.1 | 26.2       | 19.4 | 15.0 | 35.2       | 21.2 | 19.8 |
| User DelAdj:                                | 1.00        | 1.00 | 1.00 | 1.00        | 1.00 | 1.00 | 1.00       | 1.00 | 1.00 | 1.00       | 1.00 | 1.00 |
| AdjDel/Veh:                                 | 19.5        | 19.5 | 19.5 | 22.4        | 22.4 | 18.1 | 26.2       | 19.4 | 15.0 | 35.2       | 21.2 | 19.8 |
| LOS by Move:                                | B           | B    | B    | C           | C    | B    | C          | B    | B    | D          | C    | B    |
| HCM2k95thQ:                                 | 8           | 8    | 8    | 14          | 14   | 4    | 3          | 15   | 1    | 7          | 9    | 5    |

Note: Queue reported is the number of cars per lane.

BART

Level Of Service Computation Report  
 2000 HCM Operations (Future Volume Alternative)  
 AM - Exist + Proj Conditions

Intersection #3789: SANTA CLARA/21ST [Study Int 10]

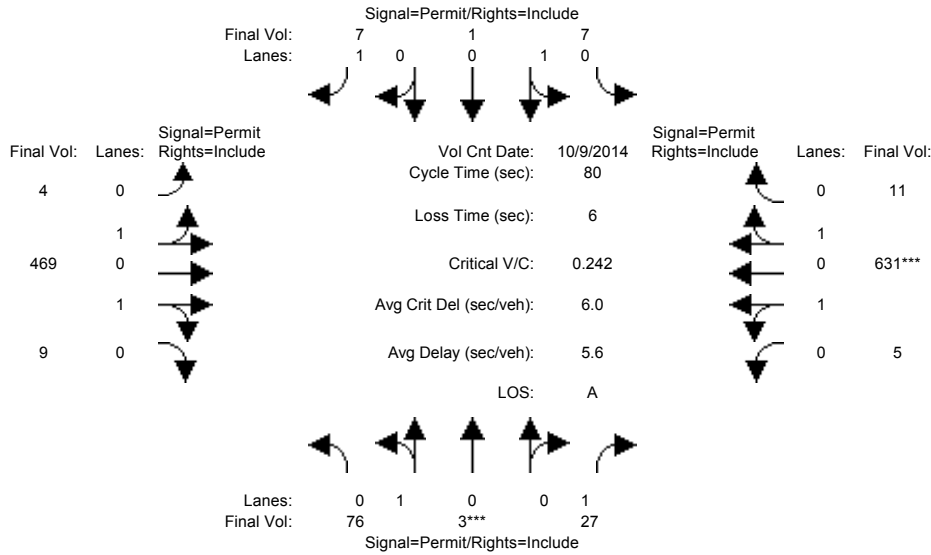

| Approach:                 | North Bound                  |      |      | South Bound |      |      | East Bound |      |      | West Bound |      |      |
|---------------------------|------------------------------|------|------|-------------|------|------|------------|------|------|------------|------|------|
| Movement:                 | L                            | T    | R    | L           | T    | R    | L          | T    | R    | L          | T    | R    |
| Min. Green:               | 10                           | 10   | 10   | 10          | 10   | 10   | 10         | 10   | 10   | 10         | 10   | 10   |
| Y+R:                      | 4.0                          | 4.0  | 4.0  | 4.0         | 4.0  | 4.0  | 4.0        | 4.0  | 4.0  | 4.0        | 4.0  | 4.0  |
| -----                     |                              |      |      |             |      |      |            |      |      |            |      |      |
| Volume Module:            | >> Count Date: 9 Oct 2014 << |      |      |             |      |      |            |      |      |            |      |      |
| Base Vol:                 | 76                           | 3    | 27   | 7           | 1    | 7    | 4          | 469  | 9    | 5          | 631  | 11   |
| Growth Adj:               | 1.00                         | 1.00 | 1.00 | 1.00        | 1.00 | 1.00 | 1.00       | 1.00 | 1.00 | 1.00       | 1.00 | 1.00 |
| Initial Bse:              | 76                           | 3    | 27   | 7           | 1    | 7    | 4          | 469  | 9    | 5          | 631  | 11   |
| Added Vol:                | 0                            | 0    | 0    | 0           | 0    | 0    | 0          | 0    | 0    | 0          | 0    | 0    |
| PasserByVol:              | 0                            | 0    | 0    | 0           | 0    | 0    | 0          | 0    | 0    | 0          | 0    | 0    |
| Initial Fut:              | 76                           | 3    | 27   | 7           | 1    | 7    | 4          | 469  | 9    | 5          | 631  | 11   |
| User Adj:                 | 1.00                         | 1.00 | 1.00 | 1.00        | 1.00 | 1.00 | 1.00       | 1.00 | 1.00 | 1.00       | 1.00 | 1.00 |
| PHF Adj:                  | 1.00                         | 1.00 | 1.00 | 1.00        | 1.00 | 1.00 | 1.00       | 1.00 | 1.00 | 1.00       | 1.00 | 1.00 |
| PHF Volume:               | 76                           | 3    | 27   | 7           | 1    | 7    | 4          | 469  | 9    | 5          | 631  | 11   |
| Reduct Vol:               | 0                            | 0    | 0    | 0           | 0    | 0    | 0          | 0    | 0    | 0          | 0    | 0    |
| Reduced Vol:              | 76                           | 3    | 27   | 7           | 1    | 7    | 4          | 469  | 9    | 5          | 631  | 11   |
| PCE Adj:                  | 1.00                         | 1.00 | 1.00 | 1.00        | 1.00 | 1.00 | 1.00       | 1.00 | 1.00 | 1.00       | 1.00 | 1.00 |
| MLF Adj:                  | 1.00                         | 1.00 | 1.00 | 1.00        | 1.00 | 1.00 | 1.00       | 1.00 | 1.00 | 1.00       | 1.00 | 1.00 |
| Final Volume:             | 76                           | 3    | 27   | 7           | 1    | 7    | 4          | 469  | 9    | 5          | 631  | 11   |
| -----                     |                              |      |      |             |      |      |            |      |      |            |      |      |
| Saturation Flow Module:   |                              |      |      |             |      |      |            |      |      |            |      |      |
| Sat/Lane:                 | 1900                         | 1900 | 1900 | 1900        | 1900 | 1900 | 1900       | 1900 | 1900 | 1900       | 1900 | 1900 |
| Adjustment:               | 0.95                         | 0.95 | 0.92 | 0.95        | 0.95 | 0.92 | 0.95       | 0.95 | 0.95 | 0.95       | 0.95 | 0.95 |
| Lanes:                    | 0.96                         | 0.04 | 1.00 | 0.87        | 0.13 | 1.00 | 0.02       | 1.94 | 0.04 | 0.02       | 1.95 | 0.03 |
| Final Sat.:               | 1732                         | 68   | 1750 | 1575        | 225  | 1750 | 30         | 3503 | 67   | 28         | 3511 | 61   |
| -----                     |                              |      |      |             |      |      |            |      |      |            |      |      |
| Capacity Analysis Module: |                              |      |      |             |      |      |            |      |      |            |      |      |
| Vol/Sat:                  | 0.04                         | 0.04 | 0.02 | 0.00        | 0.00 | 0.00 | 0.13       | 0.13 | 0.13 | 0.18       | 0.18 | 0.18 |
| Crit Moves:               | *****                        |      |      |             |      |      |            |      |      |            |      |      |
| Green Time:               | 14.5                         | 14.5 | 14.5 | 14.5        | 14.5 | 14.5 | 59.5       | 59.5 | 59.5 | 59.5       | 59.5 | 59.5 |
| Volume/Cap:               | 0.24                         | 0.24 | 0.08 | 0.02        | 0.02 | 0.02 | 0.18       | 0.18 | 0.18 | 0.24       | 0.24 | 0.24 |
| Delay/Veh:                | 28.4                         | 28.4 | 27.3 | 26.9        | 26.9 | 26.9 | 3.1        | 3.1  | 3.1  | 3.3        | 3.3  | 3.3  |
| User DelAdj:              | 1.00                         | 1.00 | 1.00 | 1.00        | 1.00 | 1.00 | 1.00       | 1.00 | 1.00 | 1.00       | 1.00 | 1.00 |
| AdjDel/Veh:               | 28.4                         | 28.4 | 27.3 | 26.9        | 26.9 | 26.9 | 3.1        | 3.1  | 3.1  | 3.3        | 3.3  | 3.3  |
| LOS by Move:              | C                            | C    | C    | C           | C    | C    | A          | A    | A    | A          | A    | A    |
| HCM2k95thQ:               | 4                            | 4    | 1    | 0           | 0    | 0    | 4          | 4    | 4    | 5          | 5    | 5    |

Note: Queue reported is the number of cars per lane.

BART

Level Of Service Computation Report  
 2000 HCM Operations (Future Volume Alternative)  
 PM - Exist + Proj Conditions

Intersection #3789: SANTA CLARA/21ST [Study Int 10]

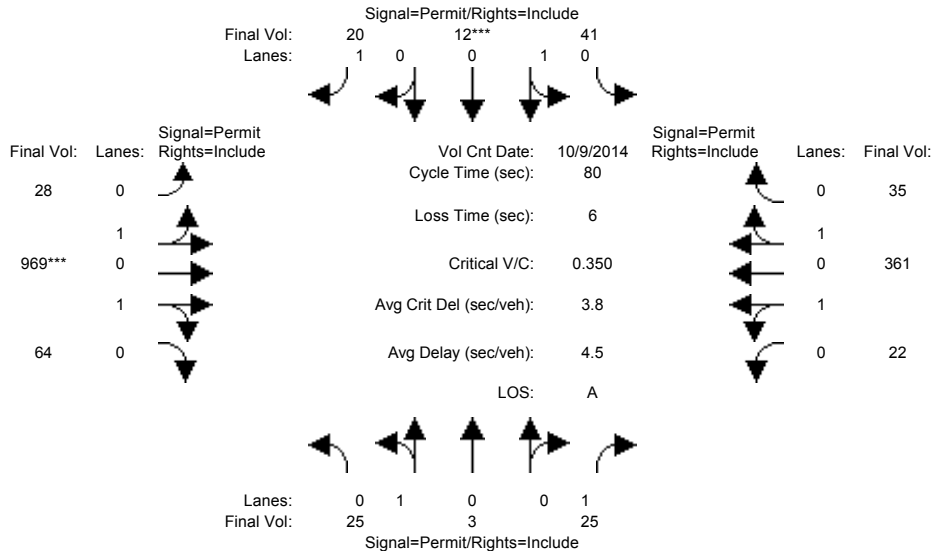

| Approach:                                   | North Bound |      |      | South Bound |      |      | East Bound |      |      | West Bound |      |      |  |
|---|-------------|------|------|-------------|------|------|------------|------|------|------------|------|------|--|
| Movement:                                   | L           | T    | R    | L           | T    | R    | L          | T    | R    | L          | T    | R    |  |
| Min. Green:                                 | 10          | 10   | 10   | 10          | 10   | 10   | 10         | 10   | 10   | 10         | 10   | 10   |  |
| Y+R:  | 4.0         | 4.0  | 4.0  | 4.0         | 4.0  | 4.0  | 4.0        | 4.0  | 4.0  | 4.0        | 4.0  | 4.0  |  |
| Volume Module: >> Count Date: 9 Oct 2014 << |             |      |      |             |      |      |            |      |      |            |      |      |  |
| Base Vol:                                   | 25          | 3    | 25   | 41          | 12   | 20   | 28         | 969  | 64   | 22         | 361  | 35   |  |
| Growth Adj:                                 | 1.00        | 1.00 | 1.00 | 1.00        | 1.00 | 1.00 | 1.00       | 1.00 | 1.00 | 1.00       | 1.00 | 1.00 |  |
| Initial Bse:                                | 25          | 3    | 25   | 41          | 12   | 20   | 28         | 969  | 64   | 22         | 361  | 35   |  |
| Added Vol:                                  | 0           | 0    | 0    | 0           | 0    | 0    | 0          | 0    | 0    | 0          | 0    | 0    |  |
| PasserByVol:                                | 0           | 0    | 0    | 0           | 0    | 0    | 0          | 0    | 0    | 0          | 0    | 0    |  |
| Initial Fut:                                | 25          | 3    | 25   | 41          | 12   | 20   | 28         | 969  | 64   | 22         | 361  | 35   |  |
| User Adj:                                   | 1.00        | 1.00 | 1.00 | 1.00        | 1.00 | 1.00 | 1.00       | 1.00 | 1.00 | 1.00       | 1.00 | 1.00 |  |
| PHF Adj:                                    | 1.00        | 1.00 | 1.00 | 1.00        | 1.00 | 1.00 | 1.00       | 1.00 | 1.00 | 1.00       | 1.00 | 1.00 |  |
| PHF Volume:                                 | 25          | 3    | 25   | 41          | 12   | 20   | 28         | 969  | 64   | 22         | 361  | 35   |  |
| Reduct Vol:                                 | 0           | 0    | 0    | 0           | 0    | 0    | 0          | 0    | 0    | 0          | 0    | 0    |  |
| Reduced Vol:                                | 25          | 3    | 25   | 41          | 12   | 20   | 28         | 969  | 64   | 22         | 361  | 35   |  |
| PCE Adj:                                    | 1.00        | 1.00 | 1.00 | 1.00        | 1.00 | 1.00 | 1.00       | 1.00 | 1.00 | 1.00       | 1.00 | 1.00 |  |
| MLF Adj:                                    | 1.00        | 1.00 | 1.00 | 1.00        | 1.00 | 1.00 | 1.00       | 1.00 | 1.00 | 1.00       | 1.00 | 1.00 |  |
| Final Volume:                               | 25          | 3    | 25   | 41          | 12   | 20   | 28         | 969  | 64   | 22         | 361  | 35   |  |
| Saturation Flow Module:                     |             |      |      |             |      |      |            |      |      |            |      |      |  |
| Sat/Lane:                                   | 1900        | 1900 | 1900 | 1900        | 1900 | 1900 | 1900       | 1900 | 1900 | 1900       | 1900 | 1900 |  |
| Adjustment:                                 | 0.95        | 0.95 | 0.92 | 0.95        | 0.95 | 0.92 | 0.95       | 0.95 | 0.95 | 0.95       | 0.95 | 0.95 |  |
| Lanes:                                      | 0.89        | 0.11 | 1.00 | 0.77        | 0.23 | 1.00 | 0.05       | 1.83 | 0.12 | 0.10       | 1.73 | 0.17 |  |
| Final Sat.:                                 | 1607        | 193  | 1750 | 1392        | 408  | 1750 | 95         | 3288 | 217  | 189        | 3109 | 301  |  |
| Capacity Analysis Module:                   |             |      |      |             |      |      |            |      |      |            |      |      |  |
| Vol/Sat:                                    | 0.02        | 0.02 | 0.01 | 0.03        | 0.03 | 0.01 | 0.29       | 0.29 | 0.29 | 0.12       | 0.12 | 0.12 |  |
| Crit Moves:                                 |             |      |      | ****        |      |      |            | **** |      |            |      |      |  |
| Green Time:                                 | 10.0        | 10.0 | 10.0 | 10.0        | 10.0 | 10.0 | 64.0       | 64.0 | 64.0 | 64.0       | 64.0 | 64.0 |  |
| Volume/Cap:                                 | 0.12        | 0.12 | 0.11 | 0.24        | 0.24 | 0.09 | 0.37       | 0.37 | 0.37 | 0.15       | 0.15 | 0.15 |  |
| Delay/Veh:                                  | 31.4        | 31.4 | 31.3 | 32.1        | 32.1 | 31.2 | 2.3        | 2.3  | 2.3  | 1.8        | 1.8  | 1.8  |  |
| User DelAdj:                                | 1.00        | 1.00 | 1.00 | 1.00        | 1.00 | 1.00 | 1.00       | 1.00 | 1.00 | 1.00       | 1.00 | 1.00 |  |
| AdjDel/Veh:                                 | 31.4        | 31.4 | 31.3 | 32.1        | 32.1 | 31.2 | 2.3        | 2.3  | 2.3  | 1.8        | 1.8  | 1.8  |  |
| LOS by Move:                                | C           | C    | C    | C           | C    | C    | A          | A    | A    | A          | A    | A    |  |
| HCM2k95thQ:                                 | 2           | 2    | 1    | 3           | 3    | 1    | 8          | 8    | 8    | 3          | 3    | 3    |  |

Note: Queue reported is the number of cars per lane.

BART

Level Of Service Computation Report  
 2000 HCM Operations (Future Volume Alternative)  
 AM - Exist + Proj Conditions

Intersection #3790: SANTA CLARA/24TH [Study Int 11]

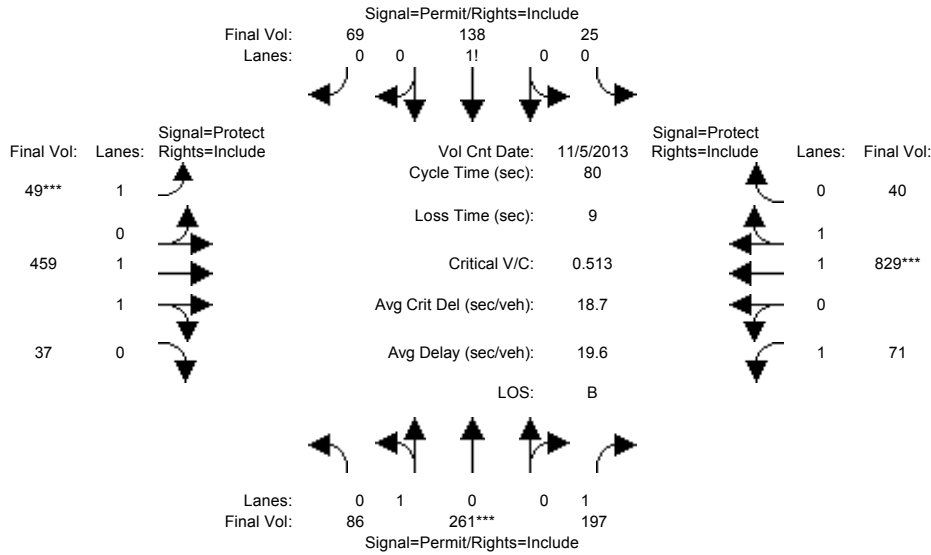

| Approach:                                   | North Bound |      |      | South Bound |      |      | East Bound |      |      | West Bound |      |      |
|---|-------------|------|------|-------------|------|------|------------|------|------|------------|------|------|
| Movement:                                   | L           | T    | R    | L           | T    | R    | L          | T    | R    | L          | T    | R    |
| Min. Green:                                 | 10          | 10   | 10   | 10          | 10   | 10   | 7          | 10   | 10   | 7          | 10   | 10   |
| Y+R:  | 4.0         | 4.0  | 4.0  | 4.0         | 4.0  | 4.0  | 4.0        | 4.0  | 4.0  | 4.0        | 4.0  | 4.0  |
| Volume Module: >> Count Date: 5 Nov 2013 << |             |      |      |             |      |      |            |      |      |            |      |      |
| Base Vol:                                   | 86          | 261  | 197  | 25          | 138  | 69   | 49         | 459  | 37   | 71         | 829  | 40   |
| Growth Adj:                                 | 1.00        | 1.00 | 1.00 | 1.00        | 1.00 | 1.00 | 1.00       | 1.00 | 1.00 | 1.00       | 1.00 | 1.00 |
| Initial Bse:                                | 86          | 261  | 197  | 25          | 138  | 69   | 49         | 459  | 37   | 71         | 829  | 40   |
| Added Vol:                                  | 0           | 0    | 0    | 0           | 0    | 0    | 0          | 0    | 0    | 0          | 0    | 0    |
| PasserByVol:                                | 0           | 0    | 0    | 0           | 0    | 0    | 0          | 0    | 0    | 0          | 0    | 0    |
| Initial Fut:                                | 86          | 261  | 197  | 25          | 138  | 69   | 49         | 459  | 37   | 71         | 829  | 40   |
| User Adj:                                   | 1.00        | 1.00 | 1.00 | 1.00        | 1.00 | 1.00 | 1.00       | 1.00 | 1.00 | 1.00       | 1.00 | 1.00 |
| PHF Adj:                                    | 1.00        | 1.00 | 1.00 | 1.00        | 1.00 | 1.00 | 1.00       | 1.00 | 1.00 | 1.00       | 1.00 | 1.00 |
| PHF Volume:                                 | 86          | 261  | 197  | 25          | 138  | 69   | 49         | 459  | 37   | 71         | 829  | 40   |
| Reduct Vol:                                 | 0           | 0    | 0    | 0           | 0    | 0    | 0          | 0    | 0    | 0          | 0    | 0    |
| Reduced Vol:                                | 86          | 261  | 197  | 25          | 138  | 69   | 49         | 459  | 37   | 71         | 829  | 40   |
| PCE Adj:                                    | 1.00        | 1.00 | 1.00 | 1.00        | 1.00 | 1.00 | 1.00       | 1.00 | 1.00 | 1.00       | 1.00 | 1.00 |
| MLF Adj:                                    | 1.00        | 1.00 | 1.00 | 1.00        | 1.00 | 1.00 | 1.00       | 1.00 | 1.00 | 1.00       | 1.00 | 1.00 |
| Final Volume:                               | 86          | 261  | 197  | 25          | 138  | 69   | 49         | 459  | 37   | 71         | 829  | 40   |
| Saturation Flow Module:                     |             |      |      |             |      |      |            |      |      |            |      |      |
| Sat/Lane:                                   | 1900        | 1900 | 1900 | 1900        | 1900 | 1900 | 1900       | 1900 | 1900 | 1900       | 1900 | 1900 |
| Adjustment:                                 | 0.95        | 0.95 | 0.92 | 0.92        | 0.92 | 0.92 | 0.92       | 0.98 | 0.95 | 0.92       | 0.97 | 0.95 |
| Lanes:                                      | 0.25        | 0.75 | 1.00 | 0.11        | 0.59 | 0.30 | 1.00       | 1.85 | 0.15 | 1.00       | 1.91 | 0.09 |
| Final Sat.:                                 | 446         | 1354 | 1750 | 189         | 1041 | 520  | 1750       | 3424 | 276  | 1750       | 3530 | 170  |
| Capacity Analysis Module:                   |             |      |      |             |      |      |            |      |      |            |      |      |
| Vol/Sat:                                    | 0.19        | 0.19 | 0.11 | 0.13        | 0.13 | 0.13 | 0.03       | 0.13 | 0.13 | 0.04       | 0.23 | 0.23 |
| Crit Moves:                                 | ****        |      |      | ****        |      |      | ****       |      |      | ****       |      |      |
| Green Time:                                 | 28.9        | 28.9 | 28.9 | 28.9        | 28.9 | 28.9 | 7.0        | 25.5 | 25.5 | 16.6       | 35.1 | 35.1 |
| Volume/Cap:                                 | 0.53        | 0.53 | 0.31 | 0.37        | 0.37 | 0.37 | 0.32       | 0.42 | 0.42 | 0.19       | 0.53 | 0.53 |
| Delay/Veh:                                  | 21.1        | 21.1 | 18.7 | 19.2        | 19.2 | 19.2 | 35.5       | 21.7 | 21.7 | 26.4       | 16.8 | 16.8 |
| User DelAdj:                                | 1.00        | 1.00 | 1.00 | 1.00        | 1.00 | 1.00 | 1.00       | 1.00 | 1.00 | 1.00       | 1.00 | 1.00 |
| AdjDel/Veh:                                 | 21.1        | 21.1 | 18.7 | 19.2        | 19.2 | 19.2 | 35.5       | 21.7 | 21.7 | 26.4       | 16.8 | 16.8 |
| LOS by Move:                                | C           | C    | B    | B           | B    | B    | D          | C    | C    | C          | B    | B    |
| HCM2k95thQ:                                 | 13          | 13   | 7    | 9           | 9    | 9    | 2          | 9    | 9    | 3          | 15   | 15   |

Note: Queue reported is the number of cars per lane.



BART

Level Of Service Computation Report  
 2000 HCM Operations (Future Volume Alternative)  
 PM - Exist + Proj Conditions

Intersection #3790: SANTA CLARA/24TH [Study Int 11]

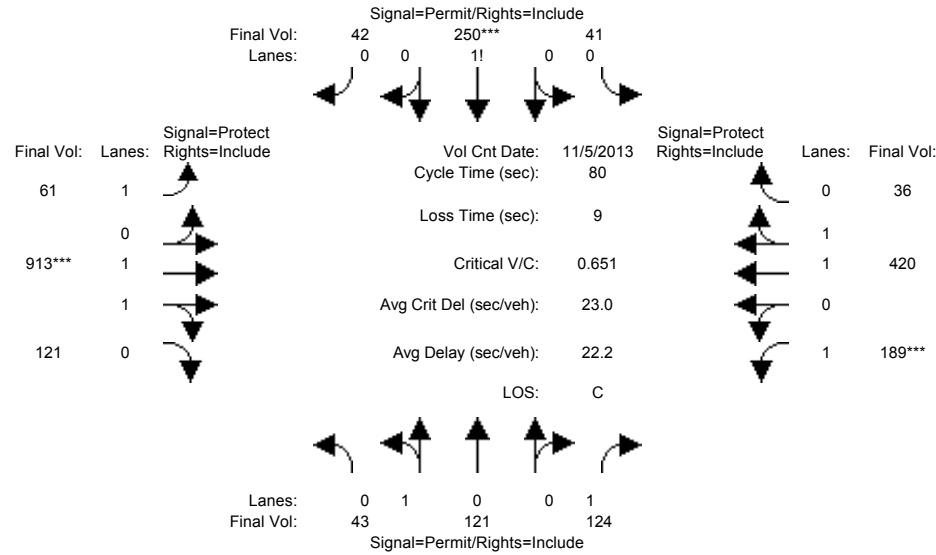

| Approach:                                   | North Bound |      |      | South Bound |      |      | East Bound |      |      | West Bound |      |      |
|---|-------------|------|------|-------------|------|------|------------|------|------|------------|------|------|
| Movement:                                   | L           | T    | R    | L           | T    | R    | L          | T    | R    | L          | T    | R    |
| Min. Green:                                 | 10          | 10   | 10   | 10          | 10   | 10   | 7          | 10   | 10   | 7          | 10   | 10   |
| Y+R:  | 4.0         | 4.0  | 4.0  | 4.0         | 4.0  | 4.0  | 4.0        | 4.0  | 4.0  | 4.0        | 4.0  | 4.0  |
| Volume Module: >> Count Date: 5 Nov 2013 << |             |      |      |             |      |      |            |      |      |            |      |      |
| Base Vol:                                   | 43          | 121  | 124  | 41          | 250  | 42   | 61         | 913  | 121  | 189        | 420  | 36   |
| Growth Adj:                                 | 1.00        | 1.00 | 1.00 | 1.00        | 1.00 | 1.00 | 1.00       | 1.00 | 1.00 | 1.00       | 1.00 | 1.00 |
| Initial Bse:                                | 43          | 121  | 124  | 41          | 250  | 42   | 61         | 913  | 121  | 189        | 420  | 36   |
| Added Vol:                                  | 0           | 0    | 0    | 0           | 0    | 0    | 0          | 0    | 0    | 0          | 0    | 0    |
| PasserByVol:                                | 0           | 0    | 0    | 0           | 0    | 0    | 0          | 0    | 0    | 0          | 0    | 0    |
| Initial Fut:                                | 43          | 121  | 124  | 41          | 250  | 42   | 61         | 913  | 121  | 189        | 420  | 36   |
| User Adj:                                   | 1.00        | 1.00 | 1.00 | 1.00        | 1.00 | 1.00 | 1.00       | 1.00 | 1.00 | 1.00       | 1.00 | 1.00 |
| PHF Adj:                                    | 1.00        | 1.00 | 1.00 | 1.00        | 1.00 | 1.00 | 1.00       | 1.00 | 1.00 | 1.00       | 1.00 | 1.00 |
| PHF Volume:                                 | 43          | 121  | 124  | 41          | 250  | 42   | 61         | 913  | 121  | 189        | 420  | 36   |
| Reduct Vol:                                 | 0           | 0    | 0    | 0           | 0    | 0    | 0          | 0    | 0    | 0          | 0    | 0    |
| Reduced Vol:                                | 43          | 121  | 124  | 41          | 250  | 42   | 61         | 913  | 121  | 189        | 420  | 36   |
| PCE Adj:                                    | 1.00        | 1.00 | 1.00 | 1.00        | 1.00 | 1.00 | 1.00       | 1.00 | 1.00 | 1.00       | 1.00 | 1.00 |
| MLF Adj:                                    | 1.00        | 1.00 | 1.00 | 1.00        | 1.00 | 1.00 | 1.00       | 1.00 | 1.00 | 1.00       | 1.00 | 1.00 |
| Final Volume:                               | 43          | 121  | 124  | 41          | 250  | 42   | 61         | 913  | 121  | 189        | 420  | 36   |
| Saturation Flow Module:                     |             |      |      |             |      |      |            |      |      |            |      |      |
| Sat/Lane:                                   | 1900        | 1900 | 1900 | 1900        | 1900 | 1900 | 1900       | 1900 | 1900 | 1900       | 1900 | 1900 |
| Adjustment:                                 | 0.95        | 0.95 | 0.92 | 0.92        | 0.92 | 0.92 | 0.92       | 0.98 | 0.95 | 0.92       | 0.98 | 0.95 |
| Lanes:                                      | 0.26        | 0.74 | 1.00 | 0.12        | 0.75 | 0.13 | 1.00       | 1.76 | 0.24 | 1.00       | 1.84 | 0.16 |
| Final Sat.:                                 | 472         | 1328 | 1750 | 215         | 1314 | 221  | 1750       | 3267 | 433  | 1750       | 3408 | 292  |
| Capacity Analysis Module:                   |             |      |      |             |      |      |            |      |      |            |      |      |
| Vol/Sat:                                    | 0.09        | 0.09 | 0.07 | 0.19        | 0.19 | 0.19 | 0.03       | 0.28 | 0.28 | 0.11       | 0.12 | 0.12 |
| Crit Moves:                                 |             |      |      | ****        |      |      |            | **** |      |            |      |      |
| Green Time:                                 | 23.4        | 23.4 | 23.4 | 23.4        | 23.4 | 23.4 | 19.6       | 34.3 | 34.3 | 13.3       | 28.0 | 28.0 |
| Volume/Cap:                                 | 0.31        | 0.31 | 0.24 | 0.65        | 0.65 | 0.65 | 0.14       | 0.65 | 0.65 | 0.65       | 0.35 | 0.35 |
| Delay/Veh:                                  | 22.4        | 22.4 | 21.8 | 27.7        | 27.7 | 27.7 | 23.8       | 19.1 | 19.1 | 36.4       | 19.4 | 19.4 |
| User DelAdj:                                | 1.00        | 1.00 | 1.00 | 1.00        | 1.00 | 1.00 | 1.00       | 1.00 | 1.00 | 1.00       | 1.00 | 1.00 |
| AdjDel/Veh:                                 | 22.4        | 22.4 | 21.8 | 27.7        | 27.7 | 27.7 | 23.8       | 19.1 | 19.1 | 36.4       | 19.4 | 19.4 |
| LOS by Move:                                | C           | C    | C    | C           | C    | C    | C          | B    | B    | D          | B    | B    |
| HCM2k95thQ:                                 | 6           | 6    | 5    | 16          | 16   | 16   | 3          | 19   | 19   | 9          | 8    | 8    |

Note: Queue reported is the number of cars per lane.

BART

Level Of Service Computation Report  
 2000 HCM Operations (Future Volume Alternative)  
 AM - Exist + Proj Conditions

Intersection #3832: 24TH/WILLIAM [Study Int 24]

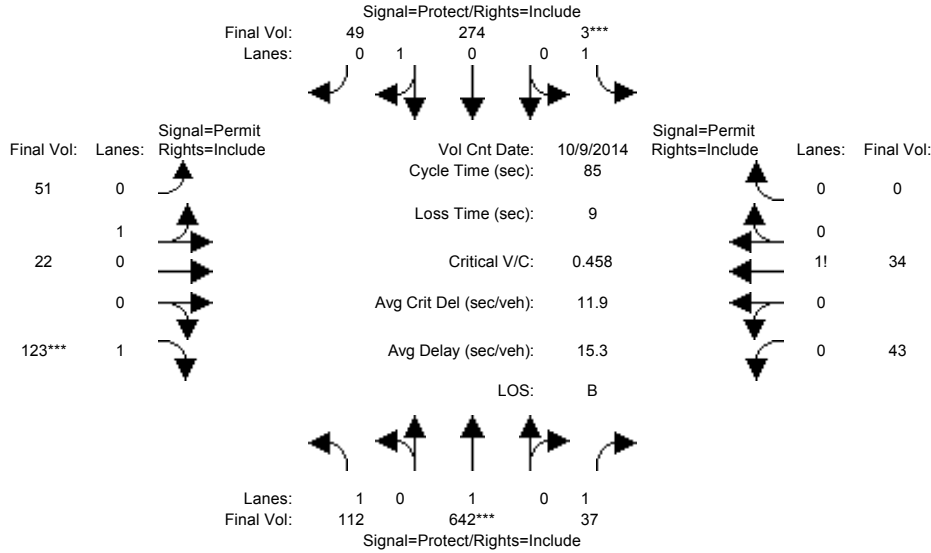

| Approach:                                   | North Bound |      |      | South Bound |      |      | East Bound |      |      | West Bound |      |      |
|---|-------------|------|------|-------------|------|------|------------|------|------|------------|------|------|
| Movement:                                   | L           | T    | R    | L           | T    | R    | L          | T    | R    | L          | T    | R    |
| Min. Green:                                 | 7           | 10   | 10   | 7           | 10   | 10   | 10         | 10   | 10   | 10         | 10   | 10   |
| Y+R:  | 4.0         | 4.0  | 4.0  | 4.0         | 4.0  | 4.0  | 4.0        | 4.0  | 4.0  | 4.0        | 4.0  | 4.0  |
| Volume Module: >> Count Date: 9 Oct 2014 << |             |      |      |             |      |      |            |      |      |            |      |      |
| Base Vol:                                   | 112         | 642  | 37   | 3           | 274  | 49   | 51         | 22   | 123  | 43         | 34   | 0    |
| Growth Adj:                                 | 1.00        | 1.00 | 1.00 | 1.00        | 1.00 | 1.00 | 1.00       | 1.00 | 1.00 | 1.00       | 1.00 | 1.00 |
| Initial Bse:                                | 112         | 642  | 37   | 3           | 274  | 49   | 51         | 22   | 123  | 43         | 34   | 0    |
| Added Vol:                                  | 0           | 0    | 0    | 0           | 0    | 0    | 0          | 0    | 0    | 0          | 0    | 0    |
| PasserByVol:                                | 0           | 0    | 0    | 0           | 0    | 0    | 0          | 0    | 0    | 0          | 0    | 0    |
| Initial Fut:                                | 112         | 642  | 37   | 3           | 274  | 49   | 51         | 22   | 123  | 43         | 34   | 0    |
| User Adj:                                   | 1.00        | 1.00 | 1.00 | 1.00        | 1.00 | 1.00 | 1.00       | 1.00 | 1.00 | 1.00       | 1.00 | 1.00 |
| PHF Adj:                                    | 1.00        | 1.00 | 1.00 | 1.00        | 1.00 | 1.00 | 1.00       | 1.00 | 1.00 | 1.00       | 1.00 | 1.00 |
| PHF Volume:                                 | 112         | 642  | 37   | 3           | 274  | 49   | 51         | 22   | 123  | 43         | 34   | 0    |
| Reduct Vol:                                 | 0           | 0    | 0    | 0           | 0    | 0    | 0          | 0    | 0    | 0          | 0    | 0    |
| Reduced Vol:                                | 112         | 642  | 37   | 3           | 274  | 49   | 51         | 22   | 123  | 43         | 34   | 0    |
| PCE Adj:                                    | 1.00        | 1.00 | 1.00 | 1.00        | 1.00 | 1.00 | 1.00       | 1.00 | 1.00 | 1.00       | 1.00 | 1.00 |
| MLF Adj:                                    | 1.00        | 1.00 | 1.00 | 1.00        | 1.00 | 1.00 | 1.00       | 1.00 | 1.00 | 1.00       | 1.00 | 1.00 |
| Final Volume:                               | 112         | 642  | 37   | 3           | 274  | 49   | 51         | 22   | 123  | 43         | 34   | 0    |
| Saturation Flow Module:                     |             |      |      |             |      |      |            |      |      |            |      |      |
| Sat/Lane:                                   | 1900        | 1900 | 1900 | 1900        | 1900 | 1900 | 1900       | 1900 | 1900 | 1900       | 1900 | 1900 |
| Adjustment:                                 | 0.92        | 1.00 | 0.92 | 0.92        | 0.95 | 0.95 | 0.95       | 0.95 | 0.92 | 0.95       | 0.95 | 0.92 |
| Lanes:                                      | 1.00        | 1.00 | 1.00 | 1.00        | 0.85 | 0.15 | 0.70       | 0.30 | 1.00 | 0.56       | 0.44 | 0.00 |
| Final Sat.:                                 | 1750        | 1900 | 1750 | 1750        | 1527 | 273  | 1258       | 542  | 1750 | 1005       | 795  | 0    |
| Capacity Analysis Module:                   |             |      |      |             |      |      |            |      |      |            |      |      |
| Vol/Sat:                                    | 0.06        | 0.34 | 0.02 | 0.00        | 0.18 | 0.18 | 0.04       | 0.04 | 0.07 | 0.04       | 0.04 | 0.00 |
| Crit Moves:                                 | ****        | **** | **** | ****        | **** | **** | ****       | **** | **** | ****       | **** | **** |
| Green Time:                                 | 20.2        | 57.1 | 57.1 | 7.0         | 43.9 | 43.9 | 11.9       | 11.9 | 11.9 | 11.9       | 11.9 | 0.0  |
| Volume/Cap:                                 | 0.27        | 0.50 | 0.03 | 0.02        | 0.35 | 0.35 | 0.29       | 0.29 | 0.50 | 0.31       | 0.31 | 0.00 |
| Delay/Veh:                                  | 26.8        | 7.2  | 4.7  | 35.9        | 12.3 | 12.3 | 33.4       | 33.4 | 35.5 | 33.5       | 33.5 | 0.0  |
| User DelAdj:                                | 1.00        | 1.00 | 1.00 | 1.00        | 1.00 | 1.00 | 1.00       | 1.00 | 1.00 | 1.00       | 1.00 | 1.00 |
| AdjDel/Veh:                                 | 26.8        | 7.2  | 4.7  | 35.9        | 12.3 | 12.3 | 33.4       | 33.4 | 35.5 | 33.5       | 33.5 | 0.0  |
| LOS by Move:                                | C           | A    | A    | D           | B    | B    | C          | C    | D    | C          | C    | A    |
| HCM2k95thQ:                                 | 5           | 16   | 1    | 0           | 10   | 10   | 4          | 4    | 8    | 4          | 4    | 0    |

Note: Queue reported is the number of cars per lane.

BART

Level Of Service Computation Report  
 2000 HCM Operations (Future Volume Alternative)  
 PM - Exist + Proj Conditions

Intersection #3832: 24TH/WILLIAM [Study Int 24]

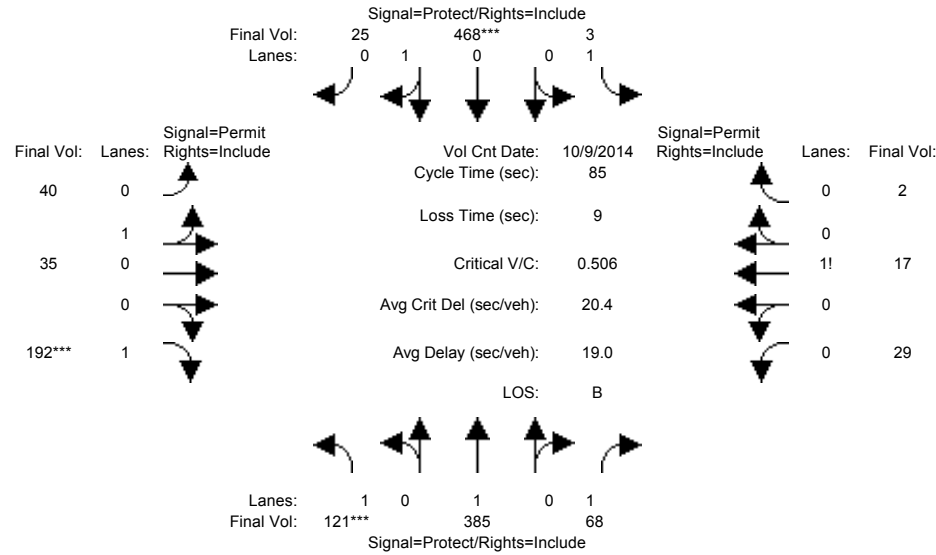

| Approach:                                   | North Bound |      |      | South Bound |      |      | East Bound |      |      | West Bound |      |      |
|---|-------------|------|------|-------------|------|------|------------|------|------|------------|------|------|
| Movement:                                   | L           | T    | R    | L           | T    | R    | L          | T    | R    | L          | T    | R    |
| Min. Green:                                 | 7           | 10   | 10   | 7           | 10   | 10   | 10         | 10   | 10   | 10         | 10   | 10   |
| Y+R:  | 4.0         | 4.0  | 4.0  | 4.0         | 4.0  | 4.0  | 4.0        | 4.0  | 4.0  | 4.0        | 4.0  | 4.0  |
| Volume Module: >> Count Date: 9 Oct 2014 << |             |      |      |             |      |      |            |      |      |            |      |      |
| Base Vol:                                   | 121         | 385  | 68   | 3           | 468  | 25   | 40         | 35   | 192  | 29         | 17   | 2    |
| Growth Adj:                                 | 1.00        | 1.00 | 1.00 | 1.00        | 1.00 | 1.00 | 1.00       | 1.00 | 1.00 | 1.00       | 1.00 | 1.00 |
| Initial Bse:                                | 121         | 385  | 68   | 3           | 468  | 25   | 40         | 35   | 192  | 29         | 17   | 2    |
| Added Vol:                                  | 0           | 0    | 0    | 0           | 0    | 0    | 0          | 0    | 0    | 0          | 0    | 0    |
| PasserByVol:                                | 0           | 0    | 0    | 0           | 0    | 0    | 0          | 0    | 0    | 0          | 0    | 0    |
| Initial Fut:                                | 121         | 385  | 68   | 3           | 468  | 25   | 40         | 35   | 192  | 29         | 17   | 2    |
| User Adj:                                   | 1.00        | 1.00 | 1.00 | 1.00        | 1.00 | 1.00 | 1.00       | 1.00 | 1.00 | 1.00       | 1.00 | 1.00 |
| PHF Adj:                                    | 1.00        | 1.00 | 1.00 | 1.00        | 1.00 | 1.00 | 1.00       | 1.00 | 1.00 | 1.00       | 1.00 | 1.00 |
| PHF Volume:                                 | 121         | 385  | 68   | 3           | 468  | 25   | 40         | 35   | 192  | 29         | 17   | 2    |
| Reduct Vol:                                 | 0           | 0    | 0    | 0           | 0    | 0    | 0          | 0    | 0    | 0          | 0    | 0    |
| Reduced Vol:                                | 121         | 385  | 68   | 3           | 468  | 25   | 40         | 35   | 192  | 29         | 17   | 2    |
| PCE Adj:                                    | 1.00        | 1.00 | 1.00 | 1.00        | 1.00 | 1.00 | 1.00       | 1.00 | 1.00 | 1.00       | 1.00 | 1.00 |
| MLF Adj:                                    | 1.00        | 1.00 | 1.00 | 1.00        | 1.00 | 1.00 | 1.00       | 1.00 | 1.00 | 1.00       | 1.00 | 1.00 |
| Final Volume:                               | 121         | 385  | 68   | 3           | 468  | 25   | 40         | 35   | 192  | 29         | 17   | 2    |
| Saturation Flow Module:                     |             |      |      |             |      |      |            |      |      |            |      |      |
| Sat/Lane:                                   | 1900        | 1900 | 1900 | 1900        | 1900 | 1900 | 1900       | 1900 | 1900 | 1900       | 1900 | 1900 |
| Adjustment:                                 | 0.92        | 1.00 | 0.92 | 0.92        | 0.95 | 0.95 | 0.95       | 0.95 | 0.92 | 0.92       | 0.92 | 0.92 |
| Lanes:                                      | 1.00        | 1.00 | 1.00 | 1.00        | 0.95 | 0.05 | 0.53       | 0.47 | 1.00 | 0.61       | 0.35 | 0.04 |
| Final Sat.:                                 | 1750        | 1900 | 1750 | 1750        | 1709 | 91   | 960        | 840  | 1750 | 1057       | 620  | 73   |
| Capacity Analysis Module:                   |             |      |      |             |      |      |            |      |      |            |      |      |
| Vol/Sat:                                    | 0.07        | 0.20 | 0.04 | 0.00        | 0.27 | 0.27 | 0.04       | 0.04 | 0.11 | 0.03       | 0.03 | 0.03 |
| Crit Moves:                                 | ****        |      |      |             |      |      |            |      |      |            |      | **** |
| Green Time:                                 | 11.6        | 40.9 | 40.9 | 16.6        | 46.0 | 46.0 | 18.4       | 18.4 | 18.4 | 18.4       | 18.4 | 18.4 |
| Volume/Cap:                                 | 0.51        | 0.42 | 0.08 | 0.01        | 0.51 | 0.51 | 0.19       | 0.19 | 0.51 | 0.13       | 0.13 | 0.13 |
| Delay/Veh:                                  | 35.8        | 14.6 | 11.9 | 27.5        | 12.8 | 12.8 | 27.5       | 27.5 | 30.4 | 27.0       | 27.0 | 27.0 |
| User DelAdj:                                | 1.00        | 1.00 | 1.00 | 1.00        | 1.00 | 1.00 | 1.00       | 1.00 | 1.00 | 1.00       | 1.00 | 1.00 |
| AdjDel/Veh:                                 | 35.8        | 14.6 | 11.9 | 27.5        | 12.8 | 12.8 | 27.5       | 27.5 | 30.4 | 27.0       | 27.0 | 27.0 |
| LOS by Move:                                | D           | B    | B    | C           | B    | B    | C          | C    | C    | C          | C    | C    |
| HCM2k95thQ:                                 | 6           | 12   | 2    | 0           | 16   | 16   | 4          | 4    | 10   | 2          | 2    | 2    |

Note: Queue reported is the number of cars per lane.

BART

Level Of Service Computation Report  
 2000 HCM Operations (Future Volume Alternative)  
 AM - Exist + Proj Conditions

Intersection #4005: JULIAN/28TH [Study Int 3]

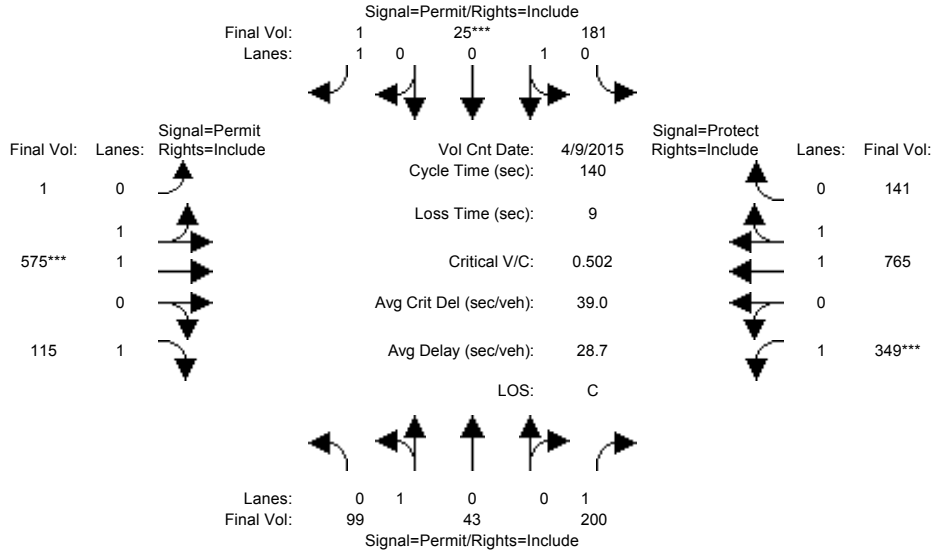

| Approach:                 | North Bound                  |      |      | South Bound |      |      | East Bound |      |      | West Bound |      |      |
|---------------------------|------------------------------|------|------|-------------|------|------|------------|------|------|------------|------|------|
| Movement:                 | L                            | T    | R    | L           | T    | R    | L          | T    | R    | L          | T    | R    |
| Min. Green:               | 10                           | 10   | 10   | 10          | 10   | 10   | 10         | 10   | 10   | 7          | 10   | 10   |
| Y+R:                      | 4.0                          | 4.0  | 4.0  | 4.0         | 4.0  | 4.0  | 4.0        | 4.0  | 4.0  | 4.0        | 4.0  | 4.0  |
| -----                     |                              |      |      |             |      |      |            |      |      |            |      |      |
| Volume Module:            | >> Count Date: 9 Apr 2015 << |      |      |             |      |      |            |      |      |            |      |      |
| Base Vol:                 | 99                           | 43   | 200  | 181         | 25   | 1    | 1          | 575  | 115  | 349        | 765  | 141  |
| Growth Adj:               | 1.00                         | 1.00 | 1.00 | 1.00        | 1.00 | 1.00 | 1.00       | 1.00 | 1.00 | 1.00       | 1.00 | 1.00 |
| Initial Bse:              | 99                           | 43   | 200  | 181         | 25   | 1    | 1          | 575  | 115  | 349        | 765  | 141  |
| Added Vol:                | 0                            | 0    | 0    | 0           | 0    | 0    | 0          | 0    | 0    | 0          | 0    | 0    |
| PasserByVol:              | 0                            | 0    | 0    | 0           | 0    | 0    | 0          | 0    | 0    | 0          | 0    | 0    |
| Initial Fut:              | 99                           | 43   | 200  | 181         | 25   | 1    | 1          | 575  | 115  | 349        | 765  | 141  |
| User Adj:                 | 1.00                         | 1.00 | 1.00 | 1.00        | 1.00 | 1.00 | 1.00       | 1.00 | 1.00 | 1.00       | 1.00 | 1.00 |
| PHF Adj:                  | 1.00                         | 1.00 | 1.00 | 1.00        | 1.00 | 1.00 | 1.00       | 1.00 | 1.00 | 1.00       | 1.00 | 1.00 |
| PHF Volume:               | 99                           | 43   | 200  | 181         | 25   | 1    | 1          | 575  | 115  | 349        | 765  | 141  |
| Reduct Vol:               | 0                            | 0    | 0    | 0           | 0    | 0    | 0          | 0    | 0    | 0          | 0    | 0    |
| Reduced Vol:              | 99                           | 43   | 200  | 181         | 25   | 1    | 1          | 575  | 115  | 349        | 765  | 141  |
| PCE Adj:                  | 1.00                         | 1.00 | 1.00 | 1.00        | 1.00 | 1.00 | 1.00       | 1.00 | 1.00 | 1.00       | 1.00 | 1.00 |
| MLF Adj:                  | 1.00                         | 1.00 | 1.00 | 1.00        | 1.00 | 1.00 | 1.00       | 1.00 | 1.00 | 1.00       | 1.00 | 1.00 |
| FinalVolume:              | 99                           | 43   | 200  | 181         | 25   | 1    | 1          | 575  | 115  | 349        | 765  | 141  |
| -----                     |                              |      |      |             |      |      |            |      |      |            |      |      |
| Saturation Flow Module:   |                              |      |      |             |      |      |            |      |      |            |      |      |
| Sat/Lane:                 | 1900                         | 1900 | 1900 | 1900        | 1900 | 1900 | 1900       | 1900 | 1900 | 1900       | 1900 | 1900 |
| Adjustment:               | 0.95                         | 0.95 | 0.92 | 0.95        | 0.95 | 0.92 | 0.95       | 0.97 | 0.92 | 0.92       | 0.98 | 0.95 |
| Lanes:                    | 0.70                         | 0.30 | 1.00 | 0.88        | 0.12 | 1.00 | 0.01       | 1.99 | 1.00 | 1.00       | 1.68 | 0.32 |
| Final Sat.:               | 1255                         | 545  | 1750 | 1582        | 218  | 1750 | 6          | 3694 | 1750 | 1750       | 3124 | 576  |
| -----                     |                              |      |      |             |      |      |            |      |      |            |      |      |
| Capacity Analysis Module: |                              |      |      |             |      |      |            |      |      |            |      |      |
| Vol/Sat:                  | 0.08                         | 0.08 | 0.11 | 0.11        | 0.11 | 0.00 | 0.16       | 0.16 | 0.07 | 0.20       | 0.24 | 0.24 |
| Crit Moves:               | *****                        |      |      |             |      |      |            |      |      |            |      |      |
| Green Time:               | 31.9                         | 31.9 | 31.9 | 31.9        | 31.9 | 31.9 | 43.4       | 43.4 | 43.4 | 55.6       | 99.1 | 99.1 |
| Volume/Cap:               | 0.35                         | 0.35 | 0.50 | 0.50        | 0.50 | 0.00 | 0.50       | 0.50 | 0.21 | 0.50       | 0.35 | 0.35 |
| Delay/Veh:                | 45.8                         | 45.8 | 48.1 | 48.1        | 48.1 | 41.7 | 39.8       | 39.8 | 35.8 | 32.3       | 8.0  | 8.0  |
| User DelAdj:              | 1.00                         | 1.00 | 1.00 | 1.00        | 1.00 | 1.00 | 1.00       | 1.00 | 1.00 | 1.00       | 1.00 | 1.00 |
| AdjDel/Veh:               | 45.8                         | 45.8 | 48.1 | 48.1        | 48.1 | 41.7 | 39.8       | 39.8 | 35.8 | 32.3       | 8.0  | 8.0  |
| LOS by Move:              | D                            | D    | D    | D           | D    | D    | D          | D    | D    | C          | A    | A    |
| HCM2k95thQ:               | 10                           | 10   | 15   | 16          | 16   | 0    | 19         | 19   | 7    | 21         | 14   | 14   |

Note: Queue reported is the number of cars per lane.

BART

Level Of Service Computation Report  
2000 HCM Operations (Future Volume Alternative)  
PM - Exist + Proj Conditions

Intersection #4005: JULIAN/28TH [Study Int 3]

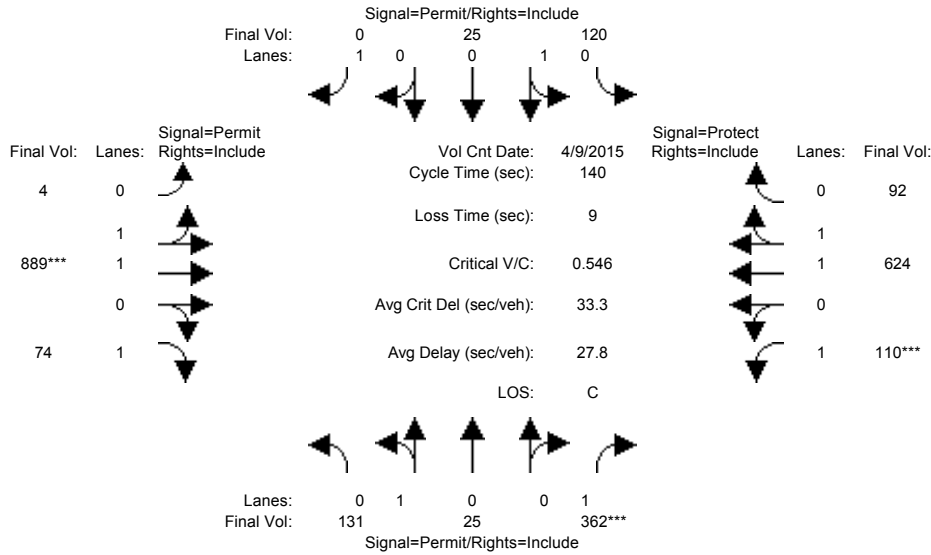

| Approach:                                   | North Bound |      |      | South Bound |      |      | East Bound |      |      | West Bound |      |      |
|---|-------------|------|------|-------------|------|------|------------|------|------|------------|------|------|
| Movement:                                   | L           | T    | R    | L           | T    | R    | L          | T    | R    | L          | T    | R    |
| Min. Green:                                 | 10          | 10   | 10   | 10          | 10   | 10   | 10         | 10   | 10   | 7          | 10   | 10   |
| Y+R:  | 4.0         | 4.0  | 4.0  | 4.0         | 4.0  | 4.0  | 4.0        | 4.0  | 4.0  | 4.0        | 4.0  | 4.0  |
| -----                                       |             |      |      |             |      |      |            |      |      |            |      |      |
| Volume Module: >> Count Date: 9 Apr 2015 << |             |      |      |             |      |      |            |      |      |            |      |      |
| Base Vol:                                   | 131         | 25   | 362  | 120         | 25   | 0    | 4          | 889  | 74   | 110        | 624  | 92   |
| Growth Adj:                                 | 1.00        | 1.00 | 1.00 | 1.00        | 1.00 | 1.00 | 1.00       | 1.00 | 1.00 | 1.00       | 1.00 | 1.00 |
| Initial Bse:                                | 131         | 25   | 362  | 120         | 25   | 0    | 4          | 889  | 74   | 110        | 624  | 92   |
| Added Vol:                                  | 0           | 0    | 0    | 0           | 0    | 0    | 0          | 0    | 0    | 0          | 0    | 0    |
| PasserByVol:                                | 0           | 0    | 0    | 0           | 0    | 0    | 0          | 0    | 0    | 0          | 0    | 0    |
| Initial Fut:                                | 131         | 25   | 362  | 120         | 25   | 0    | 4          | 889  | 74   | 110        | 624  | 92   |
| User Adj:                                   | 1.00        | 1.00 | 1.00 | 1.00        | 1.00 | 1.00 | 1.00       | 1.00 | 1.00 | 1.00       | 1.00 | 1.00 |
| PHF Adj:                                    | 1.00        | 1.00 | 1.00 | 1.00        | 1.00 | 1.00 | 1.00       | 1.00 | 1.00 | 1.00       | 1.00 | 1.00 |
| PHF Volume:                                 | 131         | 25   | 362  | 120         | 25   | 0    | 4          | 889  | 74   | 110        | 624  | 92   |
| Reduct Vol:                                 | 0           | 0    | 0    | 0           | 0    | 0    | 0          | 0    | 0    | 0          | 0    | 0    |
| Reduced Vol:                                | 131         | 25   | 362  | 120         | 25   | 0    | 4          | 889  | 74   | 110        | 624  | 92   |
| PCE Adj:                                    | 1.00        | 1.00 | 1.00 | 1.00        | 1.00 | 1.00 | 1.00       | 1.00 | 1.00 | 1.00       | 1.00 | 1.00 |
| MLF Adj:                                    | 1.00        | 1.00 | 1.00 | 1.00        | 1.00 | 1.00 | 1.00       | 1.00 | 1.00 | 1.00       | 1.00 | 1.00 |
| FinalVolume:                                | 131         | 25   | 362  | 120         | 25   | 0    | 4          | 889  | 74   | 110        | 624  | 92   |
| -----                                       |             |      |      |             |      |      |            |      |      |            |      |      |
| Saturation Flow Module:                     |             |      |      |             |      |      |            |      |      |            |      |      |
| Sat/Lane:                                   | 1900        | 1900 | 1900 | 1900        | 1900 | 1900 | 1900       | 1900 | 1900 | 1900       | 1900 | 1900 |
| Adjustment:                                 | 0.95        | 0.95 | 0.92 | 0.95        | 0.95 | 0.92 | 0.95       | 0.97 | 0.92 | 0.92       | 0.98 | 0.95 |
| Lanes:                                      | 0.84        | 0.16 | 1.00 | 0.83        | 0.17 | 1.00 | 0.01       | 1.99 | 1.00 | 1.00       | 1.74 | 0.26 |
| Final Sat.:                                 | 1512        | 288  | 1750 | 1490        | 310  | 1750 | 17         | 3683 | 1750 | 1750       | 3224 | 475  |
| -----                                       |             |      |      |             |      |      |            |      |      |            |      |      |
| Capacity Analysis Module:                   |             |      |      |             |      |      |            |      |      |            |      |      |
| Vol/Sat:                                    | 0.09        | 0.09 | 0.21 | 0.08        | 0.08 | 0.00 | 0.24       | 0.24 | 0.04 | 0.06       | 0.19 | 0.19 |
| Crit Moves:                                 | ****        |      |      | ****        |      |      | ****       |      |      | ****       |      |      |
| Green Time:                                 | 53.0        | 53.0 | 53.0 | 53.0        | 53.0 | 0.0  | 61.9       | 61.9 | 61.9 | 16.1       | 78.0 | 78.0 |
| Volume/Cap:                                 | 0.23        | 0.23 | 0.55 | 0.21        | 0.21 | 0.00 | 0.55       | 0.55 | 0.10 | 0.55       | 0.35 | 0.35 |
| Delay/Veh:                                  | 29.8        | 29.8 | 35.0 | 29.5        | 29.5 | 0.0  | 29.1       | 29.1 | 22.8 | 61.6       | 17.1 | 17.1 |
| User DelAdj:                                | 1.00        | 1.00 | 1.00 | 1.00        | 1.00 | 1.00 | 1.00       | 1.00 | 1.00 | 1.00       | 1.00 | 1.00 |
| AdjDel/Veh:                                 | 29.8        | 29.8 | 35.0 | 29.5        | 29.5 | 0.0  | 29.1       | 29.1 | 22.8 | 61.6       | 17.1 | 17.1 |
| LOS by Move:                                | C           | C    | D    | C           | C    | A    | C          | C    | C    | E          | B    | B    |
| HCM2k95thQ:                                 | 9           | 9    | 23   | 8           | 8    | 0    | 25         | 25   | 4    | 9          | 16   | 16   |

Note: Queue reported is the number of cars per lane.

BART

Level Of Service Computation Report  
 2000 HCM Operations (Future Volume Alternative)  
 AM - Exist + Proj Conditions

Intersection #4022: SANTA CLARA/26TH [Study Int 12]

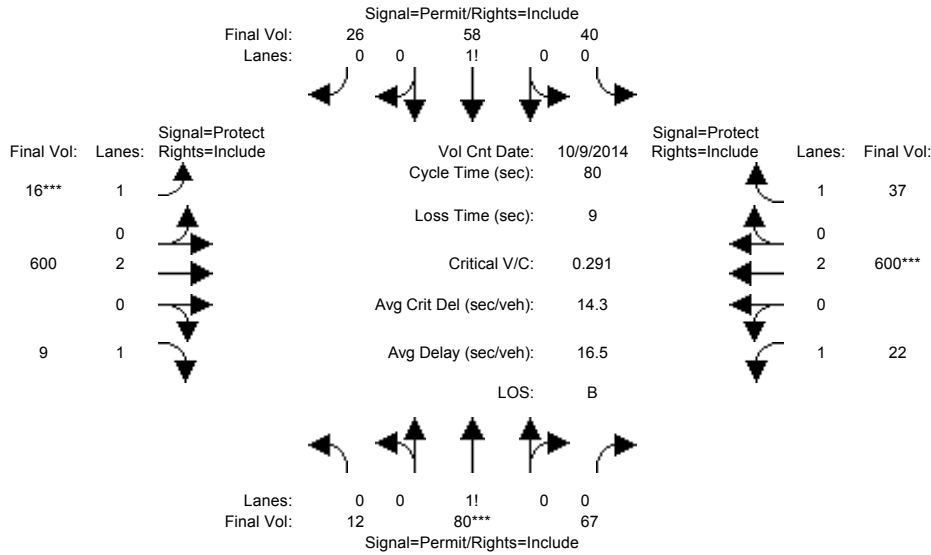

| Approach:                                   | North Bound |      |      | South Bound |      |      | East Bound |      |      | West Bound |      |      |
|---|-------------|------|------|-------------|------|------|------------|------|------|------------|------|------|
| Movement:                                   | L           | T    | R    | L           | T    | R    | L          | T    | R    | L          | T    | R    |
| Min. Green:                                 | 10          | 10   | 10   | 10          | 10   | 10   | 7          | 10   | 10   | 7          | 10   | 10   |
| Y+R:  | 4.0         | 4.0  | 4.0  | 4.0         | 4.0  | 4.0  | 4.0        | 4.0  | 4.0  | 4.0        | 4.0  | 4.0  |
| Volume Module: >> Count Date: 9 Oct 2014 << |             |      |      |             |      |      |            |      |      |            |      |      |
| Base Vol:                                   | 12          | 80   | 67   | 40          | 58   | 26   | 16         | 600  | 9    | 22         | 600  | 37   |
| Growth Adj:                                 | 1.00        | 1.00 | 1.00 | 1.00        | 1.00 | 1.00 | 1.00       | 1.00 | 1.00 | 1.00       | 1.00 | 1.00 |
| Initial Bse:                                | 12          | 80   | 67   | 40          | 58   | 26   | 16         | 600  | 9    | 22         | 600  | 37   |
| Added Vol:                                  | 0           | 0    | 0    | 0           | 0    | 0    | 0          | 0    | 0    | 0          | 0    | 0    |
| PasserByVol:                                | 0           | 0    | 0    | 0           | 0    | 0    | 0          | 0    | 0    | 0          | 0    | 0    |
| Initial Fut:                                | 12          | 80   | 67   | 40          | 58   | 26   | 16         | 600  | 9    | 22         | 600  | 37   |
| User Adj:                                   | 1.00        | 1.00 | 1.00 | 1.00        | 1.00 | 1.00 | 1.00       | 1.00 | 1.00 | 1.00       | 1.00 | 1.00 |
| PHF Adj:                                    | 1.00        | 1.00 | 1.00 | 1.00        | 1.00 | 1.00 | 1.00       | 1.00 | 1.00 | 1.00       | 1.00 | 1.00 |
| PHF Volume:                                 | 12          | 80   | 67   | 40          | 58   | 26   | 16         | 600  | 9    | 22         | 600  | 37   |
| Reduct Vol:                                 | 0           | 0    | 0    | 0           | 0    | 0    | 0          | 0    | 0    | 0          | 0    | 0    |
| Reduced Vol:                                | 12          | 80   | 67   | 40          | 58   | 26   | 16         | 600  | 9    | 22         | 600  | 37   |
| PCE Adj:                                    | 1.00        | 1.00 | 1.00 | 1.00        | 1.00 | 1.00 | 1.00       | 1.00 | 1.00 | 1.00       | 1.00 | 1.00 |
| MLF Adj:                                    | 1.00        | 1.00 | 1.00 | 1.00        | 1.00 | 1.00 | 1.00       | 1.00 | 1.00 | 1.00       | 1.00 | 1.00 |
| Final Volume:                               | 12          | 80   | 67   | 40          | 58   | 26   | 16         | 600  | 9    | 22         | 600  | 37   |
| Saturation Flow Module:                     |             |      |      |             |      |      |            |      |      |            |      |      |
| Sat/Lane:                                   | 1900        | 1900 | 1900 | 1900        | 1900 | 1900 | 1900       | 1900 | 1900 | 1900       | 1900 | 1900 |
| Adjustment:                                 | 0.92        | 0.92 | 0.92 | 0.92        | 0.92 | 0.92 | 0.92       | 1.00 | 0.92 | 0.92       | 1.00 | 0.92 |
| Lanes:                                      | 0.08        | 0.50 | 0.42 | 0.32        | 0.47 | 0.21 | 1.00       | 2.00 | 1.00 | 1.00       | 2.00 | 1.00 |
| Final Sat.:                                 | 132         | 881  | 737  | 565         | 819  | 367  | 1750       | 3800 | 1750 | 1750       | 3800 | 1750 |
| Capacity Analysis Module:                   |             |      |      |             |      |      |            |      |      |            |      |      |
| Vol/Sat:                                    | 0.09        | 0.09 | 0.09 | 0.07        | 0.07 | 0.07 | 0.01       | 0.16 | 0.01 | 0.01       | 0.16 | 0.02 |
| Crit Moves:                                 | ****        |      |      | ****        |      |      | ****       |      |      | ****       |      |      |
| Green Time:                                 | 23.4        | 23.4 | 23.4 | 23.4        | 23.4 | 23.4 | 7.0        | 30.6 | 30.6 | 17.0       | 40.6 | 40.6 |
| Volume/Cap:                                 | 0.31        | 0.31 | 0.31 | 0.24        | 0.24 | 0.24 | 0.10       | 0.41 | 0.01 | 0.06       | 0.31 | 0.04 |
| Delay/Veh:                                  | 22.4        | 22.4 | 22.4 | 21.8        | 21.8 | 21.8 | 33.9       | 18.3 | 15.3 | 25.2       | 11.6 | 9.9  |
| User DelAdj:                                | 1.00        | 1.00 | 1.00 | 1.00        | 1.00 | 1.00 | 1.00       | 1.00 | 1.00 | 1.00       | 1.00 | 1.00 |
| AdjDel/Veh:                                 | 22.4        | 22.4 | 22.4 | 21.8        | 21.8 | 21.8 | 33.9       | 18.3 | 15.3 | 25.2       | 11.6 | 9.9  |
| LOS by Move:                                | C           | C    | C    | C           | C    | C    | C          | B    | B    | C          | B    | A    |
| HCM2k95thQ:                                 | 7           | 7    | 7    | 5           | 5    | 5    | 1          | 10   | 0    | 1          | 8    | 1    |

Note: Queue reported is the number of cars per lane.

BART

Level Of Service Computation Report  
2000 HCM Operations (Future Volume Alternative)  
PM - Exist + Proj Conditions

Intersection #4022: SANTA CLARA/26TH [Study Int 12]

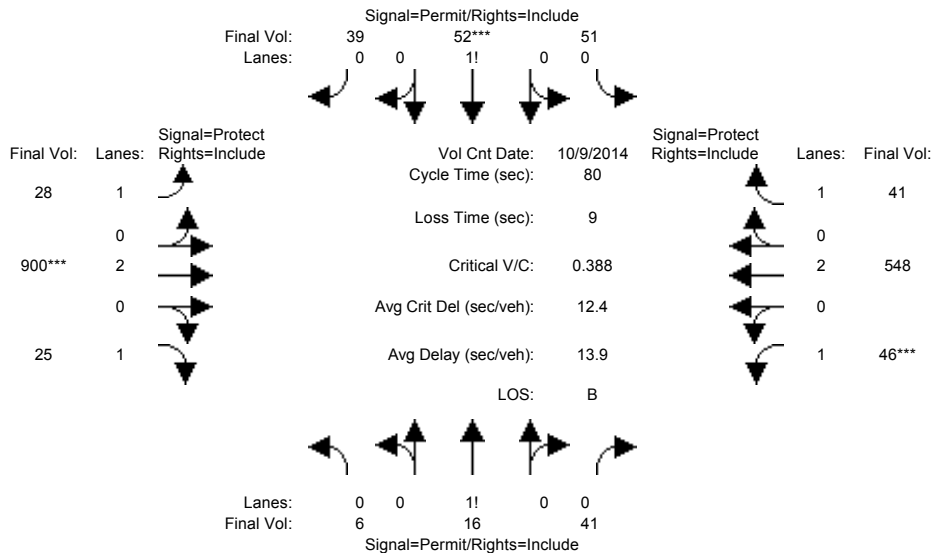

| Approach:                                   | North Bound |      |      | South Bound |      |      | East Bound |      |      | West Bound |      |      |
|---|-------------|------|------|-------------|------|------|------------|------|------|------------|------|------|
| Movement:                                   | L           | T    | R    | L           | T    | R    | L          | T    | R    | L          | T    | R    |
| Min. Green:                                 | 10          | 10   | 10   | 10          | 10   | 10   | 7          | 10   | 10   | 7          | 10   | 10   |
| Y+R:  | 4.0         | 4.0  | 4.0  | 4.0         | 4.0  | 4.0  | 4.0        | 4.0  | 4.0  | 4.0        | 4.0  | 4.0  |
| Volume Module: >> Count Date: 9 Oct 2014 << |             |      |      |             |      |      |            |      |      |            |      |      |
| Base Vol:                                   | 6           | 16   | 41   | 51          | 52   | 39   | 28         | 900  | 25   | 46         | 548  | 41   |
| Growth Adj:                                 | 1.00        | 1.00 | 1.00 | 1.00        | 1.00 | 1.00 | 1.00       | 1.00 | 1.00 | 1.00       | 1.00 | 1.00 |
| Initial Bse:                                | 6           | 16   | 41   | 51          | 52   | 39   | 28         | 900  | 25   | 46         | 548  | 41   |
| Added Vol:                                  | 0           | 0    | 0    | 0           | 0    | 0    | 0          | 0    | 0    | 0          | 0    | 0    |
| PasserByVol:                                | 0           | 0    | 0    | 0           | 0    | 0    | 0          | 0    | 0    | 0          | 0    | 0    |
| Initial Fut:                                | 6           | 16   | 41   | 51          | 52   | 39   | 28         | 900  | 25   | 46         | 548  | 41   |
| User Adj:                                   | 1.00        | 1.00 | 1.00 | 1.00        | 1.00 | 1.00 | 1.00       | 1.00 | 1.00 | 1.00       | 1.00 | 1.00 |
| PHF Adj:                                    | 1.00        | 1.00 | 1.00 | 1.00        | 1.00 | 1.00 | 1.00       | 1.00 | 1.00 | 1.00       | 1.00 | 1.00 |
| PHF Volume:                                 | 6           | 16   | 41   | 51          | 52   | 39   | 28         | 900  | 25   | 46         | 548  | 41   |
| Reduct Vol:                                 | 0           | 0    | 0    | 0           | 0    | 0    | 0          | 0    | 0    | 0          | 0    | 0    |
| Reduced Vol:                                | 6           | 16   | 41   | 51          | 52   | 39   | 28         | 900  | 25   | 46         | 548  | 41   |
| PCE Adj:                                    | 1.00        | 1.00 | 1.00 | 1.00        | 1.00 | 1.00 | 1.00       | 1.00 | 1.00 | 1.00       | 1.00 | 1.00 |
| MLF Adj:                                    | 1.00        | 1.00 | 1.00 | 1.00        | 1.00 | 1.00 | 1.00       | 1.00 | 1.00 | 1.00       | 1.00 | 1.00 |
| Final Volume:                               | 6           | 16   | 41   | 51          | 52   | 39   | 28         | 900  | 25   | 46         | 548  | 41   |
| Saturation Flow Module:                     |             |      |      |             |      |      |            |      |      |            |      |      |
| Sat/Lane:                                   | 1900        | 1900 | 1900 | 1900        | 1900 | 1900 | 1900       | 1900 | 1900 | 1900       | 1900 | 1900 |
| Adjustment:                                 | 0.92        | 0.92 | 0.92 | 0.92        | 0.92 | 0.92 | 0.92       | 1.00 | 0.92 | 0.92       | 1.00 | 0.92 |
| Lanes:                                      | 0.10        | 0.25 | 0.65 | 0.36        | 0.37 | 0.27 | 1.00       | 2.00 | 1.00 | 1.00       | 2.00 | 1.00 |
| Final Sat.:                                 | 167         | 444  | 1139 | 629         | 641  | 481  | 1750       | 3800 | 1750 | 1750       | 3800 | 1750 |
| Capacity Analysis Module:                   |             |      |      |             |      |      |            |      |      |            |      |      |
| Vol/Sat:                                    | 0.04        | 0.04 | 0.04 | 0.08        | 0.08 | 0.08 | 0.02       | 0.24 | 0.01 | 0.03       | 0.14 | 0.02 |
| Crit Moves:                                 |             |      |      | ****        |      |      |            | **** |      |            |      | **** |
| Green Time:                                 | 16.3        | 16.3 | 16.3 | 16.3        | 16.3 | 16.3 | 20.6       | 47.7 | 47.7 | 7.0        | 34.0 | 34.0 |
| Volume/Cap:                                 | 0.18        | 0.18 | 0.18 | 0.40        | 0.40 | 0.40 | 0.06       | 0.40 | 0.02 | 0.30       | 0.34 | 0.06 |
| Delay/Veh:                                  | 26.5        | 26.5 | 26.5 | 28.3        | 28.3 | 28.3 | 22.4       | 8.7  | 6.6  | 35.3       | 15.6 | 13.6 |
| User DelAdj:                                | 1.00        | 1.00 | 1.00 | 1.00        | 1.00 | 1.00 | 1.00       | 1.00 | 1.00 | 1.00       | 1.00 | 1.00 |
| AdjDel/Veh:                                 | 26.5        | 26.5 | 26.5 | 28.3        | 28.3 | 28.3 | 22.4       | 8.7  | 6.6  | 35.3       | 15.6 | 13.6 |
| LOS by Move:                                | C           | C    | C    | C           | C    | C    | C          | A    | A    | D          | B    | B    |
| HCM2k95thQ:                                 | 3           | 3    | 3    | 7           | 7    | 7    | 1          | 11   | 1    | 2          | 9    | 1    |

Note: Queue reported is the number of cars per lane.

BART

Level Of Service Computation Report  
 2000 HCM Operations (Future Volume Alternative)  
 AM - Exist + Proj Conditions

Intersection #4038: 87/Taylor [Study Int 40]

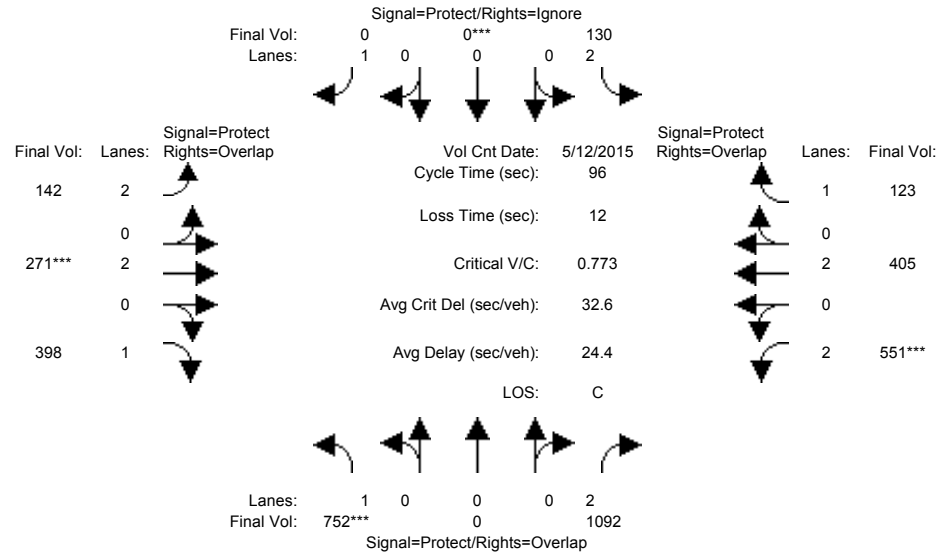

| Approach:                     | North Bound                |      |      | South Bound |      |      | East Bound |      |      | West Bound |      |      |
|-------------------------------|----------------------------|------|------|-------------|------|------|------------|------|------|------------|------|------|
| Movement:                     | L                          | T    | R    | L           | T    | R    | L          | T    | R    | L          | T    | R    |
| Min. Green:                   | 7                          | 0    | 10   | 7           | 0    | 10   | 7          | 10   | 10   | 7          | 10   | 10   |
| Y+R:                          | 4.0                        | 4.0  | 4.0  | 4.0         | 4.0  | 4.0  | 4.0        | 4.0  | 4.0  | 4.0        | 4.0  | 4.0  |
| Volume Module: >> Count Date: | 12 May 2015 << 7:30-8:30AM |      |      |             |      |      |            |      |      |            |      |      |
| Base Vol:                     | 752                        | 0    | 1092 | 130         | 0    | 145  | 142        | 271  | 398  | 551        | 405  | 123  |
| Growth Adj:                   | 1.00                       | 1.00 | 1.00 | 1.00        | 1.00 | 1.00 | 1.00       | 1.00 | 1.00 | 1.00       | 1.00 | 1.00 |
| Initial Bse:                  | 752                        | 0    | 1092 | 130         | 0    | 145  | 142        | 271  | 398  | 551        | 405  | 123  |
| Added Vol:                    | 0                          | 0    | 0    | 0           | 0    | 0    | 0          | 0    | 0    | 0          | 0    | 0    |
| PasserByVol:                  | 0                          | 0    | 0    | 0           | 0    | 0    | 0          | 0    | 0    | 0          | 0    | 0    |
| Initial Fut:                  | 752                        | 0    | 1092 | 130         | 0    | 145  | 142        | 271  | 398  | 551        | 405  | 123  |
| User Adj:                     | 1.00                       | 1.00 | 1.00 | 1.00        | 1.00 | 0.00 | 1.00       | 1.00 | 1.00 | 1.00       | 1.00 | 1.00 |
| PHF Adj:                      | 1.00                       | 1.00 | 1.00 | 1.00        | 1.00 | 0.00 | 1.00       | 1.00 | 1.00 | 1.00       | 1.00 | 1.00 |
| PHF Volume:                   | 752                        | 0    | 1092 | 130         | 0    | 0    | 142        | 271  | 398  | 551        | 405  | 123  |
| Reduct Vol:                   | 0                          | 0    | 0    | 0           | 0    | 0    | 0          | 0    | 0    | 0          | 0    | 0    |
| Reduced Vol:                  | 752                        | 0    | 1092 | 130         | 0    | 0    | 142        | 271  | 398  | 551        | 405  | 123  |
| PCE Adj:                      | 1.00                       | 1.00 | 1.00 | 1.00        | 1.00 | 0.00 | 1.00       | 1.00 | 1.00 | 1.00       | 1.00 | 1.00 |
| MLF Adj:                      | 1.00                       | 1.00 | 1.00 | 1.00        | 1.00 | 0.00 | 1.00       | 1.00 | 1.00 | 1.00       | 1.00 | 1.00 |
| Final Volume:                 | 752                        | 0    | 1092 | 130         | 0    | 0    | 142        | 271  | 398  | 551        | 405  | 123  |
| Saturation Flow Module:       |                            |      |      |             |      |      |            |      |      |            |      |      |
| Sat/Lane:                     | 1900                       | 1900 | 1900 | 1900        | 1900 | 1900 | 1900       | 1900 | 1900 | 1900       | 1900 | 1900 |
| Adjustment:                   | 0.92                       | 1.00 | 0.83 | 0.83        | 1.00 | 0.92 | 0.83       | 1.00 | 0.92 | 0.83       | 1.00 | 0.92 |
| Lanes:                        | 1.00                       | 0.00 | 2.00 | 2.00        | 0.00 | 1.00 | 2.00       | 2.00 | 1.00 | 2.00       | 2.00 | 1.00 |
| Final Sat.:                   | 1750                       | 0    | 3150 | 3150        | 0    | 1750 | 3150       | 3800 | 1750 | 3150       | 3800 | 1750 |
| Capacity Analysis Module:     |                            |      |      |             |      |      |            |      |      |            |      |      |
| Vol/Sat:                      | 0.43                       | 0.00 | 0.35 | 0.04        | 0.00 | 0.00 | 0.05       | 0.07 | 0.23 | 0.17       | 0.11 | 0.07 |
| Crit Moves:                   | ****                       |      |      | ****        |      |      | ****       |      |      | ****       |      |      |
| Green Time:                   | 52.6                       | 0.0  | 58.3 | 15.7        | 0.0  | 0.0  | 12.8       | 10.0 | 62.6 | 21.4       | 18.6 | 34.3 |
| Volume/Cap:                   | 0.78                       | 0.00 | 0.57 | 0.25        | 0.00 | 0.00 | 0.34       | 0.68 | 0.35 | 0.78       | 0.55 | 0.20 |
| Delay/Veh:                    | 21.5                       | 0.0  | 11.7 | 35.3        | 0.0  | 0.0  | 38.3       | 46.4 | 7.7  | 40.9       | 35.8 | 21.5 |
| User DelAdj:                  | 1.00                       | 1.00 | 1.00 | 1.00        | 1.00 | 1.00 | 1.00       | 1.00 | 1.00 | 1.00       | 1.00 | 1.00 |
| AdjDel/Veh:                   | 21.5                       | 0.0  | 11.7 | 35.3        | 0.0  | 0.0  | 38.3       | 46.4 | 7.7  | 40.9       | 35.8 | 21.5 |
| LOS by Move:                  | C                          | A    | B    | D           | A    | A    | D          | D    | A    | D          | D    | C    |
| HCM2k95thQ:                   | 35                         | 0    | 21   | 4           | 0    | 0    | 5          | 8    | 11   | 20         | 12   | 5    |

Note: Queue reported is the number of cars per lane.



BART

Level Of Service Computation Report  
 2000 HCM Operations (Future Volume Alternative)  
 PM - Exist + Proj Conditions

Intersection #4038: 87/Taylor [Study Int 40]

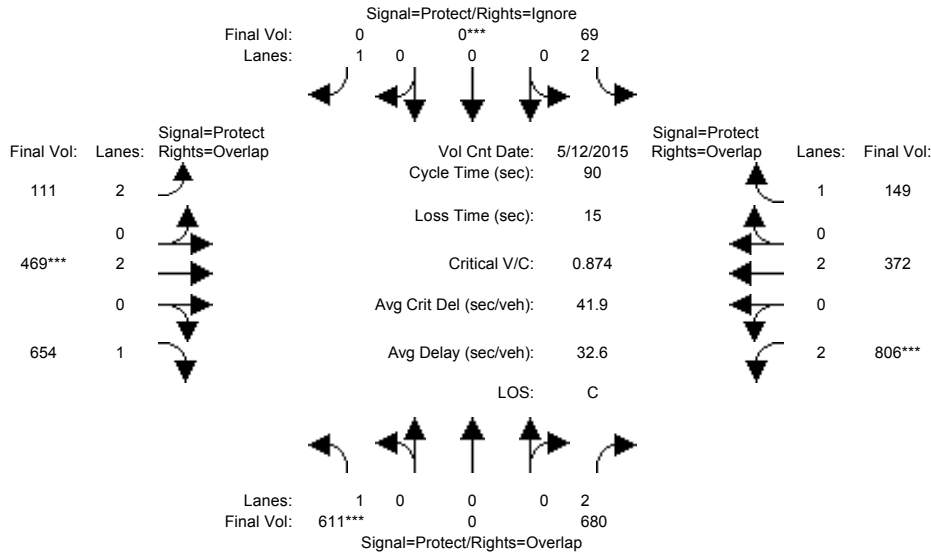

| Approach:  | North Bound |      |      | South Bound |      |      | East Bound |      |      | West Bound |      |      |
|--|-------------|------|------|-------------|------|------|------------|------|------|------------|------|------|
| Movement:  | L           | T    | R    | L           | T    | R    | L          | T    | R    | L          | T    | R    |
| Min. Green:  | 7           | 0    | 10   | 7           | 0    | 10   | 7          | 10   | 10   | 7          | 10   | 10   |
| Y+R:   | 4.0         | 4.0  | 4.0  | 4.0         | 4.0  | 4.0  | 4.0        | 4.0  | 4.0  | 4.0        | 4.0  | 4.0  |
| Volume Module: >> Count Date: 12 May 2015 << 5:00-6:00PM |             |      |      |             |      |      |            |      |      |            |      |      |
| Base Vol:  | 611         | 0    | 680  | 69          | 0    | 154  | 111        | 469  | 654  | 806        | 372  | 149  |
| Growth Adj:  | 1.00        | 1.00 | 1.00 | 1.00        | 1.00 | 1.00 | 1.00       | 1.00 | 1.00 | 1.00       | 1.00 | 1.00 |
| Initial Bse:   | 611         | 0    | 680  | 69          | 0    | 154  | 111        | 469  | 654  | 806        | 372  | 149  |
| Added Vol:   | 0           | 0    | 0    | 0           | 0    | 0    | 0          | 0    | 0    | 0          | 0    | 0    |
| PasserByVol:   | 0           | 0    | 0    | 0           | 0    | 0    | 0          | 0    | 0    | 0          | 0    | 0    |
| Initial Fut:   | 611         | 0    | 680  | 69          | 0    | 154  | 111        | 469  | 654  | 806        | 372  | 149  |
| User Adj:  | 1.00        | 1.00 | 1.00 | 1.00        | 1.00 | 0.00 | 1.00       | 1.00 | 1.00 | 1.00       | 1.00 | 1.00 |
| PHF Adj:   | 1.00        | 1.00 | 1.00 | 1.00        | 1.00 | 0.00 | 1.00       | 1.00 | 1.00 | 1.00       | 1.00 | 1.00 |
| PHF Volume:  | 611         | 0    | 680  | 69          | 0    | 0    | 111        | 469  | 654  | 806        | 372  | 149  |
| Reduct Vol:  | 0           | 0    | 0    | 0           | 0    | 0    | 0          | 0    | 0    | 0          | 0    | 0    |
| Reduced Vol:   | 611         | 0    | 680  | 69          | 0    | 0    | 111        | 469  | 654  | 806        | 372  | 149  |
| PCE Adj:   | 1.00        | 1.00 | 1.00 | 1.00        | 1.00 | 0.00 | 1.00       | 1.00 | 1.00 | 1.00       | 1.00 | 1.00 |
| MLF Adj:   | 1.00        | 1.00 | 1.00 | 1.00        | 1.00 | 0.00 | 1.00       | 1.00 | 1.00 | 1.00       | 1.00 | 1.00 |
| Final Volume:  | 611         | 0    | 680  | 69          | 0    | 0    | 111        | 469  | 654  | 806        | 372  | 149  |
| Saturation Flow Module:                                  |             |      |      |             |      |      |            |      |      |            |      |      |
| Sat/Lane:  | 1900        | 1900 | 1900 | 1900        | 1900 | 1900 | 1900       | 1900 | 1900 | 1900       | 1900 | 1900 |
| Adjustment:  | 0.92        | 1.00 | 0.83 | 0.83        | 1.00 | 0.92 | 0.83       | 1.00 | 0.92 | 0.83       | 1.00 | 0.92 |
| Lanes:   | 1.00        | 0.00 | 2.00 | 2.00        | 0.00 | 1.00 | 2.00       | 2.00 | 1.00 | 2.00       | 2.00 | 1.00 |
| Final Sat.:  | 1750        | 0    | 3150 | 3150        | 0    | 1750 | 3150       | 3800 | 1750 | 3150       | 3800 | 1750 |
| Capacity Analysis Module:                                |             |      |      |             |      |      |            |      |      |            |      |      |
| Vol/Sat:   | 0.35        | 0.00 | 0.22 | 0.02        | 0.00 | 0.00 | 0.04       | 0.12 | 0.37 | 0.26       | 0.10 | 0.09 |
| Crit Moves:  | ****        |      |      | ****        |      |      | ****       |      |      | ****       |      |      |
| Green Time:  | 35.9        | 0.0  | 26.3 | 35.9        | 0.0  | 0.0  | 16.1       | 12.7 | 48.7 | 26.3       | 23.0 | 58.9 |
| Volume/Cap:  | 0.87        | 0.00 | 0.74 | 0.05        | 0.00 | 0.00 | 0.20       | 0.87 | 0.69 | 0.87       | 0.38 | 0.13 |
| Delay/Veh:   | 36.8        | 0.0  | 31.9 | 16.6        | 0.0  | 0.0  | 31.6       | 52.6 | 17.4 | 39.6       | 27.9 | 5.9  |
| User DelAdj:   | 1.00        | 1.00 | 1.00 | 1.00        | 1.00 | 1.00 | 1.00       | 1.00 | 1.00 | 1.00       | 1.00 | 1.00 |
| AdjDel/Veh:  | 36.8        | 0.0  | 31.9 | 16.6        | 0.0  | 0.0  | 31.6       | 52.6 | 17.4 | 39.6       | 27.9 | 5.9  |
| LOS by Move:   | D           | A    | C    | B           | A    | A    | C          | D    | B    | D          | C    | A    |
| HCM2k95thQ:  | 34          | 0    | 21   | 1           | 0    | 0    | 3          | 13   | 25   | 28         | 9    | 3    |

Note: Queue reported is the number of cars per lane.

BART

Level Of Service Computation Report  
 2000 HCM Operations (Future Volume Alternative)  
 AM - Exist + Proj Conditions

Intersection #4047: COLEMAN/NEWHALL [Study Int 35]

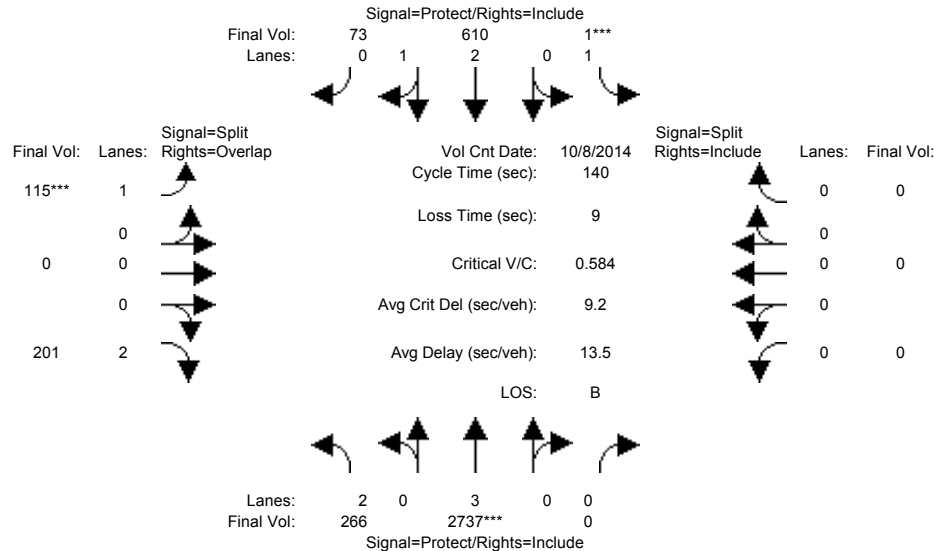

| Approach:                 | North Bound                  |      |      | South Bound |      |      | East Bound |      |      | West Bound |      |      |
|---------------------------|------------------------------|------|------|-------------|------|------|------------|------|------|------------|------|------|
| Movement:                 | L                            | T    | R    | L           | T    | R    | L          | T    | R    | L          | T    | R    |
| Min. Green:               | 7                            | 10   | 0    | 7           | 10   | 10   | 10         | 0    | 10   | 0          | 0    | 0    |
| Y+R:                      | 4.0                          | 4.0  | 4.0  | 4.0         | 4.0  | 4.0  | 4.0        | 4.0  | 4.0  | 4.0        | 4.0  | 4.0  |
| -----                     |                              |      |      |             |      |      |            |      |      |            |      |      |
| Volume Module:            | >> Count Date: 8 Oct 2014 << |      |      |             |      |      |            |      |      |            |      |      |
| Base Vol:                 | 266                          | 2737 | 0    | 1           | 610  | 73   | 115        | 0    | 201  | 0          | 0    | 0    |
| Growth Adj:               | 1.00                         | 1.00 | 1.00 | 1.00        | 1.00 | 1.00 | 1.00       | 1.00 | 1.00 | 1.00       | 1.00 | 1.00 |
| Initial Bse:              | 266                          | 2737 | 0    | 1           | 610  | 73   | 115        | 0    | 201  | 0          | 0    | 0    |
| Added Vol:                | 0                            | 0    | 0    | 0           | 0    | 0    | 0          | 0    | 0    | 0          | 0    | 0    |
| PasserByVol:              | 0                            | 0    | 0    | 0           | 0    | 0    | 0          | 0    | 0    | 0          | 0    | 0    |
| Initial Fut:              | 266                          | 2737 | 0    | 1           | 610  | 73   | 115        | 0    | 201  | 0          | 0    | 0    |
| User Adj:                 | 1.00                         | 1.00 | 1.00 | 1.00        | 1.00 | 1.00 | 1.00       | 1.00 | 1.00 | 1.00       | 1.00 | 1.00 |
| PHF Adj:                  | 1.00                         | 1.00 | 1.00 | 1.00        | 1.00 | 1.00 | 1.00       | 1.00 | 1.00 | 1.00       | 1.00 | 1.00 |
| PHF Volume:               | 266                          | 2737 | 0    | 1           | 610  | 73   | 115        | 0    | 201  | 0          | 0    | 0    |
| Reduct Vol:               | 0                            | 0    | 0    | 0           | 0    | 0    | 0          | 0    | 0    | 0          | 0    | 0    |
| Reduced Vol:              | 266                          | 2737 | 0    | 1           | 610  | 73   | 115        | 0    | 201  | 0          | 0    | 0    |
| PCE Adj:                  | 1.00                         | 1.00 | 1.00 | 1.00        | 1.00 | 1.00 | 1.00       | 1.00 | 1.00 | 1.00       | 1.00 | 1.00 |
| MLF Adj:                  | 1.00                         | 1.00 | 1.00 | 1.00        | 1.00 | 1.00 | 1.00       | 1.00 | 1.00 | 1.00       | 1.00 | 1.00 |
| Final Volume:             | 266                          | 2737 | 0    | 1           | 610  | 73   | 115        | 0    | 201  | 0          | 0    | 0    |
| -----                     |                              |      |      |             |      |      |            |      |      |            |      |      |
| Saturation Flow Module:   |                              |      |      |             |      |      |            |      |      |            |      |      |
| Sat/Lane:                 | 1900                         | 1900 | 1900 | 1900        | 1900 | 1900 | 1900       | 1900 | 1900 | 1900       | 1900 | 1900 |
| Adjustment:               | 0.83                         | 1.00 | 0.92 | 0.92        | 0.99 | 0.95 | 0.92       | 1.00 | 0.83 | 0.92       | 1.00 | 0.92 |
| Lanes:                    | 2.00                         | 3.00 | 0.00 | 1.00        | 2.67 | 0.33 | 1.00       | 0.00 | 2.00 | 0.00       | 0.00 | 0.00 |
| Final Sat.:               | 3150                         | 5700 | 0    | 1750        | 5001 | 598  | 1750       | 0    | 3150 | 0          | 0    | 0    |
| -----                     |                              |      |      |             |      |      |            |      |      |            |      |      |
| Capacity Analysis Module: |                              |      |      |             |      |      |            |      |      |            |      |      |
| Vol/Sat:                  | 0.08                         | 0.48 | 0.00 | 0.00        | 0.12 | 0.12 | 0.07       | 0.00 | 0.06 | 0.00       | 0.00 | 0.00 |
| Crit Moves:               | ****                         | **** | **** | ****        | **** | **** | ****       | **** | **** | ****       | **** | **** |
| Green Time:               | 47.5                         | 109  | 0.0  | 7.0         | 68.6 | 68.6 | 14.9       | 0.0  | 62.4 | 0.0        | 0.0  | 0.0  |
| Volume/Cap:               | 0.25                         | 0.62 | 0.00 | 0.01        | 0.25 | 0.25 | 0.62       | 0.00 | 0.14 | 0.00       | 0.00 | 0.00 |
| Delay/Veh:                | 33.5                         | 6.8  | 0.0  | 63.3        | 20.8 | 20.8 | 65.9       | 0.0  | 23.0 | 0.0        | 0.0  | 0.0  |
| User DelAdj:              | 1.00                         | 1.00 | 1.00 | 1.00        | 1.00 | 1.00 | 1.00       | 1.00 | 1.00 | 1.00       | 1.00 | 1.00 |
| AdjDel/Veh:               | 33.5                         | 6.8  | 0.0  | 63.3        | 20.8 | 20.8 | 65.9       | 0.0  | 23.0 | 0.0        | 0.0  | 0.0  |
| LOS by Move:              | C                            | A    | A    | E           | C    | C    | E          | A    | C    | C          | A    | A    |
| HCM2k95thQ:               | 9                            | 29   | 0    | 0           | 11   | 11   | 12         | 0    | 6    | 0          | 0    | 0    |

Note: Queue reported is the number of cars per lane.

BART

Level Of Service Computation Report  
 2000 HCM Operations (Future Volume Alternative)  
 PM - Exist + Proj Conditions

Intersection #4047: COLEMAN/NEWHALL [Study Int 35]

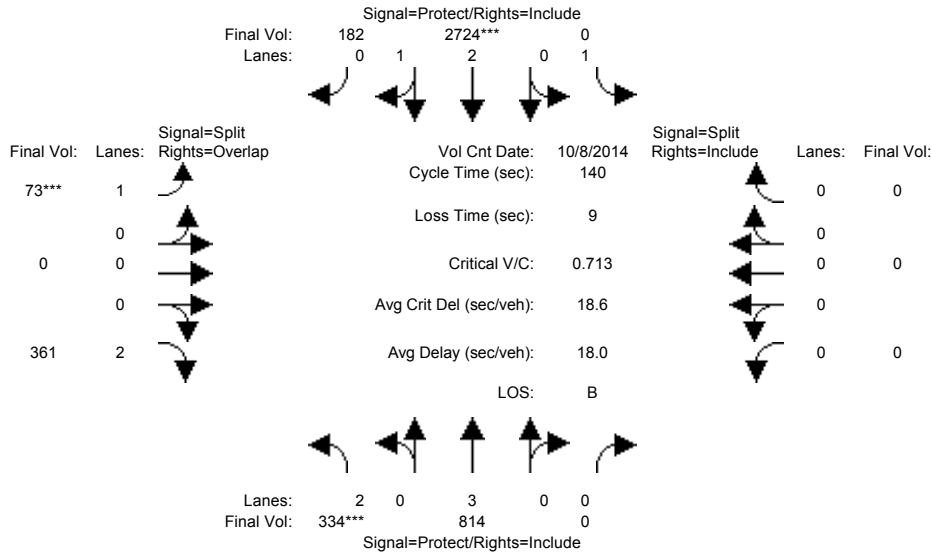

| Approach:   | North Bound |      |      | South Bound |      |       | East Bound |      |      | West Bound |      |      |
|---|-------------|------|------|-------------|------|-------|------------|------|------|------------|------|------|
| Movement:   | L           | T    | R    | L           | T    | R     | L          | T    | R    | L          | T    | R    |
| Min. Green:   | 7           | 10   | 0    | 7           | 10   | 10    | 10         | 0    | 10   | 0          | 0    | 0    |
| Y+R:  | 4.0         | 4.0  | 4.0  | 4.0         | 4.0  | 4.0   | 4.0        | 4.0  | 4.0  | 4.0        | 4.0  | 4.0  |
| ----- ----- ----- ----- ----- ----- ----- ----- ----- ----- ----- ----- ----- |             |      |      |             |      |       |            |      |      |            |      |      |
| Volume Module: >> Count Date: 8 Oct 2014 <<                                   |             |      |      |             |      |       |            |      |      |            |      |      |
| Base Vol:   | 334         | 814  | 0    | 0           | 2724 | 182   | 73         | 0    | 361  | 0          | 0    | 0    |
| Growth Adj:   | 1.00        | 1.00 | 1.00 | 1.00        | 1.00 | 1.00  | 1.00       | 1.00 | 1.00 | 1.00       | 1.00 | 1.00 |
| Initial Bse:  | 334         | 814  | 0    | 0           | 2724 | 182   | 73         | 0    | 361  | 0          | 0    | 0    |
| Added Vol:  | 0           | 0    | 0    | 0           | 0    | 0     | 0          | 0    | 0    | 0          | 0    | 0    |
| PasserByVol:  | 0           | 0    | 0    | 0           | 0    | 0     | 0          | 0    | 0    | 0          | 0    | 0    |
| Initial Fut:  | 334         | 814  | 0    | 0           | 2724 | 182   | 73         | 0    | 361  | 0          | 0    | 0    |
| User Adj:   | 1.00        | 1.00 | 1.00 | 1.00        | 1.00 | 1.00  | 1.00       | 1.00 | 1.00 | 1.00       | 1.00 | 1.00 |
| PHF Adj:  | 1.00        | 1.00 | 1.00 | 1.00        | 1.00 | 1.00  | 1.00       | 1.00 | 1.00 | 1.00       | 1.00 | 1.00 |
| PHF Volume:   | 334         | 814  | 0    | 0           | 2724 | 182   | 73         | 0    | 361  | 0          | 0    | 0    |
| Reduct Vol:   | 0           | 0    | 0    | 0           | 0    | 0     | 0          | 0    | 0    | 0          | 0    | 0    |
| Reduced Vol:  | 334         | 814  | 0    | 0           | 2724 | 182   | 73         | 0    | 361  | 0          | 0    | 0    |
| PCE Adj:  | 1.00        | 1.00 | 1.00 | 1.00        | 1.00 | 1.00  | 1.00       | 1.00 | 1.00 | 1.00       | 1.00 | 1.00 |
| MLF Adj:  | 1.00        | 1.00 | 1.00 | 1.00        | 1.00 | 1.00  | 1.00       | 1.00 | 1.00 | 1.00       | 1.00 | 1.00 |
| FinalVolume:  | 334         | 814  | 0    | 0           | 2724 | 182   | 73         | 0    | 361  | 0          | 0    | 0    |
| ----- ----- ----- ----- ----- ----- ----- ----- ----- ----- ----- -----       |             |      |      |             |      |       |            |      |      |            |      |      |
| Saturation Flow Module:   |             |      |      |             |      |       |            |      |      |            |      |      |
| Sat/Lane:   | 1900        | 1900 | 1900 | 1900        | 1900 | 1900  | 1900       | 1900 | 1900 | 1900       | 1900 | 1900 |
| Adjustment:   | 0.83        | 1.00 | 0.92 | 0.92        | 0.98 | 0.95  | 0.92       | 1.00 | 0.83 | 0.92       | 1.00 | 0.92 |
| Lanes:  | 2.00        | 3.00 | 0.00 | 1.00        | 2.81 | 0.19  | 1.00       | 0.00 | 2.00 | 0.00       | 0.00 | 0.00 |
| Final Sat.:   | 3150        | 5700 | 0    | 1750        | 5249 | 351   | 1750       | 0    | 3150 | 0          | 0    | 0    |
| ----- ----- ----- ----- ----- ----- ----- ----- ----- ----- ----- -----       |             |      |      |             |      |       |            |      |      |            |      |      |
| Capacity Analysis Module:   |             |      |      |             |      |       |            |      |      |            |      |      |
| Vol/Sat:  | 0.11        | 0.14 | 0.00 | 0.00        | 0.52 | 0.52  | 0.04       | 0.00 | 0.11 | 0.00       | 0.00 | 0.00 |
| Crit Moves:   | ****        |      |      | ****        |      |       | ****       |      |      |            |      |      |
| Green Time:   | 20.5        | 121  | 0.0  | 0.0         | 100  | 100.5 | 10.0       | 0.0  | 30.5 | 0.0        | 0.0  | 0.0  |
| Volume/Cap:   | 0.72        | 0.17 | 0.00 | 0.00        | 0.72 | 0.72  | 0.58       | 0.00 | 0.53 | 0.00       | 0.00 | 0.00 |
| Delay/Veh:  | 62.6        | 1.5  | 0.0  | 0.0         | 12.3 | 12.3  | 69.9       | 0.0  | 49.1 | 0.0        | 0.0  | 0.0  |
| User DelAdj:  | 1.00        | 1.00 | 1.00 | 1.00        | 1.00 | 1.00  | 1.00       | 1.00 | 1.00 | 1.00       | 1.00 | 1.00 |
| AdjDel/Veh:   | 62.6        | 1.5  | 0.0  | 0.0         | 12.3 | 12.3  | 69.9       | 0.0  | 49.1 | 0.0        | 0.0  | 0.0  |
| LOS by Move:  | E           | A    | A    | A           | B    | B     | E          | A    | D    | A          | A    | A    |
| HCM2k95thQ:   | 18          | 4    | 0    | 0           | 40   | 40    | 8          | 0    | 16   | 0          | 0    | 0    |

Note: Queue reported is the number of cars per lane.

BART

Level Of Service Computation Report  
 2000 HCM Operations (Future Volume Alternative)  
 AM - Exist + Proj Conditions

Intersection #4069: 101/Trimble [Study Int 62]

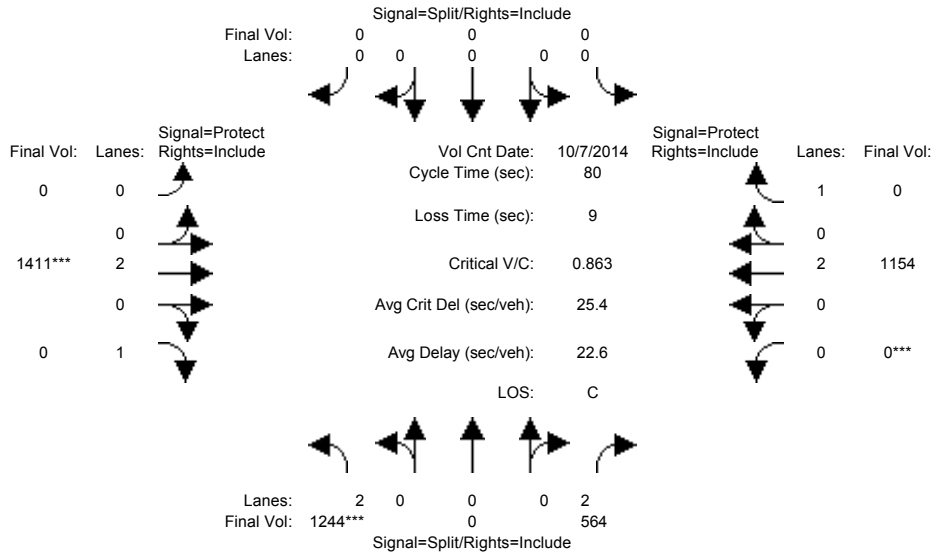

| Approach:   | North Bound |      |      | South Bound |      |      | East Bound |      |      | West Bound |      |      |
|---|-------------|------|------|-------------|------|------|------------|------|------|------------|------|------|
| Movement:   | L           | T    | R    | L           | T    | R    | L          | T    | R    | L          | T    | R    |
| Min. Green:   | 10          | 0    | 10   | 0           | 0    | 0    | 0          | 10   | 10   | 0          | 10   | 10   |
| Y+R:  | 4.0         | 4.0  | 4.0  | 4.0         | 4.0  | 4.0  | 4.0        | 4.0  | 4.0  | 4.0        | 4.0  | 4.0  |
| Volume Module: >> Count Date: 7 Oct 2014 << 7:55-8:55AM |             |      |      |             |      |      |            |      |      |            |      |      |
| Base Vol:   | 1244        | 0    | 564  | 0           | 0    | 0    | 0          | 1411 | 397  | 0          | 1154 | 320  |
| Growth Adj:   | 1.00        | 1.00 | 1.00 | 1.00        | 1.00 | 1.00 | 1.00       | 1.00 | 1.00 | 1.00       | 1.00 | 1.00 |
| Initial Bse:  | 1244        | 0    | 564  | 0           | 0    | 0    | 0          | 1411 | 397  | 0          | 1154 | 320  |
| Added Vol:  | 0           | 0    | 0    | 0           | 0    | 0    | 0          | 0    | 0    | 0          | 0    | 0    |
| PasserByVol:  | 0           | 0    | 0    | 0           | 0    | 0    | 0          | 0    | 0    | 0          | 0    | 0    |
| Initial Fut:  | 1244        | 0    | 564  | 0           | 0    | 0    | 0          | 1411 | 397  | 0          | 1154 | 320  |
| User Adj:   | 1.00        | 1.00 | 1.00 | 1.00        | 1.00 | 1.00 | 1.00       | 1.00 | 0.00 | 1.00       | 1.00 | 0.00 |
| PHF Adj:  | 1.00        | 1.00 | 1.00 | 1.00        | 1.00 | 1.00 | 1.00       | 1.00 | 1.00 | 1.00       | 1.00 | 1.00 |
| PHF Volume:   | 1244        | 0    | 564  | 0           | 0    | 0    | 0          | 1411 | 0    | 0          | 1154 | 0    |
| Reduct Vol:   | 0           | 0    | 0    | 0           | 0    | 0    | 0          | 0    | 0    | 0          | 0    | 0    |
| Reduced Vol:  | 1244        | 0    | 564  | 0           | 0    | 0    | 0          | 1411 | 0    | 0          | 1154 | 0    |
| PCE Adj:  | 1.00        | 1.00 | 1.00 | 1.00        | 1.00 | 1.00 | 1.00       | 1.00 | 1.00 | 1.00       | 1.00 | 1.00 |
| MLF Adj:  | 1.00        | 1.00 | 1.00 | 1.00        | 1.00 | 1.00 | 1.00       | 1.00 | 1.00 | 1.00       | 1.00 | 1.00 |
| FinalVolume:  | 1244        | 0    | 564  | 0           | 0    | 0    | 0          | 1411 | 0    | 0          | 1154 | 0    |
| Saturation Flow Module:                                 |             |      |      |             |      |      |            |      |      |            |      |      |
| Sat/Lane:   | 1900        | 1900 | 1900 | 1900        | 1900 | 1900 | 1900       | 1900 | 1900 | 1900       | 1900 | 1900 |
| Adjustment:   | 0.83        | 1.00 | 0.83 | 0.92        | 1.00 | 0.92 | 0.92       | 1.00 | 0.92 | 0.92       | 1.00 | 0.92 |
| Lanes:  | 2.00        | 0.00 | 2.00 | 0.00        | 0.00 | 0.00 | 0.00       | 2.00 | 1.00 | 0.00       | 2.00 | 1.00 |
| Final Sat.:   | 3150        | 0    | 3150 | 0           | 0    | 0    | 0          | 3800 | 1750 | 0          | 3800 | 1750 |
| Capacity Analysis Module:                               |             |      |      |             |      |      |            |      |      |            |      |      |
| Vol/Sat:  | 0.39        | 0.00 | 0.18 | 0.00        | 0.00 | 0.00 | 0.00       | 0.37 | 0.00 | 0.00       | 0.30 | 0.00 |
| Crit Moves:   | ****        |      |      |             |      |      |            | **** |      |            | **** |      |
| Green Time:   | 36.6        | 0.0  | 36.6 | 0.0         | 0.0  | 0.0  | 0.0        | 34.4 | 0.0  | 0.0        | 34.4 | 0.0  |
| Volume/Cap:   | 0.86        | 0.00 | 0.39 | 0.00        | 0.00 | 0.00 | 0.00       | 0.86 | 0.00 | 0.00       | 0.71 | 0.00 |
| Delay/Veh:  | 25.1        | 0.0  | 14.5 | 0.0         | 0.0  | 0.0  | 0.0        | 25.7 | 0.0  | 0.0        | 20.1 | 0.0  |
| User DelAdj:  | 1.00        | 1.00 | 1.00 | 1.00        | 1.00 | 1.00 | 1.00       | 1.00 | 1.00 | 1.00       | 1.00 | 1.00 |
| AdjDel/Veh:   | 25.1        | 0.0  | 14.5 | 0.0         | 0.0  | 0.0  | 0.0        | 25.7 | 0.0  | 0.0        | 20.1 | 0.0  |
| LOS by Move:  | C           | A    | B    | A           | A    | A    | A          | C    | A    | A          | C    | A    |
| HCM2k95thQ:   | 34          | 0    | 11   | 0           | 0    | 0    | 0          | 30   | 0    | 0          | 23   | 0    |

Note: Queue reported is the number of cars per lane.

BART

Level Of Service Computation Report  
 2000 HCM Operations (Future Volume Alternative)  
 PM - Exist + Proj Conditions

Intersection #4069: 101/Trimble [Study Int 62]

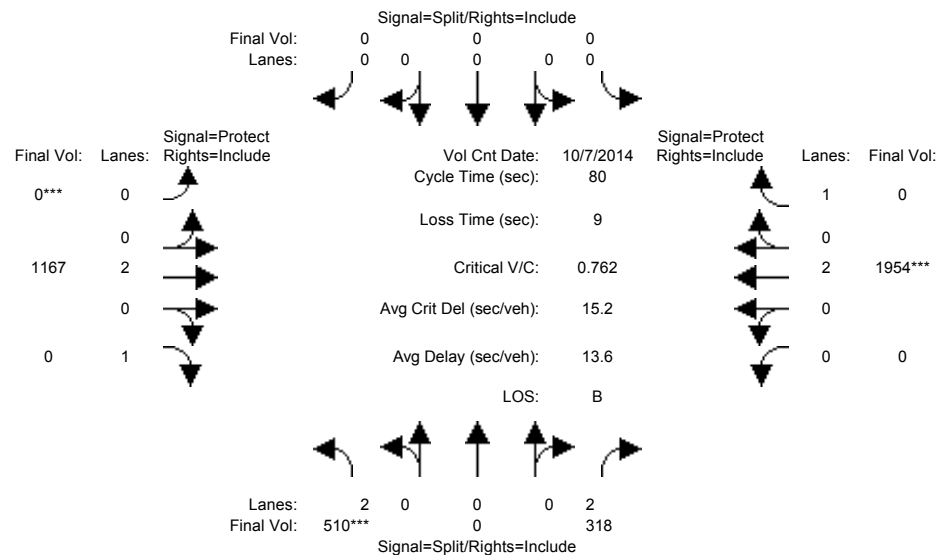

| Approach:   | North Bound |      |      | South Bound |      |      | East Bound |      |      | West Bound |      |      |
|---|-------------|------|------|-------------|------|------|------------|------|------|------------|------|------|
| Movement:   | L           | T    | R    | L           | T    | R    | L          | T    | R    | L          | T    | R    |
| Min. Green:   | 10          | 0    | 10   | 0           | 0    | 0    | 0          | 10   | 10   | 0          | 10   | 10   |
| Y+R:  | 4.0         | 4.0  | 4.0  | 4.0         | 4.0  | 4.0  | 4.0        | 4.0  | 4.0  | 4.0        | 4.0  | 4.0  |
| Volume Module: >> Count Date: 7 Oct 2014 << 5:00-6:00PM |             |      |      |             |      |      |            |      |      |            |      |      |
| Base Vol:   | 510         | 0    | 318  | 0           | 0    | 0    | 0          | 1167 | 205  | 0          | 1954 | 735  |
| Growth Adj:   | 1.00        | 1.00 | 1.00 | 1.00        | 1.00 | 1.00 | 1.00       | 1.00 | 1.00 | 1.00       | 1.00 | 1.00 |
| Initial Bse:  | 510         | 0    | 318  | 0           | 0    | 0    | 0          | 1167 | 205  | 0          | 1954 | 735  |
| Added Vol:  | 0           | 0    | 0    | 0           | 0    | 0    | 0          | 0    | 0    | 0          | 0    | 0    |
| PasserByVol:  | 0           | 0    | 0    | 0           | 0    | 0    | 0          | 0    | 0    | 0          | 0    | 0    |
| Initial Fut:  | 510         | 0    | 318  | 0           | 0    | 0    | 0          | 1167 | 205  | 0          | 1954 | 735  |
| User Adj:   | 1.00        | 1.00 | 1.00 | 1.00        | 1.00 | 1.00 | 1.00       | 1.00 | 0.00 | 1.00       | 1.00 | 0.00 |
| PHF Adj:  | 1.00        | 1.00 | 1.00 | 1.00        | 1.00 | 1.00 | 1.00       | 1.00 | 1.00 | 1.00       | 1.00 | 1.00 |
| PHF Volume:   | 510         | 0    | 318  | 0           | 0    | 0    | 0          | 1167 | 0    | 0          | 1954 | 0    |
| Reduct Vol:   | 0           | 0    | 0    | 0           | 0    | 0    | 0          | 0    | 0    | 0          | 0    | 0    |
| Reduced Vol:  | 510         | 0    | 318  | 0           | 0    | 0    | 0          | 1167 | 0    | 0          | 1954 | 0    |
| PCE Adj:  | 1.00        | 1.00 | 1.00 | 1.00        | 1.00 | 1.00 | 1.00       | 1.00 | 1.00 | 1.00       | 1.00 | 1.00 |
| MLF Adj:  | 1.00        | 1.00 | 1.00 | 1.00        | 1.00 | 1.00 | 1.00       | 1.00 | 1.00 | 1.00       | 1.00 | 1.00 |
| FinalVolume:  | 510         | 0    | 318  | 0           | 0    | 0    | 0          | 1167 | 0    | 0          | 1954 | 0    |
| Saturation Flow Module:                                 |             |      |      |             |      |      |            |      |      |            |      |      |
| Sat/Lane:   | 1900        | 1900 | 1900 | 1900        | 1900 | 1900 | 1900       | 1900 | 1900 | 1900       | 1900 | 1900 |
| Adjustment:   | 0.83        | 1.00 | 0.83 | 0.92        | 1.00 | 0.92 | 0.92       | 1.00 | 0.92 | 0.92       | 1.00 | 0.92 |
| Lanes:  | 2.00        | 0.00 | 2.00 | 0.00        | 0.00 | 0.00 | 0.00       | 2.00 | 1.00 | 0.00       | 2.00 | 1.00 |
| Final Sat.:   | 3150        | 0    | 3150 | 0           | 0    | 0    | 0          | 3800 | 1750 | 0          | 3800 | 1750 |
| Capacity Analysis Module:                               |             |      |      |             |      |      |            |      |      |            |      |      |
| Vol/Sat:  | 0.16        | 0.00 | 0.10 | 0.00        | 0.00 | 0.00 | 0.00       | 0.31 | 0.00 | 0.00       | 0.51 | 0.00 |
| Crit Moves:   | ****        |      |      |             |      |      | ****       |      |      | ****       |      |      |
| Green Time:   | 17.0        | 0.0  | 17.0 | 0.0         | 0.0  | 0.0  | 0.0        | 54.0 | 0.0  | 0.0        | 54.0 | 0.0  |
| Volume/Cap:   | 0.76        | 0.00 | 0.48 | 0.00        | 0.00 | 0.00 | 0.00       | 0.45 | 0.00 | 0.00       | 0.76 | 0.00 |
| Delay/Veh:  | 34.7        | 0.0  | 28.1 | 0.0         | 0.0  | 0.0  | 0.0        | 6.2  | 0.0  | 0.0        | 10.1 | 0.0  |
| User DelAdj:  | 1.00        | 1.00 | 1.00 | 1.00        | 1.00 | 1.00 | 1.00       | 1.00 | 1.00 | 1.00       | 1.00 | 1.00 |
| AdjDel/Veh:   | 34.7        | 0.0  | 28.1 | 0.0         | 0.0  | 0.0  | 0.0        | 6.2  | 0.0  | 0.0        | 10.1 | 0.0  |
| LOS by Move:  | C           | A    | C    | A           | A    | A    | A          | A    | A    | A          | B    | A    |
| HCM2k95thQ:   | 17          | 0    | 9    | 0           | 0    | 0    | 0          | 13   | 0    | 0          | 30   | 0    |

Note: Queue reported is the number of cars per lane.

BART

Level Of Service Computation Report  
2000 HCM Operations (Future Volume Alternative)  
AM - Exist + Proj Conditions

Intersection #5332: CENTRAL EXPWY/SCOTT BLVD [Study Int 28]

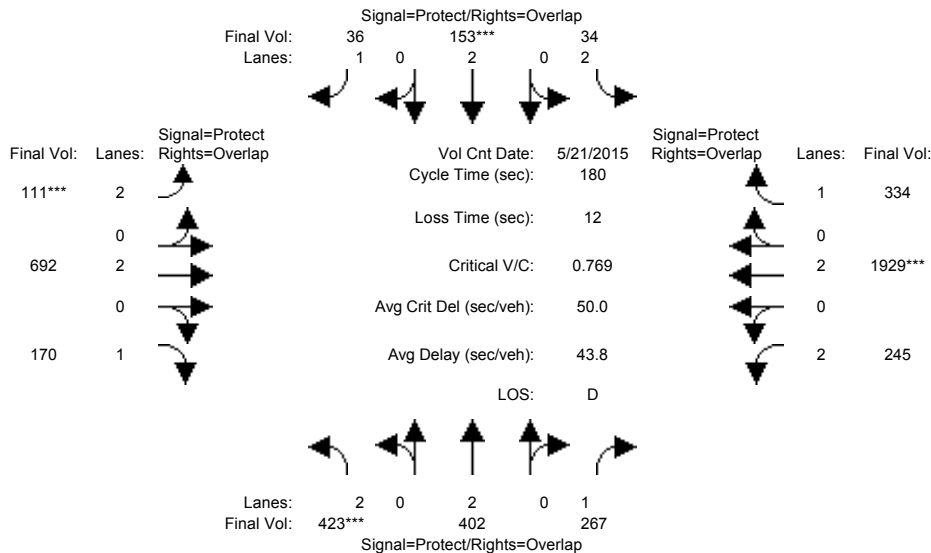

| Approach:  | North Bound |      |      | South Bound |      |      | East Bound |      |       | West Bound |      |       |
|--|-------------|------|------|-------------|------|------|------------|------|-------|------------|------|-------|
| Movement:  | L           | T    | R    | L           | T    | R    | L          | T    | R     | L          | T    | R     |
| Min. Green:  | 14          | 10   | 10   | 14          | 10   | 10   | 14         | 10   | 10    | 14         | 90   | 10    |
| Y+R:   | 4.0         | 4.0  | 4.0  | 4.0         | 4.0  | 4.0  | 4.0        | 4.0  | 4.0   | 4.0        | 4.0  | 4.0   |
| Volume Module: >> Count Date: 21 May 2015 << 5:00-6:00PM |             |      |      |             |      |      |            |      |       |            |      |       |
| Base Vol:  | 423         | 402  | 267  | 34          | 153  | 36   | 111        | 795  | 170   | 245        | 2167 | 334   |
| Growth Adj:  | 1.00        | 1.00 | 1.00 | 1.00        | 1.00 | 1.00 | 1.00       | 1.00 | 1.00  | 1.00       | 1.00 | 1.00  |
| Initial Bse:   | 423         | 402  | 267  | 34          | 153  | 36   | 111        | 795  | 170   | 245        | 2167 | 334   |
| Added Vol:   | 0           | 0    | 0    | 0           | 0    | 0    | 0          | 0    | 0     | 0          | 0    | 0     |
| PasserByVol:   | 0           | 0    | 0    | 0           | 0    | 0    | 0          | 0    | 0     | 0          | 0    | 0     |
| Initial Fut:   | 423         | 402  | 267  | 34          | 153  | 36   | 111        | 795  | 170   | 245        | 2167 | 334   |
| User Adj:  | 1.00        | 1.00 | 1.00 | 1.00        | 1.00 | 1.00 | 1.00       | 0.87 | 1.00  | 1.00       | 0.89 | 1.00  |
| PHF Adj:   | 1.00        | 1.00 | 1.00 | 1.00        | 1.00 | 1.00 | 1.00       | 1.00 | 1.00  | 1.00       | 1.00 | 1.00  |
| PHF Volume:  | 423         | 402  | 267  | 34          | 153  | 36   | 111        | 692  | 170   | 245        | 1929 | 334   |
| Reduct Vol:  | 0           | 0    | 0    | 0           | 0    | 0    | 0          | 0    | 0     | 0          | 0    | 0     |
| Reduced Vol:   | 423         | 402  | 267  | 34          | 153  | 36   | 111        | 692  | 170   | 245        | 1929 | 334   |
| PCE Adj:   | 1.00        | 1.00 | 1.00 | 1.00        | 1.00 | 1.00 | 1.00       | 1.00 | 1.00  | 1.00       | 1.00 | 1.00  |
| MLF Adj:   | 1.00        | 1.00 | 1.00 | 1.00        | 1.00 | 1.00 | 1.00       | 1.00 | 1.00  | 1.00       | 1.00 | 1.00  |
| Final Volume:  | 423         | 402  | 267  | 34          | 153  | 36   | 111        | 692  | 170   | 245        | 1929 | 334   |
| Saturation Flow Module:                                  |             |      |      |             |      |      |            |      |       |            |      |       |
| Sat/Lane:  | 1900        | 1900 | 1900 | 1900        | 1900 | 1900 | 1900       | 1900 | 1900  | 1900       | 1900 | 1900  |
| Adjustment:  | 0.83        | 1.00 | 0.92 | 0.83        | 1.00 | 0.92 | 0.83       | 1.00 | 0.92  | 0.83       | 1.00 | 0.92  |
| Lanes:   | 2.00        | 2.00 | 1.00 | 2.00        | 2.00 | 1.00 | 2.00       | 2.00 | 1.00  | 2.00       | 2.00 | 1.00  |
| Final Sat.:  | 3150        | 3800 | 1750 | 3150        | 3800 | 1750 | 3150       | 3800 | 1750  | 3150       | 3800 | 1750  |
| Capacity Analysis Module:                                |             |      |      |             |      |      |            |      |       |            |      |       |
| Vol/Sat:   | 0.13        | 0.11 | 0.15 | 0.01        | 0.04 | 0.02 | 0.04       | 0.18 | 0.10  | 0.08       | 0.51 | 0.19  |
| Crit Moves:  | ****        |      |      | ****        |      |      | ****       |      |       | ****       |      |       |
| Green Time:  | 30.1        | 23.1 | 61.4 | 17.0        | 10.0 | 24.0 | 14.0       | 89.6 | 119.7 | 38.3       | 114  | 130.9 |
| Volume/Cap:  | 0.80        | 0.82 | 0.45 | 0.11        | 0.72 | 0.15 | 0.45       | 0.37 | 0.15  | 0.37       | 0.80 | 0.26  |
| Delay/Veh:   | 80.7        | 87.3 | 46.6 | 74.8        | 95.4 | 69.3 | 76.2       | 9.5  | 0.1   | 61.7       | 38.1 | 14.7  |
| User DelAdj:   | 1.00        | 1.00 | 1.00 | 1.00        | 1.00 | 1.00 | 1.00       | 1.00 | 1.00  | 1.00       | 1.00 | 1.00  |
| AdjDel/Veh:  | 80.7        | 87.3 | 46.6 | 74.8        | 95.4 | 69.3 | 76.2       | 9.5  | 0.1   | 61.7       | 38.1 | 14.7  |
| LOS by Move:   | F           | F    | D    | E           | F    | E    | E          | A    | A     | E          | D    | B     |
| HCM2k95thQ:  | 25          | 21   | 23   | 2           | 9    | 4    | 8          | 9    | 0     | 13         | 68   | 20    |

Note: Queue reported is the number of cars per lane.

BART

Level Of Service Computation Report  
2000 HCM Operations (Future Volume Alternative)  
PM - Exist + Proj Conditions

Intersection #5332: CENTRAL EXPWY/SCOTT BLVD [Study Int 28]

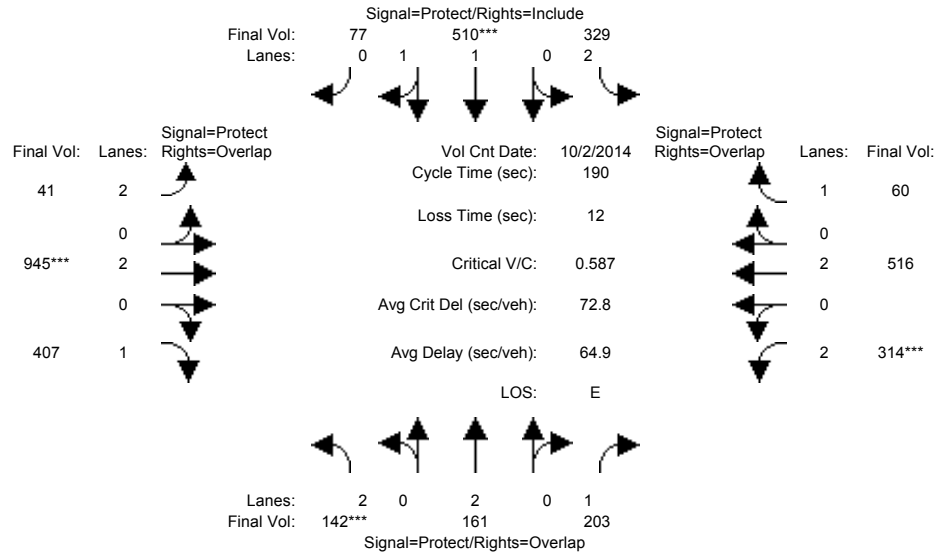

| Approach:   | North Bound |      |      | South Bound |      |       | East Bound |      |       | West Bound |      |       |
|---|-------------|------|------|-------------|------|-------|------------|------|-------|------------|------|-------|
| Movement:   | L           | T    | R    | L           | T    | R     | L          | T    | R     | L          | T    | R     |
| Min. Green:   | 28          | 42   | 42   | 20          | 34   | 34    | 19         | 105  | 105   | 23         | 109  | 109   |
| Y+R:  | 4.0         | 4.0  | 4.0  | 4.0         | 4.0  | 4.0   | 4.0        | 4.0  | 4.0   | 4.0        | 4.0  | 4.0   |
| Volume Module: >> Count Date: 2 Oct 2014 << 5:15-6:15PM |             |      |      |             |      |       |            |      |       |            |      |       |
| Base Vol:   | 142         | 161  | 203  | 329         | 510  | 77    | 41         | 1726 | 407   | 314        | 666  | 60    |
| Growth Adj:   | 1.00        | 1.00 | 1.00 | 1.00        | 1.00 | 1.00  | 1.00       | 0.74 | 1.00  | 1.00       | 0.88 | 1.00  |
| Initial Bse:  | 142         | 161  | 203  | 329         | 510  | 77    | 41         | 1277 | 407   | 314        | 586  | 60    |
| Added Vol:  | 0           | 0    | 0    | 0           | 0    | 0     | 0          | 0    | 0     | 0          | 0    | 0     |
| PasserByVol:  | 0           | 0    | 0    | 0           | 0    | 0     | 0          | 0    | 0     | 0          | 0    | 0     |
| Initial Fut:  | 142         | 161  | 203  | 329         | 510  | 77    | 41         | 1277 | 407   | 314        | 586  | 60    |
| User Adj:   | 1.00        | 1.00 | 1.00 | 1.00        | 1.00 | 1.00  | 1.00       | 0.74 | 1.00  | 1.00       | 0.88 | 1.00  |
| PHF Adj:  | 1.00        | 1.00 | 1.00 | 1.00        | 1.00 | 1.00  | 1.00       | 1.00 | 1.00  | 1.00       | 1.00 | 1.00  |
| PHF Volume:   | 142         | 161  | 203  | 329         | 510  | 77    | 41         | 945  | 407   | 314        | 516  | 60    |
| Reduct Vol:   | 0           | 0    | 0    | 0           | 0    | 0     | 0          | 0    | 0     | 0          | 0    | 0     |
| Reduced Vol:  | 142         | 161  | 203  | 329         | 510  | 77    | 41         | 945  | 407   | 314        | 516  | 60    |
| PCE Adj:  | 1.00        | 1.00 | 1.00 | 1.00        | 1.00 | 1.00  | 1.00       | 1.00 | 1.00  | 1.00       | 1.00 | 1.00  |
| MLF Adj:  | 1.00        | 1.00 | 1.00 | 1.00        | 1.00 | 1.00  | 1.00       | 1.00 | 1.00  | 1.00       | 1.00 | 1.00  |
| Final Volume:   | 142         | 161  | 203  | 329         | 510  | 77    | 41         | 945  | 407   | 314        | 516  | 60    |
| Saturation Flow Module:                                 |             |      |      |             |      |       |            |      |       |            |      |       |
| Sat/Lane:   | 1900        | 1900 | 1900 | 1900        | 1900 | 1900  | 1900       | 1900 | 1900  | 1900       | 1900 | 1900  |
| Adjustment:   | 0.83        | 1.00 | 0.92 | 0.83        | 0.98 | 0.95  | 0.83       | 1.00 | 0.92  | 0.83       | 1.00 | 0.92  |
| Lanes:  | 2.00        | 2.00 | 1.00 | 2.00        | 1.73 | 0.27  | 2.00       | 2.00 | 1.00  | 2.00       | 2.00 | 1.00  |
| Final Sat.:   | 3150        | 3800 | 1750 | 3150        | 3214 | 485   | 3150       | 3800 | 1750  | 3150       | 3800 | 1750  |
| Capacity Analysis Module:                               |             |      |      |             |      |       |            |      |       |            |      |       |
| Vol/Sat:  | 0.05        | 0.04 | 0.12 | 0.10        | 0.16 | 0.16  | 0.01       | 0.25 | 0.23  | 0.10       | 0.14 | 0.03  |
| Crit Moves:   | ****        |      |      | ****        |      |       | ****       |      |       | ****       |      |       |
| Green Time:   | 26.3        | 39.5 | 61.1 | 18.8        | 32.0 | 32.0  | 17.9       | 98.8 | 125.1 | 21.6       | 103  | 121.3 |
| Volume/Cap:   | 0.33        | 0.20 | 0.36 | 1.05        | 0.94 | 0.94  | 0.14       | 0.48 | 0.35  | 0.88       | 0.25 | 0.05  |
| Delay/Veh:  | 78.9        | 66.3 | 53.0 | 157.1       | 106  | 105.9 | 84.2       | 39.4 | 23.6  | 108.7      | 17.4 | 6.5   |
| User DelAdj:  | 1.00        | 1.00 | 1.00 | 1.00        | 1.00 | 1.00  | 1.00       | 1.00 | 1.00  | 1.00       | 1.00 | 1.00  |
| AdjDel/Veh:   | 78.9        | 66.3 | 53.0 | 157.1       | 106  | 105.9 | 84.2       | 39.4 | 23.6  | 108.7      | 17.4 | 6.5   |
| LOS by Move:  | E           | E    | D    | F           | F    | F     | F          | D    | C     | F          | B    | A     |
| HCM2k95thQ:   | 9           | 8    | 18   | 26          | 34   | 34    | 3          | 36   | 29    | 22         | 10   | 1     |

Note: Queue reported is the number of cars per lane.

BART

Level Of Service Computation Report  
 2000 HCM Operations (Future Volume Alternative)  
 AM - Exist + Proj Conditions

Intersection #5334: CENTRAL EXPWY/LAFAYETTE ST [Study Int 29]

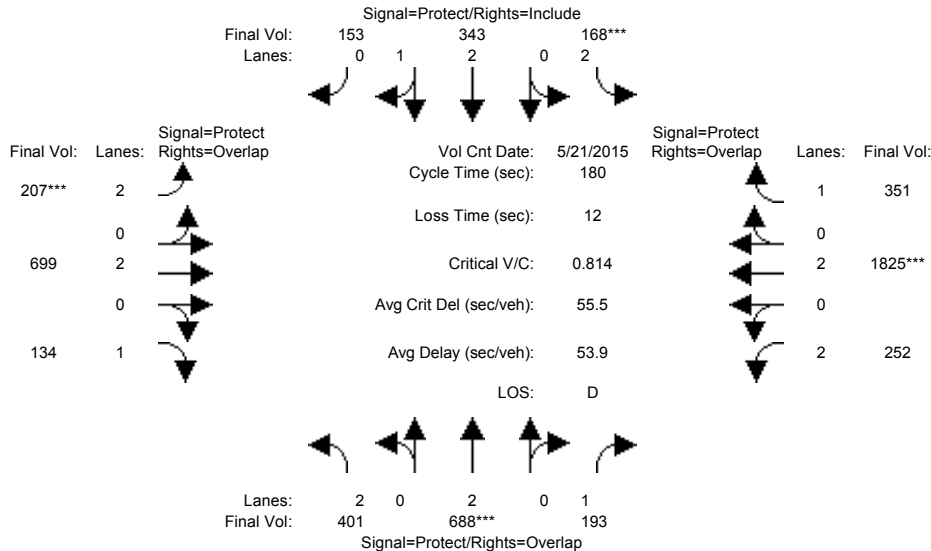

| Approach:  | North Bound |      |      | South Bound |      |      | East Bound |      |       | West Bound |      |       |
|--|-------------|------|------|-------------|------|------|------------|------|-------|------------|------|-------|
| Movement:  | L           | T    | R    | L           | T    | R    | L          | T    | R     | L          | T    | R     |
| Min. Green:  | 14          | 10   | 10   | 14          | 10   | 10   | 14         | 10   | 10    | 14         | 90   | 10    |
| Y+R:   | 4.0         | 4.0  | 4.0  | 4.0         | 4.0  | 4.0  | 4.0        | 4.0  | 4.0   | 4.0        | 4.0  | 4.0   |
| Volume Module: >> Count Date: 21 May 2015 << 7:00-9:00 |             |      |      |             |      |      |            |      |       |            |      |       |
| Base Vol:  | 401         | 688  | 193  | 168         | 343  | 153  | 207        | 803  | 134   | 252        | 2051 | 351   |
| Growth Adj:  | 1.00        | 1.00 | 1.00 | 1.00        | 1.00 | 1.00 | 1.00       | 1.00 | 1.00  | 1.00       | 1.00 | 1.00  |
| Initial Bse:   | 401         | 688  | 193  | 168         | 343  | 153  | 207        | 803  | 134   | 252        | 2051 | 351   |
| Added Vol:   | 0           | 0    | 0    | 0           | 0    | 0    | 0          | 0    | 0     | 0          | 0    | 0     |
| PasserByVol:   | 0           | 0    | 0    | 0           | 0    | 0    | 0          | 0    | 0     | 0          | 0    | 0     |
| Initial Fut:   | 401         | 688  | 193  | 168         | 343  | 153  | 207        | 803  | 134   | 252        | 2051 | 351   |
| User Adj:  | 1.00        | 1.00 | 1.00 | 1.00        | 1.00 | 1.00 | 1.00       | 0.87 | 1.00  | 1.00       | 0.89 | 1.00  |
| PHF Adj:   | 1.00        | 1.00 | 1.00 | 1.00        | 1.00 | 1.00 | 1.00       | 1.00 | 1.00  | 1.00       | 1.00 | 1.00  |
| PHF Volume:  | 401         | 688  | 193  | 168         | 343  | 153  | 207        | 699  | 134   | 252        | 1825 | 351   |
| Reduct Vol:  | 0           | 0    | 0    | 0           | 0    | 0    | 0          | 0    | 0     | 0          | 0    | 0     |
| Reduced Vol:   | 401         | 688  | 193  | 168         | 343  | 153  | 207        | 699  | 134   | 252        | 1825 | 351   |
| PCE Adj:   | 1.00        | 1.00 | 1.00 | 1.00        | 1.00 | 1.00 | 1.00       | 1.00 | 1.00  | 1.00       | 1.00 | 1.00  |
| MLF Adj:   | 1.00        | 1.00 | 1.00 | 1.00        | 1.00 | 1.00 | 1.00       | 1.00 | 1.00  | 1.00       | 1.00 | 1.00  |
| Final Volume:  | 401         | 688  | 193  | 168         | 343  | 153  | 207        | 699  | 134   | 252        | 1825 | 351   |
| Saturation Flow Module:                                |             |      |      |             |      |      |            |      |       |            |      |       |
| Sat/Lane:  | 1900        | 1900 | 1900 | 1900        | 1900 | 1900 | 1900       | 1900 | 1900  | 1900       | 1900 | 1900  |
| Adjustment:  | 1.00        | 1.00 | 1.00 | 1.00        | 1.00 | 1.00 | 1.00       | 0.85 | 1.00  | 1.00       | 1.00 | 1.00  |
| Lanes:   | 2.00        | 2.00 | 1.00 | 2.00        | 2.07 | 0.93 | 2.00       | 2.00 | 1.00  | 2.00       | 2.00 | 1.00  |
| Final Sat.:  | 3800        | 3800 | 1900 | 3800        | 3942 | 1758 | 3800       | 3230 | 1900  | 3800       | 3800 | 1900  |
| Capacity Analysis Module:                              |             |      |      |             |      |      |            |      |       |            |      |       |
| Vol/Sat:   | 0.11        | 0.18 | 0.10 | 0.04        | 0.09 | 0.09 | 0.05       | 0.22 | 0.07  | 0.07       | 0.48 | 0.18  |
| Crit Moves:  | ****        | **** | **** | ****        | **** | **** | ****       | **** | ****  | ****       | **** | ****  |
| Green Time:  | 28.7        | 38.3 | 68.9 | 14.0        | 23.6 | 23.6 | 14.0       | 85.1 | 113.8 | 30.6       | 102  | 115.7 |
| Volume/Cap:  | 0.66        | 0.85 | 0.27 | 0.57        | 0.66 | 0.66 | 0.70       | 0.46 | 0.11  | 0.39       | 0.85 | 0.29  |
| Delay/Veh:   | 82.8        | 88.9 | 54.1 | 87.2        | 84.1 | 84.1 | 88.3       | 32.2 | 13.2  | 66.8       | 36.2 | 14.2  |
| User DelAdj:   | 1.00        | 1.00 | 1.00 | 1.00        | 1.00 | 1.00 | 1.00       | 1.00 | 1.00  | 1.00       | 1.00 | 1.00  |
| AdjDel/Veh:  | 82.8        | 88.9 | 54.1 | 87.2        | 84.1 | 84.1 | 88.3       | 32.2 | 13.2  | 66.8       | 36.2 | 14.2  |
| LOS by Move:   | F           | F    | D    | F           | F    | F    | F          | C    | B     | E          | D    | B     |
| HCM2k95thQ:  | 19          | 33   | 17   | 9           | 17   | 17   | 11         | 22   | 6     | 12         | 72   | 22    |

Note: Queue reported is the number of cars per lane.



BART

Level Of Service Computation Report  
2000 HCM Operations (Future Volume Alternative)  
PM - Exist + Proj Conditions

Intersection #5334: CENTRAL EXPWY/LAFAYETTE ST [Study Int 29]

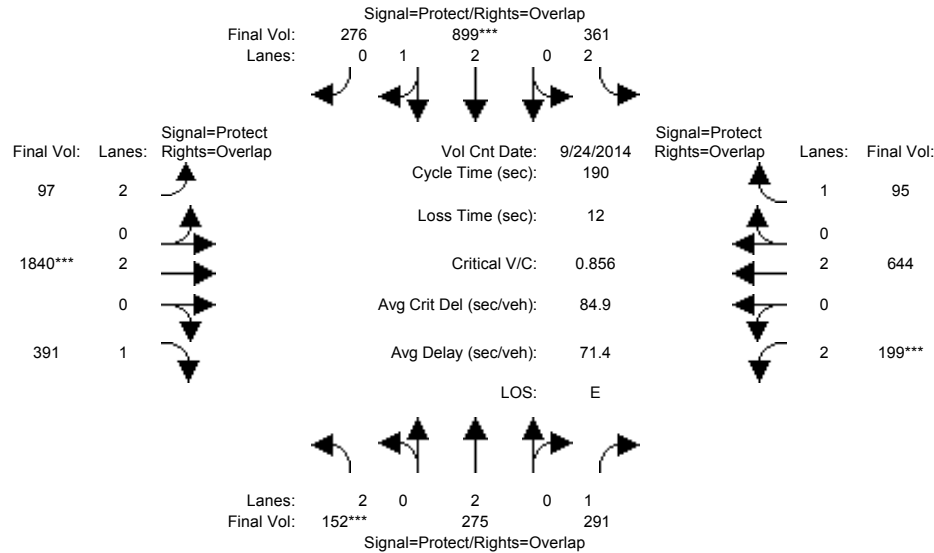

| Approach:                 | North Bound                            |      |      | South Bound |      |      | East Bound |      |       | West Bound |      |       |
|---------------------------|--|------|------|-------------|------|------|------------|------|-------|------------|------|-------|
| Movement:                 | L                                      | T    | R    | L           | T    | R    | L          | T    | R     | L          | T    | R     |
| Min. Green:               | 18                                     | 35   | 35   | 23          | 39   | 39   | 19         | 112  | 112   | 21         | 113  | 113   |
| Y+R:                      | 4.0                                    | 4.0  | 4.0  | 4.0         | 4.0  | 4.0  | 4.0        | 4.0  | 4.0   | 4.0        | 4.0  | 4.0   |
| Volume Module:            | Count Date: 24 Sep 2014 << 5:00-6:00PM |      |      |             |      |      |            |      |       |            |      |       |
| Base Vol:                 | 152                                    | 275  | 291  | 361         | 899  | 276  | 97         | 2487 | 391   | 199        | 732  | 95    |
| Growth Adj:               | 1.00                                   | 1.00 | 1.00 | 1.00        | 1.00 | 1.00 | 1.00       | 1.00 | 1.00  | 1.00       | 1.00 | 1.00  |
| Initial Bse:              | 152                                    | 275  | 291  | 361         | 899  | 276  | 97         | 2487 | 391   | 199        | 732  | 95    |
| Added Vol:                | 0                                      | 0    | 0    | 0           | 0    | 0    | 0          | 0    | 0     | 0          | 0    | 0     |
| PasserByVol:              | 0                                      | 0    | 0    | 0           | 0    | 0    | 0          | 0    | 0     | 0          | 0    | 0     |
| Initial Fut:              | 152                                    | 275  | 291  | 361         | 899  | 276  | 97         | 2487 | 391   | 199        | 732  | 95    |
| User Adj:                 | 1.00                                   | 1.00 | 1.00 | 1.00        | 1.00 | 1.00 | 1.00       | 0.74 | 1.00  | 1.00       | 0.88 | 1.00  |
| PHF Adj:                  | 1.00                                   | 1.00 | 1.00 | 1.00        | 1.00 | 1.00 | 1.00       | 1.00 | 1.00  | 1.00       | 1.00 | 1.00  |
| PHF Volume:               | 152                                    | 275  | 291  | 361         | 899  | 276  | 97         | 1840 | 391   | 199        | 644  | 95    |
| Reduct Vol:               | 0                                      | 0    | 0    | 0           | 0    | 0    | 0          | 0    | 0     | 0          | 0    | 0     |
| Reduced Vol:              | 152                                    | 275  | 291  | 361         | 899  | 276  | 97         | 1840 | 391   | 199        | 644  | 95    |
| PCE Adj:                  | 1.00                                   | 1.00 | 1.00 | 1.00        | 1.00 | 1.00 | 1.00       | 1.00 | 1.00  | 1.00       | 1.00 | 1.00  |
| MLF Adj:                  | 1.00                                   | 1.00 | 1.00 | 1.00        | 1.00 | 1.00 | 1.00       | 1.00 | 1.00  | 1.00       | 1.00 | 1.00  |
| Final Volume:             | 152                                    | 275  | 291  | 361         | 899  | 276  | 97         | 1840 | 391   | 199        | 644  | 95    |
| Saturation Flow Module:   |  |      |      |             |      |      |            |      |       |            |      |       |
| Sat/Lane:                 | 1900                                   | 1900 | 1900 | 1900        | 1900 | 1900 | 1900       | 1900 | 1900  | 1900       | 1900 | 1900  |
| Adjustment:               | 0.83                                   | 1.00 | 0.92 | 0.83        | 0.99 | 0.95 | 0.83       | 1.00 | 0.92  | 0.83       | 1.00 | 0.92  |
| Lanes:                    | 2.00                                   | 2.00 | 1.00 | 2.00        | 2.27 | 0.73 | 2.00       | 2.00 | 1.00  | 2.00       | 2.00 | 1.00  |
| Final Sat.:               | 3150                                   | 3800 | 1750 | 3150        | 4283 | 1315 | 3150       | 3800 | 1750  | 3150       | 3800 | 1750  |
| Capacity Analysis Module: |  |      |      |             |      |      |            |      |       |            |      |       |
| Vol/Sat:                  | 0.05                                   | 0.07 | 0.17 | 0.11        | 0.21 | 0.21 | 0.03       | 0.48 | 0.22  | 0.06       | 0.17 | 0.05  |
| Crit Moves:               | ****                                   | **** | **** | ****        | **** | **** | ****       | **** | ****  | ****       | **** | ****  |
| Green Time:               | 16.8                                   | 32.8 | 52.4 | 21.5        | 37.4 | 55.4 | 17.9       | 105  | 121.7 | 19.7       | 107  | 128.1 |
| Volume/Cap:               | 0.54                                   | 0.42 | 0.60 | 1.01        | 1.07 | 0.72 | 0.33       | 0.88 | 0.35  | 0.61       | 0.30 | 0.08  |
| Delay/Veh:                | 90.8                                   | 75.4 | 66.0 | 140.6       | 128  | 66.1 | 86.5       | 56.5 | 25.2  | 90.5       | 23.6 | 11.4  |
| User DelAdj:              | 1.00                                   | 1.00 | 1.00 | 1.00        | 1.00 | 1.00 | 1.00       | 1.00 | 1.00  | 1.00       | 1.00 | 1.00  |
| AdjDel/Veh:               | 90.8                                   | 75.4 | 66.0 | 140.6       | 128  | 66.1 | 86.5       | 56.5 | 25.2  | 90.5       | 23.6 | 11.4  |
| LOS by Move:              | F                                      | E    | E    | F           | F    | E    | F          | E    | C     | F          | C    | B     |
| HCM2k95thQ:               | 10                                     | 14   | 29   | 28          | 48   | 37   | 7          | 82   | 29    | 14         | 19   | 4     |

Note: Queue reported is the number of cars per lane.

BART

Level Of Service Computation Report  
 2000 HCM Operations (Future Volume Alternative)  
 AM - Exist + Proj Conditions

Intersection #5335: CENTRAL EXPWY/DE LA CRUZ BLVD [Study Int 30]

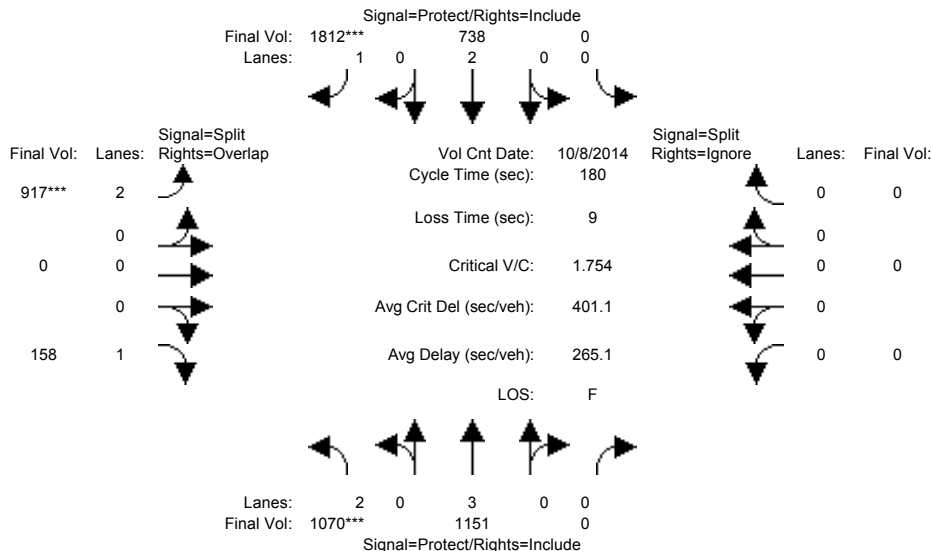

| Approach:                                   | North Bound |      |      | South Bound |      |       | East Bound |      |      | West Bound |      |      |
|---|-------------|------|------|-------------|------|-------|------------|------|------|------------|------|------|
| Movement:                                   | L           | T    | R    | L           | T    | R     | L          | T    | R    | L          | T    | R    |
| Min. Green:                                 | 7           | 10   | 0    | 0           | 10   | 10    | 10         | 0    | 10   | 0          | 0    | 0    |
| Y+R:  | 4.0         | 4.0  | 4.0  | 4.0         | 4.0  | 4.0   | 4.0        | 4.0  | 4.0  | 4.0        | 4.0  | 4.0  |
| Volume Module: >> Count Date: 8 Oct 2014 << |             |      |      |             |      |       |            |      |      |            |      |      |
| Base Vol:                                   | 1070        | 1151 | 0    | 0           | 738  | 1812  | 1054       | 0    | 158  | 0          | 0    | 0    |
| Growth Adj:                                 | 1.00        | 1.00 | 1.00 | 1.00        | 1.00 | 1.00  | 1.00       | 1.00 | 1.00 | 1.00       | 1.00 | 1.00 |
| Initial Bse:                                | 1070        | 1151 | 0    | 0           | 738  | 1812  | 1054       | 0    | 158  | 0          | 0    | 0    |
| Added Vol:                                  | 0           | 0    | 0    | 0           | 0    | 0     | 0          | 0    | 0    | 0          | 0    | 0    |
| PasserByVol:                                | 0           | 0    | 0    | 0           | 0    | 0     | 0          | 0    | 0    | 0          | 0    | 0    |
| Initial Fut:                                | 1070        | 1151 | 0    | 0           | 738  | 1812  | 1054       | 0    | 158  | 0          | 0    | 0    |
| User Adj:                                   | 1.00        | 1.00 | 1.00 | 1.00        | 1.00 | 1.00  | 0.87       | 1.00 | 1.00 | 1.00       | 1.00 | 0.00 |
| PHF Adj:                                    | 1.00        | 1.00 | 1.00 | 1.00        | 1.00 | 1.00  | 1.00       | 1.00 | 1.00 | 1.00       | 1.00 | 0.00 |
| PHF Volume:                                 | 1070        | 1151 | 0    | 0           | 738  | 1812  | 917        | 0    | 158  | 0          | 0    | 0    |
| Reduct Vol:                                 | 0           | 0    | 0    | 0           | 0    | 0     | 0          | 0    | 0    | 0          | 0    | 0    |
| Reduced Vol:                                | 1070        | 1151 | 0    | 0           | 738  | 1812  | 917        | 0    | 158  | 0          | 0    | 0    |
| PCE Adj:                                    | 1.00        | 1.00 | 1.00 | 1.00        | 1.00 | 1.00  | 1.00       | 1.00 | 1.00 | 1.00       | 1.00 | 0.00 |
| MLF Adj:                                    | 1.00        | 1.00 | 1.00 | 1.00        | 1.00 | 1.00  | 1.00       | 1.00 | 1.00 | 1.00       | 1.00 | 0.00 |
| Final Volume:                               | 1070        | 1151 | 0    | 0           | 738  | 1812  | 917        | 0    | 158  | 0          | 0    | 0    |
| Saturation Flow Module:                     |             |      |      |             |      |       |            |      |      |            |      |      |
| Sat/Lane:                                   | 1900        | 1900 | 1900 | 1900        | 1900 | 1900  | 1900       | 1900 | 1900 | 1900       | 1900 | 1900 |
| Adjustment:                                 | 0.83        | 1.00 | 0.92 | 0.92        | 1.00 | 0.92  | 0.83       | 1.00 | 0.92 | 0.92       | 1.00 | 0.92 |
| Lanes:                                      | 2.00        | 3.00 | 0.00 | 0.00        | 2.00 | 1.00  | 2.00       | 0.00 | 1.00 | 0.00       | 0.00 | 0.00 |
| Final Sat.:                                 | 3150        | 5700 | 0    | 0           | 3800 | 1750  | 3150       | 0    | 1750 | 0          | 0    | 0    |
| Capacity Analysis Module:                   |             |      |      |             |      |       |            |      |      |            |      |      |
| Vol/Sat:                                    | 0.34        | 0.20 | 0.00 | 0.00        | 0.19 | 1.04  | 0.29       | 0.00 | 0.09 | 0.00       | 0.00 | 0.00 |
| Crit Moves:                                 | ****        |      |      |             | **** | ****  | ****       |      |      |            |      |      |
| Green Time:                                 | 34.9        | 141  | 0.0  | 0.0         | 106  | 106.3 | 29.9       | 0.0  | 64.7 | 0.0        | 0.0  | 0.0  |
| Volume/Cap:                                 | 1.75        | 0.26 | 0.00 | 0.00        | 0.33 | 1.75  | 1.75       | 0.00 | 0.25 | 0.00       | 0.00 | 0.00 |
| Delay/Veh:                                  | 418.6       | 5.3  | 0.0  | 0.0         | 18.8 | 380.1 | 422.2      | 0.0  | 38.1 | 0.0        | 0.0  | 0.0  |
| User DelAdj:                                | 1.00        | 1.00 | 1.00 | 1.00        | 1.00 | 1.00  | 1.00       | 1.00 | 1.00 | 1.00       | 1.00 | 1.00 |
| AdjDel/Veh:                                 | 418.6       | 5.3  | 0.0  | 0.0         | 18.8 | 380.1 | 422.2      | 0.0  | 38.1 | 0.0        | 0.0  | 0.0  |
| LOS by Move:                                | F           | A    | A    | A           | B    | F     | F          | A    | D    | A          | A    | A    |
| HCM2k95thQ:                                 | 103         | 11   | 0    | 0           | 18   | 310   | 89         | 0    | 10   | 0          | 0    | 0    |

Note: Queue reported is the number of cars per lane.

BART

Level Of Service Computation Report  
2000 HCM Operations (Future Volume Alternative)  
PM - Exist + Proj Conditions

Intersection #5335: CENTRAL EXPWY/DE LA CRUZ BLVD [Study Int 30]

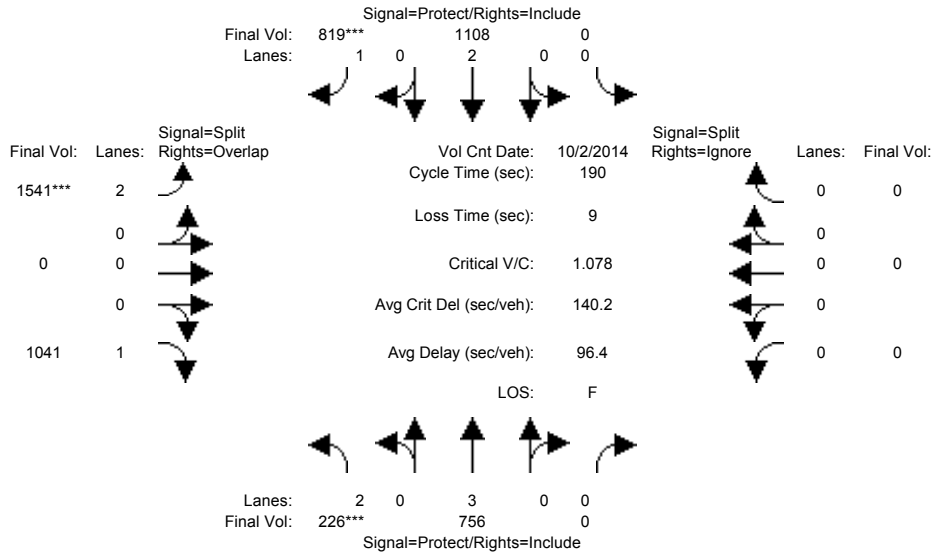

| Approach:                                   | North Bound |      |      | South Bound |      |       | East Bound |      |       | West Bound |      |      |
|---|-------------|------|------|-------------|------|-------|------------|------|-------|------------|------|------|
| Movement:                                   | L           | T    | R    | L           | T    | R     | L          | T    | R     | L          | T    | R    |
| Min. Green:                                 | 19          | 76   | 0    | 0           | 57   | 57    | 114        | 0    | 114   | 0          | 0    | 0    |
| Y+R:  | 4.0         | 4.0  | 4.0  | 4.0         | 4.0  | 4.0   | 4.0        | 4.0  | 4.0   | 4.0        | 4.0  | 4.0  |
| Volume Module: >> Count Date: 2 Oct 2014 << |             |      |      |             |      |       |            |      |       |            |      |      |
| Base Vol:                                   | 226         | 756  | 0    | 0           | 1108 | 819   | 2083       | 0    | 1041  | 0          | 0    | 0    |
| Growth Adj:                                 | 1.00        | 1.00 | 1.00 | 1.00        | 1.00 | 1.00  | 1.00       | 1.00 | 1.00  | 1.00       | 1.00 | 1.00 |
| Initial Bse:                                | 226         | 756  | 0    | 0           | 1108 | 819   | 2083       | 0    | 1041  | 0          | 0    | 0    |
| Added Vol:                                  | 0           | 0    | 0    | 0           | 0    | 0     | 0          | 0    | 0     | 0          | 0    | 0    |
| PasserByVol:                                | 0           | 0    | 0    | 0           | 0    | 0     | 0          | 0    | 0     | 0          | 0    | 0    |
| Initial Fut:                                | 226         | 756  | 0    | 0           | 1108 | 819   | 2083       | 0    | 1041  | 0          | 0    | 0    |
| User Adj:                                   | 1.00        | 1.00 | 1.00 | 1.00        | 1.00 | 1.00  | 0.74       | 1.00 | 1.00  | 1.00       | 1.00 | 0.00 |
| PHF Adj:                                    | 1.00        | 1.00 | 1.00 | 1.00        | 1.00 | 1.00  | 1.00       | 1.00 | 1.00  | 1.00       | 1.00 | 0.00 |
| PHF Volume:                                 | 226         | 756  | 0    | 0           | 1108 | 819   | 1541       | 0    | 1041  | 0          | 0    | 0    |
| Reduct Vol:                                 | 0           | 0    | 0    | 0           | 0    | 0     | 0          | 0    | 0     | 0          | 0    | 0    |
| Reduced Vol:                                | 226         | 756  | 0    | 0           | 1108 | 819   | 1541       | 0    | 1041  | 0          | 0    | 0    |
| PCE Adj:                                    | 1.00        | 1.00 | 1.00 | 1.00        | 1.00 | 1.00  | 1.00       | 1.00 | 1.00  | 1.00       | 1.00 | 0.00 |
| MLF Adj:                                    | 1.00        | 1.00 | 1.00 | 1.00        | 1.00 | 1.00  | 1.00       | 1.00 | 1.00  | 1.00       | 1.00 | 0.00 |
| Final Volume:                               | 226         | 756  | 0    | 0           | 1108 | 819   | 1541       | 0    | 1041  | 0          | 0    | 0    |
| Saturation Flow Module:                     |             |      |      |             |      |       |            |      |       |            |      |      |
| Sat/Lane:                                   | 1900        | 1900 | 1900 | 1900        | 1900 | 1900  | 1900       | 1900 | 1900  | 1900       | 1900 | 1900 |
| Adjustment:                                 | 0.83        | 1.00 | 0.92 | 0.92        | 1.00 | 0.92  | 0.83       | 1.00 | 0.92  | 0.92       | 1.00 | 0.92 |
| Lanes:                                      | 2.00        | 3.00 | 0.00 | 0.00        | 2.00 | 1.00  | 2.00       | 0.00 | 1.00  | 0.00       | 0.00 | 0.00 |
| Final Sat.:                                 | 3150        | 5700 | 0    | 0           | 3800 | 1750  | 3150       | 0    | 1750  | 0          | 0    | 0    |
| Capacity Analysis Module:                   |             |      |      |             |      |       |            |      |       |            |      |      |
| Vol/Sat:                                    | 0.07        | 0.13 | 0.00 | 0.00        | 0.29 | 0.47  | 0.49       | 0.00 | 0.59  | 0.00       | 0.00 | 0.00 |
| Crit Moves:                                 | ****        |      |      | ****        | **** | ****  | ****       |      |       |            |      |      |
| Green Time:                                 | 18.1        | 72.6 | 0.0  | 0.0         | 54.4 | 54.4  | 108.8      | 0.0  | 127.0 | 0.0        | 0.0  | 0.0  |
| Volume/Cap:                                 | 0.75        | 0.35 | 0.00 | 0.00        | 1.02 | 1.63  | 0.85       | 0.00 | 0.89  | 0.00       | 0.00 | 0.00 |
| Delay/Veh:                                  | 97.9        | 43.9 | 0.0  | 0.0         | 103  | 365.2 | 26.8       | 0.0  | 18.9  | 0.0        | 0.0  | 0.0  |
| User DelAdj:                                | 1.00        | 1.00 | 1.00 | 1.00        | 1.00 | 1.00  | 1.00       | 1.00 | 1.00  | 1.00       | 1.00 | 1.00 |
| AdjDel/Veh:                                 | 97.9        | 43.9 | 0.0  | 0.0         | 103  | 365.2 | 26.8       | 0.0  | 18.9  | 0.0        | 0.0  | 0.0  |
| LOS by Move:                                | F           | D    | A    | A           | F    | F     | C          | A    | B     | A          | A    | A    |
| HCM2k95thQ:                                 | 16          | 19   | 0    | 0           | 61   | 142   | 59         | 0    | 57    | 0          | 0    | 0    |

Note: Queue reported is the number of cars per lane.

BART

Level Of Service Computation Report  
 2000 HCM Operations (Future Volume Alternative)  
 AM - Exist + Proj Conditions

Intersection #5416: SAN TOMAS EXPWY/EL CAMINO REAL [Study Int 41]

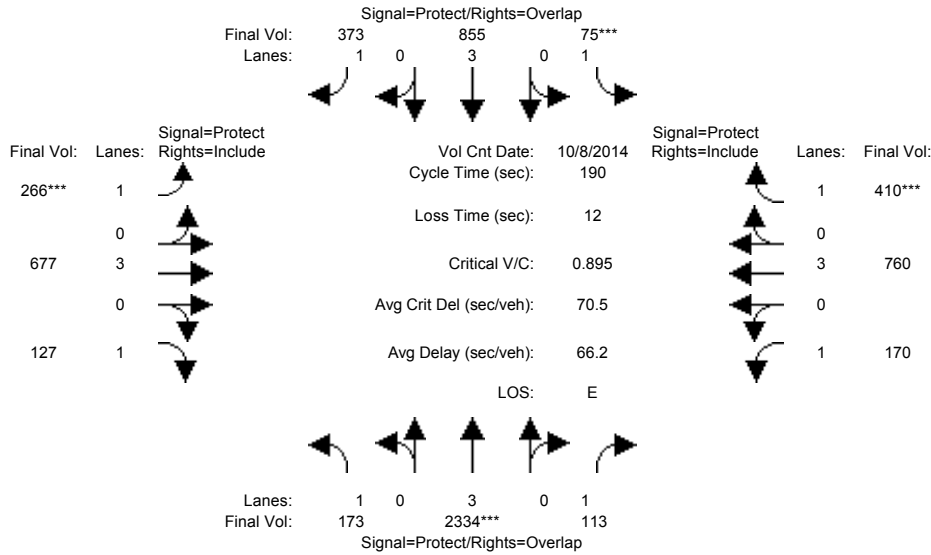

| Approach:                                   | North Bound |      |       | South Bound |      |      | East Bound |      |      | West Bound |      |      |
|---|-------------|------|-------|-------------|------|------|------------|------|------|------------|------|------|
| Movement:                                   | L           | T    | R     | L           | T    | R    | L          | T    | R    | L          | T    | R    |
| Min. Green:                                 | 7           | 10   | 10    | 7           | 10   | 10   | 7          | 10   | 10   | 7          | 10   | 10   |
| Y+R:  | 4.0         | 4.0  | 4.0   | 4.0         | 4.0  | 4.0  | 4.0        | 4.0  | 4.0  | 4.0        | 4.0  | 4.0  |
| Volume Module: >> Count Date: 8 Oct 2014 << |             |      |       |             |      |      |            |      |      |            |      |      |
| Base Vol:                                   | 173         | 2778 | 113   | 75          | 1018 | 373  | 266        | 677  | 127  | 170        | 760  | 410  |
| Growth Adj:                                 | 1.00        | 1.00 | 1.00  | 1.00        | 1.00 | 1.00 | 1.00       | 1.00 | 1.00 | 1.00       | 1.00 | 1.00 |
| Initial Bse:                                | 173         | 2778 | 113   | 75          | 1018 | 373  | 266        | 677  | 127  | 170        | 760  | 410  |
| Added Vol:                                  | 0           | 0    | 0     | 0           | 0    | 0    | 0          | 0    | 0    | 0          | 0    | 0    |
| PasserByVol:                                | 0           | 0    | 0     | 0           | 0    | 0    | 0          | 0    | 0    | 0          | 0    | 0    |
| Initial Fut:                                | 173         | 2778 | 113   | 75          | 1018 | 373  | 266        | 677  | 127  | 170        | 760  | 410  |
| User Adj:                                   | 1.00        | 0.84 | 1.00  | 1.00        | 0.84 | 1.00 | 1.00       | 1.00 | 1.00 | 1.00       | 1.00 | 1.00 |
| PHF Adj:                                    | 1.00        | 1.00 | 1.00  | 1.00        | 1.00 | 1.00 | 1.00       | 1.00 | 1.00 | 1.00       | 1.00 | 1.00 |
| PHF Volume:                                 | 173         | 2334 | 113   | 75          | 855  | 373  | 266        | 677  | 127  | 170        | 760  | 410  |
| Reduct Vol:                                 | 0           | 0    | 0     | 0           | 0    | 0    | 0          | 0    | 0    | 0          | 0    | 0    |
| Reduced Vol:                                | 173         | 2334 | 113   | 75          | 855  | 373  | 266        | 677  | 127  | 170        | 760  | 410  |
| PCE Adj:                                    | 1.00        | 1.00 | 1.00  | 1.00        | 1.00 | 1.00 | 1.00       | 1.00 | 1.00 | 1.00       | 1.00 | 1.00 |
| MLF Adj:                                    | 1.00        | 1.00 | 1.00  | 1.00        | 1.00 | 1.00 | 1.00       | 1.00 | 1.00 | 1.00       | 1.00 | 1.00 |
| Final Volume:                               | 173         | 2334 | 113   | 75          | 855  | 373  | 266        | 677  | 127  | 170        | 760  | 410  |
| Saturation Flow Module:                     |             |      |       |             |      |      |            |      |      |            |      |      |
| Sat/Lane:                                   | 1900        | 1900 | 1900  | 1900        | 1900 | 1900 | 1900       | 1900 | 1900 | 1900       | 1900 | 1900 |
| Adjustment:                                 | 0.92        | 1.00 | 0.92  | 0.92        | 1.00 | 0.92 | 0.92       | 1.00 | 0.92 | 0.92       | 1.00 | 0.92 |
| Lanes:                                      | 1.00        | 3.00 | 1.00  | 1.00        | 3.00 | 1.00 | 1.00       | 3.00 | 1.00 | 1.00       | 3.00 | 1.00 |
| Final Sat.:                                 | 1750        | 5700 | 1750  | 1750        | 5700 | 1750 | 1750       | 5700 | 1750 | 1750       | 5700 | 1750 |
| Capacity Analysis Module:                   |             |      |       |             |      |      |            |      |      |            |      |      |
| Vol/Sat:                                    | 0.10        | 0.41 | 0.06  | 0.04        | 0.15 | 0.21 | 0.15       | 0.12 | 0.07 | 0.10       | 0.13 | 0.23 |
| Crit Moves:                                 | ****        | **** | ****  | ****        | **** | **** | ****       | **** | **** | ****       | **** | **** |
| Green Time:                                 | 38.1        | 86.9 | 123.8 | 9.1         | 57.9 | 90.1 | 32.3       | 45.1 | 45.1 | 36.9       | 49.7 | 49.7 |
| Volume/Cap:                                 | 0.49        | 0.90 | 0.10  | 0.90        | 0.49 | 0.45 | 0.90       | 0.50 | 0.31 | 0.50       | 0.51 | 0.90 |
| Delay/Veh:                                  | 69.0        | 60.9 | 18.7  | 157.5       | 70.1 | 53.8 | 104.5      | 63.0 | 60.0 | 69.5       | 60.0 | 87.3 |
| User DelAdj:                                | 1.00        | 1.00 | 1.00  | 1.00        | 1.00 | 1.00 | 1.00       | 1.00 | 1.00 | 1.00       | 1.00 | 1.00 |
| AdjDel/Veh:                                 | 69.0        | 60.9 | 18.7  | 157.5       | 70.1 | 53.8 | 104.5      | 63.0 | 60.0 | 69.5       | 60.0 | 87.3 |
| LOS by Move:                                | E           | E    | B     | F           | E    | D    | F          | E    | E    | E          | E    | F    |
| HCM2k95thQ:                                 | 18          | 70   | 8     | 11          | 26   | 34   | 33         | 21   | 12   | 17         | 22   | 43   |

Note: Queue reported is the number of cars per lane.

BART

Level Of Service Computation Report  
2000 HCM Operations (Future Volume Alternative)  
PM - Exist + Proj Conditions

Intersection #5416: SAN TOMAS EXPWY/EL CAMINO REAL [Study Int 41]

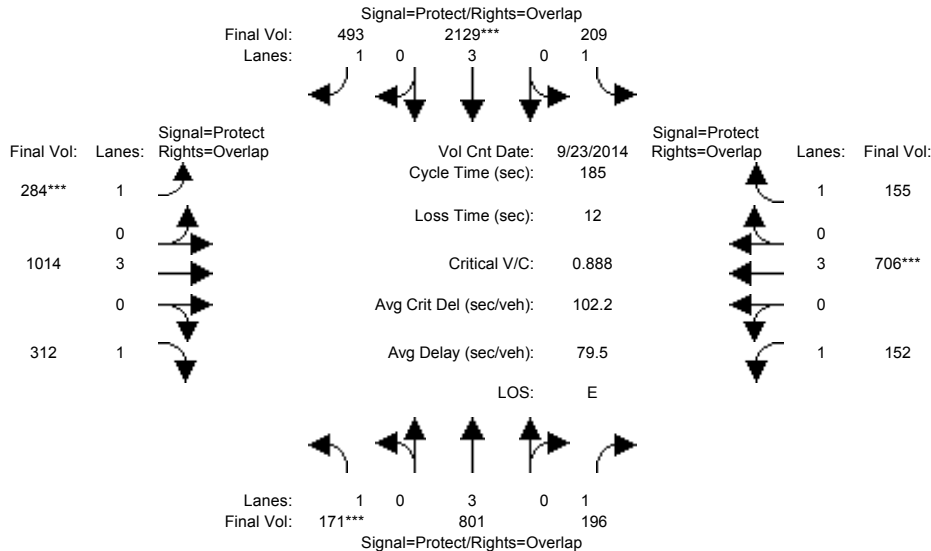

| Approach:                                    | North Bound |      |      | South Bound |      |       | East Bound |      |      | West Bound |      |      |
|--|-------------|------|------|-------------|------|-------|------------|------|------|------------|------|------|
| Movement:                                    | L           | T    | R    | L           | T    | R     | L          | T    | R    | L          | T    | R    |
| Min. Green:                                  | 12          | 72   | 72   | 33          | 93   | 93    | 39         | 50   | 50   | 29         | 41   | 41   |
| Y+R:   | 4.0         | 4.0  | 4.0  | 4.0         | 4.0  | 4.0   | 4.0        | 4.0  | 4.0  | 4.0        | 4.0  | 4.0  |
| Volume Module: >> Count Date: 23 Sep 2014 << |             |      |      |             |      |       |            |      |      |            |      |      |
| Base Vol:                                    | 171         | 1054 | 196  | 209         | 2765 | 493   | 284        | 1014 | 312  | 152        | 706  | 155  |
| Growth Adj:                                  | 1.00        | 1.00 | 1.00 | 1.00        | 1.00 | 1.00  | 1.00       | 1.00 | 1.00 | 1.00       | 1.00 | 1.00 |
| Initial Bse:                                 | 171         | 1054 | 196  | 209         | 2765 | 493   | 284        | 1014 | 312  | 152        | 706  | 155  |
| Added Vol:                                   | 0           | 0    | 0    | 0           | 0    | 0     | 0          | 0    | 0    | 0          | 0    | 0    |
| PasserByVol:                                 | 0           | 0    | 0    | 0           | 0    | 0     | 0          | 0    | 0    | 0          | 0    | 0    |
| Initial Fut:                                 | 171         | 1054 | 196  | 209         | 2765 | 493   | 284        | 1014 | 312  | 152        | 706  | 155  |
| User Adj:                                    | 1.00        | 0.76 | 1.00 | 1.00        | 0.77 | 1.00  | 1.00       | 1.00 | 1.00 | 1.00       | 1.00 | 1.00 |
| PHF Adj:                                     | 1.00        | 1.00 | 1.00 | 1.00        | 1.00 | 1.00  | 1.00       | 1.00 | 1.00 | 1.00       | 1.00 | 1.00 |
| PHF Volume:                                  | 171         | 801  | 196  | 209         | 2129 | 493   | 284        | 1014 | 312  | 152        | 706  | 155  |
| Reduct Vol:                                  | 0           | 0    | 0    | 0           | 0    | 0     | 0          | 0    | 0    | 0          | 0    | 0    |
| Reduced Vol:                                 | 171         | 801  | 196  | 209         | 2129 | 493   | 284        | 1014 | 312  | 152        | 706  | 155  |
| PCE Adj:                                     | 1.00        | 1.00 | 1.00 | 1.00        | 1.00 | 1.00  | 1.00       | 1.00 | 1.00 | 1.00       | 1.00 | 1.00 |
| MLF Adj:                                     | 1.00        | 1.00 | 1.00 | 1.00        | 1.00 | 1.00  | 1.00       | 1.00 | 1.00 | 1.00       | 1.00 | 1.00 |
| Final Volume:                                | 171         | 801  | 196  | 209         | 2129 | 493   | 284        | 1014 | 312  | 152        | 706  | 155  |
| Saturation Flow Module:                      |             |      |      |             |      |       |            |      |      |            |      |      |
| Sat/Lane:                                    | 1900        | 1900 | 1900 | 1900        | 1900 | 1900  | 1900       | 1900 | 1900 | 1900       | 1900 | 1900 |
| Adjustment:                                  | 0.92        | 1.00 | 0.92 | 0.92        | 0.83 | 0.92  | 0.92       | 1.00 | 0.92 | 0.92       | 1.00 | 0.92 |
| Lanes:                                       | 1.00        | 3.00 | 1.00 | 1.00        | 3.00 | 1.00  | 1.00       | 3.00 | 1.00 | 1.00       | 3.00 | 1.00 |
| Final Sat.:                                  | 1750        | 5700 | 1750 | 1750        | 4731 | 1750  | 1750       | 5700 | 1750 | 1750       | 5700 | 1750 |
| Capacity Analysis Module:                    |             |      |      |             |      |       |            |      |      |            |      |      |
| Vol/Sat:                                     | 0.10        | 0.14 | 0.11 | 0.12        | 0.45 | 0.28  | 0.16       | 0.18 | 0.18 | 0.09       | 0.12 | 0.09 |
| Crit Moves:                                  | ****        |      |      | ****        |      |       | ****       |      |      | ****       |      |      |
| Green Time:                                  | 11.3        | 67.6 | 95.2 | 31.0        | 87.3 | 124.0 | 36.6       | 47.5 | 58.8 | 27.6       | 38.5 | 69.5 |
| Volume/Cap:                                  | 1.60        | 0.38 | 0.22 | 0.71        | 0.95 | 0.42  | 0.82       | 0.69 | 0.56 | 0.58       | 0.60 | 0.24 |
| Delay/Veh:                                   | 403.6       | 51.3 | 33.0 | 95.9        | 89.9 | 35.4  | 89.9       | 67.6 | 57.1 | 81.4       | 71.3 | 42.3 |
| User DelAdj:                                 | 1.00        | 1.00 | 1.00 | 1.00        | 1.00 | 1.00  | 1.00       | 1.00 | 1.00 | 1.00       | 1.00 | 1.00 |
| AdjDel/Veh:                                  | 403.6       | 51.3 | 33.0 | 95.9        | 89.9 | 35.4  | 89.9       | 67.6 | 57.1 | 81.4       | 71.3 | 42.3 |
| LOS by Move:                                 | F           | D    | C    | F           | F    | D     | F          | E    | E    | F          | E    | D    |
| HCM2k95thQ:                                  | 33          | 23   | 16   | 24          | 71   | 43    | 33         | 32   | 29   | 17         | 23   | 13   |

Note: Queue reported is the number of cars per lane.

BART

Level Of Service Computation Report  
 2000 HCM Operations (Future Volume Alternative)  
 AM - Exist + Proj Conditions

Intersection #5444: Lafayette/Lewis [Study Int 47]

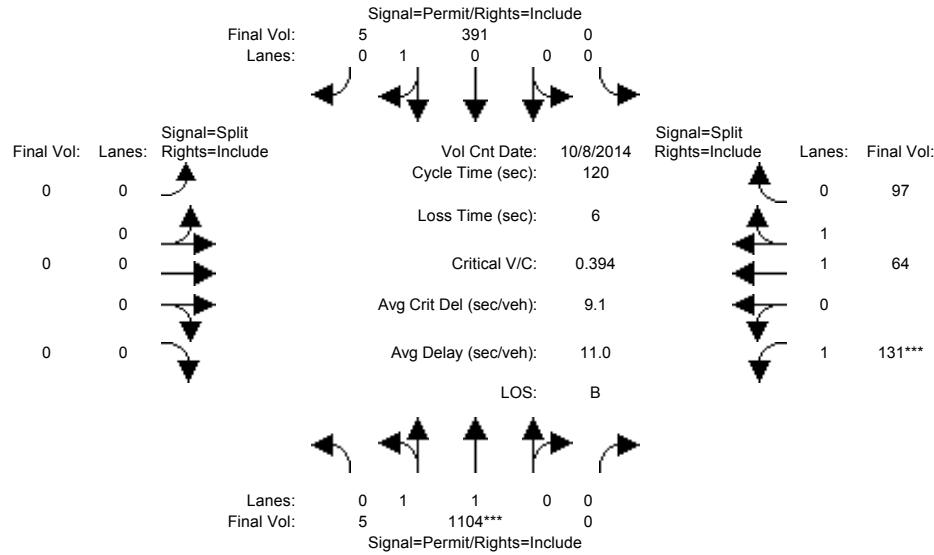

| Approach:                                   | North Bound |      |      | South Bound |      |      | East Bound |      |      | West Bound |      |      |
|---|-------------|------|------|-------------|------|------|------------|------|------|------------|------|------|
| Movement:                                   | L           | T    | R    | L           | T    | R    | L          | T    | R    | L          | T    | R    |
| Min. Green:                                 | 10          | 10   | 0    | 0           | 10   | 10   | 0          | 0    | 0    | 10         | 10   | 10   |
| Y+R:  | 4.0         | 4.0  | 4.0  | 4.0         | 4.0  | 4.0  | 4.0        | 4.0  | 4.0  | 4.0        | 4.0  | 4.0  |
| Volume Module: >> Count Date: 8 Oct 2014 << |             |      |      |             |      |      |            |      |      |            |      |      |
| Base Vol:                                   | 5           | 1104 | 0    | 0           | 391  | 5    | 0          | 0    | 0    | 131        | 64   | 97   |
| Growth Adj:                                 | 1.00        | 1.00 | 1.00 | 1.00        | 1.00 | 1.00 | 1.00       | 1.00 | 1.00 | 1.00       | 1.00 | 1.00 |
| Initial Bse:                                | 5           | 1104 | 0    | 0           | 391  | 5    | 0          | 0    | 0    | 131        | 64   | 97   |
| Added Vol:                                  | 0           | 0    | 0    | 0           | 0    | 0    | 0          | 0    | 0    | 0          | 0    | 0    |
| PasserByVol:                                | 0           | 0    | 0    | 0           | 0    | 0    | 0          | 0    | 0    | 0          | 0    | 0    |
| Initial Fut:                                | 5           | 1104 | 0    | 0           | 391  | 5    | 0          | 0    | 0    | 131        | 64   | 97   |
| User Adj:                                   | 1.00        | 1.00 | 1.00 | 1.00        | 1.00 | 1.00 | 1.00       | 1.00 | 1.00 | 1.00       | 1.00 | 1.00 |
| PHF Adj:                                    | 1.00        | 1.00 | 1.00 | 1.00        | 1.00 | 1.00 | 1.00       | 1.00 | 1.00 | 1.00       | 1.00 | 1.00 |
| PHF Volume:                                 | 5           | 1104 | 0    | 0           | 391  | 5    | 0          | 0    | 0    | 131        | 64   | 97   |
| Reduct Vol:                                 | 0           | 0    | 0    | 0           | 0    | 0    | 0          | 0    | 0    | 0          | 0    | 0    |
| Reduced Vol:                                | 5           | 1104 | 0    | 0           | 391  | 5    | 0          | 0    | 0    | 131        | 64   | 97   |
| PCE Adj:                                    | 1.00        | 1.00 | 1.00 | 1.00        | 1.00 | 1.00 | 1.00       | 1.00 | 1.00 | 1.00       | 1.00 | 1.00 |
| MLF Adj:                                    | 1.00        | 1.00 | 1.00 | 1.00        | 1.00 | 1.00 | 1.00       | 1.00 | 1.00 | 1.00       | 1.00 | 1.00 |
| Final Volume:                               | 5           | 1104 | 0    | 0           | 391  | 5    | 0          | 0    | 0    | 131        | 64   | 97   |
| Saturation Flow Module:                     |             |      |      |             |      |      |            |      |      |            |      |      |
| Sat/Lane:                                   | 1900        | 1900 | 1900 | 1900        | 1900 | 1900 | 1900       | 1900 | 1900 | 1900       | 1900 | 1900 |
| Adjustment:                                 | 0.95        | 0.97 | 0.92 | 0.92        | 0.95 | 0.95 | 0.92       | 1.00 | 0.92 | 0.92       | 1.00 | 0.92 |
| Lanes:                                      | 0.01        | 1.99 | 0.00 | 0.00        | 0.99 | 0.01 | 0.00       | 0.00 | 0.00 | 1.00       | 1.00 | 1.00 |
| Final Sat.:                                 | 17          | 3683 | 0    | 0           | 1777 | 23   | 0          | 0    | 0    | 1750       | 1900 | 1750 |
| Capacity Analysis Module:                   |             |      |      |             |      |      |            |      |      |            |      |      |
| Vol/Sat:                                    | 0.30        | 0.30 | 0.00 | 0.00        | 0.22 | 0.22 | 0.00       | 0.00 | 0.00 | 0.07       | 0.03 | 0.06 |
| Crit Moves:                                 | ****        |      |      | ****        |      |      | ****       |      |      | ****       |      |      |
| Green Time:                                 | 91.2        | 91.2 | 0.0  | 0.0         | 91.2 | 91.2 | 0.0        | 0.0  | 0.0  | 22.8       | 22.8 | 22.8 |
| Volume/Cap:                                 | 0.39        | 0.39 | 0.00 | 0.00        | 0.29 | 0.29 | 0.00       | 0.00 | 0.00 | 0.39       | 0.18 | 0.29 |
| Delay/Veh:                                  | 5.0         | 5.0  | 0.0  | 0.0         | 4.5  | 4.5  | 0.0        | 0.0  | 0.0  | 43.3       | 40.8 | 42.0 |
| User DelAdj:                                | 1.00        | 1.00 | 1.00 | 1.00        | 1.00 | 1.00 | 1.00       | 1.00 | 1.00 | 1.00       | 1.00 | 1.00 |
| AdjDel/Veh:                                 | 5.0         | 5.0  | 0.0  | 0.0         | 4.5  | 4.5  | 0.0        | 0.0  | 0.0  | 43.3       | 40.8 | 42.0 |
| LOS by Move:                                | A           | A    | A    | A           | A    | A    | A          | A    | A    | D          | D    | D    |
| HCM2k95thQ:                                 | 13          | 13   | 0    | 0           | 9    | 9    | 0          | 0    | 0    | 9          | 4    | 7    |

Note: Queue reported is the number of cars per lane.

BART

Level Of Service Computation Report  
 2000 HCM Operations (Future Volume Alternative)  
 PM - Exist + Proj Conditions

Intersection #5444: Lafayette/Lewis [Study Int 47]

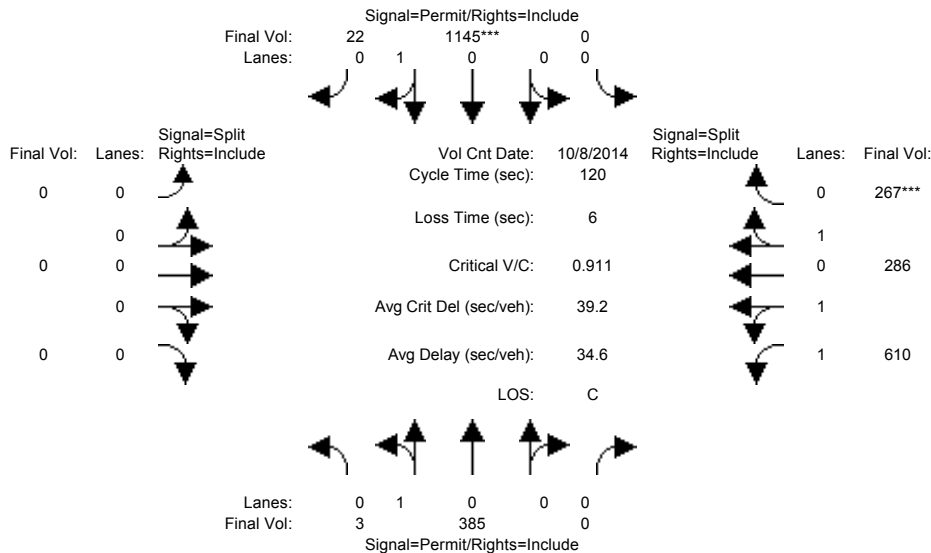

| Approach:                                   | North Bound |      |      | South Bound |      |      | East Bound |      |      | West Bound |      |      |
|---|-------------|------|------|-------------|------|------|------------|------|------|------------|------|------|
| Movement:                                   | L           | T    | R    | L           | T    | R    | L          | T    | R    | L          | T    | R    |
| Min. Green:                                 | 10          | 10   | 0    | 0           | 10   | 10   | 0          | 0    | 0    | 10         | 10   | 10   |
| Y+R:  | 4.0         | 4.0  | 4.0  | 4.0         | 4.0  | 4.0  | 4.0        | 4.0  | 4.0  | 4.0        | 4.0  | 4.0  |
| Volume Module: >> Count Date: 8 Oct 2014 << |             |      |      |             |      |      |            |      |      |            |      |      |
| Base Vol:                                   | 3           | 385  | 0    | 0           | 1145 | 22   | 0          | 0    | 0    | 610        | 286  | 267  |
| Growth Adj:                                 | 1.00        | 1.00 | 1.00 | 1.00        | 1.00 | 1.00 | 1.00       | 1.00 | 1.00 | 1.00       | 1.00 | 1.00 |
| Initial Bse:                                | 3           | 385  | 0    | 0           | 1145 | 22   | 0          | 0    | 0    | 610        | 286  | 267  |
| Added Vol:                                  | 0           | 0    | 0    | 0           | 0    | 0    | 0          | 0    | 0    | 0          | 0    | 0    |
| PasserByVol:                                | 0           | 0    | 0    | 0           | 0    | 0    | 0          | 0    | 0    | 0          | 0    | 0    |
| Initial Fut:                                | 3           | 385  | 0    | 0           | 1145 | 22   | 0          | 0    | 0    | 610        | 286  | 267  |
| User Adj:                                   | 1.00        | 1.00 | 1.00 | 1.00        | 1.00 | 1.00 | 1.00       | 1.00 | 1.00 | 1.00       | 1.00 | 1.00 |
| PHF Adj:                                    | 1.00        | 1.00 | 1.00 | 1.00        | 1.00 | 1.00 | 1.00       | 1.00 | 1.00 | 1.00       | 1.00 | 1.00 |
| PHF Volume:                                 | 3           | 385  | 0    | 0           | 1145 | 22   | 0          | 0    | 0    | 610        | 286  | 267  |
| Reduct Vol:                                 | 0           | 0    | 0    | 0           | 0    | 0    | 0          | 0    | 0    | 0          | 0    | 0    |
| Reduced Vol:                                | 3           | 385  | 0    | 0           | 1145 | 22   | 0          | 0    | 0    | 610        | 286  | 267  |
| PCE Adj:                                    | 1.00        | 1.00 | 1.00 | 1.00        | 1.00 | 1.00 | 1.00       | 1.00 | 1.00 | 1.00       | 1.00 | 1.00 |
| MLF Adj:                                    | 1.00        | 1.00 | 1.00 | 1.00        | 1.00 | 1.00 | 1.00       | 1.00 | 1.00 | 1.00       | 1.00 | 1.00 |
| Final Volume:                               | 3           | 385  | 0    | 0           | 1145 | 22   | 0          | 0    | 0    | 610        | 286  | 267  |
| Saturation Flow Module:                     |             |      |      |             |      |      |            |      |      |            |      |      |
| Sat/Lane:                                   | 1900        | 1900 | 1900 | 1900        | 1900 | 1900 | 1900       | 1900 | 1900 | 1900       | 1900 | 1900 |
| Adjustment:                                 | 0.95        | 0.95 | 0.92 | 0.92        | 0.95 | 0.95 | 0.92       | 1.00 | 0.92 | 0.93       | 0.95 | 0.95 |
| Lanes:                                      | 0.01        | 0.99 | 0.00 | 0.00        | 0.98 | 0.02 | 0.00       | 0.00 | 0.00 | 1.59       | 0.73 | 0.68 |
| Final Sat.:                                 | 14          | 1786 | 0    | 0           | 1766 | 34   | 0          | 0    | 0    | 2806       | 1316 | 1228 |
| Capacity Analysis Module:                   |             |      |      |             |      |      |            |      |      |            |      |      |
| Vol/Sat:                                    | 0.22        | 0.22 | 0.00 | 0.00        | 0.65 | 0.65 | 0.00       | 0.00 | 0.00 | 0.22       | 0.22 | 0.22 |
| Crit Moves:                                 | *****       |      |      |             |      |      |            |      |      |            |      |      |
| Green Time:                                 | 85.4        | 85.4 | 0.0  | 0.0         | 85.4 | 85.4 | 0.0        | 0.0  | 0.0  | 28.6       | 28.6 | 28.6 |
| Volume/Cap:                                 | 0.30        | 0.30 | 0.00 | 0.00        | 0.91 | 0.91 | 0.00       | 0.00 | 0.00 | 0.91       | 0.91 | 0.91 |
| Delay/Veh:                                  | 6.5         | 6.5  | 0.0  | 0.0         | 24.1 | 24.1 | 0.0        | 0.0  | 0.0  | 54.4       | 54.4 | 54.4 |
| User DelAdj:                                | 1.00        | 1.00 | 1.00 | 1.00        | 1.00 | 1.00 | 1.00       | 1.00 | 1.00 | 1.00       | 1.00 | 1.00 |
| AdjDel/Veh:                                 | 6.5         | 6.5  | 0.0  | 0.0         | 24.1 | 24.1 | 0.0        | 0.0  | 0.0  | 54.4       | 54.4 | 54.4 |
| LOS by Move:                                | A           | A    | A    | A           | C    | C    | A          | A    | A    | D          | D    | D    |
| HCM2k95thQ:                                 | 11          | 11   | 0    | 0           | 61   | 61   | 0          | 0    | 0    | 32         | 32   | 32   |

Note: Queue reported is the number of cars per lane.

BART

Level Of Service Computation Report  
 2000 HCM Operations (Future Volume Alternative)  
 AM - Background Conditions

Intersection #6: DE LA CRUZ/MARTIN [Study Int 31]

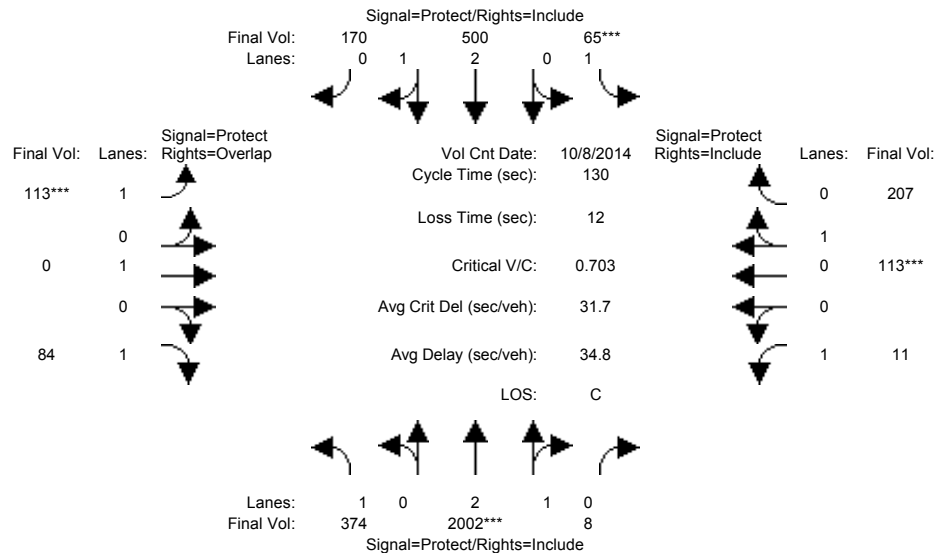

| Approach:                                   | North Bound |      |      | South Bound |      |      | East Bound |      |      | West Bound |      |      |
|---|-------------|------|------|-------------|------|------|------------|------|------|------------|------|------|
| Movement:                                   | L           | T    | R    | L           | T    | R    | L          | T    | R    | L          | T    | R    |
| Min. Green:                                 | 7           | 10   | 10   | 7           | 10   | 10   | 7          | 10   | 10   | 7          | 10   | 10   |
| Y+R:  | 4.0         | 4.0  | 4.0  | 4.0         | 4.0  | 4.0  | 4.0        | 4.0  | 4.0  | 4.0        | 4.0  | 4.0  |
| Volume Module: >> Count Date: 8 Oct 2014 << |             |      |      |             |      |      |            |      |      |            |      |      |
| Base Vol:                                   | 374         | 2002 | 8    | 65          | 500  | 170  | 113        | 0    | 84   | 11         | 113  | 207  |
| Growth Adj:                                 | 1.00        | 1.00 | 1.00 | 1.00        | 1.00 | 1.00 | 1.00       | 1.00 | 1.00 | 1.00       | 1.00 | 1.00 |
| Initial Bse:                                | 374         | 2002 | 8    | 65          | 500  | 170  | 113        | 0    | 84   | 11         | 113  | 207  |
| Added Vol:                                  | 0           | 0    | 0    | 0           | 0    | 0    | 0          | 0    | 0    | 0          | 0    | 0    |
| PasserByVol:                                | 0           | 0    | 0    | 0           | 0    | 0    | 0          | 0    | 0    | 0          | 0    | 0    |
| Initial Fut:                                | 374         | 2002 | 8    | 65          | 500  | 170  | 113        | 0    | 84   | 11         | 113  | 207  |
| User Adj:                                   | 1.00        | 1.00 | 1.00 | 1.00        | 1.00 | 1.00 | 1.00       | 1.00 | 1.00 | 1.00       | 1.00 | 1.00 |
| PHF Adj:                                    | 1.00        | 1.00 | 1.00 | 1.00        | 1.00 | 1.00 | 1.00       | 1.00 | 1.00 | 1.00       | 1.00 | 1.00 |
| PHF Volume:                                 | 374         | 2002 | 8    | 65          | 500  | 170  | 113        | 0    | 84   | 11         | 113  | 207  |
| Reduct Vol:                                 | 0           | 0    | 0    | 0           | 0    | 0    | 0          | 0    | 0    | 0          | 0    | 0    |
| Reduced Vol:                                | 374         | 2002 | 8    | 65          | 500  | 170  | 113        | 0    | 84   | 11         | 113  | 207  |
| PCE Adj:                                    | 1.00        | 1.00 | 1.00 | 1.00        | 1.00 | 1.00 | 1.00       | 1.00 | 1.00 | 1.00       | 1.00 | 1.00 |
| MLF Adj:                                    | 1.00        | 1.00 | 1.00 | 1.00        | 1.00 | 1.00 | 1.00       | 1.00 | 1.00 | 1.00       | 1.00 | 1.00 |
| FinalVolume:                                | 374         | 2002 | 8    | 65          | 500  | 170  | 113        | 0    | 84   | 11         | 113  | 207  |
| Saturation Flow Module:                     |             |      |      |             |      |      |            |      |      |            |      |      |
| Sat/Lane:                                   | 1900        | 1900 | 1900 | 1900        | 1900 | 1900 | 1900       | 1900 | 1900 | 1900       | 1900 | 1900 |
| Adjustment:                                 | 0.92        | 0.98 | 0.95 | 0.92        | 0.99 | 0.95 | 0.92       | 1.00 | 0.92 | 0.92       | 0.95 | 0.95 |
| Lanes:                                      | 1.00        | 2.99 | 0.01 | 1.00        | 2.21 | 0.79 | 1.00       | 1.00 | 1.00 | 1.00       | 0.35 | 0.65 |
| Final Sat.:                                 | 1750        | 5578 | 22   | 1750        | 4177 | 1420 | 1750       | 1900 | 1750 | 1750       | 636  | 1164 |
| Capacity Analysis Module:                   |             |      |      |             |      |      |            |      |      |            |      |      |
| Vol/Sat:                                    | 0.21        | 0.36 | 0.36 | 0.04        | 0.12 | 0.12 | 0.06       | 0.00 | 0.05 | 0.01       | 0.18 | 0.18 |
| Crit Moves:                                 | ****        | **** | **** | ****        | **** | **** | ****       | **** | **** | ****       | **** | **** |
| Green Time:                                 | 47.0        | 66.3 | 66.3 | 7.0         | 26.3 | 26.3 | 11.9       | 0.0  | 58.9 | 44.7       | 32.8 | 32.8 |
| Volume/Cap:                                 | 0.59        | 0.70 | 0.70 | 0.69        | 0.59 | 0.59 | 0.70       | 0.00 | 0.11 | 0.02       | 0.70 | 0.70 |
| Delay/Veh:                                  | 35.2        | 25.2 | 25.2 | 79.9        | 47.8 | 47.8 | 70.6       | 0.0  | 20.5 | 28.1       | 49.1 | 49.1 |
| User DelAdj:                                | 1.00        | 1.00 | 1.00 | 1.00        | 1.00 | 1.00 | 1.00       | 1.00 | 1.00 | 1.00       | 1.00 | 1.00 |
| AdjDel/Veh:                                 | 35.2        | 25.2 | 25.2 | 79.9        | 47.8 | 47.8 | 70.6       | 0.0  | 20.5 | 28.1       | 49.1 | 49.1 |
| LOS by Move:                                | D           | C    | C    | E           | D    | D    | E          | A    | C    | C          | D    | D    |
| HCM2k95thQ:                                 | 23          | 35   | 35   | 6           | 15   | 15   | 10         | 0    | 4    | 1          | 24   | 24   |

Note: Queue reported is the number of cars per lane.



BART

Level Of Service Computation Report  
2000 HCM Operations (Future Volume Alternative)  
PM - Background Conditions

Intersection #6: DE LA CRUZ/MARTIN [Study Int 31]

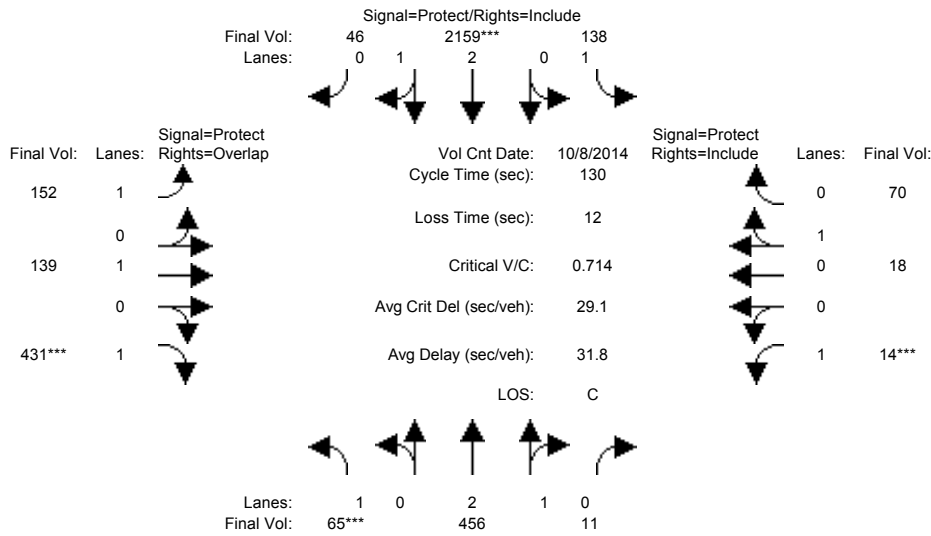

| Approach:                                   | North Bound |      |      | South Bound |      |      | East Bound |      |      | West Bound |      |      |
|---|-------------|------|------|-------------|------|------|------------|------|------|------------|------|------|
| Movement:                                   | L           | T    | R    | L           | T    | R    | L          | T    | R    | L          | T    | R    |
| Min. Green:                                 | 7           | 10   | 10   | 7           | 10   | 10   | 7          | 10   | 10   | 7          | 10   | 10   |
| Y+R:  | 4.0         | 4.0  | 4.0  | 4.0         | 4.0  | 4.0  | 4.0        | 4.0  | 4.0  | 4.0        | 4.0  | 4.0  |
| Volume Module: >> Count Date: 8 Oct 2014 << |             |      |      |             |      |      |            |      |      |            |      |      |
| Base Vol:                                   | 65          | 456  | 11   | 138         | 2159 | 46   | 152        | 139  | 431  | 14         | 18   | 70   |
| Growth Adj:                                 | 1.00        | 1.00 | 1.00 | 1.00        | 1.00 | 1.00 | 1.00       | 1.00 | 1.00 | 1.00       | 1.00 | 1.00 |
| Initial Bse:                                | 65          | 456  | 11   | 138         | 2159 | 46   | 152        | 139  | 431  | 14         | 18   | 70   |
| Added Vol:                                  | 0           | 0    | 0    | 0           | 0    | 0    | 0          | 0    | 0    | 0          | 0    | 0    |
| PasserByVol:                                | 0           | 0    | 0    | 0           | 0    | 0    | 0          | 0    | 0    | 0          | 0    | 0    |
| Initial Fut:                                | 65          | 456  | 11   | 138         | 2159 | 46   | 152        | 139  | 431  | 14         | 18   | 70   |
| User Adj:                                   | 1.00        | 1.00 | 1.00 | 1.00        | 1.00 | 1.00 | 1.00       | 1.00 | 1.00 | 1.00       | 1.00 | 1.00 |
| PHF Adj:                                    | 1.00        | 1.00 | 1.00 | 1.00        | 1.00 | 1.00 | 1.00       | 1.00 | 1.00 | 1.00       | 1.00 | 1.00 |
| PHF Volume:                                 | 65          | 456  | 11   | 138         | 2159 | 46   | 152        | 139  | 431  | 14         | 18   | 70   |
| Reduct Vol:                                 | 0           | 0    | 0    | 0           | 0    | 0    | 0          | 0    | 0    | 0          | 0    | 0    |
| Reduced Vol:                                | 65          | 456  | 11   | 138         | 2159 | 46   | 152        | 139  | 431  | 14         | 18   | 70   |
| PCE Adj:                                    | 1.00        | 1.00 | 1.00 | 1.00        | 1.00 | 1.00 | 1.00       | 1.00 | 1.00 | 1.00       | 1.00 | 1.00 |
| MLF Adj:                                    | 1.00        | 1.00 | 1.00 | 1.00        | 1.00 | 1.00 | 1.00       | 1.00 | 1.00 | 1.00       | 1.00 | 1.00 |
| Final Volume:                               | 65          | 456  | 11   | 138         | 2159 | 46   | 152        | 139  | 431  | 14         | 18   | 70   |
| Saturation Flow Module:                     |             |      |      |             |      |      |            |      |      |            |      |      |
| Sat/Lane:                                   | 1900        | 1900 | 1900 | 1900        | 1900 | 1900 | 1900       | 1900 | 1900 | 1900       | 1900 | 1900 |
| Adjustment:                                 | 0.92        | 0.98 | 0.95 | 0.92        | 0.98 | 0.95 | 0.92       | 1.00 | 0.92 | 0.92       | 0.95 | 0.95 |
| Lanes:                                      | 1.00        | 2.93 | 0.07 | 1.00        | 2.94 | 0.06 | 1.00       | 1.00 | 1.00 | 1.00       | 0.20 | 0.80 |
| Final Sat.:                                 | 1750        | 5468 | 132  | 1750        | 5483 | 117  | 1750       | 1900 | 1750 | 1750       | 368  | 1432 |
| Capacity Analysis Module:                   |             |      |      |             |      |      |            |      |      |            |      |      |
| Vol/Sat:                                    | 0.04        | 0.08 | 0.08 | 0.08        | 0.39 | 0.39 | 0.09       | 0.07 | 0.25 | 0.01       | 0.05 | 0.05 |
| Crit Moves:                                 | ****        |      |      | ****        |      |      | ****       |      | **** | ****       |      |      |
| Green Time:                                 | 7.0         | 39.5 | 39.5 | 37.4        | 69.9 | 69.9 | 21.8       | 34.1 | 41.1 | 7.0        | 19.3 | 19.3 |
| Volume/Cap:                                 | 0.69        | 0.27 | 0.27 | 0.27        | 0.73 | 0.73 | 0.52       | 0.28 | 0.78 | 0.15       | 0.33 | 0.33 |
| Delay/Veh:                                  | 79.9        | 34.5 | 34.5 | 36.1        | 23.9 | 23.9 | 50.9       | 38.4 | 47.2 | 59.4       | 50.3 | 50.3 |
| User DelAdj:                                | 1.00        | 1.00 | 1.00 | 1.00        | 1.00 | 1.00 | 1.00       | 1.00 | 1.00 | 1.00       | 1.00 | 1.00 |
| AdjDel/Veh:                                 | 79.9        | 34.5 | 34.5 | 36.1        | 23.9 | 23.9 | 50.9       | 38.4 | 47.2 | 59.4       | 50.3 | 50.3 |
| LOS by Move:                                | E           | C    | C    | D           | C    | C    | D          | D    | D    | E          | D    | D    |
| HCM2k95thQ:                                 | 6           | 9    | 9    | 9           | 38   | 38   | 11         | 8    | 30   | 1          | 7    | 7    |

Note: Queue reported is the number of cars per lane.

BART

Level Of Service Computation Report  
 2000 HCM Operations (Future Volume Alternative)  
 AM - Background Conditions

Intersection #7: LAFAYETTE/REED [Study Int 45]

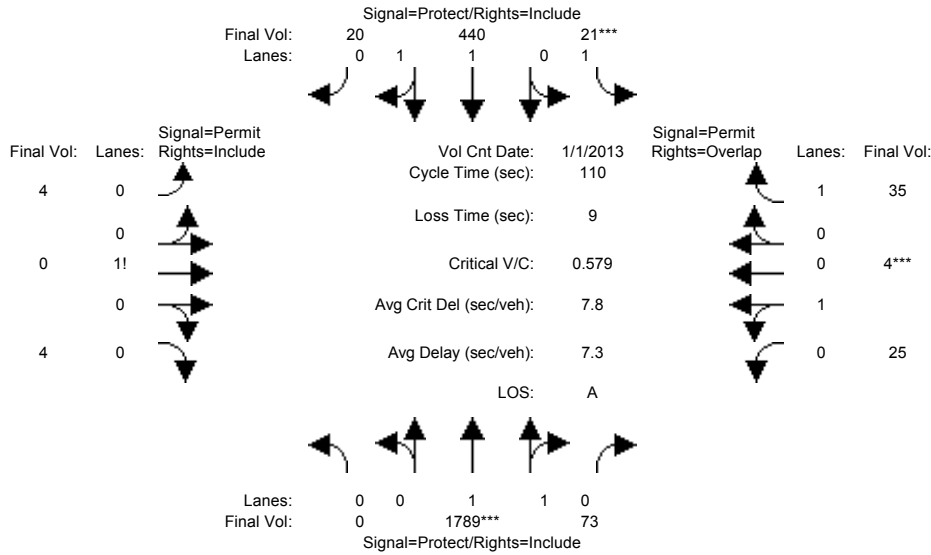

| Approach:                                   | North Bound |      |      | South Bound |      |      | East Bound |      |      | West Bound |      |      |
|---|-------------|------|------|-------------|------|------|------------|------|------|------------|------|------|
| Movement:                                   | L           | T    | R    | L           | T    | R    | L          | T    | R    | L          | T    | R    |
| Min. Green:                                 | 7           | 10   | 10   | 7           | 10   | 10   | 10         | 10   | 10   | 10         | 10   | 10   |
| Y+R:  | 4.0         | 4.0  | 4.0  | 4.0         | 4.0  | 4.0  | 4.0        | 4.0  | 4.0  | 4.0        | 4.0  | 4.0  |
| Volume Module: >> Count Date: 1 Jan 2013 << |             |      |      |             |      |      |            |      |      |            |      |      |
| Base Vol:                                   | 0           | 1789 | 73   | 21          | 440  | 20   | 4          | 0    | 4    | 25         | 4    | 35   |
| Growth Adj:                                 | 1.00        | 1.00 | 1.00 | 1.00        | 1.00 | 1.00 | 1.00       | 1.00 | 1.00 | 1.00       | 1.00 | 1.00 |
| Initial Bse:                                | 0           | 1789 | 73   | 21          | 440  | 20   | 4          | 0    | 4    | 25         | 4    | 35   |
| Added Vol:                                  | 0           | 0    | 0    | 0           | 0    | 0    | 0          | 0    | 0    | 0          | 0    | 0    |
| PasserByVol:                                | 0           | 0    | 0    | 0           | 0    | 0    | 0          | 0    | 0    | 0          | 0    | 0    |
| Initial Fut:                                | 0           | 1789 | 73   | 21          | 440  | 20   | 4          | 0    | 4    | 25         | 4    | 35   |
| User Adj:                                   | 1.00        | 1.00 | 1.00 | 1.00        | 1.00 | 1.00 | 1.00       | 1.00 | 1.00 | 1.00       | 1.00 | 1.00 |
| PHF Adj:                                    | 1.00        | 1.00 | 1.00 | 1.00        | 1.00 | 1.00 | 1.00       | 1.00 | 1.00 | 1.00       | 1.00 | 1.00 |
| PHF Volume:                                 | 0           | 1789 | 73   | 21          | 440  | 20   | 4          | 0    | 4    | 25         | 4    | 35   |
| Reduct Vol:                                 | 0           | 0    | 0    | 0           | 0    | 0    | 0          | 0    | 0    | 0          | 0    | 0    |
| Reduced Vol:                                | 0           | 1789 | 73   | 21          | 440  | 20   | 4          | 0    | 4    | 25         | 4    | 35   |
| PCE Adj:                                    | 1.00        | 1.00 | 1.00 | 1.00        | 1.00 | 1.00 | 1.00       | 1.00 | 1.00 | 1.00       | 1.00 | 1.00 |
| MLF Adj:                                    | 1.00        | 1.00 | 1.00 | 1.00        | 1.00 | 1.00 | 1.00       | 1.00 | 1.00 | 1.00       | 1.00 | 1.00 |
| Final Volume:                               | 0           | 1789 | 73   | 21          | 440  | 20   | 4          | 0    | 4    | 25         | 4    | 35   |
| Saturation Flow Module:                     |             |      |      |             |      |      |            |      |      |            |      |      |
| Sat/Lane:                                   | 1900        | 1900 | 1900 | 1900        | 1900 | 1900 | 1900       | 1900 | 1900 | 1900       | 1900 | 1900 |
| Adjustment:                                 | 0.92        | 0.97 | 0.95 | 0.92        | 0.97 | 0.95 | 0.92       | 0.92 | 0.92 | 0.95       | 0.95 | 0.92 |
| Lanes:                                      | 0.00        | 1.92 | 0.08 | 1.00        | 1.91 | 0.09 | 0.50       | 0.00 | 0.50 | 0.86       | 0.14 | 1.00 |
| Final Sat.:                                 | 0           | 3555 | 145  | 1750        | 3539 | 161  | 875        | 0    | 875  | 1552       | 248  | 1750 |
| Capacity Analysis Module:                   |             |      |      |             |      |      |            |      |      |            |      |      |
| Vol/Sat:                                    | 0.00        | 0.50 | 0.50 | 0.01        | 0.12 | 0.12 | 0.00       | 0.00 | 0.00 | 0.02       | 0.02 | 0.02 |
| Crit Moves:                                 | ****        | **** | **** | ****        | **** | **** | ****       | **** | **** | ****       | **** | **** |
| Green Time:                                 | 0.0         | 84.0 | 84.0 | 7.0         | 91.0 | 91.0 | 10.0       | 0.0  | 10.0 | 10.0       | 10.0 | 17.0 |
| Volume/Cap:                                 | 0.00        | 0.66 | 0.66 | 0.19        | 0.15 | 0.15 | 0.05       | 0.00 | 0.05 | 0.18       | 0.18 | 0.13 |
| Delay/Veh:                                  | 0.0         | 6.8  | 6.8  | 49.6        | 1.9  | 1.9  | 45.8       | 0.0  | 45.8 | 46.7       | 46.7 | 40.3 |
| User DelAdj:                                | 1.00        | 1.00 | 1.00 | 1.00        | 1.00 | 1.00 | 1.00       | 1.00 | 1.00 | 1.00       | 1.00 | 1.00 |
| AdjDel/Veh:                                 | 0.0         | 6.8  | 6.8  | 49.6        | 1.9  | 1.9  | 45.8       | 0.0  | 45.8 | 46.7       | 46.7 | 40.3 |
| LOS by Move:                                | A           | A    | A    | D           | A    | A    | D          | A    | D    | D          | D    | D    |
| HCM2k95thQ:                                 | 0           | 28   | 28   | 1           | 3    | 3    | 1          | 0    | 1    | 2          | 2    | 2    |

Note: Queue reported is the number of cars per lane.

BART

Level Of Service Computation Report  
 2000 HCM Operations (Future Volume Alternative)  
 PM - Background Conditions

Intersection #7: LAFAYETTE/REED [Study Int 45]

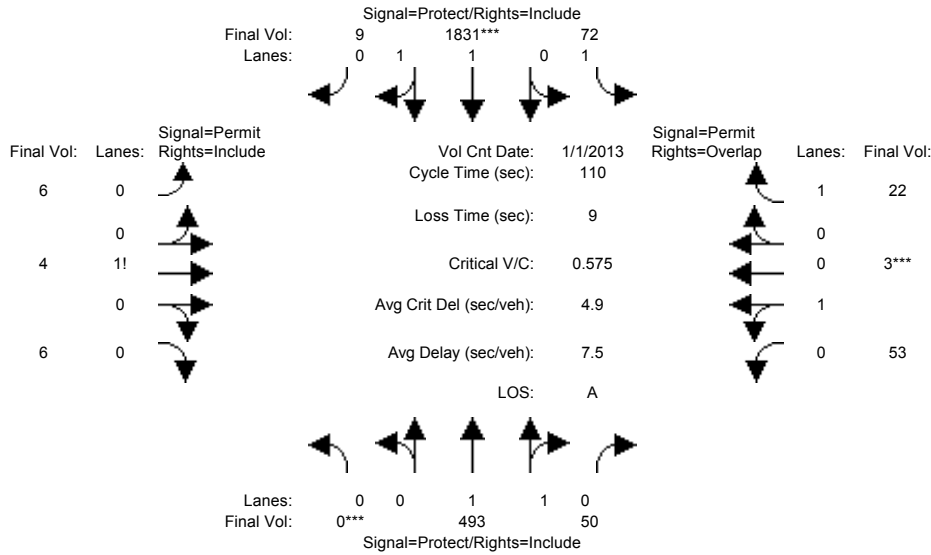

| Approach:                                   | North Bound |      |      | South Bound |      |      | East Bound |      |      | West Bound |      |      |
|---|-------------|------|------|-------------|------|------|------------|------|------|------------|------|------|
| Movement:                                   | L           | T    | R    | L           | T    | R    | L          | T    | R    | L          | T    | R    |
| Min. Green:                                 | 7           | 10   | 10   | 7           | 10   | 10   | 10         | 10   | 10   | 10         | 10   | 10   |
| Y+R:  | 4.0         | 4.0  | 4.0  | 4.0         | 4.0  | 4.0  | 4.0        | 4.0  | 4.0  | 4.0        | 4.0  | 4.0  |
| Volume Module: >> Count Date: 1 Jan 2013 << |             |      |      |             |      |      |            |      |      |            |      |      |
| Base Vol:                                   | 0           | 493  | 50   | 72          | 1831 | 9    | 6          | 4    | 6    | 53         | 3    | 22   |
| Growth Adj:                                 | 1.00        | 1.00 | 1.00 | 1.00        | 1.00 | 1.00 | 1.00       | 1.00 | 1.00 | 1.00       | 1.00 | 1.00 |
| Initial Bse:                                | 0           | 493  | 50   | 72          | 1831 | 9    | 6          | 4    | 6    | 53         | 3    | 22   |
| Added Vol:                                  | 0           | 0    | 0    | 0           | 0    | 0    | 0          | 0    | 0    | 0          | 0    | 0    |
| PasserByVol:                                | 0           | 0    | 0    | 0           | 0    | 0    | 0          | 0    | 0    | 0          | 0    | 0    |
| Initial Fut:                                | 0           | 493  | 50   | 72          | 1831 | 9    | 6          | 4    | 6    | 53         | 3    | 22   |
| User Adj:                                   | 1.00        | 1.00 | 1.00 | 1.00        | 1.00 | 1.00 | 1.00       | 1.00 | 1.00 | 1.00       | 1.00 | 1.00 |
| PHF Adj:                                    | 1.00        | 1.00 | 1.00 | 1.00        | 1.00 | 1.00 | 1.00       | 1.00 | 1.00 | 1.00       | 1.00 | 1.00 |
| PHF Volume:                                 | 0           | 493  | 50   | 72          | 1831 | 9    | 6          | 4    | 6    | 53         | 3    | 22   |
| Reduct Vol:                                 | 0           | 0    | 0    | 0           | 0    | 0    | 0          | 0    | 0    | 0          | 0    | 0    |
| Reduced Vol:                                | 0           | 493  | 50   | 72          | 1831 | 9    | 6          | 4    | 6    | 53         | 3    | 22   |
| PCE Adj:                                    | 1.00        | 1.00 | 1.00 | 1.00        | 1.00 | 1.00 | 1.00       | 1.00 | 1.00 | 1.00       | 1.00 | 1.00 |
| MLF Adj:                                    | 1.00        | 1.00 | 1.00 | 1.00        | 1.00 | 1.00 | 1.00       | 1.00 | 1.00 | 1.00       | 1.00 | 1.00 |
| Final Volume:                               | 0           | 493  | 50   | 72          | 1831 | 9    | 6          | 4    | 6    | 53         | 3    | 22   |
| Saturation Flow Module:                     |             |      |      |             |      |      |            |      |      |            |      |      |
| Sat/Lane:                                   | 1900        | 1900 | 1900 | 1900        | 1900 | 1900 | 1900       | 1900 | 1900 | 1900       | 1900 | 1900 |
| Adjustment:                                 | 0.92        | 0.98 | 0.95 | 0.92        | 0.97 | 0.95 | 0.92       | 0.92 | 0.92 | 0.95       | 0.95 | 0.92 |
| Lanes:                                      | 0.00        | 1.81 | 0.19 | 1.00        | 1.99 | 0.01 | 0.37       | 0.25 | 0.38 | 0.95       | 0.05 | 1.00 |
| Final Sat.:                                 | 0           | 3359 | 341  | 1750        | 3682 | 18   | 656        | 438  | 656  | 1704       | 96   | 1750 |
| Capacity Analysis Module:                   |             |      |      |             |      |      |            |      |      |            |      |      |
| Vol/Sat:                                    | 0.00        | 0.15 | 0.15 | 0.04        | 0.50 | 0.50 | 0.01       | 0.01 | 0.01 | 0.03       | 0.03 | 0.01 |
| Crit Moves:                                 | ****        |      |      | ****        |      |      |            |      |      | ****       |      |      |
| Green Time:                                 | 0.0         | 63.5 | 63.5 | 27.5        | 91.0 | 91.0 | 10.0       | 10.0 | 10.0 | 10.0       | 10.0 | 37.5 |
| Volume/Cap:                                 | 0.00        | 0.25 | 0.25 | 0.16        | 0.60 | 0.60 | 0.10       | 0.10 | 0.10 | 0.34       | 0.34 | 0.04 |
| Delay/Veh:                                  | 0.0         | 11.6 | 11.6 | 32.4        | 3.6  | 3.6  | 46.2       | 46.2 | 46.2 | 48.2       | 48.2 | 24.2 |
| User DelAdj:                                | 1.00        | 1.00 | 1.00 | 1.00        | 1.00 | 1.00 | 1.00       | 1.00 | 1.00 | 1.00       | 1.00 | 1.00 |
| AdjDel/Veh:                                 | 0.0         | 11.6 | 11.6 | 32.4        | 3.6  | 3.6  | 46.2       | 46.2 | 46.2 | 48.2       | 48.2 | 24.2 |
| LOS by Move:                                | A           | B    | B    | C           | A    | A    | D          | D    | D    | D          | D    | C    |
| HCM2k95thQ:                                 | 0           | 9    | 9    | 4           | 21   | 21   | 1          | 1    | 1    | 4          | 4    | 1    |

Note: Queue reported is the number of cars per lane.

BART

Level Of Service Computation Report  
2000 HCM Operations (Future Volume Alternative)  
AM - Background Conditions

Intersection #9: Coleman/Brokaw [Study Int 33]

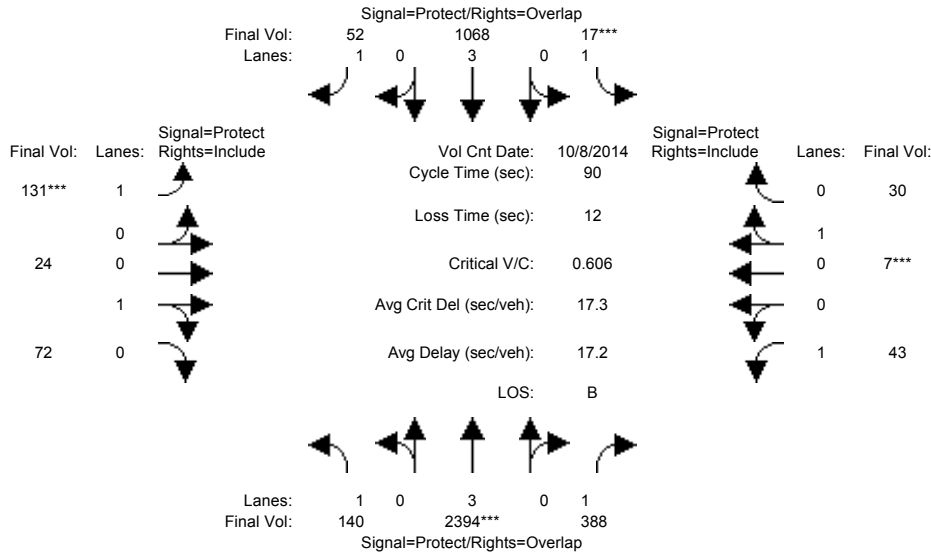

| Approach:                                   | North Bound |      |      | South Bound |      |      | East Bound |      |      | West Bound |      |      |
|---|-------------|------|------|-------------|------|------|------------|------|------|------------|------|------|
| Movement:                                   | L           | T    | R    | L           | T    | R    | L          | T    | R    | L          | T    | R    |
| Min. Green:                                 | 7           | 10   | 10   | 7           | 10   | 10   | 7          | 10   | 10   | 7          | 10   | 10   |
| Y+R:  | 4.0         | 4.0  | 4.0  | 4.0         | 4.0  | 4.0  | 4.0        | 4.0  | 4.0  | 4.0        | 4.0  | 4.0  |
| Volume Module: >> Count Date: 8 Oct 2014 << |             |      |      |             |      |      |            |      |      |            |      |      |
| Base Vol:                                   | 140         | 2394 | 388  | 17          | 1068 | 52   | 131        | 24   | 72   | 43         | 7    | 30   |
| Growth Adj:                                 | 1.00        | 1.00 | 1.00 | 1.00        | 1.00 | 1.00 | 1.00       | 1.00 | 1.00 | 1.00       | 1.00 | 1.00 |
| Initial Bse:                                | 140         | 2394 | 388  | 17          | 1068 | 52   | 131        | 24   | 72   | 43         | 7    | 30   |
| Added Vol:                                  | 0           | 0    | 0    | 0           | 0    | 0    | 0          | 0    | 0    | 0          | 0    | 0    |
| PasserByVol:                                | 0           | 0    | 0    | 0           | 0    | 0    | 0          | 0    | 0    | 0          | 0    | 0    |
| Initial Fut:                                | 140         | 2394 | 388  | 17          | 1068 | 52   | 131        | 24   | 72   | 43         | 7    | 30   |
| User Adj:                                   | 1.00        | 1.00 | 1.00 | 1.00        | 1.00 | 1.00 | 1.00       | 1.00 | 1.00 | 1.00       | 1.00 | 1.00 |
| PHF Adj:                                    | 1.00        | 1.00 | 1.00 | 1.00        | 1.00 | 1.00 | 1.00       | 1.00 | 1.00 | 1.00       | 1.00 | 1.00 |
| PHF Volume:                                 | 140         | 2394 | 388  | 17          | 1068 | 52   | 131        | 24   | 72   | 43         | 7    | 30   |
| Reduct Vol:                                 | 0           | 0    | 0    | 0           | 0    | 0    | 0          | 0    | 0    | 0          | 0    | 0    |
| Reduced Vol:                                | 140         | 2394 | 388  | 17          | 1068 | 52   | 131        | 24   | 72   | 43         | 7    | 30   |
| PCE Adj:                                    | 1.00        | 1.00 | 1.00 | 1.00        | 1.00 | 1.00 | 1.00       | 1.00 | 1.00 | 1.00       | 1.00 | 1.00 |
| MLF Adj:                                    | 1.00        | 1.00 | 1.00 | 1.00        | 1.00 | 1.00 | 1.00       | 1.00 | 1.00 | 1.00       | 1.00 | 1.00 |
| Final Volume:                               | 140         | 2394 | 388  | 17          | 1068 | 52   | 131        | 24   | 72   | 43         | 7    | 30   |
| Saturation Flow Module:                     |             |      |      |             |      |      |            |      |      |            |      |      |
| Sat/Lane:                                   | 1900        | 1900 | 1900 | 1900        | 1900 | 1900 | 1900       | 1900 | 1900 | 1900       | 1900 | 1900 |
| Adjustment:                                 | 0.92        | 1.00 | 0.92 | 0.92        | 1.00 | 0.92 | 0.92       | 0.95 | 0.95 | 0.92       | 0.95 | 0.95 |
| Lanes:                                      | 1.00        | 3.00 | 1.00 | 1.00        | 3.00 | 1.00 | 1.00       | 0.25 | 0.75 | 1.00       | 0.19 | 0.81 |
| Final Sat.:                                 | 1750        | 5700 | 1750 | 1750        | 5700 | 1750 | 1750       | 450  | 1350 | 1750       | 341  | 1459 |
| Capacity Analysis Module:                   |             |      |      |             |      |      |            |      |      |            |      |      |
| Vol/Sat:                                    | 0.08        | 0.42 | 0.22 | 0.01        | 0.19 | 0.03 | 0.07       | 0.05 | 0.05 | 0.02       | 0.02 | 0.02 |
| Crit Moves:                                 | ****        | **** | **** | ****        | **** | **** | ****       | **** | **** | ****       | **** | **** |
| Green Time:                                 | 17.6        | 51.8 | 59.7 | 7.0         | 41.2 | 50.4 | 9.2        | 11.3 | 11.3 | 7.9        | 10.0 | 10.0 |
| Volume/Cap:                                 | 0.41        | 0.73 | 0.33 | 0.12        | 0.41 | 0.05 | 0.73       | 0.42 | 0.42 | 0.28       | 0.19 | 0.19 |
| Delay/Veh:                                  | 32.5        | 14.9 | 6.7  | 39.1        | 16.4 | 9.0  | 53.3       | 37.6 | 37.6 | 39.4       | 36.8 | 36.8 |
| User DelAdj:                                | 1.00        | 1.00 | 1.00 | 1.00        | 1.00 | 1.00 | 1.00       | 1.00 | 1.00 | 1.00       | 1.00 | 1.00 |
| AdjDel/Veh:                                 | 32.5        | 14.9 | 6.7  | 39.1        | 16.4 | 9.0  | 53.3       | 37.6 | 37.6 | 39.4       | 36.8 | 36.8 |
| LOS by Move:                                | C           | B    | A    | D           | B    | A    | D          | D    | D    | D          | D    | D    |
| HCM2k95thQ:                                 | 7           | 26   | 9    | 1           | 12   | 1    | 11         | 6    | 6    | 2          | 2    | 2    |

Note: Queue reported is the number of cars per lane.

BART

Level Of Service Computation Report  
2000 HCM Operations (Future Volume Alternative)  
PM - Background Conditions

Intersection #9: Coleman/Brokaw [Study Int 33]

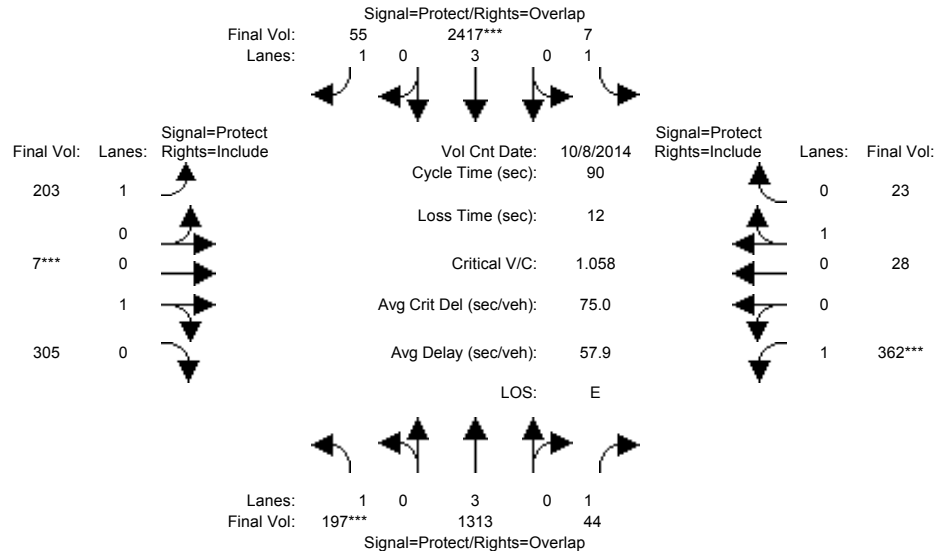

| Approach:                                   | North Bound |      |      | South Bound |      |      | East Bound |      |       | West Bound |      |      |
|---|-------------|------|------|-------------|------|------|------------|------|-------|------------|------|------|
| Movement:                                   | L           | T    | R    | L           | T    | R    | L          | T    | R     | L          | T    | R    |
| Min. Green:                                 | 7           | 10   | 10   | 7           | 10   | 10   | 7          | 10   | 10    | 7          | 10   | 10   |
| Y+R:  | 4.0         | 4.0  | 4.0  | 4.0         | 4.0  | 4.0  | 4.0        | 4.0  | 4.0   | 4.0        | 4.0  | 4.0  |
| Volume Module: >> Count Date: 8 Oct 2014 << |             |      |      |             |      |      |            |      |       |            |      |      |
| Base Vol:                                   | 197         | 1313 | 44   | 7           | 2417 | 55   | 203        | 7    | 305   | 362        | 28   | 23   |
| Growth Adj:                                 | 1.00        | 1.00 | 1.00 | 1.00        | 1.00 | 1.00 | 1.00       | 1.00 | 1.00  | 1.00       | 1.00 | 1.00 |
| Initial Bse:                                | 197         | 1313 | 44   | 7           | 2417 | 55   | 203        | 7    | 305   | 362        | 28   | 23   |
| Added Vol:                                  | 0           | 0    | 0    | 0           | 0    | 0    | 0          | 0    | 0     | 0          | 0    | 0    |
| PasserByVol:                                | 0           | 0    | 0    | 0           | 0    | 0    | 0          | 0    | 0     | 0          | 0    | 0    |
| Initial Fut:                                | 197         | 1313 | 44   | 7           | 2417 | 55   | 203        | 7    | 305   | 362        | 28   | 23   |
| User Adj:                                   | 1.00        | 1.00 | 1.00 | 1.00        | 1.00 | 1.00 | 1.00       | 1.00 | 1.00  | 1.00       | 1.00 | 1.00 |
| PHF Adj:                                    | 1.00        | 1.00 | 1.00 | 1.00        | 1.00 | 1.00 | 1.00       | 1.00 | 1.00  | 1.00       | 1.00 | 1.00 |
| PHF Volume:                                 | 197         | 1313 | 44   | 7           | 2417 | 55   | 203        | 7    | 305   | 362        | 28   | 23   |
| Reduct Vol:                                 | 0           | 0    | 0    | 0           | 0    | 0    | 0          | 0    | 0     | 0          | 0    | 0    |
| Reduced Vol:                                | 197         | 1313 | 44   | 7           | 2417 | 55   | 203        | 7    | 305   | 362        | 28   | 23   |
| PCE Adj:                                    | 1.00        | 1.00 | 1.00 | 1.00        | 1.00 | 1.00 | 1.00       | 1.00 | 1.00  | 1.00       | 1.00 | 1.00 |
| MLF Adj:                                    | 1.00        | 1.00 | 1.00 | 1.00        | 1.00 | 1.00 | 1.00       | 1.00 | 1.00  | 1.00       | 1.00 | 1.00 |
| Final Volume:                               | 197         | 1313 | 44   | 7           | 2417 | 55   | 203        | 7    | 305   | 362        | 28   | 23   |
| Saturation Flow Module:                     |             |      |      |             |      |      |            |      |       |            |      |      |
| Sat/Lane:                                   | 1900        | 1900 | 1900 | 1900        | 1900 | 1900 | 1900       | 1900 | 1900  | 1900       | 1900 | 1900 |
| Adjustment:                                 | 0.92        | 1.00 | 0.92 | 0.92        | 1.00 | 0.92 | 0.92       | 0.95 | 0.95  | 0.92       | 0.95 | 0.95 |
| Lanes:                                      | 1.00        | 3.00 | 1.00 | 1.00        | 3.00 | 1.00 | 1.00       | 0.02 | 0.98  | 1.00       | 0.55 | 0.45 |
| Final Sat.:                                 | 1750        | 5700 | 1750 | 1750        | 5700 | 1750 | 1750       | 40   | 1760  | 1750       | 988  | 812  |
| Capacity Analysis Module:                   |             |      |      |             |      |      |            |      |       |            |      |      |
| Vol/Sat:                                    | 0.11        | 0.23 | 0.03 | 0.00        | 0.42 | 0.03 | 0.12       | 0.17 | 0.17  | 0.21       | 0.03 | 0.03 |
| Crit Moves:                                 | ****        |      |      | ****        |      |      | ****       |      |       | ****       |      |      |
| Green Time:                                 | 9.6         | 34.1 | 51.7 | 11.5        | 36.1 | 52.6 | 16.5       | 14.7 | 14.7  | 17.6       | 15.8 | 15.8 |
| Volume/Cap:                                 | 1.06        | 0.61 | 0.04 | 0.03        | 1.06 | 0.05 | 0.63       | 1.06 | 1.06  | 1.06       | 0.16 | 0.16 |
| Delay/Veh:                                  | 122.3       | 23.0 | 8.4  | 34.4        | 63.3 | 8.0  | 38.0       | 106  | 106.1 | 100.9      | 31.7 | 31.7 |
| User DelAdj:                                | 1.00        | 1.00 | 1.00 | 1.00        | 1.00 | 1.00 | 1.00       | 1.00 | 1.00  | 1.00       | 1.00 | 1.00 |
| AdjDel/Veh:                                 | 122.3       | 23.0 | 8.4  | 34.4        | 63.3 | 8.0  | 38.0       | 106  | 106.1 | 100.9      | 31.7 | 31.7 |
| LOS by Move:                                | F           | C    | A    | C           | E    | A    | D          | F    | F     | F          | C    | C    |
| HCM2k95thQ:                                 | 16          | 18   | 1    | 0           | 50   | 1    | 13         | 28   | 28    | 27         | 2    | 2    |

Note: Queue reported is the number of cars per lane.

BART

Level Of Service Computation Report  
 2000 HCM Operations (Future Volume Alternative)  
 AM - Background Conditions

Intersection #106: Benton/E/ Camino Real [Study Int 52]

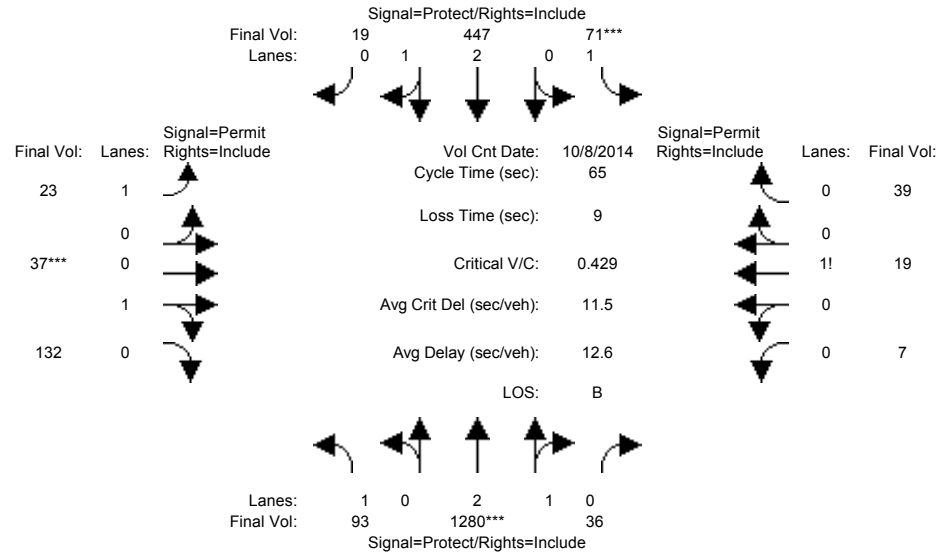

| Approach:                                   | North Bound |      |      | South Bound |      |      | East Bound |      |      | West Bound |      |      |
|---|-------------|------|------|-------------|------|------|------------|------|------|------------|------|------|
| Movement:                                   | L           | T    | R    | L           | T    | R    | L          | T    | R    | L          | T    | R    |
| Min. Green:                                 | 7           | 10   | 10   | 7           | 10   | 10   | 10         | 10   | 10   | 10         | 10   | 10   |
| Y+R:  | 4.0         | 4.0  | 4.0  | 4.0         | 4.0  | 4.0  | 4.0        | 4.0  | 4.0  | 4.0        | 4.0  | 4.0  |
| Volume Module: >> Count Date: 8 Oct 2014 << |             |      |      |             |      |      |            |      |      |            |      |      |
| Base Vol:                                   | 93          | 1280 | 36   | 71          | 447  | 19   | 23         | 37   | 132  | 7          | 19   | 39   |
| Growth Adj:                                 | 1.00        | 1.00 | 1.00 | 1.00        | 1.00 | 1.00 | 1.00       | 1.00 | 1.00 | 1.00       | 1.00 | 1.00 |
| Initial Bse:                                | 93          | 1280 | 36   | 71          | 447  | 19   | 23         | 37   | 132  | 7          | 19   | 39   |
| Added Vol:                                  | 0           | 0    | 0    | 0           | 0    | 0    | 0          | 0    | 0    | 0          | 0    | 0    |
| PasserByVol:                                | 0           | 0    | 0    | 0           | 0    | 0    | 0          | 0    | 0    | 0          | 0    | 0    |
| Initial Fut:                                | 93          | 1280 | 36   | 71          | 447  | 19   | 23         | 37   | 132  | 7          | 19   | 39   |
| User Adj:                                   | 1.00        | 1.00 | 1.00 | 1.00        | 1.00 | 1.00 | 1.00       | 1.00 | 1.00 | 1.00       | 1.00 | 1.00 |
| PHF Adj:                                    | 1.00        | 1.00 | 1.00 | 1.00        | 1.00 | 1.00 | 1.00       | 1.00 | 1.00 | 1.00       | 1.00 | 1.00 |
| PHF Volume:                                 | 93          | 1280 | 36   | 71          | 447  | 19   | 23         | 37   | 132  | 7          | 19   | 39   |
| Reduct Vol:                                 | 0           | 0    | 0    | 0           | 0    | 0    | 0          | 0    | 0    | 0          | 0    | 0    |
| Reduced Vol:                                | 93          | 1280 | 36   | 71          | 447  | 19   | 23         | 37   | 132  | 7          | 19   | 39   |
| PCE Adj:                                    | 1.00        | 1.00 | 1.00 | 1.00        | 1.00 | 1.00 | 1.00       | 1.00 | 1.00 | 1.00       | 1.00 | 1.00 |
| MLF Adj:                                    | 1.00        | 1.00 | 1.00 | 1.00        | 1.00 | 1.00 | 1.00       | 1.00 | 1.00 | 1.00       | 1.00 | 1.00 |
| Final Volume:                               | 93          | 1280 | 36   | 71          | 447  | 19   | 23         | 37   | 132  | 7          | 19   | 39   |
| Saturation Flow Module:                     |             |      |      |             |      |      |            |      |      |            |      |      |
| Sat/Lane:                                   | 1900        | 1900 | 1900 | 1900        | 1900 | 1900 | 1900       | 1900 | 1900 | 1900       | 1900 | 1900 |
| Adjustment:                                 | 0.92        | 0.98 | 0.95 | 0.92        | 0.98 | 0.95 | 0.92       | 0.95 | 0.95 | 0.92       | 0.92 | 0.92 |
| Lanes:                                      | 1.00        | 2.91 | 0.09 | 1.00        | 2.87 | 0.13 | 1.00       | 0.22 | 0.78 | 0.11       | 0.29 | 0.60 |
| Final Sat.:                                 | 1750        | 5447 | 153  | 1750        | 5371 | 228  | 1750       | 394  | 1406 | 188        | 512  | 1050 |
| Capacity Analysis Module:                   |             |      |      |             |      |      |            |      |      |            |      |      |
| Vol/Sat:                                    | 0.05        | 0.24 | 0.24 | 0.04        | 0.08 | 0.08 | 0.01       | 0.09 | 0.09 | 0.04       | 0.04 | 0.04 |
| Crit Moves:                                 | ****        |      |      | ****        |      |      | ****       |      |      |            |      |      |
| Green Time:                                 | 17.3        | 35.0 | 35.0 | 7.0         | 24.7 | 24.7 | 14.0       | 14.0 | 14.0 | 14.0       | 14.0 | 14.0 |
| Volume/Cap:                                 | 0.20        | 0.44 | 0.44 | 0.38        | 0.22 | 0.22 | 0.06       | 0.44 | 0.44 | 0.17       | 0.17 | 0.17 |
| Delay/Veh:                                  | 18.7        | 9.1  | 9.1  | 28.2        | 13.7 | 13.7 | 20.4       | 22.9 | 22.9 | 21.0       | 21.0 | 21.0 |
| User DelAdj:                                | 1.00        | 1.00 | 1.00 | 1.00        | 1.00 | 1.00 | 1.00       | 1.00 | 1.00 | 1.00       | 1.00 | 1.00 |
| AdjDel/Veh:                                 | 18.7        | 9.1  | 9.1  | 28.2        | 13.7 | 13.7 | 20.4       | 22.9 | 22.9 | 21.0       | 21.0 | 21.0 |
| LOS by Move:                                | B           | A    | A    | C           | B    | B    | C          | C    | C    | C          | C    | C    |
| HCM2k95thQ:                                 | 3           | 10   | 10   | 3           | 4    | 4    | 1          | 6    | 6    | 3          | 3    | 3    |

Note: Queue reported is the number of cars per lane.

BART

Level Of Service Computation Report  
 2000 HCM Operations (Future Volume Alternative)  
 PM - Background Conditions

Intersection #106: Benton/E/ Camino Real [Study Int 52]

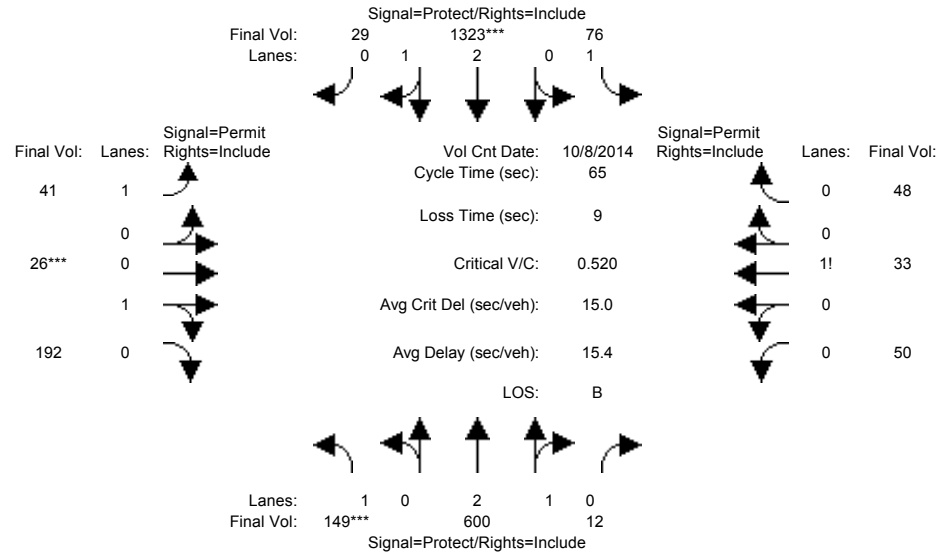

| Approach:                                   | North Bound |      |      | South Bound |      |      | East Bound |      |      | West Bound |      |      |
|---|-------------|------|------|-------------|------|------|------------|------|------|------------|------|------|
| Movement:                                   | L           | T    | R    | L           | T    | R    | L          | T    | R    | L          | T    | R    |
| Min. Green:                                 | 7           | 10   | 10   | 7           | 10   | 10   | 10         | 10   | 10   | 10         | 10   | 10   |
| Y+R:  | 4.0         | 4.0  | 4.0  | 4.0         | 4.0  | 4.0  | 4.0        | 4.0  | 4.0  | 4.0        | 4.0  | 4.0  |
| Volume Module: >> Count Date: 8 Oct 2014 << |             |      |      |             |      |      |            |      |      |            |      |      |
| Base Vol:                                   | 149         | 600  | 12   | 76          | 1323 | 29   | 41         | 26   | 192  | 50         | 33   | 48   |
| Growth Adj:                                 | 1.00        | 1.00 | 1.00 | 1.00        | 1.00 | 1.00 | 1.00       | 1.00 | 1.00 | 1.00       | 1.00 | 1.00 |
| Initial Bse:                                | 149         | 600  | 12   | 76          | 1323 | 29   | 41         | 26   | 192  | 50         | 33   | 48   |
| Added Vol:                                  | 0           | 0    | 0    | 0           | 0    | 0    | 0          | 0    | 0    | 0          | 0    | 0    |
| PasserByVol:                                | 0           | 0    | 0    | 0           | 0    | 0    | 0          | 0    | 0    | 0          | 0    | 0    |
| Initial Fut:                                | 149         | 600  | 12   | 76          | 1323 | 29   | 41         | 26   | 192  | 50         | 33   | 48   |
| User Adj:                                   | 1.00        | 1.00 | 1.00 | 1.00        | 1.00 | 1.00 | 1.00       | 1.00 | 1.00 | 1.00       | 1.00 | 1.00 |
| PHF Adj:                                    | 1.00        | 1.00 | 1.00 | 1.00        | 1.00 | 1.00 | 1.00       | 1.00 | 1.00 | 1.00       | 1.00 | 1.00 |
| PHF Volume:                                 | 149         | 600  | 12   | 76          | 1323 | 29   | 41         | 26   | 192  | 50         | 33   | 48   |
| Reduct Vol:                                 | 0           | 0    | 0    | 0           | 0    | 0    | 0          | 0    | 0    | 0          | 0    | 0    |
| Reduced Vol:                                | 149         | 600  | 12   | 76          | 1323 | 29   | 41         | 26   | 192  | 50         | 33   | 48   |
| PCE Adj:                                    | 1.00        | 1.00 | 1.00 | 1.00        | 1.00 | 1.00 | 1.00       | 1.00 | 1.00 | 1.00       | 1.00 | 1.00 |
| MLF Adj:                                    | 1.00        | 1.00 | 1.00 | 1.00        | 1.00 | 1.00 | 1.00       | 1.00 | 1.00 | 1.00       | 1.00 | 1.00 |
| Final Volume:                               | 149         | 600  | 12   | 76          | 1323 | 29   | 41         | 26   | 192  | 50         | 33   | 48   |
| Saturation Flow Module:                     |             |      |      |             |      |      |            |      |      |            |      |      |
| Sat/Lane:                                   | 1900        | 1900 | 1900 | 1900        | 1900 | 1900 | 1900       | 1900 | 1900 | 1900       | 1900 | 1900 |
| Adjustment:                                 | 0.92        | 0.98 | 0.95 | 0.92        | 0.98 | 0.95 | 0.92       | 0.95 | 0.95 | 0.92       | 0.92 | 0.92 |
| Lanes:                                      | 1.00        | 2.94 | 0.06 | 1.00        | 2.93 | 0.07 | 1.00       | 0.12 | 0.88 | 0.38       | 0.25 | 0.37 |
| Final Sat.:                                 | 1750        | 5490 | 110  | 1750        | 5480 | 120  | 1750       | 215  | 1585 | 668        | 441  | 641  |
| Capacity Analysis Module:                   |             |      |      |             |      |      |            |      |      |            |      |      |
| Vol/Sat:                                    | 0.09        | 0.11 | 0.11 | 0.04        | 0.24 | 0.24 | 0.02       | 0.12 | 0.12 | 0.07       | 0.07 | 0.07 |
| Crit Moves:                                 | ****        |      |      | ****        |      |      | ****       |      |      |            |      |      |
| Green Time:                                 | 10.7        | 24.0 | 24.0 | 16.8        | 30.2 | 30.2 | 15.1       | 15.1 | 15.1 | 15.1       | 15.1 | 15.1 |
| Volume/Cap:                                 | 0.52        | 0.30 | 0.30 | 0.17        | 0.52 | 0.52 | 0.10       | 0.52 | 0.52 | 0.32       | 0.32 | 0.32 |
| Delay/Veh:                                  | 26.5        | 14.6 | 14.6 | 18.8        | 12.5 | 12.5 | 19.7       | 22.9 | 22.9 | 21.1       | 21.1 | 21.1 |
| User DelAdj:                                | 1.00        | 1.00 | 1.00 | 1.00        | 1.00 | 1.00 | 1.00       | 1.00 | 1.00 | 1.00       | 1.00 | 1.00 |
| AdjDel/Veh:                                 | 26.5        | 14.6 | 14.6 | 18.8        | 12.5 | 12.5 | 19.7       | 22.9 | 22.9 | 21.1       | 21.1 | 21.1 |
| LOS by Move:                                | C           | B    | B    | B           | B    | B    | B          | C    | C    | C          | C    | C    |
| HCM2k95thQ:                                 | 6           | 6    | 6    | 3           | 12   | 12   | 1          | 8    | 8    | 5          | 5    | 5    |

Note: Queue reported is the number of cars per lane.

BART

Level Of Service Computation Report  
2000 HCM Operations (Future Volume Alternative)  
AM - Background Conditions

Intersection #107: Lafayette/Benton [Study Int 49]

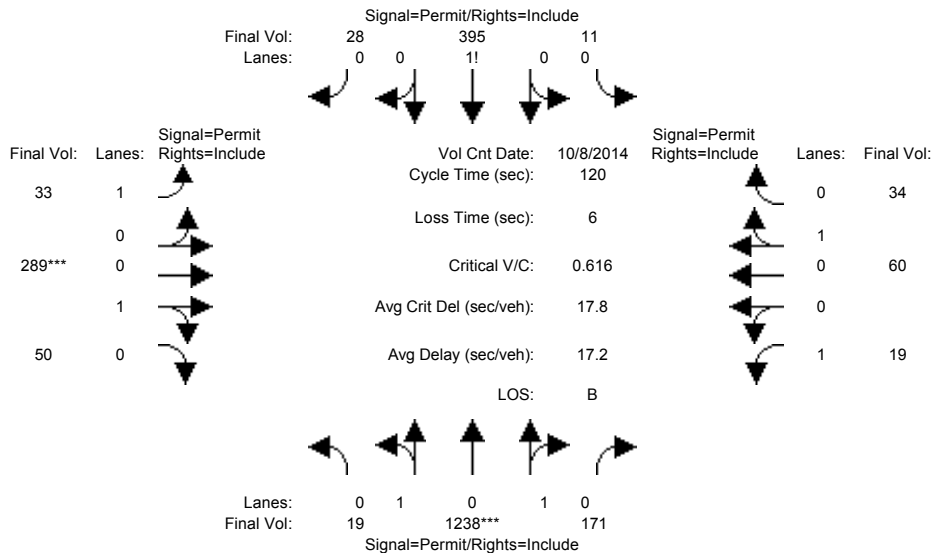

| Approach:                 | North Bound                  |      |      | South Bound |      |      | East Bound |      |      | West Bound |      |      |
|---------------------------|------------------------------|------|------|-------------|------|------|------------|------|------|------------|------|------|
| Movement:                 | L                            | T    | R    | L           | T    | R    | L          | T    | R    | L          | T    | R    |
| Min. Green:               | 10                           | 10   | 10   | 10          | 10   | 10   | 10         | 10   | 10   | 10         | 10   | 10   |
| Y+R:                      | 4.0                          | 4.0  | 4.0  | 4.0         | 4.0  | 4.0  | 4.0        | 4.0  | 4.0  | 4.0        | 4.0  | 4.0  |
| -----                     |                              |      |      |             |      |      |            |      |      |            |      |      |
| Volume Module:            | >> Count Date: 8 Oct 2014 << |      |      |             |      |      |            |      |      |            |      |      |
| Base Vol:                 | 19                           | 1238 | 171  | 11          | 395  | 28   | 33         | 289  | 50   | 19         | 60   | 34   |
| Growth Adj:               | 1.00                         | 1.00 | 1.00 | 1.00        | 1.00 | 1.00 | 1.00       | 1.00 | 1.00 | 1.00       | 1.00 | 1.00 |
| Initial Bse:              | 19                           | 1238 | 171  | 11          | 395  | 28   | 33         | 289  | 50   | 19         | 60   | 34   |
| Added Vol:                | 0                            | 0    | 0    | 0           | 0    | 0    | 0          | 0    | 0    | 0          | 0    | 0    |
| PasserByVol:              | 0                            | 0    | 0    | 0           | 0    | 0    | 0          | 0    | 0    | 0          | 0    | 0    |
| Initial Fut:              | 19                           | 1238 | 171  | 11          | 395  | 28   | 33         | 289  | 50   | 19         | 60   | 34   |
| User Adj:                 | 1.00                         | 1.00 | 1.00 | 1.00        | 1.00 | 1.00 | 1.00       | 1.00 | 1.00 | 1.00       | 1.00 | 1.00 |
| PHF Adj:                  | 1.00                         | 1.00 | 1.00 | 1.00        | 1.00 | 1.00 | 1.00       | 1.00 | 1.00 | 1.00       | 1.00 | 1.00 |
| PHF Volume:               | 19                           | 1238 | 171  | 11          | 395  | 28   | 33         | 289  | 50   | 19         | 60   | 34   |
| Reduct Vol:               | 0                            | 0    | 0    | 0           | 0    | 0    | 0          | 0    | 0    | 0          | 0    | 0    |
| Reduced Vol:              | 19                           | 1238 | 171  | 11          | 395  | 28   | 33         | 289  | 50   | 19         | 60   | 34   |
| PCE Adj:                  | 1.00                         | 1.00 | 1.00 | 1.00        | 1.00 | 1.00 | 1.00       | 1.00 | 1.00 | 1.00       | 1.00 | 1.00 |
| MLF Adj:                  | 1.00                         | 1.00 | 1.00 | 1.00        | 1.00 | 1.00 | 1.00       | 1.00 | 1.00 | 1.00       | 1.00 | 1.00 |
| FinalVolume:              | 19                           | 1238 | 171  | 11          | 395  | 28   | 33         | 289  | 50   | 19         | 60   | 34   |
| -----                     |                              |      |      |             |      |      |            |      |      |            |      |      |
| Saturation Flow Module:   |                              |      |      |             |      |      |            |      |      |            |      |      |
| Sat/Lane:                 | 1900                         | 1900 | 1900 | 1900        | 1900 | 1900 | 1900       | 1900 | 1900 | 1900       | 1900 | 1900 |
| Adjustment:               | 0.95                         | 0.95 | 0.95 | 0.92        | 0.92 | 0.92 | 0.92       | 0.95 | 0.95 | 0.92       | 0.95 | 0.95 |
| Lanes:                    | 0.03                         | 1.73 | 0.24 | 0.03        | 0.91 | 0.06 | 1.00       | 0.85 | 0.15 | 1.00       | 0.64 | 0.36 |
| Final Sat.:               | 48                           | 3121 | 431  | 44          | 1593 | 113  | 1750       | 1535 | 265  | 1750       | 1149 | 651  |
| -----                     |                              |      |      |             |      |      |            |      |      |            |      |      |
| Capacity Analysis Module: |                              |      |      |             |      |      |            |      |      |            |      |      |
| Vol/Sat:                  | 0.40                         | 0.40 | 0.40 | 0.25        | 0.25 | 0.25 | 0.02       | 0.19 | 0.19 | 0.01       | 0.05 | 0.05 |
| Crit Moves:               | ****                         |      |      | ****        |      |      | ****       |      |      | ****       |      |      |
| Green Time:               | 77.3                         | 77.3 | 77.3 | 77.3        | 77.3 | 77.3 | 36.7       | 36.7 | 36.7 | 36.7       | 36.7 | 36.7 |
| Volume/Cap:               | 0.62                         | 0.62 | 0.62 | 0.38        | 0.38 | 0.38 | 0.06       | 0.62 | 0.62 | 0.04       | 0.17 | 0.17 |
| Delay/Veh:                | 13.1                         | 13.1 | 13.1 | 10.3        | 10.3 | 10.3 | 29.5       | 37.7 | 37.7 | 29.3       | 30.7 | 30.7 |
| User DelAdj:              | 1.00                         | 1.00 | 1.00 | 1.00        | 1.00 | 1.00 | 1.00       | 1.00 | 1.00 | 1.00       | 1.00 | 1.00 |
| AdjDel/Veh:               | 13.1                         | 13.1 | 13.1 | 10.3        | 10.3 | 10.3 | 29.5       | 37.7 | 37.7 | 29.3       | 30.7 | 30.7 |
| LOS by Move:              | B                            | B    | B    | B           | B    | B    | C          | D    | D    | C          | C    | C    |
| HCM2k95thQ:               | 27                           | 27   | 27   | 15          | 15   | 15   | 2          | 20   | 20   | 1          | 5    | 5    |

Note: Queue reported is the number of cars per lane.



BART

Level Of Service Computation Report  
 2000 HCM Operations (Future Volume Alternative)  
 PM - Background Conditions

Intersection #107: Lafayette/Benton [Study Int 49]

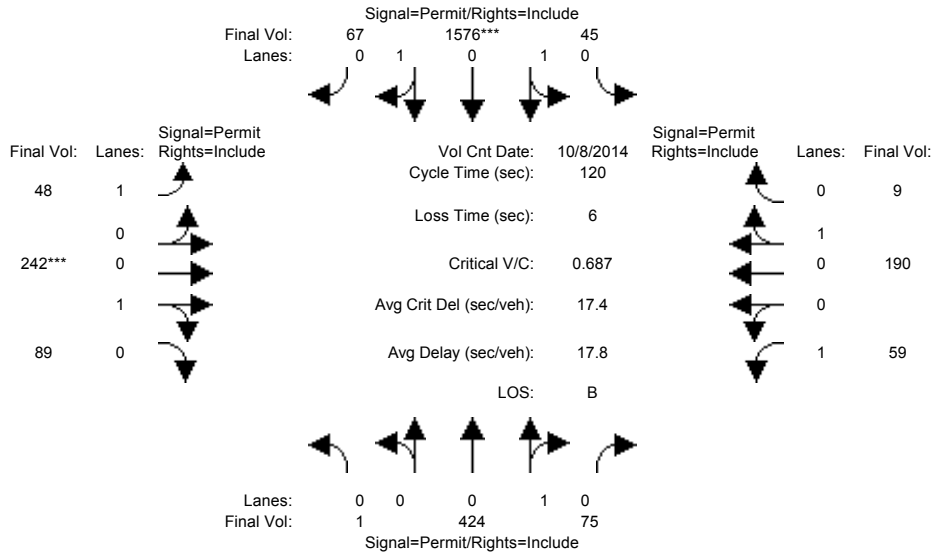

| Approach:                                   | North Bound |      |      | South Bound |      |      | East Bound |      |      | West Bound |      |      |
|---|-------------|------|------|-------------|------|------|------------|------|------|------------|------|------|
| Movement:                                   | L           | T    | R    | L           | T    | R    | L          | T    | R    | L          | T    | R    |
| Min. Green:                                 | 10          | 10   | 10   | 10          | 10   | 10   | 10         | 10   | 10   | 10         | 10   | 10   |
| Y+R:  | 4.0         | 4.0  | 4.0  | 4.0         | 4.0  | 4.0  | 4.0        | 4.0  | 4.0  | 4.0        | 4.0  | 4.0  |
| Volume Module: >> Count Date: 8 Oct 2014 << |             |      |      |             |      |      |            |      |      |            |      |      |
| Base Vol:                                   | 1           | 424  | 75   | 45          | 1576 | 67   | 48         | 242  | 89   | 59         | 190  | 9    |
| Growth Adj:                                 | 1.00        | 1.00 | 1.00 | 1.00        | 1.00 | 1.00 | 1.00       | 1.00 | 1.00 | 1.00       | 1.00 | 1.00 |
| Initial Bse:                                | 1           | 424  | 75   | 45          | 1576 | 67   | 48         | 242  | 89   | 59         | 190  | 9    |
| Added Vol:                                  | 0           | 0    | 0    | 0           | 0    | 0    | 0          | 0    | 0    | 0          | 0    | 0    |
| PasserByVol:                                | 0           | 0    | 0    | 0           | 0    | 0    | 0          | 0    | 0    | 0          | 0    | 0    |
| Initial Fut:                                | 1           | 424  | 75   | 45          | 1576 | 67   | 48         | 242  | 89   | 59         | 190  | 9    |
| User Adj:                                   | 1.00        | 1.00 | 1.00 | 1.00        | 1.00 | 1.00 | 1.00       | 1.00 | 1.00 | 1.00       | 1.00 | 1.00 |
| PHF Adj:                                    | 1.00        | 1.00 | 1.00 | 1.00        | 1.00 | 1.00 | 1.00       | 1.00 | 1.00 | 1.00       | 1.00 | 1.00 |
| PHF Volume:                                 | 1           | 424  | 75   | 45          | 1576 | 67   | 48         | 242  | 89   | 59         | 190  | 9    |
| Reduct Vol:                                 | 0           | 0    | 0    | 0           | 0    | 0    | 0          | 0    | 0    | 0          | 0    | 0    |
| Reduced Vol:                                | 1           | 424  | 75   | 45          | 1576 | 67   | 48         | 242  | 89   | 59         | 190  | 9    |
| PCE Adj:                                    | 1.00        | 1.00 | 1.00 | 1.00        | 1.00 | 1.00 | 1.00       | 1.00 | 1.00 | 1.00       | 1.00 | 1.00 |
| MLF Adj:                                    | 1.00        | 1.00 | 1.00 | 1.00        | 1.00 | 1.00 | 1.00       | 1.00 | 1.00 | 1.00       | 1.00 | 1.00 |
| Final Volume:                               | 1           | 424  | 75   | 45          | 1576 | 67   | 48         | 242  | 89   | 59         | 190  | 9    |
| Saturation Flow Module:                     |             |      |      |             |      |      |            |      |      |            |      |      |
| Sat/Lane:                                   | 1900        | 1900 | 1900 | 1900        | 1900 | 1900 | 1900       | 1900 | 1900 | 1900       | 1900 | 1900 |
| Adjustment:                                 | 0.92        | 0.92 | 0.92 | 0.95        | 0.95 | 0.95 | 0.92       | 0.95 | 0.95 | 0.92       | 0.95 | 0.95 |
| Lanes:                                      | 0.01        | 0.84 | 0.15 | 0.05        | 1.87 | 0.08 | 1.00       | 0.73 | 0.27 | 1.00       | 0.95 | 0.05 |
| Final Sat.:                                 | 4           | 1484 | 263  | 96          | 3361 | 143  | 1750       | 1316 | 484  | 1750       | 1719 | 81   |
| Capacity Analysis Module:                   |             |      |      |             |      |      |            |      |      |            |      |      |
| Vol/Sat:                                    | 0.29        | 0.29 | 0.29 | 0.47        | 0.47 | 0.47 | 0.03       | 0.18 | 0.18 | 0.03       | 0.11 | 0.11 |
| Crit Moves:                                 | *****       |      |      |             |      |      |            |      |      |            |      |      |
| Green Time:                                 | 81.9        | 81.9 | 81.9 | 81.9        | 81.9 | 81.9 | 32.1       | 32.1 | 32.1 | 32.1       | 32.1 | 32.1 |
| Volume/Cap:                                 | 0.42        | 0.42 | 0.42 | 0.69        | 0.69 | 0.69 | 0.10       | 0.69 | 0.69 | 0.13       | 0.41 | 0.41 |
| Delay/Veh:                                  | 8.7         | 8.7  | 8.7  | 12.2        | 12.2 | 12.2 | 33.2       | 43.6 | 43.6 | 33.4       | 36.8 | 36.8 |
| User DelAdj:                                | 1.00        | 1.00 | 1.00 | 1.00        | 1.00 | 1.00 | 1.00       | 1.00 | 1.00 | 1.00       | 1.00 | 1.00 |
| AdjDel/Veh:                                 | 8.7         | 8.7  | 8.7  | 12.2        | 12.2 | 12.2 | 33.2       | 43.6 | 43.6 | 33.4       | 36.8 | 36.8 |
| LOS by Move:                                | A           | A    | A    | B           | B    | B    | C          | D    | D    | C          | D    | D    |
| HCM2k95thQ:                                 | 16          | 16   | 16   | 31          | 31   | 31   | 3          | 21   | 21   | 4          | 12   | 12   |

Note: Queue reported is the number of cars per lane.

BART

Level Of Service Computation Report  
2000 HCM Operations (Future Volume Alternative)  
AM - Background Conditions

Intersection #121: Market/Lafayette [Study Int 51]

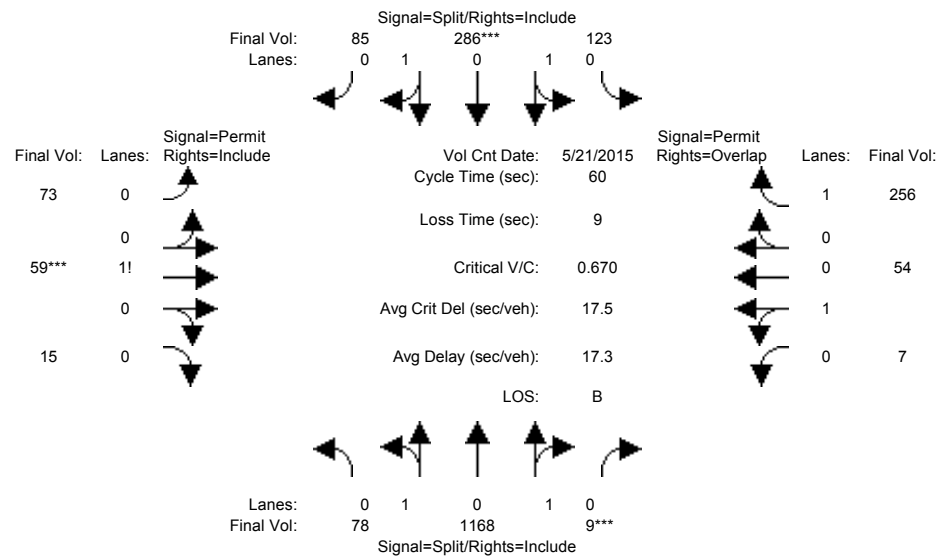

| Approach:                                    | North Bound |      |      | South Bound |      |      | East Bound |      |      | West Bound |      |      |
|--|-------------|------|------|-------------|------|------|------------|------|------|------------|------|------|
| Movement:                                    | L           | T    | R    | L           | T    | R    | L          | T    | R    | L          | T    | R    |
| Min. Green:                                  | 10          | 10   | 10   | 10          | 10   | 10   | 10         | 10   | 10   | 10         | 10   | 10   |
| Y+R:   | 4.0         | 4.0  | 4.0  | 4.0         | 4.0  | 4.0  | 4.0        | 4.0  | 4.0  | 4.0        | 4.0  | 4.0  |
| Volume Module: >> Count Date: 21 May 2015 << |             |      |      |             |      |      |            |      |      |            |      |      |
| Base Vol:                                    | 78          | 1168 | 9    | 123         | 286  | 85   | 73         | 59   | 15   | 7          | 54   | 256  |
| Growth Adj:                                  | 1.00        | 1.00 | 1.00 | 1.00        | 1.00 | 1.00 | 1.00       | 1.00 | 1.00 | 1.00       | 1.00 | 1.00 |
| Initial Bse:                                 | 78          | 1168 | 9    | 123         | 286  | 85   | 73         | 59   | 15   | 7          | 54   | 256  |
| Added Vol:                                   | 0           | 0    | 0    | 0           | 0    | 0    | 0          | 0    | 0    | 0          | 0    | 0    |
| PasserByVol:                                 | 0           | 0    | 0    | 0           | 0    | 0    | 0          | 0    | 0    | 0          | 0    | 0    |
| Initial Fut:                                 | 78          | 1168 | 9    | 123         | 286  | 85   | 73         | 59   | 15   | 7          | 54   | 256  |
| User Adj:                                    | 1.00        | 1.00 | 1.00 | 1.00        | 1.00 | 1.00 | 1.00       | 1.00 | 1.00 | 1.00       | 1.00 | 1.00 |
| PHF Adj:                                     | 1.00        | 1.00 | 1.00 | 1.00        | 1.00 | 1.00 | 1.00       | 1.00 | 1.00 | 1.00       | 1.00 | 1.00 |
| PHF Volume:                                  | 78          | 1168 | 9    | 123         | 286  | 85   | 73         | 59   | 15   | 7          | 54   | 256  |
| Reduct Vol:                                  | 0           | 0    | 0    | 0           | 0    | 0    | 0          | 0    | 0    | 0          | 0    | 0    |
| Reduced Vol:                                 | 78          | 1168 | 9    | 123         | 286  | 85   | 73         | 59   | 15   | 7          | 54   | 256  |
| PCE Adj:                                     | 1.00        | 1.00 | 1.00 | 1.00        | 1.00 | 1.00 | 1.00       | 1.00 | 1.00 | 1.00       | 1.00 | 1.00 |
| MLF Adj:                                     | 1.00        | 1.00 | 1.00 | 1.00        | 1.00 | 1.00 | 1.00       | 1.00 | 1.00 | 1.00       | 1.00 | 1.00 |
| FinalVolume:                                 | 78          | 1168 | 9    | 123         | 286  | 85   | 73         | 59   | 15   | 7          | 54   | 256  |
| Saturation Flow Module:                      |             |      |      |             |      |      |            |      |      |            |      |      |
| Sat/Lane:                                    | 1900        | 1900 | 1900 | 1900        | 1900 | 1900 | 1900       | 1900 | 1900 | 1900       | 1900 | 1900 |
| Adjustment:                                  | 0.95        | 0.95 | 0.95 | 0.95        | 0.95 | 0.95 | 0.92       | 0.92 | 0.92 | 0.95       | 0.95 | 0.92 |
| Lanes:                                       | 0.12        | 1.87 | 0.01 | 0.50        | 1.16 | 0.34 | 0.50       | 0.40 | 0.10 | 0.11       | 0.89 | 1.00 |
| Final Sat.:                                  | 224         | 3350 | 26   | 896         | 2084 | 619  | 869        | 702  | 179  | 207        | 1593 | 1750 |
| Capacity Analysis Module:                    |             |      |      |             |      |      |            |      |      |            |      |      |
| Vol/Sat:                                     | 0.35        | 0.35 | 0.35 | 0.14        | 0.14 | 0.14 | 0.08       | 0.08 | 0.08 | 0.03       | 0.03 | 0.15 |
| Crit Moves:                                  | ****        |      |      | ****        |      |      | ****       |      |      | ****       |      |      |
| Green Time:                                  | 29.4        | 29.4 | 29.4 | 11.6        | 11.6 | 11.6 | 10.0       | 10.0 | 10.0 | 10.0       | 10.0 | 21.6 |
| Volume/Cap:                                  | 0.71        | 0.71 | 0.71 | 0.71        | 0.71 | 0.71 | 0.50       | 0.50 | 0.50 | 0.20       | 0.20 | 0.41 |
| Delay/Veh:                                   | 13.3        | 13.3 | 13.3 | 26.1        | 26.1 | 26.1 | 24.2       | 24.2 | 24.2 | 21.9       | 21.9 | 14.8 |
| User DelAdj:                                 | 1.00        | 1.00 | 1.00 | 1.00        | 1.00 | 1.00 | 1.00       | 1.00 | 1.00 | 1.00       | 1.00 | 1.00 |
| AdjDel/Veh:                                  | 13.3        | 13.3 | 13.3 | 26.1        | 26.1 | 26.1 | 24.2       | 24.2 | 24.2 | 21.9       | 21.9 | 14.8 |
| LOS by Move:                                 | B           | B    | B    | C           | C    | C    | C          | C    | C    | C          | C    | B    |
| HCM2k95thQ:                                  | 18          | 18   | 18   | 9           | 9    | 9    | 5          | 5    | 5    | 2          | 2    | 8    |

Note: Queue reported is the number of cars per lane.

BART

Level Of Service Computation Report  
2000 HCM Operations (Future Volume Alternative)  
PM - Background Conditions

Intersection #121: Market/Lafayette [Study Int 51]

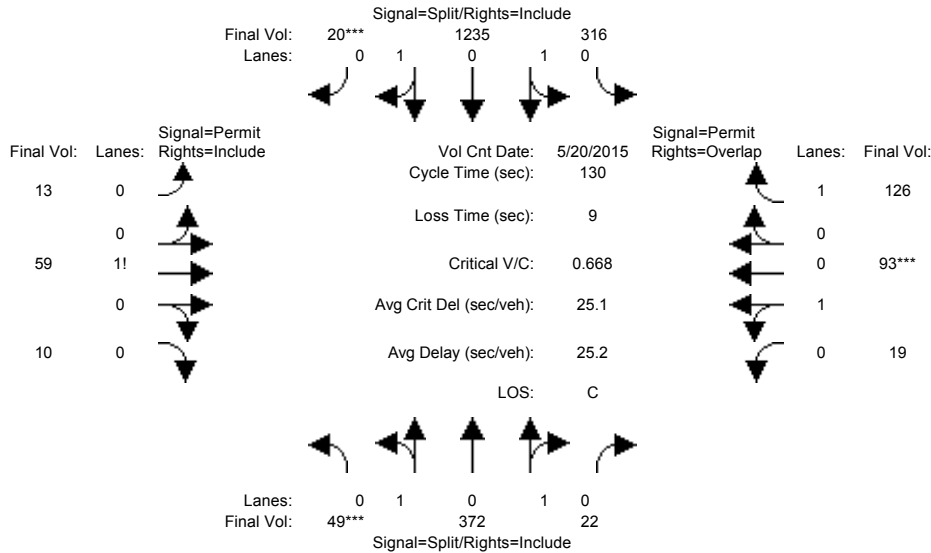

| Approach:                 | North Bound                   |      |      | South Bound |      |      | East Bound |      |      | West Bound |      |      |
|---------------------------|-------------------------------|------|------|-------------|------|------|------------|------|------|------------|------|------|
| Movement:                 | L                             | T    | R    | L           | T    | R    | L          | T    | R    | L          | T    | R    |
| Min. Green:               | 10                            | 10   | 10   | 10          | 10   | 10   | 10         | 10   | 10   | 10         | 10   | 10   |
| Y+R:                      | 4.0                           | 4.0  | 4.0  | 4.0         | 4.0  | 4.0  | 4.0        | 4.0  | 4.0  | 4.0        | 4.0  | 4.0  |
| -----                     |                               |      |      |             |      |      |            |      |      |            |      |      |
| Volume Module:            | >> Count Date: 20 May 2015 << |      |      |             |      |      |            |      |      |            |      |      |
| Base Vol:                 | 49                            | 372  | 22   | 316         | 1235 | 20   | 13         | 59   | 10   | 19         | 93   | 126  |
| Growth Adj:               | 1.00                          | 1.00 | 1.00 | 1.00        | 1.00 | 1.00 | 1.00       | 1.00 | 1.00 | 1.00       | 1.00 | 1.00 |
| Initial Bse:              | 49                            | 372  | 22   | 316         | 1235 | 20   | 13         | 59   | 10   | 19         | 93   | 126  |
| Added Vol:                | 0                             | 0    | 0    | 0           | 0    | 0    | 0          | 0    | 0    | 0          | 0    | 0    |
| PasserByVol:              | 0                             | 0    | 0    | 0           | 0    | 0    | 0          | 0    | 0    | 0          | 0    | 0    |
| Initial Fut:              | 49                            | 372  | 22   | 316         | 1235 | 20   | 13         | 59   | 10   | 19         | 93   | 126  |
| User Adj:                 | 1.00                          | 1.00 | 1.00 | 1.00        | 1.00 | 1.00 | 1.00       | 1.00 | 1.00 | 1.00       | 1.00 | 1.00 |
| PHF Adj:                  | 1.00                          | 1.00 | 1.00 | 1.00        | 1.00 | 1.00 | 1.00       | 1.00 | 1.00 | 1.00       | 1.00 | 1.00 |
| PHF Volume:               | 49                            | 372  | 22   | 316         | 1235 | 20   | 13         | 59   | 10   | 19         | 93   | 126  |
| Reduct Vol:               | 0                             | 0    | 0    | 0           | 0    | 0    | 0          | 0    | 0    | 0          | 0    | 0    |
| Reduced Vol:              | 49                            | 372  | 22   | 316         | 1235 | 20   | 13         | 59   | 10   | 19         | 93   | 126  |
| PCE Adj:                  | 1.00                          | 1.00 | 1.00 | 1.00        | 1.00 | 1.00 | 1.00       | 1.00 | 1.00 | 1.00       | 1.00 | 1.00 |
| MLF Adj:                  | 1.00                          | 1.00 | 1.00 | 1.00        | 1.00 | 1.00 | 1.00       | 1.00 | 1.00 | 1.00       | 1.00 | 1.00 |
| Final Volume:             | 49                            | 372  | 22   | 316         | 1235 | 20   | 13         | 59   | 10   | 19         | 93   | 126  |
| -----                     |                               |      |      |             |      |      |            |      |      |            |      |      |
| Saturation Flow Module:   |                               |      |      |             |      |      |            |      |      |            |      |      |
| Sat/Lane:                 | 1900                          | 1900 | 1900 | 1900        | 1900 | 1900 | 1900       | 1900 | 1900 | 1900       | 1900 | 1900 |
| Adjustment:               | 0.95                          | 0.95 | 0.95 | 0.95        | 0.95 | 0.95 | 0.92       | 0.92 | 0.92 | 0.95       | 0.95 | 0.92 |
| Lanes:                    | 0.22                          | 1.68 | 0.10 | 0.40        | 1.57 | 0.03 | 0.16       | 0.72 | 0.12 | 0.17       | 0.83 | 1.00 |
| Final Sat.:               | 398                           | 3023 | 179  | 724         | 2830 | 46   | 277        | 1259 | 213  | 305        | 1495 | 1750 |
| -----                     |                               |      |      |             |      |      |            |      |      |            |      |      |
| Capacity Analysis Module: |                               |      |      |             |      |      |            |      |      |            |      |      |
| Vol/Sat:                  | 0.12                          | 0.12 | 0.12 | 0.44        | 0.44 | 0.44 | 0.05       | 0.05 | 0.05 | 0.06       | 0.06 | 0.07 |
| Crit Moves:               | ****                          |      |      | ****        |      |      | ****       |      |      | ****       |      |      |
| Green Time:               | 24.0                          | 24.0 | 24.0 | 84.9        | 84.9 | 84.9 | 12.1       | 12.1 | 12.1 | 12.1       | 12.1 | 97.0 |
| Volume/Cap:               | 0.67                          | 0.67 | 0.67 | 0.67        | 0.67 | 0.67 | 0.50       | 0.50 | 0.50 | 0.67       | 0.67 | 0.10 |
| Delay/Veh:                | 51.9                          | 51.9 | 51.9 | 14.6        | 14.6 | 14.6 | 58.6       | 58.6 | 58.6 | 66.9       | 66.9 | 4.5  |
| User DelAdj:              | 1.00                          | 1.00 | 1.00 | 1.00        | 1.00 | 1.00 | 1.00       | 1.00 | 1.00 | 1.00       | 1.00 | 1.00 |
| AdjDel/Veh:               | 51.9                          | 51.9 | 51.9 | 14.6        | 14.6 | 14.6 | 58.6       | 58.6 | 58.6 | 66.9       | 66.9 | 4.5  |
| LOS by Move:              | D                             | D    | D    | B           | B    | B    | E          | E    | E    | E          | E    | A    |
| HCM2k95thQ:               | 16                            | 16   | 16   | 34          | 34   | 34   | 7          | 7    | 7    | 11         | 11   | 3    |

Note: Queue reported is the number of cars per lane.

BART

Level Of Service Computation Report  
2000 HCM Operations (Future Volume Alternative)  
AM - Background Conditions

Intersection #123: Homestead/Monroe [Study Int 61]

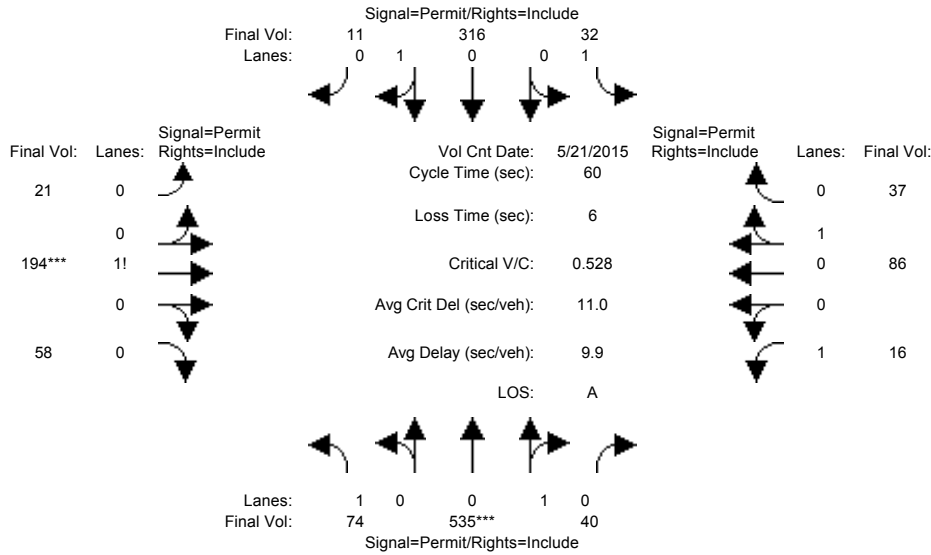

| Approach:                                    | North Bound |      |      | South Bound |      |      | East Bound |      |      | West Bound |      |      |
|--|-------------|------|------|-------------|------|------|------------|------|------|------------|------|------|
| Movement:                                    | L           | T    | R    | L           | T    | R    | L          | T    | R    | L          | T    | R    |
| Min. Green:                                  | 10          | 10   | 10   | 10          | 10   | 10   | 10         | 10   | 10   | 10         | 10   | 10   |
| Y+R:   | 4.0         | 4.0  | 4.0  | 4.0         | 4.0  | 4.0  | 4.0        | 4.0  | 4.0  | 4.0        | 4.0  | 4.0  |
| -----  |             |      |      |             |      |      |            |      |      |            |      |      |
| Volume Module: >> Count Date: 21 May 2015 << |             |      |      |             |      |      |            |      |      |            |      |      |
| Base Vol:                                    | 74          | 535  | 40   | 32          | 316  | 11   | 21         | 194  | 58   | 16         | 86   | 37   |
| Growth Adj:                                  | 1.00        | 1.00 | 1.00 | 1.00        | 1.00 | 1.00 | 1.00       | 1.00 | 1.00 | 1.00       | 1.00 | 1.00 |
| Initial Bse:                                 | 74          | 535  | 40   | 32          | 316  | 11   | 21         | 194  | 58   | 16         | 86   | 37   |
| Added Vol:                                   | 0           | 0    | 0    | 0           | 0    | 0    | 0          | 0    | 0    | 0          | 0    | 0    |
| PasserByVol:                                 | 0           | 0    | 0    | 0           | 0    | 0    | 0          | 0    | 0    | 0          | 0    | 0    |
| Initial Fut:                                 | 74          | 535  | 40   | 32          | 316  | 11   | 21         | 194  | 58   | 16         | 86   | 37   |
| User Adj:                                    | 1.00        | 1.00 | 1.00 | 1.00        | 1.00 | 1.00 | 1.00       | 1.00 | 1.00 | 1.00       | 1.00 | 1.00 |
| PHF Adj:                                     | 1.00        | 1.00 | 1.00 | 1.00        | 1.00 | 1.00 | 1.00       | 1.00 | 1.00 | 1.00       | 1.00 | 1.00 |
| PHF Volume:                                  | 74          | 535  | 40   | 32          | 316  | 11   | 21         | 194  | 58   | 16         | 86   | 37   |
| Reduct Vol:                                  | 0           | 0    | 0    | 0           | 0    | 0    | 0          | 0    | 0    | 0          | 0    | 0    |
| Reduced Vol:                                 | 74          | 535  | 40   | 32          | 316  | 11   | 21         | 194  | 58   | 16         | 86   | 37   |
| PCE Adj:                                     | 1.00        | 1.00 | 1.00 | 1.00        | 1.00 | 1.00 | 1.00       | 1.00 | 1.00 | 1.00       | 1.00 | 1.00 |
| MLF Adj:                                     | 1.00        | 1.00 | 1.00 | 1.00        | 1.00 | 1.00 | 1.00       | 1.00 | 1.00 | 1.00       | 1.00 | 1.00 |
| FinalVolume:                                 | 74          | 535  | 40   | 32          | 316  | 11   | 21         | 194  | 58   | 16         | 86   | 37   |
| -----  |             |      |      |             |      |      |            |      |      |            |      |      |
| Saturation Flow Module:                      |             |      |      |             |      |      |            |      |      |            |      |      |
| Sat/Lane:                                    | 1900        | 1900 | 1900 | 1900        | 1900 | 1900 | 1900       | 1900 | 1900 | 1900       | 1900 | 1900 |
| Adjustment:                                  | 0.92        | 0.95 | 0.95 | 0.92        | 0.95 | 0.95 | 0.92       | 0.92 | 0.92 | 0.92       | 0.95 | 0.95 |
| Lanes:                                       | 1.00        | 0.93 | 0.07 | 1.00        | 0.97 | 0.03 | 0.08       | 0.71 | 0.21 | 1.00       | 0.70 | 0.30 |
| Final Sat.:                                  | 1750        | 1675 | 125  | 1750        | 1739 | 61   | 135        | 1244 | 372  | 1750       | 1259 | 541  |
| -----  |             |      |      |             |      |      |            |      |      |            |      |      |
| Capacity Analysis Module:                    |             |      |      |             |      |      |            |      |      |            |      |      |
| Vol/Sat:                                     | 0.04        | 0.32 | 0.32 | 0.02        | 0.18 | 0.18 | 0.16       | 0.16 | 0.16 | 0.01       | 0.07 | 0.07 |
| Crit Moves:                                  | ****        |      |      | ****        |      |      | ****       |      |      | ****       |      |      |
| Green Time:                                  | 36.3        | 36.3 | 36.3 | 36.3        | 36.3 | 36.3 | 17.7       | 17.7 | 17.7 | 17.7       | 17.7 | 17.7 |
| Volume/Cap:                                  | 0.07        | 0.53 | 0.53 | 0.03        | 0.30 | 0.30 | 0.53       | 0.53 | 0.53 | 0.03       | 0.23 | 0.23 |
| Delay/Veh:                                   | 4.9         | 7.4  | 7.4  | 4.8         | 5.9  | 5.9  | 18.7       | 18.7 | 18.7 | 15.1       | 16.2 | 16.2 |
| User DelAdj:                                 | 1.00        | 1.00 | 1.00 | 1.00        | 1.00 | 1.00 | 1.00       | 1.00 | 1.00 | 1.00       | 1.00 | 1.00 |
| AdjDel/Veh:                                  | 4.9         | 7.4  | 7.4  | 4.8         | 5.9  | 5.9  | 18.7       | 18.7 | 18.7 | 15.1       | 16.2 | 16.2 |
| LOS by Move:                                 | A           | A    | A    | A           | A    | A    | B          | B    | B    | B          | B    | B    |
| HCM2k95thQ:                                  | 1           | 13   | 13   | 1           | 6    | 6    | 9          | 9    | 9    | 0          | 4    | 4    |

Note: Queue reported is the number of cars per lane.

BART

Level Of Service Computation Report  
 2000 HCM Operations (Future Volume Alternative)  
 PM - Background Conditions

Intersection #123: Homestead/Monroe [Study Int 61]

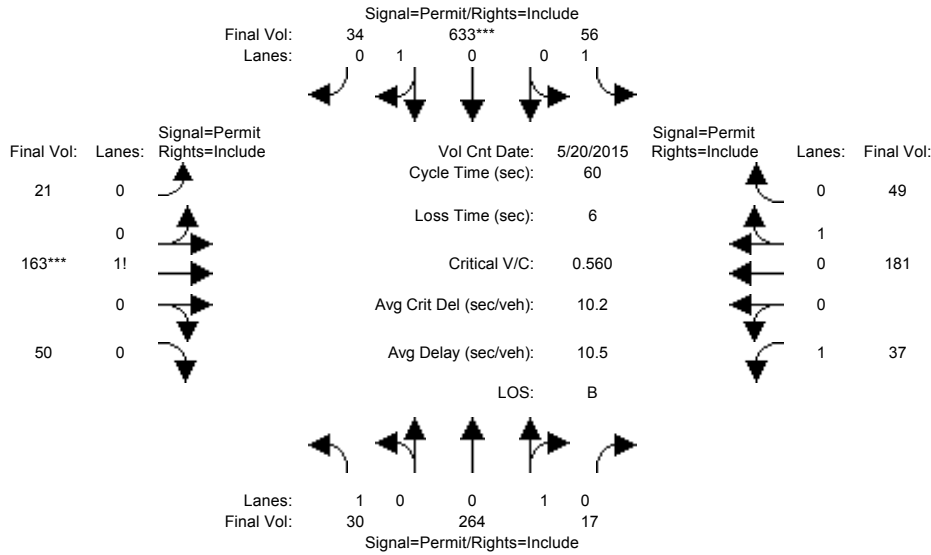

| Approach:                                    | North Bound |      |      | South Bound |      |      | East Bound |      |      | West Bound |      |      |
|--|-------------|------|------|-------------|------|------|------------|------|------|------------|------|------|
| Movement:                                    | L           | T    | R    | L           | T    | R    | L          | T    | R    | L          | T    | R    |
| Min. Green:                                  | 10          | 10   | 10   | 10          | 10   | 10   | 10         | 10   | 10   | 10         | 10   | 10   |
| Y+R:   | 4.0         | 4.0  | 4.0  | 4.0         | 4.0  | 4.0  | 4.0        | 4.0  | 4.0  | 4.0        | 4.0  | 4.0  |
| Volume Module: >> Count Date: 20 May 2015 << |             |      |      |             |      |      |            |      |      |            |      |      |
| Base Vol:                                    | 30          | 264  | 17   | 56          | 633  | 34   | 21         | 163  | 50   | 37         | 181  | 49   |
| Growth Adj:                                  | 1.00        | 1.00 | 1.00 | 1.00        | 1.00 | 1.00 | 1.00       | 1.00 | 1.00 | 1.00       | 1.00 | 1.00 |
| Initial Bse:                                 | 30          | 264  | 17   | 56          | 633  | 34   | 21         | 163  | 50   | 37         | 181  | 49   |
| Added Vol:                                   | 0           | 0    | 0    | 0           | 0    | 0    | 0          | 0    | 0    | 0          | 0    | 0    |
| PasserByVol:                                 | 0           | 0    | 0    | 0           | 0    | 0    | 0          | 0    | 0    | 0          | 0    | 0    |
| Initial Fut:                                 | 30          | 264  | 17   | 56          | 633  | 34   | 21         | 163  | 50   | 37         | 181  | 49   |
| User Adj:                                    | 1.00        | 1.00 | 1.00 | 1.00        | 1.00 | 1.00 | 1.00       | 1.00 | 1.00 | 1.00       | 1.00 | 1.00 |
| PHF Adj:                                     | 1.00        | 1.00 | 1.00 | 1.00        | 1.00 | 1.00 | 1.00       | 1.00 | 1.00 | 1.00       | 1.00 | 1.00 |
| PHF Volume:                                  | 30          | 264  | 17   | 56          | 633  | 34   | 21         | 163  | 50   | 37         | 181  | 49   |
| Reduct Vol:                                  | 0           | 0    | 0    | 0           | 0    | 0    | 0          | 0    | 0    | 0          | 0    | 0    |
| Reduced Vol:                                 | 30          | 264  | 17   | 56          | 633  | 34   | 21         | 163  | 50   | 37         | 181  | 49   |
| PCE Adj:                                     | 1.00        | 1.00 | 1.00 | 1.00        | 1.00 | 1.00 | 1.00       | 1.00 | 1.00 | 1.00       | 1.00 | 1.00 |
| MLF Adj:                                     | 1.00        | 1.00 | 1.00 | 1.00        | 1.00 | 1.00 | 1.00       | 1.00 | 1.00 | 1.00       | 1.00 | 1.00 |
| Final Volume:                                | 30          | 264  | 17   | 56          | 633  | 34   | 21         | 163  | 50   | 37         | 181  | 49   |
| Saturation Flow Module:                      |             |      |      |             |      |      |            |      |      |            |      |      |
| Sat/Lane:                                    | 1900        | 1900 | 1900 | 1900        | 1900 | 1900 | 1900       | 1900 | 1900 | 1900       | 1900 | 1900 |
| Adjustment:                                  | 0.92        | 0.95 | 0.95 | 0.92        | 0.95 | 0.95 | 0.92       | 0.92 | 0.92 | 0.92       | 0.95 | 0.95 |
| Lanes:                                       | 1.00        | 0.94 | 0.06 | 1.00        | 0.95 | 0.05 | 0.09       | 0.70 | 0.21 | 1.00       | 0.79 | 0.21 |
| Final Sat.:                                  | 1750        | 1691 | 109  | 1750        | 1708 | 92   | 157        | 1219 | 374  | 1750       | 1417 | 383  |
| Capacity Analysis Module:                    |             |      |      |             |      |      |            |      |      |            |      |      |
| Vol/Sat:                                     | 0.02        | 0.16 | 0.16 | 0.03        | 0.37 | 0.37 | 0.13       | 0.13 | 0.13 | 0.02       | 0.13 | 0.13 |
| Crit Moves:                                  | *****       |      |      |             |      |      |            |      |      |            |      |      |
| Green Time:                                  | 39.7        | 39.7 | 39.7 | 39.7        | 39.7 | 39.7 | 14.3       | 14.3 | 14.3 | 14.3       | 14.3 | 14.3 |
| Volume/Cap:                                  | 0.03        | 0.24 | 0.24 | 0.05        | 0.56 | 0.56 | 0.56       | 0.56 | 0.56 | 0.09       | 0.54 | 0.54 |
| Delay/Veh:                                   | 3.5         | 4.2  | 4.2  | 3.6         | 6.1  | 6.1  | 21.8       | 21.8 | 21.8 | 17.9       | 21.3 | 21.3 |
| User DelAdj:                                 | 1.00        | 1.00 | 1.00 | 1.00        | 1.00 | 1.00 | 1.00       | 1.00 | 1.00 | 1.00       | 1.00 | 1.00 |
| AdjDel/Veh:                                  | 3.5         | 4.2  | 4.2  | 3.6         | 6.1  | 6.1  | 21.8       | 21.8 | 21.8 | 17.9       | 21.3 | 21.3 |
| LOS by Move:                                 | A           | A    | A    | A           | A    | A    | C          | C    | C    | B          | C    | C    |
| HCM2k95thQ:                                  | 0           | 4    | 4    | 1           | 13   | 13   | 8          | 8    | 8    | 1          | 8    | 8    |

Note: Queue reported is the number of cars per lane.

BART

Level Of Service Computation Report  
 2000 HCM Operations (Future Volume Alternative)  
 AM - Background Conditions

Intersection #127: Lincoln/Homestead [Study Int 60]

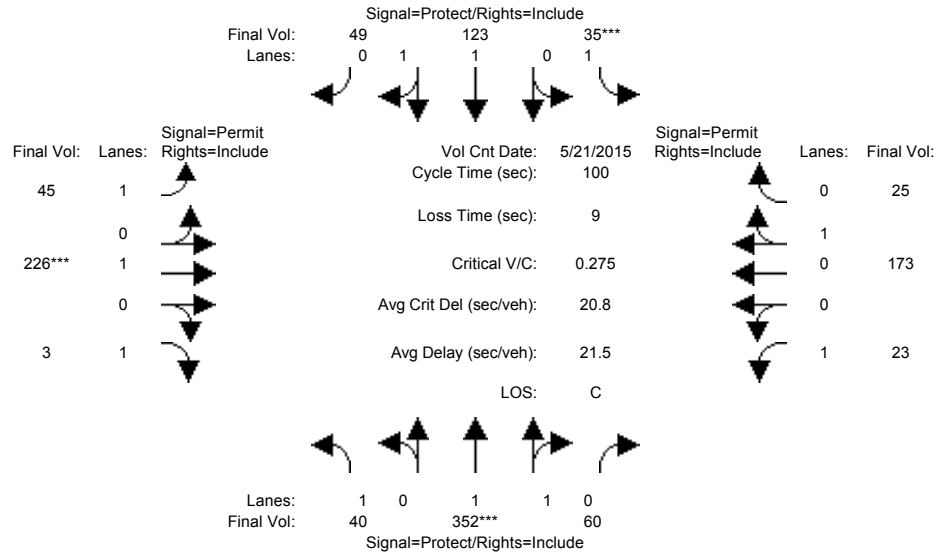

| Approach:                                    | North Bound |      |      | South Bound |      |      | East Bound |      |      | West Bound |      |      |
|--|-------------|------|------|-------------|------|------|------------|------|------|------------|------|------|
| Movement:                                    | L           | T    | R    | L           | T    | R    | L          | T    | R    | L          | T    | R    |
| Min. Green:                                  | 7           | 10   | 10   | 7           | 10   | 10   | 7          | 10   | 10   | 7          | 10   | 10   |
| Y+R:   | 4.0         | 4.0  | 4.0  | 4.0         | 4.0  | 4.0  | 4.0        | 4.0  | 4.0  | 4.0        | 4.0  | 4.0  |
| Volume Module: >> Count Date: 21 May 2015 << |             |      |      |             |      |      |            |      |      |            |      |      |
| Base Vol:                                    | 40          | 352  | 60   | 35          | 123  | 49   | 45         | 226  | 3    | 23         | 173  | 25   |
| Growth Adj:                                  | 1.00        | 1.00 | 1.00 | 1.00        | 1.00 | 1.00 | 1.00       | 1.00 | 1.00 | 1.00       | 1.00 | 1.00 |
| Initial Bse:                                 | 40          | 352  | 60   | 35          | 123  | 49   | 45         | 226  | 3    | 23         | 173  | 25   |
| Added Vol:                                   | 0           | 0    | 0    | 0           | 0    | 0    | 0          | 0    | 0    | 0          | 0    | 0    |
| PasserByVol:                                 | 0           | 0    | 0    | 0           | 0    | 0    | 0          | 0    | 0    | 0          | 0    | 0    |
| Initial Fut:                                 | 40          | 352  | 60   | 35          | 123  | 49   | 45         | 226  | 3    | 23         | 173  | 25   |
| User Adj:                                    | 1.00        | 1.00 | 1.00 | 1.00        | 1.00 | 1.00 | 1.00       | 1.00 | 1.00 | 1.00       | 1.00 | 1.00 |
| PHF Adj:                                     | 1.00        | 1.00 | 1.00 | 1.00        | 1.00 | 1.00 | 1.00       | 1.00 | 1.00 | 1.00       | 1.00 | 1.00 |
| PHF Volume:                                  | 40          | 352  | 60   | 35          | 123  | 49   | 45         | 226  | 3    | 23         | 173  | 25   |
| Reduct Vol:                                  | 0           | 0    | 0    | 0           | 0    | 0    | 0          | 0    | 0    | 0          | 0    | 0    |
| Reduced Vol:                                 | 40          | 352  | 60   | 35          | 123  | 49   | 45         | 226  | 3    | 23         | 173  | 25   |
| PCE Adj:                                     | 1.00        | 1.00 | 1.00 | 1.00        | 1.00 | 1.00 | 1.00       | 1.00 | 1.00 | 1.00       | 1.00 | 1.00 |
| MLF Adj:                                     | 1.00        | 1.00 | 1.00 | 1.00        | 1.00 | 1.00 | 1.00       | 1.00 | 1.00 | 1.00       | 1.00 | 1.00 |
| Final Volume:                                | 40          | 352  | 60   | 35          | 123  | 49   | 45         | 226  | 3    | 23         | 173  | 25   |
| Saturation Flow Module:                      |             |      |      |             |      |      |            |      |      |            |      |      |
| Sat/Lane:                                    | 1900        | 1900 | 1900 | 1900        | 1900 | 1900 | 1900       | 1900 | 1900 | 1900       | 1900 | 1900 |
| Adjustment:                                  | 0.92        | 0.98 | 0.95 | 0.92        | 0.98 | 0.95 | 0.92       | 1.00 | 0.92 | 0.92       | 0.95 | 0.95 |
| Lanes:                                       | 1.00        | 1.70 | 0.30 | 1.00        | 1.41 | 0.59 | 1.00       | 1.00 | 1.00 | 1.00       | 0.87 | 0.13 |
| Final Sat.:                                  | 1750        | 3161 | 539  | 1750        | 2645 | 1054 | 1750       | 1900 | 1750 | 1750       | 1573 | 227  |
| Capacity Analysis Module:                    |             |      |      |             |      |      |            |      |      |            |      |      |
| Vol/Sat:                                     | 0.02        | 0.11 | 0.11 | 0.02        | 0.05 | 0.05 | 0.03       | 0.12 | 0.00 | 0.01       | 0.11 | 0.11 |
| Crit Moves:                                  | ****        | **** | **** | ****        | **** | **** | ****       | **** | **** | ****       | **** | **** |
| Green Time:                                  | 19.7        | 40.5 | 40.5 | 7.3         | 28.1 | 28.1 | 43.2       | 43.2 | 43.2 | 43.2       | 43.2 | 43.2 |
| Volume/Cap:                                  | 0.12        | 0.28 | 0.28 | 0.28        | 0.17 | 0.17 | 0.06       | 0.28 | 0.00 | 0.03       | 0.25 | 0.25 |
| Delay/Veh:                                   | 33.2        | 20.0 | 20.0 | 45.0        | 27.2 | 27.2 | 16.6       | 18.5 | 16.1 | 16.3       | 18.3 | 18.3 |
| User DelAdj:                                 | 1.00        | 1.00 | 1.00 | 1.00        | 1.00 | 1.00 | 1.00       | 1.00 | 1.00 | 1.00       | 1.00 | 1.00 |
| AdjDel/Veh:                                  | 33.2        | 20.0 | 20.0 | 45.0        | 27.2 | 27.2 | 16.6       | 18.5 | 16.1 | 16.3       | 18.3 | 18.3 |
| LOS by Move:                                 | C           | C    | C    | D           | C    | C    | B          | B    | B    | B          | B    | B    |
| HCM2k95thQ:                                  | 2           | 8    | 8    | 2           | 4    | 4    | 2          | 8    | 0    | 1          | 8    | 8    |

Note: Queue reported is the number of cars per lane.

BART

Level Of Service Computation Report  
 2000 HCM Operations (Future Volume Alternative)  
 PM - Background Conditions

Intersection #127: Lincoln/Homestead [Study Int 60]

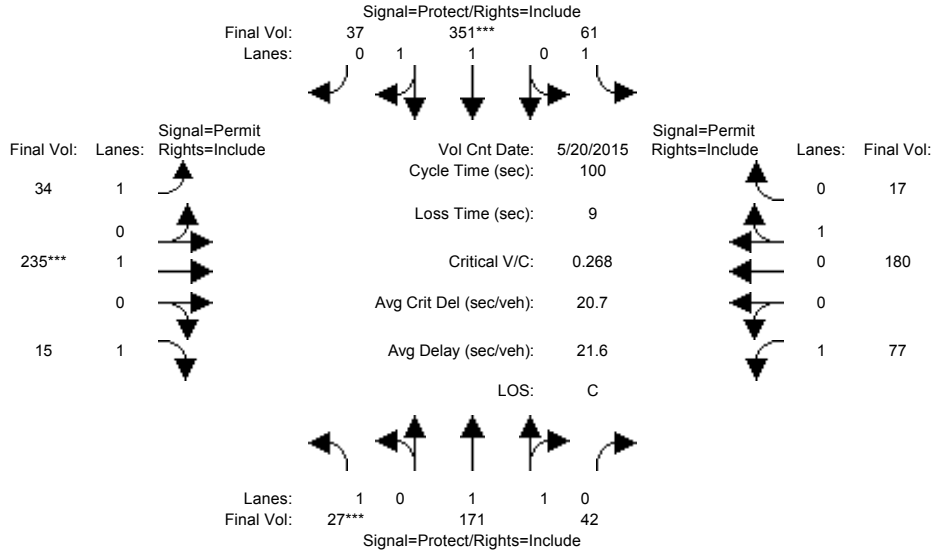

| Approach:                                    | North Bound |      |      | South Bound |      |      | East Bound |      |      | West Bound |      |      |
|--|-------------|------|------|-------------|------|------|------------|------|------|------------|------|------|
| Movement:                                    | L           | T    | R    | L           | T    | R    | L          | T    | R    | L          | T    | R    |
| Min. Green:                                  | 7           | 10   | 10   | 7           | 10   | 10   | 7          | 10   | 10   | 7          | 10   | 10   |
| Y+R:   | 4.0         | 4.0  | 4.0  | 4.0         | 4.0  | 4.0  | 4.0        | 4.0  | 4.0  | 4.0        | 4.0  | 4.0  |
| Volume Module: >> Count Date: 20 May 2015 << |             |      |      |             |      |      |            |      |      |            |      |      |
| Base Vol:                                    | 27          | 171  | 42   | 61          | 351  | 37   | 34         | 235  | 15   | 77         | 180  | 17   |
| Growth Adj:                                  | 1.00        | 1.00 | 1.00 | 1.00        | 1.00 | 1.00 | 1.00       | 1.00 | 1.00 | 1.00       | 1.00 | 1.00 |
| Initial Bse:                                 | 27          | 171  | 42   | 61          | 351  | 37   | 34         | 235  | 15   | 77         | 180  | 17   |
| Added Vol:                                   | 0           | 0    | 0    | 0           | 0    | 0    | 0          | 0    | 0    | 0          | 0    | 0    |
| PasserByVol:                                 | 0           | 0    | 0    | 0           | 0    | 0    | 0          | 0    | 0    | 0          | 0    | 0    |
| Initial Fut:                                 | 27          | 171  | 42   | 61          | 351  | 37   | 34         | 235  | 15   | 77         | 180  | 17   |
| User Adj:                                    | 1.00        | 1.00 | 1.00 | 1.00        | 1.00 | 1.00 | 1.00       | 1.00 | 1.00 | 1.00       | 1.00 | 1.00 |
| PHF Adj:                                     | 1.00        | 1.00 | 1.00 | 1.00        | 1.00 | 1.00 | 1.00       | 1.00 | 1.00 | 1.00       | 1.00 | 1.00 |
| PHF Volume:                                  | 27          | 171  | 42   | 61          | 351  | 37   | 34         | 235  | 15   | 77         | 180  | 17   |
| Reduct Vol:                                  | 0           | 0    | 0    | 0           | 0    | 0    | 0          | 0    | 0    | 0          | 0    | 0    |
| Reduced Vol:                                 | 27          | 171  | 42   | 61          | 351  | 37   | 34         | 235  | 15   | 77         | 180  | 17   |
| PCE Adj:                                     | 1.00        | 1.00 | 1.00 | 1.00        | 1.00 | 1.00 | 1.00       | 1.00 | 1.00 | 1.00       | 1.00 | 1.00 |
| MLF Adj:                                     | 1.00        | 1.00 | 1.00 | 1.00        | 1.00 | 1.00 | 1.00       | 1.00 | 1.00 | 1.00       | 1.00 | 1.00 |
| Final Volume:                                | 27          | 171  | 42   | 61          | 351  | 37   | 34         | 235  | 15   | 77         | 180  | 17   |
| Saturation Flow Module:                      |             |      |      |             |      |      |            |      |      |            |      |      |
| Sat/Lane:                                    | 1900        | 1900 | 1900 | 1900        | 1900 | 1900 | 1900       | 1900 | 1900 | 1900       | 1900 | 1900 |
| Adjustment:                                  | 0.92        | 0.98 | 0.95 | 0.92        | 0.98 | 0.95 | 0.92       | 1.00 | 0.92 | 0.92       | 0.95 | 0.95 |
| Lanes:                                       | 1.00        | 1.59 | 0.41 | 1.00        | 1.80 | 0.20 | 1.00       | 1.00 | 1.00 | 1.00       | 0.91 | 0.09 |
| Final Sat.:                                  | 1750        | 2970 | 729  | 1750        | 3347 | 353  | 1750       | 1900 | 1750 | 1750       | 1645 | 155  |
| Capacity Analysis Module:                    |             |      |      |             |      |      |            |      |      |            |      |      |
| Vol/Sat:                                     | 0.02        | 0.06 | 0.06 | 0.03        | 0.10 | 0.10 | 0.02       | 0.12 | 0.01 | 0.04       | 0.11 | 0.11 |
| Crit Moves:                                  | ****        |      |      | ****        |      |      | ****       |      |      | ****       |      |      |
| Green Time:                                  | 7.0         | 26.8 | 26.8 | 18.8        | 38.5 | 38.5 | 45.5       | 45.5 | 45.5 | 45.5       | 45.5 | 45.5 |
| Volume/Cap:                                  | 0.22        | 0.21 | 0.21 | 0.19        | 0.27 | 0.27 | 0.04       | 0.27 | 0.02 | 0.10       | 0.24 | 0.24 |
| Delay/Veh:                                   | 44.8        | 28.5 | 28.5 | 34.5        | 21.2 | 21.2 | 15.2       | 17.1 | 15.0 | 15.6       | 16.9 | 16.9 |
| User DelAdj:                                 | 1.00        | 1.00 | 1.00 | 1.00        | 1.00 | 1.00 | 1.00       | 1.00 | 1.00 | 1.00       | 1.00 | 1.00 |
| AdjDel/Veh:                                  | 44.8        | 28.5 | 28.5 | 34.5        | 21.2 | 21.2 | 15.2       | 17.1 | 15.0 | 15.6       | 16.9 | 16.9 |
| LOS by Move:                                 | D           | C    | C    | C           | C    | C    | B          | B    | B    | B          | B    | B    |
| HCM2k95thQ:                                  | 2           | 5    | 5    | 3           | 8    | 8    | 1          | 9    | 1    | 3          | 7    | 7    |

Note: Queue reported is the number of cars per lane.

BART

Level Of Service Computation Report  
2000 HCM Operations (Future Volume Alternative)  
AM - Background Conditions

Intersection #128: Homestead/Lafayette [Study Int 50]

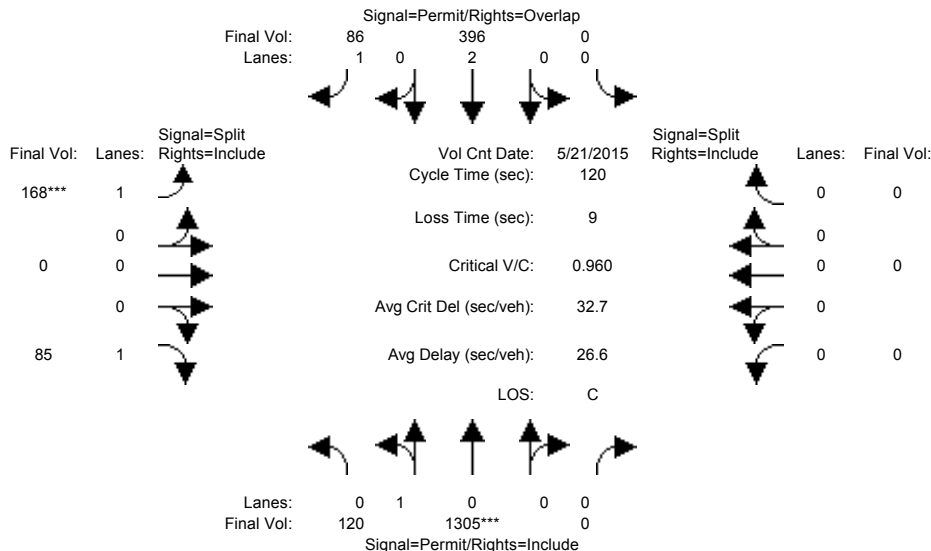

| Approach:                                    | North Bound |      |      | South Bound |      |       | East Bound |      |      | West Bound |      |      |
|--|-------------|------|------|-------------|------|-------|------------|------|------|------------|------|------|
| Movement:                                    | L           | T    | R    | L           | T    | R     | L          | T    | R    | L          | T    | R    |
| Min. Green:                                  | 10          | 10   | 10   | 10          | 10   | 10    | 10         | 10   | 10   | 10         | 10   | 10   |
| Y+R:   | 4.0         | 4.0  | 4.0  | 4.0         | 4.0  | 4.0   | 4.0        | 4.0  | 4.0  | 4.0        | 4.0  | 4.0  |
| Volume Module: >> Count Date: 21 May 2015 << |             |      |      |             |      |       |            |      |      |            |      |      |
| Base Vol:                                    | 120         | 1305 | 0    | 0           | 396  | 86    | 168        | 0    | 85   | 0          | 0    | 0    |
| Growth Adj:                                  | 1.00        | 1.00 | 1.00 | 1.00        | 1.00 | 1.00  | 1.00       | 1.00 | 1.00 | 1.00       | 1.00 | 1.00 |
| Initial Bse:                                 | 120         | 1305 | 0    | 0           | 396  | 86    | 168        | 0    | 85   | 0          | 0    | 0    |
| Added Vol:                                   | 0           | 0    | 0    | 0           | 0    | 0     | 0          | 0    | 0    | 0          | 0    | 0    |
| PasserByVol:                                 | 0           | 0    | 0    | 0           | 0    | 0     | 0          | 0    | 0    | 0          | 0    | 0    |
| Initial Fut:                                 | 120         | 1305 | 0    | 0           | 396  | 86    | 168        | 0    | 85   | 0          | 0    | 0    |
| User Adj:                                    | 1.00        | 1.00 | 1.00 | 1.00        | 1.00 | 1.00  | 1.00       | 1.00 | 1.00 | 1.00       | 1.00 | 1.00 |
| PHF Adj:                                     | 1.00        | 1.00 | 1.00 | 1.00        | 1.00 | 1.00  | 1.00       | 1.00 | 1.00 | 1.00       | 1.00 | 1.00 |
| PHF Volume:                                  | 120         | 1305 | 0    | 0           | 396  | 86    | 168        | 0    | 85   | 0          | 0    | 0    |
| Reduct Vol:                                  | 0           | 0    | 0    | 0           | 0    | 0     | 0          | 0    | 0    | 0          | 0    | 0    |
| Reduced Vol:                                 | 120         | 1305 | 0    | 0           | 396  | 86    | 168        | 0    | 85   | 0          | 0    | 0    |
| PCE Adj:                                     | 1.00        | 1.00 | 1.00 | 1.00        | 1.00 | 1.00  | 1.00       | 1.00 | 1.00 | 1.00       | 1.00 | 1.00 |
| MLF Adj:                                     | 1.00        | 1.00 | 1.00 | 1.00        | 1.00 | 1.00  | 1.00       | 1.00 | 1.00 | 1.00       | 1.00 | 1.00 |
| Final Volume:                                | 120         | 1305 | 0    | 0           | 396  | 86    | 168        | 0    | 85   | 0          | 0    | 0    |
| Saturation Flow Module:                      |             |      |      |             |      |       |            |      |      |            |      |      |
| Sat/Lane:                                    | 1900        | 1900 | 1900 | 1900        | 1900 | 1900  | 1900       | 1900 | 1900 | 1900       | 1900 | 1900 |
| Adjustment:                                  | 0.95        | 0.95 | 0.92 | 0.92        | 1.00 | 0.92  | 0.92       | 1.00 | 0.92 | 0.92       | 1.00 | 0.92 |
| Lanes:                                       | 0.08        | 0.92 | 0.00 | 0.00        | 2.00 | 1.00  | 1.00       | 0.00 | 1.00 | 0.00       | 0.00 | 0.00 |
| Final Sat.:                                  | 152         | 1648 | 0    | 0           | 3800 | 1750  | 1750       | 0    | 1750 | 0          | 0    | 0    |
| Capacity Analysis Module:                    |             |      |      |             |      |       |            |      |      |            |      |      |
| Vol/Sat:                                     | 0.79        | 0.79 | 0.00 | 0.00        | 0.10 | 0.05  | 0.10       | 0.00 | 0.05 | 0.00       | 0.00 | 0.00 |
| Crit Moves:                                  | ****        |      |      | ****        |      |       | ****       |      |      | ****       |      |      |
| Green Time:                                  | 99.0        | 99.0 | 0.0  | 0.0         | 99.0 | 111.0 | 12.0       | 0.0  | 12.0 | 0.0        | 0.0  | 0.0  |
| Volume/Cap:                                  | 0.96        | 0.96 | 0.00 | 0.00        | 0.13 | 0.05  | 0.96       | 0.00 | 0.49 | 0.00       | 0.00 | 0.00 |
| Delay/Veh:                                   | 23.7        | 23.7 | 0.0  | 0.0         | 2.1  | 0.4   | 109.8      | 0.0  | 53.2 | 0.0        | 0.0  | 0.0  |
| User DelAdj:                                 | 1.00        | 1.00 | 1.00 | 1.00        | 1.00 | 1.00  | 1.00       | 1.00 | 1.00 | 1.00       | 1.00 | 1.00 |
| AdjDel/Veh:                                  | 23.7        | 23.7 | 0.0  | 0.0         | 2.1  | 0.4   | 109.8      | 0.0  | 53.2 | 0.0        | 0.0  | 0.0  |
| LOS by Move:                                 | C           | C    | A    | A           | A    | A     | F          | A    | D    | A          | A    | A    |
| HCM2k95thQ:                                  | 81          | 81   | 0    | 0           | 3    | 1     | 15         | 0    | 6    | 0          | 0    | 0    |

Note: Queue reported is the number of cars per lane.



BART

Level Of Service Computation Report  
 2000 HCM Operations (Future Volume Alternative)  
 PM - Background Conditions

Intersection #128: Homestead/Lafayette [Study Int 50]

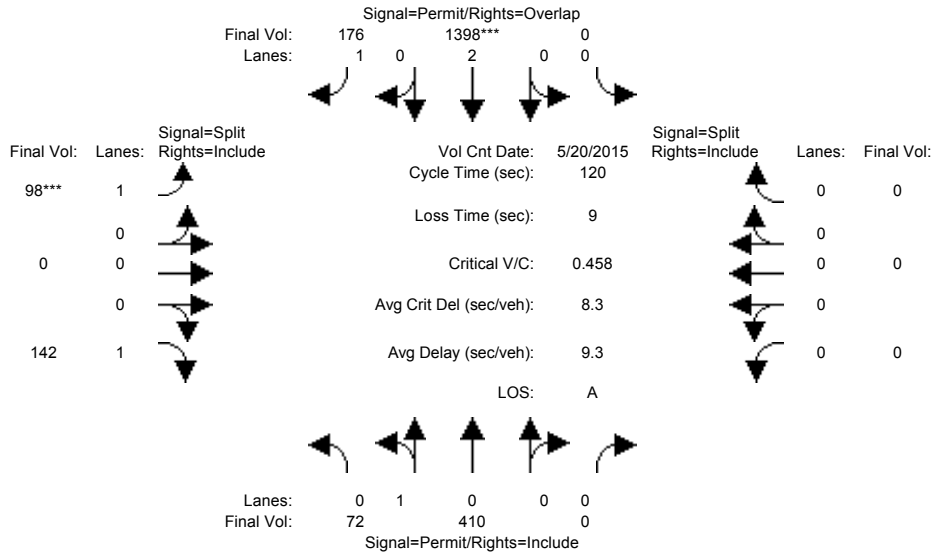

| Approach:   | North Bound |      |      | South Bound |      |       | East Bound |      |      | West Bound |      |      |
|---|-------------|------|------|-------------|------|-------|------------|------|------|------------|------|------|
| Movement:   | L           | T    | R    | L           | T    | R     | L          | T    | R    | L          | T    | R    |
| Min. Green:   | 10          | 10   | 10   | 10          | 10   | 10    | 10         | 10   | 10   | 10         | 10   | 10   |
| Y+R:  | 4.0         | 4.0  | 4.0  | 4.0         | 4.0  | 4.0   | 4.0        | 4.0  | 4.0  | 4.0        | 4.0  | 4.0  |
| ----- ----- ----- ----- ----- ----- ----- ----- ----- ----- ----- ----- ----- |             |      |      |             |      |       |            |      |      |            |      |      |
| Volume Module: >> Count Date: 20 May 2015 <<                                  |             |      |      |             |      |       |            |      |      |            |      |      |
| Base Vol:   | 72          | 410  | 0    | 0           | 1398 | 176   | 98         | 0    | 142  | 0          | 0    | 0    |
| Growth Adj:   | 1.00        | 1.00 | 1.00 | 1.00        | 1.00 | 1.00  | 1.00       | 1.00 | 1.00 | 1.00       | 1.00 | 1.00 |
| Initial Bse:  | 72          | 410  | 0    | 0           | 1398 | 176   | 98         | 0    | 142  | 0          | 0    | 0    |
| Added Vol:  | 0           | 0    | 0    | 0           | 0    | 0     | 0          | 0    | 0    | 0          | 0    | 0    |
| PasserByVol:  | 0           | 0    | 0    | 0           | 0    | 0     | 0          | 0    | 0    | 0          | 0    | 0    |
| Initial Fut:  | 72          | 410  | 0    | 0           | 1398 | 176   | 98         | 0    | 142  | 0          | 0    | 0    |
| User Adj:   | 1.00        | 1.00 | 1.00 | 1.00        | 1.00 | 1.00  | 1.00       | 1.00 | 1.00 | 1.00       | 1.00 | 1.00 |
| PHF Adj:  | 1.00        | 1.00 | 1.00 | 1.00        | 1.00 | 1.00  | 1.00       | 1.00 | 1.00 | 1.00       | 1.00 | 1.00 |
| PHF Volume:   | 72          | 410  | 0    | 0           | 1398 | 176   | 98         | 0    | 142  | 0          | 0    | 0    |
| Reduct Vol:   | 0           | 0    | 0    | 0           | 0    | 0     | 0          | 0    | 0    | 0          | 0    | 0    |
| Reduced Vol:  | 72          | 410  | 0    | 0           | 1398 | 176   | 98         | 0    | 142  | 0          | 0    | 0    |
| PCE Adj:  | 1.00        | 1.00 | 1.00 | 1.00        | 1.00 | 1.00  | 1.00       | 1.00 | 1.00 | 1.00       | 1.00 | 1.00 |
| MLF Adj:  | 1.00        | 1.00 | 1.00 | 1.00        | 1.00 | 1.00  | 1.00       | 1.00 | 1.00 | 1.00       | 1.00 | 1.00 |
| Final Volume:   | 72          | 410  | 0    | 0           | 1398 | 176   | 98         | 0    | 142  | 0          | 0    | 0    |
| ----- ----- ----- ----- ----- ----- ----- ----- ----- ----- ----- -----       |             |      |      |             |      |       |            |      |      |            |      |      |
| Saturation Flow Module:   |             |      |      |             |      |       |            |      |      |            |      |      |
| Sat/Lane:   | 1900        | 1900 | 1900 | 1900        | 1900 | 1900  | 1900       | 1900 | 1900 | 1900       | 1900 | 1900 |
| Adjustment:   | 0.95        | 0.95 | 0.92 | 0.92        | 1.00 | 0.92  | 0.92       | 1.00 | 0.92 | 0.92       | 1.00 | 0.92 |
| Lanes:  | 0.15        | 0.85 | 0.00 | 0.00        | 2.00 | 1.00  | 1.00       | 0.00 | 1.00 | 0.00       | 0.00 | 0.00 |
| Final Sat.:   | 269         | 1531 | 0    | 0           | 3800 | 1750  | 1750       | 0    | 1750 | 0          | 0    | 0    |
| ----- ----- ----- ----- ----- ----- ----- ----- ----- ----- ----- -----       |             |      |      |             |      |       |            |      |      |            |      |      |
| Capacity Analysis Module:   |             |      |      |             |      |       |            |      |      |            |      |      |
| Vol/Sat:  | 0.27        | 0.27 | 0.00 | 0.00        | 0.37 | 0.10  | 0.06       | 0.00 | 0.08 | 0.00       | 0.00 | 0.00 |
| Crit Moves:   | *****       |      |      |             |      |       |            |      |      |            |      |      |
| Green Time:   | 90.9        | 90.9 | 0.0  | 0.0         | 90.9 | 111.0 | 20.1       | 0.0  | 20.1 | 0.0        | 0.0  | 0.0  |
| Volume/Cap:   | 0.35        | 0.35 | 0.00 | 0.00        | 0.49 | 0.11  | 0.34       | 0.00 | 0.49 | 0.00       | 0.00 | 0.00 |
| Delay/Veh:  | 5.0         | 5.0  | 0.0  | 0.0         | 5.7  | 0.4   | 44.8       | 0.0  | 46.6 | 0.0        | 0.0  | 0.0  |
| User DelAdj:  | 1.00        | 1.00 | 1.00 | 1.00        | 1.00 | 1.00  | 1.00       | 1.00 | 1.00 | 1.00       | 1.00 | 1.00 |
| AdjDel/Veh:   | 5.0         | 5.0  | 0.0  | 0.0         | 5.7  | 0.4   | 44.8       | 0.0  | 46.6 | 0.0        | 0.0  | 0.0  |
| LOS by Move:  | A           | A    | A    | A           | A    | A     | D          | A    | D    | A          | A    | A    |
| HCM2k95thQ:   | 12          | 12   | 0    | 0           | 18   | 1     | 7          | 0    | 10   | 0          | 0    | 0    |

Note: Queue reported is the number of cars per lane.

BART

Level Of Service Computation Report  
 2000 HCM Operations (Future Volume Alternative)  
 AM - Background Conditions

Intersection #175: Reed/De La Cruz [Study Int 32]

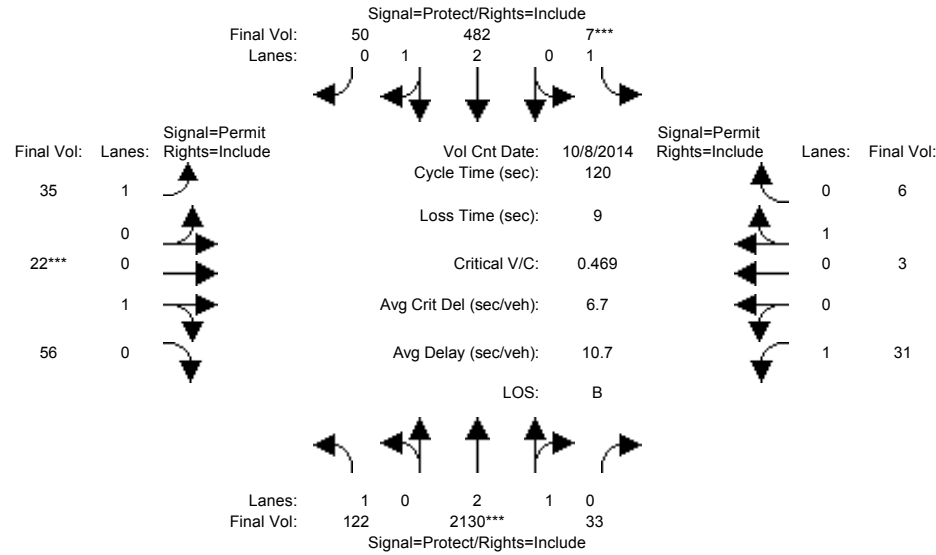

| Approach:                                   | North Bound |      |      | South Bound |      |      | East Bound |      |      | West Bound |      |      |
|---|-------------|------|------|-------------|------|------|------------|------|------|------------|------|------|
| Movement:                                   | L           | T    | R    | L           | T    | R    | L          | T    | R    | L          | T    | R    |
| Min. Green:                                 | 7           | 10   | 10   | 7           | 10   | 10   | 10         | 10   | 10   | 10         | 10   | 10   |
| Y+R:  | 4.0         | 4.0  | 4.0  | 4.0         | 4.0  | 4.0  | 4.0        | 4.0  | 4.0  | 4.0        | 4.0  | 4.0  |
| Volume Module: >> Count Date: 8 Oct 2014 << |             |      |      |             |      |      |            |      |      |            |      |      |
| Base Vol:                                   | 122         | 2130 | 33   | 7           | 482  | 50   | 35         | 22   | 56   | 31         | 3    | 6    |
| Growth Adj:                                 | 1.00        | 1.00 | 1.00 | 1.00        | 1.00 | 1.00 | 1.00       | 1.00 | 1.00 | 1.00       | 1.00 | 1.00 |
| Initial Bse:                                | 122         | 2130 | 33   | 7           | 482  | 50   | 35         | 22   | 56   | 31         | 3    | 6    |
| Added Vol:                                  | 0           | 0    | 0    | 0           | 0    | 0    | 0          | 0    | 0    | 0          | 0    | 0    |
| PasserByVol:                                | 0           | 0    | 0    | 0           | 0    | 0    | 0          | 0    | 0    | 0          | 0    | 0    |
| Initial Fut:                                | 122         | 2130 | 33   | 7           | 482  | 50   | 35         | 22   | 56   | 31         | 3    | 6    |
| User Adj:                                   | 1.00        | 1.00 | 1.00 | 1.00        | 1.00 | 1.00 | 1.00       | 1.00 | 1.00 | 1.00       | 1.00 | 1.00 |
| PHF Adj:                                    | 1.00        | 1.00 | 1.00 | 1.00        | 1.00 | 1.00 | 1.00       | 1.00 | 1.00 | 1.00       | 1.00 | 1.00 |
| PHF Volume:                                 | 122         | 2130 | 33   | 7           | 482  | 50   | 35         | 22   | 56   | 31         | 3    | 6    |
| Reduct Vol:                                 | 0           | 0    | 0    | 0           | 0    | 0    | 0          | 0    | 0    | 0          | 0    | 0    |
| Reduced Vol:                                | 122         | 2130 | 33   | 7           | 482  | 50   | 35         | 22   | 56   | 31         | 3    | 6    |
| PCE Adj:                                    | 1.00        | 1.00 | 1.00 | 1.00        | 1.00 | 1.00 | 1.00       | 1.00 | 1.00 | 1.00       | 1.00 | 1.00 |
| MLF Adj:                                    | 1.00        | 1.00 | 1.00 | 1.00        | 1.00 | 1.00 | 1.00       | 1.00 | 1.00 | 1.00       | 1.00 | 1.00 |
| Final Volume:                               | 122         | 2130 | 33   | 7           | 482  | 50   | 35         | 22   | 56   | 31         | 3    | 6    |
| Saturation Flow Module:                     |             |      |      |             |      |      |            |      |      |            |      |      |
| Sat/Lane:                                   | 1900        | 1900 | 1900 | 1900        | 1900 | 1900 | 1900       | 1900 | 1900 | 1900       | 1900 | 1900 |
| Adjustment:                                 | 0.92        | 0.98 | 0.95 | 0.92        | 0.99 | 0.95 | 0.92       | 0.95 | 0.95 | 0.92       | 0.95 | 0.95 |
| Lanes:                                      | 1.00        | 2.95 | 0.05 | 1.00        | 2.71 | 0.29 | 1.00       | 0.28 | 0.72 | 1.00       | 0.33 | 0.67 |
| Final Sat.:                                 | 1750        | 5514 | 85   | 1750        | 5073 | 526  | 1750       | 508  | 1292 | 1750       | 600  | 1200 |
| Capacity Analysis Module:                   |             |      |      |             |      |      |            |      |      |            |      |      |
| Vol/Sat:                                    | 0.07        | 0.39 | 0.39 | 0.00        | 0.10 | 0.10 | 0.02       | 0.04 | 0.04 | 0.02       | 0.01 | 0.01 |
| Crit Moves:                                 | ****        | **** | **** | ****        | **** | **** | ****       | **** | **** | ****       | **** | **** |
| Green Time:                                 | 42.5        | 93.5 | 93.5 | 7.0         | 58.0 | 58.0 | 10.5       | 10.5 | 10.5 | 10.5       | 10.5 | 10.5 |
| Volume/Cap:                                 | 0.20        | 0.50 | 0.50 | 0.07        | 0.20 | 0.20 | 0.23       | 0.50 | 0.50 | 0.20       | 0.06 | 0.06 |
| Delay/Veh:                                  | 27.0        | 4.9  | 4.9  | 53.7        | 17.7 | 17.7 | 51.8       | 54.7 | 54.7 | 51.5       | 50.4 | 50.4 |
| User DelAdj:                                | 1.00        | 1.00 | 1.00 | 1.00        | 1.00 | 1.00 | 1.00       | 1.00 | 1.00 | 1.00       | 1.00 | 1.00 |
| AdjDel/Veh:                                 | 27.0        | 4.9  | 4.9  | 53.7        | 17.7 | 17.7 | 51.8       | 54.7 | 54.7 | 51.5       | 50.4 | 50.4 |
| LOS by Move:                                | C           | A    | A    | D           | B    | B    | D          | D    | D    | D          | D    | D    |
| HCM2k95thQ:                                 | 7           | 18   | 18   | 1           | 7    | 7    | 3          | 6    | 6    | 3          | 1    | 1    |

Note: Queue reported is the number of cars per lane.

BART

Level Of Service Computation Report  
 2000 HCM Operations (Future Volume Alternative)  
 PM - Background Conditions

Intersection #175: Reed/De La Cruz [Study Int 32]

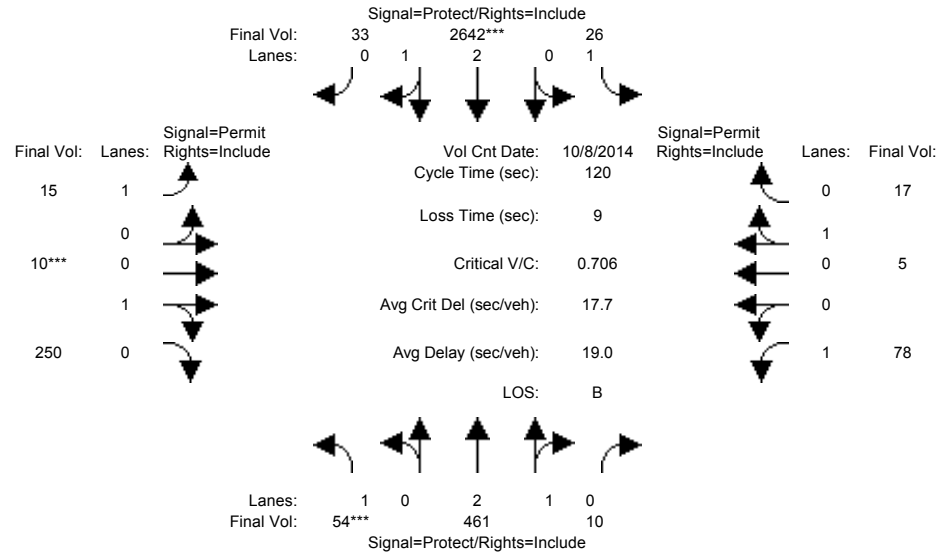

| Approach:                                   | North Bound |      |      | South Bound |      |      | East Bound |      |      | West Bound |      |      |
|---|-------------|------|------|-------------|------|------|------------|------|------|------------|------|------|
| Movement:                                   | L           | T    | R    | L           | T    | R    | L          | T    | R    | L          | T    | R    |
| Min. Green:                                 | 7           | 10   | 10   | 7           | 10   | 10   | 10         | 10   | 10   | 10         | 10   | 10   |
| Y+R:  | 4.0         | 4.0  | 4.0  | 4.0         | 4.0  | 4.0  | 4.0        | 4.0  | 4.0  | 4.0        | 4.0  | 4.0  |
| Volume Module: >> Count Date: 8 Oct 2014 << |             |      |      |             |      |      |            |      |      |            |      |      |
| Base Vol:                                   | 54          | 461  | 10   | 26          | 2642 | 33   | 15         | 10   | 250  | 78         | 5    | 17   |
| Growth Adj:                                 | 1.00        | 1.00 | 1.00 | 1.00        | 1.00 | 1.00 | 1.00       | 1.00 | 1.00 | 1.00       | 1.00 | 1.00 |
| Initial Bse:                                | 54          | 461  | 10   | 26          | 2642 | 33   | 15         | 10   | 250  | 78         | 5    | 17   |
| Added Vol:                                  | 0           | 0    | 0    | 0           | 0    | 0    | 0          | 0    | 0    | 0          | 0    | 0    |
| PasserByVol:                                | 0           | 0    | 0    | 0           | 0    | 0    | 0          | 0    | 0    | 0          | 0    | 0    |
| Initial Fut:                                | 54          | 461  | 10   | 26          | 2642 | 33   | 15         | 10   | 250  | 78         | 5    | 17   |
| User Adj:                                   | 1.00        | 1.00 | 1.00 | 1.00        | 1.00 | 1.00 | 1.00       | 1.00 | 1.00 | 1.00       | 1.00 | 1.00 |
| PHF Adj:                                    | 1.00        | 1.00 | 1.00 | 1.00        | 1.00 | 1.00 | 1.00       | 1.00 | 1.00 | 1.00       | 1.00 | 1.00 |
| PHF Volume:                                 | 54          | 461  | 10   | 26          | 2642 | 33   | 15         | 10   | 250  | 78         | 5    | 17   |
| Reduct Vol:                                 | 0           | 0    | 0    | 0           | 0    | 0    | 0          | 0    | 0    | 0          | 0    | 0    |
| Reduced Vol:                                | 54          | 461  | 10   | 26          | 2642 | 33   | 15         | 10   | 250  | 78         | 5    | 17   |
| PCE Adj:                                    | 1.00        | 1.00 | 1.00 | 1.00        | 1.00 | 1.00 | 1.00       | 1.00 | 1.00 | 1.00       | 1.00 | 1.00 |
| MLF Adj:                                    | 1.00        | 1.00 | 1.00 | 1.00        | 1.00 | 1.00 | 1.00       | 1.00 | 1.00 | 1.00       | 1.00 | 1.00 |
| Final Volume:                               | 54          | 461  | 10   | 26          | 2642 | 33   | 15         | 10   | 250  | 78         | 5    | 17   |
| Saturation Flow Module:                     |             |      |      |             |      |      |            |      |      |            |      |      |
| Sat/Lane:                                   | 1900        | 1900 | 1900 | 1900        | 1900 | 1900 | 1900       | 1900 | 1900 | 1900       | 1900 | 1900 |
| Adjustment:                                 | 0.92        | 0.98 | 0.95 | 0.92        | 0.98 | 0.95 | 0.92       | 0.95 | 0.95 | 0.92       | 0.95 | 0.95 |
| Lanes:                                      | 1.00        | 2.93 | 0.07 | 1.00        | 2.96 | 0.04 | 1.00       | 0.04 | 0.96 | 1.00       | 0.23 | 0.77 |
| Final Sat.:                                 | 1750        | 5481 | 119  | 1750        | 5531 | 69   | 1750       | 69   | 1731 | 1750       | 409  | 1391 |
| Capacity Analysis Module:                   |             |      |      |             |      |      |            |      |      |            |      |      |
| Vol/Sat:                                    | 0.03        | 0.08 | 0.08 | 0.01        | 0.48 | 0.48 | 0.01       | 0.14 | 0.14 | 0.04       | 0.01 | 0.01 |
| Crit Moves:                                 | ****        |      |      | ****        |      |      | ****       |      |      | ****       |      |      |
| Green Time:                                 | 7.0         | 51.3 | 51.3 | 35.6        | 79.9 | 79.9 | 24.1       | 24.1 | 24.1 | 24.1       | 24.1 | 24.1 |
| Volume/Cap:                                 | 0.53        | 0.20 | 0.20 | 0.05        | 0.72 | 0.72 | 0.04       | 0.72 | 0.72 | 0.22       | 0.06 | 0.06 |
| Delay/Veh:                                  | 60.0        | 21.5 | 21.5 | 30.2        | 13.5 | 13.5 | 38.7       | 51.5 | 51.5 | 40.4       | 38.8 | 38.8 |
| User DelAdj:                                | 1.00        | 1.00 | 1.00 | 1.00        | 1.00 | 1.00 | 1.00       | 1.00 | 1.00 | 1.00       | 1.00 | 1.00 |
| AdjDel/Veh:                                 | 60.0        | 21.5 | 21.5 | 30.2        | 13.5 | 13.5 | 38.7       | 51.5 | 51.5 | 40.4       | 38.8 | 38.8 |
| LOS by Move:                                | E           | C    | C    | C           | B    | B    | D          | D    | D    | D          | D    | D    |
| HCM2k95thQ:                                 | 6           | 7    | 7    | 1           | 36   | 36   | 1          | 18   | 18   | 5          | 1    | 1    |

Note: Queue reported is the number of cars per lane.

BART

Level Of Service Computation Report  
2000 HCM Unsignalized (Future Volume Alternative)  
AM - Background Conditions

Intersection #1008: Lafayette/Harrison (unsignalized) [Study Int 48]

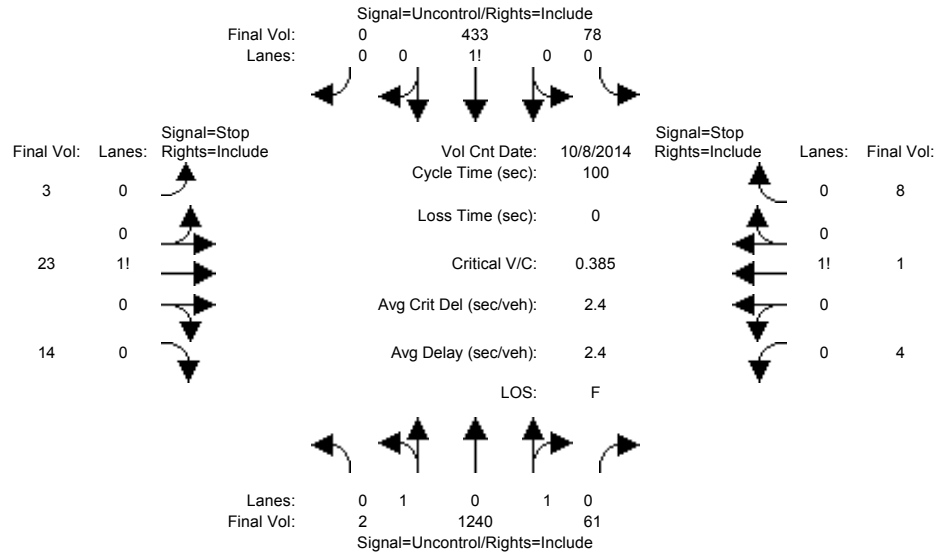

| Approach:   | North Bound               | South Bound       | East Bound        | West Bound        |
|---|---------------------------|-------------------|-------------------|-------------------|
| Movement:   | L - T - R                 | L - T - R         | L - T - R         | L - T - R         |
| Volume Module: >> Count Date: 8 Oct 2014 <<                               |                           |                   |                   |                   |
| Base Vol:   | 2 1240                    | 61 78 433         | 0 3 23 14         | 4 1 8             |
| Growth Adj:   | 1.00 1.00 1.00            | 1.00 1.00 1.00    | 1.00 1.00 1.00    | 1.00 1.00 1.00    |
| Initial Bse:  | 2 1240                    | 61 78 433         | 0 3 23 14         | 4 1 8             |
| Added Vol:  | 0 0 0                     | 0 0 0             | 0 0 0             | 0 0 0             |
| PasserByVol:  | 0 0 0                     | 0 0 0             | 0 0 0             | 0 0 0             |
| Initial Fut:  | 2 1240                    | 61 78 433         | 0 3 23 14         | 4 1 8             |
| User Adj:   | 1.00 1.00 1.00            | 1.00 1.00 1.00    | 1.00 1.00 1.00    | 1.00 1.00 1.00    |
| PHF Adj:  | 1.00 1.00 1.00            | 1.00 1.00 1.00    | 1.00 1.00 1.00    | 1.00 1.00 1.00    |
| PHF Volume:   | 2 1240                    | 61 78 433         | 0 3 23 14         | 4 1 8             |
| Reduct Vol:   | 0 0 0                     | 0 0 0             | 0 0 0             | 0 0 0             |
| FinalVolume:  | 2 1240                    | 61 78 433         | 0 3 23 14         | 4 1 8             |
| Critical Gap Module:  |                           |                   |                   |                   |
| Critical Gp:  | 4.1 xxxxx xxxxxx          | 4.1 xxxxx xxxxxx  | 7.1 6.5 6.2       | 7.1 6.5 6.2       |
| FollowUpTim:  | 2.2 xxxxx xxxxxx          | 2.2 xxxxx xxxxxx  | 3.5 4.0 3.3       | 3.5 4.0 3.3       |
| Capacity Module:  |                           |                   |                   |                   |
| Cnflct Vol:   | 433 xxxxx xxxxxx          | 1301 xxxxx xxxxxx | 1214 1894 433     | 1882 1864 651     |
| Potent Cap.:  | 1137 xxxxx xxxxxx         | 539 xxxxx xxxxxx  | 160 71 627        | 55 74 472         |
| Move Cap.:  | 1137 xxxxx xxxxxx         | 539 xxxxx xxxxxx  | 137 60 627        | 33 62 472         |
| Volume/Cap:   | 0.00 xxxxx xxxxx          | 0.14 xxxxx xxxxx  | 0.02 0.38 0.02    | 0.12 0.02 0.02    |
| Level Of Service Module:  |                           |                   |                   |                   |
| 2Way95thQ:  | 0.0 xxxxx xxxxxx          | 0.5 xxxxx xxxxxx  | xxxx xxxxx xxxxxx | xxxx xxxxx xxxxxx |
| Control Del:  | 8.2 xxxxx xxxxxx          | 12.8 xxxxx xxxxxx | xxxx xxxxx xxxxxx | xxxx xxxxx xxxxxx |
| LOS by Move:  | A * * * *                 | B * * * *         | * * * * *         | * * * * *         |
| Movement:   | LT - LTR - RT             | LT - LTR - RT     | LT - LTR - RT     | LT - LTR - RT     |
| Shared Cap.:  | xxxx xxxxx xxxxxx         | xxxx xxxxx xxxxxx | 93 xxxxxx         | 85 xxxxxx         |
| SharedQueue:  | 0.0 xxxxx xxxxxx          | 0.5 xxxxx xxxxxx  | 1.8 xxxxxx        | 0.5 xxxxxx        |
| Shrd ConDel:  | 8.2 xxxxx xxxxxx          | 12.8 xxxxx xxxxxx | 69.9 xxxxxx       | 54.7 xxxxxx       |
| Shared LOS:   | A * * * *                 | B * * * *         | F * * * *         | F * * * *         |
| ApproachDel:  | xxxxxx                    | xxxxxx            | 69.9              | 54.7              |
| ApproachLOS:  | *                         | *                 | F                 | F                 |
| Note: Queue reported is the number of cars per lane.                      |                           |                   |                   |                   |
| HevVeh:   | 0%                        | 0%                | 0%                | 0%                |
| Grade:  | 0%                        | 0%                | 0%                | 0%                |
| Peds/Hour:  | 0                         | 0                 | 0                 | 0                 |
| Pedestrian Walk Speed:  | 4.00 feet/sec             | 4.00 feet/sec     | 4.00 feet/sec     | 4.00 feet/sec     |
| LaneWidth:  | 12 feet                   | 12 feet           | 12 feet           | 12 feet           |
| Time Period:  | 0.25 hour                 | 0.25 hour         | 0.25 hour         | 0.25 hour         |
| Upstream Signals:   |                           |                   |                   |                   |
| Link Index:   | #718                      | #974              |                   |                   |
| Dist (miles):   | 0.000                     | 0.000             |                   |                   |
| Speed (mph):  | 0.00                      | 0.00              |                   |                   |
| SignalIndex:  | #107                      | #5444             |                   |                   |
| Cycle Time:   | 0 secs                    | 0 secs            |                   |                   |
| InitVolume:   | 0 0                       | 0 0               |                   |                   |
| Saturation:   | 0 0                       | 0 0               |                   |                   |
| ArrivalType:  | 0 0                       | 0 0               |                   |                   |
| G/C:  | 0.00 0.00                 | 0.00 0.00         |                   |                   |
| *** Computation 1: Time for Queue to Clear at Each Upstream Intersection  |                           |                   |                   |                   |
| P:  | 0.000 0.000               | 0.000 0.000       |                   |                   |
| gg1:  | 0.00 0.00                 | 0.00 0.00         |                   |                   |
| gg2:  | 0.00 0.00                 | 0.00 0.00         |                   |                   |
| gg:   | 0.00 0.00                 | 0.00 0.00         |                   |                   |
| *** Computation 2: Time Intersection Blocked Because of Upstream Platoons |                           |                   |                   |                   |
| alpha:  | 0.000                     | 0.000             |                   |                   |
| beta:   | 0.000                     | 0.000             |                   |                   |
| ta (secs):  | 0.000                     | 0.000             |                   |                   |
| F:  | 0.000                     | 0.000             |                   |                   |
| f:  | 0.000 0.000               | 0.000 0.000       |                   |                   |
| vcmax:  | 0 0                       | 0 0               |                   |                   |
| vcg:  | 0 0                       | 0 0               |                   |                   |
| vcmin:  | 0 0                       | 0 0               |                   |                   |
| tp:   | 0.0 0.0                   | 0.0 0.0           |                   |                   |
| P1:   | 0.000                     | 0.000             |                   |                   |
| *** Computation 3: Platoon Event Periods                                  |                           |                   |                   |                   |
| pdom/psubo:   | 0.000/0.000/Unconstrained |                   |                   |                   |
| *** Computation 4: Conflicting Flows During Each Unblocked Period         |                           |                   |                   |                   |
| InitCnflVol:  | 433 xxxxx xxxxxx          | 1301 xxxxx xxxxxx | 1214 1894 433     | 1882 1864 651     |
| AdjCnflVol:   | 433 xxxxx xxxxxx          | 1301 xxxxx xxxxxx | 1214 1894 433     | 1882 1864 651     |
| UpstreamAdj:  | 1.00 x.xxx x.xxx          | 1.00 x.xxx x.xxx  | 1.00 1.000 1.000  | 1.00 1.000 1.000  |

ConflictVol: 433 xxxxx xxxxx 1301 xxxxx xxxxx 1214 1894 433 1882 1864 651  
\*\*\* Computation 5: Capacity for Subject Movement During Unblocked Period  
InitPotCap: 1137 xxxxx xxxxx 539 xxxxx xxxxx 160 71 627 55 74 472  
UpstreamAdj:1.00 x.xxx x.xxx 1.00 x.xxx x.xxx 1.00 1.000 1.000 1.00 1.000  
Potent Cap.:1137 xxxxx xxxxx 539 xxxxx xxxxx 160 71 627 55 74 472

BART

Level Of Service Computation Report
2000 HCM Unsignalized (Future Volume Alternative)
PM - Background Conditions

Intersection #1008: Lafayette/Harrison (unsignalized) [Study Int 48]

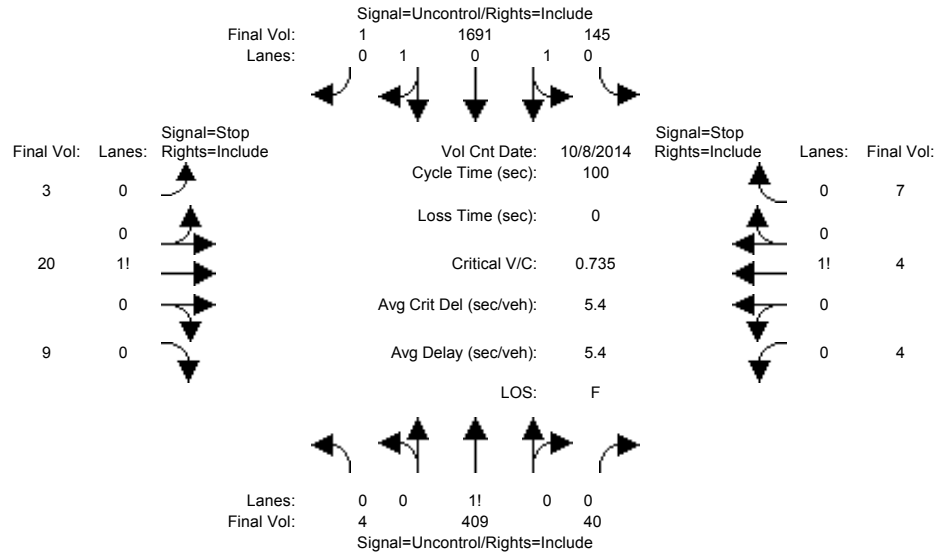

Table of traffic engineering data including:
Approach: North Bound, South Bound, East Bound, West Bound
Movement: L - T - R
Volume Module: Count Date: 8 Oct 2014
Base Vol, Growth Adj, Initial Bse, Added Vol, PasserByVol, Initial Fut, User Adj, PHF Adj, PHF Volume, Reduct Vol, FinalVolume
Critical Gap Module: Critical Gap, FollowUpTim
Capacity Module: Conflict Vol, Potent Cap., Move Cap., Volume/Cap.
Level Of Service Module: 2Way95thQ, Control Del, LOS by Move, Movement, Shared Cap., Shared Queue, Shrd ConDel, Shared LOS, ApproachDel, ApproachLOS
Note: Queue reported is the number of cars per lane.
HevVeh, Grade, Peds/Hour, Pedestrian Walk Speed, LaneWidth, Time Period, Upstream Signals, Link Index, Dist(miles), Speed(mph), SignalIndex, Cycle Time, InitVolume, Saturation, ArrivalType, G/C, Computation 1, Computation 2, Computation 3, Computation 4.

ConflictVol:1692 xxxxx xxxxx 449 xxxxx xxxxx 2424 2439 846 1583 2419 429  
\*\*\* Computation 5: Capacity for Subject Movement During Unblocked Period  
InitPotCap: 382 xxxxx xxxxx 1122 xxxxx xxxxx 22 32 365 89 33 630  
UpstreamAdj:1.00 x.xxx x.xxx 1.00 x.xxx x.xxx 1.00 1.000 1.000 1.00 1.000 1.000  
Potent Cap.: 382 xxxxx xxxxx 1122 xxxxx xxxxx 22 32 365 89 33 630

BART

Level Of Service Computation Report  
2000 HCM Operations (Future Volume Alternative)  
AM - Background Conditions

Intersection #1012: El Camino Real/Railroad Ave [Study Int 53]

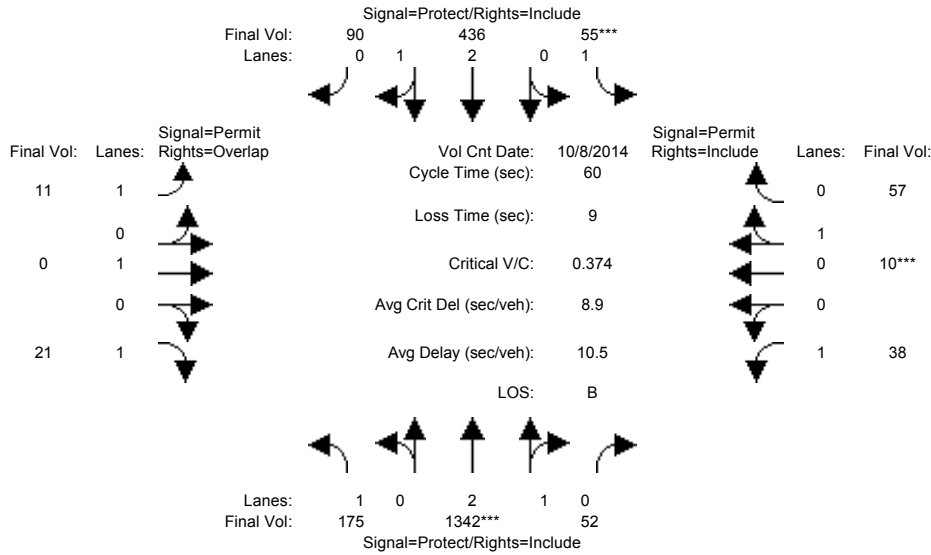

| Approach:                     | North Bound   |      |      | South Bound |      |      | East Bound |      |      | West Bound |      |      |
|-------------------------------|---------------|------|------|-------------|------|------|------------|------|------|------------|------|------|
| Movement:                     | L             | T    | R    | L           | T    | R    | L          | T    | R    | L          | T    | R    |
| Min. Green:                   | 7             | 10   | 10   | 7           | 10   | 10   | 10         | 10   | 10   | 10         | 10   | 10   |
| Y+R:                          | 4.0           | 4.0  | 4.0  | 4.0         | 4.0  | 4.0  | 4.0        | 4.0  | 4.0  | 4.0        | 4.0  | 4.0  |
| -----                         |               |      |      |             |      |      |            |      |      |            |      |      |
| Volume Module: >> Count Date: | 8 Oct 2014 << |      |      |             |      |      |            |      |      |            |      |      |
| Base Vol:                     | 175           | 1342 | 52   | 55          | 436  | 90   | 11         | 0    | 21   | 38         | 10   | 57   |
| Growth Adj:                   | 1.00          | 1.00 | 1.00 | 1.00        | 1.00 | 1.00 | 1.00       | 1.00 | 1.00 | 1.00       | 1.00 | 1.00 |
| Initial Bse:                  | 175           | 1342 | 52   | 55          | 436  | 90   | 11         | 0    | 21   | 38         | 10   | 57   |
| Added Vol:                    | 0             | 0    | 0    | 0           | 0    | 0    | 0          | 0    | 0    | 0          | 0    | 0    |
| PasserByVol:                  | 0             | 0    | 0    | 0           | 0    | 0    | 0          | 0    | 0    | 0          | 0    | 0    |
| Initial Fut:                  | 175           | 1342 | 52   | 55          | 436  | 90   | 11         | 0    | 21   | 38         | 10   | 57   |
| User Adj:                     | 1.00          | 1.00 | 1.00 | 1.00        | 1.00 | 1.00 | 1.00       | 1.00 | 1.00 | 1.00       | 1.00 | 1.00 |
| PHF Adj:                      | 1.00          | 1.00 | 1.00 | 1.00        | 1.00 | 1.00 | 1.00       | 1.00 | 1.00 | 1.00       | 1.00 | 1.00 |
| PHF Volume:                   | 175           | 1342 | 52   | 55          | 436  | 90   | 11         | 0    | 21   | 38         | 10   | 57   |
| Reduct Vol:                   | 0             | 0    | 0    | 0           | 0    | 0    | 0          | 0    | 0    | 0          | 0    | 0    |
| Reduced Vol:                  | 175           | 1342 | 52   | 55          | 436  | 90   | 11         | 0    | 21   | 38         | 10   | 57   |
| PCE Adj:                      | 1.00          | 1.00 | 1.00 | 1.00        | 1.00 | 1.00 | 1.00       | 1.00 | 1.00 | 1.00       | 1.00 | 1.00 |
| MLF Adj:                      | 1.00          | 1.00 | 1.00 | 1.00        | 1.00 | 1.00 | 1.00       | 1.00 | 1.00 | 1.00       | 1.00 | 1.00 |
| FinalVolume:                  | 175           | 1342 | 52   | 55          | 436  | 90   | 11         | 0    | 21   | 38         | 10   | 57   |
| -----                         |               |      |      |             |      |      |            |      |      |            |      |      |
| Saturation Flow Module:       |               |      |      |             |      |      |            |      |      |            |      |      |
| Sat/Lane:                     | 1900          | 1900 | 1900 | 1900        | 1900 | 1900 | 1900       | 1900 | 1900 | 1900       | 1900 | 1900 |
| Adjustment:                   | 0.92          | 0.98 | 0.95 | 0.92        | 0.99 | 0.95 | 0.92       | 1.00 | 0.92 | 0.92       | 0.95 | 0.95 |
| Lanes:                        | 1.00          | 2.88 | 0.12 | 1.00        | 2.47 | 0.53 | 1.00       | 1.00 | 1.00 | 1.00       | 0.15 | 0.85 |
| Final Sat.:                   | 1750          | 5391 | 209  | 1750        | 4641 | 958  | 1750       | 1900 | 1750 | 1750       | 269  | 1531 |
| -----                         |               |      |      |             |      |      |            |      |      |            |      |      |
| Capacity Analysis Module:     |               |      |      |             |      |      |            |      |      |            |      |      |
| Vol/Sat:                      | 0.10          | 0.25 | 0.25 | 0.03        | 0.09 | 0.09 | 0.01       | 0.00 | 0.01 | 0.02       | 0.04 | 0.04 |
| Crit Moves:                   | ****          |      |      | ****        |      |      | ****       |      |      | ****       |      |      |
| Green Time:                   | 16.9          | 34.0 | 34.0 | 7.0         | 24.1 | 24.1 | 10.0       | 0.0  | 26.9 | 10.0       | 10.0 | 10.0 |
| Volume/Cap:                   | 0.36          | 0.44 | 0.44 | 0.27        | 0.23 | 0.23 | 0.04       | 0.00 | 0.03 | 0.13       | 0.22 | 0.22 |
| Delay/Veh:                    | 17.7          | 7.6  | 7.6  | 24.9        | 11.9 | 11.9 | 21.0       | 0.0  | 9.3  | 21.5       | 22.0 | 22.0 |
| User DelAdj:                  | 1.00          | 1.00 | 1.00 | 1.00        | 1.00 | 1.00 | 1.00       | 1.00 | 1.00 | 1.00       | 1.00 | 1.00 |
| AdjDel/Veh:                   | 17.7          | 7.6  | 7.6  | 24.9        | 11.9 | 11.9 | 21.0       | 0.0  | 9.3  | 21.5       | 22.0 | 22.0 |
| LOS by Move:                  | B             | A    | A    | C           | B    | B    | C          | A    | A    | C          | C    | C    |
| HCM2k95thQ:                   | 6             | 10   | 10   | 2           | 4    | 4    | 0          | 0    | 1    | 2          | 3    | 3    |

Note: Queue reported is the number of cars per lane.



BART

Level Of Service Computation Report  
 2000 HCM Operations (Future Volume Alternative)  
 PM - Background Conditions

Intersection #1012: El Camino Real/Railroad Ave [Study Int 53]

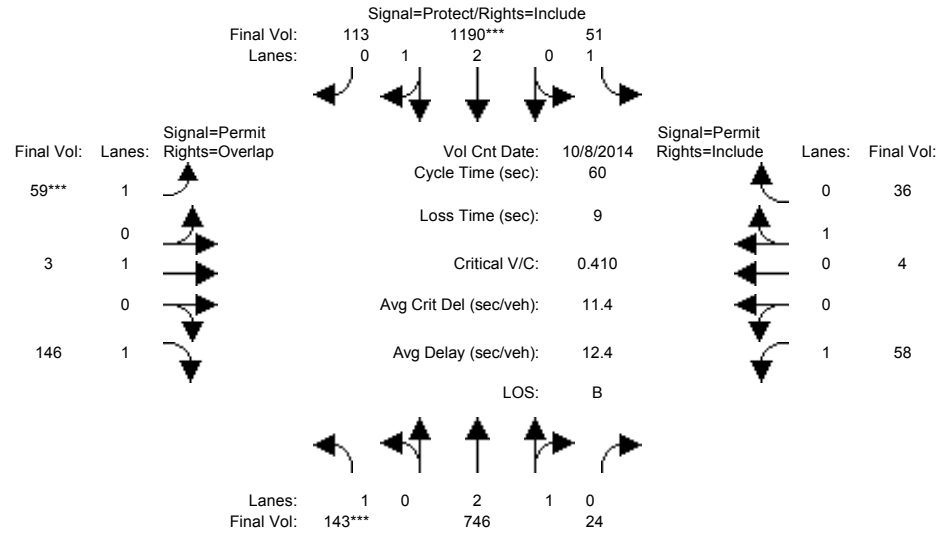

| Approach:                     | North Bound   |      |      | South Bound |      |      | East Bound |      |      | West Bound |      |      |
|-------------------------------|---------------|------|------|-------------|------|------|------------|------|------|------------|------|------|
| Movement:                     | L             | T    | R    | L           | T    | R    | L          | T    | R    | L          | T    | R    |
| Min. Green:                   | 7             | 10   | 10   | 7           | 10   | 10   | 10         | 10   | 10   | 10         | 10   | 10   |
| Y+R:                          | 4.0           | 4.0  | 4.0  | 4.0         | 4.0  | 4.0  | 4.0        | 4.0  | 4.0  | 4.0        | 4.0  | 4.0  |
| -----                         |               |      |      |             |      |      |            |      |      |            |      |      |
| Volume Module: >> Count Date: | 8 Oct 2014 << |      |      |             |      |      |            |      |      |            |      |      |
| Base Vol:                     | 143           | 746  | 24   | 51          | 1190 | 113  | 59         | 3    | 146  | 58         | 4    | 36   |
| Growth Adj:                   | 1.00          | 1.00 | 1.00 | 1.00        | 1.00 | 1.00 | 1.00       | 1.00 | 1.00 | 1.00       | 1.00 | 1.00 |
| Initial Bse:                  | 143           | 746  | 24   | 51          | 1190 | 113  | 59         | 3    | 146  | 58         | 4    | 36   |
| Added Vol:                    | 0             | 0    | 0    | 0           | 0    | 0    | 0          | 0    | 0    | 0          | 0    | 0    |
| PasserByVol:                  | 0             | 0    | 0    | 0           | 0    | 0    | 0          | 0    | 0    | 0          | 0    | 0    |
| Initial Fut:                  | 143           | 746  | 24   | 51          | 1190 | 113  | 59         | 3    | 146  | 58         | 4    | 36   |
| User Adj:                     | 1.00          | 1.00 | 1.00 | 1.00        | 1.00 | 1.00 | 1.00       | 1.00 | 1.00 | 1.00       | 1.00 | 1.00 |
| PHF Adj:                      | 1.00          | 1.00 | 1.00 | 1.00        | 1.00 | 1.00 | 1.00       | 1.00 | 1.00 | 1.00       | 1.00 | 1.00 |
| PHF Volume:                   | 143           | 746  | 24   | 51          | 1190 | 113  | 59         | 3    | 146  | 58         | 4    | 36   |
| Reduct Vol:                   | 0             | 0    | 0    | 0           | 0    | 0    | 0          | 0    | 0    | 0          | 0    | 0    |
| Reduced Vol:                  | 143           | 746  | 24   | 51          | 1190 | 113  | 59         | 3    | 146  | 58         | 4    | 36   |
| PCE Adj:                      | 1.00          | 1.00 | 1.00 | 1.00        | 1.00 | 1.00 | 1.00       | 1.00 | 1.00 | 1.00       | 1.00 | 1.00 |
| MLF Adj:                      | 1.00          | 1.00 | 1.00 | 1.00        | 1.00 | 1.00 | 1.00       | 1.00 | 1.00 | 1.00       | 1.00 | 1.00 |
| Final Volume:                 | 143           | 746  | 24   | 51          | 1190 | 113  | 59         | 3    | 146  | 58         | 4    | 36   |
| -----                         |               |      |      |             |      |      |            |      |      |            |      |      |
| Saturation Flow Module:       |               |      |      |             |      |      |            |      |      |            |      |      |
| Sat/Lane:                     | 1900          | 1900 | 1900 | 1900        | 1900 | 1900 | 1900       | 1900 | 1900 | 1900       | 1900 | 1900 |
| Adjustment:                   | 0.92          | 0.98 | 0.95 | 0.92        | 0.99 | 0.95 | 0.92       | 1.00 | 0.92 | 0.92       | 0.95 | 0.95 |
| Lanes:                        | 1.00          | 2.90 | 0.10 | 1.00        | 2.73 | 0.27 | 1.00       | 1.00 | 1.00 | 1.00       | 0.10 | 0.90 |
| Final Sat.:                   | 1750          | 5425 | 175  | 1750        | 5114 | 486  | 1750       | 1900 | 1750 | 1750       | 180  | 1620 |
| -----                         |               |      |      |             |      |      |            |      |      |            |      |      |
| Capacity Analysis Module:     |               |      |      |             |      |      |            |      |      |            |      |      |
| Vol/Sat:                      | 0.08          | 0.14 | 0.14 | 0.03        | 0.23 | 0.23 | 0.03       | 0.00 | 0.08 | 0.03       | 0.02 | 0.02 |
| Crit Moves:                   | ****          |      |      | ****        |      |      | ****       |      |      |            |      |      |
| Green Time:                   | 10.7          | 24.1 | 24.1 | 16.9        | 30.3 | 30.3 | 10.0       | 10.0 | 20.7 | 10.0       | 10.0 | 10.0 |
| Volume/Cap:                   | 0.46          | 0.34 | 0.34 | 0.10        | 0.46 | 0.46 | 0.20       | 0.01 | 0.24 | 0.20       | 0.13 | 0.13 |
| Delay/Veh:                    | 23.2          | 12.5 | 12.5 | 16.1        | 9.7  | 9.7  | 21.9       | 20.9 | 14.3 | 21.9       | 21.5 | 21.5 |
| User DelAdj:                  | 1.00          | 1.00 | 1.00 | 1.00        | 1.00 | 1.00 | 1.00       | 1.00 | 1.00 | 1.00       | 1.00 | 1.00 |
| AdjDel/Veh:                   | 23.2          | 12.5 | 12.5 | 16.1        | 9.7  | 9.7  | 21.9       | 20.9 | 14.3 | 21.9       | 21.5 | 21.5 |
| LOS by Move:                  | C             | B    | B    | B           | A    | A    | C          | C    | B    | C          | C    | C    |
| HCM2k95thQ:                   | 6             | 7    | 7    | 1           | 10   | 10   | 2          | 0    | 4    | 2          | 2    | 2    |

Note: Queue reported is the number of cars per lane.

BART

Level Of Service Computation Report  
 2000 HCM Operations (Future Volume Alternative)  
 AM - Background Conditions

Intersection #1202: LAFAYETTE/EL CAMINO REAL [Study Int 46]

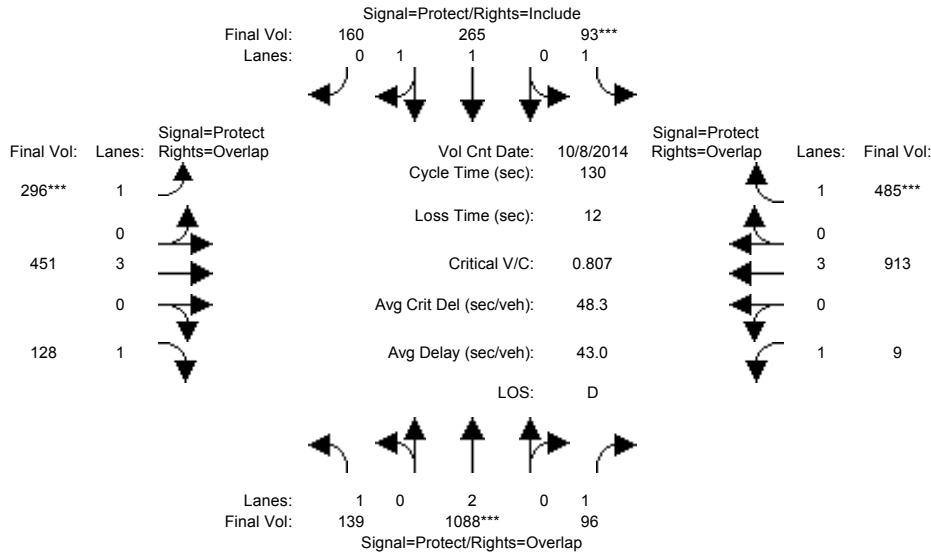

| Approach:   | North Bound |      |      | South Bound |      |      | East Bound |      |      | West Bound |      |      |
|---|-------------|------|------|-------------|------|------|------------|------|------|------------|------|------|
| Movement:   | L           | T    | R    | L           | T    | R    | L          | T    | R    | L          | T    | R    |
| Min. Green:   | 7           | 10   | 10   | 7           | 10   | 10   | 7          | 10   | 10   | 7          | 10   | 10   |
| Y+R:  | 4.0         | 4.0  | 4.0  | 4.0         | 4.0  | 4.0  | 4.0        | 4.0  | 4.0  | 4.0        | 4.0  | 4.0  |
| ----- ----- ----- ----- ----- ----- ----- ----- ----- ----- ----- ----- ----- |             |      |      |             |      |      |            |      |      |            |      |      |
| Volume Module: >> Count Date: 8 Oct 2014 <<                                   |             |      |      |             |      |      |            |      |      |            |      |      |
| Base Vol:   | 139         | 1088 | 96   | 93          | 265  | 160  | 296        | 451  | 128  | 9          | 913  | 485  |
| Growth Adj:   | 1.00        | 1.00 | 1.00 | 1.00        | 1.00 | 1.00 | 1.00       | 1.00 | 1.00 | 1.00       | 1.00 | 1.00 |
| Initial Bse:  | 139         | 1088 | 96   | 93          | 265  | 160  | 296        | 451  | 128  | 9          | 913  | 485  |
| Added Vol:  | 0           | 0    | 0    | 0           | 0    | 0    | 0          | 0    | 0    | 0          | 0    | 0    |
| PasserByVol:  | 0           | 0    | 0    | 0           | 0    | 0    | 0          | 0    | 0    | 0          | 0    | 0    |
| Initial Fut:  | 139         | 1088 | 96   | 93          | 265  | 160  | 296        | 451  | 128  | 9          | 913  | 485  |
| User Adj:   | 1.00        | 1.00 | 1.00 | 1.00        | 1.00 | 1.00 | 1.00       | 1.00 | 1.00 | 1.00       | 1.00 | 1.00 |
| PHF Adj:  | 1.00        | 1.00 | 1.00 | 1.00        | 1.00 | 1.00 | 1.00       | 1.00 | 1.00 | 1.00       | 1.00 | 1.00 |
| PHF Volume:   | 139         | 1088 | 96   | 93          | 265  | 160  | 296        | 451  | 128  | 9          | 913  | 485  |
| Reduct Vol:   | 0           | 0    | 0    | 0           | 0    | 0    | 0          | 0    | 0    | 0          | 0    | 0    |
| Reduced Vol:  | 139         | 1088 | 96   | 93          | 265  | 160  | 296        | 451  | 128  | 9          | 913  | 485  |
| PCE Adj:  | 1.00        | 1.00 | 1.00 | 1.00        | 1.00 | 1.00 | 1.00       | 1.00 | 1.00 | 1.00       | 1.00 | 1.00 |
| MLF Adj:  | 1.00        | 1.00 | 1.00 | 1.00        | 1.00 | 1.00 | 1.00       | 1.00 | 1.00 | 1.00       | 1.00 | 1.00 |
| FinalVolume:  | 139         | 1088 | 96   | 93          | 265  | 160  | 296        | 451  | 128  | 9          | 913  | 485  |
| ----- ----- ----- ----- ----- ----- ----- ----- ----- ----- ----- -----       |             |      |      |             |      |      |            |      |      |            |      |      |
| Saturation Flow Module:   |             |      |      |             |      |      |            |      |      |            |      |      |
| Sat/Lane:   | 1900        | 1900 | 1900 | 1900        | 1900 | 1900 | 1900       | 1900 | 1900 | 1900       | 1900 | 1900 |
| Adjustment:   | 0.92        | 1.00 | 0.92 | 0.92        | 0.99 | 0.95 | 0.92       | 1.00 | 0.92 | 0.92       | 1.00 | 0.92 |
| Lanes:  | 1.00        | 2.00 | 1.00 | 1.00        | 1.23 | 0.77 | 1.00       | 3.00 | 1.00 | 1.00       | 3.00 | 1.00 |
| Final Sat.:   | 1750        | 3800 | 1750 | 1750        | 2306 | 1392 | 1750       | 5700 | 1750 | 1750       | 5700 | 1750 |
| ----- ----- ----- ----- ----- ----- ----- ----- ----- ----- ----- -----       |             |      |      |             |      |      |            |      |      |            |      |      |
| Capacity Analysis Module:   |             |      |      |             |      |      |            |      |      |            |      |      |
| Vol/Sat:  | 0.08        | 0.29 | 0.05 | 0.05        | 0.11 | 0.11 | 0.17       | 0.08 | 0.07 | 0.01       | 0.16 | 0.28 |
| Crit Moves:   | ****        | **** | **** | ****        | **** | **** | ****       | **** | **** | ****       | **** | **** |
| Green Time:   | 22.3        | 46.1 | 71.7 | 8.6         | 32.3 | 32.3 | 27.2       | 37.6 | 60.0 | 25.6       | 36.0 | 44.5 |
| Volume/Cap:   | 0.46        | 0.81 | 0.10 | 0.81        | 0.46 | 0.46 | 0.81       | 0.27 | 0.16 | 0.03       | 0.58 | 0.81 |
| Delay/Veh:  | 49.5        | 41.6 | 13.9 | 92.7        | 41.8 | 41.8 | 61.3       | 35.7 | 20.4 | 42.2       | 41.0 | 47.0 |
| User DelAdj:  | 1.00        | 1.00 | 1.00 | 1.00        | 1.00 | 1.00 | 1.00       | 1.00 | 1.00 | 1.00       | 1.00 | 1.00 |
| AdjDel/Veh:   | 49.5        | 41.6 | 13.9 | 92.7        | 41.8 | 41.8 | 61.3       | 35.7 | 20.4 | 42.2       | 41.0 | 47.0 |
| LOS by Move:  | D           | D    | B    | F           | D    | D    | E          | D    | C    | D          | D    | D    |
| HCM2k95thQ:   | 10          | 34   | 4    | 9           | 14   | 14   | 22         | 9    | 6    | 1          | 20   | 35   |

Note: Queue reported is the number of cars per lane.

BART

Level Of Service Computation Report  
 2000 HCM Operations (Future Volume Alternative)  
 PM - Background Conditions

Intersection #1202: LAFAYETTE/EL CAMINO REAL [Study Int 46]

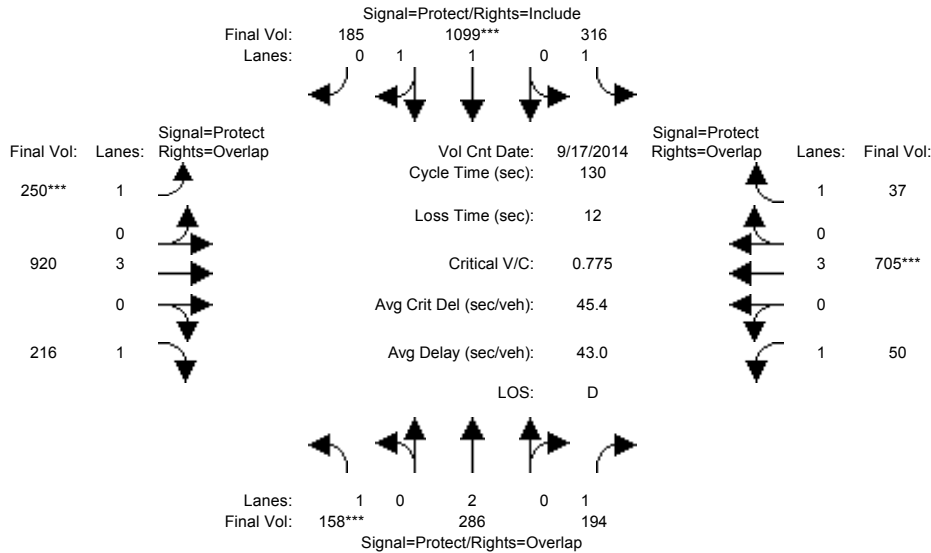

| Approach:                                    | North Bound |      |      | South Bound |      |      | East Bound |      |      | West Bound |      |      |
|--|-------------|------|------|-------------|------|------|------------|------|------|------------|------|------|
| Movement:                                    | L           | T    | R    | L           | T    | R    | L          | T    | R    | L          | T    | R    |
| Min. Green:                                  | 7           | 10   | 10   | 7           | 10   | 10   | 7          | 10   | 10   | 7          | 10   | 10   |
| Y+R:   | 4.0         | 4.0  | 4.0  | 4.0         | 4.0  | 4.0  | 4.0        | 4.0  | 4.0  | 4.0        | 4.0  | 4.0  |
| Volume Module: >> Count Date: 17 Sep 2014 << |             |      |      |             |      |      |            |      |      |            |      |      |
| Base Vol:                                    | 158         | 286  | 194  | 316         | 1099 | 185  | 250        | 920  | 216  | 50         | 705  | 37   |
| Growth Adj:                                  | 1.00        | 1.00 | 1.00 | 1.00        | 1.00 | 1.00 | 1.00       | 1.00 | 1.00 | 1.00       | 1.00 | 1.00 |
| Initial Bse:                                 | 158         | 286  | 194  | 316         | 1099 | 185  | 250        | 920  | 216  | 50         | 705  | 37   |
| Added Vol:                                   | 0           | 0    | 0    | 0           | 0    | 0    | 0          | 0    | 0    | 0          | 0    | 0    |
| PasserByVol:                                 | 0           | 0    | 0    | 0           | 0    | 0    | 0          | 0    | 0    | 0          | 0    | 0    |
| Initial Fut:                                 | 158         | 286  | 194  | 316         | 1099 | 185  | 250        | 920  | 216  | 50         | 705  | 37   |
| User Adj:                                    | 1.00        | 1.00 | 1.00 | 1.00        | 1.00 | 1.00 | 1.00       | 1.00 | 1.00 | 1.00       | 1.00 | 1.00 |
| PHF Adj:                                     | 1.00        | 1.00 | 1.00 | 1.00        | 1.00 | 1.00 | 1.00       | 1.00 | 1.00 | 1.00       | 1.00 | 1.00 |
| PHF Volume:                                  | 158         | 286  | 194  | 316         | 1099 | 185  | 250        | 920  | 216  | 50         | 705  | 37   |
| Reduct Vol:                                  | 0           | 0    | 0    | 0           | 0    | 0    | 0          | 0    | 0    | 0          | 0    | 0    |
| Reduced Vol:                                 | 158         | 286  | 194  | 316         | 1099 | 185  | 250        | 920  | 216  | 50         | 705  | 37   |
| PCE Adj:                                     | 1.00        | 1.00 | 1.00 | 1.00        | 1.00 | 1.00 | 1.00       | 1.00 | 1.00 | 1.00       | 1.00 | 1.00 |
| MLF Adj:                                     | 1.00        | 1.00 | 1.00 | 1.00        | 1.00 | 1.00 | 1.00       | 1.00 | 1.00 | 1.00       | 1.00 | 1.00 |
| Final Volume:                                | 158         | 286  | 194  | 316         | 1099 | 185  | 250        | 920  | 216  | 50         | 705  | 37   |
| Saturation Flow Module:                      |             |      |      |             |      |      |            |      |      |            |      |      |
| Sat/Lane:                                    | 1900        | 1900 | 1900 | 1900        | 1900 | 1900 | 1900       | 1900 | 1900 | 1900       | 1900 | 1900 |
| Adjustment:                                  | 0.92        | 1.00 | 0.92 | 0.92        | 0.98 | 0.95 | 0.92       | 1.00 | 0.92 | 0.92       | 1.00 | 0.92 |
| Lanes:                                       | 1.00        | 2.00 | 1.00 | 1.00        | 1.70 | 0.30 | 1.00       | 3.00 | 1.00 | 1.00       | 3.00 | 1.00 |
| Final Sat.:                                  | 1750        | 3800 | 1750 | 1750        | 3167 | 533  | 1750       | 5700 | 1750 | 1750       | 5700 | 1750 |
| Capacity Analysis Module:                    |             |      |      |             |      |      |            |      |      |            |      |      |
| Vol/Sat:                                     | 0.09        | 0.08 | 0.11 | 0.18        | 0.35 | 0.35 | 0.14       | 0.16 | 0.12 | 0.03       | 0.12 | 0.02 |
| Crit Moves:                                  | ****        |      |      | ****        |      |      | ****       |      |      | ****       |      |      |
| Green Time:                                  | 15.1        | 23.0 | 34.1 | 50.4        | 58.2 | 58.2 | 23.9       | 33.5 | 48.6 | 11.2       | 20.7 | 71.1 |
| Volume/Cap:                                  | 0.78        | 0.43 | 0.42 | 0.47        | 0.78 | 0.78 | 0.78       | 0.63 | 0.33 | 0.33       | 0.78 | 0.04 |
| Delay/Veh:                                   | 72.7        | 48.1 | 40.4 | 30.3        | 32.8 | 32.8 | 61.7       | 43.6 | 29.3 | 57.2       | 56.6 | 13.6 |
| User DelAdj:                                 | 1.00        | 1.00 | 1.00 | 1.00        | 1.00 | 1.00 | 1.00       | 1.00 | 1.00 | 1.00       | 1.00 | 1.00 |
| AdjDel/Veh:                                  | 72.7        | 48.1 | 40.4 | 30.3        | 32.8 | 32.8 | 61.7       | 43.6 | 29.3 | 57.2       | 56.6 | 13.6 |
| LOS by Move:                                 | E           | D    | D    | C           | C    | C    | E          | D    | C    | E          | E    | B    |
| HCM2k95thQ:                                  | 13          | 10   | 13   | 18          | 38   | 38   | 19         | 19   | 12   | 5          | 20   | 1    |

Note: Queue reported is the number of cars per lane.

BART

Level Of Service Computation Report  
 2000 HCM Operations (Future Volume Alternative)  
 AM - Background Conditions

Intersection #1203: ECR/Lincoln 1203 [Study Int 43]

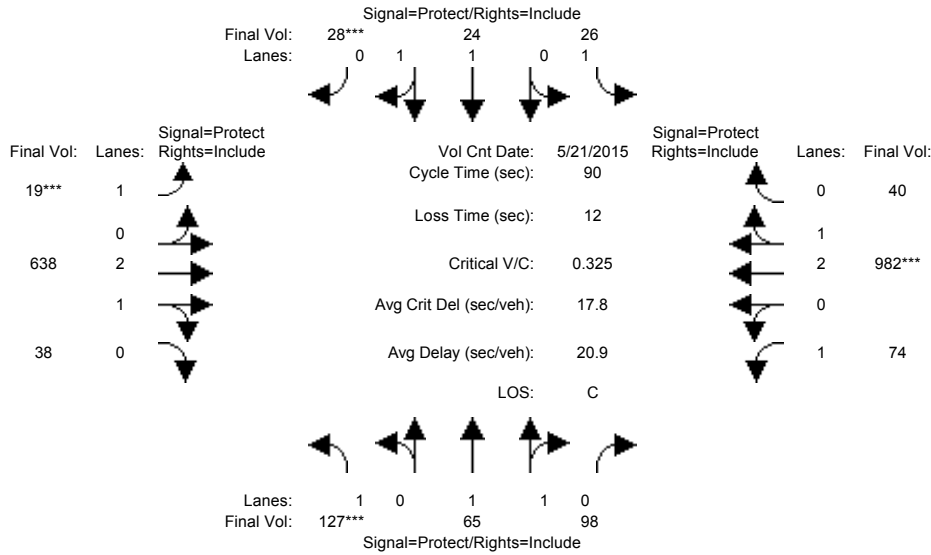

| Approach:   | North Bound |      |      | South Bound |      |      | East Bound |      |      | West Bound |      |      |
|---|-------------|------|------|-------------|------|------|------------|------|------|------------|------|------|
| Movement:   | L           | T    | R    | L           | T    | R    | L          | T    | R    | L          | T    | R    |
| Min. Green:   | 7           | 10   | 10   | 7           | 10   | 10   | 7          | 10   | 10   | 7          | 10   | 10   |
| Y+R:  | 4.0         | 4.0  | 4.0  | 4.0         | 4.0  | 4.0  | 4.0        | 4.0  | 4.0  | 4.0        | 4.0  | 4.0  |
| Volume Module: >> Count Date: 21 May 2015 << 5:00 - 6:00 PM |             |      |      |             |      |      |            |      |      |            |      |      |
| Base Vol:   | 127         | 65   | 98   | 26          | 24   | 28   | 19         | 638  | 38   | 74         | 982  | 40   |
| Growth Adj:   | 1.00        | 1.00 | 1.00 | 1.00        | 1.00 | 1.00 | 1.00       | 1.00 | 1.00 | 1.00       | 1.00 | 1.00 |
| Initial Bse:  | 127         | 65   | 98   | 26          | 24   | 28   | 19         | 638  | 38   | 74         | 982  | 40   |
| Added Vol:  | 0           | 0    | 0    | 0           | 0    | 0    | 0          | 0    | 0    | 0          | 0    | 0    |
| PasserByVol:  | 0           | 0    | 0    | 0           | 0    | 0    | 0          | 0    | 0    | 0          | 0    | 0    |
| Initial Fut:  | 127         | 65   | 98   | 26          | 24   | 28   | 19         | 638  | 38   | 74         | 982  | 40   |
| User Adj:   | 1.00        | 1.00 | 1.00 | 1.00        | 1.00 | 1.00 | 1.00       | 1.00 | 1.00 | 1.00       | 1.00 | 1.00 |
| PHF Adj:  | 1.00        | 1.00 | 1.00 | 1.00        | 1.00 | 1.00 | 1.00       | 1.00 | 1.00 | 1.00       | 1.00 | 1.00 |
| PHF Volume:   | 127         | 65   | 98   | 26          | 24   | 28   | 19         | 638  | 38   | 74         | 982  | 40   |
| Reduct Vol:   | 0           | 0    | 0    | 0           | 0    | 0    | 0          | 0    | 0    | 0          | 0    | 0    |
| Reduced Vol:  | 127         | 65   | 98   | 26          | 24   | 28   | 19         | 638  | 38   | 74         | 982  | 40   |
| PCE Adj:  | 1.00        | 1.00 | 1.00 | 1.00        | 1.00 | 1.00 | 1.00       | 1.00 | 1.00 | 1.00       | 1.00 | 1.00 |
| MLF Adj:  | 1.00        | 1.00 | 1.00 | 1.00        | 1.00 | 1.00 | 1.00       | 1.00 | 1.00 | 1.00       | 1.00 | 1.00 |
| Final Volume:   | 127         | 65   | 98   | 26          | 24   | 28   | 19         | 638  | 38   | 74         | 982  | 40   |
| Saturation Flow Module:                                     |             |      |      |             |      |      |            |      |      |            |      |      |
| Sat/Lane:   | 1900        | 1900 | 1900 | 1900        | 1900 | 1900 | 1900       | 1900 | 1900 | 1900       | 1900 | 1900 |
| Adjustment:   | 0.92        | 1.00 | 0.92 | 0.92        | 1.00 | 0.92 | 0.92       | 0.98 | 0.95 | 0.92       | 0.98 | 0.95 |
| Lanes:  | 1.00        | 1.00 | 1.00 | 1.00        | 1.00 | 1.00 | 1.00       | 2.83 | 0.17 | 1.00       | 2.88 | 0.12 |
| Final Sat.:   | 1750        | 1900 | 1750 | 1750        | 1900 | 1750 | 1750       | 5285 | 315  | 1750       | 5381 | 219  |
| Capacity Analysis Module:                                   |             |      |      |             |      |      |            |      |      |            |      |      |
| Vol/Sat:  | 0.07        | 0.03 | 0.06 | 0.01        | 0.01 | 0.02 | 0.01       | 0.12 | 0.12 | 0.04       | 0.18 | 0.18 |
| Crit Moves:   | ****        |      |      | ****        | **** |      | ****       |      |      | ****       |      |      |
| Green Time:   | 17.4        | 16.1 | 16.1 | 11.3        | 10.0 | 10.0 | 7.0        | 30.8 | 30.8 | 19.8       | 43.6 | 43.6 |
| Volume/Cap:   | 0.38        | 0.19 | 0.31 | 0.12        | 0.11 | 0.14 | 0.14       | 0.35 | 0.35 | 0.19       | 0.38 | 0.38 |
| Delay/Veh:  | 32.3        | 31.5 | 32.5 | 35.2        | 36.1 | 36.3 | 39.2       | 22.3 | 22.3 | 28.8       | 14.7 | 14.7 |
| User DelAdj:  | 1.00        | 1.00 | 1.00 | 1.00        | 1.00 | 1.00 | 1.00       | 1.00 | 1.00 | 1.00       | 1.00 | 1.00 |
| AdjDel/Veh:   | 32.3        | 31.5 | 32.5 | 35.2        | 36.1 | 36.3 | 39.2       | 22.3 | 22.3 | 28.8       | 14.7 | 14.7 |
| LOS by Move:  | C           | C    | C    | D           | D    | D    | D          | C    | C    | C          | B    | B    |
| HCM2k95thQ:   | 6           | 3    | 5    | 2           | 1    | 2    | 1          | 9    | 9    | 4          | 11   | 11   |

Note: Queue reported is the number of cars per lane.

BART

Level Of Service Computation Report  
2000 HCM Operations (Future Volume Alternative)  
PM - Background Conditions

Intersection #1203: ECR/Lincoln 1203 [Study Int 43]

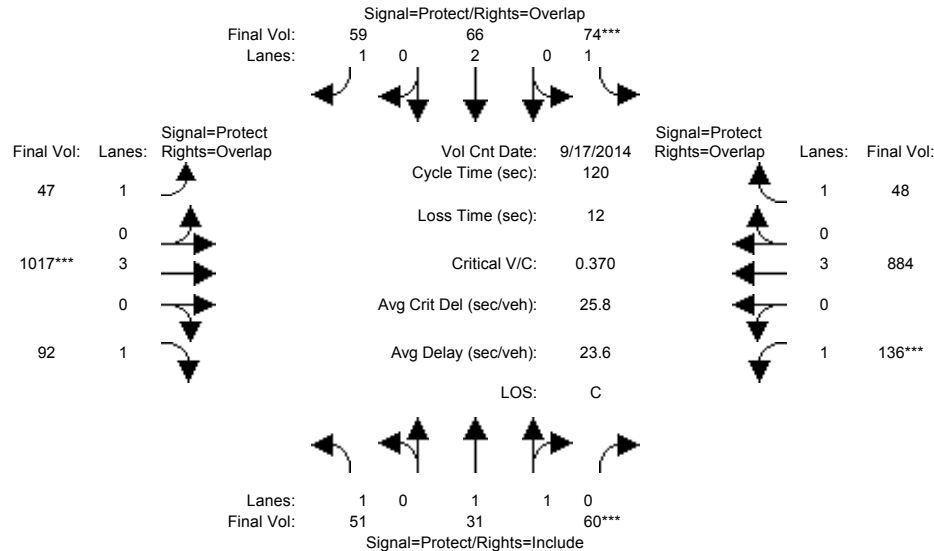

| Approach:  | North Bound |      |      | South Bound |      |      | East Bound |      |      | West Bound |      |      |
|--|-------------|------|------|-------------|------|------|------------|------|------|------------|------|------|
| Movement:  | L           | T    | R    | L           | T    | R    | L          | T    | R    | L          | T    | R    |
| Min. Green:  | 7           | 10   | 10   | 7           | 10   | 10   | 7          | 10   | 10   | 7          | 10   | 10   |
| Y+R:   | 4.0         | 4.0  | 4.0  | 4.0         | 4.0  | 4.0  | 4.0        | 4.0  | 4.0  | 4.0        | 4.0  | 4.0  |
| Volume Module: >> Count Date: 17 Sep 2014 << 4:45-5:45PM |             |      |      |             |      |      |            |      |      |            |      |      |
| Base Vol:  | 51          | 31   | 60   | 74          | 66   | 59   | 47         | 1017 | 92   | 136        | 884  | 48   |
| Growth Adj:  | 1.00        | 1.00 | 1.00 | 1.00        | 1.00 | 1.00 | 1.00       | 1.00 | 1.00 | 1.00       | 1.00 | 1.00 |
| Initial Bse:   | 51          | 31   | 60   | 74          | 66   | 59   | 47         | 1017 | 92   | 136        | 884  | 48   |
| Added Vol:   | 0           | 0    | 0    | 0           | 0    | 0    | 0          | 0    | 0    | 0          | 0    | 0    |
| PasserByVol:   | 0           | 0    | 0    | 0           | 0    | 0    | 0          | 0    | 0    | 0          | 0    | 0    |
| Initial Fut:   | 51          | 31   | 60   | 74          | 66   | 59   | 47         | 1017 | 92   | 136        | 884  | 48   |
| User Adj:  | 1.00        | 1.00 | 1.00 | 1.00        | 1.00 | 1.00 | 1.00       | 1.00 | 1.00 | 1.00       | 1.00 | 1.00 |
| PHF Adj:   | 1.00        | 1.00 | 1.00 | 1.00        | 1.00 | 1.00 | 1.00       | 1.00 | 1.00 | 1.00       | 1.00 | 1.00 |
| PHF Volume:  | 51          | 31   | 60   | 74          | 66   | 59   | 47         | 1017 | 92   | 136        | 884  | 48   |
| Reduct Vol:  | 0           | 0    | 0    | 0           | 0    | 0    | 0          | 0    | 0    | 0          | 0    | 0    |
| Reduced Vol:   | 51          | 31   | 60   | 74          | 66   | 59   | 47         | 1017 | 92   | 136        | 884  | 48   |
| PCE Adj:   | 1.00        | 1.00 | 1.00 | 1.00        | 1.00 | 1.00 | 1.00       | 1.00 | 1.00 | 1.00       | 1.00 | 1.00 |
| MLF Adj:   | 1.00        | 1.00 | 1.00 | 1.00        | 1.00 | 1.00 | 1.00       | 1.00 | 1.00 | 1.00       | 1.00 | 1.00 |
| Final Volume:  | 51          | 31   | 60   | 74          | 66   | 59   | 47         | 1017 | 92   | 136        | 884  | 48   |
| Saturation Flow Module:                                  |             |      |      |             |      |      |            |      |      |            |      |      |
| Sat/Lane:  | 1900        | 1900 | 1900 | 1900        | 1900 | 1900 | 1900       | 1900 | 1900 | 1900       | 1900 | 1900 |
| Adjustment:  | 0.92        | 1.00 | 0.92 | 0.92        | 1.00 | 0.92 | 0.92       | 1.00 | 0.92 | 0.92       | 1.00 | 0.92 |
| Lanes:   | 1.00        | 1.00 | 1.00 | 1.00        | 2.00 | 1.00 | 1.00       | 3.00 | 1.00 | 1.00       | 3.00 | 1.00 |
| Final Sat.:  | 1750        | 1900 | 1750 | 1750        | 3800 | 1750 | 1750       | 5700 | 1750 | 1750       | 5700 | 1750 |
| Capacity Analysis Module:                                |             |      |      |             |      |      |            |      |      |            |      |      |
| Vol/Sat:   | 0.03        | 0.02 | 0.03 | 0.04        | 0.02 | 0.03 | 0.03       | 0.18 | 0.05 | 0.08       | 0.16 | 0.03 |
| Crit Moves:  | ****        | **** | **** | ****        | **** | **** | ****       | **** | **** | ****       | **** | **** |
| Green Time:  | 10.2        | 11.1 | 11.1 | 13.7        | 14.6 | 37.3 | 22.7       | 57.9 | 68.2 | 25.2       | 60.4 | 74.1 |
| Volume/Cap:  | 0.34        | 0.18 | 0.37 | 0.37        | 0.14 | 0.11 | 0.14       | 0.37 | 0.09 | 0.37       | 0.31 | 0.04 |
| Delay/Veh:   | 53.1        | 50.4 | 52.1 | 50.3        | 47.2 | 29.5 | 40.7       | 19.6 | 11.9 | 41.2       | 17.6 | 9.0  |
| User DelAdj:   | 1.00        | 1.00 | 1.00 | 1.00        | 1.00 | 1.00 | 1.00       | 1.00 | 1.00 | 1.00       | 1.00 | 1.00 |
| AdjDel/Veh:  | 53.1        | 50.4 | 52.1 | 50.3        | 47.2 | 29.5 | 40.7       | 19.6 | 11.9 | 41.2       | 17.6 | 9.0  |
| LOS by Move:   | D           | D    | D    | D           | D    | C    | D          | B    | B    | D          | B    | A    |
| HCM2k95thQ:  | 4           | 2    | 4    | 6           | 2    | 3    | 3          | 14   | 3    | 9          | 12   | 2    |

Note: Queue reported is the number of cars per lane.

BART

Level Of Service Computation Report  
 2000 HCM Operations (Future Volume Alternative)  
 AM - Background Conditions

Intersection #1204: MONROE/EL CAMINO REAL [Study Int 44]

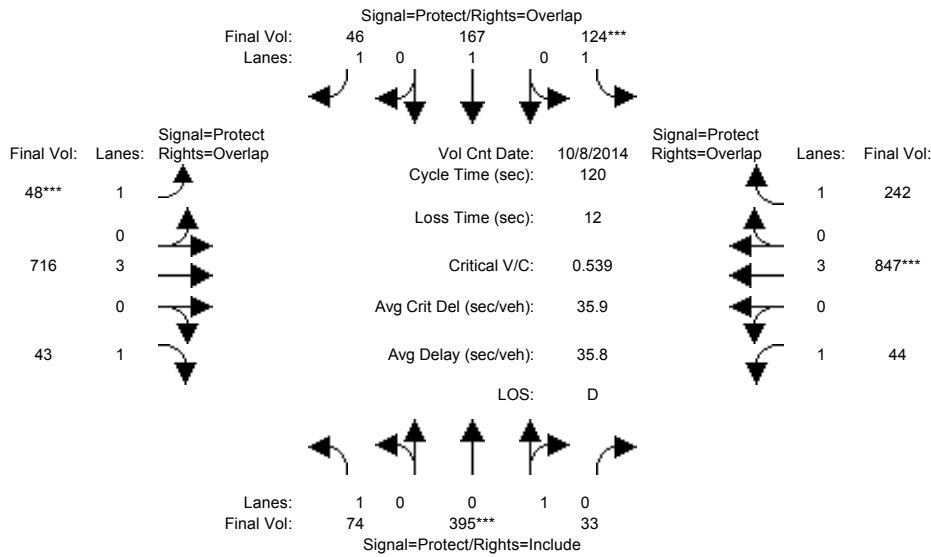

| Approach:                                   | North Bound |      |      | South Bound |      |      | East Bound |      |      | West Bound |      |      |
|---|-------------|------|------|-------------|------|------|------------|------|------|------------|------|------|
| Movement:                                   | L           | T    | R    | L           | T    | R    | L          | T    | R    | L          | T    | R    |
| Min. Green:                                 | 7           | 10   | 10   | 7           | 10   | 10   | 7          | 10   | 10   | 7          | 10   | 10   |
| Y+R:  | 4.0         | 4.0  | 4.0  | 4.0         | 4.0  | 4.0  | 4.0        | 4.0  | 4.0  | 4.0        | 4.0  | 4.0  |
| Volume Module: >> Count Date: 8 Oct 2014 << |             |      |      |             |      |      |            |      |      |            |      |      |
| Base Vol:                                   | 74          | 395  | 33   | 124         | 167  | 46   | 48         | 716  | 43   | 44         | 847  | 242  |
| Growth Adj:                                 | 1.00        | 1.00 | 1.00 | 1.00        | 1.00 | 1.00 | 1.00       | 1.00 | 1.00 | 1.00       | 1.00 | 1.00 |
| Initial Bse:                                | 74          | 395  | 33   | 124         | 167  | 46   | 48         | 716  | 43   | 44         | 847  | 242  |
| Added Vol:                                  | 0           | 0    | 0    | 0           | 0    | 0    | 0          | 0    | 0    | 0          | 0    | 0    |
| PasserByVol:                                | 0           | 0    | 0    | 0           | 0    | 0    | 0          | 0    | 0    | 0          | 0    | 0    |
| Initial Fut:                                | 74          | 395  | 33   | 124         | 167  | 46   | 48         | 716  | 43   | 44         | 847  | 242  |
| User Adj:                                   | 1.00        | 1.00 | 1.00 | 1.00        | 1.00 | 1.00 | 1.00       | 1.00 | 1.00 | 1.00       | 1.00 | 1.00 |
| PHF Adj:                                    | 1.00        | 1.00 | 1.00 | 1.00        | 1.00 | 1.00 | 1.00       | 1.00 | 1.00 | 1.00       | 1.00 | 1.00 |
| PHF Volume:                                 | 74          | 395  | 33   | 124         | 167  | 46   | 48         | 716  | 43   | 44         | 847  | 242  |
| Reduct Vol:                                 | 0           | 0    | 0    | 0           | 0    | 0    | 0          | 0    | 0    | 0          | 0    | 0    |
| Reduced Vol:                                | 74          | 395  | 33   | 124         | 167  | 46   | 48         | 716  | 43   | 44         | 847  | 242  |
| PCE Adj:                                    | 1.00        | 1.00 | 1.00 | 1.00        | 1.00 | 1.00 | 1.00       | 1.00 | 1.00 | 1.00       | 1.00 | 1.00 |
| MLF Adj:                                    | 1.00        | 1.00 | 1.00 | 1.00        | 1.00 | 1.00 | 1.00       | 1.00 | 1.00 | 1.00       | 1.00 | 1.00 |
| Final Volume:                               | 74          | 395  | 33   | 124         | 167  | 46   | 48         | 716  | 43   | 44         | 847  | 242  |
| Saturation Flow Module:                     |             |      |      |             |      |      |            |      |      |            |      |      |
| Sat/Lane:                                   | 1900        | 1900 | 1900 | 1900        | 1900 | 1900 | 1900       | 1900 | 1900 | 1900       | 1900 | 1900 |
| Adjustment:                                 | 0.92        | 0.95 | 0.95 | 0.92        | 1.00 | 0.92 | 0.92       | 1.00 | 0.92 | 0.92       | 1.00 | 0.92 |
| Lanes:                                      | 1.00        | 0.92 | 0.08 | 1.00        | 1.00 | 1.00 | 1.00       | 3.00 | 1.00 | 1.00       | 3.00 | 1.00 |
| Final Sat.:                                 | 1750        | 1661 | 139  | 1750        | 1900 | 1750 | 1750       | 5700 | 1750 | 1750       | 5700 | 1750 |
| Capacity Analysis Module:                   |             |      |      |             |      |      |            |      |      |            |      |      |
| Vol/Sat:                                    | 0.04        | 0.24 | 0.24 | 0.07        | 0.09 | 0.03 | 0.03       | 0.13 | 0.02 | 0.03       | 0.15 | 0.14 |
| Crit Moves:                                 | ****        | **** | **** | ****        | **** | **** | ****       | **** | **** | ****       | **** | **** |
| Green Time:                                 | 27.2        | 52.5 | 52.5 | 15.7        | 41.0 | 48.0 | 7.0        | 27.2 | 54.4 | 12.6       | 32.8 | 48.5 |
| Volume/Cap:                                 | 0.19        | 0.54 | 0.54 | 0.54        | 0.26 | 0.07 | 0.47       | 0.55 | 0.05 | 0.24       | 0.54 | 0.34 |
| Delay/Veh:                                  | 37.7        | 25.7 | 25.7 | 51.5        | 28.7 | 22.2 | 58.1       | 41.6 | 18.4 | 49.9       | 37.6 | 25.0 |
| User DelAdj:                                | 1.00        | 1.00 | 1.00 | 1.00        | 1.00 | 1.00 | 1.00       | 1.00 | 1.00 | 1.00       | 1.00 | 1.00 |
| AdjDel/Veh:                                 | 37.7        | 25.7 | 25.7 | 51.5        | 28.7 | 22.2 | 58.1       | 41.6 | 18.4 | 49.9       | 37.6 | 25.0 |
| LOS by Move:                                | D           | C    | C    | D           | C    | C    | E          | D    | B    | D          | D    | C    |
| HCM2k95thQ:                                 | 5           | 22   | 22   | 9           | 8    | 2    | 4          | 14   | 2    | 3          | 16   | 12   |

Note: Queue reported is the number of cars per lane.

BART

Level Of Service Computation Report  
 2000 HCM Operations (Future Volume Alternative)  
 PM - Background Conditions

Intersection #1204: MONROE/EL CAMINO REAL [Study Int 44]

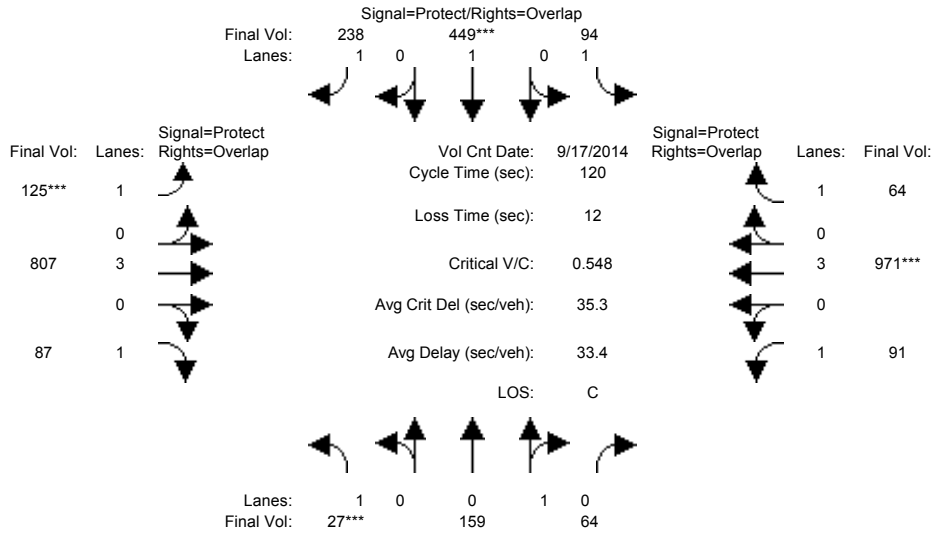

| Approach:                                    | North Bound |      |      | South Bound |      |      | East Bound |      |      | West Bound |      |      |
|--|-------------|------|------|-------------|------|------|------------|------|------|------------|------|------|
| Movement:                                    | L           | T    | R    | L           | T    | R    | L          | T    | R    | L          | T    | R    |
| Min. Green:                                  | 7           | 10   | 10   | 7           | 10   | 10   | 7          | 10   | 10   | 7          | 10   | 10   |
| Y+R:   | 4.0         | 4.0  | 4.0  | 4.0         | 4.0  | 4.0  | 4.0        | 4.0  | 4.0  | 4.0        | 4.0  | 4.0  |
| Volume Module: >> Count Date: 17 Sep 2014 << |             |      |      |             |      |      |            |      |      |            |      |      |
| Base Vol:                                    | 27          | 159  | 64   | 94          | 449  | 238  | 125        | 807  | 87   | 91         | 971  | 64   |
| Growth Adj:                                  | 1.00        | 1.00 | 1.00 | 1.00        | 1.00 | 1.00 | 1.00       | 1.00 | 1.00 | 1.00       | 1.00 | 1.00 |
| Initial Bse:                                 | 27          | 159  | 64   | 94          | 449  | 238  | 125        | 807  | 87   | 91         | 971  | 64   |
| Added Vol:                                   | 0           | 0    | 0    | 0           | 0    | 0    | 0          | 0    | 0    | 0          | 0    | 0    |
| PasserByVol:                                 | 0           | 0    | 0    | 0           | 0    | 0    | 0          | 0    | 0    | 0          | 0    | 0    |
| Initial Fut:                                 | 27          | 159  | 64   | 94          | 449  | 238  | 125        | 807  | 87   | 91         | 971  | 64   |
| User Adj:                                    | 1.00        | 1.00 | 1.00 | 1.00        | 1.00 | 1.00 | 1.00       | 1.00 | 1.00 | 1.00       | 1.00 | 1.00 |
| PHF Adj:                                     | 1.00        | 1.00 | 1.00 | 1.00        | 1.00 | 1.00 | 1.00       | 1.00 | 1.00 | 1.00       | 1.00 | 1.00 |
| PHF Volume:                                  | 27          | 159  | 64   | 94          | 449  | 238  | 125        | 807  | 87   | 91         | 971  | 64   |
| Reduct Vol:                                  | 0           | 0    | 0    | 0           | 0    | 0    | 0          | 0    | 0    | 0          | 0    | 0    |
| Reduced Vol:                                 | 27          | 159  | 64   | 94          | 449  | 238  | 125        | 807  | 87   | 91         | 971  | 64   |
| PCE Adj:                                     | 1.00        | 1.00 | 1.00 | 1.00        | 1.00 | 1.00 | 1.00       | 1.00 | 1.00 | 1.00       | 1.00 | 1.00 |
| MLF Adj:                                     | 1.00        | 1.00 | 1.00 | 1.00        | 1.00 | 1.00 | 1.00       | 1.00 | 1.00 | 1.00       | 1.00 | 1.00 |
| Final Volume:                                | 27          | 159  | 64   | 94          | 449  | 238  | 125        | 807  | 87   | 91         | 971  | 64   |
| Saturation Flow Module:                      |             |      |      |             |      |      |            |      |      |            |      |      |
| Sat/Lane:                                    | 1900        | 1900 | 1900 | 1900        | 1900 | 1900 | 1900       | 1900 | 1900 | 1900       | 1900 | 1900 |
| Adjustment:                                  | 0.92        | 0.95 | 0.95 | 0.92        | 1.00 | 0.92 | 0.92       | 1.00 | 0.92 | 0.92       | 1.00 | 0.92 |
| Lanes:                                       | 1.00        | 0.71 | 0.29 | 1.00        | 1.00 | 1.00 | 1.00       | 3.00 | 1.00 | 1.00       | 3.00 | 1.00 |
| Final Sat.:                                  | 1750        | 1283 | 517  | 1750        | 1900 | 1750 | 1750       | 5700 | 1750 | 1750       | 5700 | 1750 |
| Capacity Analysis Module:                    |             |      |      |             |      |      |            |      |      |            |      |      |
| Vol/Sat:                                     | 0.02        | 0.12 | 0.12 | 0.05        | 0.24 | 0.14 | 0.07       | 0.14 | 0.05 | 0.05       | 0.17 | 0.04 |
| Crit Moves:                                  | ****        |      |      | ****        |      |      | ****       |      |      | ****       |      |      |
| Green Time:                                  | 7.0         | 38.7 | 38.7 | 18.2        | 49.9 | 65.0 | 15.1       | 36.2 | 43.2 | 14.9       | 36.0 | 54.2 |
| Volume/Cap:                                  | 0.26        | 0.38 | 0.38 | 0.35        | 0.57 | 0.25 | 0.57       | 0.47 | 0.14 | 0.42       | 0.57 | 0.08 |
| Delay/Veh:                                   | 55.4        | 31.9 | 31.9 | 46.4        | 27.8 | 14.7 | 52.9       | 34.3 | 26.0 | 49.9       | 35.9 | 18.8 |
| User DelAdj:                                 | 1.00        | 1.00 | 1.00 | 1.00        | 1.00 | 1.00 | 1.00       | 1.00 | 1.00 | 1.00       | 1.00 | 1.00 |
| AdjDel/Veh:                                  | 55.4        | 31.9 | 31.9 | 46.4        | 27.8 | 14.7 | 52.9       | 34.3 | 26.0 | 49.9       | 35.9 | 18.8 |
| LOS by Move:                                 | E           | C    | C    | D           | C    | B    | D          | C    | C    | D          | D    | B    |
| HCM2k95thQ:                                  | 3           | 13   | 13   | 7           | 22   | 9    | 9          | 15   | 5    | 6          | 18   | 3    |

Note: Queue reported is the number of cars per lane.

BART

Level Of Service Computation Report  
 2000 HCM Operations (Future Volume Alternative)  
 AM - Background Conditions

Intersection #1205: SCOTT/EL CAMINO REAL [Study Int 42]

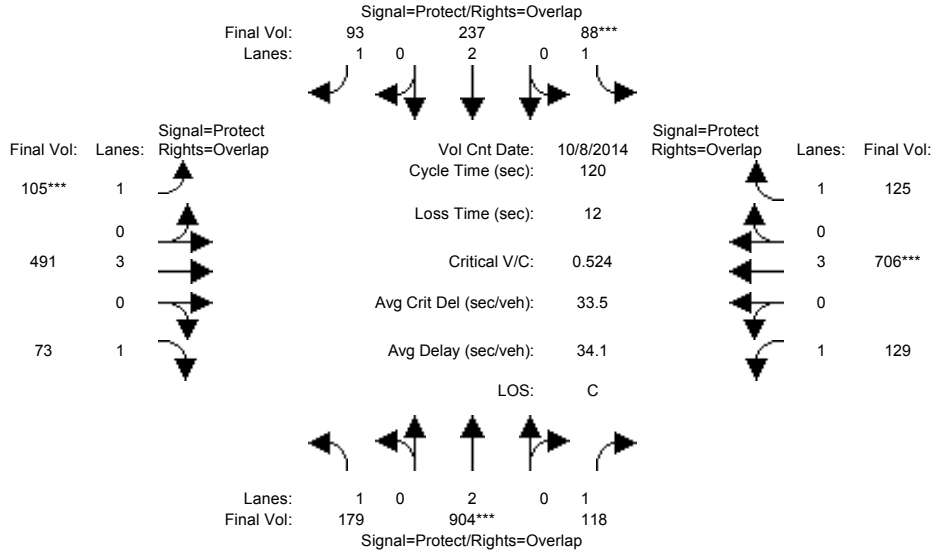

| Approach:                                   | North Bound |      |      | South Bound |      |      | East Bound |      |      | West Bound |      |      |
|---|-------------|------|------|-------------|------|------|------------|------|------|------------|------|------|
| Movement:                                   | L           | T    | R    | L           | T    | R    | L          | T    | R    | L          | T    | R    |
| Min. Green:                                 | 7           | 10   | 10   | 7           | 10   | 10   | 7          | 10   | 10   | 7          | 10   | 10   |
| Y+R:  | 4.0         | 4.0  | 4.0  | 4.0         | 4.0  | 4.0  | 4.0        | 4.0  | 4.0  | 4.0        | 4.0  | 4.0  |
| Volume Module: >> Count Date: 8 Oct 2014 << |             |      |      |             |      |      |            |      |      |            |      |      |
| Base Vol:                                   | 179         | 904  | 118  | 88          | 237  | 93   | 105        | 491  | 73   | 129        | 706  | 125  |
| Growth Adj:                                 | 1.00        | 1.00 | 1.00 | 1.00        | 1.00 | 1.00 | 1.00       | 1.00 | 1.00 | 1.00       | 1.00 | 1.00 |
| Initial Bse:                                | 179         | 904  | 118  | 88          | 237  | 93   | 105        | 491  | 73   | 129        | 706  | 125  |
| Added Vol:                                  | 0           | 0    | 0    | 0           | 0    | 0    | 0          | 0    | 0    | 0          | 0    | 0    |
| PasserByVol:                                | 0           | 0    | 0    | 0           | 0    | 0    | 0          | 0    | 0    | 0          | 0    | 0    |
| Initial Fut:                                | 179         | 904  | 118  | 88          | 237  | 93   | 105        | 491  | 73   | 129        | 706  | 125  |
| User Adj:                                   | 1.00        | 1.00 | 1.00 | 1.00        | 1.00 | 1.00 | 1.00       | 1.00 | 1.00 | 1.00       | 1.00 | 1.00 |
| PHF Adj:                                    | 1.00        | 1.00 | 1.00 | 1.00        | 1.00 | 1.00 | 1.00       | 1.00 | 1.00 | 1.00       | 1.00 | 1.00 |
| PHF Volume:                                 | 179         | 904  | 118  | 88          | 237  | 93   | 105        | 491  | 73   | 129        | 706  | 125  |
| Reduct Vol:                                 | 0           | 0    | 0    | 0           | 0    | 0    | 0          | 0    | 0    | 0          | 0    | 0    |
| Reduced Vol:                                | 179         | 904  | 118  | 88          | 237  | 93   | 105        | 491  | 73   | 129        | 706  | 125  |
| PCE Adj:                                    | 1.00        | 1.00 | 1.00 | 1.00        | 1.00 | 1.00 | 1.00       | 1.00 | 1.00 | 1.00       | 1.00 | 1.00 |
| MLF Adj:                                    | 1.00        | 1.00 | 1.00 | 1.00        | 1.00 | 1.00 | 1.00       | 1.00 | 1.00 | 1.00       | 1.00 | 1.00 |
| Final Volume:                               | 179         | 904  | 118  | 88          | 237  | 93   | 105        | 491  | 73   | 129        | 706  | 125  |
| Saturation Flow Module:                     |             |      |      |             |      |      |            |      |      |            |      |      |
| Sat/Lane:                                   | 1900        | 1900 | 1900 | 1900        | 1900 | 1900 | 1900       | 1900 | 1900 | 1900       | 1900 | 1900 |
| Adjustment:                                 | 0.92        | 1.00 | 0.92 | 0.92        | 1.00 | 0.92 | 0.92       | 1.00 | 0.92 | 0.92       | 1.00 | 0.92 |
| Lanes:                                      | 1.00        | 2.00 | 1.00 | 1.00        | 2.00 | 1.00 | 1.00       | 3.00 | 1.00 | 1.00       | 3.00 | 1.00 |
| Final Sat.:                                 | 1750        | 3800 | 1750 | 1750        | 3800 | 1750 | 1750       | 5700 | 1750 | 1750       | 5700 | 1750 |
| Capacity Analysis Module:                   |             |      |      |             |      |      |            |      |      |            |      |      |
| Vol/Sat:                                    | 0.10        | 0.24 | 0.07 | 0.05        | 0.06 | 0.05 | 0.06       | 0.09 | 0.04 | 0.07       | 0.12 | 0.07 |
| Crit Moves:                                 | ****        | **** | **** | ****        | **** | **** | ****       | **** | **** | ****       | **** | **** |
| Green Time:                                 | 36.3        | 54.4 | 73.8 | 11.5        | 29.6 | 43.3 | 13.7       | 22.7 | 59.0 | 19.4       | 28.3 | 39.8 |
| Volume/Cap:                                 | 0.34        | 0.52 | 0.11 | 0.52        | 0.25 | 0.15 | 0.52       | 0.46 | 0.08 | 0.46       | 0.52 | 0.22 |
| Delay/Veh:                                  | 32.9        | 23.8 | 9.6  | 54.7        | 36.5 | 26.0 | 52.6       | 43.5 | 16.2 | 46.7       | 40.3 | 29.0 |
| User DelAdj:                                | 1.00        | 1.00 | 1.00 | 1.00        | 1.00 | 1.00 | 1.00       | 1.00 | 1.00 | 1.00       | 1.00 | 1.00 |
| AdjDel/Veh:                                 | 32.9        | 23.8 | 9.6  | 54.7        | 36.5 | 26.0 | 52.6       | 43.5 | 16.2 | 46.7       | 40.3 | 29.0 |
| LOS by Move:                                | C           | C    | A    | D           | D    | C    | D          | D    | B    | D          | D    | C    |
| HCM2k95thQ:                                 | 10          | 21   | 4    | 7           | 7    | 5    | 8          | 10   | 3    | 9          | 14   | 7    |

Note: Queue reported is the number of cars per lane.



BART

Level Of Service Computation Report  
2000 HCM Operations (Future Volume Alternative)  
PM - Background Conditions

Intersection #1205: SCOTT/EL CAMINO REAL [Study Int 42]

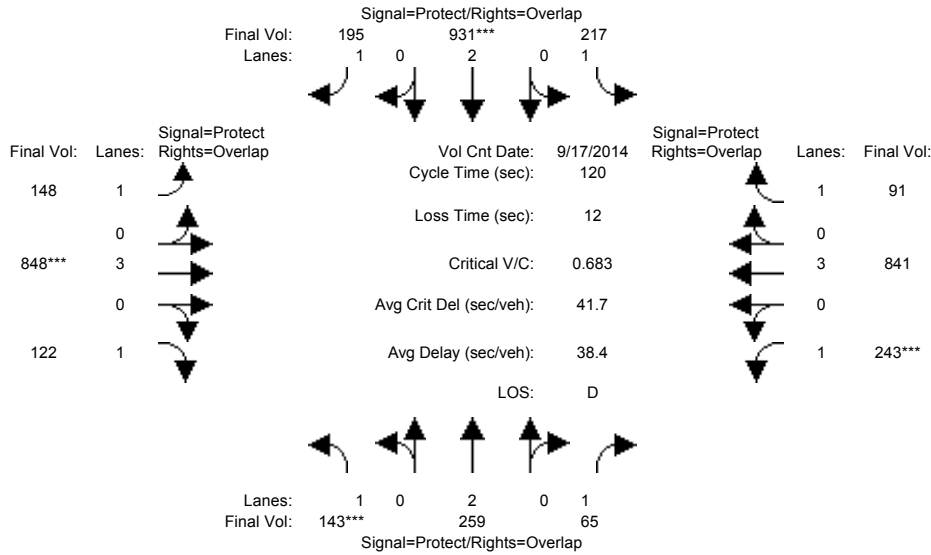

| Approach:                                    | North Bound |      |      | South Bound |      |      | East Bound |      |      | West Bound |      |      |
|--|-------------|------|------|-------------|------|------|------------|------|------|------------|------|------|
| Movement:                                    | L           | T    | R    | L           | T    | R    | L          | T    | R    | L          | T    | R    |
| Min. Green:                                  | 7           | 10   | 10   | 7           | 10   | 10   | 7          | 10   | 10   | 7          | 10   | 10   |
| Y+R:   | 4.0         | 4.0  | 4.0  | 4.0         | 4.0  | 4.0  | 4.0        | 4.0  | 4.0  | 4.0        | 4.0  | 4.0  |
| Volume Module: >> Count Date: 17 Sep 2014 << |             |      |      |             |      |      |            |      |      |            |      |      |
| Base Vol:                                    | 143         | 259  | 65   | 217         | 931  | 195  | 148        | 848  | 122  | 243        | 841  | 91   |
| Growth Adj:                                  | 1.00        | 1.00 | 1.00 | 1.00        | 1.00 | 1.00 | 1.00       | 1.00 | 1.00 | 1.00       | 1.00 | 1.00 |
| Initial Bse:                                 | 143         | 259  | 65   | 217         | 931  | 195  | 148        | 848  | 122  | 243        | 841  | 91   |
| Added Vol:                                   | 0           | 0    | 0    | 0           | 0    | 0    | 0          | 0    | 0    | 0          | 0    | 0    |
| PasserByVol:                                 | 0           | 0    | 0    | 0           | 0    | 0    | 0          | 0    | 0    | 0          | 0    | 0    |
| Initial Fut:                                 | 143         | 259  | 65   | 217         | 931  | 195  | 148        | 848  | 122  | 243        | 841  | 91   |
| User Adj:                                    | 1.00        | 1.00 | 1.00 | 1.00        | 1.00 | 1.00 | 1.00       | 1.00 | 1.00 | 1.00       | 1.00 | 1.00 |
| PHF Adj:                                     | 1.00        | 1.00 | 1.00 | 1.00        | 1.00 | 1.00 | 1.00       | 1.00 | 1.00 | 1.00       | 1.00 | 1.00 |
| PHF Volume:                                  | 143         | 259  | 65   | 217         | 931  | 195  | 148        | 848  | 122  | 243        | 841  | 91   |
| Reduct Vol:                                  | 0           | 0    | 0    | 0           | 0    | 0    | 0          | 0    | 0    | 0          | 0    | 0    |
| Reduced Vol:                                 | 143         | 259  | 65   | 217         | 931  | 195  | 148        | 848  | 122  | 243        | 841  | 91   |
| PCE Adj:                                     | 1.00        | 1.00 | 1.00 | 1.00        | 1.00 | 1.00 | 1.00       | 1.00 | 1.00 | 1.00       | 1.00 | 1.00 |
| MLF Adj:                                     | 1.00        | 1.00 | 1.00 | 1.00        | 1.00 | 1.00 | 1.00       | 1.00 | 1.00 | 1.00       | 1.00 | 1.00 |
| Final Volume:                                | 143         | 259  | 65   | 217         | 931  | 195  | 148        | 848  | 122  | 243        | 841  | 91   |
| Saturation Flow Module:                      |             |      |      |             |      |      |            |      |      |            |      |      |
| Sat/Lane:                                    | 1900        | 1900 | 1900 | 1900        | 1900 | 1900 | 1900       | 1900 | 1900 | 1900       | 1900 | 1900 |
| Adjustment:                                  | 0.92        | 1.00 | 0.92 | 0.92        | 1.00 | 0.92 | 0.92       | 1.00 | 0.92 | 0.92       | 1.00 | 0.92 |
| Lanes:                                       | 1.00        | 2.00 | 1.00 | 1.00        | 2.00 | 1.00 | 1.00       | 3.00 | 1.00 | 1.00       | 3.00 | 1.00 |
| Final Sat.:                                  | 1750        | 3800 | 1750 | 1750        | 3800 | 1750 | 1750       | 5700 | 1750 | 1750       | 5700 | 1750 |
| Capacity Analysis Module:                    |             |      |      |             |      |      |            |      |      |            |      |      |
| Vol/Sat:                                     | 0.08        | 0.07 | 0.04 | 0.12        | 0.25 | 0.11 | 0.08       | 0.15 | 0.07 | 0.14       | 0.15 | 0.05 |
| Crit Moves:                                  | ****        |      |      | ****        |      |      | ****       |      |      | ****       |      |      |
| Green Time:                                  | 14.4        | 23.1 | 47.5 | 34.4        | 43.1 | 61.5 | 18.4       | 26.2 | 40.5 | 24.4       | 32.1 | 66.5 |
| Volume/Cap:                                  | 0.68        | 0.35 | 0.09 | 0.43        | 0.68 | 0.22 | 0.55       | 0.68 | 0.21 | 0.68       | 0.55 | 0.09 |
| Delay/Veh:                                   | 59.5        | 42.3 | 22.8 | 35.5        | 34.1 | 16.2 | 49.4       | 44.7 | 28.5 | 49.6       | 38.2 | 12.6 |
| User DelAdj:                                 | 1.00        | 1.00 | 1.00 | 1.00        | 1.00 | 1.00 | 1.00       | 1.00 | 1.00 | 1.00       | 1.00 | 1.00 |
| AdjDel/Veh:                                  | 59.5        | 42.3 | 22.8 | 35.5        | 34.1 | 16.2 | 49.4       | 44.7 | 28.5 | 49.6       | 38.2 | 12.6 |
| LOS by Move:                                 | E           | D    | C    | D           | C    | B    | D          | D    | C    | D          | D    | B    |
| HCM2k95thQ:                                  | 11          | 8    | 3    | 13          | 26   | 8    | 11         | 18   | 7    | 17         | 16   | 3    |

Note: Queue reported is the number of cars per lane.

BART

Level Of Service Computation Report  
 2000 HCM Operations (Future Volume Alternative)  
 AM - Background Conditions

Intersection #1213: THE ALAMEDA/EL CAMINO REAL [Study Int 54]

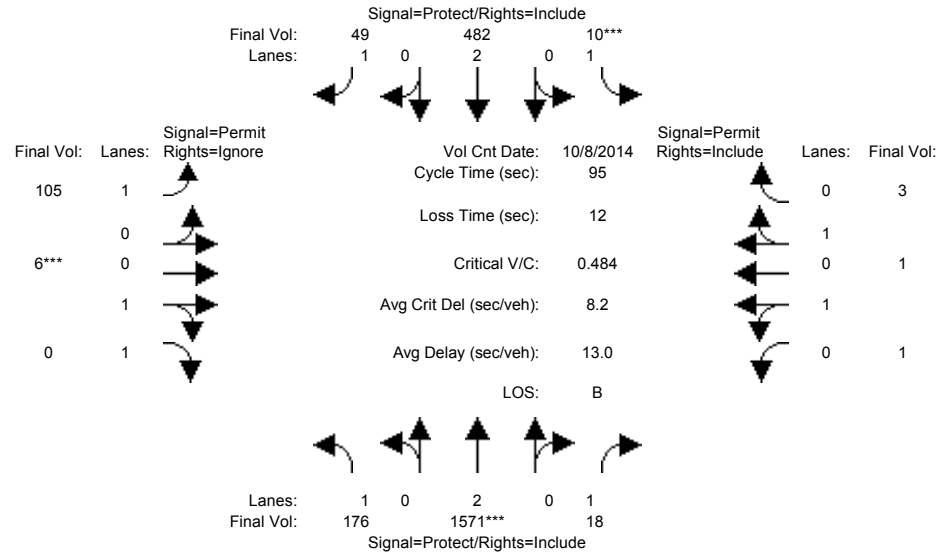

| Approach:                 | North Bound                  |      |      | South Bound |      |      | East Bound |      |      | West Bound |      |      |
|---------------------------|------------------------------|------|------|-------------|------|------|------------|------|------|------------|------|------|
| Movement:                 | L                            | T    | R    | L           | T    | R    | L          | T    | R    | L          | T    | R    |
| Min. Green:               | 7                            | 10   | 10   | 7           | 10   | 10   | 7          | 10   | 10   | 7          | 10   | 10   |
| Y+R:                      | 4.0                          | 4.0  | 4.0  | 4.0         | 4.0  | 4.0  | 4.0        | 4.0  | 4.0  | 4.0        | 4.0  | 4.0  |
| -----                     |                              |      |      |             |      |      |            |      |      |            |      |      |
| Volume Module:            | >> Count Date: 8 Oct 2014 << |      |      |             |      |      |            |      |      |            |      |      |
| Base Vol:                 | 176                          | 1571 | 18   | 10          | 482  | 49   | 105        | 6    | 108  | 1          | 1    | 3    |
| Growth Adj:               | 1.00                         | 1.00 | 1.00 | 1.00        | 1.00 | 1.00 | 1.00       | 1.00 | 1.00 | 1.00       | 1.00 | 1.00 |
| Initial Bse:              | 176                          | 1571 | 18   | 10          | 482  | 49   | 105        | 6    | 108  | 1          | 1    | 3    |
| Added Vol:                | 0                            | 0    | 0    | 0           | 0    | 0    | 0          | 0    | 0    | 0          | 0    | 0    |
| PasserByVol:              | 0                            | 0    | 0    | 0           | 0    | 0    | 0          | 0    | 0    | 0          | 0    | 0    |
| Initial Fut:              | 176                          | 1571 | 18   | 10          | 482  | 49   | 105        | 6    | 108  | 1          | 1    | 3    |
| User Adj:                 | 1.00                         | 1.00 | 1.00 | 1.00        | 1.00 | 1.00 | 1.00       | 1.00 | 0.00 | 1.00       | 1.00 | 1.00 |
| PHF Adj:                  | 1.00                         | 1.00 | 1.00 | 1.00        | 1.00 | 1.00 | 1.00       | 1.00 | 0.00 | 1.00       | 1.00 | 1.00 |
| PHF Volume:               | 176                          | 1571 | 18   | 10          | 482  | 49   | 105        | 6    | 0    | 1          | 1    | 3    |
| Reduct Vol:               | 0                            | 0    | 0    | 0           | 0    | 0    | 0          | 0    | 0    | 0          | 0    | 0    |
| Reduced Vol:              | 176                          | 1571 | 18   | 10          | 482  | 49   | 105        | 6    | 0    | 1          | 1    | 3    |
| PCE Adj:                  | 1.00                         | 1.00 | 1.00 | 1.00        | 1.00 | 1.00 | 1.00       | 1.00 | 0.00 | 1.00       | 1.00 | 1.00 |
| MLF Adj:                  | 1.00                         | 1.00 | 1.00 | 1.00        | 1.00 | 1.00 | 1.00       | 1.00 | 0.00 | 1.00       | 1.00 | 1.00 |
| FinalVolume:              | 176                          | 1571 | 18   | 10          | 482  | 49   | 105        | 6    | 0    | 1          | 1    | 3    |
| -----                     |                              |      |      |             |      |      |            |      |      |            |      |      |
| Saturation Flow Module:   |                              |      |      |             |      |      |            |      |      |            |      |      |
| Sat/Lane:                 | 1900                         | 1900 | 1900 | 1900        | 1900 | 1900 | 1900       | 1900 | 1900 | 1900       | 1900 | 1900 |
| Adjustment:               | 0.92                         | 1.00 | 0.92 | 0.92        | 1.00 | 0.92 | 0.92       | 0.95 | 0.92 | 0.95       | 0.95 | 0.95 |
| Lanes:                    | 1.00                         | 2.00 | 1.00 | 1.00        | 2.00 | 1.00 | 1.00       | 1.00 | 1.00 | 0.50       | 0.50 | 1.00 |
| Final Sat.:               | 1750                         | 3800 | 1750 | 1750        | 3800 | 1750 | 1750       | 1800 | 1750 | 900        | 900  | 1800 |
| -----                     |                              |      |      |             |      |      |            |      |      |            |      |      |
| Capacity Analysis Module: |                              |      |      |             |      |      |            |      |      |            |      |      |
| Vol/Sat:                  | 0.10                         | 0.41 | 0.01 | 0.01        | 0.13 | 0.03 | 0.06       | 0.00 | 0.00 | 0.00       | 0.00 | 0.00 |
| Crit Moves:               | ****                         | **** | **** | ****        | **** | **** | ****       | **** | **** | ****       | **** | **** |
| Green Time:               | 32.3                         | 66.0 | 66.0 | 7.0         | 40.7 | 40.7 | 10.0       | 10.0 | 0.0  | 10.0       | 10.0 | 10.0 |
| Volume/Cap:               | 0.30                         | 0.60 | 0.01 | 0.08        | 0.30 | 0.07 | 0.57       | 0.03 | 0.00 | 0.01       | 0.01 | 0.02 |
| Delay/Veh:                | 23.3                         | 7.9  | 4.5  | 41.3        | 17.9 | 16.0 | 44.7       | 38.2 | 0.0  | 38.1       | 38.1 | 38.1 |
| User DelAdj:              | 1.00                         | 1.00 | 1.00 | 1.00        | 1.00 | 1.00 | 1.00       | 1.00 | 1.00 | 1.00       | 1.00 | 1.00 |
| AdjDel/Veh:               | 23.3                         | 7.9  | 4.5  | 41.3        | 17.9 | 16.0 | 44.7       | 38.2 | 0.0  | 38.1       | 38.1 | 38.1 |
| LOS by Move:              | C                            | A    | A    | D           | B    | B    | D          | D    | A    | D          | D    | D    |
| HCM2k95thQ:               | 8                            | 21   | 0    | 1           | 9    | 2    | 8          | 0    | 0    | 0          | 0    | 0    |

Note: Queue reported is the number of cars per lane.

BART

Level Of Service Computation Report  
 2000 HCM Operations (Future Volume Alternative)  
 PM - Background Conditions

Intersection #1213: THE ALAMEDA/EL CAMINO REAL [Study Int 54]

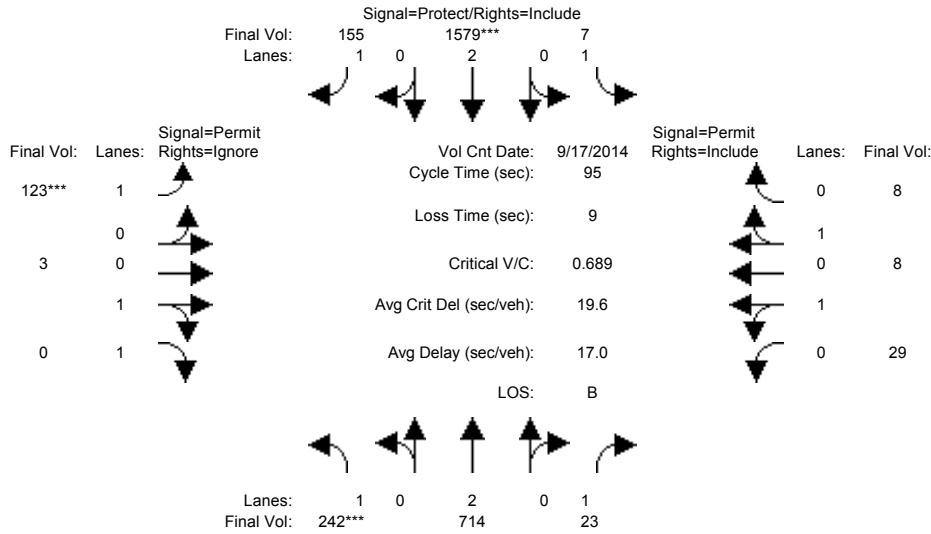

| Approach:                                    | North Bound |      |      | South Bound |      |      | East Bound |      |      | West Bound |      |      |
|--|-------------|------|------|-------------|------|------|------------|------|------|------------|------|------|
| Movement:                                    | L           | T    | R    | L           | T    | R    | L          | T    | R    | L          | T    | R    |
| Min. Green:                                  | 7           | 10   | 10   | 7           | 10   | 10   | 10         | 10   | 10   | 10         | 10   | 10   |
| Y+R:   | 4.0         | 4.0  | 4.0  | 4.0         | 4.0  | 4.0  | 4.0        | 4.0  | 4.0  | 4.0        | 4.0  | 4.0  |
| -----  |             |      |      |             |      |      |            |      |      |            |      |      |
| Volume Module: >> Count Date: 17 Sep 2014 << |             |      |      |             |      |      |            |      |      |            |      |      |
| Base Vol:                                    | 242         | 714  | 23   | 7           | 1579 | 155  | 123        | 3    | 281  | 29         | 8    | 8    |
| Growth Adj:                                  | 1.00        | 1.00 | 1.00 | 1.00        | 1.00 | 1.00 | 1.00       | 1.00 | 1.00 | 1.00       | 1.00 | 1.00 |
| Initial Bse:                                 | 242         | 714  | 23   | 7           | 1579 | 155  | 123        | 3    | 281  | 29         | 8    | 8    |
| Added Vol:                                   | 0           | 0    | 0    | 0           | 0    | 0    | 0          | 0    | 0    | 0          | 0    | 0    |
| PasserByVol:                                 | 0           | 0    | 0    | 0           | 0    | 0    | 0          | 0    | 0    | 0          | 0    | 0    |
| Initial Fut:                                 | 242         | 714  | 23   | 7           | 1579 | 155  | 123        | 3    | 281  | 29         | 8    | 8    |
| User Adj:                                    | 1.00        | 1.00 | 1.00 | 1.00        | 1.00 | 1.00 | 1.00       | 1.00 | 0.00 | 1.00       | 1.00 | 1.00 |
| PHF Adj:                                     | 1.00        | 1.00 | 1.00 | 1.00        | 1.00 | 1.00 | 1.00       | 1.00 | 0.00 | 1.00       | 1.00 | 1.00 |
| PHF Volume:                                  | 242         | 714  | 23   | 7           | 1579 | 155  | 123        | 3    | 0    | 29         | 8    | 8    |
| Reduct Vol:                                  | 0           | 0    | 0    | 0           | 0    | 0    | 0          | 0    | 0    | 0          | 0    | 0    |
| Reduced Vol:                                 | 242         | 714  | 23   | 7           | 1579 | 155  | 123        | 3    | 0    | 29         | 8    | 8    |
| PCE Adj:                                     | 1.00        | 1.00 | 1.00 | 1.00        | 1.00 | 1.00 | 1.00       | 1.00 | 0.00 | 1.00       | 1.00 | 1.00 |
| MLF Adj:                                     | 1.00        | 1.00 | 1.00 | 1.00        | 1.00 | 1.00 | 1.00       | 1.00 | 0.00 | 1.00       | 1.00 | 1.00 |
| Final Volume:                                | 242         | 714  | 23   | 7           | 1579 | 155  | 123        | 3    | 0    | 29         | 8    | 8    |
| -----  |             |      |      |             |      |      |            |      |      |            |      |      |
| Saturation Flow Module:                      |             |      |      |             |      |      |            |      |      |            |      |      |
| Sat/Lane:                                    | 1900        | 1900 | 1900 | 1900        | 1900 | 1900 | 1900       | 1900 | 1900 | 1900       | 1900 | 1900 |
| Adjustment:                                  | 0.92        | 1.00 | 0.92 | 0.92        | 1.00 | 0.92 | 0.92       | 0.95 | 0.92 | 0.95       | 0.95 | 0.95 |
| Lanes:                                       | 1.00        | 2.00 | 1.00 | 1.00        | 2.00 | 1.00 | 1.00       | 1.00 | 1.00 | 1.00       | 0.50 | 0.50 |
| Final Sat.:                                  | 1750        | 3800 | 1750 | 1750        | 3800 | 1750 | 1750       | 1800 | 1750 | 1800       | 900  | 900  |
| -----  |             |      |      |             |      |      |            |      |      |            |      |      |
| Capacity Analysis Module:                    |             |      |      |             |      |      |            |      |      |            |      |      |
| Vol/Sat:                                     | 0.14        | 0.19 | 0.01 | 0.00        | 0.42 | 0.09 | 0.07       | 0.00 | 0.00 | 0.02       | 0.01 | 0.01 |
| Crit Moves:                                  | ****        |      |      | ****        |      |      | ****       |      |      |            |      |      |
| Green Time:                                  | 19.0        | 54.6 | 54.6 | 21.4        | 57.0 | 57.0 | 10.0       | 10.0 | 0.0  | 10.0       | 10.0 | 10.0 |
| Volume/Cap:                                  | 0.69        | 0.33 | 0.02 | 0.02        | 0.69 | 0.15 | 0.67       | 0.02 | 0.00 | 0.15       | 0.08 | 0.08 |
| Delay/Veh:                                   | 41.2        | 10.7 | 8.7  | 28.6        | 13.9 | 8.4  | 49.9       | 38.1 | 0.0  | 38.9       | 38.4 | 38.4 |
| User DelAdj:                                 | 1.00        | 1.00 | 1.00 | 1.00        | 1.00 | 1.00 | 1.00       | 1.00 | 1.00 | 1.00       | 1.00 | 1.00 |
| AdjDel/Veh:                                  | 41.2        | 10.7 | 8.7  | 28.6        | 13.9 | 8.4  | 49.9       | 38.1 | 0.0  | 38.9       | 38.4 | 38.4 |
| LOS by Move:                                 | D           | B    | A    | C           | B    | A    | D          | D    | A    | D          | D    | D    |
| HCM2k95thQ:                                  | 14          | 10   | 1    | 0           | 29   | 4    | 10         | 0    | 0    | 2          | 1    | 1    |

Note: Queue reported is the number of cars per lane.

BART

Level Of Service Computation Report  
 2000 HCM Operations (Future Volume Alternative)  
 AM - Background Conditions

Intersection #1214: THE ALAMEDA/NEWHALL [Study Int 55]

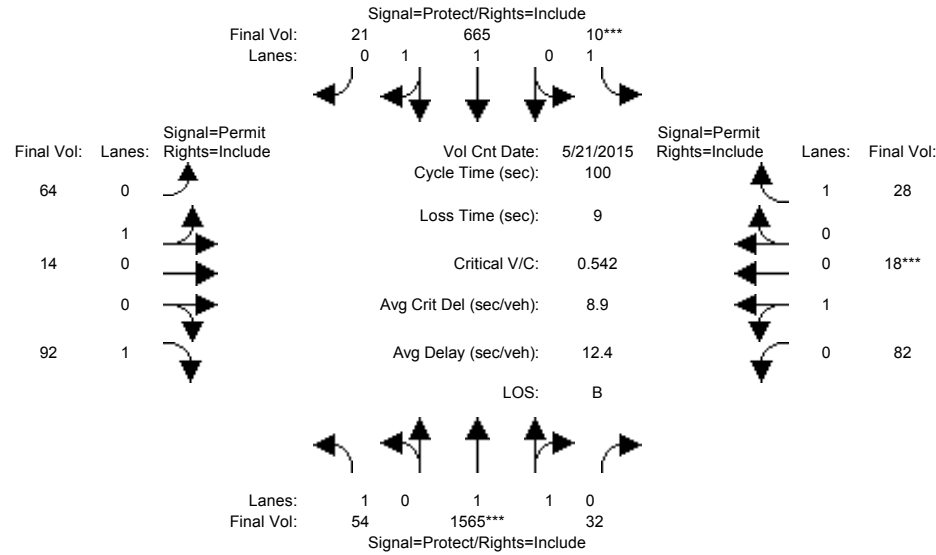

| Approach:                                    | North Bound |      |      | South Bound |      |      | East Bound |      |      | West Bound |      |      |
|--|-------------|------|------|-------------|------|------|------------|------|------|------------|------|------|
| Movement:                                    | L           | T    | R    | L           | T    | R    | L          | T    | R    | L          | T    | R    |
| Min. Green:                                  | 7           | 10   | 10   | 7           | 10   | 10   | 7          | 10   | 10   | 7          | 10   | 10   |
| Y+R:   | 4.0         | 4.0  | 4.0  | 4.0         | 4.0  | 4.0  | 4.0        | 4.0  | 4.0  | 4.0        | 4.0  | 4.0  |
| Volume Module: >> Count Date: 21 May 2015 << |             |      |      |             |      |      |            |      |      |            |      |      |
| Base Vol:                                    | 54          | 1565 | 32   | 10          | 665  | 21   | 64         | 14   | 92   | 82         | 18   | 28   |
| Growth Adj:                                  | 1.00        | 1.00 | 1.00 | 1.00        | 1.00 | 1.00 | 1.00       | 1.00 | 1.00 | 1.00       | 1.00 | 1.00 |
| Initial Bse:                                 | 54          | 1565 | 32   | 10          | 665  | 21   | 64         | 14   | 92   | 82         | 18   | 28   |
| Added Vol:                                   | 0           | 0    | 0    | 0           | 0    | 0    | 0          | 0    | 0    | 0          | 0    | 0    |
| PasserByVol:                                 | 0           | 0    | 0    | 0           | 0    | 0    | 0          | 0    | 0    | 0          | 0    | 0    |
| Initial Fut:                                 | 54          | 1565 | 32   | 10          | 665  | 21   | 64         | 14   | 92   | 82         | 18   | 28   |
| User Adj:                                    | 1.00        | 1.00 | 1.00 | 1.00        | 1.00 | 1.00 | 1.00       | 1.00 | 1.00 | 1.00       | 1.00 | 1.00 |
| PHF Adj:                                     | 1.00        | 1.00 | 1.00 | 1.00        | 1.00 | 1.00 | 1.00       | 1.00 | 1.00 | 1.00       | 1.00 | 1.00 |
| PHF Volume:                                  | 54          | 1565 | 32   | 10          | 665  | 21   | 64         | 14   | 92   | 82         | 18   | 28   |
| Reduct Vol:                                  | 0           | 0    | 0    | 0           | 0    | 0    | 0          | 0    | 0    | 0          | 0    | 0    |
| Reduced Vol:                                 | 54          | 1565 | 32   | 10          | 665  | 21   | 64         | 14   | 92   | 82         | 18   | 28   |
| PCE Adj:                                     | 1.00        | 1.00 | 1.00 | 1.00        | 1.00 | 1.00 | 1.00       | 1.00 | 1.00 | 1.00       | 1.00 | 1.00 |
| MLF Adj:                                     | 1.00        | 1.00 | 1.00 | 1.00        | 1.00 | 1.00 | 1.00       | 1.00 | 1.00 | 1.00       | 1.00 | 1.00 |
| FinalVolume:                                 | 54          | 1565 | 32   | 10          | 665  | 21   | 64         | 14   | 92   | 82         | 18   | 28   |
| Saturation Flow Module:                      |             |      |      |             |      |      |            |      |      |            |      |      |
| Sat/Lane:                                    | 1900        | 1900 | 1900 | 1900        | 1900 | 1900 | 1900       | 1900 | 1900 | 1900       | 1900 | 1900 |
| Adjustment:                                  | 0.92        | 0.97 | 0.95 | 0.92        | 0.97 | 0.95 | 0.95       | 0.95 | 0.92 | 0.95       | 0.95 | 0.92 |
| Lanes:                                       | 1.00        | 1.96 | 0.04 | 1.00        | 1.94 | 0.06 | 0.82       | 0.18 | 1.00 | 0.82       | 0.18 | 1.00 |
| Final Sat.:                                  | 1750        | 3626 | 74   | 1750        | 3587 | 113  | 1477       | 323  | 1750 | 1476       | 324  | 1750 |
| Capacity Analysis Module:                    |             |      |      |             |      |      |            |      |      |            |      |      |
| Vol/Sat:                                     | 0.03        | 0.43 | 0.43 | 0.01        | 0.19 | 0.19 | 0.04       | 0.04 | 0.05 | 0.06       | 0.06 | 0.02 |
| Crit Moves:                                  | ****        | **** | **** | ****        | **** | **** | ****       | **** | **** | ****       | **** | **** |
| Green Time:                                  | 22.2        | 74.0 | 74.0 | 7.0         | 58.8 | 58.8 | 10.0       | 10.0 | 10.0 | 10.0       | 10.0 | 10.0 |
| Volume/Cap:                                  | 0.14        | 0.58 | 0.58 | 0.08        | 0.32 | 0.32 | 0.43       | 0.43 | 0.53 | 0.56       | 0.56 | 0.16 |
| Delay/Veh:                                   | 31.4        | 6.3  | 6.3  | 43.8        | 10.5 | 10.5 | 44.0       | 44.0 | 45.7 | 46.7       | 46.7 | 41.6 |
| User DelAdj:                                 | 1.00        | 1.00 | 1.00 | 1.00        | 1.00 | 1.00 | 1.00       | 1.00 | 1.00 | 1.00       | 1.00 | 1.00 |
| AdjDel/Veh:                                  | 31.4        | 6.3  | 6.3  | 43.8        | 10.5 | 10.5 | 44.0       | 44.0 | 45.7 | 46.7       | 46.7 | 41.6 |
| LOS by Move:                                 | C           | A    | A    | D           | B    | B    | D          | D    | D    | D          | D    | D    |
| HCM2k95thQ:                                  | 3           | 21   | 21   | 1           | 10   | 10   | 5          | 5    | 6    | 8          | 8    | 2    |

Note: Queue reported is the number of cars per lane.

BART

Level Of Service Computation Report  
 2000 HCM Operations (Future Volume Alternative)  
 PM - Background Conditions

Intersection #1214: THE ALAMEDA/NEWHALL [Study Int 55]

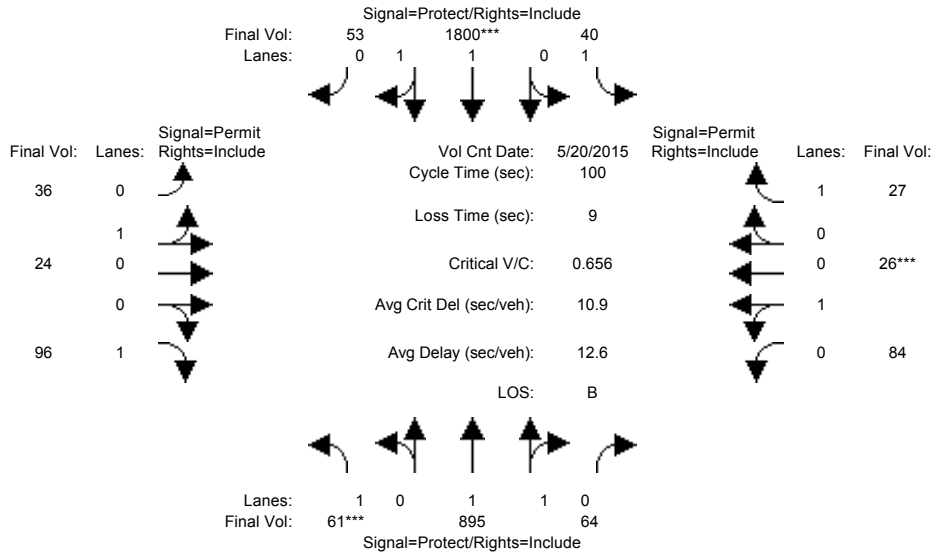

| Approach:                                    | North Bound |      |      | South Bound |      |      | East Bound |      |      | West Bound |      |      |
|--|-------------|------|------|-------------|------|------|------------|------|------|------------|------|------|
| Movement:                                    | L           | T    | R    | L           | T    | R    | L          | T    | R    | L          | T    | R    |
| Min. Green:                                  | 7           | 10   | 10   | 7           | 10   | 10   | 7          | 10   | 10   | 7          | 10   | 10   |
| Y+R:   | 4.0         | 4.0  | 4.0  | 4.0         | 4.0  | 4.0  | 4.0        | 4.0  | 4.0  | 4.0        | 4.0  | 4.0  |
| -----  |             |      |      |             |      |      |            |      |      |            |      |      |
| Volume Module: >> Count Date: 20 May 2015 << |             |      |      |             |      |      |            |      |      |            |      |      |
| Base Vol:                                    | 61          | 895  | 64   | 40          | 1800 | 53   | 36         | 24   | 96   | 84         | 26   | 27   |
| Growth Adj:                                  | 1.00        | 1.00 | 1.00 | 1.00        | 1.00 | 1.00 | 1.00       | 1.00 | 1.00 | 1.00       | 1.00 | 1.00 |
| Initial Bse:                                 | 61          | 895  | 64   | 40          | 1800 | 53   | 36         | 24   | 96   | 84         | 26   | 27   |
| Added Vol:                                   | 0           | 0    | 0    | 0           | 0    | 0    | 0          | 0    | 0    | 0          | 0    | 0    |
| PasserByVol:                                 | 0           | 0    | 0    | 0           | 0    | 0    | 0          | 0    | 0    | 0          | 0    | 0    |
| Initial Fut:                                 | 61          | 895  | 64   | 40          | 1800 | 53   | 36         | 24   | 96   | 84         | 26   | 27   |
| User Adj:                                    | 1.00        | 1.00 | 1.00 | 1.00        | 1.00 | 1.00 | 1.00       | 1.00 | 1.00 | 1.00       | 1.00 | 1.00 |
| PHF Adj:                                     | 1.00        | 1.00 | 1.00 | 1.00        | 1.00 | 1.00 | 1.00       | 1.00 | 1.00 | 1.00       | 1.00 | 1.00 |
| PHF Volume:                                  | 61          | 895  | 64   | 40          | 1800 | 53   | 36         | 24   | 96   | 84         | 26   | 27   |
| Reduct Vol:                                  | 0           | 0    | 0    | 0           | 0    | 0    | 0          | 0    | 0    | 0          | 0    | 0    |
| Reduced Vol:                                 | 61          | 895  | 64   | 40          | 1800 | 53   | 36         | 24   | 96   | 84         | 26   | 27   |
| PCE Adj:                                     | 1.00        | 1.00 | 1.00 | 1.00        | 1.00 | 1.00 | 1.00       | 1.00 | 1.00 | 1.00       | 1.00 | 1.00 |
| MLF Adj:                                     | 1.00        | 1.00 | 1.00 | 1.00        | 1.00 | 1.00 | 1.00       | 1.00 | 1.00 | 1.00       | 1.00 | 1.00 |
| Final Volume:                                | 61          | 895  | 64   | 40          | 1800 | 53   | 36         | 24   | 96   | 84         | 26   | 27   |
| -----  |             |      |      |             |      |      |            |      |      |            |      |      |
| Saturation Flow Module:                      |             |      |      |             |      |      |            |      |      |            |      |      |
| Sat/Lane:                                    | 1900        | 1900 | 1900 | 1900        | 1900 | 1900 | 1900       | 1900 | 1900 | 1900       | 1900 | 1900 |
| Adjustment:                                  | 0.92        | 0.98 | 0.95 | 0.92        | 0.97 | 0.95 | 0.95       | 0.95 | 0.92 | 0.95       | 0.95 | 0.92 |
| Lanes:                                       | 1.00        | 1.86 | 0.14 | 1.00        | 1.94 | 0.06 | 0.60       | 0.40 | 1.00 | 0.76       | 0.24 | 1.00 |
| Final Sat.:                                  | 1750        | 3453 | 247  | 1750        | 3594 | 106  | 1080       | 720  | 1750 | 1375       | 425  | 1750 |
| -----  |             |      |      |             |      |      |            |      |      |            |      |      |
| Capacity Analysis Module:                    |             |      |      |             |      |      |            |      |      |            |      |      |
| Vol/Sat:                                     | 0.03        | 0.26 | 0.26 | 0.02        | 0.50 | 0.50 | 0.03       | 0.03 | 0.05 | 0.06       | 0.06 | 0.02 |
| Crit Moves:                                  | ****        |      |      | ****        |      |      |            |      |      | ****       |      |      |
| Green Time:                                  | 7.0         | 63.8 | 63.8 | 17.2        | 74.0 | 74.0 | 10.0       | 10.0 | 10.0 | 10.0       | 10.0 | 10.0 |
| Volume/Cap:                                  | 0.50        | 0.41 | 0.41 | 0.13        | 0.68 | 0.68 | 0.33       | 0.33 | 0.55 | 0.61       | 0.61 | 0.15 |
| Delay/Veh:                                   | 48.0        | 9.0  | 9.0  | 35.3        | 7.5  | 7.5  | 43.0       | 43.0 | 46.5 | 49.2       | 49.2 | 41.5 |
| User DelAdj:                                 | 1.00        | 1.00 | 1.00 | 1.00        | 1.00 | 1.00 | 1.00       | 1.00 | 1.00 | 1.00       | 1.00 | 1.00 |
| AdjDel/Veh:                                  | 48.0        | 9.0  | 9.0  | 35.3        | 7.5  | 7.5  | 43.0       | 43.0 | 46.5 | 49.2       | 49.2 | 41.5 |
| LOS by Move:                                 | D           | A    | A    | D           | A    | A    | D          | D    | D    | D          | D    | D    |
| HCM2k95thQ:                                  | 4           | 14   | 14   | 2           | 26   | 26   | 4          | 4    | 6    | 9          | 9    | 2    |

Note: Queue reported is the number of cars per lane.

BART

Level Of Service Computation Report  
2000 HCM Operations (Future Volume Alternative)  
AM - Background Conditions

Intersection #3016: 101/ALUM ROCK [Study Int 15]

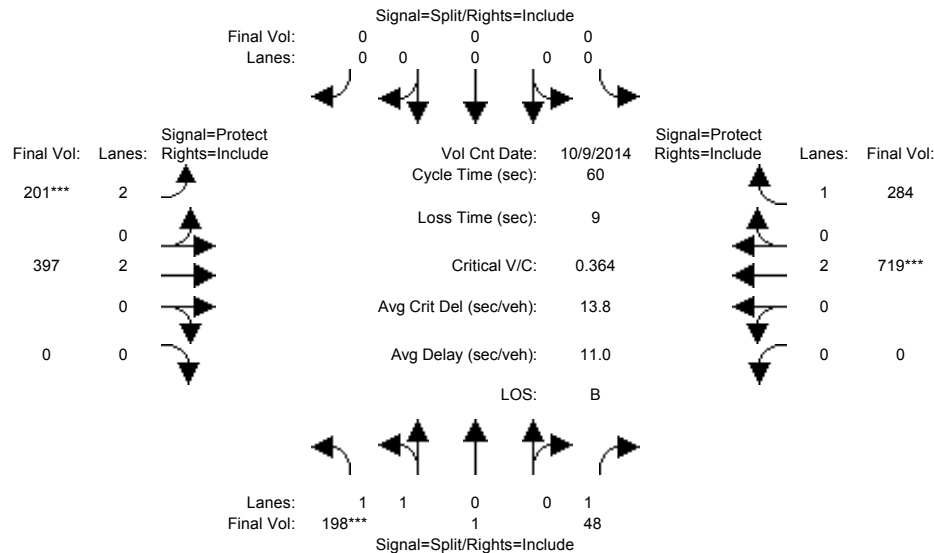

| Approach:                                   | North Bound |      |      | South Bound |      |      | East Bound |      |      | West Bound |      |      |
|---|-------------|------|------|-------------|------|------|------------|------|------|------------|------|------|
| Movement:                                   | L           | T    | R    | L           | T    | R    | L          | T    | R    | L          | T    | R    |
| Min. Green:                                 | 10          | 10   | 10   | 0           | 0    | 0    | 7          | 10   | 0    | 0          | 10   | 10   |
| Y+R:  | 4.0         | 4.0  | 4.0  | 4.0         | 4.0  | 4.0  | 4.0        | 4.0  | 4.0  | 4.0        | 4.0  | 4.0  |
| Volume Module: >> Count Date: 9 Oct 2014 << |             |      |      |             |      |      |            |      |      |            |      |      |
| Base Vol:                                   | 198         | 1    | 48   | 0           | 0    | 0    | 201        | 397  | 0    | 0          | 719  | 284  |
| Growth Adj:                                 | 1.00        | 1.00 | 1.00 | 1.00        | 1.00 | 1.00 | 1.00       | 1.00 | 1.00 | 1.00       | 1.00 | 1.00 |
| Initial Bse:                                | 198         | 1    | 48   | 0           | 0    | 0    | 201        | 397  | 0    | 0          | 719  | 284  |
| Added Vol:                                  | 0           | 0    | 0    | 0           | 0    | 0    | 0          | 0    | 0    | 0          | 0    | 0    |
| PasserByVol:                                | 0           | 0    | 0    | 0           | 0    | 0    | 0          | 0    | 0    | 0          | 0    | 0    |
| Initial Fut:                                | 198         | 1    | 48   | 0           | 0    | 0    | 201        | 397  | 0    | 0          | 719  | 284  |
| User Adj:                                   | 1.00        | 1.00 | 1.00 | 1.00        | 1.00 | 1.00 | 1.00       | 1.00 | 1.00 | 1.00       | 1.00 | 1.00 |
| PHF Adj:                                    | 1.00        | 1.00 | 1.00 | 1.00        | 1.00 | 1.00 | 1.00       | 1.00 | 1.00 | 1.00       | 1.00 | 1.00 |
| PHF Volume:                                 | 198         | 1    | 48   | 0           | 0    | 0    | 201        | 397  | 0    | 0          | 719  | 284  |
| Reduct Vol:                                 | 0           | 0    | 0    | 0           | 0    | 0    | 0          | 0    | 0    | 0          | 0    | 0    |
| Reduced Vol:                                | 198         | 1    | 48   | 0           | 0    | 0    | 201        | 397  | 0    | 0          | 719  | 284  |
| PCE Adj:                                    | 1.00        | 1.00 | 1.00 | 1.00        | 1.00 | 1.00 | 1.00       | 1.00 | 1.00 | 1.00       | 1.00 | 1.00 |
| MLF Adj:                                    | 1.00        | 1.00 | 1.00 | 1.00        | 1.00 | 1.00 | 1.00       | 1.00 | 1.00 | 1.00       | 1.00 | 1.00 |
| Final Volume:                               | 198         | 1    | 48   | 0           | 0    | 0    | 201        | 397  | 0    | 0          | 719  | 284  |
| Saturation Flow Module:                     |             |      |      |             |      |      |            |      |      |            |      |      |
| Sat/Lane:                                   | 1900        | 1900 | 1900 | 1900        | 1900 | 1900 | 1900       | 1900 | 1900 | 1900       | 1900 | 1900 |
| Adjustment:                                 | 0.93        | 0.95 | 0.92 | 0.92        | 1.00 | 0.92 | 0.83       | 1.00 | 0.92 | 0.92       | 1.00 | 0.92 |
| Lanes:                                      | 1.99        | 0.01 | 1.00 | 0.00        | 0.00 | 0.00 | 2.00       | 2.00 | 0.00 | 0.00       | 2.00 | 1.00 |
| Final Sat.:                                 | 3532        | 18   | 1750 | 0           | 0    | 0    | 3150       | 3800 | 0    | 0          | 3800 | 1750 |
| Capacity Analysis Module:                   |             |      |      |             |      |      |            |      |      |            |      |      |
| Vol/Sat:                                    | 0.06        | 0.06 | 0.03 | 0.00        | 0.00 | 0.00 | 0.06       | 0.10 | 0.00 | 0.00       | 0.19 | 0.16 |
| Crit Moves:                                 | ****        |      |      |             |      |      | ****       |      |      | ****       |      |      |
| Green Time:                                 | 10.0        | 10.0 | 10.0 | 0.0         | 0.0  | 0.0  | 10.3       | 41.0 | 0.0  | 0.0        | 30.7 | 30.7 |
| Volume/Cap:                                 | 0.34        | 0.34 | 0.16 | 0.00        | 0.00 | 0.00 | 0.37       | 0.15 | 0.00 | 0.00       | 0.37 | 0.32 |
| Delay/Veh:                                  | 22.4        | 22.4 | 21.7 | 0.0         | 0.0  | 0.0  | 22.4       | 3.4  | 0.0  | 0.0        | 9.0  | 8.8  |
| User DelAdj:                                | 1.00        | 1.00 | 1.00 | 1.00        | 1.00 | 1.00 | 1.00       | 1.00 | 1.00 | 1.00       | 1.00 | 1.00 |
| AdjDel/Veh:                                 | 22.4        | 22.4 | 21.7 | 0.0         | 0.0  | 0.0  | 22.4       | 3.4  | 0.0  | 0.0        | 9.0  | 8.8  |
| LOS by Move:                                | C           | C    | C    | A           | A    | A    | C          | A    | A    | A          | A    | A    |
| HCM2k95thQ:                                 | 4           | 4    | 2    | 0           | 0    | 0    | 4          | 3    | 0    | 0          | 8    | 6    |

Note: Queue reported is the number of cars per lane.

BART

Level Of Service Computation Report  
2000 HCM Operations (Future Volume Alternative)  
PM - Background Conditions

Intersection #3016: 101/ALUM ROCK [Study Int 15]

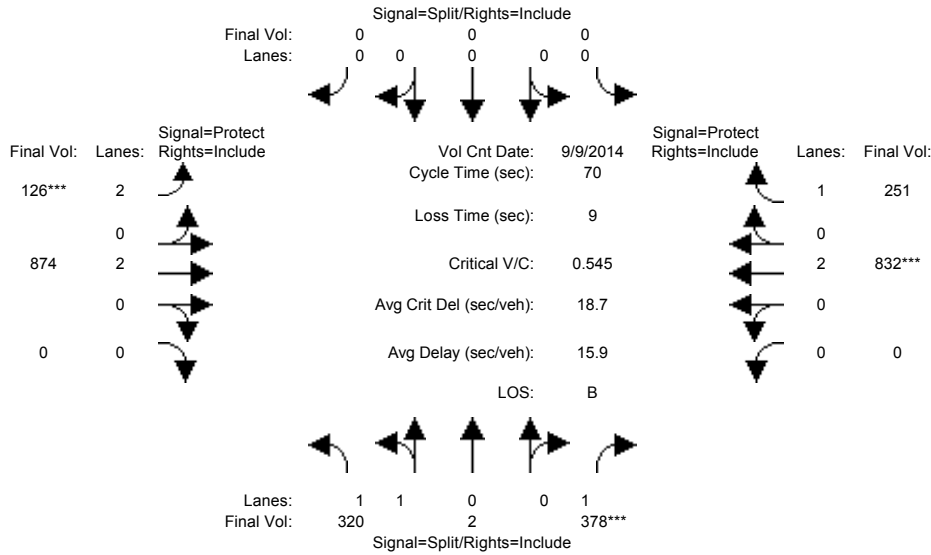

| Approach:                                   | North Bound |      |      | South Bound |      |      | East Bound |      |      | West Bound |      |      |
|---|-------------|------|------|-------------|------|------|------------|------|------|------------|------|------|
| Movement:                                   | L           | T    | R    | L           | T    | R    | L          | T    | R    | L          | T    | R    |
| Min. Green:                                 | 10          | 10   | 10   | 0           | 0    | 0    | 7          | 10   | 0    | 0          | 10   | 10   |
| Y+R:  | 4.0         | 4.0  | 4.0  | 4.0         | 4.0  | 4.0  | 4.0        | 4.0  | 4.0  | 4.0        | 4.0  | 4.0  |
| Volume Module: >> Count Date: 9 Sep 2014 << |             |      |      |             |      |      |            |      |      |            |      |      |
| Base Vol:                                   | 320         | 2    | 378  | 0           | 0    | 0    | 126        | 874  | 0    | 0          | 832  | 251  |
| Growth Adj:                                 | 1.00        | 1.00 | 1.00 | 1.00        | 1.00 | 1.00 | 1.00       | 1.00 | 1.00 | 1.00       | 1.00 | 1.00 |
| Initial Bse:                                | 320         | 2    | 378  | 0           | 0    | 0    | 126        | 874  | 0    | 0          | 832  | 251  |
| Added Vol:                                  | 0           | 0    | 0    | 0           | 0    | 0    | 0          | 0    | 0    | 0          | 0    | 0    |
| PasserByVol:                                | 0           | 0    | 0    | 0           | 0    | 0    | 0          | 0    | 0    | 0          | 0    | 0    |
| Initial Fut:                                | 320         | 2    | 378  | 0           | 0    | 0    | 126        | 874  | 0    | 0          | 832  | 251  |
| User Adj:                                   | 1.00        | 1.00 | 1.00 | 1.00        | 1.00 | 1.00 | 1.00       | 1.00 | 1.00 | 1.00       | 1.00 | 1.00 |
| PHF Adj:                                    | 1.00        | 1.00 | 1.00 | 1.00        | 1.00 | 1.00 | 1.00       | 1.00 | 1.00 | 1.00       | 1.00 | 1.00 |
| PHF Volume:                                 | 320         | 2    | 378  | 0           | 0    | 0    | 126        | 874  | 0    | 0          | 832  | 251  |
| Reduct Vol:                                 | 0           | 0    | 0    | 0           | 0    | 0    | 0          | 0    | 0    | 0          | 0    | 0    |
| Reduced Vol:                                | 320         | 2    | 378  | 0           | 0    | 0    | 126        | 874  | 0    | 0          | 832  | 251  |
| PCE Adj:                                    | 1.00        | 1.00 | 1.00 | 1.00        | 1.00 | 1.00 | 1.00       | 1.00 | 1.00 | 1.00       | 1.00 | 1.00 |
| MLF Adj:                                    | 1.00        | 1.00 | 1.00 | 1.00        | 1.00 | 1.00 | 1.00       | 1.00 | 1.00 | 1.00       | 1.00 | 1.00 |
| FinalVolume:                                | 320         | 2    | 378  | 0           | 0    | 0    | 126        | 874  | 0    | 0          | 832  | 251  |
| Saturation Flow Module:                     |             |      |      |             |      |      |            |      |      |            |      |      |
| Sat/Lane:                                   | 1900        | 1900 | 1900 | 1900        | 1900 | 1900 | 1900       | 1900 | 1900 | 1900       | 1900 | 1900 |
| Adjustment:                                 | 0.93        | 0.95 | 0.92 | 0.92        | 1.00 | 0.92 | 0.83       | 1.00 | 0.92 | 0.92       | 1.00 | 0.92 |
| Lanes:                                      | 1.99        | 0.01 | 1.00 | 0.00        | 0.00 | 0.00 | 2.00       | 2.00 | 0.00 | 0.00       | 2.00 | 1.00 |
| Final Sat.:                                 | 3528        | 22   | 1750 | 0           | 0    | 0    | 3150       | 3800 | 0    | 0          | 3800 | 1750 |
| Capacity Analysis Module:                   |             |      |      |             |      |      |            |      |      |            |      |      |
| Vol/Sat:                                    | 0.09        | 0.09 | 0.22 | 0.00        | 0.00 | 0.00 | 0.04       | 0.23 | 0.00 | 0.00       | 0.22 | 0.14 |
| Crit Moves:                                 | ****        |      |      | ****        |      |      | ****       |      |      | ****       |      |      |
| Green Time:                                 | 26.8        | 26.8 | 26.8 | 0.0         | 0.0  | 0.0  | 7.0        | 34.2 | 0.0  | 0.0        | 27.2 | 27.2 |
| Volume/Cap:                                 | 0.24        | 0.24 | 0.56 | 0.00        | 0.00 | 0.00 | 0.40       | 0.47 | 0.00 | 0.00       | 0.56 | 0.37 |
| Delay/Veh:                                  | 14.7        | 14.7 | 18.1 | 0.0         | 0.0  | 0.0  | 30.4       | 12.1 | 0.0  | 0.0        | 17.3 | 15.6 |
| User DelAdj:                                | 1.00        | 1.00 | 1.00 | 1.00        | 1.00 | 1.00 | 1.00       | 1.00 | 1.00 | 1.00       | 1.00 | 1.00 |
| AdjDel/Veh:                                 | 14.7        | 14.7 | 18.1 | 0.0         | 0.0  | 0.0  | 30.4       | 12.1 | 0.0  | 0.0        | 17.3 | 15.6 |
| LOS by Move:                                | B           | B    | B    | A           | A    | A    | C          | B    | A    | A          | B    | B    |
| HCM2k95thQ:                                 | 5           | 5    | 14   | 0           | 0    | 0    | 3          | 12   | 0    | 0          | 13   | 8    |

Note: Queue reported is the number of cars per lane.

BART

Level Of Service Computation Report  
 2000 HCM Operations (Future Volume Alternative)  
 AM - Background Conditions

Intersection #3023: 101/SANTA CLARA [Study Int 14]

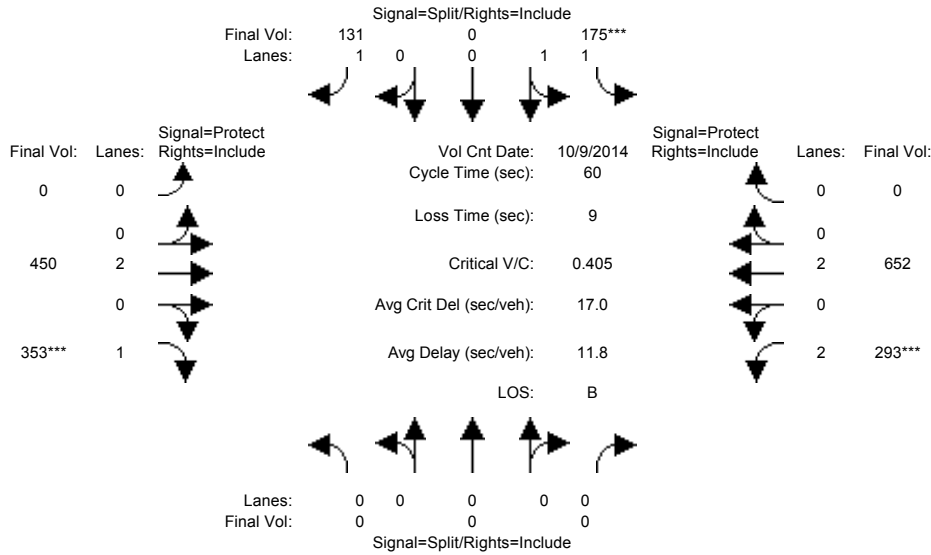

| Approach:                                   | North Bound |      |      | South Bound |      |      | East Bound |      |      | West Bound |      |      |
|---|-------------|------|------|-------------|------|------|------------|------|------|------------|------|------|
| Movement:                                   | L           | T    | R    | L           | T    | R    | L          | T    | R    | L          | T    | R    |
| Min. Green:                                 | 0           | 0    | 0    | 10          | 10   | 10   | 0          | 10   | 10   | 7          | 10   | 0    |
| Y+R:  | 4.0         | 4.0  | 4.0  | 4.0         | 4.0  | 4.0  | 4.0        | 4.0  | 4.0  | 4.0        | 4.0  | 4.0  |
| Volume Module: >> Count Date: 9 Oct 2014 << |             |      |      |             |      |      |            |      |      |            |      |      |
| Base Vol:                                   | 0           | 0    | 0    | 175         | 0    | 131  | 0          | 450  | 353  | 293        | 652  | 0    |
| Growth Adj:                                 | 1.00        | 1.00 | 1.00 | 1.00        | 1.00 | 1.00 | 1.00       | 1.00 | 1.00 | 1.00       | 1.00 | 1.00 |
| Initial Bse:                                | 0           | 0    | 0    | 175         | 0    | 131  | 0          | 450  | 353  | 293        | 652  | 0    |
| Added Vol:                                  | 0           | 0    | 0    | 0           | 0    | 0    | 0          | 0    | 0    | 0          | 0    | 0    |
| PasserByVol:                                | 0           | 0    | 0    | 0           | 0    | 0    | 0          | 0    | 0    | 0          | 0    | 0    |
| Initial Fut:                                | 0           | 0    | 0    | 175         | 0    | 131  | 0          | 450  | 353  | 293        | 652  | 0    |
| User Adj:                                   | 1.00        | 1.00 | 1.00 | 1.00        | 1.00 | 1.00 | 1.00       | 1.00 | 1.00 | 1.00       | 1.00 | 1.00 |
| PHF Adj:                                    | 1.00        | 1.00 | 1.00 | 1.00        | 1.00 | 1.00 | 1.00       | 1.00 | 1.00 | 1.00       | 1.00 | 1.00 |
| PHF Volume:                                 | 0           | 0    | 0    | 175         | 0    | 131  | 0          | 450  | 353  | 293        | 652  | 0    |
| Reduct Vol:                                 | 0           | 0    | 0    | 0           | 0    | 0    | 0          | 0    | 0    | 0          | 0    | 0    |
| Reduced Vol:                                | 0           | 0    | 0    | 175         | 0    | 131  | 0          | 450  | 353  | 293        | 652  | 0    |
| PCE Adj:                                    | 1.00        | 1.00 | 1.00 | 1.00        | 1.00 | 1.00 | 1.00       | 1.00 | 1.00 | 1.00       | 1.00 | 1.00 |
| MLF Adj:                                    | 1.00        | 1.00 | 1.00 | 1.00        | 1.00 | 1.00 | 1.00       | 1.00 | 1.00 | 1.00       | 1.00 | 1.00 |
| FinalVolume:                                | 0           | 0    | 0    | 175         | 0    | 131  | 0          | 450  | 353  | 293        | 652  | 0    |
| Saturation Flow Module:                     |             |      |      |             |      |      |            |      |      |            |      |      |
| Sat/Lane:                                   | 1900        | 1900 | 1900 | 1900        | 1900 | 1900 | 1900       | 1900 | 1900 | 1900       | 1900 | 1900 |
| Adjustment:                                 | 0.92        | 1.00 | 0.92 | 0.93        | 1.00 | 0.92 | 0.92       | 1.00 | 0.92 | 0.83       | 1.00 | 0.92 |
| Lanes:                                      | 0.00        | 0.00 | 0.00 | 2.00        | 0.00 | 1.00 | 0.00       | 2.00 | 1.00 | 2.00       | 2.00 | 0.00 |
| Final Sat.:                                 | 0           | 0    | 0    | 3550        | 0    | 1750 | 0          | 3800 | 1750 | 3150       | 3800 | 0    |
| Capacity Analysis Module:                   |             |      |      |             |      |      |            |      |      |            |      |      |
| Vol/Sat:                                    | 0.00        | 0.00 | 0.00 | 0.05        | 0.00 | 0.07 | 0.00       | 0.12 | 0.20 | 0.09       | 0.17 | 0.00 |
| Crit Moves:                                 | *****       |      |      |             |      |      |            |      |      |            |      |      |
| Green Time:                                 | 0.0         | 0.0  | 0.0  | 11.1        | 0.0  | 11.1 | 0.0        | 27.3 | 27.3 | 12.6       | 39.9 | 0.0  |
| Volume/Cap:                                 | 0.00        | 0.00 | 0.00 | 0.27        | 0.00 | 0.40 | 0.00       | 0.26 | 0.44 | 0.44       | 0.26 | 0.00 |
| Delay/Veh:                                  | 0.0         | 0.0  | 0.0  | 21.2        | 0.0  | 22.4 | 0.0        | 10.2 | 11.6 | 21.1       | 4.1  | 0.0  |
| User DelAdj:                                | 1.00        | 1.00 | 1.00 | 1.00        | 1.00 | 1.00 | 1.00       | 1.00 | 1.00 | 1.00       | 1.00 | 1.00 |
| AdjDel/Veh:                                 | 0.0         | 0.0  | 0.0  | 21.2        | 0.0  | 22.4 | 0.0        | 10.2 | 11.6 | 21.1       | 4.1  | 0.0  |
| LOS by Move:                                | A           | A    | A    | C           | A    | C    | A          | B    | B    | C          | A    | A    |
| HCM2k95thQ:                                 | 0           | 0    | 0    | 3           | 0    | 6    | 0          | 5    | 9    | 6          | 5    | 0    |

Note: Queue reported is the number of cars per lane.



BART

Level Of Service Computation Report  
 2000 HCM Operations (Future Volume Alternative)  
 PM - Background Conditions

Intersection #3023: 101/SANTA CLARA [Study Int 14]

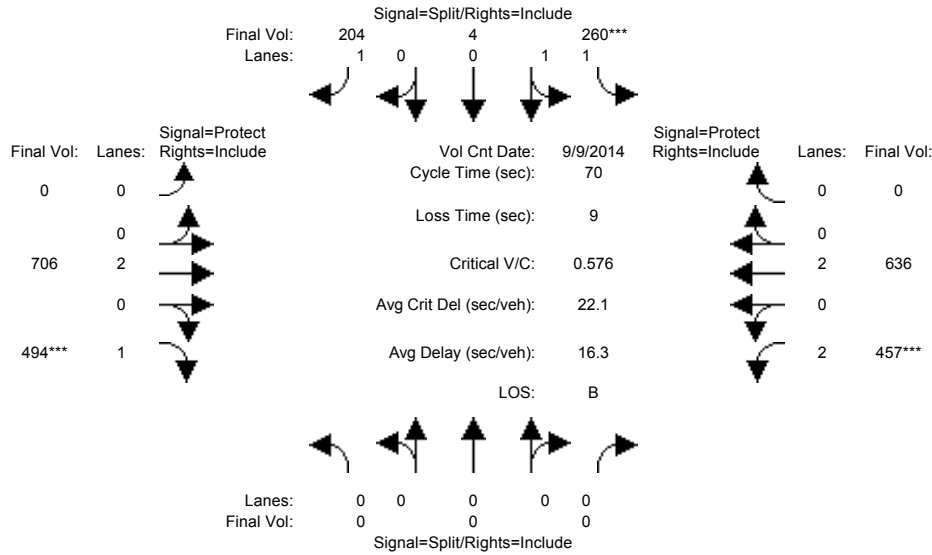

| Approach:                                   | North Bound |      |      | South Bound |      |      | East Bound |      |      | West Bound |      |      |
|---|-------------|------|------|-------------|------|------|------------|------|------|------------|------|------|
| Movement:                                   | L           | T    | R    | L           | T    | R    | L          | T    | R    | L          | T    | R    |
| Min. Green:                                 | 0           | 0    | 0    | 10          | 10   | 10   | 0          | 10   | 10   | 7          | 10   | 0    |
| Y+R:  | 4.0         | 4.0  | 4.0  | 4.0         | 4.0  | 4.0  | 4.0        | 4.0  | 4.0  | 4.0        | 4.0  | 4.0  |
| Volume Module: >> Count Date: 9 Sep 2014 << |             |      |      |             |      |      |            |      |      |            |      |      |
| Base Vol:                                   | 0           | 0    | 0    | 260         | 4    | 204  | 0          | 706  | 494  | 457        | 636  | 0    |
| Growth Adj:                                 | 1.00        | 1.00 | 1.00 | 1.00        | 1.00 | 1.00 | 1.00       | 1.00 | 1.00 | 1.00       | 1.00 | 1.00 |
| Initial Bse:                                | 0           | 0    | 0    | 260         | 4    | 204  | 0          | 706  | 494  | 457        | 636  | 0    |
| Added Vol:                                  | 0           | 0    | 0    | 0           | 0    | 0    | 0          | 0    | 0    | 0          | 0    | 0    |
| PasserByVol:                                | 0           | 0    | 0    | 0           | 0    | 0    | 0          | 0    | 0    | 0          | 0    | 0    |
| Initial Fut:                                | 0           | 0    | 0    | 260         | 4    | 204  | 0          | 706  | 494  | 457        | 636  | 0    |
| User Adj:                                   | 1.00        | 1.00 | 1.00 | 1.00        | 1.00 | 1.00 | 1.00       | 1.00 | 1.00 | 1.00       | 1.00 | 1.00 |
| PHF Adj:                                    | 1.00        | 1.00 | 1.00 | 1.00        | 1.00 | 1.00 | 1.00       | 1.00 | 1.00 | 1.00       | 1.00 | 1.00 |
| PHF Volume:                                 | 0           | 0    | 0    | 260         | 4    | 204  | 0          | 706  | 494  | 457        | 636  | 0    |
| Reduct Vol:                                 | 0           | 0    | 0    | 0           | 0    | 0    | 0          | 0    | 0    | 0          | 0    | 0    |
| Reduced Vol:                                | 0           | 0    | 0    | 260         | 4    | 204  | 0          | 706  | 494  | 457        | 636  | 0    |
| PCE Adj:                                    | 1.00        | 1.00 | 1.00 | 1.00        | 1.00 | 1.00 | 1.00       | 1.00 | 1.00 | 1.00       | 1.00 | 1.00 |
| MLF Adj:                                    | 1.00        | 1.00 | 1.00 | 1.00        | 1.00 | 1.00 | 1.00       | 1.00 | 1.00 | 1.00       | 1.00 | 1.00 |
| FinalVolume:                                | 0           | 0    | 0    | 260         | 4    | 204  | 0          | 706  | 494  | 457        | 636  | 0    |
| Saturation Flow Module:                     |             |      |      |             |      |      |            |      |      |            |      |      |
| Sat/Lane:                                   | 1900        | 1900 | 1900 | 1900        | 1900 | 1900 | 1900       | 1900 | 1900 | 1900       | 1900 | 1900 |
| Adjustment:                                 | 0.92        | 1.00 | 0.92 | 0.93        | 0.95 | 0.92 | 0.92       | 1.00 | 0.92 | 0.83       | 1.00 | 0.92 |
| Lanes:                                      | 0.00        | 0.00 | 0.00 | 1.97        | 0.03 | 1.00 | 0.00       | 2.00 | 1.00 | 2.00       | 2.00 | 0.00 |
| Final Sat.:                                 | 0           | 0    | 0    | 3496        | 54   | 1750 | 0          | 3800 | 1750 | 3150       | 3800 | 0    |
| Capacity Analysis Module:                   |             |      |      |             |      |      |            |      |      |            |      |      |
| Vol/Sat:                                    | 0.00        | 0.00 | 0.00 | 0.07        | 0.07 | 0.12 | 0.00       | 0.19 | 0.28 | 0.15       | 0.17 | 0.00 |
| Crit Moves:                                 | *****       |      |      |             |      |      |            |      |      |            |      |      |
| Green Time:                                 | 0.0         | 0.0  | 0.0  | 14.2        | 14.2 | 14.2 | 0.0        | 30.9 | 30.9 | 15.9       | 46.8 | 0.0  |
| Volume/Cap:                                 | 0.00        | 0.00 | 0.00 | 0.37        | 0.37 | 0.58 | 0.00       | 0.42 | 0.64 | 0.64       | 0.25 | 0.00 |
| Delay/Veh:                                  | 0.0         | 0.0  | 0.0  | 24.4        | 24.4 | 27.5 | 0.0        | 13.6 | 17.0 | 26.4       | 4.7  | 0.0  |
| User DelAdj:                                | 1.00        | 1.00 | 1.00 | 1.00        | 1.00 | 1.00 | 1.00       | 1.00 | 1.00 | 1.00       | 1.00 | 1.00 |
| AdjDel/Veh:                                 | 0.0         | 0.0  | 0.0  | 24.4        | 24.4 | 27.5 | 0.0        | 13.6 | 17.0 | 26.4       | 4.7  | 0.0  |
| LOS by Move:                                | A           | A    | A    | C           | C    | C    | A          | B    | B    | C          | A    | A    |
| HCM2k95thQ:                                 | 0           | 0    | 0    | 6           | 6    | 10   | 0          | 10   | 17   | 10         | 5    | 0    |

Note: Queue reported is the number of cars per lane.

BART

Level Of Service Computation Report  
 2000 HCM Operations (Future Volume Alternative)  
 AM - Background Conditions

Intersection #3036: 280/MCLAUGHLIN [Study Int 25]

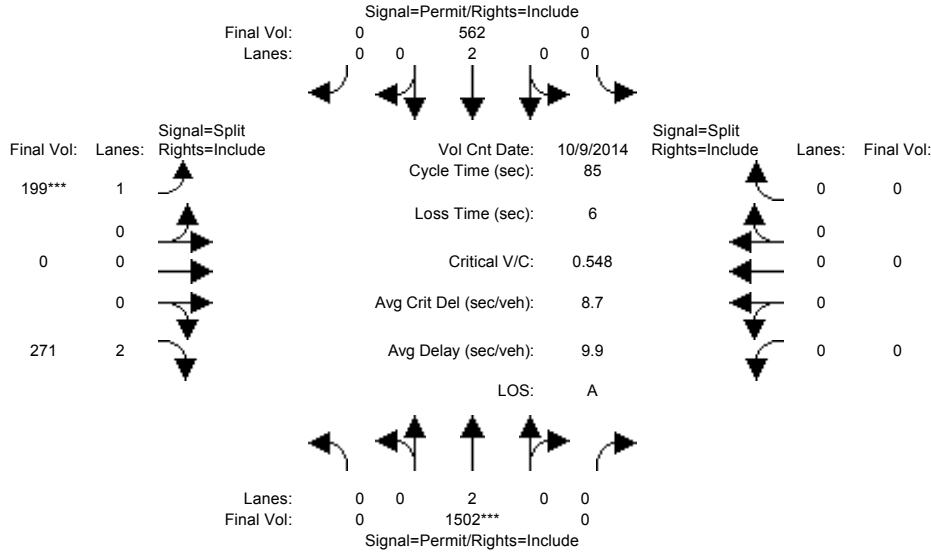

| Approach:                     | North Bound   |      |      | South Bound |      |      | East Bound |      |      | West Bound |      |      |
|-------------------------------|---------------|------|------|-------------|------|------|------------|------|------|------------|------|------|
| Movement:                     | L             | T    | R    | L           | T    | R    | L          | T    | R    | L          | T    | R    |
| Min. Green:                   | 0             | 10   | 0    | 0           | 10   | 0    | 10         | 0    | 10   | 0          | 0    | 0    |
| Y+R:                          | 4.0           | 4.0  | 4.0  | 4.0         | 4.0  | 4.0  | 4.0        | 4.0  | 4.0  | 4.0        | 4.0  | 4.0  |
| -----                         |               |      |      |             |      |      |            |      |      |            |      |      |
| Volume Module: >> Count Date: | 9 Oct 2014 << |      |      |             |      |      |            |      |      |            |      |      |
| Base Vol:                     | 0             | 1502 | 0    | 0           | 562  | 0    | 199        | 0    | 271  | 0          | 0    | 0    |
| Growth Adj:                   | 1.00          | 1.00 | 1.00 | 1.00        | 1.00 | 1.00 | 1.00       | 1.00 | 1.00 | 1.00       | 1.00 | 1.00 |
| Initial Bse:                  | 0             | 1502 | 0    | 0           | 562  | 0    | 199        | 0    | 271  | 0          | 0    | 0    |
| Added Vol:                    | 0             | 0    | 0    | 0           | 0    | 0    | 0          | 0    | 0    | 0          | 0    | 0    |
| PasserByVol:                  | 0             | 0    | 0    | 0           | 0    | 0    | 0          | 0    | 0    | 0          | 0    | 0    |
| Initial Fut:                  | 0             | 1502 | 0    | 0           | 562  | 0    | 199        | 0    | 271  | 0          | 0    | 0    |
| User Adj:                     | 1.00          | 1.00 | 1.00 | 1.00        | 1.00 | 1.00 | 1.00       | 1.00 | 1.00 | 1.00       | 1.00 | 1.00 |
| PHF Adj:                      | 1.00          | 1.00 | 1.00 | 1.00        | 1.00 | 1.00 | 1.00       | 1.00 | 1.00 | 1.00       | 1.00 | 1.00 |
| PHF Volume:                   | 0             | 1502 | 0    | 0           | 562  | 0    | 199        | 0    | 271  | 0          | 0    | 0    |
| Reduct Vol:                   | 0             | 0    | 0    | 0           | 0    | 0    | 0          | 0    | 0    | 0          | 0    | 0    |
| Reduced Vol:                  | 0             | 1502 | 0    | 0           | 562  | 0    | 199        | 0    | 271  | 0          | 0    | 0    |
| PCE Adj:                      | 1.00          | 1.00 | 1.00 | 1.00        | 1.00 | 1.00 | 1.00       | 1.00 | 1.00 | 1.00       | 1.00 | 1.00 |
| MLF Adj:                      | 1.00          | 1.00 | 1.00 | 1.00        | 1.00 | 1.00 | 1.00       | 1.00 | 1.00 | 1.00       | 1.00 | 1.00 |
| FinalVolume:                  | 0             | 1502 | 0    | 0           | 562  | 0    | 199        | 0    | 271  | 0          | 0    | 0    |
| -----                         |               |      |      |             |      |      |            |      |      |            |      |      |
| Saturation Flow Module:       |               |      |      |             |      |      |            |      |      |            |      |      |
| Sat/Lane:                     | 1900          | 1900 | 1900 | 1900        | 1900 | 1900 | 1900       | 1900 | 1900 | 1900       | 1900 | 1900 |
| Adjustment:                   | 0.92          | 1.00 | 0.92 | 0.92        | 1.00 | 0.92 | 0.92       | 1.00 | 0.83 | 0.92       | 1.00 | 0.92 |
| Lanes:                        | 0.00          | 2.00 | 0.00 | 0.00        | 2.00 | 0.00 | 1.00       | 0.00 | 2.00 | 0.00       | 0.00 | 0.00 |
| Final Sat.:                   | 0             | 3800 | 0    | 0           | 3800 | 0    | 1750       | 0    | 3150 | 0          | 0    | 0    |
| -----                         |               |      |      |             |      |      |            |      |      |            |      |      |
| Capacity Analysis Module:     |               |      |      |             |      |      |            |      |      |            |      |      |
| Vol/Sat:                      | 0.00          | 0.40 | 0.00 | 0.00        | 0.15 | 0.00 | 0.11       | 0.00 | 0.09 | 0.00       | 0.00 | 0.00 |
| Crit Moves:                   | *****         |      |      |             |      |      |            |      |      |            |      |      |
| Green Time:                   | 0.0           | 61.4 | 0.0  | 0.0         | 61.4 | 0.0  | 17.6       | 0.0  | 17.6 | 0.0        | 0.0  | 0.0  |
| Volume/Cap:                   | 0.00          | 0.55 | 0.00 | 0.00        | 0.20 | 0.00 | 0.55       | 0.00 | 0.41 | 0.00       | 0.00 | 0.00 |
| Delay/Veh:                    | 0.0           | 5.7  | 0.0  | 0.0         | 3.9  | 0.0  | 31.9       | 0.0  | 29.6 | 0.0        | 0.0  | 0.0  |
| User DelAdj:                  | 1.00          | 1.00 | 1.00 | 1.00        | 1.00 | 1.00 | 1.00       | 1.00 | 1.00 | 1.00       | 1.00 | 1.00 |
| AdjDel/Veh:                   | 0.0           | 5.7  | 0.0  | 0.0         | 3.9  | 0.0  | 31.9       | 0.0  | 29.6 | 0.0        | 0.0  | 0.0  |
| LOS by Move:                  | A             | A    | A    | A           | A    | A    | C          | A    | C    | A          | A    | A    |
| HCM2k95thQ:                   | 0             | 17   | 0    | 0           | 5    | 0    | 11         | 0    | 8    | 0          | 0    | 0    |

Note: Queue reported is the number of cars per lane.

BART

Level Of Service Computation Report  
2000 HCM Operations (Future Volume Alternative)  
PM - Background Conditions

Intersection #3036: 280/MCLAUGHLIN [Study Int 25]

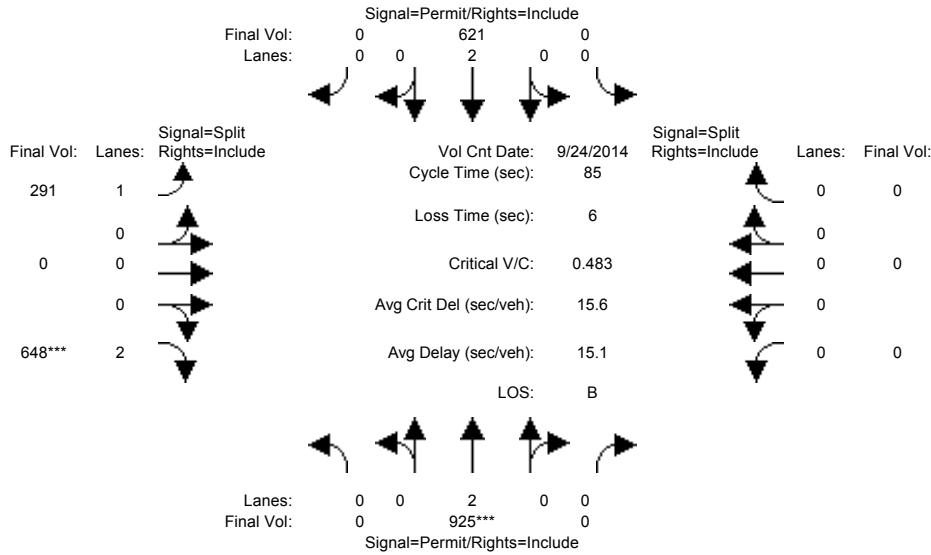

| Approach:                                    | North Bound |      |      | South Bound |      |      | East Bound |      |      | West Bound |      |      |
|--|-------------|------|------|-------------|------|------|------------|------|------|------------|------|------|
| Movement:                                    | L           | T    | R    | L           | T    | R    | L          | T    | R    | L          | T    | R    |
| Min. Green:                                  | 0           | 10   | 0    | 0           | 10   | 0    | 10         | 0    | 10   | 0          | 0    | 0    |
| Y+R:   | 4.0         | 4.0  | 4.0  | 4.0         | 4.0  | 4.0  | 4.0        | 4.0  | 4.0  | 4.0        | 4.0  | 4.0  |
| Volume Module: >> Count Date: 24 Sep 2014 << |             |      |      |             |      |      |            |      |      |            |      |      |
| Base Vol:                                    | 0           | 925  | 0    | 0           | 621  | 0    | 291        | 0    | 648  | 0          | 0    | 0    |
| Growth Adj:                                  | 1.00        | 1.00 | 1.00 | 1.00        | 1.00 | 1.00 | 1.00       | 1.00 | 1.00 | 1.00       | 1.00 | 1.00 |
| Initial Bse:                                 | 0           | 925  | 0    | 0           | 621  | 0    | 291        | 0    | 648  | 0          | 0    | 0    |
| Added Vol:                                   | 0           | 0    | 0    | 0           | 0    | 0    | 0          | 0    | 0    | 0          | 0    | 0    |
| PasserByVol:                                 | 0           | 0    | 0    | 0           | 0    | 0    | 0          | 0    | 0    | 0          | 0    | 0    |
| Initial Fut:                                 | 0           | 925  | 0    | 0           | 621  | 0    | 291        | 0    | 648  | 0          | 0    | 0    |
| User Adj:                                    | 1.00        | 1.00 | 1.00 | 1.00        | 1.00 | 1.00 | 1.00       | 1.00 | 1.00 | 1.00       | 1.00 | 1.00 |
| PHF Adj:                                     | 1.00        | 1.00 | 1.00 | 1.00        | 1.00 | 1.00 | 1.00       | 1.00 | 1.00 | 1.00       | 1.00 | 1.00 |
| PHF Volume:                                  | 0           | 925  | 0    | 0           | 621  | 0    | 291        | 0    | 648  | 0          | 0    | 0    |
| Reduct Vol:                                  | 0           | 0    | 0    | 0           | 0    | 0    | 0          | 0    | 0    | 0          | 0    | 0    |
| Reduced Vol:                                 | 0           | 925  | 0    | 0           | 621  | 0    | 291        | 0    | 648  | 0          | 0    | 0    |
| PCE Adj:                                     | 1.00        | 1.00 | 1.00 | 1.00        | 1.00 | 1.00 | 1.00       | 1.00 | 1.00 | 1.00       | 1.00 | 1.00 |
| MLF Adj:                                     | 1.00        | 1.00 | 1.00 | 1.00        | 1.00 | 1.00 | 1.00       | 1.00 | 1.00 | 1.00       | 1.00 | 1.00 |
| Final Volume:                                | 0           | 925  | 0    | 0           | 621  | 0    | 291        | 0    | 648  | 0          | 0    | 0    |
| Saturation Flow Module:                      |             |      |      |             |      |      |            |      |      |            |      |      |
| Sat/Lane:                                    | 1900        | 1900 | 1900 | 1900        | 1900 | 1900 | 1900       | 1900 | 1900 | 1900       | 1900 | 1900 |
| Adjustment:                                  | 0.92        | 1.00 | 0.92 | 0.92        | 1.00 | 0.92 | 0.92       | 1.00 | 0.83 | 0.92       | 1.00 | 0.92 |
| Lanes:                                       | 0.00        | 2.00 | 0.00 | 0.00        | 2.00 | 0.00 | 1.00       | 0.00 | 2.00 | 0.00       | 0.00 | 0.00 |
| Final Sat.:                                  | 0           | 3800 | 0    | 0           | 3800 | 0    | 1750       | 0    | 3150 | 0          | 0    | 0    |
| Capacity Analysis Module:                    |             |      |      |             |      |      |            |      |      |            |      |      |
| Vol/Sat:                                     | 0.00        | 0.24 | 0.00 | 0.00        | 0.16 | 0.00 | 0.17       | 0.00 | 0.21 | 0.00       | 0.00 | 0.00 |
| Crit Moves:                                  | ****        |      |      | ****        |      |      | ****       |      |      | ****       |      |      |
| Green Time:                                  | 0.0         | 42.8 | 0.0  | 0.0         | 42.8 | 0.0  | 36.2       | 0.0  | 36.2 | 0.0        | 0.0  | 0.0  |
| Volume/Cap:                                  | 0.00        | 0.48 | 0.00 | 0.00        | 0.32 | 0.00 | 0.39       | 0.00 | 0.48 | 0.00       | 0.00 | 0.00 |
| Delay/Veh:                                   | 0.0         | 14.0 | 0.0  | 0.0         | 12.6 | 0.0  | 17.2       | 0.0  | 17.9 | 0.0        | 0.0  | 0.0  |
| User DelAdj:                                 | 1.00        | 1.00 | 1.00 | 1.00        | 1.00 | 1.00 | 1.00       | 1.00 | 1.00 | 1.00       | 1.00 | 1.00 |
| AdjDel/Veh:                                  | 0.0         | 14.0 | 0.0  | 0.0         | 12.6 | 0.0  | 17.2       | 0.0  | 17.9 | 0.0        | 0.0  | 0.0  |
| LOS by Move:                                 | A           | B    | A    | A           | B    | A    | B          | A    | B    | A          | A    | A    |
| HCM2k95thQ:                                  | 0           | 15   | 0    | 0           | 9    | 0    | 11         | 0    | 14   | 0          | 0    | 0    |

Note: Queue reported is the number of cars per lane.

BART

Level Of Service Computation Report  
 2000 HCM Operations (Future Volume Alternative)  
 AM - Background Conditions

Intersection #3042: 680N/ALUM ROCK (E) [Study Int 20]

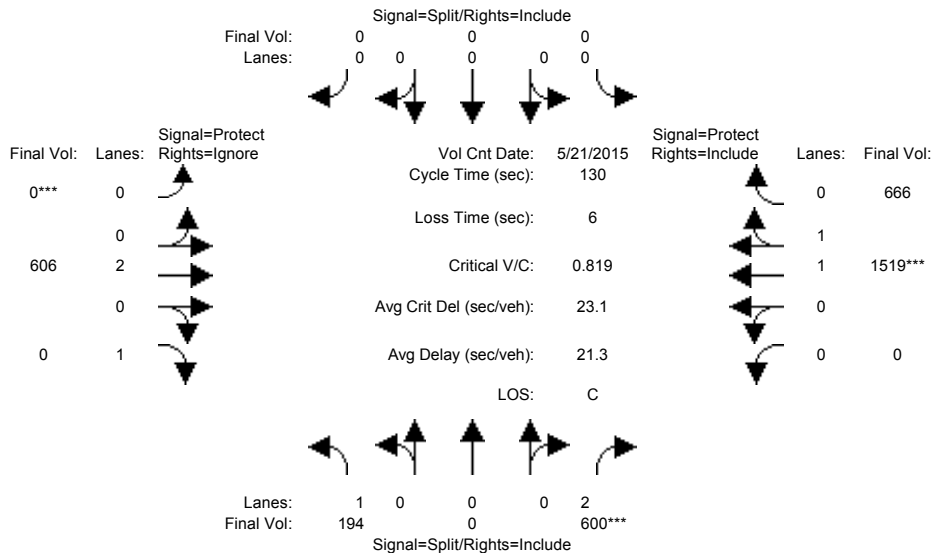

| Approach:  | North Bound |      |      | South Bound |      |      | East Bound |      |      | West Bound |      |      |
|--|-------------|------|------|-------------|------|------|------------|------|------|------------|------|------|
| Movement:  | L           | T    | R    | L           | T    | R    | L          | T    | R    | L          | T    | R    |
| Min. Green:  | 10          | 0    | 10   | 0           | 0    | 0    | 0          | 10   | 10   | 0          | 10   | 10   |
| Y+R:   | 4.0         | 4.0  | 4.0  | 4.0         | 4.0  | 4.0  | 4.0        | 4.0  | 4.0  | 4.0        | 4.0  | 4.0  |
| Volume Module: >> Count Date: 21 May 2015 << 7:30-8:30AM |             |      |      |             |      |      |            |      |      |            |      |      |
| Base Vol:  | 194         | 0    | 600  | 0           | 0    | 0    | 0          | 606  | 361  | 0          | 1519 | 666  |
| Growth Adj:  | 1.00        | 1.00 | 1.00 | 1.00        | 1.00 | 1.00 | 1.00       | 1.00 | 1.00 | 1.00       | 1.00 | 1.00 |
| Initial Bse:   | 194         | 0    | 600  | 0           | 0    | 0    | 0          | 606  | 361  | 0          | 1519 | 666  |
| Added Vol:   | 0           | 0    | 0    | 0           | 0    | 0    | 0          | 0    | 0    | 0          | 0    | 0    |
| PasserByVol:   | 0           | 0    | 0    | 0           | 0    | 0    | 0          | 0    | 0    | 0          | 0    | 0    |
| Initial Fut:   | 194         | 0    | 600  | 0           | 0    | 0    | 0          | 606  | 361  | 0          | 1519 | 666  |
| User Adj:  | 1.00        | 1.00 | 1.00 | 1.00        | 1.00 | 1.00 | 1.00       | 1.00 | 0.00 | 1.00       | 1.00 | 1.00 |
| PHF Adj:   | 1.00        | 1.00 | 1.00 | 1.00        | 1.00 | 1.00 | 1.00       | 1.00 | 0.00 | 1.00       | 1.00 | 1.00 |
| PHF Volume:  | 194         | 0    | 600  | 0           | 0    | 0    | 0          | 606  | 0    | 0          | 1519 | 666  |
| Reduct Vol:  | 0           | 0    | 0    | 0           | 0    | 0    | 0          | 0    | 0    | 0          | 0    | 0    |
| Reduced Vol:   | 194         | 0    | 600  | 0           | 0    | 0    | 0          | 606  | 0    | 0          | 1519 | 666  |
| PCE Adj:   | 1.00        | 1.00 | 1.00 | 1.00        | 1.00 | 1.00 | 1.00       | 1.00 | 0.00 | 1.00       | 1.00 | 1.00 |
| MLF Adj:   | 1.00        | 1.00 | 1.00 | 1.00        | 1.00 | 1.00 | 1.00       | 1.00 | 0.00 | 1.00       | 1.00 | 1.00 |
| Final Volume:  | 194         | 0    | 600  | 0           | 0    | 0    | 0          | 606  | 0    | 0          | 1519 | 666  |
| Saturation Flow Module:                                  |             |      |      |             |      |      |            |      |      |            |      |      |
| Sat/Lane:  | 1900        | 1900 | 1900 | 1900        | 1900 | 1900 | 1900       | 1900 | 1900 | 1900       | 1900 | 1900 |
| Adjustment:  | 0.92        | 1.00 | 0.83 | 0.92        | 1.00 | 0.92 | 0.92       | 1.00 | 0.92 | 0.92       | 0.99 | 0.95 |
| Lanes:   | 1.00        | 0.00 | 2.00 | 0.00        | 0.00 | 0.00 | 0.00       | 2.00 | 1.00 | 0.00       | 1.37 | 0.63 |
| Final Sat.:  | 1750        | 0    | 3150 | 0           | 0    | 0    | 0          | 3800 | 1750 | 0          | 2571 | 1127 |
| Capacity Analysis Module:                                |             |      |      |             |      |      |            |      |      |            |      |      |
| Vol/Sat:   | 0.11        | 0.00 | 0.19 | 0.00        | 0.00 | 0.00 | 0.00       | 0.16 | 0.00 | 0.00       | 0.59 | 0.59 |
| Crit Moves:  | ****        |      |      | ****        |      |      | ****       |      |      | ****       |      |      |
| Green Time:  | 30.2        | 0.0  | 30.2 | 0.0         | 0.0  | 0.0  | 0.0        | 93.8 | 0.0  | 0.0        | 93.8 | 93.8 |
| Volume/Cap:  | 0.48        | 0.00 | 0.82 | 0.00        | 0.00 | 0.00 | 0.00       | 0.22 | 0.00 | 0.00       | 0.82 | 0.82 |
| Delay/Veh:   | 43.9        | 0.0  | 54.5 | 0.0         | 0.0  | 0.0  | 0.0        | 6.0  | 0.0  | 0.0        | 14.5 | 14.5 |
| User DelAdj:   | 1.00        | 1.00 | 1.00 | 1.00        | 1.00 | 1.00 | 1.00       | 1.00 | 1.00 | 1.00       | 1.00 | 1.00 |
| AdjDel/Veh:  | 43.9        | 0.0  | 54.5 | 0.0         | 0.0  | 0.0  | 0.0        | 6.0  | 0.0  | 0.0        | 14.5 | 14.5 |
| LOS by Move:   | D           | A    | D    | A           | A    | A    | A          | A    | A    | A          | B    | B    |
| HCM2k95thQ:  | 14          | 0    | 28   | 0           | 0    | 0    | 0          | 8    | 0    | 0          | 51   | 51   |

Note: Queue reported is the number of cars per lane.

BART

Level Of Service Computation Report  
2000 HCM Operations (Future Volume Alternative)  
PM - Background Conditions

Intersection #3042: 680N/ALUM ROCK (E) [Study Int 20]

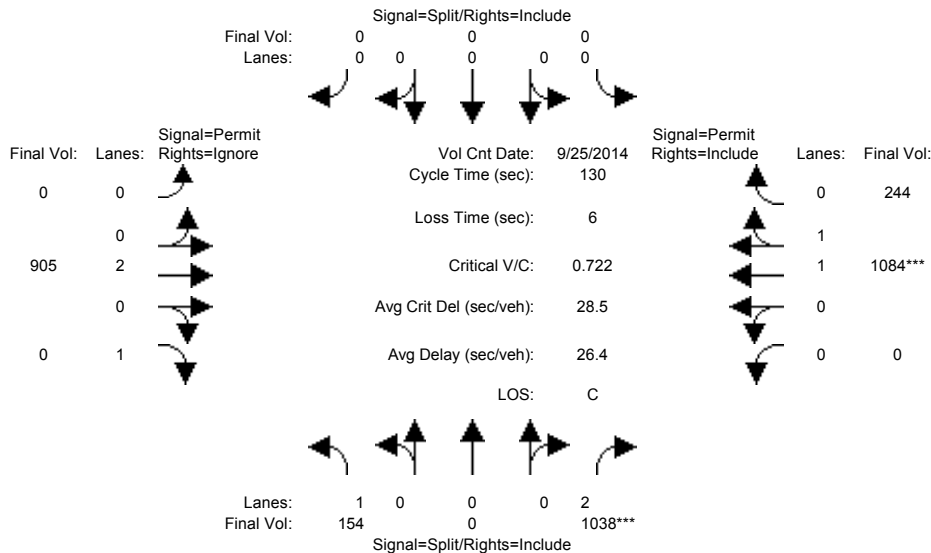

| Approach:  | North Bound |      |      | South Bound |      |      | East Bound |      |      | West Bound |      |      |
|--|-------------|------|------|-------------|------|------|------------|------|------|------------|------|------|
| Movement:  | L           | T    | R    | L           | T    | R    | L          | T    | R    | L          | T    | R    |
| Min. Green:  | 10          | 0    | 10   | 0           | 0    | 0    | 0          | 10   | 10   | 0          | 10   | 10   |
| Y+R:   | 4.0         | 4.0  | 4.0  | 4.0         | 4.0  | 4.0  | 4.0        | 4.0  | 4.0  | 4.0        | 4.0  | 4.0  |
| Volume Module: >> Count Date: 25 Sep 2014 << 4:45-5:45PM |             |      |      |             |      |      |            |      |      |            |      |      |
| Base Vol:  | 154         | 0    | 1038 | 0           | 0    | 0    | 0          | 905  | 8    | 0          | 1084 | 244  |
| Growth Adj:  | 1.00        | 1.00 | 1.00 | 1.00        | 1.00 | 1.00 | 1.00       | 1.00 | 1.00 | 1.00       | 1.00 | 1.00 |
| Initial Bse:   | 154         | 0    | 1038 | 0           | 0    | 0    | 0          | 905  | 8    | 0          | 1084 | 244  |
| Added Vol:   | 0           | 0    | 0    | 0           | 0    | 0    | 0          | 0    | 0    | 0          | 0    | 0    |
| PasserByVol:   | 0           | 0    | 0    | 0           | 0    | 0    | 0          | 0    | 0    | 0          | 0    | 0    |
| Initial Fut:   | 154         | 0    | 1038 | 0           | 0    | 0    | 0          | 905  | 8    | 0          | 1084 | 244  |
| User Adj:  | 1.00        | 1.00 | 1.00 | 1.00        | 1.00 | 1.00 | 1.00       | 1.00 | 0.00 | 1.00       | 1.00 | 1.00 |
| PHF Adj:   | 1.00        | 1.00 | 1.00 | 1.00        | 1.00 | 1.00 | 1.00       | 1.00 | 0.00 | 1.00       | 1.00 | 1.00 |
| PHF Volume:  | 154         | 0    | 1038 | 0           | 0    | 0    | 0          | 905  | 0    | 0          | 1084 | 244  |
| Reduct Vol:  | 0           | 0    | 0    | 0           | 0    | 0    | 0          | 0    | 0    | 0          | 0    | 0    |
| Reduced Vol:   | 154         | 0    | 1038 | 0           | 0    | 0    | 0          | 905  | 0    | 0          | 1084 | 244  |
| PCE Adj:   | 1.00        | 1.00 | 1.00 | 1.00        | 1.00 | 1.00 | 1.00       | 1.00 | 0.00 | 1.00       | 1.00 | 1.00 |
| MLF Adj:   | 1.00        | 1.00 | 1.00 | 1.00        | 1.00 | 1.00 | 1.00       | 1.00 | 0.00 | 1.00       | 1.00 | 1.00 |
| Final Volume:  | 154         | 0    | 1038 | 0           | 0    | 0    | 0          | 905  | 0    | 0          | 1084 | 244  |
| Saturation Flow Module:                                  |             |      |      |             |      |      |            |      |      |            |      |      |
| Sat/Lane:  | 1900        | 1900 | 1900 | 1900        | 1900 | 1900 | 1900       | 1900 | 1900 | 1900       | 1900 | 1900 |
| Adjustment:  | 0.92        | 1.00 | 0.83 | 0.92        | 1.00 | 0.92 | 0.92       | 1.00 | 0.92 | 0.92       | 0.98 | 0.95 |
| Lanes:   | 1.00        | 0.00 | 2.00 | 0.00        | 0.00 | 0.00 | 0.00       | 2.00 | 1.00 | 0.00       | 1.62 | 0.38 |
| Final Sat.:  | 1750        | 0    | 3150 | 0           | 0    | 0    | 0          | 3800 | 1750 | 0          | 3020 | 680  |
| Capacity Analysis Module:                                |             |      |      |             |      |      |            |      |      |            |      |      |
| Vol/Sat:   | 0.09        | 0.00 | 0.33 | 0.00        | 0.00 | 0.00 | 0.00       | 0.24 | 0.00 | 0.00       | 0.36 | 0.36 |
| Crit Moves:  | ****        |      |      |             |      |      |            |      |      |            |      |      |
| Green Time:  | 59.3        | 0.0  | 59.3 | 0.0         | 0.0  | 0.0  | 0.0        | 64.7 | 0.0  | 0.0        | 64.7 | 64.7 |
| Volume/Cap:  | 0.19        | 0.00 | 0.72 | 0.00        | 0.00 | 0.00 | 0.00       | 0.48 | 0.00 | 0.00       | 0.72 | 0.72 |
| Delay/Veh:   | 21.2        | 0.0  | 30.5 | 0.0         | 0.0  | 0.0  | 0.0        | 21.8 | 0.0  | 0.0        | 27.1 | 27.1 |
| User DelAdj:   | 1.00        | 1.00 | 1.00 | 1.00        | 1.00 | 1.00 | 1.00       | 1.00 | 1.00 | 1.00       | 1.00 | 1.00 |
| AdjDel/Veh:  | 21.2        | 0.0  | 30.5 | 0.0         | 0.0  | 0.0  | 0.0        | 21.8 | 0.0  | 0.0        | 27.1 | 27.1 |
| LOS by Move:   | C           | A    | C    | A           | A    | A    | A          | C    | A    | A          | C    | C    |
| HCM2k95thQ:  | 8           | 0    | 35   | 0           | 0    | 0    | 0          | 21   | 0    | 0          | 36   | 36   |

Note: Queue reported is the number of cars per lane.

BART

Level Of Service Computation Report  
2000 HCM Operations (Future Volume Alternative)  
AM - Background Conditions

Intersection #3043: 680S/ALUM ROCK (W) [Study Int 19]

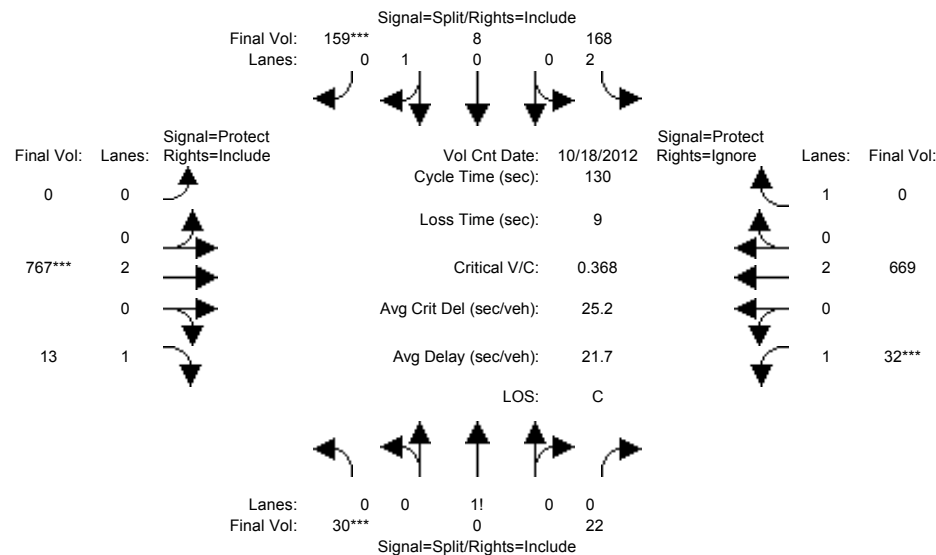

| Approach:                     | North Bound                |      |      | South Bound |      |      | East Bound |      |      | West Bound |      |      |
|-------------------------------|----------------------------|------|------|-------------|------|------|------------|------|------|------------|------|------|
| Movement:                     | L                          | T    | R    | L           | T    | R    | L          | T    | R    | L          | T    | R    |
| Min. Green:                   | 10                         | 0    | 10   | 10          | 10   | 10   | 0          | 10   | 10   | 10         | 10   | 10   |
| Y+R:                          | 4.0                        | 4.0  | 4.0  | 4.0         | 4.0  | 4.0  | 4.0        | 4.0  | 4.0  | 4.0        | 4.0  | 4.0  |
| -----                         |                            |      |      |             |      |      |            |      |      |            |      |      |
| Volume Module: >> Count Date: | 18 Oct 2012 << 7:15-8:15AM |      |      |             |      |      |            |      |      |            |      |      |
| Base Vol:                     | 30                         | 0    | 22   | 168         | 8    | 159  | 0          | 767  | 13   | 32         | 669  | 0    |
| Growth Adj:                   | 1.00                       | 1.00 | 1.00 | 1.00        | 1.00 | 1.00 | 1.00       | 1.00 | 1.00 | 1.00       | 1.00 | 1.00 |
| Initial Bse:                  | 30                         | 0    | 22   | 168         | 8    | 159  | 0          | 767  | 13   | 32         | 669  | 0    |
| Added Vol:                    | 0                          | 0    | 0    | 0           | 0    | 0    | 0          | 0    | 0    | 0          | 0    | 0    |
| PasserByVol:                  | 0                          | 0    | 0    | 0           | 0    | 0    | 0          | 0    | 0    | 0          | 0    | 0    |
| Initial Fut:                  | 30                         | 0    | 22   | 168         | 8    | 159  | 0          | 767  | 13   | 32         | 669  | 0    |
| User Adj:                     | 1.00                       | 1.00 | 1.00 | 1.00        | 1.00 | 1.00 | 1.00       | 1.00 | 1.00 | 1.00       | 1.00 | 0.00 |
| PHF Adj:                      | 1.00                       | 1.00 | 1.00 | 1.00        | 1.00 | 1.00 | 1.00       | 1.00 | 1.00 | 1.00       | 1.00 | 0.00 |
| PHF Volume:                   | 30                         | 0    | 22   | 168         | 8    | 159  | 0          | 767  | 13   | 32         | 669  | 0    |
| Reduct Vol:                   | 0                          | 0    | 0    | 0           | 0    | 0    | 0          | 0    | 0    | 0          | 0    | 0    |
| Reduced Vol:                  | 30                         | 0    | 22   | 168         | 8    | 159  | 0          | 767  | 13   | 32         | 669  | 0    |
| PCE Adj:                      | 1.00                       | 1.00 | 1.00 | 1.00        | 1.00 | 1.00 | 1.00       | 1.00 | 1.00 | 1.00       | 1.00 | 0.00 |
| MLF Adj:                      | 1.00                       | 1.00 | 1.00 | 1.00        | 1.00 | 1.00 | 1.00       | 1.00 | 1.00 | 1.00       | 1.00 | 0.00 |
| Final Volume:                 | 30                         | 0    | 22   | 168         | 8    | 159  | 0          | 767  | 13   | 32         | 669  | 0    |
| -----                         |                            |      |      |             |      |      |            |      |      |            |      |      |
| Saturation Flow Module:       |                            |      |      |             |      |      |            |      |      |            |      |      |
| Sat/Lane:                     | 1900                       | 1900 | 1900 | 1900        | 1900 | 1900 | 1900       | 1900 | 1900 | 1900       | 1900 | 1900 |
| Adjustment:                   | 0.92                       | 0.92 | 0.92 | 0.83        | 0.95 | 0.95 | 0.92       | 1.00 | 0.92 | 0.92       | 1.00 | 0.92 |
| Lanes:                        | 0.58                       | 0.00 | 0.42 | 2.00        | 0.05 | 0.95 | 0.00       | 2.00 | 1.00 | 1.00       | 2.00 | 1.00 |
| Final Sat.:                   | 1010                       | 0    | 740  | 3150        | 86   | 1714 | 0          | 3800 | 1750 | 1750       | 3800 | 1750 |
| -----                         |                            |      |      |             |      |      |            |      |      |            |      |      |
| Capacity Analysis Module:     |                            |      |      |             |      |      |            |      |      |            |      |      |
| Vol/Sat:                      | 0.03                       | 0.00 | 0.03 | 0.05        | 0.09 | 0.09 | 0.00       | 0.20 | 0.01 | 0.02       | 0.18 | 0.00 |
| Crit Moves:                   | ****                       |      |      | ****        |      |      | ****       |      |      | ****       |      |      |
| Green Time:                   | 10.2                       | 0.0  | 10.2 | 31.8        | 31.8 | 31.8 | 0.0        | 69.1 | 69.1 | 10.0       | 79.1 | 0.0  |
| Volume/Cap:                   | 0.38                       | 0.00 | 0.38 | 0.22        | 0.38 | 0.38 | 0.00       | 0.38 | 0.01 | 0.24       | 0.29 | 0.00 |
| Delay/Veh:                    | 58.7                       | 0.0  | 58.7 | 39.4        | 41.5 | 41.5 | 0.0        | 18.0 | 14.4 | 57.3       | 12.2 | 0.0  |
| User DelAdj:                  | 1.00                       | 1.00 | 1.00 | 1.00        | 1.00 | 1.00 | 1.00       | 1.00 | 1.00 | 1.00       | 1.00 | 1.00 |
| AdjDel/Veh:                   | 58.7                       | 0.0  | 58.7 | 39.4        | 41.5 | 41.5 | 0.0        | 18.0 | 14.4 | 57.3       | 12.2 | 0.0  |
| LOS by Move:                  | E                          | A    | E    | D           | D    | D    | A          | B    | B    | E          | B    | A    |
| HCM2k95thQ:                   | 5                          | 0    | 5    | 6           | 11   | 11   | 0          | 16   | 1    | 3          | 12   | 0    |

Note: Queue reported is the number of cars per lane.

BART

Level Of Service Computation Report  
 2000 HCM Operations (Future Volume Alternative)  
 PM - Background Conditions

Intersection #3043: 680S/ALUM ROCK (W) [Study Int 19]

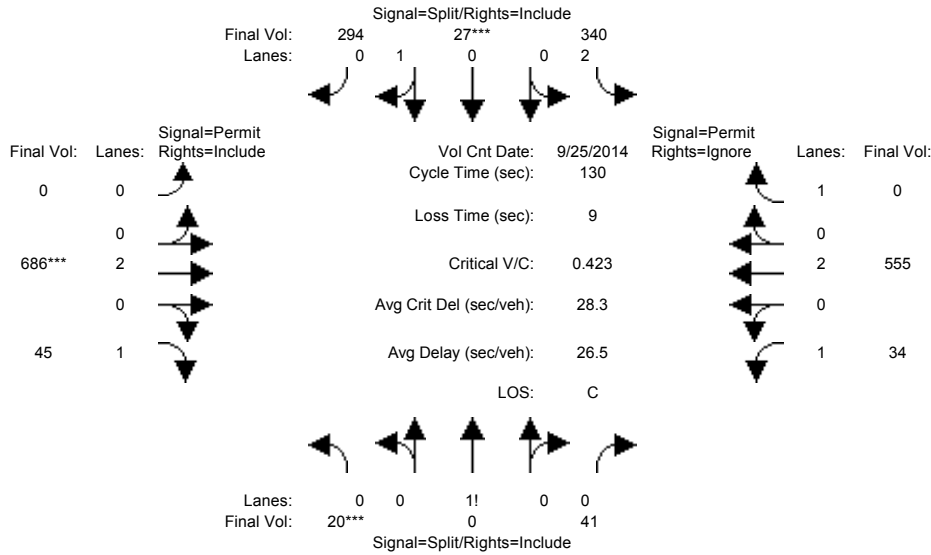

| Approach:  | North Bound |      |      | South Bound |      |      | East Bound |      |      | West Bound |      |      |
|--|-------------|------|------|-------------|------|------|------------|------|------|------------|------|------|
| Movement:  | L           | T    | R    | L           | T    | R    | L          | T    | R    | L          | T    | R    |
| Min. Green:  | 10          | 0    | 10   | 10          | 10   | 10   | 0          | 10   | 10   | 10         | 10   | 10   |
| Y+R:   | 4.0         | 4.0  | 4.0  | 4.0         | 4.0  | 4.0  | 4.0        | 4.0  | 4.0  | 4.0        | 4.0  | 4.0  |
| Volume Module: >> Count Date: 25 Sep 2014 << 4:15-5:15PM |             |      |      |             |      |      |            |      |      |            |      |      |
| Base Vol:  | 20          | 0    | 41   | 340         | 27   | 294  | 0          | 686  | 45   | 34         | 555  | 592  |
| Growth Adj:  | 1.00        | 1.00 | 1.00 | 1.00        | 1.00 | 1.00 | 1.00       | 1.00 | 1.00 | 1.00       | 1.00 | 1.00 |
| Initial Bse:   | 20          | 0    | 41   | 340         | 27   | 294  | 0          | 686  | 45   | 34         | 555  | 592  |
| Added Vol:   | 0           | 0    | 0    | 0           | 0    | 0    | 0          | 0    | 0    | 0          | 0    | 0    |
| PasserByVol:   | 0           | 0    | 0    | 0           | 0    | 0    | 0          | 0    | 0    | 0          | 0    | 0    |
| Initial Fut:   | 20          | 0    | 41   | 340         | 27   | 294  | 0          | 686  | 45   | 34         | 555  | 592  |
| User Adj:  | 1.00        | 1.00 | 1.00 | 1.00        | 1.00 | 1.00 | 1.00       | 1.00 | 1.00 | 1.00       | 1.00 | 0.00 |
| PHF Adj:   | 1.00        | 1.00 | 1.00 | 1.00        | 1.00 | 1.00 | 1.00       | 1.00 | 1.00 | 1.00       | 1.00 | 0.00 |
| PHF Volume:  | 20          | 0    | 41   | 340         | 27   | 294  | 0          | 686  | 45   | 34         | 555  | 0    |
| Reduct Vol:  | 0           | 0    | 0    | 0           | 0    | 0    | 0          | 0    | 0    | 0          | 0    | 0    |
| Reduced Vol:   | 20          | 0    | 41   | 340         | 27   | 294  | 0          | 686  | 45   | 34         | 555  | 0    |
| PCE Adj:   | 1.00        | 1.00 | 1.00 | 1.00        | 1.00 | 1.00 | 1.00       | 1.00 | 1.00 | 1.00       | 1.00 | 0.00 |
| MLF Adj:   | 1.00        | 1.00 | 1.00 | 1.00        | 1.00 | 1.00 | 1.00       | 1.00 | 1.00 | 1.00       | 1.00 | 0.00 |
| Final Volume:  | 20          | 0    | 41   | 340         | 27   | 294  | 0          | 686  | 45   | 34         | 555  | 0    |
| Saturation Flow Module:                                  |             |      |      |             |      |      |            |      |      |            |      |      |
| Sat/Lane:  | 1900        | 1900 | 1900 | 1900        | 1900 | 1900 | 1900       | 1900 | 1900 | 1900       | 1900 | 1900 |
| Adjustment:  | 0.92        | 0.92 | 0.92 | 0.83        | 0.95 | 0.95 | 0.92       | 1.00 | 0.92 | 0.92       | 1.00 | 0.92 |
| Lanes:   | 0.33        | 0.00 | 0.67 | 2.00        | 0.08 | 0.92 | 0.00       | 2.00 | 1.00 | 1.00       | 2.00 | 1.00 |
| Final Sat.:  | 574         | 0    | 1176 | 3150        | 151  | 1649 | 0          | 3800 | 1750 | 1750       | 3800 | 1750 |
| Capacity Analysis Module:                                |             |      |      |             |      |      |            |      |      |            |      |      |
| Vol/Sat:   | 0.03        | 0.00 | 0.03 | 0.11        | 0.18 | 0.18 | 0.00       | 0.18 | 0.03 | 0.02       | 0.15 | 0.00 |
| Crit Moves:  | ****        |      |      | ****        |      |      | ****       |      |      |            |      |      |
| Green Time:  | 10.7        | 0.0  | 10.7 | 54.8        | 54.8 | 54.8 | 0.0        | 55.5 | 55.5 | 55.5       | 55.5 | 0.0  |
| Volume/Cap:  | 0.42        | 0.00 | 0.42 | 0.26        | 0.42 | 0.42 | 0.00       | 0.42 | 0.06 | 0.05       | 0.34 | 0.00 |
| Delay/Veh:   | 58.7        | 0.0  | 58.7 | 24.5        | 26.8 | 26.8 | 0.0        | 26.2 | 22.0 | 21.8       | 25.1 | 0.0  |
| User DelAdj:   | 1.00        | 1.00 | 1.00 | 1.00        | 1.00 | 1.00 | 1.00       | 1.00 | 1.00 | 1.00       | 1.00 | 1.00 |
| AdjDel/Veh:  | 58.7        | 0.0  | 58.7 | 24.5        | 26.8 | 26.8 | 0.0        | 26.2 | 22.0 | 21.8       | 25.1 | 0.0  |
| LOS by Move:   | E           | A    | E    | C           | C    | C    | A          | C    | C    | C          | C    | A    |
| HCM2k95thQ:  | 6           | 0    | 6    | 10          | 17   | 17   | 0          | 17   | 2    | 2          | 14   | 0    |

Note: Queue reported is the number of cars per lane.

BART

Level Of Service Computation Report  
2000 HCM Operations (Future Volume Alternative)  
AM - Background Conditions

Intersection #3046: The Alameda/880 SB Ramps [Study Int 56]

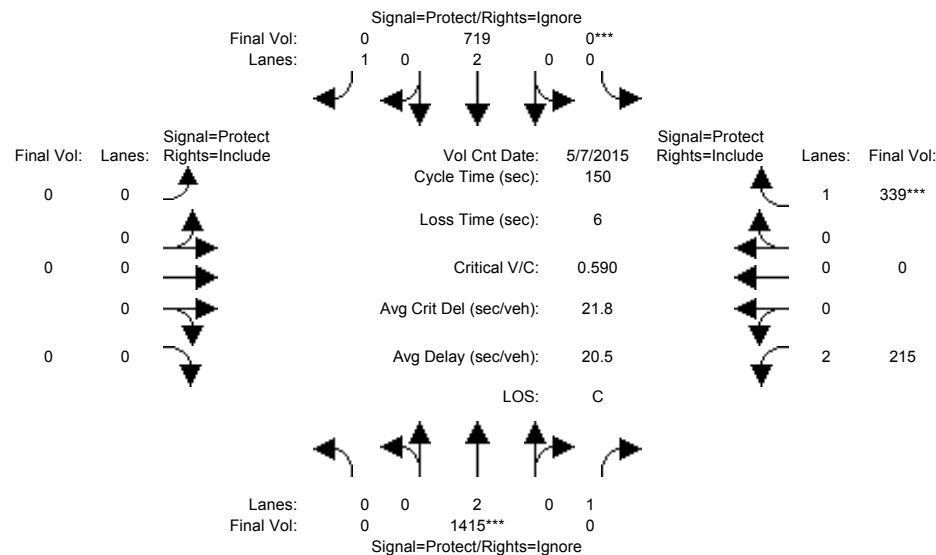

| Approach:   | North Bound |      |      | South Bound |      |      | East Bound |      |      | West Bound |      |      |
|---|-------------|------|------|-------------|------|------|------------|------|------|------------|------|------|
| Movement:   | L           | T    | R    | L           | T    | R    | L          | T    | R    | L          | T    | R    |
| Min. Green:   | 0           | 10   | 10   | 0           | 10   | 10   | 0          | 0    | 0    | 10         | 0    | 10   |
| Y+R:  | 4.0         | 4.0  | 4.0  | 4.0         | 4.0  | 4.0  | 4.0        | 4.0  | 4.0  | 4.0        | 4.0  | 4.0  |
| Volume Module: >> Count Date: 7 May 2015 << 7:35-8:35AM |             |      |      |             |      |      |            |      |      |            |      |      |
| Base Vol:   | 0           | 1415 | 313  | 0           | 719  | 193  | 0          | 0    | 0    | 215        | 0    | 339  |
| Growth Adj:   | 1.00        | 1.00 | 1.00 | 1.00        | 1.00 | 1.00 | 1.00       | 1.00 | 1.00 | 1.00       | 1.00 | 1.00 |
| Initial Bse:  | 0           | 1415 | 313  | 0           | 719  | 193  | 0          | 0    | 0    | 215        | 0    | 339  |
| Added Vol:  | 0           | 0    | 0    | 0           | 0    | 0    | 0          | 0    | 0    | 0          | 0    | 0    |
| PasserByVol:  | 0           | 0    | 0    | 0           | 0    | 0    | 0          | 0    | 0    | 0          | 0    | 0    |
| Initial Fut:  | 0           | 1415 | 313  | 0           | 719  | 193  | 0          | 0    | 0    | 215        | 0    | 339  |
| User Adj:   | 1.00        | 1.00 | 0.00 | 1.00        | 1.00 | 0.00 | 1.00       | 1.00 | 1.00 | 1.00       | 1.00 | 1.00 |
| PHF Adj:  | 1.00        | 1.00 | 0.00 | 1.00        | 1.00 | 0.00 | 1.00       | 1.00 | 1.00 | 1.00       | 1.00 | 1.00 |
| PHF Volume:   | 0           | 1415 | 0    | 0           | 719  | 0    | 0          | 0    | 0    | 215        | 0    | 339  |
| Reduct Vol:   | 0           | 0    | 0    | 0           | 0    | 0    | 0          | 0    | 0    | 0          | 0    | 0    |
| Reduced Vol:  | 0           | 1415 | 0    | 0           | 719  | 0    | 0          | 0    | 0    | 215        | 0    | 339  |
| PCE Adj:  | 1.00        | 1.00 | 0.00 | 1.00        | 1.00 | 0.00 | 1.00       | 1.00 | 1.00 | 1.00       | 1.00 | 1.00 |
| MLF Adj:  | 1.00        | 1.00 | 0.00 | 1.00        | 1.00 | 0.00 | 1.00       | 1.00 | 1.00 | 1.00       | 1.00 | 1.00 |
| Final Volume:   | 0           | 1415 | 0    | 0           | 719  | 0    | 0          | 0    | 0    | 215        | 0    | 339  |
| Saturation Flow Module:                                 |             |      |      |             |      |      |            |      |      |            |      |      |
| Sat/Lane:   | 1900        | 1900 | 1900 | 1900        | 1900 | 1900 | 1900       | 1900 | 1900 | 1900       | 1900 | 1900 |
| Adjustment:   | 0.92        | 1.00 | 0.92 | 0.92        | 1.00 | 0.92 | 0.92       | 1.00 | 0.92 | 0.83       | 1.00 | 0.92 |
| Lanes:  | 0.00        | 2.00 | 1.00 | 0.00        | 2.00 | 1.00 | 0.00       | 0.00 | 0.00 | 2.00       | 0.00 | 1.00 |
| Final Sat.:   | 0           | 3800 | 1750 | 0           | 3800 | 1750 | 0          | 0    | 0    | 3150       | 0    | 1750 |
| Capacity Analysis Module:                               |             |      |      |             |      |      |            |      |      |            |      |      |
| Vol/Sat:  | 0.00        | 0.37 | 0.00 | 0.00        | 0.19 | 0.00 | 0.00       | 0.00 | 0.00 | 0.07       | 0.00 | 0.19 |
| Crit Moves:   | ****        |      |      | ****        |      |      | ****       |      |      | ****       |      |      |
| Green Time:   | 0.0         | 94.7 | 0.0  | 0.0         | 94.7 | 0.0  | 0.0        | 0.0  | 0.0  | 49.3       | 0.0  | 49.3 |
| Volume/Cap:   | 0.00        | 0.59 | 0.00 | 0.00        | 0.30 | 0.00 | 0.00       | 0.00 | 0.00 | 0.21       | 0.00 | 0.59 |
| Delay/Veh:  | 0.0         | 16.6 | 0.0  | 0.0         | 12.6 | 0.0  | 0.0        | 0.0  | 0.0  | 36.4       | 0.0  | 43.6 |
| User DelAdj:  | 1.00        | 1.00 | 1.00 | 1.00        | 1.00 | 1.00 | 1.00       | 1.00 | 1.00 | 1.00       | 1.00 | 1.00 |
| AdjDel/Veh:   | 0.0         | 16.6 | 0.0  | 0.0         | 12.6 | 0.0  | 0.0        | 0.0  | 0.0  | 36.4       | 0.0  | 43.6 |
| LOS by Move:  | A           | B    | A    | A           | B    | A    | A          | A    | A    | D          | A    | D    |
| HCM2k95thQ:   | 0           | 32   | 0    | 0           | 14   | 0    | 0          | 0    | 0    | 8          | 0    | 25   |

Note: Queue reported is the number of cars per lane.



BART

Level Of Service Computation Report  
 2000 HCM Operations (Future Volume Alternative)  
 PM - Background Conditions

Intersection #3046: The Alameda/880 SB Ramps [Study Int 56]

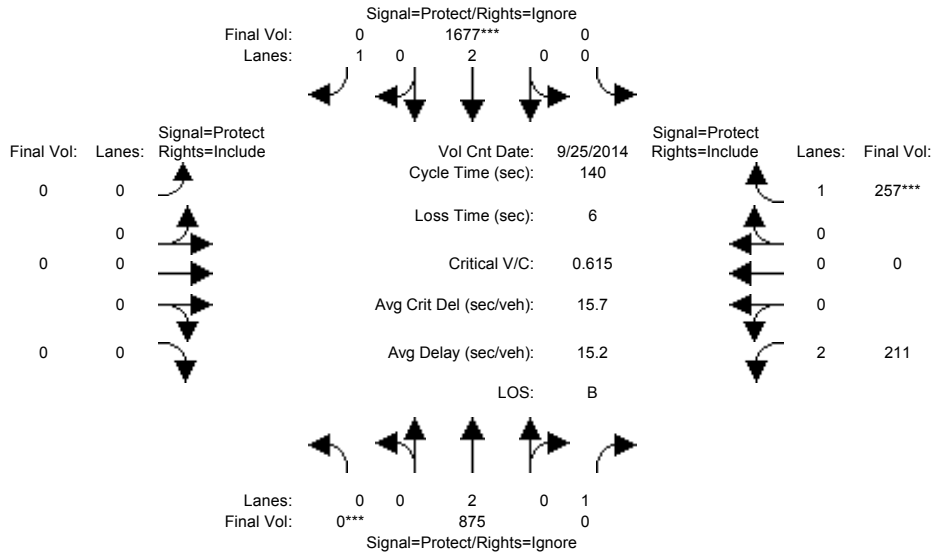

| Approach:  | North Bound |      |      | South Bound |      |      | East Bound |      |      | West Bound |      |      |
|--|-------------|------|------|-------------|------|------|------------|------|------|------------|------|------|
| Movement:  | L           | T    | R    | L           | T    | R    | L          | T    | R    | L          | T    | R    |
| Min. Green:  | 0           | 10   | 10   | 0           | 10   | 10   | 0          | 0    | 0    | 10         | 0    | 10   |
| Y+R:   | 4.0         | 4.0  | 4.0  | 4.0         | 4.0  | 4.0  | 4.0        | 4.0  | 4.0  | 4.0        | 4.0  | 4.0  |
| Volume Module: >> Count Date: 25 Sep 2014 << 4:45-5:00PM |             |      |      |             |      |      |            |      |      |            |      |      |
| Base Vol:  | 0           | 875  | 394  | 0           | 1677 | 362  | 0          | 0    | 0    | 211        | 0    | 257  |
| Growth Adj:  | 1.00        | 1.00 | 1.00 | 1.00        | 1.00 | 1.00 | 1.00       | 1.00 | 1.00 | 1.00       | 1.00 | 1.00 |
| Initial Bse:   | 0           | 875  | 394  | 0           | 1677 | 362  | 0          | 0    | 0    | 211        | 0    | 257  |
| Added Vol:   | 0           | 0    | 0    | 0           | 0    | 0    | 0          | 0    | 0    | 0          | 0    | 0    |
| PasserByVol:   | 0           | 0    | 0    | 0           | 0    | 0    | 0          | 0    | 0    | 0          | 0    | 0    |
| Initial Fut:   | 0           | 875  | 394  | 0           | 1677 | 362  | 0          | 0    | 0    | 211        | 0    | 257  |
| User Adj:  | 1.00        | 1.00 | 0.00 | 1.00        | 1.00 | 0.00 | 1.00       | 1.00 | 1.00 | 1.00       | 1.00 | 1.00 |
| PHF Adj:   | 1.00        | 1.00 | 0.00 | 1.00        | 1.00 | 0.00 | 1.00       | 1.00 | 1.00 | 1.00       | 1.00 | 1.00 |
| PHF Volume:  | 0           | 875  | 0    | 0           | 1677 | 0    | 0          | 0    | 0    | 211        | 0    | 257  |
| Reduct Vol:  | 0           | 0    | 0    | 0           | 0    | 0    | 0          | 0    | 0    | 0          | 0    | 0    |
| Reduced Vol:   | 0           | 875  | 0    | 0           | 1677 | 0    | 0          | 0    | 0    | 211        | 0    | 257  |
| PCE Adj:   | 1.00        | 1.00 | 0.00 | 1.00        | 1.00 | 0.00 | 1.00       | 1.00 | 1.00 | 1.00       | 1.00 | 1.00 |
| MLF Adj:   | 1.00        | 1.00 | 0.00 | 1.00        | 1.00 | 0.00 | 1.00       | 1.00 | 1.00 | 1.00       | 1.00 | 1.00 |
| Final Volume:  | 0           | 875  | 0    | 0           | 1677 | 0    | 0          | 0    | 0    | 211        | 0    | 257  |
| Saturation Flow Module:                                  |             |      |      |             |      |      |            |      |      |            |      |      |
| Sat/Lane:  | 1900        | 1900 | 1900 | 1900        | 1900 | 1900 | 1900       | 1900 | 1900 | 1900       | 1900 | 1900 |
| Adjustment:  | 0.92        | 1.00 | 0.92 | 0.92        | 1.00 | 0.92 | 0.92       | 1.00 | 0.92 | 0.83       | 1.00 | 0.92 |
| Lanes:   | 0.00        | 2.00 | 1.00 | 0.00        | 2.00 | 1.00 | 0.00       | 0.00 | 0.00 | 2.00       | 0.00 | 1.00 |
| Final Sat.:  | 0           | 3800 | 1750 | 0           | 3800 | 1750 | 0          | 0    | 0    | 3150       | 0    | 1750 |
| Capacity Analysis Module:                                |             |      |      |             |      |      |            |      |      |            |      |      |
| Vol/Sat:   | 0.00        | 0.23 | 0.00 | 0.00        | 0.44 | 0.00 | 0.00       | 0.00 | 0.00 | 0.07       | 0.00 | 0.15 |
| Crit Moves:  | ****        |      |      | ****        |      |      |            |      |      |            |      | **** |
| Green Time:  | 0.0         | 101  | 0.0  | 0.0         | 101  | 0.0  | 0.0        | 0.0  | 0.0  | 33.5       | 0.0  | 33.5 |
| Volume/Cap:  | 0.00        | 0.32 | 0.00 | 0.00        | 0.61 | 0.00 | 0.00       | 0.00 | 0.00 | 0.28       | 0.00 | 0.61 |
| Delay/Veh:   | 0.0         | 7.3  | 0.0  | 0.0         | 10.4 | 0.0  | 0.0        | 0.0  | 0.0  | 43.7       | 0.0  | 50.2 |
| User DelAdj:   | 1.00        | 1.00 | 1.00 | 1.00        | 1.00 | 1.00 | 1.00       | 1.00 | 1.00 | 1.00       | 1.00 | 1.00 |
| AdjDel/Veh:  | 0.0         | 7.3  | 0.0  | 0.0         | 10.4 | 0.0  | 0.0        | 0.0  | 0.0  | 43.7       | 0.0  | 50.2 |
| LOS by Move:   | A           | A    | A    | A           | B    | A    | A          | A    | A    | D          | A    | D    |
| HCM2k95thQ:  | 0           | 13   | 0    | 0           | 30   | 0    | 0          | 0    | 0    | 9          | 0    | 20   |

Note: Queue reported is the number of cars per lane.

BART

Level Of Service Computation Report  
 2000 HCM Operations (Future Volume Alternative)  
 AM - Background Conditions

Intersection #3047: The Alameda/880 NB Ramps [Study Int 57]

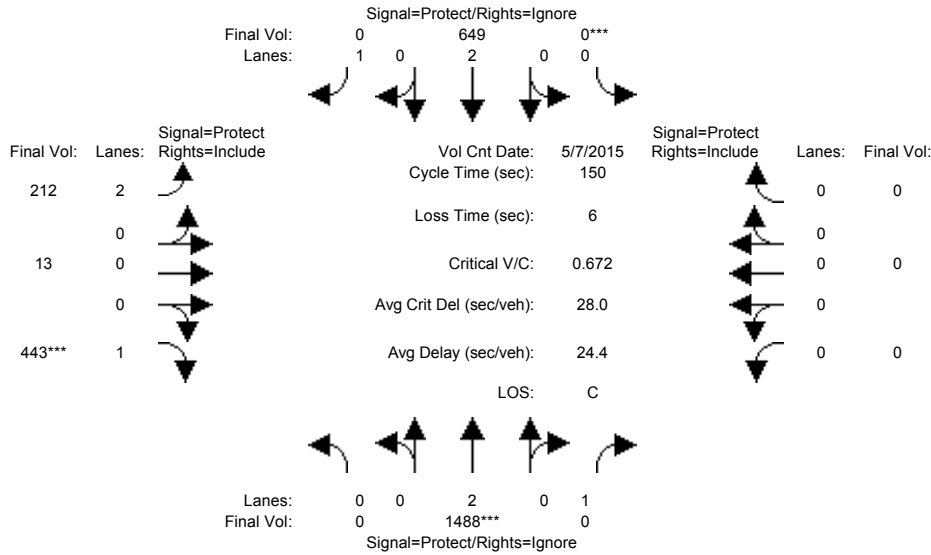

| Approach:   | North Bound |      |      | South Bound |      |      | East Bound |      |      | West Bound |      |      |
|---|-------------|------|------|-------------|------|------|------------|------|------|------------|------|------|
| Movement:   | L           | T    | R    | L           | T    | R    | L          | T    | R    | L          | T    | R    |
| Min. Green:   | 0           | 10   | 10   | 0           | 10   | 10   | 10         | 0    | 10   | 0          | 0    | 0    |
| Y+R:  | 4.0         | 4.0  | 4.0  | 4.0         | 4.0  | 4.0  | 4.0        | 4.0  | 4.0  | 4.0        | 4.0  | 4.0  |
| Volume Module: >> Count Date: 7 May 2015 << 7:50-8:50AM |             |      |      |             |      |      |            |      |      |            |      |      |
| Base Vol:   | 0           | 1488 | 469  | 0           | 649  | 269  | 212        | 13   | 443  | 0          | 0    | 0    |
| Growth Adj:   | 1.00        | 1.00 | 1.00 | 1.00        | 1.00 | 1.00 | 1.00       | 1.00 | 1.00 | 1.00       | 1.00 | 1.00 |
| Initial Bse:  | 0           | 1488 | 469  | 0           | 649  | 269  | 212        | 13   | 443  | 0          | 0    | 0    |
| Added Vol:  | 0           | 0    | 0    | 0           | 0    | 0    | 0          | 0    | 0    | 0          | 0    | 0    |
| PasserByVol:  | 0           | 0    | 0    | 0           | 0    | 0    | 0          | 0    | 0    | 0          | 0    | 0    |
| Initial Fut:  | 0           | 1488 | 469  | 0           | 649  | 269  | 212        | 13   | 443  | 0          | 0    | 0    |
| User Adj:   | 1.00        | 1.00 | 0.00 | 1.00        | 1.00 | 0.00 | 1.00       | 1.00 | 1.00 | 1.00       | 1.00 | 1.00 |
| PHF Adj:  | 1.00        | 1.00 | 0.00 | 1.00        | 1.00 | 0.00 | 1.00       | 1.00 | 1.00 | 1.00       | 1.00 | 1.00 |
| PHF Volume:   | 0           | 1488 | 0    | 0           | 649  | 0    | 212        | 13   | 443  | 0          | 0    | 0    |
| Reduct Vol:   | 0           | 0    | 0    | 0           | 0    | 0    | 0          | 0    | 0    | 0          | 0    | 0    |
| Reduced Vol:  | 0           | 1488 | 0    | 0           | 649  | 0    | 212        | 13   | 443  | 0          | 0    | 0    |
| PCE Adj:  | 1.00        | 1.00 | 0.00 | 1.00        | 1.00 | 0.00 | 1.00       | 1.00 | 1.00 | 1.00       | 1.00 | 1.00 |
| MLF Adj:  | 1.00        | 1.00 | 0.00 | 1.00        | 1.00 | 0.00 | 1.00       | 1.00 | 1.00 | 1.00       | 1.00 | 1.00 |
| Final Volume:   | 0           | 1488 | 0    | 0           | 649  | 0    | 212        | 13   | 443  | 0          | 0    | 0    |
| Saturation Flow Module:                                 |             |      |      |             |      |      |            |      |      |            |      |      |
| Sat/Lane:   | 1900        | 1900 | 1900 | 1900        | 1900 | 1900 | 1900       | 1900 | 1900 | 1900       | 1900 | 1900 |
| Adjustment:   | 0.92        | 1.00 | 0.92 | 0.92        | 1.00 | 0.92 | 0.92       | 1.00 | 0.92 | 0.92       | 1.00 | 0.92 |
| Lanes:  | 0.00        | 2.00 | 1.00 | 0.00        | 2.00 | 1.00 | 1.89       | 0.11 | 1.00 | 0.00       | 0.00 | 0.00 |
| Final Sat.:   | 0           | 3800 | 1750 | 0           | 3800 | 1750 | 3313       | 203  | 1750 | 0          | 0    | 0    |
| Capacity Analysis Module:                               |             |      |      |             |      |      |            |      |      |            |      |      |
| Vol/Sat:  | 0.00        | 0.39 | 0.00 | 0.00        | 0.17 | 0.00 | 0.06       | 0.06 | 0.25 | 0.00       | 0.00 | 0.00 |
| Crit Moves:   | ****        | **** | **** | ****        | **** | **** | ****       | **** | **** | ****       | **** | **** |
| Green Time:   | 0.0         | 87.5 | 0.0  | 0.0         | 87.5 | 0.0  | 56.5       | 56.5 | 56.5 | 0.0        | 0.0  | 0.0  |
| Volume/Cap:   | 0.00        | 0.67 | 0.00 | 0.00        | 0.29 | 0.00 | 0.17       | 0.17 | 0.67 | 0.00       | 0.00 | 0.00 |
| Delay/Veh:  | 0.0         | 22.2 | 0.0  | 0.0         | 15.8 | 0.0  | 31.1       | 31.1 | 40.8 | 0.0        | 0.0  | 0.0  |
| User DelAdj:  | 1.00        | 1.00 | 1.00 | 1.00        | 1.00 | 1.00 | 1.00       | 1.00 | 1.00 | 1.00       | 1.00 | 1.00 |
| AdjDel/Veh:   | 0.0         | 22.2 | 0.0  | 0.0         | 15.8 | 0.0  | 31.1       | 31.1 | 40.8 | 0.0        | 0.0  | 0.0  |
| LOS by Move:  | A           | C    | A    | A           | B    | A    | C          | C    | D    | A          | A    | A    |
| HCM2k95thQ:   | 0           | 38   | 0    | 0           | 14   | 0    | 7          | 7    | 32   | 0          | 0    | 0    |

Note: Queue reported is the number of cars per lane.

BART

Level Of Service Computation Report  
 2000 HCM Operations (Future Volume Alternative)  
 PM - Background Conditions

Intersection #3047: The Alameda/880 NB Ramps [Study Int 57]

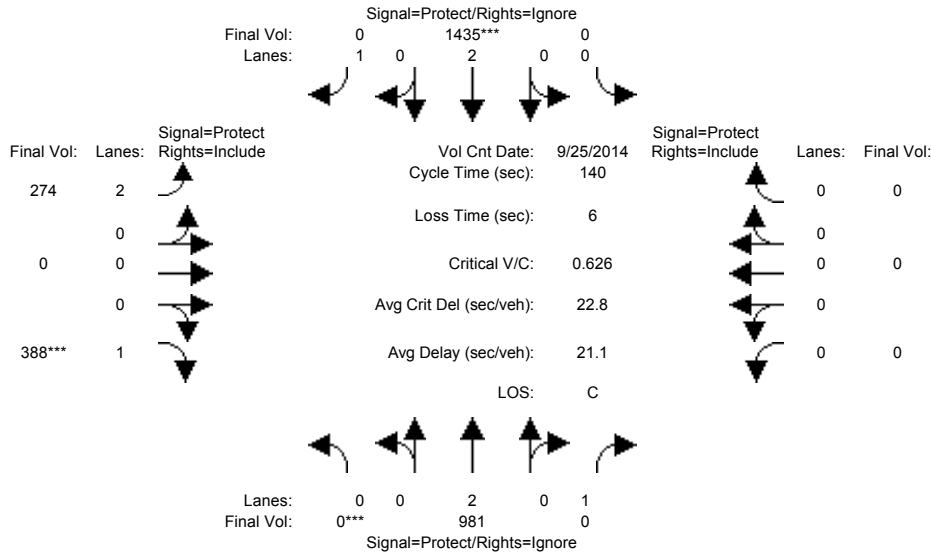

| Approach:  | North Bound |      |      | South Bound |      |      | East Bound |      |      | West Bound |      |      |
|--|-------------|------|------|-------------|------|------|------------|------|------|------------|------|------|
| Movement:  | L           | T    | R    | L           | T    | R    | L          | T    | R    | L          | T    | R    |
| Min. Green:  | 0           | 10   | 10   | 0           | 10   | 10   | 10         | 0    | 10   | 0          | 0    | 0    |
| Y+R:   | 4.0         | 4.0  | 4.0  | 4.0         | 4.0  | 4.0  | 4.0        | 4.0  | 4.0  | 4.0        | 4.0  | 4.0  |
| Volume Module: >> Count Date: 25 Sep 2014 << 4:45-5:45PM |             |      |      |             |      |      |            |      |      |            |      |      |
| Base Vol:  | 0           | 981  | 225  | 0           | 1435 | 466  | 274        | 0    | 388  | 0          | 0    | 0    |
| Growth Adj:  | 1.00        | 1.00 | 1.00 | 1.00        | 1.00 | 1.00 | 1.00       | 1.00 | 1.00 | 1.00       | 1.00 | 1.00 |
| Initial Bse:   | 0           | 981  | 225  | 0           | 1435 | 466  | 274        | 0    | 388  | 0          | 0    | 0    |
| Added Vol:   | 0           | 0    | 0    | 0           | 0    | 0    | 0          | 0    | 0    | 0          | 0    | 0    |
| PasserByVol:   | 0           | 0    | 0    | 0           | 0    | 0    | 0          | 0    | 0    | 0          | 0    | 0    |
| Initial Fut:   | 0           | 981  | 225  | 0           | 1435 | 466  | 274        | 0    | 388  | 0          | 0    | 0    |
| User Adj:  | 1.00        | 1.00 | 0.00 | 1.00        | 1.00 | 0.00 | 1.00       | 1.00 | 1.00 | 1.00       | 1.00 | 1.00 |
| PHF Adj:   | 1.00        | 1.00 | 0.00 | 1.00        | 1.00 | 0.00 | 1.00       | 1.00 | 1.00 | 1.00       | 1.00 | 1.00 |
| PHF Volume:  | 0           | 981  | 0    | 0           | 1435 | 0    | 274        | 0    | 388  | 0          | 0    | 0    |
| Reduct Vol:  | 0           | 0    | 0    | 0           | 0    | 0    | 0          | 0    | 0    | 0          | 0    | 0    |
| Reduced Vol:   | 0           | 981  | 0    | 0           | 1435 | 0    | 274        | 0    | 388  | 0          | 0    | 0    |
| PCE Adj:   | 1.00        | 1.00 | 0.00 | 1.00        | 1.00 | 0.00 | 1.00       | 1.00 | 1.00 | 1.00       | 1.00 | 1.00 |
| MLF Adj:   | 1.00        | 1.00 | 0.00 | 1.00        | 1.00 | 0.00 | 1.00       | 1.00 | 1.00 | 1.00       | 1.00 | 1.00 |
| FinalVolume:   | 0           | 981  | 0    | 0           | 1435 | 0    | 274        | 0    | 388  | 0          | 0    | 0    |
| Saturation Flow Module:                                  |             |      |      |             |      |      |            |      |      |            |      |      |
| Sat/Lane:  | 1900        | 1900 | 1900 | 1900        | 1900 | 1900 | 1900       | 1900 | 1900 | 1900       | 1900 | 1900 |
| Adjustment:  | 0.92        | 1.00 | 0.92 | 0.92        | 1.00 | 0.92 | 0.83       | 1.00 | 0.92 | 0.92       | 1.00 | 0.92 |
| Lanes:   | 0.00        | 2.00 | 1.00 | 0.00        | 2.00 | 1.00 | 2.00       | 0.00 | 1.00 | 0.00       | 0.00 | 0.00 |
| Final Sat.:  | 0           | 3800 | 1750 | 0           | 3800 | 1750 | 3150       | 0    | 1750 | 0          | 0    | 0    |
| Capacity Analysis Module:                                |             |      |      |             |      |      |            |      |      |            |      |      |
| Vol/Sat:   | 0.00        | 0.26 | 0.00 | 0.00        | 0.38 | 0.00 | 0.09       | 0.00 | 0.22 | 0.00       | 0.00 | 0.00 |
| Crit Moves:  | ****        |      |      | ****        |      |      | ****       |      |      | ****       |      |      |
| Green Time:  | 0.0         | 84.4 | 0.0  | 0.0         | 84.4 | 0.0  | 49.6       | 0.0  | 49.6 | 0.0        | 0.0  | 0.0  |
| Volume/Cap:  | 0.00        | 0.43 | 0.00 | 0.00        | 0.63 | 0.00 | 0.25       | 0.00 | 0.63 | 0.00       | 0.00 | 0.00 |
| Delay/Veh:   | 0.0         | 15.0 | 0.0  | 0.0         | 18.3 | 0.0  | 32.1       | 0.0  | 39.6 | 0.0        | 0.0  | 0.0  |
| User DelAdj:   | 1.00        | 1.00 | 1.00 | 1.00        | 1.00 | 1.00 | 1.00       | 1.00 | 1.00 | 1.00       | 1.00 | 1.00 |
| AdjDel/Veh:  | 0.0         | 15.0 | 0.0  | 0.0         | 18.3 | 0.0  | 32.1       | 0.0  | 39.6 | 0.0        | 0.0  | 0.0  |
| LOS by Move:   | A           | B    | A    | A           | B    | A    | C          | A    | D    | A          | A    | A    |
| HCM2k95thQ:  | 0           | 20   | 0    | 0           | 33   | 0    | 10         | 0    | 27   | 0          | 0    | 0    |

Note: Queue reported is the number of cars per lane.

BART

Level Of Service Computation Report  
 2000 HCM Operations (Future Volume Alternative)  
 AM - Background Conditions

Intersection #3052: 880 SB Ramps/Coleman [Study Int 36]

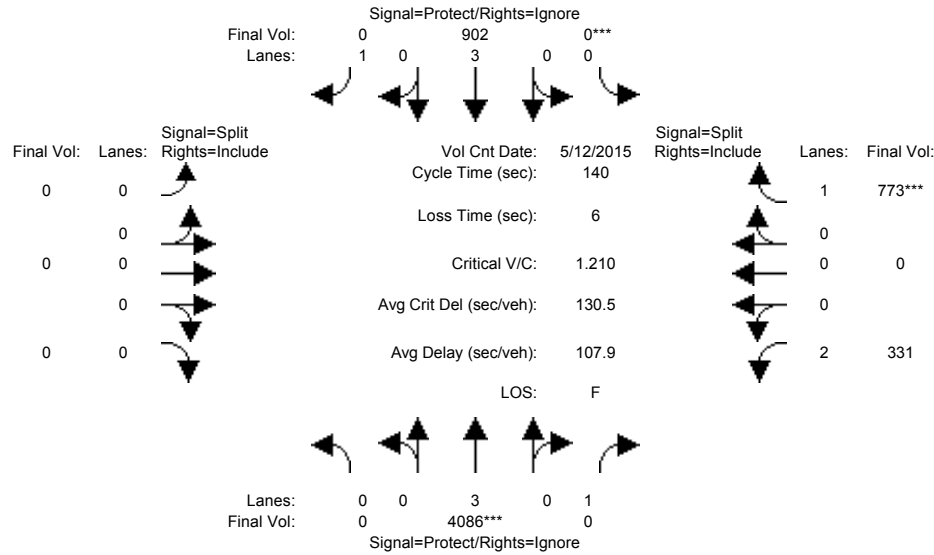

| Approach:                 | North Bound                               |      |      | South Bound |      |      | East Bound |      |      | West Bound |      |       |
|---------------------------|---|------|------|-------------|------|------|------------|------|------|------------|------|-------|
| Movement:                 | L   | T    | R    | L           | T    | R    | L          | T    | R    | L          | T    | R     |
| Min. Green:               | 0   | 10   | 10   | 0           | 10   | 10   | 0          | 0    | 0    | 10         | 0    | 10    |
| Y+R:                      | 4.0                                       | 4.0  | 4.0  | 4.0         | 4.0  | 4.0  | 4.0        | 4.0  | 4.0  | 4.0        | 4.0  | 4.0   |
| Volume Module:            | >> Count Date: 12 May 2015 << 7:45-8:45AM |      |      |             |      |      |            |      |      |            |      |       |
| Base Vol:                 | 0   | 4086 | 179  | 0           | 902  | 193  | 0          | 0    | 0    | 331        | 0    | 773   |
| Growth Adj:               | 1.00                                      | 1.00 | 1.00 | 1.00        | 1.00 | 1.00 | 1.00       | 1.00 | 1.00 | 1.00       | 1.00 | 1.00  |
| Initial Bse:              | 0   | 4086 | 179  | 0           | 902  | 193  | 0          | 0    | 0    | 331        | 0    | 773   |
| Added Vol:                | 0   | 0    | 0    | 0           | 0    | 0    | 0          | 0    | 0    | 0          | 0    | 0     |
| PasserByVol:              | 0   | 0    | 0    | 0           | 0    | 0    | 0          | 0    | 0    | 0          | 0    | 0     |
| Initial Fut:              | 0   | 4086 | 179  | 0           | 902  | 193  | 0          | 0    | 0    | 331        | 0    | 773   |
| User Adj:                 | 1.00                                      | 1.00 | 0.00 | 1.00        | 1.00 | 0.00 | 1.00       | 1.00 | 1.00 | 1.00       | 1.00 | 1.00  |
| PHF Adj:                  | 1.00                                      | 1.00 | 0.00 | 1.00        | 1.00 | 0.00 | 1.00       | 1.00 | 1.00 | 1.00       | 1.00 | 1.00  |
| PHF Volume:               | 0   | 4086 | 0    | 0           | 902  | 0    | 0          | 0    | 0    | 331        | 0    | 773   |
| Reduct Vol:               | 0   | 0    | 0    | 0           | 0    | 0    | 0          | 0    | 0    | 0          | 0    | 0     |
| Reduced Vol:              | 0   | 4086 | 0    | 0           | 902  | 0    | 0          | 0    | 0    | 331        | 0    | 773   |
| PCE Adj:                  | 1.00                                      | 1.00 | 0.00 | 1.00        | 1.00 | 0.00 | 1.00       | 1.00 | 1.00 | 1.00       | 1.00 | 1.00  |
| MLF Adj:                  | 1.00                                      | 1.00 | 0.00 | 1.00        | 1.00 | 0.00 | 1.00       | 1.00 | 1.00 | 1.00       | 1.00 | 1.00  |
| Final Volume:             | 0   | 4086 | 0    | 0           | 902  | 0    | 0          | 0    | 0    | 331        | 0    | 773   |
| Saturation Flow Module:   |   |      |      |             |      |      |            |      |      |            |      |       |
| Sat/Lane:                 | 1900                                      | 1900 | 1900 | 1900        | 1900 | 1900 | 1900       | 1900 | 1900 | 1900       | 1900 | 1900  |
| Adjustment:               | 0.92                                      | 1.00 | 0.92 | 0.92        | 1.00 | 0.92 | 0.92       | 1.00 | 0.92 | 0.83       | 1.00 | 0.92  |
| Lanes:                    | 0.00                                      | 3.00 | 1.00 | 0.00        | 3.00 | 1.00 | 0.00       | 0.00 | 0.00 | 2.00       | 0.00 | 1.00  |
| Final Sat.:               | 0   | 5700 | 1750 | 0           | 5700 | 1750 | 0          | 0    | 0    | 3150       | 0    | 1750  |
| Capacity Analysis Module: |   |      |      |             |      |      |            |      |      |            |      |       |
| Vol/Sat:                  | 0.00                                      | 0.72 | 0.00 | 0.00        | 0.16 | 0.00 | 0.00       | 0.00 | 0.00 | 0.11       | 0.00 | 0.44  |
| Crit Moves:               | ****                                      |      |      | ****        |      |      |            |      |      | ****       |      |       |
| Green Time:               | 0.0                                       | 82.9 | 0.0  | 0.0         | 82.9 | 0.0  | 0.0        | 0.0  | 0.0  | 51.1       | 0.0  | 51.1  |
| Volume/Cap:               | 0.00                                      | 1.21 | 0.00 | 0.00        | 0.27 | 0.00 | 0.00       | 0.00 | 0.00 | 0.29       | 0.00 | 1.21  |
| Delay/Veh:                | 0.0                                       | 126  | 0.0  | 0.0         | 13.9 | 0.0  | 0.0        | 0.0  | 0.0  | 31.7       | 0.0  | 153.3 |
| User DelAdj:              | 1.00                                      | 1.00 | 1.00 | 1.00        | 1.00 | 1.00 | 1.00       | 1.00 | 1.00 | 1.00       | 1.00 | 1.00  |
| AdjDel/Veh:               | 0.0                                       | 126  | 0.0  | 0.0         | 13.9 | 0.0  | 0.0        | 0.0  | 0.0  | 31.7       | 0.0  | 153.3 |
| LOS by Move:              | A   | F    | A    | A           | B    | A    | A          | A    | A    | C          | A    | F     |
| HCM2k95thQ:               | 0   | 132  | 0    | 0           | 12   | 0    | 0          | 0    | 0    | 11         | 0    | 85    |

Note: Queue reported is the number of cars per lane.

BART

Level Of Service Computation Report  
2000 HCM Operations (Future Volume Alternative)  
PM - Background Conditions

Intersection #3052: 880 SB Ramps/Coleman [Study Int 36]

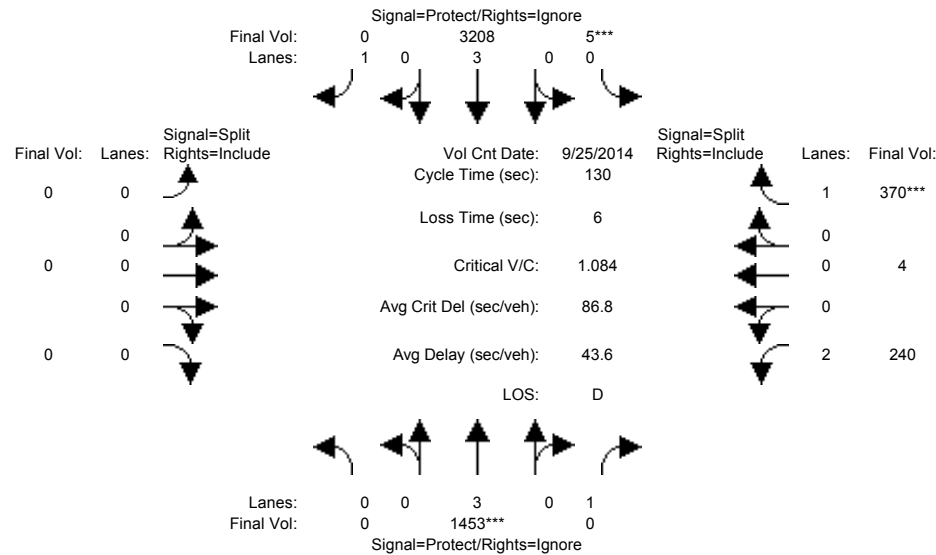

| Approach:   | North Bound |      |      | South Bound |      |      | East Bound |      |      | West Bound |      |       |
|---|-------------|------|------|-------------|------|------|------------|------|------|------------|------|-------|
| Movement:   | L           | T    | R    | L           | T    | R    | L          | T    | R    | L          | T    | R     |
| Min. Green:   | 0           | 10   | 10   | 0           | 10   | 10   | 0          | 0    | 0    | 10         | 0    | 10    |
| Y+R:  | 4.0         | 4.0  | 4.0  | 4.0         | 4.0  | 4.0  | 4.0        | 4.0  | 4.0  | 4.0        | 4.0  | 4.0   |
| Volume Module: >> Count Date: 25 Sep 2014 << 4:30 PM to 5:30 PM |             |      |      |             |      |      |            |      |      |            |      |       |
| Base Vol:   | 0           | 1453 | 301  | 5           | 3208 | 773  | 0          | 0    | 0    | 240        | 4    | 370   |
| Growth Adj:   | 1.00        | 1.00 | 1.00 | 1.00        | 1.00 | 1.00 | 1.00       | 1.00 | 1.00 | 1.00       | 1.00 | 1.00  |
| Initial Bse:  | 0           | 1453 | 301  | 5           | 3208 | 773  | 0          | 0    | 0    | 240        | 4    | 370   |
| Added Vol:  | 0           | 0    | 0    | 0           | 0    | 0    | 0          | 0    | 0    | 0          | 0    | 0     |
| PasserByVol:  | 0           | 0    | 0    | 0           | 0    | 0    | 0          | 0    | 0    | 0          | 0    | 0     |
| Initial Fut:  | 0           | 1453 | 301  | 5           | 3208 | 773  | 0          | 0    | 0    | 240        | 4    | 370   |
| User Adj:   | 1.00        | 1.00 | 0.00 | 1.00        | 1.00 | 0.00 | 1.00       | 1.00 | 1.00 | 1.00       | 1.00 | 1.00  |
| PHF Adj:  | 1.00        | 1.00 | 0.00 | 1.00        | 1.00 | 0.00 | 1.00       | 1.00 | 1.00 | 1.00       | 1.00 | 1.00  |
| PHF Volume:   | 0           | 1453 | 0    | 5           | 3208 | 0    | 0          | 0    | 0    | 240        | 4    | 370   |
| Reduct Vol:   | 0           | 0    | 0    | 0           | 0    | 0    | 0          | 0    | 0    | 0          | 0    | 0     |
| Reduced Vol:  | 0           | 1453 | 0    | 5           | 3208 | 0    | 0          | 0    | 0    | 240        | 4    | 370   |
| PCE Adj:  | 1.00        | 1.00 | 0.00 | 1.00        | 1.00 | 0.00 | 1.00       | 1.00 | 1.00 | 1.00       | 1.00 | 1.00  |
| MLF Adj:  | 1.00        | 1.00 | 0.00 | 1.00        | 1.00 | 0.00 | 1.00       | 1.00 | 1.00 | 1.00       | 1.00 | 1.00  |
| Final Volume:   | 0           | 1453 | 0    | 5           | 3208 | 0    | 0          | 0    | 0    | 240        | 4    | 370   |
| Saturation Flow Module:   |             |      |      |             |      |      |            |      |      |            |      |       |
| Sat/Lane:   | 1900        | 1900 | 1900 | 1900        | 1900 | 1900 | 1900       | 1900 | 1900 | 1900       | 1900 | 1900  |
| Adjustment:   | 0.92        | 1.00 | 0.92 | 0.95        | 0.98 | 0.92 | 0.92       | 1.00 | 0.92 | 0.92       | 0.95 | 0.95  |
| Lanes:  | 0.00        | 3.00 | 1.00 | 0.01        | 2.99 | 1.00 | 0.00       | 0.00 | 0.00 | 1.97       | 0.03 | 1.00  |
| Final Sat.:   | 0           | 5700 | 1750 | 9           | 5591 | 1750 | 0          | 0    | 0    | 3458       | 58   | 1800  |
| Capacity Analysis Module:                                       |             |      |      |             |      |      |            |      |      |            |      |       |
| Vol/Sat:  | 0.00        | 0.25 | 0.00 | 0.57        | 0.57 | 0.00 | 0.00       | 0.00 | 0.00 | 0.07       | 0.07 | 0.21  |
| Crit Moves:   | ****        | **** | **** | ****        | **** | **** | ****       | **** | **** | ****       | **** | ****  |
| Green Time:   | 0.0         | 30.6 | 0.0  | 68.8        | 99.4 | 0.0  | 0.0        | 0.0  | 0.0  | 24.6       | 24.6 | 24.6  |
| Volume/Cap:   | 0.00        | 1.08 | 0.00 | 1.08        | 0.75 | 0.00 | 0.00       | 0.00 | 0.00 | 0.37       | 0.37 | 1.08  |
| Delay/Veh:  | 0.0         | 101  | 0.0  | 75.2        | 9.2  | 0.0  | 0.0        | 0.0  | 0.0  | 46.0       | 46.0 | 115.3 |
| User DelAdj:  | 1.00        | 1.00 | 1.00 | 1.00        | 1.00 | 1.00 | 1.00       | 1.00 | 1.00 | 1.00       | 1.00 | 1.00  |
| AdjDel/Veh:   | 0.0         | 101  | 0.0  | 75.2        | 9.2  | 0.0  | 0.0        | 0.0  | 0.0  | 46.0       | 46.0 | 115.3 |
| LOS by Move:  | A           | F    | A    | E           | A    | A    | A          | A    | A    | D          | D    | F     |
| HCM2k95thQ:   | 0           | 46   | 0    | 87          | 41   | 0    | 0          | 0    | 0    | 9          | 9    | 39    |

Note: Queue reported is the number of cars per lane.

BART

Level Of Service Computation Report  
2000 HCM Operations (Future Volume Alternative)  
AM - Background Conditions

Intersection #3053: 880 NB Ramps/Coleman [Study Int 37]

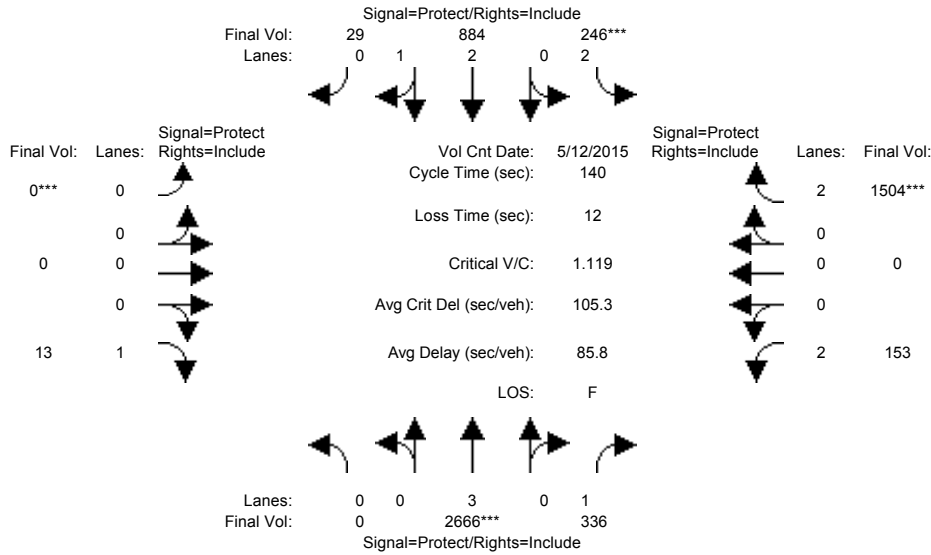

| Approach:  | North Bound |      |      | South Bound |      |      | East Bound |      |      | West Bound |      |       |
|--|-------------|------|------|-------------|------|------|------------|------|------|------------|------|-------|
| Movement:  | L           | T    | R    | L           | T    | R    | L          | T    | R    | L          | T    | R     |
| Min. Green:  | 0           | 10   | 10   | 7           | 10   | 10   | 0          | 0    | 10   | 10         | 0    | 10    |
| Y+R:   | 4.0         | 4.0  | 4.0  | 4.0         | 4.0  | 4.0  | 4.0        | 4.0  | 4.0  | 4.0        | 4.0  | 4.0   |
| Volume Module: >> Count Date: 12 May 2015 << 7:45-8:45AM |             |      |      |             |      |      |            |      |      |            |      |       |
| Base Vol:  | 0           | 2666 | 336  | 246         | 884  | 29   | 0          | 0    | 13   | 153        | 0    | 1504  |
| Growth Adj:  | 1.00        | 1.00 | 1.00 | 1.00        | 1.00 | 1.00 | 1.00       | 1.00 | 1.00 | 1.00       | 1.00 | 1.00  |
| Initial Bse:   | 0           | 2666 | 336  | 246         | 884  | 29   | 0          | 0    | 13   | 153        | 0    | 1504  |
| Added Vol:   | 0           | 0    | 0    | 0           | 0    | 0    | 0          | 0    | 0    | 0          | 0    | 0     |
| PasserByVol:   | 0           | 0    | 0    | 0           | 0    | 0    | 0          | 0    | 0    | 0          | 0    | 0     |
| Initial Fut:   | 0           | 2666 | 336  | 246         | 884  | 29   | 0          | 0    | 13   | 153        | 0    | 1504  |
| User Adj:  | 1.00        | 1.00 | 1.00 | 1.00        | 1.00 | 1.00 | 1.00       | 1.00 | 1.00 | 1.00       | 1.00 | 1.00  |
| PHF Adj:   | 1.00        | 1.00 | 1.00 | 1.00        | 1.00 | 1.00 | 1.00       | 1.00 | 1.00 | 1.00       | 1.00 | 1.00  |
| PHF Volume:  | 0           | 2666 | 336  | 246         | 884  | 29   | 0          | 0    | 13   | 153        | 0    | 1504  |
| Reduct Vol:  | 0           | 0    | 0    | 0           | 0    | 0    | 0          | 0    | 0    | 0          | 0    | 0     |
| Reduced Vol:   | 0           | 2666 | 336  | 246         | 884  | 29   | 0          | 0    | 13   | 153        | 0    | 1504  |
| PCE Adj:   | 1.00        | 1.00 | 1.00 | 1.00        | 1.00 | 1.00 | 1.00       | 1.00 | 1.00 | 1.00       | 1.00 | 1.00  |
| MLF Adj:   | 1.00        | 1.00 | 1.00 | 1.00        | 1.00 | 1.00 | 1.00       | 1.00 | 1.00 | 1.00       | 1.00 | 1.00  |
| FinalVolume:   | 0           | 2666 | 336  | 246         | 884  | 29   | 0          | 0    | 13   | 153        | 0    | 1504  |
| Saturation Flow Module:                                  |             |      |      |             |      |      |            |      |      |            |      |       |
| Sat/Lane:  | 1900        | 1900 | 1900 | 1900        | 1900 | 1900 | 1900       | 1900 | 1900 | 1900       | 1900 | 1900  |
| Adjustment:  | 0.92        | 1.00 | 0.92 | 0.83        | 0.98 | 0.95 | 0.92       | 1.00 | 0.92 | 0.83       | 1.00 | 0.83  |
| Lanes:   | 0.00        | 3.00 | 1.00 | 2.00        | 2.90 | 0.10 | 0.00       | 0.00 | 1.00 | 2.00       | 0.00 | 2.00  |
| Final Sat.:  | 0           | 5700 | 1750 | 3150        | 5422 | 178  | 0          | 0    | 1750 | 3150       | 0    | 3150  |
| Capacity Analysis Module:                                |             |      |      |             |      |      |            |      |      |            |      |       |
| Vol/Sat:   | 0.00        | 0.47 | 0.19 | 0.08        | 0.16 | 0.16 | 0.00       | 0.00 | 0.01 | 0.05       | 0.00 | 0.48  |
| Crit Moves:  | ****        | **** | **** | ****        | **** | **** | ****       | **** | **** | ****       | **** | ****  |
| Green Time:  | 0.0         | 58.5 | 58.5 | 9.8         | 68.3 | 68.3 | 0.0        | 0.0  | 5.6  | 54.1       | 0.0  | 59.7  |
| Volume/Cap:  | 0.00        | 1.12 | 0.46 | 1.12        | 0.33 | 0.33 | 0.00       | 0.00 | 0.18 | 0.13       | 0.00 | 1.12  |
| Delay/Veh:   | 0.0         | 101  | 29.8 | 161.5       | 22.0 | 22.0 | 0.0        | 0.0  | 66.2 | 27.7       | 0.0  | 104.3 |
| User DelAdj:   | 1.00        | 1.00 | 1.00 | 1.00        | 1.00 | 1.00 | 1.00       | 1.00 | 1.00 | 1.00       | 1.00 | 1.00  |
| AdjDel/Veh:  | 0.0         | 101  | 29.8 | 161.5       | 22.0 | 22.0 | 0.0        | 0.0  | 66.2 | 27.7       | 0.0  | 104.3 |
| LOS by Move:   | A           | F    | C    | F           | C    | C    | A          | A    | E    | C          | A    | F     |
| HCM2k95thQ:  | 0           | 75   | 19   | 20          | 15   | 15   | 0          | 0    | 2    | 5          | 0    | 82    |

Note: Queue reported is the number of cars per lane.

BART

Level Of Service Computation Report  
 2000 HCM Operations (Future Volume Alternative)  
 PM - Background Conditions

Intersection #3053: 880 NB Ramps/Coleman [Study Int 37]

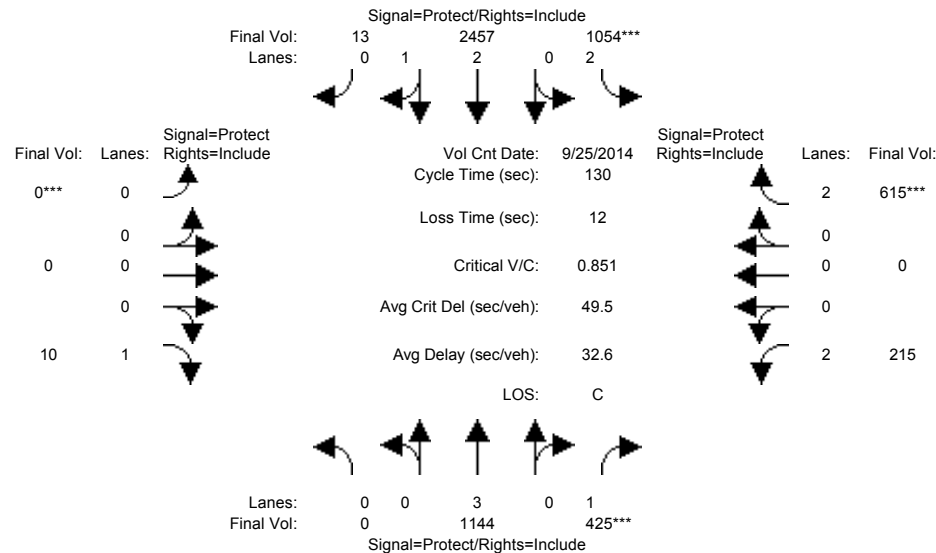

| Approach:  | North Bound |      |      | South Bound |      |      | East Bound |      |      | West Bound |      |      |
|--|-------------|------|------|-------------|------|------|------------|------|------|------------|------|------|
| Movement:  | L           | T    | R    | L           | T    | R    | L          | T    | R    | L          | T    | R    |
| Min. Green:  | 0           | 10   | 10   | 7           | 10   | 10   | 0          | 0    | 10   | 10         | 0    | 10   |
| Y+R:   | 4.0         | 4.0  | 4.0  | 4.0         | 4.0  | 4.0  | 4.0        | 4.0  | 4.0  | 4.0        | 4.0  | 4.0  |
| Volume Module: >> Count Date: 25 Sep 2014 << 5:00-6:00PM |             |      |      |             |      |      |            |      |      |            |      |      |
| Base Vol:  | 0           | 1144 | 425  | 1054        | 2457 | 13   | 0          | 0    | 10   | 215        | 0    | 615  |
| Growth Adj:  | 1.00        | 1.00 | 1.00 | 1.00        | 1.00 | 1.00 | 1.00       | 1.00 | 1.00 | 1.00       | 1.00 | 1.00 |
| Initial Bse:   | 0           | 1144 | 425  | 1054        | 2457 | 13   | 0          | 0    | 10   | 215        | 0    | 615  |
| Added Vol:   | 0           | 0    | 0    | 0           | 0    | 0    | 0          | 0    | 0    | 0          | 0    | 0    |
| PasserByVol:   | 0           | 0    | 0    | 0           | 0    | 0    | 0          | 0    | 0    | 0          | 0    | 0    |
| Initial Fut:   | 0           | 1144 | 425  | 1054        | 2457 | 13   | 0          | 0    | 10   | 215        | 0    | 615  |
| User Adj:  | 1.00        | 1.00 | 1.00 | 1.00        | 1.00 | 1.00 | 1.00       | 1.00 | 1.00 | 1.00       | 1.00 | 1.00 |
| PHF Adj:   | 1.00        | 1.00 | 1.00 | 1.00        | 1.00 | 1.00 | 1.00       | 1.00 | 1.00 | 1.00       | 1.00 | 1.00 |
| PHF Volume:  | 0           | 1144 | 425  | 1054        | 2457 | 13   | 0          | 0    | 10   | 215        | 0    | 615  |
| Reduct Vol:  | 0           | 0    | 0    | 0           | 0    | 0    | 0          | 0    | 0    | 0          | 0    | 0    |
| Reduced Vol:   | 0           | 1144 | 425  | 1054        | 2457 | 13   | 0          | 0    | 10   | 215        | 0    | 615  |
| PCE Adj:   | 1.00        | 1.00 | 1.00 | 1.00        | 1.00 | 1.00 | 1.00       | 1.00 | 1.00 | 1.00       | 1.00 | 1.00 |
| MLF Adj:   | 1.00        | 1.00 | 1.00 | 1.00        | 1.00 | 1.00 | 1.00       | 1.00 | 1.00 | 1.00       | 1.00 | 1.00 |
| Final Volume:  | 0           | 1144 | 425  | 1054        | 2457 | 13   | 0          | 0    | 10   | 215        | 0    | 615  |
| Saturation Flow Module:                                  |             |      |      |             |      |      |            |      |      |            |      |      |
| Sat/Lane:  | 1900        | 1900 | 1900 | 1900        | 1900 | 1900 | 1900       | 1900 | 1900 | 1900       | 1900 | 1900 |
| Adjustment:  | 0.92        | 1.00 | 0.92 | 0.83        | 0.98 | 0.95 | 0.92       | 1.00 | 0.92 | 0.83       | 1.00 | 0.83 |
| Lanes:   | 0.00        | 3.00 | 1.00 | 2.00        | 2.98 | 0.02 | 0.00       | 0.00 | 1.00 | 2.00       | 0.00 | 2.00 |
| Final Sat.:  | 0           | 5700 | 1750 | 3150        | 5570 | 29   | 0          | 0    | 1750 | 3150       | 0    | 3150 |
| Capacity Analysis Module:                                |             |      |      |             |      |      |            |      |      |            |      |      |
| Vol/Sat:   | 0.00        | 0.20 | 0.24 | 0.33        | 0.44 | 0.44 | 0.00       | 0.00 | 0.01 | 0.07       | 0.00 | 0.20 |
| Crit Moves:  | 0.00        | 0.20 | 0.24 | 0.33        | 0.44 | 0.44 | 0.00       | 0.00 | 0.01 | 0.07       | 0.00 | 0.20 |
| Green Time:  | 0.0         | 37.1 | 37.1 | 51.1        | 88.2 | 88.2 | 0.0        | 0.0  | 2.1  | 27.8       | 0.0  | 29.8 |
| Volume/Cap:  | 0.00        | 0.70 | 0.85 | 0.85        | 0.65 | 0.65 | 0.00       | 0.00 | 0.36 | 0.32       | 0.00 | 0.85 |
| Delay/Veh:   | 0.0         | 43.0 | 57.0 | 41.8        | 12.4 | 12.4 | 0.0        | 0.0  | 71.1 | 43.4       | 0.0  | 57.5 |
| User DelAdj:   | 1.00        | 1.00 | 1.00 | 1.00        | 1.00 | 1.00 | 1.00       | 1.00 | 1.00 | 1.00       | 1.00 | 1.00 |
| AdjDel/Veh:  | 0.0         | 43.0 | 57.0 | 41.8        | 12.4 | 12.4 | 0.0        | 0.0  | 71.1 | 43.4       | 0.0  | 57.5 |
| LOS by Move:   | A           | D    | E    | D           | B    | B    | A          | A    | E    | D          | A    | E    |
| HCM2k95thQ:  | 0           | 24   | 30   | 42          | 33   | 33   | 0          | 0    | 2    | 9          | 0    | 29   |

Note: Queue reported is the number of cars per lane.

BART

Level Of Service Computation Report  
 2000 HCM Operations (Future Volume Alternative)  
 AM - Background Conditions

Intersection #3057: The Alameda/Hedding [Study Int 58]

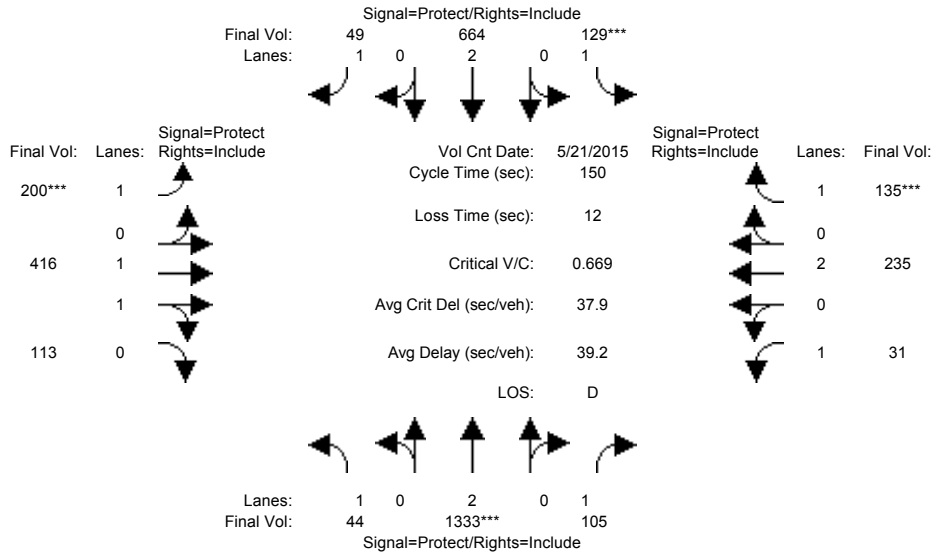

| Approach:  | North Bound |      |      | South Bound |      |      | East Bound |      |      | West Bound |      |      |
|--|-------------|------|------|-------------|------|------|------------|------|------|------------|------|------|
| Movement:  | L           | T    | R    | L           | T    | R    | L          | T    | R    | L          | T    | R    |
| Min. Green:  | 7           | 10   | 10   | 7           | 10   | 10   | 7          | 10   | 10   | 7          | 10   | 10   |
| Y+R:   | 4.0         | 4.0  | 4.0  | 4.0         | 4.0  | 4.0  | 4.0        | 4.0  | 4.0  | 4.0        | 4.0  | 4.0  |
| Volume Module: >> Count Date: 21 May 2015 << 7:30-8:30AM |             |      |      |             |      |      |            |      |      |            |      |      |
| Base Vol:  | 44          | 1333 | 105  | 129         | 664  | 49   | 200        | 416  | 113  | 31         | 235  | 135  |
| Growth Adj:  | 1.00        | 1.00 | 1.00 | 1.00        | 1.00 | 1.00 | 1.00       | 1.00 | 1.00 | 1.00       | 1.00 | 1.00 |
| Initial Bse:   | 44          | 1333 | 105  | 129         | 664  | 49   | 200        | 416  | 113  | 31         | 235  | 135  |
| Added Vol:   | 0           | 0    | 0    | 0           | 0    | 0    | 0          | 0    | 0    | 0          | 0    | 0    |
| PasserByVol:   | 0           | 0    | 0    | 0           | 0    | 0    | 0          | 0    | 0    | 0          | 0    | 0    |
| Initial Fut:   | 44          | 1333 | 105  | 129         | 664  | 49   | 200        | 416  | 113  | 31         | 235  | 135  |
| User Adj:  | 1.00        | 1.00 | 1.00 | 1.00        | 1.00 | 1.00 | 1.00       | 1.00 | 1.00 | 1.00       | 1.00 | 1.00 |
| PHF Adj:   | 1.00        | 1.00 | 1.00 | 1.00        | 1.00 | 1.00 | 1.00       | 1.00 | 1.00 | 1.00       | 1.00 | 1.00 |
| PHF Volume:  | 44          | 1333 | 105  | 129         | 664  | 49   | 200        | 416  | 113  | 31         | 235  | 135  |
| Reduct Vol:  | 0           | 0    | 0    | 0           | 0    | 0    | 0          | 0    | 0    | 0          | 0    | 0    |
| Reduced Vol:   | 44          | 1333 | 105  | 129         | 664  | 49   | 200        | 416  | 113  | 31         | 235  | 135  |
| PCE Adj:   | 1.00        | 1.00 | 1.00 | 1.00        | 1.00 | 1.00 | 1.00       | 1.00 | 1.00 | 1.00       | 1.00 | 1.00 |
| MLF Adj:   | 1.00        | 1.00 | 1.00 | 1.00        | 1.00 | 1.00 | 1.00       | 1.00 | 1.00 | 1.00       | 1.00 | 1.00 |
| Final Volume:  | 44          | 1333 | 105  | 129         | 664  | 49   | 200        | 416  | 113  | 31         | 235  | 135  |
| Saturation Flow Module:                                  |             |      |      |             |      |      |            |      |      |            |      |      |
| Sat/Lane:  | 1900        | 1900 | 1900 | 1900        | 1900 | 1900 | 1900       | 1900 | 1900 | 1900       | 1900 | 1900 |
| Adjustment:  | 0.92        | 1.00 | 0.92 | 0.92        | 1.00 | 0.92 | 0.92       | 0.98 | 0.95 | 0.92       | 1.00 | 0.92 |
| Lanes:   | 1.00        | 2.00 | 1.00 | 1.00        | 2.00 | 1.00 | 1.00       | 1.56 | 0.44 | 1.00       | 2.00 | 1.00 |
| Final Sat.:  | 1750        | 3800 | 1750 | 1750        | 3800 | 1750 | 1750       | 2909 | 790  | 1750       | 3800 | 1750 |
| Capacity Analysis Module:                                |             |      |      |             |      |      |            |      |      |            |      |      |
| Vol/Sat:   | 0.03        | 0.35 | 0.06 | 0.07        | 0.17 | 0.03 | 0.11       | 0.14 | 0.14 | 0.02       | 0.06 | 0.08 |
| Crit Moves:  | ****        | **** | **** | ****        | **** | **** | ****       | **** | **** | ****       | **** | **** |
| Green Time:  | 20.0        | 78.6 | 78.6 | 16.5        | 75.1 | 75.1 | 25.6       | 32.3 | 32.3 | 10.6       | 17.3 | 17.3 |
| Volume/Cap:  | 0.19        | 0.67 | 0.11 | 0.67        | 0.35 | 0.06 | 0.67       | 0.66 | 0.66 | 0.25       | 0.54 | 0.67 |
| Delay/Veh:   | 58.1        | 27.1 | 18.1 | 72.9        | 22.8 | 19.3 | 64.0       | 56.0 | 56.0 | 67.1       | 63.9 | 72.0 |
| User DelAdj:   | 1.00        | 1.00 | 1.00 | 1.00        | 1.00 | 1.00 | 1.00       | 1.00 | 1.00 | 1.00       | 1.00 | 1.00 |
| AdjDel/Veh:  | 58.1        | 27.1 | 18.1 | 72.9        | 22.8 | 19.3 | 64.0       | 56.0 | 56.0 | 67.1       | 63.9 | 72.0 |
| LOS by Move:   | E           | C    | B    | E           | C    | B    | E          | E    | E    | E          | E    | E    |
| HCM2k95thQ:  | 4           | 36   | 5    | 12          | 17   | 2    | 19         | 22   | 22   | 3          | 9    | 12   |

Note: Queue reported is the number of cars per lane.



BART

Level Of Service Computation Report  
 2000 HCM Operations (Future Volume Alternative)  
 PM - Background Conditions

Intersection #3057: The Alameda/Hedding [Study Int 58]

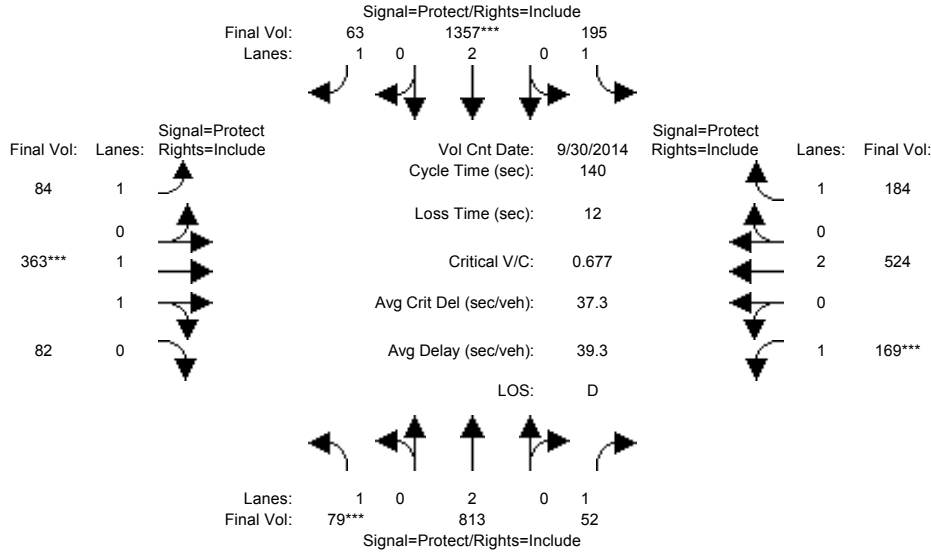

| Approach:  | North Bound |      |      | South Bound |      |      | East Bound |      |      | West Bound |      |      |
|--|-------------|------|------|-------------|------|------|------------|------|------|------------|------|------|
| Movement:  | L           | T    | R    | L           | T    | R    | L          | T    | R    | L          | T    | R    |
| Min. Green:  | 7           | 10   | 10   | 7           | 10   | 10   | 7          | 10   | 10   | 7          | 10   | 10   |
| Y+R:   | 4.0         | 4.0  | 4.0  | 4.0         | 4.0  | 4.0  | 4.0        | 4.0  | 4.0  | 4.0        | 4.0  | 4.0  |
| Volume Module: >> Count Date: 30 Sep 2014 << 5:00-6:00PM |             |      |      |             |      |      |            |      |      |            |      |      |
| Base Vol:  | 79          | 813  | 52   | 195         | 1357 | 63   | 84         | 363  | 82   | 169        | 524  | 184  |
| Growth Adj:  | 1.00        | 1.00 | 1.00 | 1.00        | 1.00 | 1.00 | 1.00       | 1.00 | 1.00 | 1.00       | 1.00 | 1.00 |
| Initial Bse:   | 79          | 813  | 52   | 195         | 1357 | 63   | 84         | 363  | 82   | 169        | 524  | 184  |
| Added Vol:   | 0           | 0    | 0    | 0           | 0    | 0    | 0          | 0    | 0    | 0          | 0    | 0    |
| PasserByVol:   | 0           | 0    | 0    | 0           | 0    | 0    | 0          | 0    | 0    | 0          | 0    | 0    |
| Initial Fut:   | 79          | 813  | 52   | 195         | 1357 | 63   | 84         | 363  | 82   | 169        | 524  | 184  |
| User Adj:  | 1.00        | 1.00 | 1.00 | 1.00        | 1.00 | 1.00 | 1.00       | 1.00 | 1.00 | 1.00       | 1.00 | 1.00 |
| PHF Adj:   | 1.00        | 1.00 | 1.00 | 1.00        | 1.00 | 1.00 | 1.00       | 1.00 | 1.00 | 1.00       | 1.00 | 1.00 |
| PHF Volume:  | 79          | 813  | 52   | 195         | 1357 | 63   | 84         | 363  | 82   | 169        | 524  | 184  |
| Reduct Vol:  | 0           | 0    | 0    | 0           | 0    | 0    | 0          | 0    | 0    | 0          | 0    | 0    |
| Reduced Vol:   | 79          | 813  | 52   | 195         | 1357 | 63   | 84         | 363  | 82   | 169        | 524  | 184  |
| PCE Adj:   | 1.00        | 1.00 | 1.00 | 1.00        | 1.00 | 1.00 | 1.00       | 1.00 | 1.00 | 1.00       | 1.00 | 1.00 |
| MLF Adj:   | 1.00        | 1.00 | 1.00 | 1.00        | 1.00 | 1.00 | 1.00       | 1.00 | 1.00 | 1.00       | 1.00 | 1.00 |
| FinalVolume:   | 79          | 813  | 52   | 195         | 1357 | 63   | 84         | 363  | 82   | 169        | 524  | 184  |
| Saturation Flow Module:                                  |             |      |      |             |      |      |            |      |      |            |      |      |
| Sat/Lane:  | 1900        | 1900 | 1900 | 1900        | 1900 | 1900 | 1900       | 1900 | 1900 | 1900       | 1900 | 1900 |
| Adjustment:  | 0.92        | 1.00 | 0.92 | 0.92        | 1.00 | 0.92 | 0.92       | 0.98 | 0.95 | 0.92       | 1.00 | 0.92 |
| Lanes:   | 1.00        | 2.00 | 1.00 | 1.00        | 2.00 | 1.00 | 1.00       | 1.62 | 0.38 | 1.00       | 2.00 | 1.00 |
| Final Sat.:  | 1750        | 3800 | 1750 | 1750        | 3800 | 1750 | 1750       | 3018 | 682  | 1750       | 3800 | 1750 |
| Capacity Analysis Module:                                |             |      |      |             |      |      |            |      |      |            |      |      |
| Vol/Sat:   | 0.05        | 0.21 | 0.03 | 0.11        | 0.36 | 0.04 | 0.05       | 0.12 | 0.12 | 0.10       | 0.14 | 0.11 |
| Crit Moves:  | ****        |      |      | ****        |      |      | ****       |      |      | ****       |      |      |
| Green Time:  | 9.3         | 54.7 | 54.7 | 28.5        | 73.8 | 73.8 | 11.9       | 24.9 | 24.9 | 20.0       | 32.9 | 32.9 |
| Volume/Cap:  | 0.68        | 0.55 | 0.08 | 0.55        | 0.68 | 0.07 | 0.56       | 0.68 | 0.68 | 0.68       | 0.59 | 0.45 |
| Delay/Veh:   | 78.6        | 33.5 | 26.8 | 51.8        | 25.3 | 16.3 | 66.4       | 56.6 | 56.6 | 64.2       | 48.5 | 46.6 |
| User DelAdj:   | 1.00        | 1.00 | 1.00 | 1.00        | 1.00 | 1.00 | 1.00       | 1.00 | 1.00 | 1.00       | 1.00 | 1.00 |
| AdjDel/Veh:  | 78.6        | 33.5 | 26.8 | 51.8        | 25.3 | 16.3 | 66.4       | 56.6 | 56.6 | 64.2       | 48.5 | 46.6 |
| LOS by Move:   | E           | C    | C    | D           | C    | B    | E          | E    | E    | E          | D    | D    |
| HCM2k95thQ:  | 7           | 23   | 3    | 15          | 35   | 3    | 9          | 19   | 19   | 14         | 18   | 13   |

Note: Queue reported is the number of cars per lane.

BART

Level Of Service Computation Report  
2000 HCM Operations (Future Volume Alternative)  
AM - Background Conditions

Intersection #3058: The Alameda/Naglee [Study Int 59]

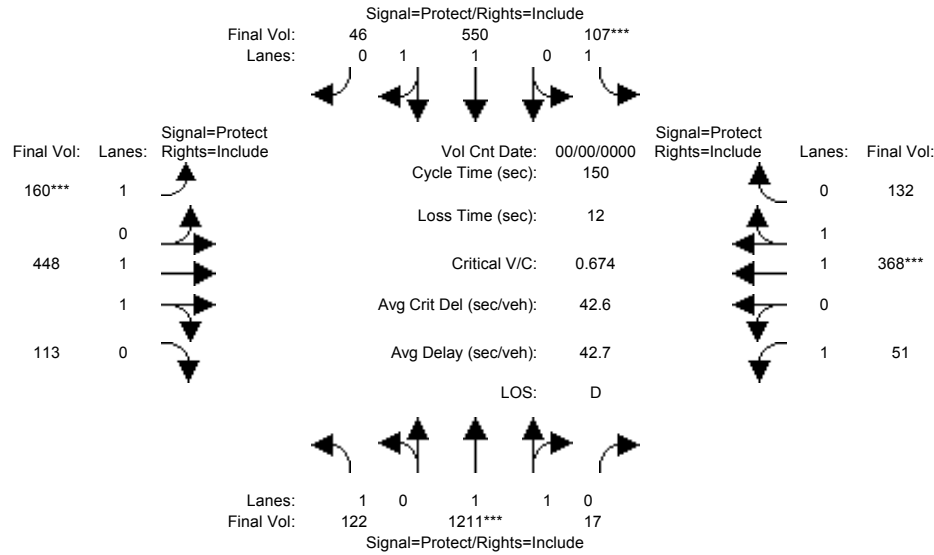

| Approach:                               | North Bound |      |      | South Bound |      |      | East Bound |      |      | West Bound |      |      |
|---|-------------|------|------|-------------|------|------|------------|------|------|------------|------|------|
| Movement:                               | L           | T    | R    | L           | T    | R    | L          | T    | R    | L          | T    | R    |
| Min. Green:                             | 7           | 10   | 10   | 7           | 10   | 10   | 7          | 10   | 10   | 7          | 10   | 10   |
| Y+R:                                    | 4.0         | 4.0  | 4.0  | 4.0         | 4.0  | 4.0  | 4.0        | 4.0  | 4.0  | 4.0        | 4.0  | 4.0  |
| Volume Module: >> Count Date: 0 0 << AM |             |      |      |             |      |      |            |      |      |            |      |      |
| Base Vol:                               | 122         | 1211 | 17   | 107         | 550  | 46   | 160        | 448  | 113  | 51         | 368  | 132  |
| Growth Adj:                             | 1.00        | 1.00 | 1.00 | 1.00        | 1.00 | 1.00 | 1.00       | 1.00 | 1.00 | 1.00       | 1.00 | 1.00 |
| Initial Bse:                            | 122         | 1211 | 17   | 107         | 550  | 46   | 160        | 448  | 113  | 51         | 368  | 132  |
| Added Vol:                              | 0           | 0    | 0    | 0           | 0    | 0    | 0          | 0    | 0    | 0          | 0    | 0    |
| PasserByVol:                            | 0           | 0    | 0    | 0           | 0    | 0    | 0          | 0    | 0    | 0          | 0    | 0    |
| Initial Fut:                            | 122         | 1211 | 17   | 107         | 550  | 46   | 160        | 448  | 113  | 51         | 368  | 132  |
| User Adj:                               | 1.00        | 1.00 | 1.00 | 1.00        | 1.00 | 1.00 | 1.00       | 1.00 | 1.00 | 1.00       | 1.00 | 1.00 |
| PHF Adj:                                | 1.00        | 1.00 | 1.00 | 1.00        | 1.00 | 1.00 | 1.00       | 1.00 | 1.00 | 1.00       | 1.00 | 1.00 |
| PHF Volume:                             | 122         | 1211 | 17   | 107         | 550  | 46   | 160        | 448  | 113  | 51         | 368  | 132  |
| Reduct Vol:                             | 0           | 0    | 0    | 0           | 0    | 0    | 0          | 0    | 0    | 0          | 0    | 0    |
| Reduced Vol:                            | 122         | 1211 | 17   | 107         | 550  | 46   | 160        | 448  | 113  | 51         | 368  | 132  |
| PCE Adj:                                | 1.00        | 1.00 | 1.00 | 1.00        | 1.00 | 1.00 | 1.00       | 1.00 | 1.00 | 1.00       | 1.00 | 1.00 |
| MLF Adj:                                | 1.00        | 1.00 | 1.00 | 1.00        | 1.00 | 1.00 | 1.00       | 1.00 | 1.00 | 1.00       | 1.00 | 1.00 |
| Final Volume:                           | 122         | 1211 | 17   | 107         | 550  | 46   | 160        | 448  | 113  | 51         | 368  | 132  |
| Saturation Flow Module:                 |             |      |      |             |      |      |            |      |      |            |      |      |
| Sat/Lane:                               | 1900        | 1900 | 1900 | 1900        | 1900 | 1900 | 1900       | 1900 | 1900 | 1900       | 1900 | 1900 |
| Adjustment:                             | 0.92        | 0.97 | 0.95 | 0.92        | 0.98 | 0.95 | 0.92       | 0.98 | 0.95 | 0.92       | 0.98 | 0.95 |
| Lanes:                                  | 1.00        | 1.97 | 0.03 | 1.00        | 1.84 | 0.16 | 1.00       | 1.59 | 0.41 | 1.00       | 1.46 | 0.54 |
| Final Sat.:                             | 1750        | 3649 | 51   | 1750        | 3414 | 286  | 1750       | 2954 | 745  | 1750       | 2722 | 977  |
| Capacity Analysis Module:               |             |      |      |             |      |      |            |      |      |            |      |      |
| Vol/Sat:                                | 0.07        | 0.33 | 0.33 | 0.06        | 0.16 | 0.16 | 0.09       | 0.15 | 0.15 | 0.03       | 0.14 | 0.14 |
| Crit Moves:                             | ****        | **** | **** | ****        | **** | **** | ****       | **** | **** | ****       | **** | **** |
| Green Time:                             | 26.4        | 73.9 | 73.9 | 13.6        | 61.1 | 61.1 | 20.4       | 38.6 | 38.6 | 11.9       | 30.1 | 30.1 |
| Volume/Cap:                             | 0.40        | 0.67 | 0.67 | 0.67        | 0.40 | 0.40 | 0.67       | 0.59 | 0.59 | 0.37       | 0.67 | 0.67 |
| Delay/Veh:                              | 55.5        | 29.9 | 29.9 | 76.9        | 31.6 | 31.6 | 69.1       | 49.8 | 49.8 | 67.2       | 57.9 | 57.9 |
| User DelAdj:                            | 1.00        | 1.00 | 1.00 | 1.00        | 1.00 | 1.00 | 1.00       | 1.00 | 1.00 | 1.00       | 1.00 | 1.00 |
| AdjDel/Veh:                             | 55.5        | 29.9 | 29.9 | 76.9        | 31.6 | 31.6 | 69.1       | 49.8 | 49.8 | 67.2       | 57.9 | 57.9 |
| LOS by Move:                            | E           | C    | C    | E           | C    | C    | E          | D    | D    | E          | E    | E    |
| HCM2k95thQ:                             | 11          | 37   | 37   | 10          | 18   | 18   | 16         | 21   | 21   | 5          | 20   | 20   |

Note: Queue reported is the number of cars per lane.

BART

Level Of Service Computation Report  
2000 HCM Operations (Future Volume Alternative)  
PM - Background Conditions

Intersection #3058: The Alameda/Naglee [Study Int 59]

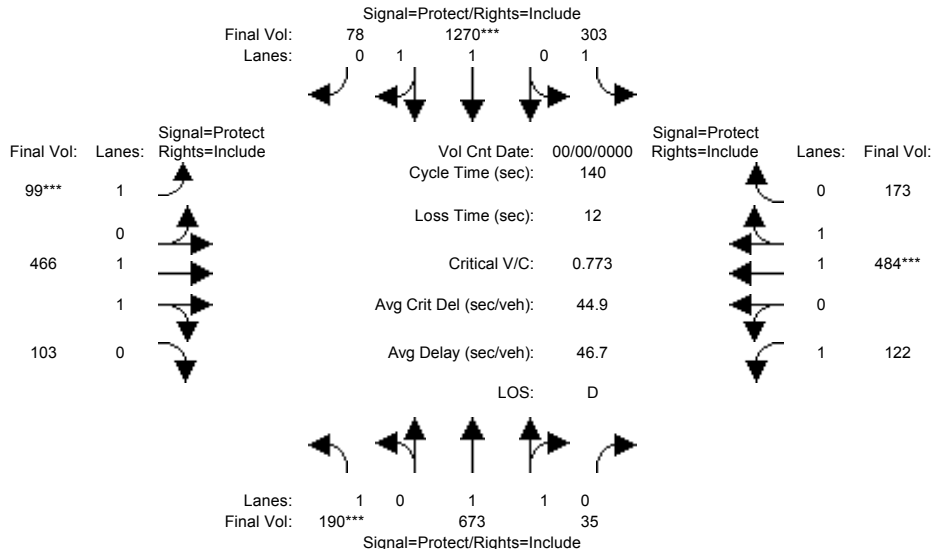

| Approach:                               | North Bound |      |      | South Bound |      |      | East Bound |      |      | West Bound |      |      |
|---|-------------|------|------|-------------|------|------|------------|------|------|------------|------|------|
| Movement:                               | L           | T    | R    | L           | T    | R    | L          | T    | R    | L          | T    | R    |
| Min. Green:                             | 7           | 10   | 10   | 7           | 10   | 10   | 7          | 10   | 10   | 7          | 10   | 10   |
| Y+R:                                    | 4.0         | 4.0  | 4.0  | 4.0         | 4.0  | 4.0  | 4.0        | 4.0  | 4.0  | 4.0        | 4.0  | 4.0  |
| Volume Module: >> Count Date: 0 0 << AM |             |      |      |             |      |      |            |      |      |            |      |      |
| Base Vol:                               | 190         | 673  | 35   | 303         | 1270 | 78   | 99         | 466  | 103  | 122        | 484  | 173  |
| Growth Adj:                             | 1.00        | 1.00 | 1.00 | 1.00        | 1.00 | 1.00 | 1.00       | 1.00 | 1.00 | 1.00       | 1.00 | 1.00 |
| Initial Bse:                            | 190         | 673  | 35   | 303         | 1270 | 78   | 99         | 466  | 103  | 122        | 484  | 173  |
| Added Vol:                              | 0           | 0    | 0    | 0           | 0    | 0    | 0          | 0    | 0    | 0          | 0    | 0    |
| PasserByVol:                            | 0           | 0    | 0    | 0           | 0    | 0    | 0          | 0    | 0    | 0          | 0    | 0    |
| Initial Fut:                            | 190         | 673  | 35   | 303         | 1270 | 78   | 99         | 466  | 103  | 122        | 484  | 173  |
| User Adj:                               | 1.00        | 1.00 | 1.00 | 1.00        | 1.00 | 1.00 | 1.00       | 1.00 | 1.00 | 1.00       | 1.00 | 1.00 |
| PHF Adj:                                | 1.00        | 1.00 | 1.00 | 1.00        | 1.00 | 1.00 | 1.00       | 1.00 | 1.00 | 1.00       | 1.00 | 1.00 |
| PHF Volume:                             | 190         | 673  | 35   | 303         | 1270 | 78   | 99         | 466  | 103  | 122        | 484  | 173  |
| Reduct Vol:                             | 0           | 0    | 0    | 0           | 0    | 0    | 0          | 0    | 0    | 0          | 0    | 0    |
| Reduced Vol:                            | 190         | 673  | 35   | 303         | 1270 | 78   | 99         | 466  | 103  | 122        | 484  | 173  |
| PCE Adj:                                | 1.00        | 1.00 | 1.00 | 1.00        | 1.00 | 1.00 | 1.00       | 1.00 | 1.00 | 1.00       | 1.00 | 1.00 |
| MLF Adj:                                | 1.00        | 1.00 | 1.00 | 1.00        | 1.00 | 1.00 | 1.00       | 1.00 | 1.00 | 1.00       | 1.00 | 1.00 |
| FinalVolume:                            | 190         | 673  | 35   | 303         | 1270 | 78   | 99         | 466  | 103  | 122        | 484  | 173  |
| Saturation Flow Module:                 |             |      |      |             |      |      |            |      |      |            |      |      |
| Sat/Lane:                               | 1900        | 1900 | 1900 | 1900        | 1900 | 1900 | 1900       | 1900 | 1900 | 1900       | 1900 | 1900 |
| Adjustment:                             | 0.92        | 0.98 | 0.95 | 0.92        | 0.98 | 0.95 | 0.92       | 0.98 | 0.95 | 0.92       | 0.98 | 0.95 |
| Lanes:                                  | 1.00        | 1.90 | 0.10 | 1.00        | 1.88 | 0.12 | 1.00       | 1.63 | 0.37 | 1.00       | 1.46 | 0.54 |
| Final Sat.:                             | 1750        | 3517 | 183  | 1750        | 3486 | 214  | 1750       | 3030 | 670  | 1750       | 2725 | 974  |
| Capacity Analysis Module:               |             |      |      |             |      |      |            |      |      |            |      |      |
| Vol/Sat:                                | 0.11        | 0.19 | 0.19 | 0.17        | 0.36 | 0.36 | 0.06       | 0.15 | 0.15 | 0.07       | 0.18 | 0.18 |
| Crit Moves:                             | ****        | **** | **** | ****        | **** | **** | ****       | **** | **** | ****       | **** | **** |
| Green Time:                             | 19.7        | 44.9 | 44.9 | 40.7        | 66.0 | 66.0 | 10.2       | 29.2 | 29.2 | 13.2       | 32.2 | 32.2 |
| Volume/Cap:                             | 0.77        | 0.60 | 0.60 | 0.60        | 0.77 | 0.77 | 0.77       | 0.74 | 0.74 | 0.74       | 0.77 | 0.77 |
| Delay/Veh:                              | 72.1        | 40.7 | 40.7 | 44.6        | 33.0 | 33.0 | 88.5       | 55.6 | 55.6 | 77.7       | 55.0 | 55.0 |
| User DelAdj:                            | 1.00        | 1.00 | 1.00 | 1.00        | 1.00 | 1.00 | 1.00       | 1.00 | 1.00 | 1.00       | 1.00 | 1.00 |
| AdjDel/Veh:                             | 72.1        | 40.7 | 40.7 | 44.6        | 33.0 | 33.0 | 88.5       | 55.6 | 55.6 | 77.7       | 55.0 | 55.0 |
| LOS by Move:                            | E           | D    | D    | D           | C    | C    | F          | E    | E    | E          | D    | D    |
| HCM2k95thQ:                             | 19          | 24   | 24   | 21          | 40   | 40   | 12         | 23   | 23   | 11         | 24   | 24   |

Note: Queue reported is the number of cars per lane.

BART

Level Of Service Computation Report  
 2000 HCM Operations (Future Volume Alternative)  
 AM - Background Conditions

Intersection #3063: ALUM ROCK/JACKSON [Study Int 18]

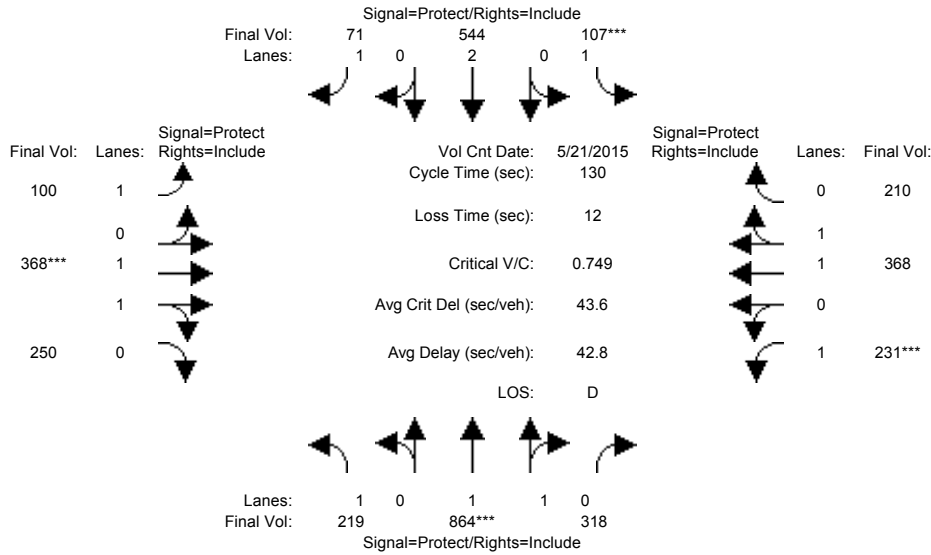

| Approach:  | North Bound |      |      | South Bound |      |      | East Bound |      |      | West Bound |      |      |
|--|-------------|------|------|-------------|------|------|------------|------|------|------------|------|------|
| Movement:  | L           | T    | R    | L           | T    | R    | L          | T    | R    | L          | T    | R    |
| Min. Green:  | 7           | 10   | 10   | 7           | 10   | 10   | 7          | 10   | 10   | 7          | 10   | 10   |
| Y+R:   | 4.0         | 4.0  | 4.0  | 4.0         | 4.0  | 4.0  | 4.0        | 4.0  | 4.0  | 4.0        | 4.0  | 4.0  |
| Volume Module: >> Count Date: 21 May 2015 << 7:45-8:45AM |             |      |      |             |      |      |            |      |      |            |      |      |
| Base Vol:  | 219         | 864  | 318  | 107         | 544  | 71   | 100        | 368  | 250  | 231        | 368  | 210  |
| Growth Adj:  | 1.00        | 1.00 | 1.00 | 1.00        | 1.00 | 1.00 | 1.00       | 1.00 | 1.00 | 1.00       | 1.00 | 1.00 |
| Initial Bse:   | 219         | 864  | 318  | 107         | 544  | 71   | 100        | 368  | 250  | 231        | 368  | 210  |
| Added Vol:   | 0           | 0    | 0    | 0           | 0    | 0    | 0          | 0    | 0    | 0          | 0    | 0    |
| PasserByVol:   | 0           | 0    | 0    | 0           | 0    | 0    | 0          | 0    | 0    | 0          | 0    | 0    |
| Initial Fut:   | 219         | 864  | 318  | 107         | 544  | 71   | 100        | 368  | 250  | 231        | 368  | 210  |
| User Adj:  | 1.00        | 1.00 | 1.00 | 1.00        | 1.00 | 1.00 | 1.00       | 1.00 | 1.00 | 1.00       | 1.00 | 1.00 |
| PHF Adj:   | 1.00        | 1.00 | 1.00 | 1.00        | 1.00 | 1.00 | 1.00       | 1.00 | 1.00 | 1.00       | 1.00 | 1.00 |
| PHF Volume:  | 219         | 864  | 318  | 107         | 544  | 71   | 100        | 368  | 250  | 231        | 368  | 210  |
| Reduct Vol:  | 0           | 0    | 0    | 0           | 0    | 0    | 0          | 0    | 0    | 0          | 0    | 0    |
| Reduced Vol:   | 219         | 864  | 318  | 107         | 544  | 71   | 100        | 368  | 250  | 231        | 368  | 210  |
| PCE Adj:   | 1.00        | 1.00 | 1.00 | 1.00        | 1.00 | 1.00 | 1.00       | 1.00 | 1.00 | 1.00       | 1.00 | 1.00 |
| MLF Adj:   | 1.00        | 1.00 | 1.00 | 1.00        | 1.00 | 1.00 | 1.00       | 1.00 | 1.00 | 1.00       | 1.00 | 1.00 |
| Final Volume:  | 219         | 864  | 318  | 107         | 544  | 71   | 100        | 368  | 250  | 231        | 368  | 210  |
| Saturation Flow Module:                                  |             |      |      |             |      |      |            |      |      |            |      |      |
| Sat/Lane:  | 1900        | 1900 | 1900 | 1900        | 1900 | 1900 | 1900       | 1900 | 1900 | 1900       | 1900 | 1900 |
| Adjustment:  | 0.92        | 0.98 | 0.95 | 0.92        | 1.00 | 0.92 | 0.92       | 0.99 | 0.95 | 0.92       | 0.99 | 0.95 |
| Lanes:   | 1.00        | 1.45 | 0.55 | 1.00        | 2.00 | 1.00 | 1.00       | 1.17 | 0.83 | 1.00       | 1.25 | 0.75 |
| Final Sat.:  | 1750        | 2704 | 995  | 1750        | 3800 | 1750 | 1750       | 2202 | 1496 | 1750       | 2355 | 1344 |
| Capacity Analysis Module:                                |             |      |      |             |      |      |            |      |      |            |      |      |
| Vol/Sat:   | 0.13        | 0.32 | 0.32 | 0.06        | 0.14 | 0.04 | 0.06       | 0.17 | 0.17 | 0.13       | 0.16 | 0.16 |
| Crit Moves:  | ****        | **** | **** | ****        | **** | **** | ****       | **** | **** | ****       | **** | **** |
| Green Time:  | 30.8        | 55.5 | 55.5 | 10.6        | 35.3 | 35.3 | 13.9       | 29.0 | 29.0 | 22.9       | 38.0 | 38.0 |
| Volume/Cap:  | 0.53        | 0.75 | 0.75 | 0.75        | 0.53 | 0.15 | 0.53       | 0.75 | 0.75 | 0.75       | 0.53 | 0.53 |
| Delay/Veh:   | 44.5        | 33.4 | 33.4 | 77.9        | 40.8 | 36.1 | 58.0       | 50.9 | 50.9 | 60.6       | 39.1 | 39.1 |
| User DelAdj:   | 1.00        | 1.00 | 1.00 | 1.00        | 1.00 | 1.00 | 1.00       | 1.00 | 1.00 | 1.00       | 1.00 | 1.00 |
| AdjDel/Veh:  | 44.5        | 33.4 | 33.4 | 77.9        | 40.8 | 36.1 | 58.0       | 50.9 | 50.9 | 60.6       | 39.1 | 39.1 |
| LOS by Move:   | D           | C    | C    | E           | D    | D    | E          | D    | D    | E          | D    | D    |
| HCM2k95thQ:  | 16          | 36   | 36   | 12          | 18   | 5    | 8          | 22   | 22   | 18         | 18   | 18   |

Note: Queue reported is the number of cars per lane.

BART

Level Of Service Computation Report  
 2000 HCM Operations (Future Volume Alternative)  
 PM - Background Conditions

Intersection #3063: ALUM ROCK/JACKSON [Study Int 18]

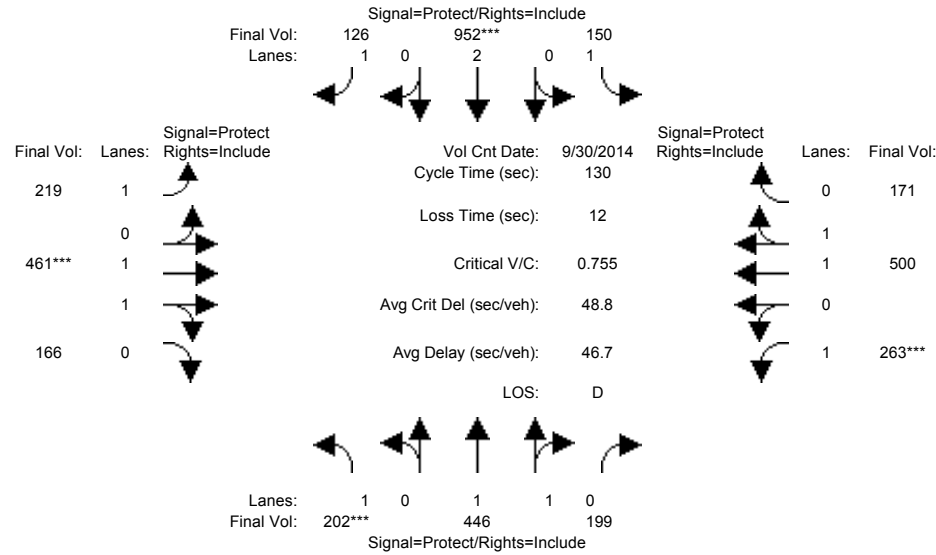

| Approach:  | North Bound |      |      | South Bound |      |      | East Bound |      |      | West Bound |      |      |
|--|-------------|------|------|-------------|------|------|------------|------|------|------------|------|------|
| Movement:  | L           | T    | R    | L           | T    | R    | L          | T    | R    | L          | T    | R    |
| Min. Green:  | 7           | 10   | 10   | 7           | 10   | 10   | 7          | 10   | 10   | 7          | 10   | 10   |
| Y+R:   | 4.0         | 4.0  | 4.0  | 4.0         | 4.0  | 4.0  | 4.0        | 4.0  | 4.0  | 4.0        | 4.0  | 4.0  |
| Volume Module: >> Count Date: 30 Sep 2014 << 4:15-5:15PM |             |      |      |             |      |      |            |      |      |            |      |      |
| Base Vol:  | 202         | 446  | 199  | 150         | 952  | 126  | 219        | 461  | 166  | 263        | 500  | 171  |
| Growth Adj:  | 1.00        | 1.00 | 1.00 | 1.00        | 1.00 | 1.00 | 1.00       | 1.00 | 1.00 | 1.00       | 1.00 | 1.00 |
| Initial Bse:   | 202         | 446  | 199  | 150         | 952  | 126  | 219        | 461  | 166  | 263        | 500  | 171  |
| Added Vol:   | 0           | 0    | 0    | 0           | 0    | 0    | 0          | 0    | 0    | 0          | 0    | 0    |
| PasserByVol:   | 0           | 0    | 0    | 0           | 0    | 0    | 0          | 0    | 0    | 0          | 0    | 0    |
| Initial Fut:   | 202         | 446  | 199  | 150         | 952  | 126  | 219        | 461  | 166  | 263        | 500  | 171  |
| User Adj:  | 1.00        | 1.00 | 1.00 | 1.00        | 1.00 | 1.00 | 1.00       | 1.00 | 1.00 | 1.00       | 1.00 | 1.00 |
| PHF Adj:   | 1.00        | 1.00 | 1.00 | 1.00        | 1.00 | 1.00 | 1.00       | 1.00 | 1.00 | 1.00       | 1.00 | 1.00 |
| PHF Volume:  | 202         | 446  | 199  | 150         | 952  | 126  | 219        | 461  | 166  | 263        | 500  | 171  |
| Reduct Vol:  | 0           | 0    | 0    | 0           | 0    | 0    | 0          | 0    | 0    | 0          | 0    | 0    |
| Reduced Vol:   | 202         | 446  | 199  | 150         | 952  | 126  | 219        | 461  | 166  | 263        | 500  | 171  |
| PCE Adj:   | 1.00        | 1.00 | 1.00 | 1.00        | 1.00 | 1.00 | 1.00       | 1.00 | 1.00 | 1.00       | 1.00 | 1.00 |
| MLF Adj:   | 1.00        | 1.00 | 1.00 | 1.00        | 1.00 | 1.00 | 1.00       | 1.00 | 1.00 | 1.00       | 1.00 | 1.00 |
| Final Volume:  | 202         | 446  | 199  | 150         | 952  | 126  | 219        | 461  | 166  | 263        | 500  | 171  |
| Saturation Flow Module:                                  |             |      |      |             |      |      |            |      |      |            |      |      |
| Sat/Lane:  | 1900        | 1900 | 1900 | 1900        | 1900 | 1900 | 1900       | 1900 | 1900 | 1900       | 1900 | 1900 |
| Adjustment:  | 0.92        | 0.99 | 0.95 | 0.92        | 1.00 | 0.92 | 0.92       | 0.98 | 0.95 | 0.92       | 0.98 | 0.95 |
| Lanes:   | 1.00        | 1.37 | 0.63 | 1.00        | 2.00 | 1.00 | 1.00       | 1.46 | 0.54 | 1.00       | 1.48 | 0.52 |
| Final Sat.:  | 1750        | 2558 | 1141 | 1750        | 3800 | 1750 | 1750       | 2720 | 979  | 1750       | 2756 | 943  |
| Capacity Analysis Module:                                |             |      |      |             |      |      |            |      |      |            |      |      |
| Vol/Sat:   | 0.12        | 0.17 | 0.17 | 0.09        | 0.25 | 0.07 | 0.13       | 0.17 | 0.17 | 0.15       | 0.18 | 0.18 |
| Crit Moves:  | ****        |      |      | ****        |      |      | ****       |      |      | ****       |      |      |
| Green Time:  | 19.9        | 42.2 | 42.2 | 20.8        | 43.1 | 43.1 | 22.5       | 29.2 | 29.2 | 25.9       | 32.6 | 32.6 |
| Volume/Cap:  | 0.76        | 0.54 | 0.54 | 0.54        | 0.76 | 0.22 | 0.72       | 0.76 | 0.76 | 0.76       | 0.72 | 0.72 |
| Delay/Veh:   | 64.4        | 36.4 | 36.4 | 52.3        | 41.4 | 31.5 | 59.2       | 51.1 | 51.1 | 58.2       | 47.5 | 47.5 |
| User DelAdj:   | 1.00        | 1.00 | 1.00 | 1.00        | 1.00 | 1.00 | 1.00       | 1.00 | 1.00 | 1.00       | 1.00 | 1.00 |
| AdjDel/Veh:  | 64.4        | 36.4 | 36.4 | 52.3        | 41.4 | 31.5 | 59.2       | 51.1 | 51.1 | 58.2       | 47.5 | 47.5 |
| LOS by Move:   | E           | D    | D    | D           | D    | C    | E          | D    | D    | E          | D    | D    |
| HCM2k95thQ:  | 18          | 20   | 20   | 12          | 31   | 8    | 17         | 22   | 22   | 20         | 23   | 23   |

Note: Queue reported is the number of cars per lane.

BART

Level Of Service Computation Report  
 2000 HCM Operations (Future Volume Alternative)  
 AM - Background Conditions

Intersection #3064: ALUM ROCK/KING [Study Int 17]

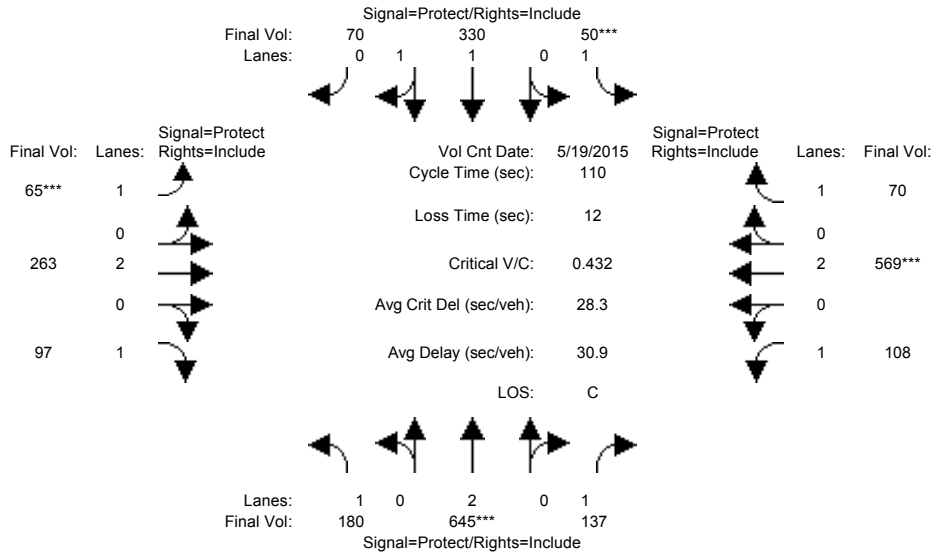

| Approach:  | North Bound |      |      | South Bound |      |      | East Bound |      |      | West Bound |      |      |
|--|-------------|------|------|-------------|------|------|------------|------|------|------------|------|------|
| Movement:  | L           | T    | R    | L           | T    | R    | L          | T    | R    | L          | T    | R    |
| Min. Green:  | 7           | 10   | 10   | 7           | 10   | 10   | 7          | 10   | 10   | 7          | 10   | 10   |
| Y+R:   | 4.0         | 4.0  | 4.0  | 4.0         | 4.0  | 4.0  | 4.0        | 4.0  | 4.0  | 4.0        | 4.0  | 4.0  |
| Volume Module: >> Count Date: 19 May 2015 << 7:45-8:45AM |             |      |      |             |      |      |            |      |      |            |      |      |
| Base Vol:  | 180         | 645  | 137  | 50          | 330  | 70   | 65         | 263  | 97   | 108        | 569  | 70   |
| Growth Adj:  | 1.00        | 1.00 | 1.00 | 1.00        | 1.00 | 1.00 | 1.00       | 1.00 | 1.00 | 1.00       | 1.00 | 1.00 |
| Initial Bse:   | 180         | 645  | 137  | 50          | 330  | 70   | 65         | 263  | 97   | 108        | 569  | 70   |
| Added Vol:   | 0           | 0    | 0    | 0           | 0    | 0    | 0          | 0    | 0    | 0          | 0    | 0    |
| PasserByVol:   | 0           | 0    | 0    | 0           | 0    | 0    | 0          | 0    | 0    | 0          | 0    | 0    |
| Initial Fut:   | 180         | 645  | 137  | 50          | 330  | 70   | 65         | 263  | 97   | 108        | 569  | 70   |
| User Adj:  | 1.00        | 1.00 | 1.00 | 1.00        | 1.00 | 1.00 | 1.00       | 1.00 | 1.00 | 1.00       | 1.00 | 1.00 |
| PHF Adj:   | 1.00        | 1.00 | 1.00 | 1.00        | 1.00 | 1.00 | 1.00       | 1.00 | 1.00 | 1.00       | 1.00 | 1.00 |
| PHF Volume:  | 180         | 645  | 137  | 50          | 330  | 70   | 65         | 263  | 97   | 108        | 569  | 70   |
| Reduct Vol:  | 0           | 0    | 0    | 0           | 0    | 0    | 0          | 0    | 0    | 0          | 0    | 0    |
| Reduced Vol:   | 180         | 645  | 137  | 50          | 330  | 70   | 65         | 263  | 97   | 108        | 569  | 70   |
| PCE Adj:   | 1.00        | 1.00 | 1.00 | 1.00        | 1.00 | 1.00 | 1.00       | 1.00 | 1.00 | 1.00       | 1.00 | 1.00 |
| MLF Adj:   | 1.00        | 1.00 | 1.00 | 1.00        | 1.00 | 1.00 | 1.00       | 1.00 | 1.00 | 1.00       | 1.00 | 1.00 |
| Final Volume:  | 180         | 645  | 137  | 50          | 330  | 70   | 65         | 263  | 97   | 108        | 569  | 70   |
| Saturation Flow Module:                                  |             |      |      |             |      |      |            |      |      |            |      |      |
| Sat/Lane:  | 1900        | 1900 | 1900 | 1900        | 1900 | 1900 | 1900       | 1900 | 1900 | 1900       | 1900 | 1900 |
| Adjustment:  | 0.92        | 1.00 | 0.92 | 0.92        | 0.98 | 0.95 | 0.92       | 1.00 | 0.92 | 0.92       | 1.00 | 0.92 |
| Lanes:   | 1.00        | 2.00 | 1.00 | 1.00        | 1.64 | 0.36 | 1.00       | 2.00 | 1.00 | 1.00       | 2.00 | 1.00 |
| Final Sat.:  | 1750        | 3800 | 1750 | 1750        | 3052 | 647  | 1750       | 3800 | 1750 | 1750       | 3800 | 1750 |
| Capacity Analysis Module:                                |             |      |      |             |      |      |            |      |      |            |      |      |
| Vol/Sat:   | 0.10        | 0.17 | 0.08 | 0.03        | 0.11 | 0.11 | 0.04       | 0.07 | 0.06 | 0.06       | 0.15 | 0.04 |
| Crit Moves:  | ****        | **** | **** | ****        | **** | **** | ****       | **** | **** | ****       | **** | **** |
| Green Time:  | 24.6        | 43.2 | 43.2 | 7.3         | 25.9 | 25.9 | 9.4        | 28.0 | 28.0 | 19.6       | 38.1 | 38.1 |
| Volume/Cap:  | 0.46        | 0.43 | 0.20 | 0.43        | 0.46 | 0.46 | 0.43       | 0.27 | 0.22 | 0.35       | 0.43 | 0.12 |
| Delay/Veh:   | 37.8        | 24.6 | 22.2 | 52.0        | 36.5 | 36.5 | 49.7       | 33.0 | 32.6 | 40.3       | 27.9 | 24.6 |
| User DelAdj:   | 1.00        | 1.00 | 1.00 | 1.00        | 1.00 | 1.00 | 1.00       | 1.00 | 1.00 | 1.00       | 1.00 | 1.00 |
| AdjDel/Veh:  | 37.8        | 24.6 | 22.2 | 52.0        | 36.5 | 36.5 | 49.7       | 33.0 | 32.6 | 40.3       | 27.9 | 24.6 |
| LOS by Move:   | D           | C    | C    | D           | D    | D    | D          | C    | C    | D          | C    | C    |
| HCM2k95thQ:  | 11          | 15   | 6    | 4           | 11   | 11   | 5          | 7    | 5    | 7          | 14   | 4    |

Note: Queue reported is the number of cars per lane.

BART

Level Of Service Computation Report  
2000 HCM Operations (Future Volume Alternative)  
PM - Background Conditions

Intersection #3064: ALUM ROCK/KING [Study Int 17]

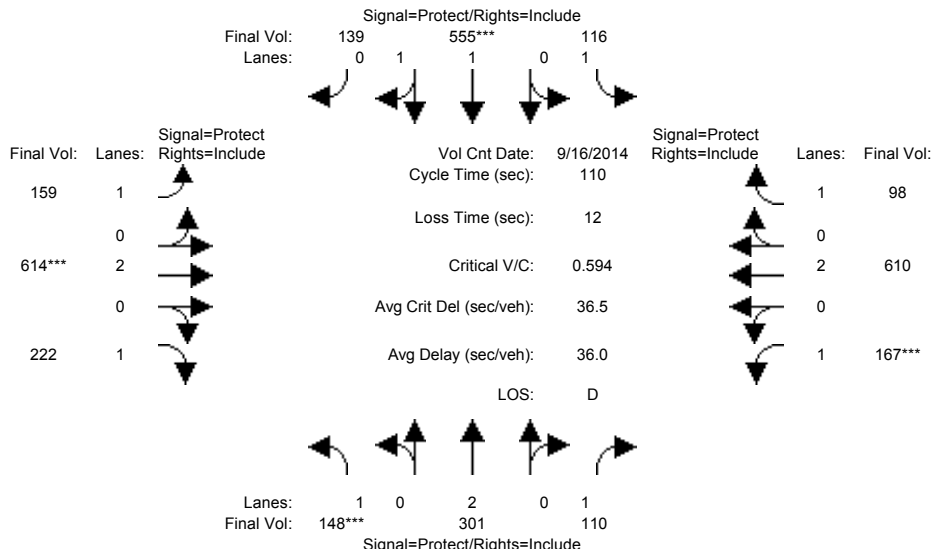

| Approach:   | North Bound |      |      | South Bound |      |      | East Bound |      |      | West Bound |      |      |
|---|-------------|------|------|-------------|------|------|------------|------|------|------------|------|------|
| Movement:   | L           | T    | R    | L           | T    | R    | L          | T    | R    | L          | T    | R    |
| Min. Green:   | 7           | 10   | 10   | 7           | 10   | 10   | 7          | 10   | 10   | 7          | 10   | 10   |
| Y+R:  | 4.0         | 4.0  | 4.0  | 4.0         | 4.0  | 4.0  | 4.0        | 4.0  | 4.0  | 4.0        | 4.0  | 4.0  |
| Volume Module: >> Count Date: 16 Sep 2014 << 5:00 - 6:00 PM |             |      |      |             |      |      |            |      |      |            |      |      |
| Base Vol:   | 148         | 301  | 110  | 116         | 555  | 139  | 159        | 614  | 222  | 167        | 610  | 98   |
| Growth Adj:   | 1.00        | 1.00 | 1.00 | 1.00        | 1.00 | 1.00 | 1.00       | 1.00 | 1.00 | 1.00       | 1.00 | 1.00 |
| Initial Bse:  | 148         | 301  | 110  | 116         | 555  | 139  | 159        | 614  | 222  | 167        | 610  | 98   |
| Added Vol:  | 0           | 0    | 0    | 0           | 0    | 0    | 0          | 0    | 0    | 0          | 0    | 0    |
| PasserByVol:  | 0           | 0    | 0    | 0           | 0    | 0    | 0          | 0    | 0    | 0          | 0    | 0    |
| Initial Fut:  | 148         | 301  | 110  | 116         | 555  | 139  | 159        | 614  | 222  | 167        | 610  | 98   |
| User Adj:   | 1.00        | 1.00 | 1.00 | 1.00        | 1.00 | 1.00 | 1.00       | 1.00 | 1.00 | 1.00       | 1.00 | 1.00 |
| PHF Adj:  | 1.00        | 1.00 | 1.00 | 1.00        | 1.00 | 1.00 | 1.00       | 1.00 | 1.00 | 1.00       | 1.00 | 1.00 |
| PHF Volume:   | 148         | 301  | 110  | 116         | 555  | 139  | 159        | 614  | 222  | 167        | 610  | 98   |
| Reduct Vol:   | 0           | 0    | 0    | 0           | 0    | 0    | 0          | 0    | 0    | 0          | 0    | 0    |
| Reduced Vol:  | 148         | 301  | 110  | 116         | 555  | 139  | 159        | 614  | 222  | 167        | 610  | 98   |
| PCE Adj:  | 1.00        | 1.00 | 1.00 | 1.00        | 1.00 | 1.00 | 1.00       | 1.00 | 1.00 | 1.00       | 1.00 | 1.00 |
| MLF Adj:  | 1.00        | 1.00 | 1.00 | 1.00        | 1.00 | 1.00 | 1.00       | 1.00 | 1.00 | 1.00       | 1.00 | 1.00 |
| Final Volume:   | 148         | 301  | 110  | 116         | 555  | 139  | 159        | 614  | 222  | 167        | 610  | 98   |
| Saturation Flow Module:                                     |             |      |      |             |      |      |            |      |      |            |      |      |
| Sat/Lane:   | 1900        | 1900 | 1900 | 1900        | 1900 | 1900 | 1900       | 1900 | 1900 | 1900       | 1900 | 1900 |
| Adjustment:   | 0.92        | 1.00 | 0.92 | 0.92        | 0.98 | 0.95 | 0.92       | 1.00 | 0.92 | 0.92       | 1.00 | 0.92 |
| Lanes:  | 1.00        | 2.00 | 1.00 | 1.00        | 1.59 | 0.41 | 1.00       | 2.00 | 1.00 | 1.00       | 2.00 | 1.00 |
| Final Sat.:   | 1750        | 3800 | 1750 | 1750        | 2958 | 741  | 1750       | 3800 | 1750 | 1750       | 3800 | 1750 |
| Capacity Analysis Module:                                   |             |      |      |             |      |      |            |      |      |            |      |      |
| Vol/Sat:  | 0.08        | 0.08 | 0.06 | 0.07        | 0.19 | 0.19 | 0.09       | 0.16 | 0.13 | 0.10       | 0.16 | 0.06 |
| Crit Moves:   | ****        |      |      | ****        |      |      | ****       |      |      | ****       |      |      |
| Green Time:   | 15.7        | 29.1 | 29.1 | 21.3        | 34.7 | 34.7 | 17.2       | 29.9 | 29.9 | 17.7       | 30.4 | 30.4 |
| Volume/Cap:   | 0.59        | 0.30 | 0.24 | 0.34        | 0.59 | 0.59 | 0.58       | 0.59 | 0.47 | 0.59       | 0.58 | 0.20 |
| Delay/Veh:  | 48.0        | 32.4 | 32.0 | 39.0        | 32.5 | 32.5 | 46.2       | 35.7 | 34.1 | 46.2       | 35.1 | 30.7 |
| User DelAdj:  | 1.00        | 1.00 | 1.00 | 1.00        | 1.00 | 1.00 | 1.00       | 1.00 | 1.00 | 1.00       | 1.00 | 1.00 |
| AdjDel/Veh:   | 48.0        | 32.4 | 32.0 | 39.0        | 32.5 | 32.5 | 46.2       | 35.7 | 34.1 | 46.2       | 35.1 | 30.7 |
| LOS by Move:  | D           | C    | C    | D           | C    | C    | D          | D    | C    | D          | D    | C    |
| HCM2k95thQ:   | 10          | 8    | 6    | 7           | 18   | 18   | 10         | 17   | 13   | 12         | 17   | 6    |

Note: Queue reported is the number of cars per lane.

BART

Level Of Service Computation Report  
2000 HCM Operations (Future Volume Alternative)  
AM - Background Conditions

Intersection #3210: 101/Julian-McKee (W) [Study Int 4]

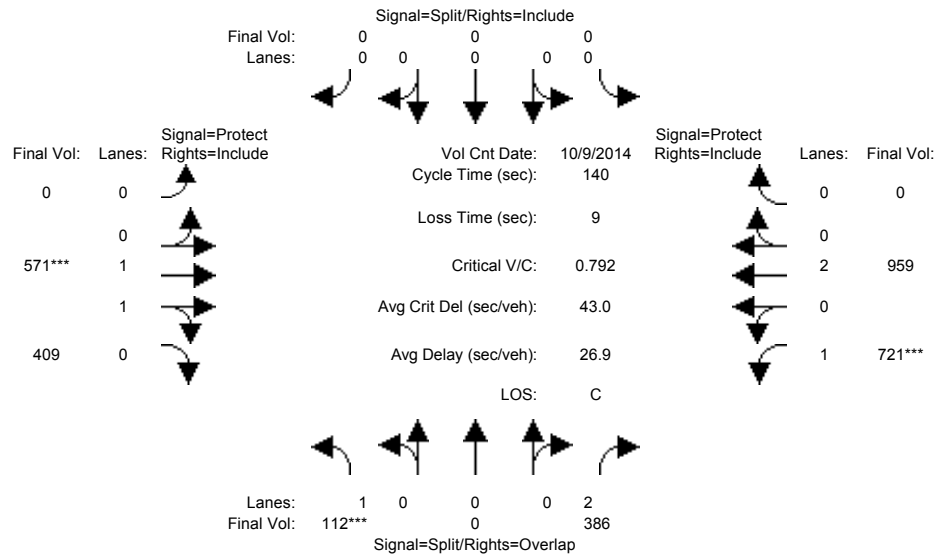

| Approach:                                   | North Bound |      |      | South Bound |      |      | East Bound |      |      | West Bound |      |      |
|---|-------------|------|------|-------------|------|------|------------|------|------|------------|------|------|
| Movement:                                   | L           | T    | R    | L           | T    | R    | L          | T    | R    | L          | T    | R    |
| Min. Green:                                 | 10          | 0    | 10   | 0           | 0    | 0    | 0          | 10   | 10   | 7          | 10   | 0    |
| Y+R:  | 4.0         | 4.0  | 4.0  | 4.0         | 4.0  | 4.0  | 4.0        | 4.0  | 4.0  | 4.0        | 4.0  | 4.0  |
| Volume Module: >> Count Date: 9 Oct 2014 << |             |      |      |             |      |      |            |      |      |            |      |      |
| Base Vol:                                   | 112         | 0    | 386  | 0           | 0    | 0    | 0          | 571  | 409  | 721        | 959  | 0    |
| Growth Adj:                                 | 1.00        | 1.00 | 1.00 | 1.00        | 1.00 | 1.00 | 1.00       | 1.00 | 1.00 | 1.00       | 1.00 | 1.00 |
| Initial Bse:                                | 112         | 0    | 386  | 0           | 0    | 0    | 0          | 571  | 409  | 721        | 959  | 0    |
| Added Vol:                                  | 0           | 0    | 0    | 0           | 0    | 0    | 0          | 0    | 0    | 0          | 0    | 0    |
| PasserByVol:                                | 0           | 0    | 0    | 0           | 0    | 0    | 0          | 0    | 0    | 0          | 0    | 0    |
| Initial Fut:                                | 112         | 0    | 386  | 0           | 0    | 0    | 0          | 571  | 409  | 721        | 959  | 0    |
| User Adj:                                   | 1.00        | 1.00 | 1.00 | 1.00        | 1.00 | 1.00 | 1.00       | 1.00 | 1.00 | 1.00       | 1.00 | 1.00 |
| PHF Adj:                                    | 1.00        | 1.00 | 1.00 | 1.00        | 1.00 | 1.00 | 1.00       | 1.00 | 1.00 | 1.00       | 1.00 | 1.00 |
| PHF Volume:                                 | 112         | 0    | 386  | 0           | 0    | 0    | 0          | 571  | 409  | 721        | 959  | 0    |
| Reduct Vol:                                 | 0           | 0    | 0    | 0           | 0    | 0    | 0          | 0    | 0    | 0          | 0    | 0    |
| Reduced Vol:                                | 112         | 0    | 386  | 0           | 0    | 0    | 0          | 571  | 409  | 721        | 959  | 0    |
| PCE Adj:                                    | 1.00        | 1.00 | 1.00 | 1.00        | 1.00 | 1.00 | 1.00       | 1.00 | 1.00 | 1.00       | 1.00 | 1.00 |
| MLF Adj:                                    | 1.00        | 1.00 | 1.00 | 1.00        | 1.00 | 1.00 | 1.00       | 1.00 | 1.00 | 1.00       | 1.00 | 1.00 |
| FinalVolume:                                | 112         | 0    | 386  | 0           | 0    | 0    | 0          | 571  | 409  | 721        | 959  | 0    |
| Saturation Flow Module:                     |             |      |      |             |      |      |            |      |      |            |      |      |
| Sat/Lane:                                   | 1900        | 1900 | 1900 | 1900        | 1900 | 1900 | 1900       | 1900 | 1900 | 1900       | 1900 | 1900 |
| Adjustment:                                 | 0.92        | 1.00 | 0.83 | 0.92        | 1.00 | 0.92 | 0.92       | 0.99 | 0.95 | 0.92       | 1.00 | 0.92 |
| Lanes:                                      | 1.00        | 0.00 | 2.00 | 0.00        | 0.00 | 0.00 | 0.00       | 1.14 | 0.86 | 1.00       | 2.00 | 0.00 |
| Final Sat.:                                 | 1750        | 0    | 3150 | 0           | 0    | 0    | 0          | 2155 | 1543 | 1750       | 3800 | 0    |
| Capacity Analysis Module:                   |             |      |      |             |      |      |            |      |      |            |      |      |
| Vol/Sat:                                    | 0.06        | 0.00 | 0.12 | 0.00        | 0.00 | 0.00 | 0.00       | 0.27 | 0.27 | 0.41       | 0.25 | 0.00 |
| Crit Moves:                                 | ****        |      |      |             |      |      |            | **** |      | ****       |      |      |
| Green Time:                                 | 11.3        | 0.0  | 84.2 | 0.0         | 0.0  | 0.0  | 0.0        | 46.8 | 46.8 | 72.8       | 120  | 0.0  |
| Volume/Cap:                                 | 0.79        | 0.00 | 0.20 | 0.00        | 0.00 | 0.00 | 0.00       | 0.79 | 0.79 | 0.79       | 0.30 | 0.00 |
| Delay/Veh:                                  | 88.7        | 0.0  | 12.7 | 0.0         | 0.0  | 0.0  | 0.0        | 45.7 | 45.7 | 32.2       | 2.0  | 0.0  |
| User DelAdj:                                | 1.00        | 1.00 | 1.00 | 1.00        | 1.00 | 1.00 | 1.00       | 1.00 | 1.00 | 1.00       | 1.00 | 1.00 |
| AdjDel/Veh:                                 | 88.7        | 0.0  | 12.7 | 0.0         | 0.0  | 0.0  | 0.0        | 45.7 | 45.7 | 32.2       | 2.0  | 0.0  |
| LOS by Move:                                | F           | A    | B    | A           | A    | A    | A          | D    | D    | C          | A    | A    |
| HCM2k95thQ:                                 | 13          | 0    | 9    | 0           | 0    | 0    | 0          | 33   | 33   | 46         | 8    | 0    |

Note: Queue reported is the number of cars per lane.



BART

Level Of Service Computation Report  
 2000 HCM Operations (Future Volume Alternative)  
 PM - Background Conditions

Intersection #3210: 101/Julian-McKee (W) [Study Int 4]

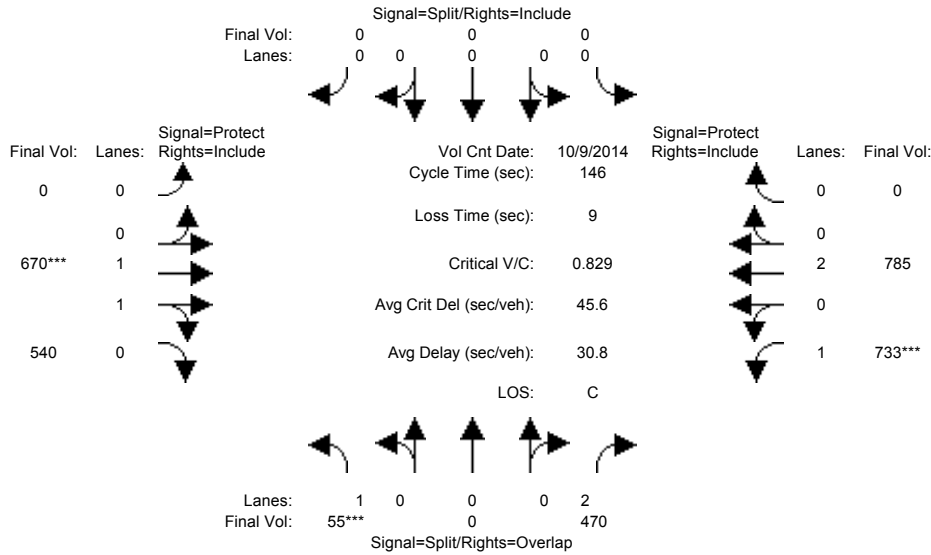

| Approach:                 | North Bound                  |      |      | South Bound |      |      | East Bound |      |      | West Bound |      |      |
|---------------------------|------------------------------|------|------|-------------|------|------|------------|------|------|------------|------|------|
| Movement:                 | L                            | T    | R    | L           | T    | R    | L          | T    | R    | L          | T    | R    |
| Min. Green:               | 10                           | 0    | 10   | 0           | 0    | 0    | 0          | 10   | 10   | 7          | 10   | 0    |
| Y+R:                      | 4.0                          | 4.0  | 4.0  | 4.0         | 4.0  | 4.0  | 4.0        | 4.0  | 4.0  | 4.0        | 4.0  | 0    |
| -----                     |                              |      |      |             |      |      |            |      |      |            |      |      |
| Volume Module:            | >> Count Date: 9 Oct 2014 << |      |      |             |      |      |            |      |      |            |      |      |
| Base Vol:                 | 55                           | 0    | 470  | 0           | 0    | 0    | 0          | 670  | 540  | 733        | 785  | 0    |
| Growth Adj:               | 1.00                         | 1.00 | 1.00 | 1.00        | 1.00 | 1.00 | 1.00       | 1.00 | 1.00 | 1.00       | 1.00 | 1.00 |
| Initial Bse:              | 55                           | 0    | 470  | 0           | 0    | 0    | 0          | 670  | 540  | 733        | 785  | 0    |
| Added Vol:                | 0                            | 0    | 0    | 0           | 0    | 0    | 0          | 0    | 0    | 0          | 0    | 0    |
| PasserByVol:              | 0                            | 0    | 0    | 0           | 0    | 0    | 0          | 0    | 0    | 0          | 0    | 0    |
| Initial Fut:              | 55                           | 0    | 470  | 0           | 0    | 0    | 0          | 670  | 540  | 733        | 785  | 0    |
| User Adj:                 | 1.00                         | 1.00 | 1.00 | 1.00        | 1.00 | 1.00 | 1.00       | 1.00 | 1.00 | 1.00       | 1.00 | 1.00 |
| PHF Adj:                  | 1.00                         | 1.00 | 1.00 | 1.00        | 1.00 | 1.00 | 1.00       | 1.00 | 1.00 | 1.00       | 1.00 | 1.00 |
| PHF Volume:               | 55                           | 0    | 470  | 0           | 0    | 0    | 0          | 670  | 540  | 733        | 785  | 0    |
| Reduct Vol:               | 0                            | 0    | 0    | 0           | 0    | 0    | 0          | 0    | 0    | 0          | 0    | 0    |
| Reduced Vol:              | 55                           | 0    | 470  | 0           | 0    | 0    | 0          | 670  | 540  | 733        | 785  | 0    |
| PCE Adj:                  | 1.00                         | 1.00 | 1.00 | 1.00        | 1.00 | 1.00 | 1.00       | 1.00 | 1.00 | 1.00       | 1.00 | 1.00 |
| MLF Adj:                  | 1.00                         | 1.00 | 1.00 | 1.00        | 1.00 | 1.00 | 1.00       | 1.00 | 1.00 | 1.00       | 1.00 | 1.00 |
| FinalVolume:              | 55                           | 0    | 470  | 0           | 0    | 0    | 0          | 670  | 540  | 733        | 785  | 0    |
| -----                     |                              |      |      |             |      |      |            |      |      |            |      |      |
| Saturation Flow Module:   |                              |      |      |             |      |      |            |      |      |            |      |      |
| Sat/Lane:                 | 1900                         | 1900 | 1900 | 1900        | 1900 | 1900 | 1900       | 1900 | 1900 | 1900       | 1900 | 1900 |
| Adjustment:               | 0.92                         | 1.00 | 0.83 | 0.92        | 1.00 | 0.92 | 0.92       | 0.99 | 0.95 | 0.92       | 1.00 | 0.92 |
| Lanes:                    | 1.00                         | 0.00 | 2.00 | 0.00        | 0.00 | 0.00 | 0.00       | 1.08 | 0.92 | 1.00       | 2.00 | 0.00 |
| Final Sat.:               | 1750                         | 0    | 3150 | 0           | 0    | 0    | 0          | 2048 | 1650 | 1750       | 3800 | 0    |
| -----                     |                              |      |      |             |      |      |            |      |      |            |      |      |
| Capacity Analysis Module: |                              |      |      |             |      |      |            |      |      |            |      |      |
| Vol/Sat:                  | 0.03                         | 0.00 | 0.15 | 0.00        | 0.00 | 0.00 | 0.00       | 0.33 | 0.33 | 0.42       | 0.21 | 0.00 |
| Crit Moves:               | ****                         |      |      | ****        |      |      | ****       |      |      | ****       |      |      |
| Green Time:               | 10.0                         | 0.0  | 81.3 | 0.0         | 0.0  | 0.0  | 0.0        | 55.7 | 55.7 | 71.3       | 127  | 0.0  |
| Volume/Cap:               | 0.46                         | 0.00 | 0.27 | 0.00        | 0.00 | 0.00 | 0.00       | 0.86 | 0.86 | 0.86       | 0.24 | 0.00 |
| Delay/Veh:                | 68.2                         | 0.0  | 16.9 | 0.0         | 0.0  | 0.0  | 0.0        | 47.0 | 47.0 | 41.5       | 1.6  | 0.0  |
| User DelAdj:              | 1.00                         | 1.00 | 1.00 | 1.00        | 1.00 | 1.00 | 1.00       | 1.00 | 1.00 | 1.00       | 1.00 | 1.00 |
| AdjDel/Veh:               | 68.2                         | 0.0  | 16.9 | 0.0         | 0.0  | 0.0  | 0.0        | 47.0 | 47.0 | 41.5       | 1.6  | 0.0  |
| LOS by Move:              | E                            | A    | B    | A           | A    | A    | A          | D    | D    | D          | A    | A    |
| HCM2k95thQ:               | 6                            | 0    | 12   | 0           | 0    | 0    | 0          | 44   | 44   | 53         | 6    | 0    |

Note: Queue reported is the number of cars per lane.

BART

Level Of Service Computation Report  
 2000 HCM Operations (Future Volume Alternative)  
 AM - Background Conditions

Intersection #3211: 101/McKee(E) [Study Int 5]

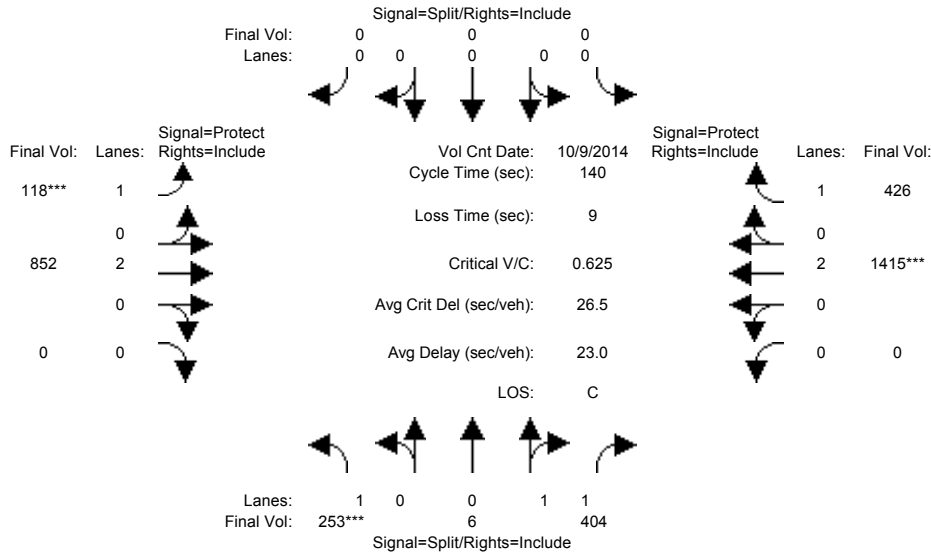

| Approach:                     | North Bound   |      |      | South Bound |      |      | East Bound |      |      | West Bound |      |      |
|-------------------------------|---------------|------|------|-------------|------|------|------------|------|------|------------|------|------|
| Movement:                     | L             | T    | R    | L           | T    | R    | L          | T    | R    | L          | T    | R    |
| Min. Green:                   | 10            | 10   | 10   | 0           | 0    | 0    | 7          | 10   | 0    | 0          | 10   | 10   |
| Y+R:                          | 4.0           | 4.0  | 4.0  | 4.0         | 4.0  | 4.0  | 4.0        | 4.0  | 4.0  | 4.0        | 4.0  | 4.0  |
| -----                         |               |      |      |             |      |      |            |      |      |            |      |      |
| Volume Module: >> Count Date: | 9 Oct 2014 << |      |      |             |      |      |            |      |      |            |      |      |
| Base Vol:                     | 253           | 6    | 404  | 0           | 0    | 0    | 118        | 852  | 0    | 0          | 1415 | 426  |
| Growth Adj:                   | 1.00          | 1.00 | 1.00 | 1.00        | 1.00 | 1.00 | 1.00       | 1.00 | 1.00 | 1.00       | 1.00 | 1.00 |
| Initial Bse:                  | 253           | 6    | 404  | 0           | 0    | 0    | 118        | 852  | 0    | 0          | 1415 | 426  |
| Added Vol:                    | 0             | 0    | 0    | 0           | 0    | 0    | 0          | 0    | 0    | 0          | 0    | 0    |
| PasserByVol:                  | 0             | 0    | 0    | 0           | 0    | 0    | 0          | 0    | 0    | 0          | 0    | 0    |
| Initial Fut:                  | 253           | 6    | 404  | 0           | 0    | 0    | 118        | 852  | 0    | 0          | 1415 | 426  |
| User Adj:                     | 1.00          | 1.00 | 1.00 | 1.00        | 1.00 | 1.00 | 1.00       | 1.00 | 1.00 | 1.00       | 1.00 | 1.00 |
| PHF Adj:                      | 1.00          | 1.00 | 1.00 | 1.00        | 1.00 | 1.00 | 1.00       | 1.00 | 1.00 | 1.00       | 1.00 | 1.00 |
| PHF Volume:                   | 253           | 6    | 404  | 0           | 0    | 0    | 118        | 852  | 0    | 0          | 1415 | 426  |
| Reduct Vol:                   | 0             | 0    | 0    | 0           | 0    | 0    | 0          | 0    | 0    | 0          | 0    | 0    |
| Reduced Vol:                  | 253           | 6    | 404  | 0           | 0    | 0    | 118        | 852  | 0    | 0          | 1415 | 426  |
| PCE Adj:                      | 1.00          | 1.00 | 1.00 | 1.00        | 1.00 | 1.00 | 1.00       | 1.00 | 1.00 | 1.00       | 1.00 | 1.00 |
| MLF Adj:                      | 1.00          | 1.00 | 1.00 | 1.00        | 1.00 | 1.00 | 1.00       | 1.00 | 1.00 | 1.00       | 1.00 | 1.00 |
| Final Volume:                 | 253           | 6    | 404  | 0           | 0    | 0    | 118        | 852  | 0    | 0          | 1415 | 426  |
| -----                         |               |      |      |             |      |      |            |      |      |            |      |      |
| Saturation Flow Module:       |               |      |      |             |      |      |            |      |      |            |      |      |
| Sat/Lane:                     | 1900          | 1900 | 1900 | 1900        | 1900 | 1900 | 1900       | 1900 | 1900 | 1900       | 1900 | 1900 |
| Adjustment:                   | 0.92          | 0.95 | 0.95 | 0.92        | 1.00 | 0.92 | 0.92       | 1.00 | 0.92 | 0.92       | 1.00 | 0.92 |
| Lanes:                        | 1.00          | 0.03 | 1.97 | 0.00        | 0.00 | 0.00 | 1.00       | 2.00 | 0.00 | 0.00       | 2.00 | 1.00 |
| Final Sat.:                   | 1750          | 53   | 3547 | 0           | 0    | 0    | 1750       | 3800 | 0    | 0          | 3800 | 1750 |
| -----                         |               |      |      |             |      |      |            |      |      |            |      |      |
| Capacity Analysis Module:     |               |      |      |             |      |      |            |      |      |            |      |      |
| Vol/Sat:                      | 0.14          | 0.11 | 0.11 | 0.00        | 0.00 | 0.00 | 0.07       | 0.22 | 0.00 | 0.00       | 0.37 | 0.24 |
| Crit Moves:                   | ****          |      |      | ****        |      |      | ****       |      |      | ****       |      |      |
| Green Time:                   | 32.4          | 32.4 | 32.4 | 0.0         | 0.0  | 0.0  | 15.1       | 98.6 | 0.0  | 0.0        | 83.5 | 83.5 |
| Volume/Cap:                   | 0.62          | 0.49 | 0.49 | 0.00        | 0.00 | 0.00 | 0.62       | 0.32 | 0.00 | 0.00       | 0.62 | 0.41 |
| Delay/Veh:                    | 51.4          | 47.1 | 47.1 | 0.0         | 0.0  | 0.0  | 66.1       | 8.0  | 0.0  | 0.0        | 18.7 | 15.3 |
| User DelAdj:                  | 1.00          | 1.00 | 1.00 | 1.00        | 1.00 | 1.00 | 1.00       | 1.00 | 1.00 | 1.00       | 1.00 | 1.00 |
| AdjDel/Veh:                   | 51.4          | 47.1 | 47.1 | 0.0         | 0.0  | 0.0  | 66.1       | 8.0  | 0.0  | 0.0        | 18.7 | 15.3 |
| LOS by Move:                  | D             | D    | D    | A           | A    | A    | E          | A    | A    | A          | B    | B    |
| HCM2k95thQ:                   | 20            | 15   | 15   | 0           | 0    | 0    | 12         | 13   | 0    | 0          | 32   | 18   |

Note: Queue reported is the number of cars per lane.

BART

Level Of Service Computation Report  
 2000 HCM Operations (Future Volume Alternative)  
 PM - Background Conditions

Intersection #3211: 101/McKee(E) [Study Int 5]

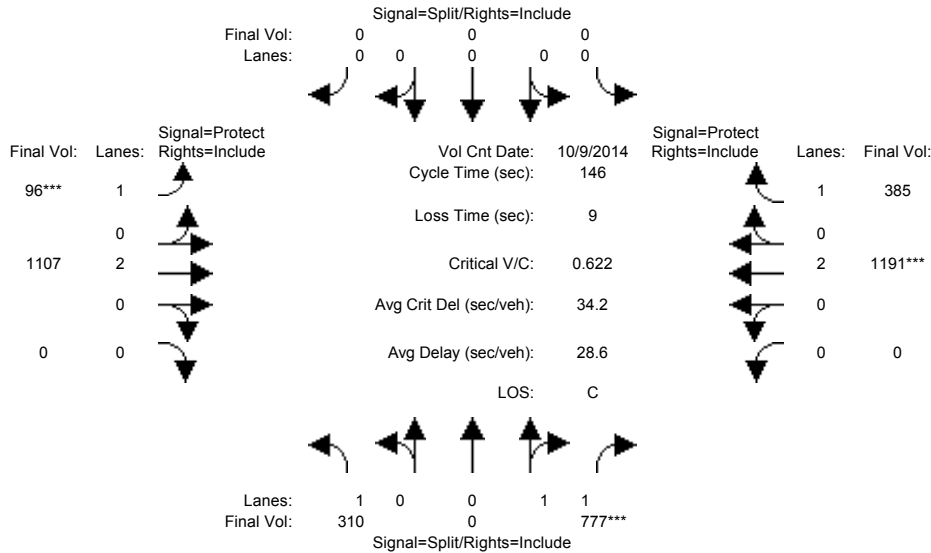

| Approach:                                   | North Bound |      |      | South Bound |      |      | East Bound |      |      | West Bound |      |      |
|---|-------------|------|------|-------------|------|------|------------|------|------|------------|------|------|
| Movement:                                   | L           | T    | R    | L           | T    | R    | L          | T    | R    | L          | T    | R    |
| Min. Green:                                 | 10          | 10   | 10   | 0           | 0    | 0    | 7          | 10   | 0    | 0          | 10   | 10   |
| Y+R:  | 4.0         | 4.0  | 4.0  | 4.0         | 4.0  | 4.0  | 4.0        | 4.0  | 4.0  | 4.0        | 4.0  | 4.0  |
| -----                                       |             |      |      |             |      |      |            |      |      |            |      |      |
| Volume Module: >> Count Date: 9 Oct 2014 << |             |      |      |             |      |      |            |      |      |            |      |      |
| Base Vol:                                   | 310         | 0    | 777  | 0           | 0    | 0    | 96         | 1107 | 0    | 0          | 1191 | 385  |
| Growth Adj:                                 | 1.00        | 1.00 | 1.00 | 1.00        | 1.00 | 1.00 | 1.00       | 1.00 | 1.00 | 1.00       | 1.00 | 1.00 |
| Initial Bse:                                | 310         | 0    | 777  | 0           | 0    | 0    | 96         | 1107 | 0    | 0          | 1191 | 385  |
| Added Vol:                                  | 0           | 0    | 0    | 0           | 0    | 0    | 0          | 0    | 0    | 0          | 0    | 0    |
| PasserByVol:                                | 0           | 0    | 0    | 0           | 0    | 0    | 0          | 0    | 0    | 0          | 0    | 0    |
| Initial Fut:                                | 310         | 0    | 777  | 0           | 0    | 0    | 96         | 1107 | 0    | 0          | 1191 | 385  |
| User Adj:                                   | 1.00        | 1.00 | 1.00 | 1.00        | 1.00 | 1.00 | 1.00       | 1.00 | 1.00 | 1.00       | 1.00 | 1.00 |
| PHF Adj:                                    | 1.00        | 1.00 | 1.00 | 1.00        | 1.00 | 1.00 | 1.00       | 1.00 | 1.00 | 1.00       | 1.00 | 1.00 |
| PHF Volume:                                 | 310         | 0    | 777  | 0           | 0    | 0    | 96         | 1107 | 0    | 0          | 1191 | 385  |
| Reduct Vol:                                 | 0           | 0    | 0    | 0           | 0    | 0    | 0          | 0    | 0    | 0          | 0    | 0    |
| Reduced Vol:                                | 310         | 0    | 777  | 0           | 0    | 0    | 96         | 1107 | 0    | 0          | 1191 | 385  |
| PCE Adj:                                    | 1.00        | 1.00 | 1.00 | 1.00        | 1.00 | 1.00 | 1.00       | 1.00 | 1.00 | 1.00       | 1.00 | 1.00 |
| MLF Adj:                                    | 1.00        | 1.00 | 1.00 | 1.00        | 1.00 | 1.00 | 1.00       | 1.00 | 1.00 | 1.00       | 1.00 | 1.00 |
| Final Volume:                               | 310         | 0    | 777  | 0           | 0    | 0    | 96         | 1107 | 0    | 0          | 1191 | 385  |
| -----                                       |             |      |      |             |      |      |            |      |      |            |      |      |
| Saturation Flow Module:                     |             |      |      |             |      |      |            |      |      |            |      |      |
| Sat/Lane:                                   | 1900        | 1900 | 1900 | 1900        | 1900 | 1900 | 1900       | 1900 | 1900 | 1900       | 1900 | 1900 |
| Adjustment:                                 | 0.92        | 1.00 | 0.95 | 0.92        | 1.00 | 0.92 | 0.92       | 1.00 | 0.92 | 0.92       | 1.00 | 0.92 |
| Lanes:                                      | 1.00        | 0.00 | 2.00 | 0.00        | 0.00 | 0.00 | 1.00       | 2.00 | 0.00 | 0.00       | 2.00 | 1.00 |
| Final Sat.:                                 | 1750        | 0    | 3600 | 0           | 0    | 0    | 1750       | 3800 | 0    | 0          | 3800 | 1750 |
| -----                                       |             |      |      |             |      |      |            |      |      |            |      |      |
| Capacity Analysis Module:                   |             |      |      |             |      |      |            |      |      |            |      |      |
| Vol/Sat:                                    | 0.18        | 0.00 | 0.22 | 0.00        | 0.00 | 0.00 | 0.05       | 0.29 | 0.00 | 0.00       | 0.31 | 0.22 |
| Crit Moves:                                 | ****        |      |      | ****        |      |      | ****       |      |      | ****       |      |      |
| Green Time:                                 | 50.6        | 0.0  | 50.6 | 0.0         | 0.0  | 0.0  | 12.9       | 86.4 | 0.0  | 0.0        | 73.5 | 73.5 |
| Volume/Cap:                                 | 0.51        | 0.00 | 0.62 | 0.00        | 0.00 | 0.00 | 0.62       | 0.49 | 0.00 | 0.00       | 0.62 | 0.44 |
| Delay/Veh:                                  | 38.6        | 0.0  | 40.7 | 0.0         | 0.0  | 0.0  | 71.9       | 17.3 | 0.0  | 0.0        | 26.9 | 23.4 |
| User DelAdj:                                | 1.00        | 1.00 | 1.00 | 1.00        | 1.00 | 1.00 | 1.00       | 1.00 | 1.00 | 1.00       | 1.00 | 1.00 |
| AdjDel/Veh:                                 | 38.6        | 0.0  | 40.7 | 0.0         | 0.0  | 0.0  | 71.9       | 17.3 | 0.0  | 0.0        | 26.9 | 23.4 |
| LOS by Move:                                | D           | A    | D    | A           | A    | A    | E          | B    | A    | A          | C    | C    |
| HCM2k95thQ:                                 | 21          | 0    | 27   | 0           | 0    | 0    | 11         | 25   | 0    | 0          | 32   | 21   |

Note: Queue reported is the number of cars per lane.

BART

Level Of Service Computation Report  
2000 HCM Operations (Future Volume Alternative)  
AM - Background Conditions

Intersection #3260: ALUM ROCK/33rd [Study Int 16]

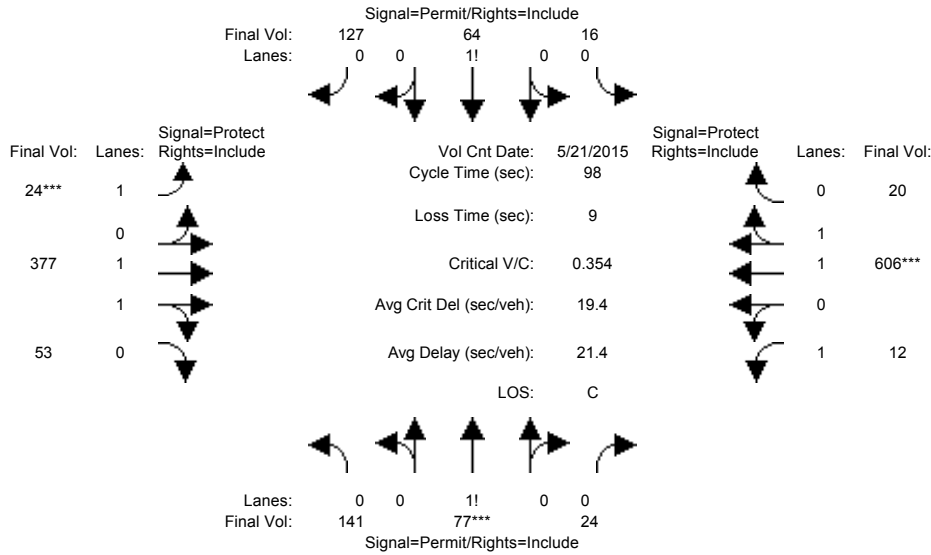

| Approach:  | North Bound |      |      | South Bound |      |      | East Bound |      |      | West Bound |      |      |
|--|-------------|------|------|-------------|------|------|------------|------|------|------------|------|------|
| Movement:  | L           | T    | R    | L           | T    | R    | L          | T    | R    | L          | T    | R    |
| Min. Green:  | 10          | 10   | 10   | 10          | 10   | 10   | 7          | 10   | 10   | 7          | 10   | 10   |
| Y+R:   | 4.0         | 4.0  | 4.0  | 4.0         | 4.0  | 4.0  | 4.0        | 4.0  | 4.0  | 4.0        | 4.0  | 4.0  |
| Volume Module: >> Count Date: 21 May 2015 << 7:30-8:30AM |             |      |      |             |      |      |            |      |      |            |      |      |
| Base Vol:  | 141         | 77   | 24   | 16          | 64   | 127  | 24         | 377  | 53   | 12         | 606  | 20   |
| Growth Adj:  | 1.00        | 1.00 | 1.00 | 1.00        | 1.00 | 1.00 | 1.00       | 1.00 | 1.00 | 1.00       | 1.00 | 1.00 |
| Initial Bse:   | 141         | 77   | 24   | 16          | 64   | 127  | 24         | 377  | 53   | 12         | 606  | 20   |
| Added Vol:   | 0           | 0    | 0    | 0           | 0    | 0    | 0          | 0    | 0    | 0          | 0    | 0    |
| PasserByVol:   | 0           | 0    | 0    | 0           | 0    | 0    | 0          | 0    | 0    | 0          | 0    | 0    |
| Initial Fut:   | 141         | 77   | 24   | 16          | 64   | 127  | 24         | 377  | 53   | 12         | 606  | 20   |
| User Adj:  | 1.00        | 1.00 | 1.00 | 1.00        | 1.00 | 1.00 | 1.00       | 1.00 | 1.00 | 1.00       | 1.00 | 1.00 |
| PHF Adj:   | 1.00        | 1.00 | 1.00 | 1.00        | 1.00 | 1.00 | 1.00       | 1.00 | 1.00 | 1.00       | 1.00 | 1.00 |
| PHF Volume:  | 141         | 77   | 24   | 16          | 64   | 127  | 24         | 377  | 53   | 12         | 606  | 20   |
| Reduct Vol:  | 0           | 0    | 0    | 0           | 0    | 0    | 0          | 0    | 0    | 0          | 0    | 0    |
| Reduced Vol:   | 141         | 77   | 24   | 16          | 64   | 127  | 24         | 377  | 53   | 12         | 606  | 20   |
| PCE Adj:   | 1.00        | 1.00 | 1.00 | 1.00        | 1.00 | 1.00 | 1.00       | 1.00 | 1.00 | 1.00       | 1.00 | 1.00 |
| MLF Adj:   | 1.00        | 1.00 | 1.00 | 1.00        | 1.00 | 1.00 | 1.00       | 1.00 | 1.00 | 1.00       | 1.00 | 1.00 |
| Final Volume:  | 141         | 77   | 24   | 16          | 64   | 127  | 24         | 377  | 53   | 12         | 606  | 20   |
| Saturation Flow Module:                                  |             |      |      |             |      |      |            |      |      |            |      |      |
| Sat/Lane:  | 1900        | 1900 | 1900 | 1900        | 1900 | 1900 | 1900       | 1900 | 1900 | 1900       | 1900 | 1900 |
| Adjustment:  | 0.92        | 0.92 | 0.92 | 0.92        | 0.92 | 0.92 | 0.92       | 0.98 | 0.95 | 0.92       | 0.97 | 0.95 |
| Lanes:   | 0.58        | 0.32 | 0.10 | 0.08        | 0.31 | 0.61 | 1.00       | 1.75 | 0.25 | 1.00       | 1.93 | 0.07 |
| Final Sat.:  | 1020        | 557  | 174  | 135         | 541  | 1074 | 1750       | 3244 | 456  | 1750       | 3582 | 118  |
| Capacity Analysis Module:                                |             |      |      |             |      |      |            |      |      |            |      |      |
| Vol/Sat:   | 0.14        | 0.14 | 0.14 | 0.12        | 0.12 | 0.12 | 0.01       | 0.12 | 0.12 | 0.01       | 0.17 | 0.17 |
| Crit Moves:  | ****        |      |      | ****        |      |      | ****       |      |      | ****       |      |      |
| Green Time:  | 36.9        | 36.9 | 36.9 | 36.9        | 36.9 | 36.9 | 7.0        | 32.3 | 32.3 | 19.8       | 45.1 | 45.1 |
| Volume/Cap:  | 0.37        | 0.37 | 0.37 | 0.31        | 0.31 | 0.31 | 0.19       | 0.35 | 0.35 | 0.03       | 0.37 | 0.37 |
| Delay/Veh:   | 22.5        | 22.5 | 22.5 | 21.9        | 21.9 | 21.9 | 43.6       | 25.1 | 25.1 | 31.4       | 17.3 | 17.3 |
| User DelAdj:   | 1.00        | 1.00 | 1.00 | 1.00        | 1.00 | 1.00 | 1.00       | 1.00 | 1.00 | 1.00       | 1.00 | 1.00 |
| AdjDel/Veh:  | 22.5        | 22.5 | 22.5 | 21.9        | 21.9 | 21.9 | 43.6       | 25.1 | 25.1 | 31.4       | 17.3 | 17.3 |
| LOS by Move:   | C           | C    | C    | C           | C    | C    | D          | C    | C    | C          | B    | B    |
| HCM2k95thQ:  | 11          | 11   | 11   | 9           | 9    | 9    | 1          | 10   | 10   | 1          | 12   | 12   |

Note: Queue reported is the number of cars per lane.

BART

Level Of Service Computation Report  
 2000 HCM Operations (Future Volume Alternative)  
 PM - Background Conditions

Intersection #3260: ALUM ROCK/33rd [Study Int 16]

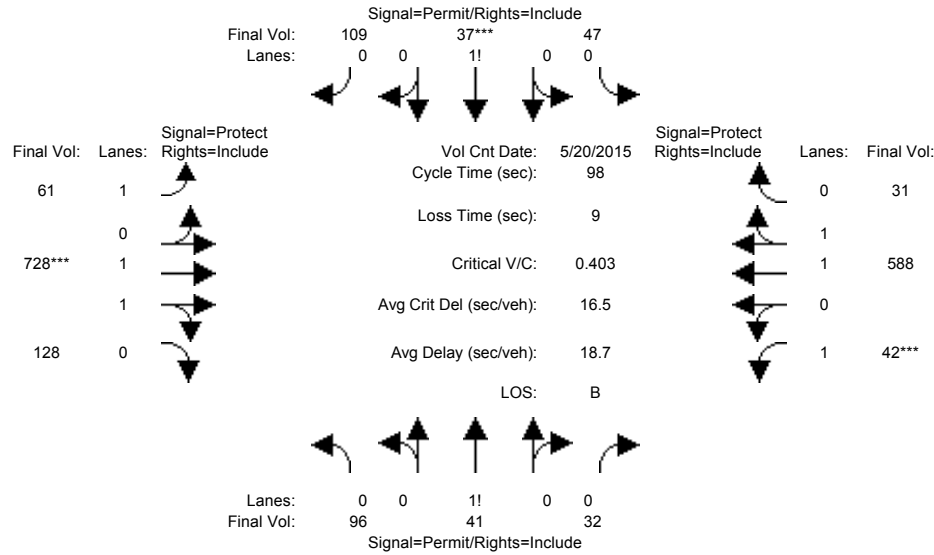

| Approach:   | North Bound                               |      |      | South Bound |      |      | East Bound |      |      | West Bound |      |      |
|---|---|------|------|-------------|------|------|------------|------|------|------------|------|------|
| Movement:   | L   | T    | R    | L           | T    | R    | L          | T    | R    | L          | T    | R    |
| Min. Green:   | 10  | 10   | 10   | 10          | 10   | 10   | 7          | 10   | 10   | 7          | 10   | 10   |
| Y+R:  | 4.0                                       | 4.0  | 4.0  | 4.0         | 4.0  | 4.0  | 4.0        | 4.0  | 4.0  | 4.0        | 4.0  | 4.0  |
| ----- ----- ----- ----- ----- ----- ----- ----- ----- ----- ----- ----- ----- |   |      |      |             |      |      |            |      |      |            |      |      |
| Volume Module:  | >> Count Date: 20 May 2015 << 4:15-5:15PM |      |      |             |      |      |            |      |      |            |      |      |
| Base Vol:   | 96  | 41   | 32   | 47          | 37   | 109  | 61         | 728  | 128  | 42         | 588  | 31   |
| Growth Adj:   | 1.00                                      | 1.00 | 1.00 | 1.00        | 1.00 | 1.00 | 1.00       | 1.00 | 1.00 | 1.00       | 1.00 | 1.00 |
| Initial Bse:  | 96  | 41   | 32   | 47          | 37   | 109  | 61         | 728  | 128  | 42         | 588  | 31   |
| Added Vol:  | 0   | 0    | 0    | 0           | 0    | 0    | 0          | 0    | 0    | 0          | 0    | 0    |
| PasserByVol:  | 0   | 0    | 0    | 0           | 0    | 0    | 0          | 0    | 0    | 0          | 0    | 0    |
| Initial Fut:  | 96  | 41   | 32   | 47          | 37   | 109  | 61         | 728  | 128  | 42         | 588  | 31   |
| User Adj:   | 1.00                                      | 1.00 | 1.00 | 1.00        | 1.00 | 1.00 | 1.00       | 1.00 | 1.00 | 1.00       | 1.00 | 1.00 |
| PHF Adj:  | 1.00                                      | 1.00 | 1.00 | 1.00        | 1.00 | 1.00 | 1.00       | 1.00 | 1.00 | 1.00       | 1.00 | 1.00 |
| PHF Volume:   | 96  | 41   | 32   | 47          | 37   | 109  | 61         | 728  | 128  | 42         | 588  | 31   |
| Reduct Vol:   | 0   | 0    | 0    | 0           | 0    | 0    | 0          | 0    | 0    | 0          | 0    | 0    |
| Reduced Vol:  | 96  | 41   | 32   | 47          | 37   | 109  | 61         | 728  | 128  | 42         | 588  | 31   |
| PCE Adj:  | 1.00                                      | 1.00 | 1.00 | 1.00        | 1.00 | 1.00 | 1.00       | 1.00 | 1.00 | 1.00       | 1.00 | 1.00 |
| MLF Adj:  | 1.00                                      | 1.00 | 1.00 | 1.00        | 1.00 | 1.00 | 1.00       | 1.00 | 1.00 | 1.00       | 1.00 | 1.00 |
| FinalVolume:  | 96  | 41   | 32   | 47          | 37   | 109  | 61         | 728  | 128  | 42         | 588  | 31   |
| ----- ----- ----- ----- ----- ----- ----- ----- ----- ----- ----- -----       |   |      |      |             |      |      |            |      |      |            |      |      |
| Saturation Flow Module:   |   |      |      |             |      |      |            |      |      |            |      |      |
| Sat/Lane:   | 1900                                      | 1900 | 1900 | 1900        | 1900 | 1900 | 1900       | 1900 | 1900 | 1900       | 1900 | 1900 |
| Adjustment:   | 0.92                                      | 0.92 | 0.92 | 0.92        | 0.92 | 0.92 | 0.92       | 0.98 | 0.95 | 0.92       | 0.98 | 0.95 |
| Lanes:  | 0.57                                      | 0.24 | 0.19 | 0.24        | 0.19 | 0.57 | 1.00       | 1.69 | 0.31 | 1.00       | 1.90 | 0.10 |
| Final Sat.:   | 994                                       | 425  | 331  | 426         | 335  | 988  | 1750       | 3146 | 553  | 1750       | 3515 | 185  |
| ----- ----- ----- ----- ----- ----- ----- ----- ----- ----- ----- -----       |   |      |      |             |      |      |            |      |      |            |      |      |
| Capacity Analysis Module:   |   |      |      |             |      |      |            |      |      |            |      |      |
| Vol/Sat:  | 0.10                                      | 0.10 | 0.10 | 0.11        | 0.11 | 0.11 | 0.03       | 0.23 | 0.23 | 0.02       | 0.17 | 0.17 |
| Crit Moves:   |   |      |      | ****        |      |      | ****       |      |      | ****       |      |      |
| Green Time:   | 26.5                                      | 26.5 | 26.5 | 26.5        | 26.5 | 26.5 | 18.7       | 55.5 | 55.5 | 7.0        | 43.8 | 43.8 |
| Volume/Cap:   | 0.36                                      | 0.36 | 0.36 | 0.41        | 0.41 | 0.41 | 0.18       | 0.41 | 0.41 | 0.34       | 0.37 | 0.37 |
| Delay/Veh:  | 29.4                                      | 29.4 | 29.4 | 29.9        | 29.9 | 29.9 | 33.5       | 12.1 | 12.1 | 44.9       | 18.1 | 18.1 |
| User DelAdj:  | 1.00                                      | 1.00 | 1.00 | 1.00        | 1.00 | 1.00 | 1.00       | 1.00 | 1.00 | 1.00       | 1.00 | 1.00 |
| AdjDel/Veh:   | 29.4                                      | 29.4 | 29.4 | 29.9        | 29.9 | 29.9 | 33.5       | 12.1 | 12.1 | 44.9       | 18.1 | 18.1 |
| LOS by Move:  | C   | C    | C    | C           | C    | C    | C          | B    | B    | D          | B    | B    |
| HCM2k95thQ:   | 9   | 9    | 9    | 10          | 10   | 10   | 3          | 14   | 14   | 3          | 12   | 12   |

Note: Queue reported is the number of cars per lane.

BART

Level Of Service Computation Report  
 2000 HCM Operations (Future Volume Alternative)  
 AM - Background Conditions

Intersection #3384: JACKSON/CAPITOL/SAN ANTONIO [Study Int 23]

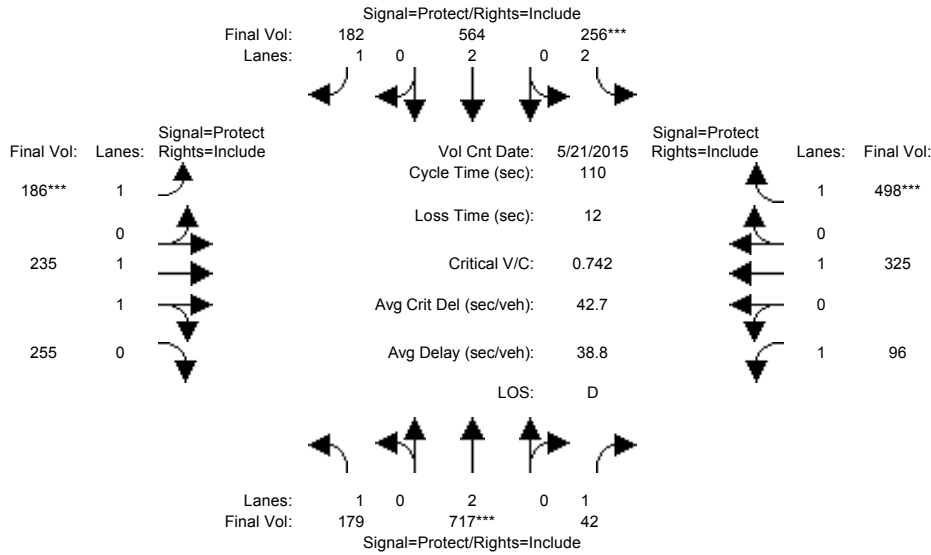

| Approach:  | North Bound |      |      | South Bound |      |      | East Bound |      |      | West Bound |      |      |
|--|-------------|------|------|-------------|------|------|------------|------|------|------------|------|------|
| Movement:  | L           | T    | R    | L           | T    | R    | L          | T    | R    | L          | T    | R    |
| Min. Green:  | 7           | 10   | 10   | 7           | 10   | 10   | 7          | 10   | 10   | 7          | 10   | 10   |
| Y+R:   | 4.0         | 4.0  | 4.0  | 4.0         | 4.0  | 4.0  | 4.0        | 4.0  | 4.0  | 4.0        | 4.0  | 4.0  |
| Volume Module: >> Count Date: 21 May 2015 << 7:30-8:30AM |             |      |      |             |      |      |            |      |      |            |      |      |
| Base Vol:  | 179         | 717  | 42   | 256         | 564  | 182  | 186        | 235  | 255  | 96         | 325  | 498  |
| Growth Adj:  | 1.00        | 1.00 | 1.00 | 1.00        | 1.00 | 1.00 | 1.00       | 1.00 | 1.00 | 1.00       | 1.00 | 1.00 |
| Initial Bse:   | 179         | 717  | 42   | 256         | 564  | 182  | 186        | 235  | 255  | 96         | 325  | 498  |
| Added Vol:   | 0           | 0    | 0    | 0           | 0    | 0    | 0          | 0    | 0    | 0          | 0    | 0    |
| PasserByVol:   | 0           | 0    | 0    | 0           | 0    | 0    | 0          | 0    | 0    | 0          | 0    | 0    |
| Initial Fut:   | 179         | 717  | 42   | 256         | 564  | 182  | 186        | 235  | 255  | 96         | 325  | 498  |
| User Adj:  | 1.00        | 1.00 | 1.00 | 1.00        | 1.00 | 1.00 | 1.00       | 1.00 | 1.00 | 1.00       | 1.00 | 1.00 |
| PHF Adj:   | 1.00        | 1.00 | 1.00 | 1.00        | 1.00 | 1.00 | 1.00       | 1.00 | 1.00 | 1.00       | 1.00 | 1.00 |
| PHF Volume:  | 179         | 717  | 42   | 256         | 564  | 182  | 186        | 235  | 255  | 96         | 325  | 498  |
| Reduct Vol:  | 0           | 0    | 0    | 0           | 0    | 0    | 0          | 0    | 0    | 0          | 0    | 0    |
| Reduced Vol:   | 179         | 717  | 42   | 256         | 564  | 182  | 186        | 235  | 255  | 96         | 325  | 498  |
| PCE Adj:   | 1.00        | 1.00 | 1.00 | 1.00        | 1.00 | 1.00 | 1.00       | 1.00 | 1.00 | 1.00       | 1.00 | 1.00 |
| MLF Adj:   | 1.00        | 1.00 | 1.00 | 1.00        | 1.00 | 1.00 | 1.00       | 1.00 | 1.00 | 1.00       | 1.00 | 1.00 |
| Final Volume:  | 179         | 717  | 42   | 256         | 564  | 182  | 186        | 235  | 255  | 96         | 325  | 498  |
| Saturation Flow Module:                                  |             |      |      |             |      |      |            |      |      |            |      |      |
| Sat/Lane:  | 1900        | 1900 | 1900 | 1900        | 1900 | 1900 | 1900       | 1900 | 1900 | 1900       | 1900 | 1900 |
| Adjustment:  | 0.92        | 1.00 | 0.92 | 0.83        | 1.00 | 0.92 | 0.92       | 1.00 | 0.92 | 0.92       | 1.00 | 0.92 |
| Lanes:   | 1.00        | 2.00 | 1.00 | 2.00        | 2.00 | 1.00 | 1.00       | 1.00 | 1.00 | 1.00       | 1.00 | 1.00 |
| Final Sat.:  | 1750        | 3800 | 1750 | 3150        | 3800 | 1750 | 1750       | 1900 | 1750 | 1750       | 1900 | 1750 |
| Capacity Analysis Module:                                |             |      |      |             |      |      |            |      |      |            |      |      |
| Vol/Sat:   | 0.10        | 0.19 | 0.02 | 0.08        | 0.15 | 0.10 | 0.11       | 0.12 | 0.15 | 0.05       | 0.17 | 0.28 |
| Crit Moves:  | ****        | **** | **** | ****        | **** | **** | ****       | **** | **** | ****       | **** | **** |
| Green Time:  | 16.3        | 28.0 | 28.0 | 12.1        | 23.7 | 23.7 | 15.8       | 40.3 | 40.3 | 17.6       | 42.2 | 42.2 |
| Volume/Cap:  | 0.69        | 0.74 | 0.09 | 0.74        | 0.69 | 0.48 | 0.74       | 0.34 | 0.40 | 0.34       | 0.45 | 0.74 |
| Delay/Veh:   | 52.0        | 40.8 | 31.4 | 55.8        | 42.2 | 38.8 | 56.4       | 25.3 | 26.0 | 41.8       | 25.6 | 33.6 |
| User DelAdj:   | 1.00        | 1.00 | 1.00 | 1.00        | 1.00 | 1.00 | 1.00       | 1.00 | 1.00 | 1.00       | 1.00 | 1.00 |
| AdjDel/Veh:  | 52.0        | 40.8 | 31.4 | 55.8        | 42.2 | 38.8 | 56.4       | 25.3 | 26.0 | 41.8       | 25.6 | 33.6 |
| LOS by Move:   | D           | D    | C    | E           | D    | D    | E          | C    | C    | D          | C    | C    |
| HCM2k95thQ:  | 12          | 21   | 2    | 13          | 18   | 12   | 13         | 11   | 13   | 7          | 15   | 29   |

Note: Queue reported is the number of cars per lane.

BART

Level Of Service Computation Report  
2000 HCM Operations (Future Volume Alternative)  
PM - Background Conditions

Intersection #3384: JACKSON/CAPITOL/SAN ANTONIO [Study Int 23]

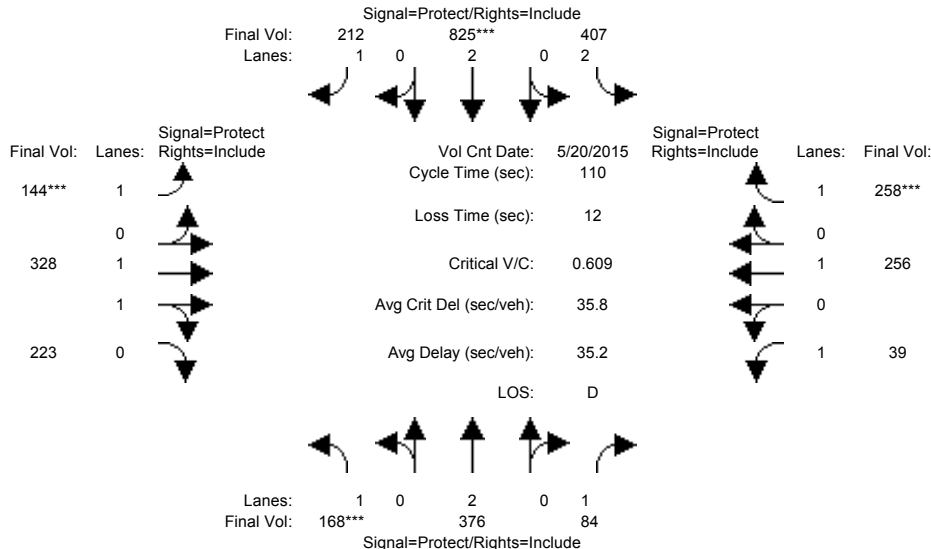

| Approach:  | North Bound |      |      | South Bound |      |      | East Bound |      |      | West Bound |      |      |
|--|-------------|------|------|-------------|------|------|------------|------|------|------------|------|------|
| Movement:  | L           | T    | R    | L           | T    | R    | L          | T    | R    | L          | T    | R    |
| Min. Green:  | 7           | 10   | 10   | 7           | 10   | 10   | 7          | 10   | 10   | 7          | 10   | 10   |
| Y+R:   | 4.0         | 4.0  | 4.0  | 4.0         | 4.0  | 4.0  | 4.0        | 4.0  | 4.0  | 4.0        | 4.0  | 4.0  |
| Volume Module: >> Count Date: 20 May 2015 << 5:00-6:00PM |             |      |      |             |      |      |            |      |      |            |      |      |
| Base Vol:  | 168         | 376  | 84   | 407         | 825  | 212  | 144        | 328  | 223  | 39         | 256  | 258  |
| Growth Adj:  | 1.00        | 1.00 | 1.00 | 1.00        | 1.00 | 1.00 | 1.00       | 1.00 | 1.00 | 1.00       | 1.00 | 1.00 |
| Initial Bse:   | 168         | 376  | 84   | 407         | 825  | 212  | 144        | 328  | 223  | 39         | 256  | 258  |
| Added Vol:   | 0           | 0    | 0    | 0           | 0    | 0    | 0          | 0    | 0    | 0          | 0    | 0    |
| PasserByVol:   | 0           | 0    | 0    | 0           | 0    | 0    | 0          | 0    | 0    | 0          | 0    | 0    |
| Initial Fut:   | 168         | 376  | 84   | 407         | 825  | 212  | 144        | 328  | 223  | 39         | 256  | 258  |
| User Adj:  | 1.00        | 1.00 | 1.00 | 1.00        | 1.00 | 1.00 | 1.00       | 1.00 | 1.00 | 1.00       | 1.00 | 1.00 |
| PHF Adj:   | 1.00        | 1.00 | 1.00 | 1.00        | 1.00 | 1.00 | 1.00       | 1.00 | 1.00 | 1.00       | 1.00 | 1.00 |
| PHF Volume:  | 168         | 376  | 84   | 407         | 825  | 212  | 144        | 328  | 223  | 39         | 256  | 258  |
| Reduct Vol:  | 0           | 0    | 0    | 0           | 0    | 0    | 0          | 0    | 0    | 0          | 0    | 0    |
| Reduced Vol:   | 168         | 376  | 84   | 407         | 825  | 212  | 144        | 328  | 223  | 39         | 256  | 258  |
| PCE Adj:   | 1.00        | 1.00 | 1.00 | 1.00        | 1.00 | 1.00 | 1.00       | 1.00 | 1.00 | 1.00       | 1.00 | 1.00 |
| MLF Adj:   | 1.00        | 1.00 | 1.00 | 1.00        | 1.00 | 1.00 | 1.00       | 1.00 | 1.00 | 1.00       | 1.00 | 1.00 |
| FinalVolume:   | 168         | 376  | 84   | 407         | 825  | 212  | 144        | 328  | 223  | 39         | 256  | 258  |
| Saturation Flow Module:                                  |             |      |      |             |      |      |            |      |      |            |      |      |
| Sat/Lane:  | 1900        | 1900 | 1900 | 1900        | 1900 | 1900 | 1900       | 1900 | 1900 | 1900       | 1900 | 1900 |
| Adjustment:  | 0.92        | 1.00 | 0.92 | 0.83        | 1.00 | 0.92 | 0.92       | 0.99 | 0.95 | 0.92       | 1.00 | 0.92 |
| Lanes:   | 1.00        | 2.00 | 1.00 | 2.00        | 2.00 | 1.00 | 1.00       | 1.17 | 0.83 | 1.00       | 1.00 | 1.00 |
| Final Sat.:  | 1750        | 3800 | 1750 | 3150        | 3800 | 1750 | 1750       | 2201 | 1497 | 1750       | 1900 | 1750 |
| Capacity Analysis Module:                                |             |      |      |             |      |      |            |      |      |            |      |      |
| Vol/Sat:   | 0.10        | 0.10 | 0.05 | 0.13        | 0.22 | 0.12 | 0.08       | 0.15 | 0.15 | 0.02       | 0.13 | 0.15 |
| Crit Moves:  | ****        |      |      | ****        |      |      | ****       |      |      | ****       |      |      |
| Green Time:  | 17.3        | 24.5 | 24.5 | 32.0        | 39.2 | 39.2 | 14.9       | 29.1 | 29.1 | 12.4       | 26.6 | 26.6 |
| Volume/Cap:  | 0.61        | 0.44 | 0.22 | 0.44        | 0.61 | 0.34 | 0.61       | 0.56 | 0.56 | 0.20       | 0.56 | 0.61 |
| Delay/Veh:   | 47.1        | 37.2 | 35.2 | 32.1        | 29.9 | 26.3 | 49.4       | 35.8 | 35.8 | 44.8       | 38.0 | 39.6 |
| User DelAdj:   | 1.00        | 1.00 | 1.00 | 1.00        | 1.00 | 1.00 | 1.00       | 1.00 | 1.00 | 1.00       | 1.00 | 1.00 |
| AdjDel/Veh:  | 47.1        | 37.2 | 35.2 | 32.1        | 29.9 | 26.3 | 49.4       | 35.8 | 35.8 | 44.8       | 38.0 | 39.6 |
| LOS by Move:   | D           | D    | D    | C           | C    | C    | D          | D    | D    | D          | D    | D    |
| HCM2k95thQ:  | 11          | 10   | 5    | 13          | 21   | 11   | 10         | 15   | 15   | 3          | 15   | 17   |

Note: Queue reported is the number of cars per lane.

BART

Level Of Service Computation Report  
2000 HCM Operations (Future Volume Alternative)  
AM - Background Conditions

Intersection #3411: AVIATION/COLEMAN [Study Int 34]

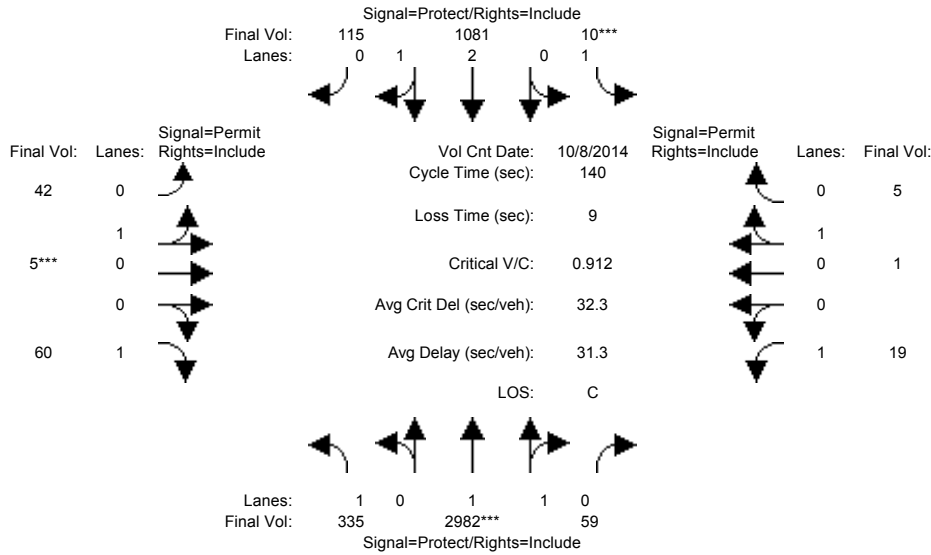

| Approach:                                   | North Bound |      |       | South Bound |      |      | East Bound |      |      | West Bound |      |      |
|---|-------------|------|-------|-------------|------|------|------------|------|------|------------|------|------|
| Movement:                                   | L           | T    | R     | L           | T    | R    | L          | T    | R    | L          | T    | R    |
| Min. Green:                                 | 7           | 10   | 10    | 7           | 10   | 10   | 10         | 10   | 10   | 10         | 10   | 10   |
| Y+R:  | 4.0         | 4.0  | 4.0   | 4.0         | 4.0  | 4.0  | 4.0        | 4.0  | 4.0  | 4.0        | 4.0  | 4.0  |
| Volume Module: >> Count Date: 8 Oct 2014 << |             |      |       |             |      |      |            |      |      |            |      |      |
| Base Vol:                                   | 335         | 2982 | 59    | 10          | 1081 | 115  | 42         | 5    | 60   | 19         | 1    | 5    |
| Growth Adj:                                 | 1.00        | 1.00 | 1.00  | 1.00        | 1.00 | 1.00 | 1.00       | 1.00 | 1.00 | 1.00       | 1.00 | 1.00 |
| Initial Bse:                                | 335         | 2982 | 59    | 10          | 1081 | 115  | 42         | 5    | 60   | 19         | 1    | 5    |
| Added Vol:                                  | 0           | 0    | 0     | 0           | 0    | 0    | 0          | 0    | 0    | 0          | 0    | 0    |
| PasserByVol:                                | 0           | 0    | 0     | 0           | 0    | 0    | 0          | 0    | 0    | 0          | 0    | 0    |
| Initial Fut:                                | 335         | 2982 | 59    | 10          | 1081 | 115  | 42         | 5    | 60   | 19         | 1    | 5    |
| User Adj:                                   | 1.00        | 1.00 | 1.00  | 1.00        | 1.00 | 1.00 | 1.00       | 1.00 | 1.00 | 1.00       | 1.00 | 1.00 |
| PHF Adj:                                    | 1.00        | 1.00 | 1.00  | 1.00        | 1.00 | 1.00 | 1.00       | 1.00 | 1.00 | 1.00       | 1.00 | 1.00 |
| PHF Volume:                                 | 335         | 2982 | 59    | 10          | 1081 | 115  | 42         | 5    | 60   | 19         | 1    | 5    |
| Reduct Vol:                                 | 0           | 0    | 0     | 0           | 0    | 0    | 0          | 0    | 0    | 0          | 0    | 0    |
| Reduced Vol:                                | 335         | 2982 | 59    | 10          | 1081 | 115  | 42         | 5    | 60   | 19         | 1    | 5    |
| PCE Adj:                                    | 1.00        | 1.00 | 1.00  | 1.00        | 1.00 | 1.00 | 1.00       | 1.00 | 1.00 | 1.00       | 1.00 | 1.00 |
| MLF Adj:                                    | 1.00        | 1.00 | 1.00  | 1.00        | 1.00 | 1.00 | 1.00       | 1.00 | 1.00 | 1.00       | 1.00 | 1.00 |
| Final Volume:                               | 335         | 2982 | 59    | 10          | 1081 | 115  | 42         | 5    | 60   | 19         | 1    | 5    |
| Saturation Flow Module:                     |             |      |       |             |      |      |            |      |      |            |      |      |
| Sat/Lane:                                   | 1900        | 1900 | 1900  | 1900        | 1900 | 1900 | 1900       | 1900 | 1900 | 1900       | 1900 | 1900 |
| Adjustment:                                 | 0.92        | 0.97 | 0.95  | 0.92        | 0.99 | 0.95 | 0.95       | 0.95 | 0.92 | 0.92       | 0.95 | 0.95 |
| Lanes:                                      | 1.00        | 1.96 | 0.04  | 1.00        | 2.70 | 0.30 | 0.89       | 0.11 | 1.00 | 1.00       | 0.17 | 0.83 |
| Final Sat.:                                 | 1750        | 3628 | 72    | 1750        | 5061 | 538  | 1609       | 191  | 1750 | 1750       | 300  | 1500 |
| Capacity Analysis Module:                   |             |      |       |             |      |      |            |      |      |            |      |      |
| Vol/Sat:                                    | 0.19        | 0.82 | 0.82  | 0.01        | 0.21 | 0.21 | 0.03       | 0.03 | 0.03 | 0.01       | 0.00 | 0.00 |
| Crit Moves:                                 | ****        | **** | ****  | ****        | **** | **** | ****       | **** | **** | ****       | **** | **** |
| Green Time:                                 | 57.2        | 114  | 114.0 | 7.0         | 63.8 | 63.8 | 10.0       | 10.0 | 10.0 | 10.0       | 10.0 | 10.0 |
| Volume/Cap:                                 | 0.47        | 1.01 | 1.01  | 0.11        | 0.47 | 0.47 | 0.37       | 0.37 | 0.48 | 0.15       | 0.05 | 0.05 |
| Delay/Veh:                                  | 30.8        | 31.7 | 31.7  | 64.1        | 26.5 | 26.5 | 63.7       | 63.7 | 65.4 | 61.6       | 60.7 | 60.7 |
| User DelAdj:                                | 1.00        | 1.00 | 1.00  | 1.00        | 1.00 | 1.00 | 1.00       | 1.00 | 1.00 | 1.00       | 1.00 | 1.00 |
| AdjDel/Veh:                                 | 30.8        | 31.7 | 31.7  | 64.1        | 26.5 | 26.5 | 63.7       | 63.7 | 65.4 | 61.6       | 60.7 | 60.7 |
| LOS by Move:                                | C           | C    | C     | E           | C    | C    | E          | E    | E    | E          | E    | E    |
| HCM2k95thQ:                                 | 20          | 109  | 109   | 1           | 21   | 21   | 5          | 5    | 7    | 2          | 1    | 1    |

Note: Queue reported is the number of cars per lane.



BART

Level Of Service Computation Report  
 2000 HCM Operations (Future Volume Alternative)  
 PM - Background Conditions

Intersection #3411: AVIATION/COLEMAN [Study Int 34]

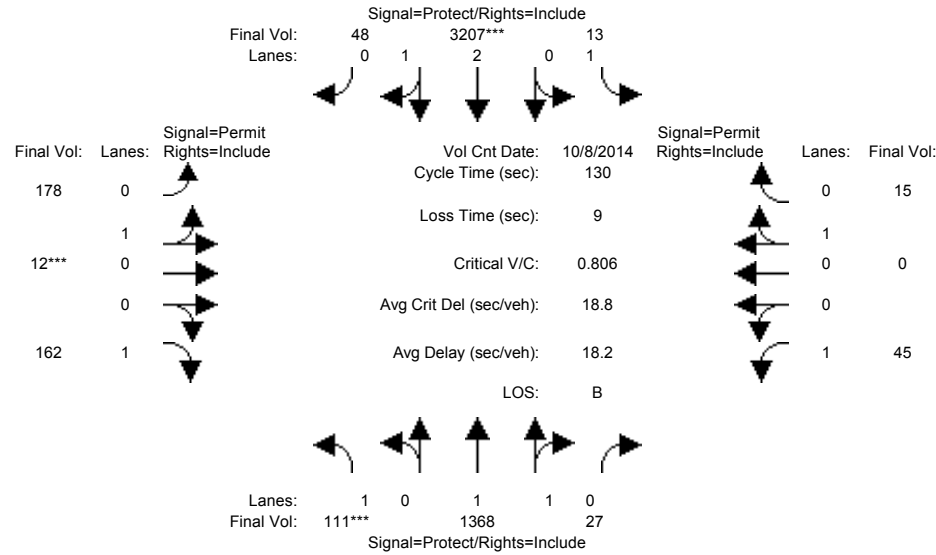

| Approach:                                   | North Bound |      |      | South Bound |      |      | East Bound |      |      | West Bound |      |      |
|---|-------------|------|------|-------------|------|------|------------|------|------|------------|------|------|
| Movement:                                   | L           | T    | R    | L           | T    | R    | L          | T    | R    | L          | T    | R    |
| Min. Green:                                 | 7           | 10   | 10   | 7           | 10   | 10   | 10         | 10   | 10   | 10         | 10   | 10   |
| Y+R:  | 4.0         | 4.0  | 4.0  | 4.0         | 4.0  | 4.0  | 4.0        | 4.0  | 4.0  | 4.0        | 4.0  | 4.0  |
| Volume Module: >> Count Date: 8 Oct 2014 << |             |      |      |             |      |      |            |      |      |            |      |      |
| Base Vol:                                   | 111         | 1368 | 27   | 13          | 3207 | 48   | 178        | 12   | 162  | 45         | 0    | 15   |
| Growth Adj:                                 | 1.00        | 1.00 | 1.00 | 1.00        | 1.00 | 1.00 | 1.00       | 1.00 | 1.00 | 1.00       | 1.00 | 1.00 |
| Initial Bse:                                | 111         | 1368 | 27   | 13          | 3207 | 48   | 178        | 12   | 162  | 45         | 0    | 15   |
| Added Vol:                                  | 0           | 0    | 0    | 0           | 0    | 0    | 0          | 0    | 0    | 0          | 0    | 0    |
| PasserByVol:                                | 0           | 0    | 0    | 0           | 0    | 0    | 0          | 0    | 0    | 0          | 0    | 0    |
| Initial Fut:                                | 111         | 1368 | 27   | 13          | 3207 | 48   | 178        | 12   | 162  | 45         | 0    | 15   |
| User Adj:                                   | 1.00        | 1.00 | 1.00 | 1.00        | 1.00 | 1.00 | 1.00       | 1.00 | 1.00 | 1.00       | 1.00 | 1.00 |
| PHF Adj:                                    | 1.00        | 1.00 | 1.00 | 1.00        | 1.00 | 1.00 | 1.00       | 1.00 | 1.00 | 1.00       | 1.00 | 1.00 |
| PHF Volume:                                 | 111         | 1368 | 27   | 13          | 3207 | 48   | 178        | 12   | 162  | 45         | 0    | 15   |
| Reduct Vol:                                 | 0           | 0    | 0    | 0           | 0    | 0    | 0          | 0    | 0    | 0          | 0    | 0    |
| Reduced Vol:                                | 111         | 1368 | 27   | 13          | 3207 | 48   | 178        | 12   | 162  | 45         | 0    | 15   |
| PCE Adj:                                    | 1.00        | 1.00 | 1.00 | 1.00        | 1.00 | 1.00 | 1.00       | 1.00 | 1.00 | 1.00       | 1.00 | 1.00 |
| MLF Adj:                                    | 1.00        | 1.00 | 1.00 | 1.00        | 1.00 | 1.00 | 1.00       | 1.00 | 1.00 | 1.00       | 1.00 | 1.00 |
| Final Volume:                               | 111         | 1368 | 27   | 13          | 3207 | 48   | 178        | 12   | 162  | 45         | 0    | 15   |
| Saturation Flow Module:                     |             |      |      |             |      |      |            |      |      |            |      |      |
| Sat/Lane:                                   | 1900        | 1900 | 1900 | 1900        | 1900 | 1900 | 1900       | 1900 | 1900 | 1900       | 1900 | 1900 |
| Adjustment:                                 | 0.92        | 0.97 | 0.95 | 0.92        | 0.98 | 0.95 | 0.95       | 0.95 | 0.92 | 0.92       | 1.00 | 0.95 |
| Lanes:                                      | 1.00        | 1.96 | 0.04 | 1.00        | 2.95 | 0.05 | 0.94       | 0.06 | 1.00 | 1.00       | 0.00 | 1.00 |
| Final Sat.:                                 | 1750        | 3628 | 72   | 1750        | 5517 | 83   | 1686       | 114  | 1750 | 1750       | 0    | 1800 |
| Capacity Analysis Module:                   |             |      |      |             |      |      |            |      |      |            |      |      |
| Vol/Sat:                                    | 0.06        | 0.38 | 0.38 | 0.01        | 0.58 | 0.58 | 0.11       | 0.11 | 0.09 | 0.03       | 0.00 | 0.01 |
| Crit Moves:                                 | ****        |      |      | ****        |      |      | ****       |      |      |            |      |      |
| Green Time:                                 | 10.2        | 91.0 | 91.0 | 13.0        | 93.7 | 93.7 | 17.0       | 17.0 | 17.0 | 17.0       | 17.0 | 17.0 |
| Volume/Cap:                                 | 0.81        | 0.54 | 0.54 | 0.07        | 0.81 | 0.81 | 0.81       | 0.81 | 0.71 | 0.20       | 0.00 | 0.06 |
| Delay/Veh:                                  | 87.2        | 9.6  | 9.6  | 53.2        | 13.3 | 13.3 | 73.0       | 73.0 | 63.8 | 50.8       | 0.0  | 49.6 |
| User DelAdj:                                | 1.00        | 1.00 | 1.00 | 1.00        | 1.00 | 1.00 | 1.00       | 1.00 | 1.00 | 1.00       | 1.00 | 1.00 |
| AdjDel/Veh:                                 | 87.2        | 9.6  | 9.6  | 53.2        | 13.3 | 13.3 | 73.0       | 73.0 | 63.8 | 50.8       | 0.0  | 49.6 |
| LOS by Move:                                | F           | A    | A    | D           | B    | B    | E          | E    | E    | D          | A    | D    |
| HCM2k95thQ:                                 | 10          | 24   | 24   | 1           | 44   | 44   | 18         | 18   | 15   | 4          | 0    | 1    |

Note: Queue reported is the number of cars per lane.

BART

Level Of Service Computation Report  
 2000 HCM Operations (Future Volume Alternative)  
 AM - Background Conditions

Intersection #3413: Coleman/Hedding [Study Int 38]

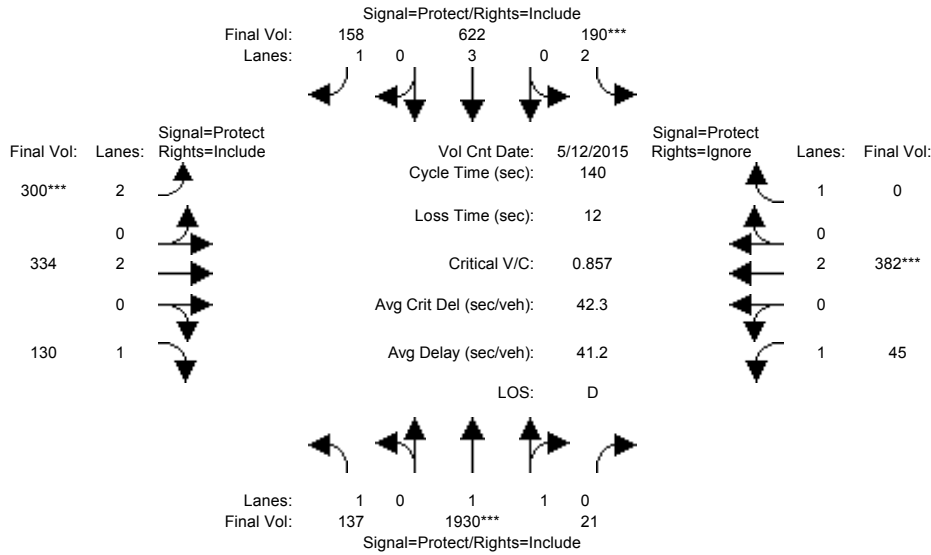

| Approach:                     | North Bound                |      |      | South Bound |      |      | East Bound |      |      | West Bound |      |      |
|-------------------------------|----------------------------|------|------|-------------|------|------|------------|------|------|------------|------|------|
| Movement:                     | L                          | T    | R    | L           | T    | R    | L          | T    | R    | L          | T    | R    |
| Min. Green:                   | 7                          | 10   | 10   | 7           | 10   | 10   | 7          | 10   | 10   | 7          | 10   | 10   |
| Y+R:                          | 4.0                        | 4.0  | 4.0  | 4.0         | 4.0  | 4.0  | 4.0        | 4.0  | 4.0  | 4.0        | 4.0  | 4.0  |
| Volume Module: >> Count Date: | 12 May 2015 << 7:45-8:45AM |      |      |             |      |      |            |      |      |            |      |      |
| Base Vol:                     | 137                        | 1930 | 21   | 190         | 622  | 158  | 300        | 334  | 130  | 45         | 382  | 789  |
| Growth Adj:                   | 1.00                       | 1.00 | 1.00 | 1.00        | 1.00 | 1.00 | 1.00       | 1.00 | 1.00 | 1.00       | 1.00 | 1.00 |
| Initial Bse:                  | 137                        | 1930 | 21   | 190         | 622  | 158  | 300        | 334  | 130  | 45         | 382  | 789  |
| Added Vol:                    | 0                          | 0    | 0    | 0           | 0    | 0    | 0          | 0    | 0    | 0          | 0    | 0    |
| PasserByVol:                  | 0                          | 0    | 0    | 0           | 0    | 0    | 0          | 0    | 0    | 0          | 0    | 0    |
| Initial Fut:                  | 137                        | 1930 | 21   | 190         | 622  | 158  | 300        | 334  | 130  | 45         | 382  | 789  |
| User Adj:                     | 1.00                       | 1.00 | 1.00 | 1.00        | 1.00 | 1.00 | 1.00       | 1.00 | 1.00 | 1.00       | 1.00 | 0.00 |
| PHF Adj:                      | 1.00                       | 1.00 | 1.00 | 1.00        | 1.00 | 1.00 | 1.00       | 1.00 | 1.00 | 1.00       | 1.00 | 0.00 |
| PHF Volume:                   | 137                        | 1930 | 21   | 190         | 622  | 158  | 300        | 334  | 130  | 45         | 382  | 0    |
| Reduct Vol:                   | 0                          | 0    | 0    | 0           | 0    | 0    | 0          | 0    | 0    | 0          | 0    | 0    |
| Reduced Vol:                  | 137                        | 1930 | 21   | 190         | 622  | 158  | 300        | 334  | 130  | 45         | 382  | 0    |
| PCE Adj:                      | 1.00                       | 1.00 | 1.00 | 1.00        | 1.00 | 1.00 | 1.00       | 1.00 | 1.00 | 1.00       | 1.00 | 0.00 |
| MLF Adj:                      | 1.00                       | 1.00 | 1.00 | 1.00        | 1.00 | 1.00 | 1.00       | 1.00 | 1.00 | 1.00       | 1.00 | 0.00 |
| Final Volume:                 | 137                        | 1930 | 21   | 190         | 622  | 158  | 300        | 334  | 130  | 45         | 382  | 0    |
| Saturation Flow Module:       |                            |      |      |             |      |      |            |      |      |            |      |      |
| Sat/Lane:                     | 1900                       | 1900 | 1900 | 1900        | 1900 | 1900 | 1900       | 1900 | 1900 | 1900       | 1900 | 1900 |
| Adjustment:                   | 0.92                       | 0.97 | 0.95 | 0.83        | 0.83 | 0.92 | 0.83       | 1.00 | 0.92 | 0.92       | 1.00 | 0.92 |
| Lanes:                        | 1.00                       | 1.98 | 0.02 | 2.00        | 3.00 | 1.00 | 2.00       | 2.00 | 1.00 | 1.00       | 2.00 | 1.00 |
| Final Sat.:                   | 1750                       | 3660 | 40   | 3150        | 4750 | 1750 | 3150       | 3800 | 1750 | 1750       | 3800 | 1750 |
| Capacity Analysis Module:     |                            |      |      |             |      |      |            |      |      |            |      |      |
| Vol/Sat:                      | 0.08                       | 0.53 | 0.53 | 0.06        | 0.13 | 0.09 | 0.10       | 0.09 | 0.07 | 0.03       | 0.10 | 0.00 |
| Crit Moves:                   | ****                       |      |      | ****        |      |      | ****       |      |      | ****       |      |      |
| Green Time:                   | 35.9                       | 86.2 | 86.2 | 9.9         | 60.1 | 60.1 | 15.6       | 20.4 | 20.4 | 11.6       | 16.4 | 0.0  |
| Volume/Cap:                   | 0.31                       | 0.86 | 0.86 | 0.86        | 0.31 | 0.21 | 0.86       | 0.60 | 0.51 | 0.31       | 0.86 | 0.00 |
| Delay/Veh:                    | 42.4                       | 25.4 | 25.4 | 90.9        | 26.3 | 25.2 | 79.6       | 57.9 | 56.9 | 61.7       | 75.7 | 0.0  |
| User DelAdj:                  | 1.00                       | 1.00 | 1.00 | 1.00        | 1.00 | 1.00 | 1.00       | 1.00 | 1.00 | 1.00       | 1.00 | 1.00 |
| AdjDel/Veh:                   | 42.4                       | 25.4 | 25.4 | 90.9        | 26.3 | 25.2 | 79.6       | 57.9 | 56.9 | 61.7       | 75.7 | 0.0  |
| LOS by Move:                  | D                          | C    | C    | F           | C    | C    | E          | E    | E    | E          | E    | A    |
| HCM2k95thQ:                   | 9                          | 52   | 52   | 11          | 11   | 9    | 15         | 12   | 10   | 5          | 19   | 0    |

Note: Queue reported is the number of cars per lane.

BART

Level Of Service Computation Report  
2000 HCM Operations (Future Volume Alternative)  
PM - Background Conditions

Intersection #3413: Coleman/Hedding [Study Int 38]

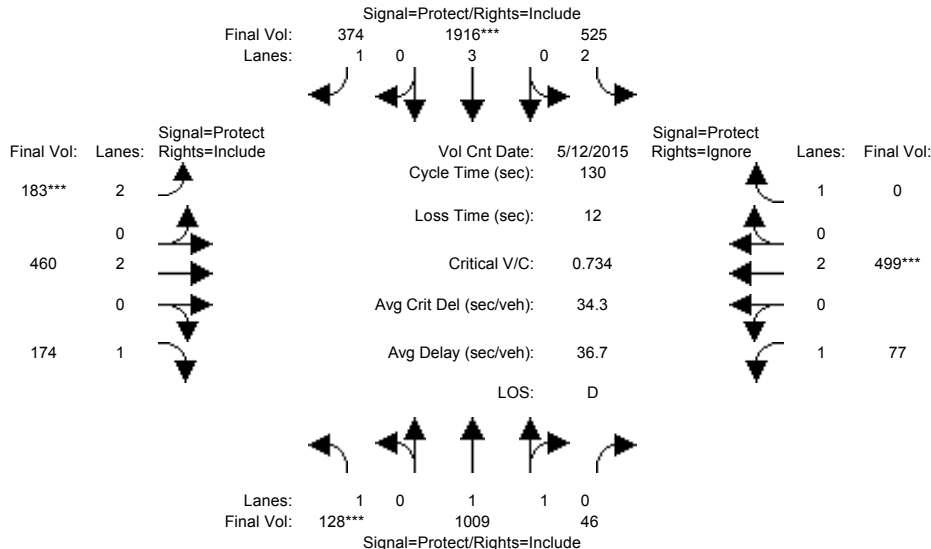

| Approach:  | North Bound |      |      | South Bound |      |      | East Bound |      |      | West Bound |      |      |
|--|-------------|------|------|-------------|------|------|------------|------|------|------------|------|------|
| Movement:  | L           | T    | R    | L           | T    | R    | L          | T    | R    | L          | T    | R    |
| Min. Green:  | 7           | 10   | 10   | 7           | 10   | 10   | 7          | 10   | 10   | 7          | 10   | 10   |
| Y+R:   | 4.0         | 4.0  | 4.0  | 4.0         | 4.0  | 4.0  | 4.0        | 4.0  | 4.0  | 4.0        | 4.0  | 4.0  |
| Volume Module: >> Count Date: 12 May 2015 << 5:00-6:00PM |             |      |      |             |      |      |            |      |      |            |      |      |
| Base Vol:  | 128         | 1009 | 46   | 525         | 1916 | 374  | 183        | 460  | 174  | 77         | 499  | 356  |
| Growth Adj:  | 1.00        | 1.00 | 1.00 | 1.00        | 1.00 | 1.00 | 1.00       | 1.00 | 1.00 | 1.00       | 1.00 | 1.00 |
| Initial Bse:   | 128         | 1009 | 46   | 525         | 1916 | 374  | 183        | 460  | 174  | 77         | 499  | 356  |
| Added Vol:   | 0           | 0    | 0    | 0           | 0    | 0    | 0          | 0    | 0    | 0          | 0    | 0    |
| PasserByVol:   | 0           | 0    | 0    | 0           | 0    | 0    | 0          | 0    | 0    | 0          | 0    | 0    |
| Initial Fut:   | 128         | 1009 | 46   | 525         | 1916 | 374  | 183        | 460  | 174  | 77         | 499  | 356  |
| User Adj:  | 1.00        | 1.00 | 1.00 | 1.00        | 1.00 | 1.00 | 1.00       | 1.00 | 1.00 | 1.00       | 1.00 | 0.00 |
| PHF Adj:   | 1.00        | 1.00 | 1.00 | 1.00        | 1.00 | 1.00 | 1.00       | 1.00 | 1.00 | 1.00       | 1.00 | 0.00 |
| PHF Volume:  | 128         | 1009 | 46   | 525         | 1916 | 374  | 183        | 460  | 174  | 77         | 499  | 0    |
| Reduct Vol:  | 0           | 0    | 0    | 0           | 0    | 0    | 0          | 0    | 0    | 0          | 0    | 0    |
| Reduced Vol:   | 128         | 1009 | 46   | 525         | 1916 | 374  | 183        | 460  | 174  | 77         | 499  | 0    |
| PCE Adj:   | 1.00        | 1.00 | 1.00 | 1.00        | 1.00 | 1.00 | 1.00       | 1.00 | 1.00 | 1.00       | 1.00 | 0.00 |
| MLF Adj:   | 1.00        | 1.00 | 1.00 | 1.00        | 1.00 | 1.00 | 1.00       | 1.00 | 1.00 | 1.00       | 1.00 | 0.00 |
| Final Volume:  | 128         | 1009 | 46   | 525         | 1916 | 374  | 183        | 460  | 174  | 77         | 499  | 0    |
| Saturation Flow Module:                                  |             |      |      |             |      |      |            |      |      |            |      |      |
| Sat/Lane:  | 1900        | 1900 | 1900 | 1900        | 1900 | 1900 | 1900       | 1900 | 1900 | 1900       | 1900 | 1900 |
| Adjustment:  | 0.92        | 0.97 | 0.95 | 0.83        | 0.83 | 0.92 | 0.83       | 1.00 | 0.92 | 0.92       | 1.00 | 0.92 |
| Lanes:   | 1.00        | 1.91 | 0.09 | 2.00        | 3.00 | 1.00 | 2.00       | 2.00 | 1.00 | 1.00       | 2.00 | 1.00 |
| Final Sat.:  | 1750        | 3539 | 161  | 3150        | 4750 | 1750 | 3150       | 3800 | 1750 | 1750       | 3800 | 1750 |
| Capacity Analysis Module:                                |             |      |      |             |      |      |            |      |      |            |      |      |
| Vol/Sat:   | 0.07        | 0.29 | 0.29 | 0.17        | 0.40 | 0.21 | 0.06       | 0.12 | 0.10 | 0.04       | 0.13 | 0.00 |
| Crit Moves:  | ****        |      |      | ****        |      |      | ****       |      |      | ****       |      |      |
| Green Time:  | 13.0        | 53.3 | 53.3 | 31.1        | 71.5 | 71.5 | 10.3       | 23.2 | 23.2 | 10.3       | 23.3 | 0.0  |
| Volume/Cap:  | 0.73        | 0.70 | 0.70 | 0.70        | 0.73 | 0.39 | 0.73       | 0.68 | 0.56 | 0.55       | 0.73 | 0.00 |
| Delay/Veh:   | 71.7        | 33.1 | 33.1 | 47.9        | 23.2 | 17.0 | 69.2       | 52.6 | 50.9 | 62.4       | 54.6 | 0.0  |
| User DelAdj:   | 1.00        | 1.00 | 1.00 | 1.00        | 1.00 | 1.00 | 1.00       | 1.00 | 1.00 | 1.00       | 1.00 | 1.00 |
| AdjDel/Veh:  | 71.7        | 33.1 | 33.1 | 47.9        | 23.2 | 17.0 | 69.2       | 52.6 | 50.9 | 62.4       | 54.6 | 0.0  |
| LOS by Move:   | E           | C    | C    | D           | C    | B    | E          | D    | D    | E          | D    | A    |
| HCM2k95thQ:  | 10          | 30   | 30   | 21          | 32   | 16   | 9          | 16   | 13   | 8          | 20   | 0    |

Note: Queue reported is the number of cars per lane.

BART

Level Of Service Computation Report  
2000 HCM Operations (Future Volume Alternative)  
AM - Background Conditions

Intersection #3417: Coleman/Taylor [Study Int 39]

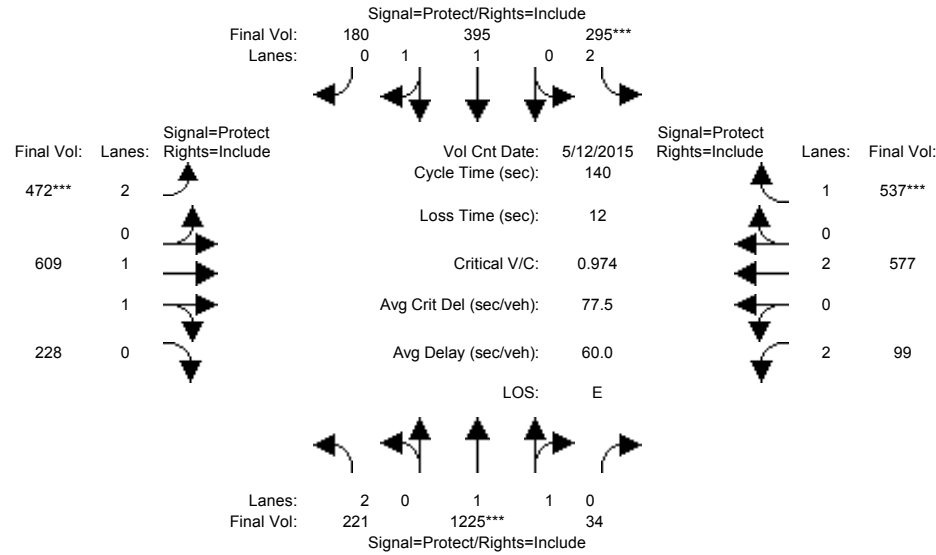

| Approach:  | North Bound |      |      | South Bound |      |      | East Bound |      |      | West Bound |      |      |
|--|-------------|------|------|-------------|------|------|------------|------|------|------------|------|------|
| Movement:  | L           | T    | R    | L           | T    | R    | L          | T    | R    | L          | T    | R    |
| Min. Green:  | 7           | 10   | 10   | 7           | 10   | 10   | 7          | 10   | 10   | 7          | 10   | 10   |
| Y+R:   | 4.0         | 4.0  | 4.0  | 4.0         | 4.0  | 4.0  | 4.0        | 4.0  | 4.0  | 4.0        | 4.0  | 4.0  |
| Volume Module: >> Count Date: 12 May 2015 << 7:30-8:30AM |             |      |      |             |      |      |            |      |      |            |      |      |
| Base Vol:  | 221         | 1225 | 34   | 295         | 395  | 180  | 472        | 609  | 228  | 99         | 577  | 537  |
| Growth Adj:  | 1.00        | 1.00 | 1.00 | 1.00        | 1.00 | 1.00 | 1.00       | 1.00 | 1.00 | 1.00       | 1.00 | 1.00 |
| Initial Bse:   | 221         | 1225 | 34   | 295         | 395  | 180  | 472        | 609  | 228  | 99         | 577  | 537  |
| Added Vol:   | 0           | 0    | 0    | 0           | 0    | 0    | 0          | 0    | 0    | 0          | 0    | 0    |
| PasserByVol:   | 0           | 0    | 0    | 0           | 0    | 0    | 0          | 0    | 0    | 0          | 0    | 0    |
| Initial Fut:   | 221         | 1225 | 34   | 295         | 395  | 180  | 472        | 609  | 228  | 99         | 577  | 537  |
| User Adj:  | 1.00        | 1.00 | 1.00 | 1.00        | 1.00 | 1.00 | 1.00       | 1.00 | 1.00 | 1.00       | 1.00 | 1.00 |
| PHF Adj:   | 1.00        | 1.00 | 1.00 | 1.00        | 1.00 | 1.00 | 1.00       | 1.00 | 1.00 | 1.00       | 1.00 | 1.00 |
| PHF Volume:  | 221         | 1225 | 34   | 295         | 395  | 180  | 472        | 609  | 228  | 99         | 577  | 537  |
| Reduct Vol:  | 0           | 0    | 0    | 0           | 0    | 0    | 0          | 0    | 0    | 0          | 0    | 0    |
| Reduced Vol:   | 221         | 1225 | 34   | 295         | 395  | 180  | 472        | 609  | 228  | 99         | 577  | 537  |
| PCE Adj:   | 1.00        | 1.00 | 1.00 | 1.00        | 1.00 | 1.00 | 1.00       | 1.00 | 1.00 | 1.00       | 1.00 | 1.00 |
| MLF Adj:   | 1.00        | 1.00 | 1.00 | 1.00        | 1.00 | 1.00 | 1.00       | 1.00 | 1.00 | 1.00       | 1.00 | 1.00 |
| Final Volume:  | 221         | 1225 | 34   | 295         | 395  | 180  | 472        | 609  | 228  | 99         | 577  | 537  |
| Saturation Flow Module:                                  |             |      |      |             |      |      |            |      |      |            |      |      |
| Sat/Lane:  | 1900        | 1900 | 1900 | 1900        | 1900 | 1900 | 1900       | 1900 | 1900 | 1900       | 1900 | 1900 |
| Adjustment:  | 0.83        | 0.97 | 0.95 | 0.83        | 0.99 | 0.95 | 0.83       | 0.98 | 0.95 | 0.83       | 1.00 | 0.92 |
| Lanes:   | 2.00        | 1.94 | 0.06 | 2.00        | 1.36 | 0.64 | 2.00       | 1.44 | 0.56 | 2.00       | 2.00 | 1.00 |
| Final Sat.:  | 3150        | 3600 | 100  | 3150        | 2541 | 1158 | 3150       | 2691 | 1008 | 3150       | 3800 | 1750 |
| Capacity Analysis Module:                                |             |      |      |             |      |      |            |      |      |            |      |      |
| Vol/Sat:   | 0.07        | 0.34 | 0.34 | 0.09        | 0.16 | 0.16 | 0.15       | 0.23 | 0.23 | 0.03       | 0.15 | 0.31 |
| Crit Moves:  | ****        | **** | **** | ****        | **** | **** | ****       | **** | **** | ****       | **** | **** |
| Green Time:  | 19.4        | 48.9 | 48.9 | 13.5        | 43.0 | 43.0 | 21.5       | 53.8 | 53.8 | 11.9       | 44.1 | 44.1 |
| Volume/Cap:  | 0.51        | 0.97 | 0.97 | 0.97        | 0.51 | 0.51 | 0.97       | 0.59 | 0.59 | 0.37       | 0.48 | 0.97 |
| Delay/Veh:   | 56.8        | 64.0 | 64.0 | 107.6       | 40.2 | 40.2 | 93.1       | 35.0 | 35.0 | 61.4       | 39.0 | 79.1 |
| User DelAdj:   | 1.00        | 1.00 | 1.00 | 1.00        | 1.00 | 1.00 | 1.00       | 1.00 | 1.00 | 1.00       | 1.00 | 1.00 |
| AdjDel/Veh:  | 56.8        | 64.0 | 64.0 | 107.6       | 40.2 | 40.2 | 93.1       | 35.0 | 35.0 | 61.4       | 39.0 | 79.1 |
| LOS by Move:   | E           | E    | E    | F           | D    | D    | F          | C    | C    | E          | D    | E    |
| HCM2k95thQ:  | 11          | 52   | 52   | 17          | 19   | 19   | 25         | 25   | 25   | 5          | 18   | 45   |

Note: Queue reported is the number of cars per lane.

BART

Level Of Service Computation Report  
 2000 HCM Operations (Future Volume Alternative)  
 PM - Background Conditions

Intersection #3417: Coleman/Taylor [Study Int 39]

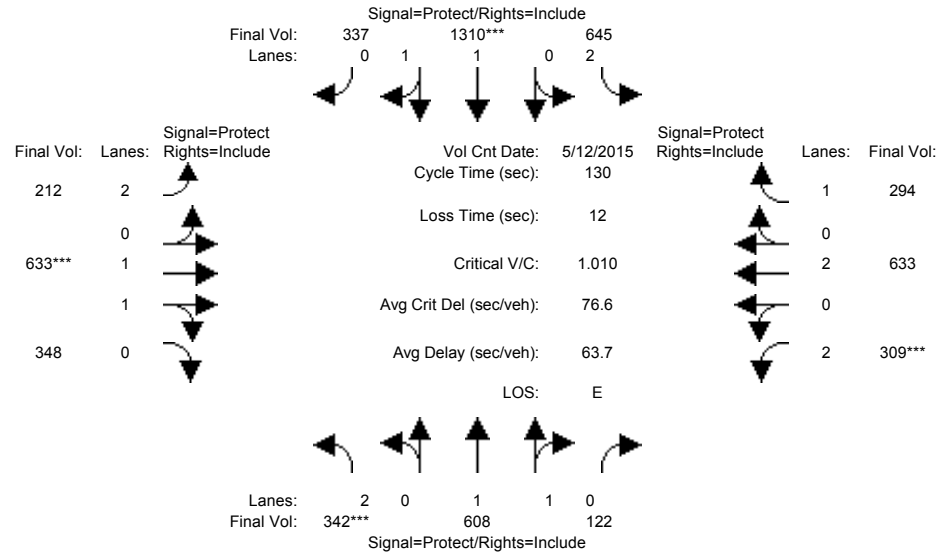

| Approach:  | North Bound |      |      | South Bound |      |      | East Bound |      |      | West Bound |      |      |
|--|-------------|------|------|-------------|------|------|------------|------|------|------------|------|------|
| Movement:  | L           | T    | R    | L           | T    | R    | L          | T    | R    | L          | T    | R    |
| Min. Green:  | 7           | 10   | 10   | 7           | 10   | 10   | 7          | 10   | 10   | 7          | 10   | 10   |
| Y+R:   | 4.0         | 4.0  | 4.0  | 4.0         | 4.0  | 4.0  | 4.0        | 4.0  | 4.0  | 4.0        | 4.0  | 4.0  |
| Volume Module: >> Count Date: 12 May 2015 << 5:00-6:00PM |             |      |      |             |      |      |            |      |      |            |      |      |
| Base Vol:  | 342         | 608  | 122  | 645         | 1310 | 337  | 212        | 633  | 348  | 309        | 633  | 294  |
| Growth Adj:  | 1.00        | 1.00 | 1.00 | 1.00        | 1.00 | 1.00 | 1.00       | 1.00 | 1.00 | 1.00       | 1.00 | 1.00 |
| Initial Bse:   | 342         | 608  | 122  | 645         | 1310 | 337  | 212        | 633  | 348  | 309        | 633  | 294  |
| Added Vol:   | 0           | 0    | 0    | 0           | 0    | 0    | 0          | 0    | 0    | 0          | 0    | 0    |
| PasserByVol:   | 0           | 0    | 0    | 0           | 0    | 0    | 0          | 0    | 0    | 0          | 0    | 0    |
| Initial Fut:   | 342         | 608  | 122  | 645         | 1310 | 337  | 212        | 633  | 348  | 309        | 633  | 294  |
| User Adj:  | 1.00        | 1.00 | 1.00 | 1.00        | 1.00 | 1.00 | 1.00       | 1.00 | 1.00 | 1.00       | 1.00 | 1.00 |
| PHF Adj:   | 1.00        | 1.00 | 1.00 | 1.00        | 1.00 | 1.00 | 1.00       | 1.00 | 1.00 | 1.00       | 1.00 | 1.00 |
| PHF Volume:  | 342         | 608  | 122  | 645         | 1310 | 337  | 212        | 633  | 348  | 309        | 633  | 294  |
| Reduct Vol:  | 0           | 0    | 0    | 0           | 0    | 0    | 0          | 0    | 0    | 0          | 0    | 0    |
| Reduced Vol:   | 342         | 608  | 122  | 645         | 1310 | 337  | 212        | 633  | 348  | 309        | 633  | 294  |
| PCE Adj:   | 1.00        | 1.00 | 1.00 | 1.00        | 1.00 | 1.00 | 1.00       | 1.00 | 1.00 | 1.00       | 1.00 | 1.00 |
| MLF Adj:   | 1.00        | 1.00 | 1.00 | 1.00        | 1.00 | 1.00 | 1.00       | 1.00 | 1.00 | 1.00       | 1.00 | 1.00 |
| Final Volume:  | 342         | 608  | 122  | 645         | 1310 | 337  | 212        | 633  | 348  | 309        | 633  | 294  |
| Saturation Flow Module:                                  |             |      |      |             |      |      |            |      |      |            |      |      |
| Sat/Lane:  | 1900        | 1900 | 1900 | 1900        | 1900 | 1900 | 1900       | 1900 | 1900 | 1900       | 1900 | 1900 |
| Adjustment:  | 0.83        | 0.98 | 0.95 | 0.83        | 0.98 | 0.95 | 0.83       | 0.99 | 0.95 | 0.83       | 1.00 | 0.92 |
| Lanes:   | 2.00        | 1.66 | 0.34 | 2.00        | 1.58 | 0.42 | 2.00       | 1.27 | 0.73 | 2.00       | 2.00 | 1.00 |
| Final Sat.:  | 3150        | 3081 | 618  | 3150        | 2942 | 757  | 3150       | 2386 | 1312 | 3150       | 3800 | 1750 |
| Capacity Analysis Module:                                |             |      |      |             |      |      |            |      |      |            |      |      |
| Vol/Sat:   | 0.11        | 0.20 | 0.20 | 0.20        | 0.45 | 0.45 | 0.07       | 0.27 | 0.27 | 0.10       | 0.17 | 0.17 |
| Crit Moves:  | ****        |      |      | ****        |      |      | ****       |      |      | ****       |      |      |
| Green Time:  | 14.0        | 35.0 | 35.0 | 36.3        | 57.3 | 57.3 | 13.4       | 34.1 | 34.1 | 12.6       | 33.4 | 33.4 |
| Volume/Cap:  | 1.01        | 0.73 | 0.73 | 0.73        | 1.01 | 1.01 | 0.65       | 1.01 | 1.01 | 1.01       | 0.65 | 0.65 |
| Delay/Veh:   | 109.6       | 46.1 | 46.1 | 45.7        | 61.2 | 61.2 | 60.9       | 79.4 | 79.4 | 112.8      | 44.6 | 44.6 |
| User DelAdj:   | 1.00        | 1.00 | 1.00 | 1.00        | 1.00 | 1.00 | 1.00       | 1.00 | 1.00 | 1.00       | 1.00 | 1.00 |
| AdjDel/Veh:  | 109.6       | 46.1 | 46.1 | 45.7        | 61.2 | 61.2 | 60.9       | 79.4 | 79.4 | 112.8      | 44.6 | 44.6 |
| LOS by Move:   | F           | D    | D    | D           | E    | E    | E          | E    | E    | F          | D    | D    |
| HCM2k95thQ:  | 23          | 26   | 26   | 24          | 60   | 60   | 9          | 39   | 39   | 18         | 20   | 20   |

Note: Queue reported is the number of cars per lane.

BART

Level Of Service Computation Report  
2000 HCM Operations (Future Volume Alternative)  
AM - Background Conditions

Intersection #3596: JACKSON/McKEE [Study Int 8]

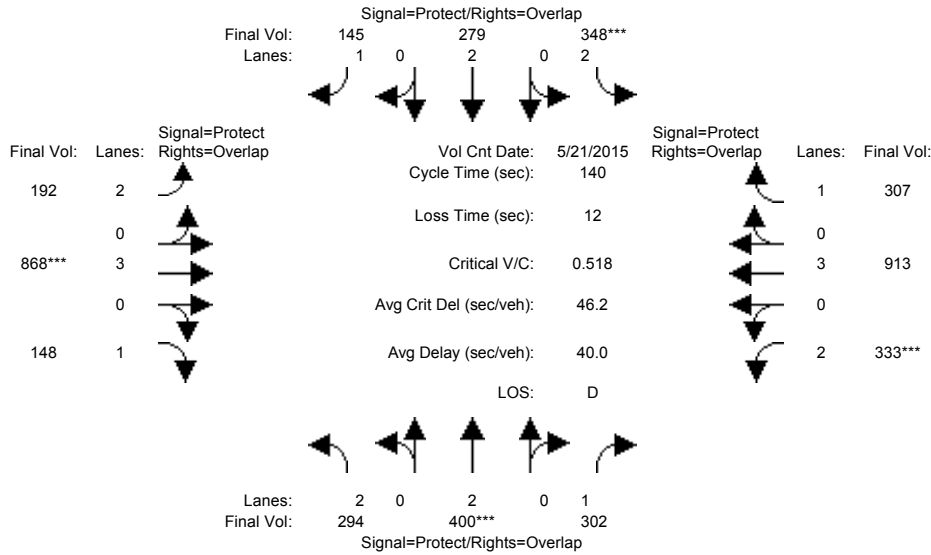

| Approach:  | North Bound |      |      | South Bound |      |      | East Bound |      |      | West Bound |      |      |
|--|-------------|------|------|-------------|------|------|------------|------|------|------------|------|------|
| Movement:  | L           | T    | R    | L           | T    | R    | L          | T    | R    | L          | T    | R    |
| Min. Green:  | 7           | 10   | 10   | 7           | 10   | 10   | 7          | 10   | 10   | 7          | 10   | 10   |
| Y+R:   | 4.0         | 4.0  | 4.0  | 4.0         | 4.0  | 4.0  | 4.0        | 4.0  | 4.0  | 4.0        | 4.0  | 4.0  |
| Volume Module: >> Count Date: 21 May 2015 << 7:30-8:30AM |             |      |      |             |      |      |            |      |      |            |      |      |
| Base Vol:  | 294         | 400  | 302  | 348         | 279  | 145  | 192        | 868  | 148  | 333        | 913  | 307  |
| Growth Adj:  | 1.00        | 1.00 | 1.00 | 1.00        | 1.00 | 1.00 | 1.00       | 1.00 | 1.00 | 1.00       | 1.00 | 1.00 |
| Initial Bse:   | 294         | 400  | 302  | 348         | 279  | 145  | 192        | 868  | 148  | 333        | 913  | 307  |
| Added Vol:   | 0           | 0    | 0    | 0           | 0    | 0    | 0          | 0    | 0    | 0          | 0    | 0    |
| PasserByVol:   | 0           | 0    | 0    | 0           | 0    | 0    | 0          | 0    | 0    | 0          | 0    | 0    |
| Initial Fut:   | 294         | 400  | 302  | 348         | 279  | 145  | 192        | 868  | 148  | 333        | 913  | 307  |
| User Adj:  | 1.00        | 1.00 | 1.00 | 1.00        | 1.00 | 1.00 | 1.00       | 1.00 | 1.00 | 1.00       | 1.00 | 1.00 |
| PHF Adj:   | 1.00        | 1.00 | 1.00 | 1.00        | 1.00 | 1.00 | 1.00       | 1.00 | 1.00 | 1.00       | 1.00 | 1.00 |
| PHF Volume:  | 294         | 400  | 302  | 348         | 279  | 145  | 192        | 868  | 148  | 333        | 913  | 307  |
| Reduct Vol:  | 0           | 0    | 0    | 0           | 0    | 0    | 0          | 0    | 0    | 0          | 0    | 0    |
| Reduced Vol:   | 294         | 400  | 302  | 348         | 279  | 145  | 192        | 868  | 148  | 333        | 913  | 307  |
| PCE Adj:   | 1.00        | 1.00 | 1.00 | 1.00        | 1.00 | 1.00 | 1.00       | 1.00 | 1.00 | 1.00       | 1.00 | 1.00 |
| MLF Adj:   | 1.00        | 1.00 | 1.00 | 1.00        | 1.00 | 1.00 | 1.00       | 1.00 | 1.00 | 1.00       | 1.00 | 1.00 |
| FinalVolume:   | 294         | 400  | 302  | 348         | 279  | 145  | 192        | 868  | 148  | 333        | 913  | 307  |
| Saturation Flow Module:                                  |             |      |      |             |      |      |            |      |      |            |      |      |
| Sat/Lane:  | 1900        | 1900 | 1900 | 1900        | 1900 | 1900 | 1900       | 1900 | 1900 | 1900       | 1900 | 1900 |
| Adjustment:  | 0.83        | 1.00 | 0.92 | 0.83        | 1.00 | 0.92 | 0.83       | 1.00 | 0.92 | 0.83       | 1.00 | 0.92 |
| Lanes:   | 2.00        | 2.00 | 1.00 | 2.00        | 2.00 | 1.00 | 2.00       | 3.00 | 1.00 | 2.00       | 3.00 | 1.00 |
| Final Sat.:  | 3150        | 3800 | 1750 | 3150        | 3800 | 1750 | 3150       | 5700 | 1750 | 3150       | 5700 | 1750 |
| Capacity Analysis Module:                                |             |      |      |             |      |      |            |      |      |            |      |      |
| Vol/Sat:   | 0.09        | 0.11 | 0.17 | 0.11        | 0.07 | 0.08 | 0.06       | 0.15 | 0.08 | 0.11       | 0.16 | 0.18 |
| Crit Moves:  | ****        | **** | **** | ****        | **** | **** | ****       | **** | **** | ****       | **** | **** |
| Green Time:  | 32.6        | 28.4 | 57.0 | 29.8        | 25.7 | 44.9 | 19.2       | 41.1 | 73.8 | 28.6       | 50.5 | 80.3 |
| Volume/Cap:  | 0.40        | 0.52 | 0.42 | 0.52        | 0.40 | 0.26 | 0.44       | 0.52 | 0.16 | 0.52       | 0.44 | 0.31 |
| Delay/Veh:   | 45.8        | 50.3 | 30.1 | 49.4        | 50.8 | 35.5 | 56.2       | 41.5 | 17.2 | 50.3       | 34.2 | 15.6 |
| User DelAdj:   | 1.00        | 1.00 | 1.00 | 1.00        | 1.00 | 1.00 | 1.00       | 1.00 | 1.00 | 1.00       | 1.00 | 1.00 |
| AdjDel/Veh:  | 45.8        | 50.3 | 30.1 | 49.4        | 50.8 | 35.5 | 56.2       | 41.5 | 17.2 | 50.3       | 34.2 | 15.6 |
| LOS by Move:   | D           | D    | C    | D           | D    | D    | E          | D    | B    | D          | C    | B    |
| HCM2k95thQ:  | 12          | 15   | 18   | 15          | 10   | 9    | 9          | 19   | 7    | 15         | 18   | 14   |

Note: Queue reported is the number of cars per lane.

BART

Level Of Service Computation Report  
2000 HCM Operations (Future Volume Alternative)  
PM - Background Conditions

Intersection #3596: JACKSON/McKEE [Study Int 8]

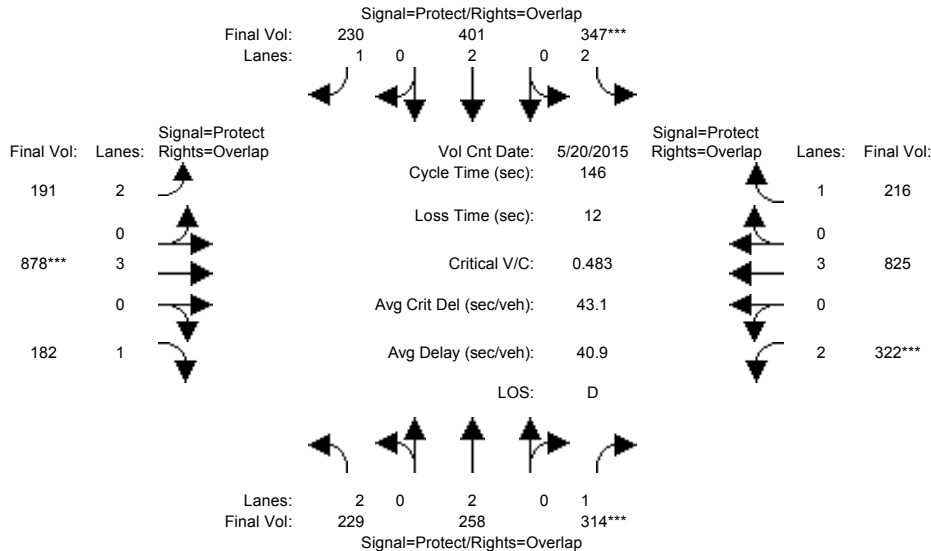

| Approach:  | North Bound |      |      | South Bound |      |      | East Bound |      |      | West Bound |      |      |
|--|-------------|------|------|-------------|------|------|------------|------|------|------------|------|------|
| Movement:  | L           | T    | R    | L           | T    | R    | L          | T    | R    | L          | T    | R    |
| Min. Green:  | 7           | 10   | 10   | 7           | 10   | 10   | 7          | 10   | 10   | 7          | 10   | 10   |
| Y+R:   | 4.0         | 4.0  | 4.0  | 4.0         | 4.0  | 4.0  | 4.0        | 4.0  | 4.0  | 4.0        | 4.0  | 4.0  |
| Volume Module: >> Count Date: 20 May 2015 << 5:00-6:00PM |             |      |      |             |      |      |            |      |      |            |      |      |
| Base Vol:  | 229         | 258  | 314  | 347         | 401  | 230  | 191        | 878  | 182  | 322        | 825  | 216  |
| Growth Adj:  | 1.00        | 1.00 | 1.00 | 1.00        | 1.00 | 1.00 | 1.00       | 1.00 | 1.00 | 1.00       | 1.00 | 1.00 |
| Initial Bse:   | 229         | 258  | 314  | 347         | 401  | 230  | 191        | 878  | 182  | 322        | 825  | 216  |
| Added Vol:   | 0           | 0    | 0    | 0           | 0    | 0    | 0          | 0    | 0    | 0          | 0    | 0    |
| PasserByVol:   | 0           | 0    | 0    | 0           | 0    | 0    | 0          | 0    | 0    | 0          | 0    | 0    |
| Initial Fut:   | 229         | 258  | 314  | 347         | 401  | 230  | 191        | 878  | 182  | 322        | 825  | 216  |
| User Adj:  | 1.00        | 1.00 | 1.00 | 1.00        | 1.00 | 1.00 | 1.00       | 1.00 | 1.00 | 1.00       | 1.00 | 1.00 |
| PHF Adj:   | 1.00        | 1.00 | 1.00 | 1.00        | 1.00 | 1.00 | 1.00       | 1.00 | 1.00 | 1.00       | 1.00 | 1.00 |
| PHF Volume:  | 229         | 258  | 314  | 347         | 401  | 230  | 191        | 878  | 182  | 322        | 825  | 216  |
| Reduct Vol:  | 0           | 0    | 0    | 0           | 0    | 0    | 0          | 0    | 0    | 0          | 0    | 0    |
| Reduced Vol:   | 229         | 258  | 314  | 347         | 401  | 230  | 191        | 878  | 182  | 322        | 825  | 216  |
| PCE Adj:   | 1.00        | 1.00 | 1.00 | 1.00        | 1.00 | 1.00 | 1.00       | 1.00 | 1.00 | 1.00       | 1.00 | 1.00 |
| MLF Adj:   | 1.00        | 1.00 | 1.00 | 1.00        | 1.00 | 1.00 | 1.00       | 1.00 | 1.00 | 1.00       | 1.00 | 1.00 |
| Final Volume:  | 229         | 258  | 314  | 347         | 401  | 230  | 191        | 878  | 182  | 322        | 825  | 216  |
| Saturation Flow Module:                                  |             |      |      |             |      |      |            |      |      |            |      |      |
| Sat/Lane:  | 1900        | 1900 | 1900 | 1900        | 1900 | 1900 | 1900       | 1900 | 1900 | 1900       | 1900 | 1900 |
| Adjustment:  | 0.83        | 1.00 | 0.92 | 0.83        | 1.00 | 0.92 | 0.83       | 1.00 | 0.92 | 0.83       | 1.00 | 0.92 |
| Lanes:   | 2.00        | 2.00 | 1.00 | 2.00        | 2.00 | 1.00 | 2.00       | 3.00 | 1.00 | 2.00       | 3.00 | 1.00 |
| Final Sat.:  | 3150        | 3800 | 1750 | 3150        | 3800 | 1750 | 3150       | 5700 | 1750 | 3150       | 5700 | 1750 |
| Capacity Analysis Module:                                |             |      |      |             |      |      |            |      |      |            |      |      |
| Vol/Sat:   | 0.07        | 0.07 | 0.18 | 0.11        | 0.11 | 0.13 | 0.06       | 0.15 | 0.10 | 0.10       | 0.14 | 0.12 |
| Crit Moves:  | ****        | **** | **** | ****        | **** | **** | ****       | **** | **** | ****       | **** | **** |
| Green Time:  | 23.1        | 23.3 | 54.2 | 33.3        | 33.5 | 56.4 | 22.9       | 46.5 | 69.6 | 30.9       | 54.6 | 87.8 |
| Volume/Cap:  | 0.46        | 0.43 | 0.48 | 0.48        | 0.46 | 0.34 | 0.39       | 0.48 | 0.22 | 0.48       | 0.39 | 0.21 |
| Delay/Veh:   | 56.5        | 55.8 | 35.7 | 49.4        | 48.8 | 32.0 | 55.8       | 40.3 | 22.4 | 51.1       | 33.6 | 13.3 |
| User DelAdj:   | 1.00        | 1.00 | 1.00 | 1.00        | 1.00 | 1.00 | 1.00       | 1.00 | 1.00 | 1.00       | 1.00 | 1.00 |
| AdjDel/Veh:  | 56.5        | 55.8 | 35.7 | 49.4        | 48.8 | 32.0 | 55.8       | 40.3 | 22.4 | 51.1       | 33.6 | 13.3 |
| LOS by Move:   | E           | E    | D    | D           | D    | C    | E          | D    | C    | D          | C    | B    |
| HCM2k95thQ:  | 11          | 11   | 21   | 15          | 14   | 14   | 9          | 19   | 10   | 15         | 16   | 9    |

Note: Queue reported is the number of cars per lane.

BART

Level Of Service Computation Report  
 2000 HCM Operations (Future Volume Alternative)  
 AM - Background Conditions

Intersection #3612: JULIAN/21ST [Study Int 1]

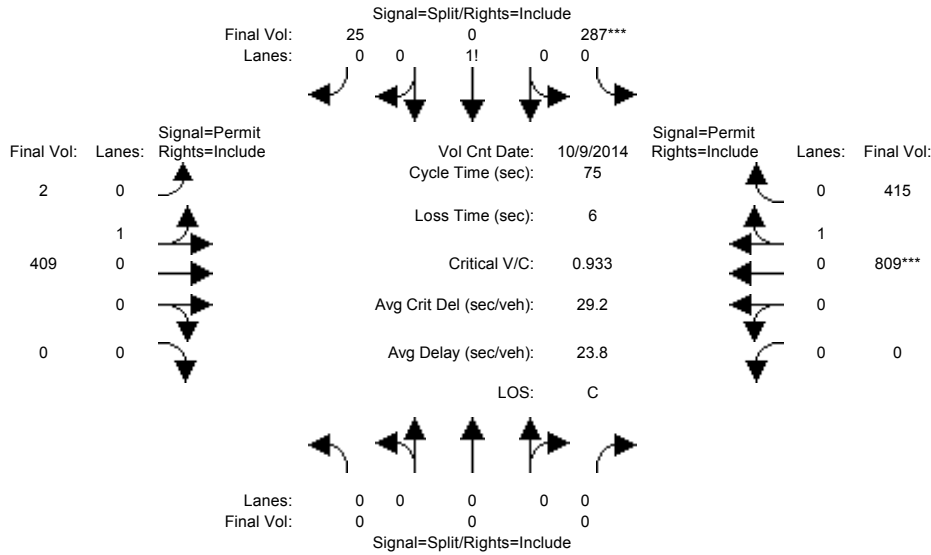

| Approach:                     | North Bound   |      |      | South Bound |      |      | East Bound |      |      | West Bound |      |      |
|-------------------------------|---------------|------|------|-------------|------|------|------------|------|------|------------|------|------|
| Movement:                     | L             | T    | R    | L           | T    | R    | L          | T    | R    | L          | T    | R    |
| Min. Green:                   | 0             | 0    | 0    | 10          | 0    | 10   | 10         | 10   | 0    | 0          | 10   | 10   |
| Y+R:                          | 4.0           | 4.0  | 4.0  | 4.0         | 4.0  | 4.0  | 4.0        | 4.0  | 4.0  | 4.0        | 4.0  | 4.0  |
| -----                         |               |      |      |             |      |      |            |      |      |            |      |      |
| Volume Module: >> Count Date: | 9 Oct 2014 << |      |      |             |      |      |            |      |      |            |      |      |
| Base Vol:                     | 0             | 0    | 0    | 287         | 0    | 25   | 2          | 409  | 0    | 0          | 809  | 415  |
| Growth Adj:                   | 1.00          | 1.00 | 1.00 | 1.00        | 1.00 | 1.00 | 1.00       | 1.00 | 1.00 | 1.00       | 1.00 | 1.00 |
| Initial Bse:                  | 0             | 0    | 0    | 287         | 0    | 25   | 2          | 409  | 0    | 0          | 809  | 415  |
| Added Vol:                    | 0             | 0    | 0    | 0           | 0    | 0    | 0          | 0    | 0    | 0          | 0    | 0    |
| PasserByVol:                  | 0             | 0    | 0    | 0           | 0    | 0    | 0          | 0    | 0    | 0          | 0    | 0    |
| Initial Fut:                  | 0             | 0    | 0    | 287         | 0    | 25   | 2          | 409  | 0    | 0          | 809  | 415  |
| User Adj:                     | 1.00          | 1.00 | 1.00 | 1.00        | 1.00 | 1.00 | 1.00       | 1.00 | 1.00 | 1.00       | 1.00 | 1.00 |
| PHF Adj:                      | 1.00          | 1.00 | 1.00 | 1.00        | 1.00 | 1.00 | 1.00       | 1.00 | 1.00 | 1.00       | 1.00 | 1.00 |
| PHF Volume:                   | 0             | 0    | 0    | 287         | 0    | 25   | 2          | 409  | 0    | 0          | 809  | 415  |
| Reduct Vol:                   | 0             | 0    | 0    | 0           | 0    | 0    | 0          | 0    | 0    | 0          | 0    | 0    |
| Reduced Vol:                  | 0             | 0    | 0    | 287         | 0    | 25   | 2          | 409  | 0    | 0          | 809  | 415  |
| PCE Adj:                      | 1.00          | 1.00 | 1.00 | 1.00        | 1.00 | 1.00 | 1.00       | 1.00 | 1.00 | 1.00       | 1.00 | 1.00 |
| MLF Adj:                      | 1.00          | 1.00 | 1.00 | 1.00        | 1.00 | 1.00 | 1.00       | 1.00 | 1.00 | 1.00       | 1.00 | 1.00 |
| Final Volume:                 | 0             | 0    | 0    | 287         | 0    | 25   | 2          | 409  | 0    | 0          | 809  | 415  |
| -----                         |               |      |      |             |      |      |            |      |      |            |      |      |
| Saturation Flow Module:       |               |      |      |             |      |      |            |      |      |            |      |      |
| Sat/Lane:                     | 1900          | 1900 | 1900 | 1900        | 1900 | 1900 | 1900       | 1900 | 1900 | 1900       | 1900 | 1900 |
| Adjustment:                   | 0.92          | 1.00 | 0.92 | 0.92        | 0.92 | 0.92 | 0.95       | 0.95 | 0.92 | 0.92       | 0.95 | 0.95 |
| Lanes:                        | 0.00          | 0.00 | 0.00 | 0.92        | 0.00 | 0.08 | 0.01       | 0.99 | 0.00 | 0.00       | 0.66 | 0.34 |
| Final Sat.:                   | 0             | 0    | 0    | 1610        | 0    | 140  | 9          | 1791 | 0    | 0          | 1190 | 610  |
| -----                         |               |      |      |             |      |      |            |      |      |            |      |      |
| Capacity Analysis Module:     |               |      |      |             |      |      |            |      |      |            |      |      |
| Vol/Sat:                      | 0.00          | 0.00 | 0.00 | 0.18        | 0.00 | 0.18 | 0.23       | 0.23 | 0.00 | 0.00       | 0.68 | 0.68 |
| Crit Moves:                   | *****         |      |      |             |      |      |            |      |      |            |      |      |
| Green Time:                   | 0.0           | 0.0  | 0.0  | 14.3        | 0.0  | 14.3 | 54.7       | 54.7 | 0.0  | 0.0        | 54.7 | 54.7 |
| Volume/Cap:                   | 0.00          | 0.00 | 0.00 | 0.93        | 0.00 | 0.93 | 0.31       | 0.31 | 0.00 | 0.00       | 0.93 | 0.93 |
| Delay/Veh:                    | 0.0           | 0.0  | 0.0  | 62.1        | 0.0  | 62.1 | 3.7        | 3.7  | 0.0  | 0.0        | 20.8 | 20.8 |
| User DelAdj:                  | 1.00          | 1.00 | 1.00 | 1.00        | 1.00 | 1.00 | 1.00       | 1.00 | 1.00 | 1.00       | 1.00 | 1.00 |
| AdjDel/Veh:                   | 0.0           | 0.0  | 0.0  | 62.1        | 0.0  | 62.1 | 3.7        | 3.7  | 0.0  | 0.0        | 20.8 | 20.8 |
| LOS by Move:                  | A             | A    | A    | E           | A    | E    | A          | A    | A    | A          | C    | C    |
| HCM2k95thQ:                   | 0             | 0    | 0    | 22          | 0    | 22   | 7          | 7    | 0    | 0          | 47   | 47   |

Note: Queue reported is the number of cars per lane.



BART

Level Of Service Computation Report  
 2000 HCM Operations (Future Volume Alternative)  
 PM - Background Conditions

Intersection #3612: JULIAN/21ST [Study Int 1]

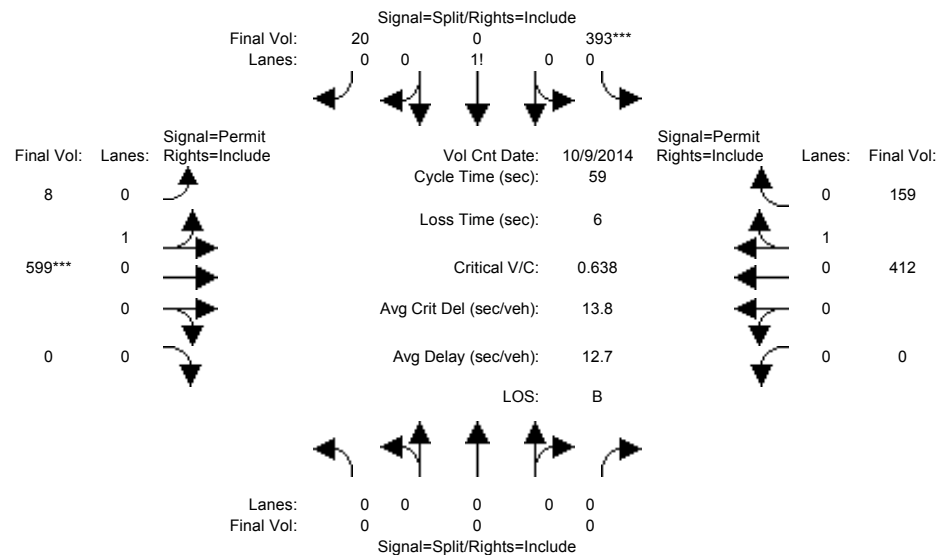

| Approach:                                   | North Bound |      |      | South Bound |      |      | East Bound |      |      | West Bound |      |      |
|---|-------------|------|------|-------------|------|------|------------|------|------|------------|------|------|
| Movement:                                   | L           | T    | R    | L           | T    | R    | L          | T    | R    | L          | T    | R    |
| Min. Green:                                 | 0           | 0    | 0    | 10          | 0    | 10   | 10         | 10   | 0    | 0          | 10   | 10   |
| Y+R:  | 4.0         | 4.0  | 4.0  | 4.0         | 4.0  | 4.0  | 4.0        | 4.0  | 4.0  | 4.0        | 4.0  | 4.0  |
| Volume Module: >> Count Date: 9 Oct 2014 << |             |      |      |             |      |      |            |      |      |            |      |      |
| Base Vol:                                   | 0           | 0    | 0    | 393         | 0    | 20   | 8          | 599  | 0    | 0          | 412  | 159  |
| Growth Adj:                                 | 1.00        | 1.00 | 1.00 | 1.00        | 1.00 | 1.00 | 1.00       | 1.00 | 1.00 | 1.00       | 1.00 | 1.00 |
| Initial Bse:                                | 0           | 0    | 0    | 393         | 0    | 20   | 8          | 599  | 0    | 0          | 412  | 159  |
| Added Vol:                                  | 0           | 0    | 0    | 0           | 0    | 0    | 0          | 0    | 0    | 0          | 0    | 0    |
| PasserByVol:                                | 0           | 0    | 0    | 0           | 0    | 0    | 0          | 0    | 0    | 0          | 0    | 0    |
| Initial Fut:                                | 0           | 0    | 0    | 393         | 0    | 20   | 8          | 599  | 0    | 0          | 412  | 159  |
| User Adj:                                   | 1.00        | 1.00 | 1.00 | 1.00        | 1.00 | 1.00 | 1.00       | 1.00 | 1.00 | 1.00       | 1.00 | 1.00 |
| PHF Adj:                                    | 1.00        | 1.00 | 1.00 | 1.00        | 1.00 | 1.00 | 1.00       | 1.00 | 1.00 | 1.00       | 1.00 | 1.00 |
| PHF Volume:                                 | 0           | 0    | 0    | 393         | 0    | 20   | 8          | 599  | 0    | 0          | 412  | 159  |
| Reduct Vol:                                 | 0           | 0    | 0    | 0           | 0    | 0    | 0          | 0    | 0    | 0          | 0    | 0    |
| Reduced Vol:                                | 0           | 0    | 0    | 393         | 0    | 20   | 8          | 599  | 0    | 0          | 412  | 159  |
| PCE Adj:                                    | 1.00        | 1.00 | 1.00 | 1.00        | 1.00 | 1.00 | 1.00       | 1.00 | 1.00 | 1.00       | 1.00 | 1.00 |
| MLF Adj:                                    | 1.00        | 1.00 | 1.00 | 1.00        | 1.00 | 1.00 | 1.00       | 1.00 | 1.00 | 1.00       | 1.00 | 1.00 |
| Final Volume:                               | 0           | 0    | 0    | 393         | 0    | 20   | 8          | 599  | 0    | 0          | 412  | 159  |
| Saturation Flow Module:                     |             |      |      |             |      |      |            |      |      |            |      |      |
| Sat/Lane:                                   | 1900        | 1900 | 1900 | 1900        | 1900 | 1900 | 1900       | 1900 | 1900 | 1900       | 1900 | 1900 |
| Adjustment:                                 | 0.92        | 1.00 | 0.92 | 0.92        | 0.92 | 0.92 | 0.95       | 0.95 | 0.92 | 0.92       | 0.95 | 0.95 |
| Lanes:                                      | 0.00        | 0.00 | 0.00 | 0.95        | 0.00 | 0.05 | 0.01       | 0.99 | 0.00 | 0.00       | 0.72 | 0.28 |
| Final Sat.:                                 | 0           | 0    | 0    | 1665        | 0    | 85   | 24         | 1776 | 0    | 0          | 1299 | 501  |
| Capacity Analysis Module:                   |             |      |      |             |      |      |            |      |      |            |      |      |
| Vol/Sat:                                    | 0.00        | 0.00 | 0.00 | 0.24        | 0.00 | 0.24 | 0.34       | 0.34 | 0.00 | 0.00       | 0.32 | 0.32 |
| Crit Moves:                                 | ****        |      |      |             |      |      |            |      |      |            |      |      |
| Green Time:                                 | 0.0         | 0.0  | 0.0  | 21.8        | 0.0  | 21.8 | 31.2       | 31.2 | 0.0  | 0.0        | 31.2 | 31.2 |
| Volume/Cap:                                 | 0.00        | 0.00 | 0.00 | 0.64        | 0.00 | 0.64 | 0.64       | 0.64 | 0.00 | 0.00       | 0.60 | 0.60 |
| Delay/Veh:                                  | 0.0         | 0.0  | 0.0  | 17.5        | 0.0  | 17.5 | 11.4       | 11.4 | 0.0  | 0.0        | 10.7 | 10.7 |
| User DelAdj:                                | 1.00        | 1.00 | 1.00 | 1.00        | 1.00 | 1.00 | 1.00       | 1.00 | 1.00 | 1.00       | 1.00 | 1.00 |
| AdjDel/Veh:                                 | 0.0         | 0.0  | 0.0  | 17.5        | 0.0  | 17.5 | 11.4       | 11.4 | 0.0  | 0.0        | 10.7 | 10.7 |
| LOS by Move:                                | A           | A    | A    | B           | A    | B    | B          | B    | A    | A          | B    | B    |
| HCM2k95thQ:                                 | 0           | 0    | 0    | 15          | 0    | 15   | 16         | 16   | 0    | 0          | 14   | 14   |

Note: Queue reported is the number of cars per lane.

BART

Level Of Service Computation Report  
 2000 HCM Operations (Future Volume Alternative)  
 AM - Background Conditions

Intersection #3613: JULIAN/24TH [Study Int 2]

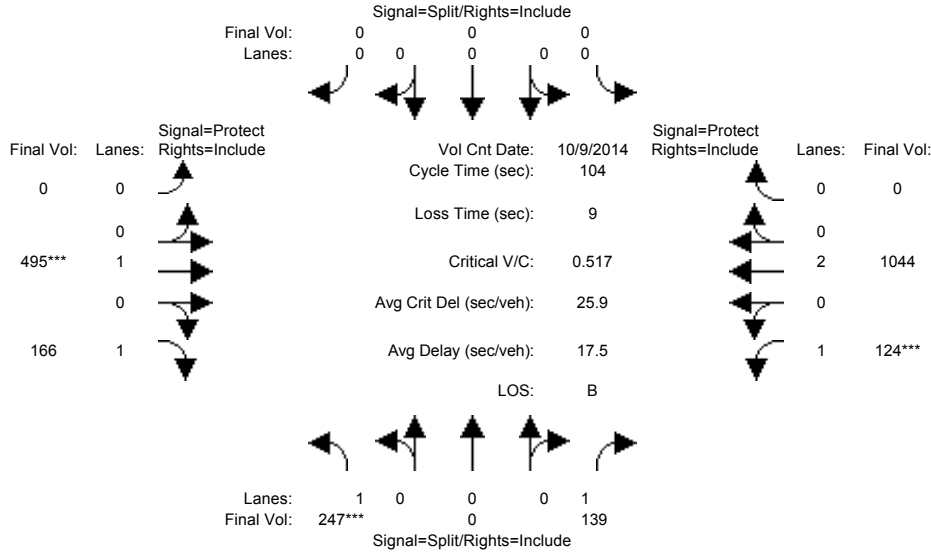

| Approach:                                   | North Bound |      |      | South Bound |      |      | East Bound |      |      | West Bound |      |      |
|---|-------------|------|------|-------------|------|------|------------|------|------|------------|------|------|
| Movement:                                   | L           | T    | R    | L           | T    | R    | L          | T    | R    | L          | T    | R    |
| Min. Green:                                 | 10          | 0    | 10   | 0           | 0    | 0    | 0          | 10   | 10   | 7          | 10   | 0    |
| Y+R:  | 4.0         | 4.0  | 4.0  | 4.0         | 4.0  | 4.0  | 4.0        | 4.0  | 4.0  | 4.0        | 4.0  | 0    |
| Volume Module: >> Count Date: 9 Oct 2014 << |             |      |      |             |      |      |            |      |      |            |      |      |
| Base Vol:                                   | 247         | 0    | 139  | 0           | 0    | 0    | 0          | 495  | 166  | 124        | 1044 | 0    |
| Growth Adj:                                 | 1.00        | 1.00 | 1.00 | 1.00        | 1.00 | 1.00 | 1.00       | 1.00 | 1.00 | 1.00       | 1.00 | 1.00 |
| Initial Bse:                                | 247         | 0    | 139  | 0           | 0    | 0    | 0          | 495  | 166  | 124        | 1044 | 0    |
| Added Vol:                                  | 0           | 0    | 0    | 0           | 0    | 0    | 0          | 0    | 0    | 0          | 0    | 0    |
| PasserByVol:                                | 0           | 0    | 0    | 0           | 0    | 0    | 0          | 0    | 0    | 0          | 0    | 0    |
| Initial Fut:                                | 247         | 0    | 139  | 0           | 0    | 0    | 0          | 495  | 166  | 124        | 1044 | 0    |
| User Adj:                                   | 1.00        | 1.00 | 1.00 | 1.00        | 1.00 | 1.00 | 1.00       | 1.00 | 1.00 | 1.00       | 1.00 | 1.00 |
| PHF Adj:                                    | 1.00        | 1.00 | 1.00 | 1.00        | 1.00 | 1.00 | 1.00       | 1.00 | 1.00 | 1.00       | 1.00 | 1.00 |
| PHF Volume:                                 | 247         | 0    | 139  | 0           | 0    | 0    | 0          | 495  | 166  | 124        | 1044 | 0    |
| Reduct Vol:                                 | 0           | 0    | 0    | 0           | 0    | 0    | 0          | 0    | 0    | 0          | 0    | 0    |
| Reduced Vol:                                | 247         | 0    | 139  | 0           | 0    | 0    | 0          | 495  | 166  | 124        | 1044 | 0    |
| PCE Adj:                                    | 1.00        | 1.00 | 1.00 | 1.00        | 1.00 | 1.00 | 1.00       | 1.00 | 1.00 | 1.00       | 1.00 | 1.00 |
| MLF Adj:                                    | 1.00        | 1.00 | 1.00 | 1.00        | 1.00 | 1.00 | 1.00       | 1.00 | 1.00 | 1.00       | 1.00 | 1.00 |
| Final Volume:                               | 247         | 0    | 139  | 0           | 0    | 0    | 0          | 495  | 166  | 124        | 1044 | 0    |
| Saturation Flow Module:                     |             |      |      |             |      |      |            |      |      |            |      |      |
| Sat/Lane:                                   | 1900        | 1900 | 1900 | 1900        | 1900 | 1900 | 1900       | 1900 | 1900 | 1900       | 1900 | 1900 |
| Adjustment:                                 | 0.92        | 1.00 | 0.92 | 0.92        | 1.00 | 0.92 | 0.92       | 1.00 | 0.92 | 0.92       | 1.00 | 0.92 |
| Lanes:                                      | 1.00        | 0.00 | 1.00 | 0.00        | 0.00 | 0.00 | 0.00       | 1.00 | 1.00 | 1.00       | 2.00 | 0.00 |
| Final Sat.:                                 | 1750        | 0    | 1750 | 0           | 0    | 0    | 0          | 1900 | 1750 | 1750       | 3800 | 0    |
| Capacity Analysis Module:                   |             |      |      |             |      |      |            |      |      |            |      |      |
| Vol/Sat:                                    | 0.14        | 0.00 | 0.08 | 0.00        | 0.00 | 0.00 | 0.00       | 0.26 | 0.09 | 0.07       | 0.27 | 0.00 |
| Crit Moves:                                 | ****        |      |      |             |      |      |            | **** |      | ****       |      |      |
| Green Time:                                 | 28.4        | 0.0  | 28.4 | 0.0         | 0.0  | 0.0  | 0.0        | 52.4 | 52.4 | 14.2       | 66.6 | 0.0  |
| Volume/Cap:                                 | 0.52        | 0.00 | 0.29 | 0.00        | 0.00 | 0.00 | 0.00       | 0.52 | 0.19 | 0.52       | 0.43 | 0.00 |
| Delay/Veh:                                  | 33.0        | 0.0  | 30.2 | 0.0         | 0.0  | 0.0  | 0.0        | 17.8 | 14.3 | 43.7       | 9.4  | 0.0  |
| User DelAdj:                                | 1.00        | 1.00 | 1.00 | 1.00        | 1.00 | 1.00 | 1.00       | 1.00 | 1.00 | 1.00       | 1.00 | 1.00 |
| AdjDel/Veh:                                 | 33.0        | 0.0  | 30.2 | 0.0         | 0.0  | 0.0  | 0.0        | 17.8 | 14.3 | 43.7       | 9.4  | 0.0  |
| LOS by Move:                                | C           | A    | C    | A           | A    | A    | A          | B    | B    | D          | A    | A    |
| HCM2k95thQ:                                 | 14          | 0    | 8    | 0           | 0    | 0    | 0          | 19   | 6    | 9          | 15   | 0    |

Note: Queue reported is the number of cars per lane.

BART

Level Of Service Computation Report  
2000 HCM Operations (Future Volume Alternative)  
PM - Background Conditions

Intersection #3613: JULIAN/24TH [Study Int 2]

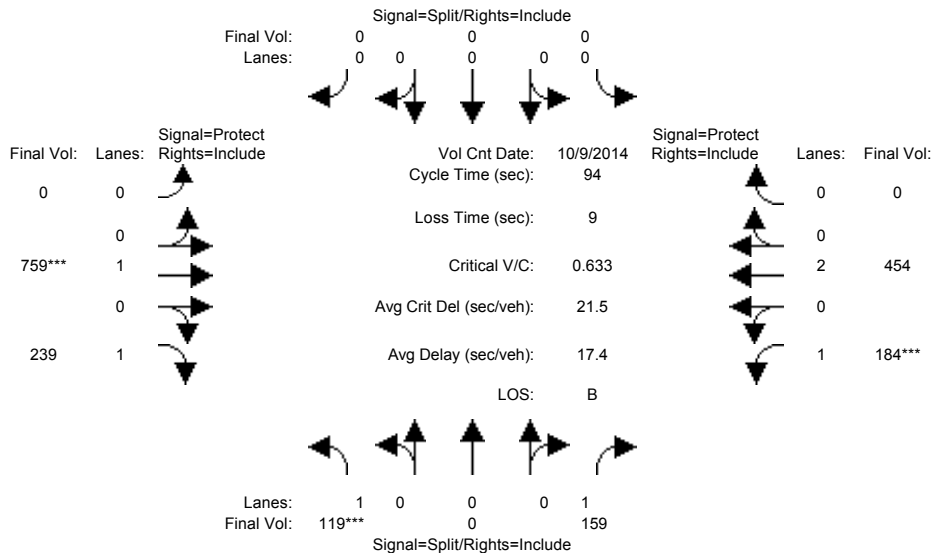

| Approach:                                   | North Bound |      |      | South Bound |      |      | East Bound |      |      | West Bound |      |      |
|---|-------------|------|------|-------------|------|------|------------|------|------|------------|------|------|
| Movement:                                   | L           | T    | R    | L           | T    | R    | L          | T    | R    | L          | T    | R    |
| Min. Green:                                 | 10          | 0    | 10   | 0           | 0    | 0    | 0          | 10   | 10   | 7          | 10   | 0    |
| Y+R:  | 4.0         | 4.0  | 4.0  | 4.0         | 4.0  | 4.0  | 4.0        | 4.0  | 4.0  | 4.0        | 4.0  | 0    |
| Volume Module: >> Count Date: 9 Oct 2014 << |             |      |      |             |      |      |            |      |      |            |      |      |
| Base Vol:                                   | 119         | 0    | 159  | 0           | 0    | 0    | 0          | 759  | 239  | 184        | 454  | 0    |
| Growth Adj:                                 | 1.00        | 1.00 | 1.00 | 1.00        | 1.00 | 1.00 | 1.00       | 1.00 | 1.00 | 1.00       | 1.00 | 1.00 |
| Initial Bse:                                | 119         | 0    | 159  | 0           | 0    | 0    | 0          | 759  | 239  | 184        | 454  | 0    |
| Added Vol:                                  | 0           | 0    | 0    | 0           | 0    | 0    | 0          | 0    | 0    | 0          | 0    | 0    |
| PasserByVol:                                | 0           | 0    | 0    | 0           | 0    | 0    | 0          | 0    | 0    | 0          | 0    | 0    |
| Initial Fut:                                | 119         | 0    | 159  | 0           | 0    | 0    | 0          | 759  | 239  | 184        | 454  | 0    |
| User Adj:                                   | 1.00        | 1.00 | 1.00 | 1.00        | 1.00 | 1.00 | 1.00       | 1.00 | 1.00 | 1.00       | 1.00 | 1.00 |
| PHF Adj:                                    | 1.00        | 1.00 | 1.00 | 1.00        | 1.00 | 1.00 | 1.00       | 1.00 | 1.00 | 1.00       | 1.00 | 1.00 |
| PHF Volume:                                 | 119         | 0    | 159  | 0           | 0    | 0    | 0          | 759  | 239  | 184        | 454  | 0    |
| Reduct Vol:                                 | 0           | 0    | 0    | 0           | 0    | 0    | 0          | 0    | 0    | 0          | 0    | 0    |
| Reduced Vol:                                | 119         | 0    | 159  | 0           | 0    | 0    | 0          | 759  | 239  | 184        | 454  | 0    |
| PCE Adj:                                    | 1.00        | 1.00 | 1.00 | 1.00        | 1.00 | 1.00 | 1.00       | 1.00 | 1.00 | 1.00       | 1.00 | 1.00 |
| MLF Adj:                                    | 1.00        | 1.00 | 1.00 | 1.00        | 1.00 | 1.00 | 1.00       | 1.00 | 1.00 | 1.00       | 1.00 | 1.00 |
| Final Volume:                               | 119         | 0    | 159  | 0           | 0    | 0    | 0          | 759  | 239  | 184        | 454  | 0    |
| Saturation Flow Module:                     |             |      |      |             |      |      |            |      |      |            |      |      |
| Sat/Lane:                                   | 1900        | 1900 | 1900 | 1900        | 1900 | 1900 | 1900       | 1900 | 1900 | 1900       | 1900 | 1900 |
| Adjustment:                                 | 0.92        | 1.00 | 0.92 | 0.92        | 1.00 | 0.92 | 0.92       | 1.00 | 0.92 | 0.92       | 1.00 | 0.92 |
| Lanes:                                      | 1.00        | 0.00 | 1.00 | 0.00        | 0.00 | 0.00 | 0.00       | 1.00 | 1.00 | 1.00       | 2.00 | 0.00 |
| Final Sat.:                                 | 1750        | 0    | 1750 | 0           | 0    | 0    | 0          | 1900 | 1750 | 1750       | 3800 | 0    |
| Capacity Analysis Module:                   |             |      |      |             |      |      |            |      |      |            |      |      |
| Vol/Sat:                                    | 0.07        | 0.00 | 0.09 | 0.00        | 0.00 | 0.00 | 0.00       | 0.40 | 0.14 | 0.11       | 0.12 | 0.00 |
| Crit Moves:                                 | ****        |      |      |             |      |      | ****       |      |      | ****       |      |      |
| Green Time:                                 | 13.0        | 0.0  | 13.0 | 0.0         | 0.0  | 0.0  | 0.0        | 57.0 | 57.0 | 15.0       | 72.0 | 0.0  |
| Volume/Cap:                                 | 0.49        | 0.00 | 0.66 | 0.00        | 0.00 | 0.00 | 0.00       | 0.66 | 0.23 | 0.66       | 0.16 | 0.00 |
| Delay/Veh:                                  | 39.1        | 0.0  | 44.9 | 0.0         | 0.0  | 0.0  | 0.0        | 13.5 | 8.5  | 42.8       | 2.9  | 0.0  |
| User DelAdj:                                | 1.00        | 1.00 | 1.00 | 1.00        | 1.00 | 1.00 | 1.00       | 1.00 | 1.00 | 1.00       | 1.00 | 1.00 |
| AdjDel/Veh:                                 | 39.1        | 0.0  | 44.9 | 0.0         | 0.0  | 0.0  | 0.0        | 13.5 | 8.5  | 42.8       | 2.9  | 0.0  |
| LOS by Move:                                | D           | A    | D    | A           | A    | A    | A          | B    | A    | D          | A    | A    |
| HCM2k95thQ:                                 | 8           | 0    | 11   | 0           | 0    | 0    | 0          | 25   | 7    | 13         | 4    | 0    |

Note: Queue reported is the number of cars per lane.

BART

Level Of Service Computation Report  
 2000 HCM Operations (Future Volume Alternative)  
 AM - Background Conditions

Intersection #3623: KING/MABURY [Study Int 27]

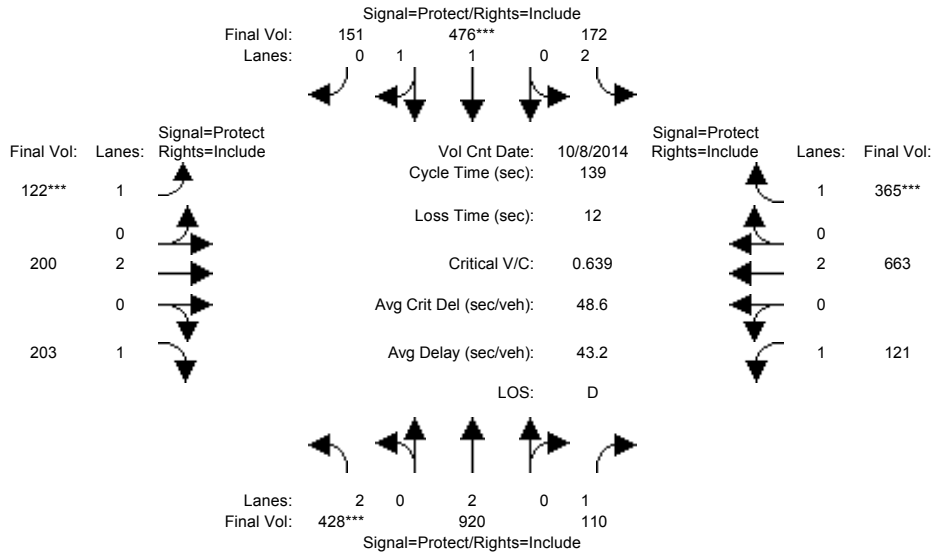

| Approach:                                   | North Bound |      |      | South Bound |      |      | East Bound |      |      | West Bound |      |      |
|---|-------------|------|------|-------------|------|------|------------|------|------|------------|------|------|
| Movement:                                   | L           | T    | R    | L           | T    | R    | L          | T    | R    | L          | T    | R    |
| Min. Green:                                 | 7           | 10   | 10   | 7           | 10   | 10   | 7          | 10   | 10   | 7          | 10   | 10   |
| Y+R:  | 4.0         | 4.0  | 4.0  | 4.0         | 4.0  | 4.0  | 4.0        | 4.0  | 4.0  | 4.0        | 4.0  | 4.0  |
| Volume Module: >> Count Date: 8 Oct 2014 << |             |      |      |             |      |      |            |      |      |            |      |      |
| Base Vol:                                   | 428         | 920  | 110  | 172         | 476  | 151  | 122        | 200  | 203  | 121        | 663  | 365  |
| Growth Adj:                                 | 1.00        | 1.00 | 1.00 | 1.00        | 1.00 | 1.00 | 1.00       | 1.00 | 1.00 | 1.00       | 1.00 | 1.00 |
| Initial Bse:                                | 428         | 920  | 110  | 172         | 476  | 151  | 122        | 200  | 203  | 121        | 663  | 365  |
| Added Vol:                                  | 0           | 0    | 0    | 0           | 0    | 0    | 0          | 0    | 0    | 0          | 0    | 0    |
| PasserByVol:                                | 0           | 0    | 0    | 0           | 0    | 0    | 0          | 0    | 0    | 0          | 0    | 0    |
| Initial Fut:                                | 428         | 920  | 110  | 172         | 476  | 151  | 122        | 200  | 203  | 121        | 663  | 365  |
| User Adj:                                   | 1.00        | 1.00 | 1.00 | 1.00        | 1.00 | 1.00 | 1.00       | 1.00 | 1.00 | 1.00       | 1.00 | 1.00 |
| PHF Adj:                                    | 1.00        | 1.00 | 1.00 | 1.00        | 1.00 | 1.00 | 1.00       | 1.00 | 1.00 | 1.00       | 1.00 | 1.00 |
| PHF Volume:                                 | 428         | 920  | 110  | 172         | 476  | 151  | 122        | 200  | 203  | 121        | 663  | 365  |
| Reduct Vol:                                 | 0           | 0    | 0    | 0           | 0    | 0    | 0          | 0    | 0    | 0          | 0    | 0    |
| Reduced Vol:                                | 428         | 920  | 110  | 172         | 476  | 151  | 122        | 200  | 203  | 121        | 663  | 365  |
| PCE Adj:                                    | 1.00        | 1.00 | 1.00 | 1.00        | 1.00 | 1.00 | 1.00       | 1.00 | 1.00 | 1.00       | 1.00 | 1.00 |
| MLF Adj:                                    | 1.00        | 1.00 | 1.00 | 1.00        | 1.00 | 1.00 | 1.00       | 1.00 | 1.00 | 1.00       | 1.00 | 1.00 |
| Final Volume:                               | 428         | 920  | 110  | 172         | 476  | 151  | 122        | 200  | 203  | 121        | 663  | 365  |
| Saturation Flow Module:                     |             |      |      |             |      |      |            |      |      |            |      |      |
| Sat/Lane:                                   | 1900        | 1900 | 1900 | 1900        | 1900 | 1900 | 1900       | 1900 | 1900 | 1900       | 1900 | 1900 |
| Adjustment:                                 | 0.83        | 1.00 | 0.92 | 0.83        | 0.98 | 0.95 | 0.92       | 1.00 | 0.92 | 0.92       | 1.00 | 0.92 |
| Lanes:                                      | 2.00        | 2.00 | 1.00 | 2.00        | 1.51 | 0.49 | 1.00       | 2.00 | 1.00 | 1.00       | 2.00 | 1.00 |
| Final Sat.:                                 | 3150        | 3800 | 1750 | 3150        | 2808 | 891  | 1750       | 3800 | 1750 | 1750       | 3800 | 1750 |
| Capacity Analysis Module:                   |             |      |      |             |      |      |            |      |      |            |      |      |
| Vol/Sat:                                    | 0.14        | 0.24 | 0.06 | 0.05        | 0.17 | 0.17 | 0.07       | 0.05 | 0.12 | 0.07       | 0.17 | 0.21 |
| Crit Moves:                                 | ****        |      |      | ****        |      |      | ****       |      |      | ****       |      |      |
| Green Time:                                 | 29.6        | 54.2 | 54.2 | 12.2        | 36.9 | 36.9 | 15.2       | 37.9 | 37.9 | 22.6       | 45.4 | 45.4 |
| Volume/Cap:                                 | 0.64        | 0.62 | 0.16 | 0.62        | 0.64 | 0.64 | 0.64       | 0.19 | 0.42 | 0.42       | 0.53 | 0.64 |
| Delay/Veh:                                  | 51.9        | 34.9 | 27.7 | 65.4        | 46.6 | 46.6 | 66.4       | 38.9 | 42.2 | 53.4       | 38.6 | 42.3 |
| User DelAdj:                                | 1.00        | 1.00 | 1.00 | 1.00        | 1.00 | 1.00 | 1.00       | 1.00 | 1.00 | 1.00       | 1.00 | 1.00 |
| AdjDel/Veh:                                 | 51.9        | 34.9 | 27.7 | 65.4        | 46.6 | 46.6 | 66.4       | 38.9 | 42.2 | 53.4       | 38.6 | 42.3 |
| LOS by Move:                                | D           | C    | C    | E           | D    | D    | E          | D    | D    | D          | D    | D    |
| HCM2k95thQ:                                 | 18          | 27   | 6    | 9           | 22   | 22   | 11         | 6    | 14   | 10         | 20   | 25   |

Note: Queue reported is the number of cars per lane.

BART

Level Of Service Computation Report  
2000 HCM Operations (Future Volume Alternative)  
PM - Background Conditions

Intersection #3623: KING/MABURY [Study Int 27]

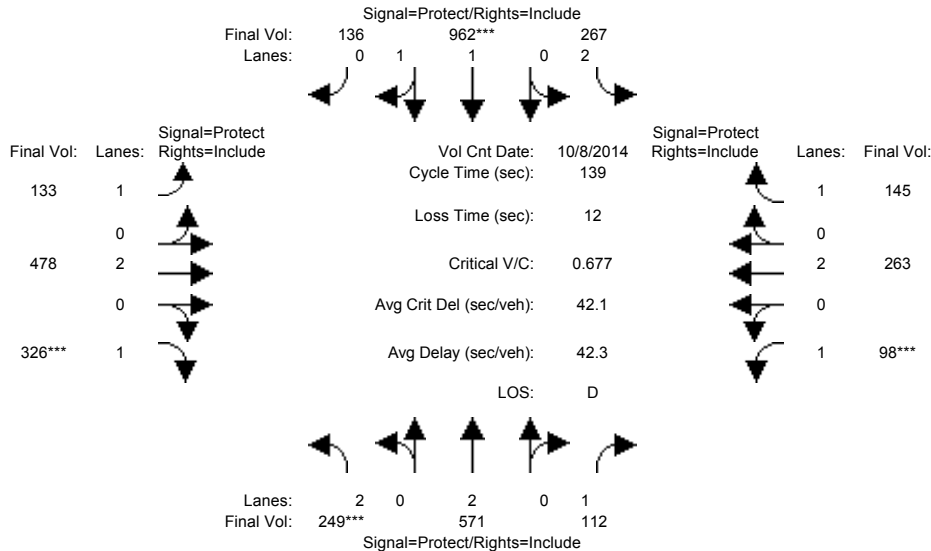

| Approach:                                   | North Bound |      |      | South Bound |      |      | East Bound |      |      | West Bound |      |      |
|---|-------------|------|------|-------------|------|------|------------|------|------|------------|------|------|
| Movement:                                   | L           | T    | R    | L           | T    | R    | L          | T    | R    | L          | T    | R    |
| Min. Green:                                 | 7           | 10   | 10   | 7           | 10   | 10   | 7          | 10   | 10   | 7          | 10   | 10   |
| Y+R:  | 4.0         | 4.0  | 4.0  | 4.0         | 4.0  | 4.0  | 4.0        | 4.0  | 4.0  | 4.0        | 4.0  | 4.0  |
| Volume Module: >> Count Date: 8 Oct 2014 << |             |      |      |             |      |      |            |      |      |            |      |      |
| Base Vol:                                   | 249         | 571  | 112  | 267         | 962  | 136  | 133        | 478  | 326  | 98         | 263  | 145  |
| Growth Adj:                                 | 1.00        | 1.00 | 1.00 | 1.00        | 1.00 | 1.00 | 1.00       | 1.00 | 1.00 | 1.00       | 1.00 | 1.00 |
| Initial Bse:                                | 249         | 571  | 112  | 267         | 962  | 136  | 133        | 478  | 326  | 98         | 263  | 145  |
| Added Vol:                                  | 0           | 0    | 0    | 0           | 0    | 0    | 0          | 0    | 0    | 0          | 0    | 0    |
| PasserByVol:                                | 0           | 0    | 0    | 0           | 0    | 0    | 0          | 0    | 0    | 0          | 0    | 0    |
| Initial Fut:                                | 249         | 571  | 112  | 267         | 962  | 136  | 133        | 478  | 326  | 98         | 263  | 145  |
| User Adj:                                   | 1.00        | 1.00 | 1.00 | 1.00        | 1.00 | 1.00 | 1.00       | 1.00 | 1.00 | 1.00       | 1.00 | 1.00 |
| PHF Adj:                                    | 1.00        | 1.00 | 1.00 | 1.00        | 1.00 | 1.00 | 1.00       | 1.00 | 1.00 | 1.00       | 1.00 | 1.00 |
| PHF Volume:                                 | 249         | 571  | 112  | 267         | 962  | 136  | 133        | 478  | 326  | 98         | 263  | 145  |
| Reduct Vol:                                 | 0           | 0    | 0    | 0           | 0    | 0    | 0          | 0    | 0    | 0          | 0    | 0    |
| Reduced Vol:                                | 249         | 571  | 112  | 267         | 962  | 136  | 133        | 478  | 326  | 98         | 263  | 145  |
| PCE Adj:                                    | 1.00        | 1.00 | 1.00 | 1.00        | 1.00 | 1.00 | 1.00       | 1.00 | 1.00 | 1.00       | 1.00 | 1.00 |
| MLF Adj:                                    | 1.00        | 1.00 | 1.00 | 1.00        | 1.00 | 1.00 | 1.00       | 1.00 | 1.00 | 1.00       | 1.00 | 1.00 |
| FinalVolume:                                | 249         | 571  | 112  | 267         | 962  | 136  | 133        | 478  | 326  | 98         | 263  | 145  |
| Saturation Flow Module:                     |             |      |      |             |      |      |            |      |      |            |      |      |
| Sat/Lane:                                   | 1900        | 1900 | 1900 | 1900        | 1900 | 1900 | 1900       | 1900 | 1900 | 1900       | 1900 | 1900 |
| Adjustment:                                 | 0.83        | 1.00 | 0.92 | 0.83        | 0.98 | 0.95 | 0.92       | 1.00 | 0.92 | 0.92       | 1.00 | 0.92 |
| Lanes:                                      | 2.00        | 2.00 | 1.00 | 2.00        | 1.75 | 0.25 | 1.00       | 2.00 | 1.00 | 1.00       | 2.00 | 1.00 |
| Final Sat.:                                 | 3150        | 3800 | 1750 | 3150        | 3241 | 458  | 1750       | 3800 | 1750 | 1750       | 3800 | 1750 |
| Capacity Analysis Module:                   |             |      |      |             |      |      |            |      |      |            |      |      |
| Vol/Sat:                                    | 0.08        | 0.15 | 0.06 | 0.08        | 0.30 | 0.30 | 0.08       | 0.13 | 0.19 | 0.06       | 0.07 | 0.08 |
| Crit Moves:                                 | ****        |      |      | ****        |      |      | ****       |      | **** | ****       |      |      |
| Green Time:                                 | 16.2        | 49.4 | 49.4 | 27.8        | 61.0 | 61.0 | 23.8       | 38.3 | 38.3 | 11.5       | 26.0 | 26.0 |
| Volume/Cap:                                 | 0.68        | 0.42 | 0.18 | 0.42        | 0.68 | 0.68 | 0.44       | 0.46 | 0.68 | 0.68       | 0.37 | 0.44 |
| Delay/Veh:                                  | 63.8        | 34.2 | 31.0 | 49.0        | 32.3 | 32.3 | 52.7       | 42.1 | 48.7 | 74.0       | 49.7 | 51.1 |
| User DelAdj:                                | 1.00        | 1.00 | 1.00 | 1.00        | 1.00 | 1.00 | 1.00       | 1.00 | 1.00 | 1.00       | 1.00 | 1.00 |
| AdjDel/Veh:                                 | 63.8        | 34.2 | 31.0 | 49.0        | 32.3 | 32.3 | 52.7       | 42.1 | 48.7 | 74.0       | 49.7 | 51.1 |
| LOS by Move:                                | E           | C    | C    | D           | C    | C    | D          | D    | D    | E          | D    | D    |
| HCM2k95thQ:                                 | 12          | 17   | 7    | 11          | 32   | 32   | 10         | 15   | 24   | 9          | 9    | 11   |

Note: Queue reported is the number of cars per lane.

BART

Level Of Service Computation Report  
 2000 HCM Operations (Future Volume Alternative)  
 AM - Background Conditions

Intersection #3625: KING/McKEE [Study Int 7]

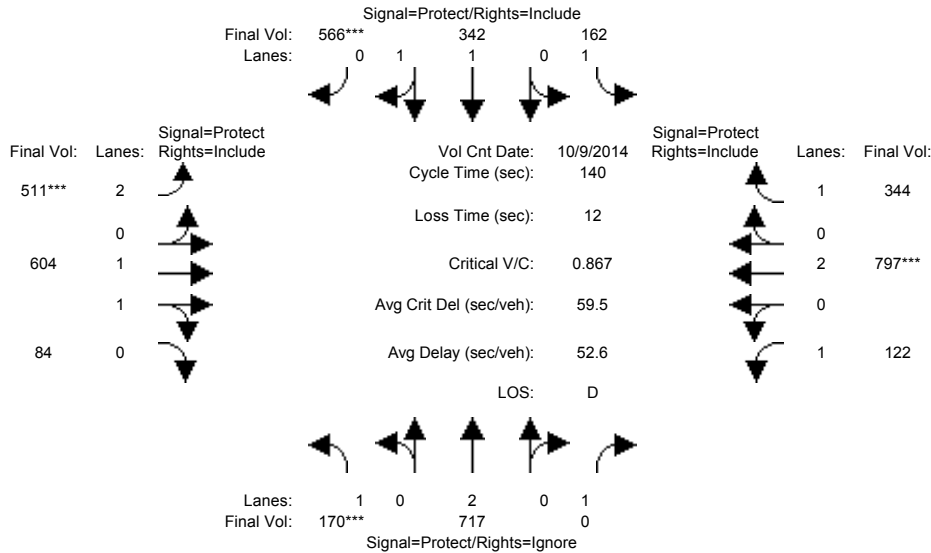

| Approach:                                   | North Bound |      |      | South Bound |      |      | East Bound |      |      | West Bound |      |      |
|---|-------------|------|------|-------------|------|------|------------|------|------|------------|------|------|
| Movement:                                   | L           | T    | R    | L           | T    | R    | L          | T    | R    | L          | T    | R    |
| Min. Green:                                 | 7           | 10   | 10   | 7           | 10   | 10   | 7          | 10   | 10   | 7          | 10   | 10   |
| Y+R:  | 4.0         | 4.0  | 4.0  | 4.0         | 4.0  | 4.0  | 4.0        | 4.0  | 4.0  | 4.0        | 4.0  | 4.0  |
| Volume Module: >> Count Date: 9 Oct 2014 << |             |      |      |             |      |      |            |      |      |            |      |      |
| Base Vol:                                   | 170         | 717  | 164  | 162         | 342  | 566  | 511        | 604  | 84   | 122        | 797  | 344  |
| Growth Adj:                                 | 1.00        | 1.00 | 1.00 | 1.00        | 1.00 | 1.00 | 1.00       | 1.00 | 1.00 | 1.00       | 1.00 | 1.00 |
| Initial Bse:                                | 170         | 717  | 164  | 162         | 342  | 566  | 511        | 604  | 84   | 122        | 797  | 344  |
| Added Vol:                                  | 0           | 0    | 0    | 0           | 0    | 0    | 0          | 0    | 0    | 0          | 0    | 0    |
| PasserByVol:                                | 0           | 0    | 0    | 0           | 0    | 0    | 0          | 0    | 0    | 0          | 0    | 0    |
| Initial Fut:                                | 170         | 717  | 164  | 162         | 342  | 566  | 511        | 604  | 84   | 122        | 797  | 344  |
| User Adj:                                   | 1.00        | 1.00 | 0.00 | 1.00        | 1.00 | 1.00 | 1.00       | 1.00 | 1.00 | 1.00       | 1.00 | 1.00 |
| PHF Adj:                                    | 1.00        | 1.00 | 0.00 | 1.00        | 1.00 | 1.00 | 1.00       | 1.00 | 1.00 | 1.00       | 1.00 | 1.00 |
| PHF Volume:                                 | 170         | 717  | 0    | 162         | 342  | 566  | 511        | 604  | 84   | 122        | 797  | 344  |
| Reduct Vol:                                 | 0           | 0    | 0    | 0           | 0    | 0    | 0          | 0    | 0    | 0          | 0    | 0    |
| Reduced Vol:                                | 170         | 717  | 0    | 162         | 342  | 566  | 511        | 604  | 84   | 122        | 797  | 344  |
| PCE Adj:                                    | 1.00        | 1.00 | 0.00 | 1.00        | 1.00 | 1.00 | 1.00       | 1.00 | 1.00 | 1.00       | 1.00 | 1.00 |
| MLF Adj:                                    | 1.00        | 1.00 | 0.00 | 1.00        | 1.00 | 1.00 | 1.00       | 1.00 | 1.00 | 1.00       | 1.00 | 1.00 |
| Final Volume:                               | 170         | 717  | 0    | 162         | 342  | 566  | 511        | 604  | 84   | 122        | 797  | 344  |
| Saturation Flow Module:                     |             |      |      |             |      |      |            |      |      |            |      |      |
| Sat/Lane:                                   | 1900        | 1900 | 1900 | 1900        | 1900 | 1900 | 1900       | 1900 | 1900 | 1900       | 1900 | 1900 |
| Adjustment:                                 | 0.92        | 1.00 | 0.92 | 0.92        | 1.00 | 0.92 | 0.83       | 0.98 | 0.95 | 0.92       | 1.00 | 0.92 |
| Lanes:                                      | 1.00        | 2.00 | 1.00 | 1.00        | 1.00 | 1.00 | 2.00       | 1.75 | 0.25 | 1.00       | 2.00 | 1.00 |
| Final Sat.:                                 | 1750        | 3800 | 1750 | 1750        | 1900 | 1750 | 3150       | 3248 | 452  | 1750       | 3800 | 1750 |
| Capacity Analysis Module:                   |             |      |      |             |      |      |            |      |      |            |      |      |
| Vol/Sat:                                    | 0.10        | 0.19 | 0.00 | 0.09        | 0.18 | 0.32 | 0.16       | 0.19 | 0.19 | 0.07       | 0.21 | 0.20 |
| Crit Moves:                                 | ****        |      |      | ****        | **** | **** | ****       | **** | **** | ****       | **** | **** |
| Green Time:                                 | 15.7        | 45.6 | 0.0  | 22.4        | 52.2 | 52.2 | 26.2       | 43.7 | 43.7 | 16.4       | 33.9 | 33.9 |
| Volume/Cap:                                 | 0.87        | 0.58 | 0.00 | 0.58        | 0.48 | 0.87 | 0.87       | 0.60 | 0.60 | 0.60       | 0.87 | 0.81 |
| Delay/Veh:                                  | 92.1        | 39.9 | 0.0  | 57.5        | 33.7 | 48.4 | 68.1       | 41.5 | 41.5 | 63.4       | 59.6 | 61.4 |
| User DelAdj:                                | 1.00        | 1.00 | 1.00 | 1.00        | 1.00 | 1.00 | 1.00       | 1.00 | 1.00 | 1.00       | 1.00 | 1.00 |
| AdjDel/Veh:                                 | 92.1        | 39.9 | 0.0  | 57.5        | 33.7 | 48.4 | 68.1       | 41.5 | 41.5 | 63.4       | 59.6 | 61.4 |
| LOS by Move:                                | F           | D    | A    | E           | C    | D    | E          | D    | D    | E          | E    | E    |
| HCM2k95thQ:                                 | 16          | 22   | 0    | 13          | 20   | 42   | 24         | 22   | 22   | 11         | 30   | 28   |

Note: Queue reported is the number of cars per lane.

BART

Level Of Service Computation Report  
 2000 HCM Operations (Future Volume Alternative)  
 PM - Background Conditions

Intersection #3625: KING/McKEE [Study Int 7]

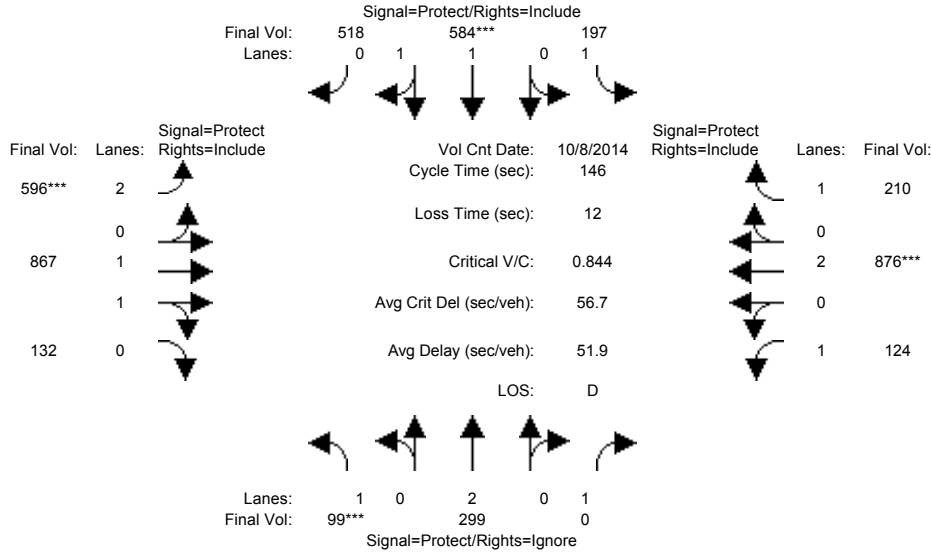

| Approach:                                   | North Bound |      |      | South Bound |      |      | East Bound |      |      | West Bound |      |      |
|---|-------------|------|------|-------------|------|------|------------|------|------|------------|------|------|
| Movement:                                   | L           | T    | R    | L           | T    | R    | L          | T    | R    | L          | T    | R    |
| Min. Green:                                 | 7           | 10   | 10   | 7           | 10   | 10   | 7          | 10   | 10   | 7          | 10   | 10   |
| Y+R:  | 4.0         | 4.0  | 4.0  | 4.0         | 4.0  | 4.0  | 4.0        | 4.0  | 4.0  | 4.0        | 4.0  | 4.0  |
| Volume Module: >> Count Date: 8 Oct 2014 << |             |      |      |             |      |      |            |      |      |            |      |      |
| Base Vol:                                   | 99          | 299  | 104  | 197         | 584  | 518  | 596        | 867  | 132  | 124        | 876  | 210  |
| Growth Adj:                                 | 1.00        | 1.00 | 1.00 | 1.00        | 1.00 | 1.00 | 1.00       | 1.00 | 1.00 | 1.00       | 1.00 | 1.00 |
| Initial Bse:                                | 99          | 299  | 104  | 197         | 584  | 518  | 596        | 867  | 132  | 124        | 876  | 210  |
| Added Vol:                                  | 0           | 0    | 0    | 0           | 0    | 0    | 0          | 0    | 0    | 0          | 0    | 0    |
| PasserByVol:                                | 0           | 0    | 0    | 0           | 0    | 0    | 0          | 0    | 0    | 0          | 0    | 0    |
| Initial Fut:                                | 99          | 299  | 104  | 197         | 584  | 518  | 596        | 867  | 132  | 124        | 876  | 210  |
| User Adj:                                   | 1.00        | 1.00 | 0.00 | 1.00        | 1.00 | 1.00 | 1.00       | 1.00 | 1.00 | 1.00       | 1.00 | 1.00 |
| PHF Adj:                                    | 1.00        | 1.00 | 0.00 | 1.00        | 1.00 | 1.00 | 1.00       | 1.00 | 1.00 | 1.00       | 1.00 | 1.00 |
| PHF Volume:                                 | 99          | 299  | 0    | 197         | 584  | 518  | 596        | 867  | 132  | 124        | 876  | 210  |
| Reduct Vol:                                 | 0           | 0    | 0    | 0           | 0    | 0    | 0          | 0    | 0    | 0          | 0    | 0    |
| Reduced Vol:                                | 99          | 299  | 0    | 197         | 584  | 518  | 596        | 867  | 132  | 124        | 876  | 210  |
| PCE Adj:                                    | 1.00        | 1.00 | 0.00 | 1.00        | 1.00 | 1.00 | 1.00       | 1.00 | 1.00 | 1.00       | 1.00 | 1.00 |
| MLF Adj:                                    | 1.00        | 1.00 | 0.00 | 1.00        | 1.00 | 1.00 | 1.00       | 1.00 | 1.00 | 1.00       | 1.00 | 1.00 |
| Final Volume:                               | 99          | 299  | 0    | 197         | 584  | 518  | 596        | 867  | 132  | 124        | 876  | 210  |
| Saturation Flow Module:                     |             |      |      |             |      |      |            |      |      |            |      |      |
| Sat/Lane:                                   | 1900        | 1900 | 1900 | 1900        | 1900 | 1900 | 1900       | 1900 | 1900 | 1900       | 1900 | 1900 |
| Adjustment:                                 | 0.92        | 1.00 | 0.92 | 0.92        | 1.00 | 0.95 | 0.83       | 0.98 | 0.95 | 0.92       | 1.00 | 0.92 |
| Lanes:                                      | 1.00        | 2.00 | 1.00 | 1.00        | 1.03 | 0.97 | 2.00       | 1.73 | 0.27 | 1.00       | 2.00 | 1.00 |
| Final Sat.:                                 | 1750        | 3800 | 1750 | 1750        | 1960 | 1738 | 3150       | 3211 | 489  | 1750       | 3800 | 1750 |
| Capacity Analysis Module:                   |             |      |      |             |      |      |            |      |      |            |      |      |
| Vol/Sat:                                    | 0.06        | 0.08 | 0.00 | 0.11        | 0.30 | 0.30 | 0.19       | 0.27 | 0.27 | 0.07       | 0.23 | 0.12 |
| Crit Moves:                                 | ****        |      |      | ****        |      |      | ****       |      |      | ****       |      |      |
| Green Time:                                 | 9.8         | 25.2 | 0.0  | 36.1        | 51.6 | 51.6 | 32.7       | 57.5 | 57.5 | 15.1       | 39.9 | 39.9 |
| Volume/Cap:                                 | 0.84        | 0.46 | 0.00 | 0.46        | 0.84 | 0.84 | 0.84       | 0.69 | 0.69 | 0.69       | 0.84 | 0.44 |
| Delay/Veh:                                  | 107.0       | 54.7 | 0.0  | 47.4        | 48.7 | 48.7 | 63.3       | 38.1 | 38.1 | 73.6       | 56.5 | 44.5 |
| User DelAdj:                                | 1.00        | 1.00 | 1.00 | 1.00        | 1.00 | 1.00 | 1.00       | 1.00 | 1.00 | 1.00       | 1.00 | 1.00 |
| AdjDel/Veh:                                 | 107.0       | 54.7 | 0.0  | 47.4        | 48.7 | 48.7 | 63.3       | 38.1 | 38.1 | 73.6       | 56.5 | 44.5 |
| LOS by Move:                                | F           | D    | A    | D           | D    | D    | E          | D    | D    | E          | E    | D    |
| HCM2k95thQ:                                 | 10          | 11   | 0    | 15          | 40   | 40   | 28         | 32   | 32   | 12         | 33   | 15   |

Note: Queue reported is the number of cars per lane.

BART

Level Of Service Computation Report  
2000 HCM Operations (Future Volume Alternative)  
AM - Background Conditions

Intersection #3627: KING/SAN ANTONIO [Study Int 22]

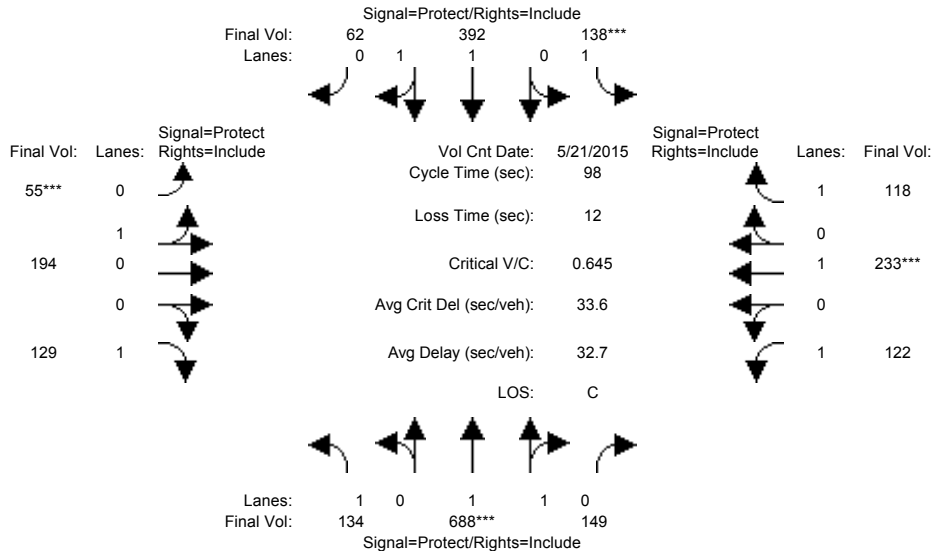

| Approach:  | North Bound |      |      | South Bound |      |      | East Bound |      |      | West Bound |      |      |
|--|-------------|------|------|-------------|------|------|------------|------|------|------------|------|------|
| Movement:  | L           | T    | R    | L           | T    | R    | L          | T    | R    | L          | T    | R    |
| Min. Green:  | 7           | 10   | 10   | 7           | 10   | 10   | 10         | 10   | 10   | 10         | 10   | 10   |
| Y+R:   | 4.0         | 4.0  | 4.0  | 4.0         | 4.0  | 4.0  | 4.0        | 4.0  | 4.0  | 4.0        | 4.0  | 4.0  |
| Volume Module: >> Count Date: 21 May 2015 << 7:30-8:30AM |             |      |      |             |      |      |            |      |      |            |      |      |
| Base Vol:  | 134         | 688  | 149  | 138         | 392  | 62   | 55         | 194  | 129  | 122        | 233  | 118  |
| Growth Adj:  | 1.00        | 1.00 | 1.00 | 1.00        | 1.00 | 1.00 | 1.00       | 1.00 | 1.00 | 1.00       | 1.00 | 1.00 |
| Initial Bse:   | 134         | 688  | 149  | 138         | 392  | 62   | 55         | 194  | 129  | 122        | 233  | 118  |
| Added Vol:   | 0           | 0    | 0    | 0           | 0    | 0    | 0          | 0    | 0    | 0          | 0    | 0    |
| PasserByVol:   | 0           | 0    | 0    | 0           | 0    | 0    | 0          | 0    | 0    | 0          | 0    | 0    |
| Initial Fut:   | 134         | 688  | 149  | 138         | 392  | 62   | 55         | 194  | 129  | 122        | 233  | 118  |
| User Adj:  | 1.00        | 1.00 | 1.00 | 1.00        | 1.00 | 1.00 | 1.00       | 1.00 | 1.00 | 1.00       | 1.00 | 1.00 |
| PHF Adj:   | 1.00        | 1.00 | 1.00 | 1.00        | 1.00 | 1.00 | 1.00       | 1.00 | 1.00 | 1.00       | 1.00 | 1.00 |
| PHF Volume:  | 134         | 688  | 149  | 138         | 392  | 62   | 55         | 194  | 129  | 122        | 233  | 118  |
| Reduct Vol:  | 0           | 0    | 0    | 0           | 0    | 0    | 0          | 0    | 0    | 0          | 0    | 0    |
| Reduced Vol:   | 134         | 688  | 149  | 138         | 392  | 62   | 55         | 194  | 129  | 122        | 233  | 118  |
| PCE Adj:   | 1.00        | 1.00 | 1.00 | 1.00        | 1.00 | 1.00 | 1.00       | 1.00 | 1.00 | 1.00       | 1.00 | 1.00 |
| MLF Adj:   | 1.00        | 1.00 | 1.00 | 1.00        | 1.00 | 1.00 | 1.00       | 1.00 | 1.00 | 1.00       | 1.00 | 1.00 |
| Final Volume:  | 134         | 688  | 149  | 138         | 392  | 62   | 55         | 194  | 129  | 122        | 233  | 118  |
| Saturation Flow Module:                                  |             |      |      |             |      |      |            |      |      |            |      |      |
| Sat/Lane:  | 1900        | 1900 | 1900 | 1900        | 1900 | 1900 | 1900       | 1900 | 1900 | 1900       | 1900 | 1900 |
| Adjustment:  | 0.92        | 0.98 | 0.95 | 0.92        | 0.98 | 0.95 | 0.95       | 0.95 | 0.92 | 0.92       | 1.00 | 0.92 |
| Lanes:   | 1.00        | 1.63 | 0.37 | 1.00        | 1.72 | 0.28 | 0.22       | 0.78 | 1.00 | 1.00       | 1.00 | 1.00 |
| Final Sat.:  | 1750        | 3041 | 659  | 1750        | 3194 | 505  | 398        | 1402 | 1750 | 1750       | 1900 | 1750 |
| Capacity Analysis Module:                                |             |      |      |             |      |      |            |      |      |            |      |      |
| Vol/Sat:   | 0.08        | 0.23 | 0.23 | 0.08        | 0.12 | 0.12 | 0.14       | 0.14 | 0.07 | 0.07       | 0.12 | 0.07 |
| Crit Moves:  | ****        | **** | **** | ****        | **** | **** | ****       | **** | **** | ****       | **** | **** |
| Green Time:  | 17.8        | 34.4 | 34.4 | 12.0        | 28.5 | 28.5 | 21.0       | 22.8 | 22.8 | 16.8       | 18.6 | 18.6 |
| Volume/Cap:  | 0.42        | 0.65 | 0.65 | 0.65        | 0.42 | 0.42 | 0.65       | 0.59 | 0.32 | 0.41       | 0.65 | 0.35 |
| Delay/Veh:   | 36.4        | 27.8 | 27.8 | 47.6        | 28.3 | 28.3 | 38.8       | 35.8 | 31.6 | 37.0       | 40.6 | 35.1 |
| User DelAdj:   | 1.00        | 1.00 | 1.00 | 1.00        | 1.00 | 1.00 | 1.00       | 1.00 | 1.00 | 1.00       | 1.00 | 1.00 |
| AdjDel/Veh:  | 36.4        | 27.8 | 27.8 | 47.6        | 28.3 | 28.3 | 38.8       | 35.8 | 31.6 | 37.0       | 40.6 | 35.1 |
| LOS by Move:   | D           | C    | C    | D           | C    | C    | D          | D    | C    | D          | D    | D    |
| HCM2k95thQ:  | 8           | 20   | 20   | 9           | 11   | 11   | 15         | 15   | 7    | 8          | 14   | 7    |

Note: Queue reported is the number of cars per lane.



BART

Level Of Service Computation Report  
2000 HCM Operations (Future Volume Alternative)  
PM - Background Conditions

Intersection #3627: KING/SAN ANTONIO [Study Int 22]

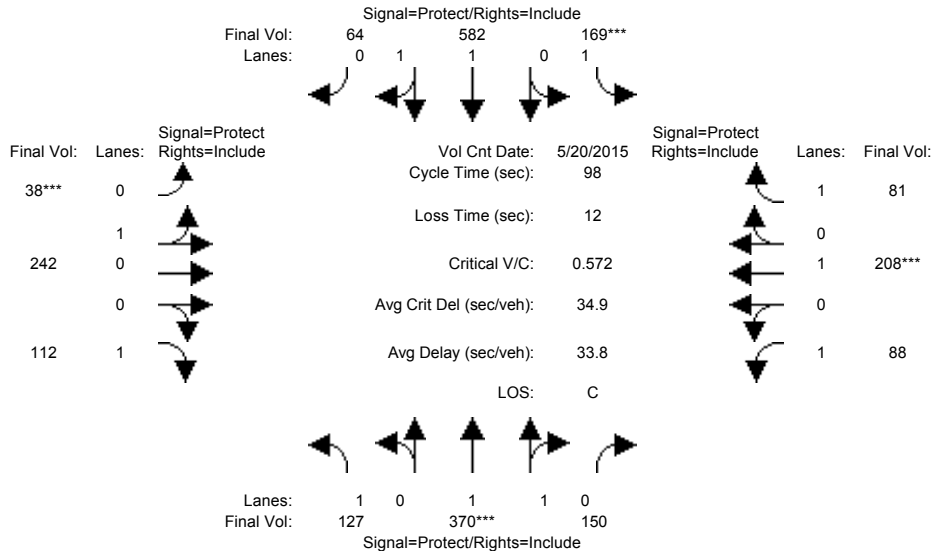

| Approach:  | North Bound |      |      | South Bound |      |      | East Bound |      |      | West Bound |      |      |
|--|-------------|------|------|-------------|------|------|------------|------|------|------------|------|------|
| Movement:  | L           | T    | R    | L           | T    | R    | L          | T    | R    | L          | T    | R    |
| Min. Green:  | 7           | 10   | 10   | 7           | 10   | 10   | 10         | 10   | 10   | 10         | 10   | 10   |
| Y+R:   | 4.0         | 4.0  | 4.0  | 4.0         | 4.0  | 4.0  | 4.0        | 4.0  | 4.0  | 4.0        | 4.0  | 4.0  |
| Volume Module: >> Count Date: 20 May 2015 << 4:45-5:45PM |             |      |      |             |      |      |            |      |      |            |      |      |
| Base Vol:  | 127         | 370  | 150  | 169         | 582  | 64   | 38         | 242  | 112  | 88         | 208  | 81   |
| Growth Adj:  | 1.00        | 1.00 | 1.00 | 1.00        | 1.00 | 1.00 | 1.00       | 1.00 | 1.00 | 1.00       | 1.00 | 1.00 |
| Initial Bse:   | 127         | 370  | 150  | 169         | 582  | 64   | 38         | 242  | 112  | 88         | 208  | 81   |
| Added Vol:   | 0           | 0    | 0    | 0           | 0    | 0    | 0          | 0    | 0    | 0          | 0    | 0    |
| PasserByVol:   | 0           | 0    | 0    | 0           | 0    | 0    | 0          | 0    | 0    | 0          | 0    | 0    |
| Initial Fut:   | 127         | 370  | 150  | 169         | 582  | 64   | 38         | 242  | 112  | 88         | 208  | 81   |
| User Adj:  | 1.00        | 1.00 | 1.00 | 1.00        | 1.00 | 1.00 | 1.00       | 1.00 | 1.00 | 1.00       | 1.00 | 1.00 |
| PHF Adj:   | 1.00        | 1.00 | 1.00 | 1.00        | 1.00 | 1.00 | 1.00       | 1.00 | 1.00 | 1.00       | 1.00 | 1.00 |
| PHF Volume:  | 127         | 370  | 150  | 169         | 582  | 64   | 38         | 242  | 112  | 88         | 208  | 81   |
| Reduct Vol:  | 0           | 0    | 0    | 0           | 0    | 0    | 0          | 0    | 0    | 0          | 0    | 0    |
| Reduced Vol:   | 127         | 370  | 150  | 169         | 582  | 64   | 38         | 242  | 112  | 88         | 208  | 81   |
| PCE Adj:   | 1.00        | 1.00 | 1.00 | 1.00        | 1.00 | 1.00 | 1.00       | 1.00 | 1.00 | 1.00       | 1.00 | 1.00 |
| MLF Adj:   | 1.00        | 1.00 | 1.00 | 1.00        | 1.00 | 1.00 | 1.00       | 1.00 | 1.00 | 1.00       | 1.00 | 1.00 |
| FinalVolume:   | 127         | 370  | 150  | 169         | 582  | 64   | 38         | 242  | 112  | 88         | 208  | 81   |
| Saturation Flow Module:                                  |             |      |      |             |      |      |            |      |      |            |      |      |
| Sat/Lane:  | 1900        | 1900 | 1900 | 1900        | 1900 | 1900 | 1900       | 1900 | 1900 | 1900       | 1900 | 1900 |
| Adjustment:  | 0.92        | 0.98 | 0.95 | 0.92        | 0.98 | 0.95 | 0.95       | 0.95 | 0.92 | 0.92       | 1.00 | 0.92 |
| Lanes:   | 1.00        | 1.41 | 0.59 | 1.00        | 1.80 | 0.20 | 0.14       | 0.86 | 1.00 | 1.00       | 1.00 | 1.00 |
| Final Sat.:  | 1750        | 2632 | 1067 | 1750        | 3333 | 367  | 244        | 1556 | 1750 | 1750       | 1900 | 1750 |
| Capacity Analysis Module:                                |             |      |      |             |      |      |            |      |      |            |      |      |
| Vol/Sat:   | 0.07        | 0.14 | 0.14 | 0.10        | 0.17 | 0.17 | 0.16       | 0.16 | 0.06 | 0.05       | 0.11 | 0.05 |
| Crit Moves:  | ****        | **** | **** | ****        | **** | **** | ****       | **** | **** | ****       | **** | **** |
| Green Time:  | 11.9        | 24.1 | 24.1 | 16.5        | 28.7 | 28.7 | 26.6       | 27.4 | 27.4 | 18.0       | 18.7 | 18.7 |
| Volume/Cap:  | 0.60        | 0.57 | 0.57 | 0.57        | 0.60 | 0.60 | 0.57       | 0.56 | 0.23 | 0.27       | 0.57 | 0.24 |
| Delay/Veh:   | 45.3        | 33.3 | 33.3 | 40.2        | 30.6 | 30.6 | 32.4       | 31.5 | 27.4 | 34.9       | 38.2 | 34.0 |
| User DelAdj:   | 1.00        | 1.00 | 1.00 | 1.00        | 1.00 | 1.00 | 1.00       | 1.00 | 1.00 | 1.00       | 1.00 | 1.00 |
| AdjDel/Veh:  | 45.3        | 33.3 | 33.3 | 40.2        | 30.6 | 30.6 | 32.4       | 31.5 | 27.4 | 34.9       | 38.2 | 34.0 |
| LOS by Move:   | D           | C    | C    | D           | C    | C    | C          | C    | C    | C          | D    | C    |
| HCM2k95thQ:  | 8           | 13   | 13   | 10          | 16   | 16   | 15         | 15   | 6    | 5          | 12   | 5    |

Note: Queue reported is the number of cars per lane.

BART

Level Of Service Computation Report  
2000 HCM Operations (Future Volume Alternative)  
AM - Background Conditions

Intersection #3678: MCKEE/33RD [Study Int 6]

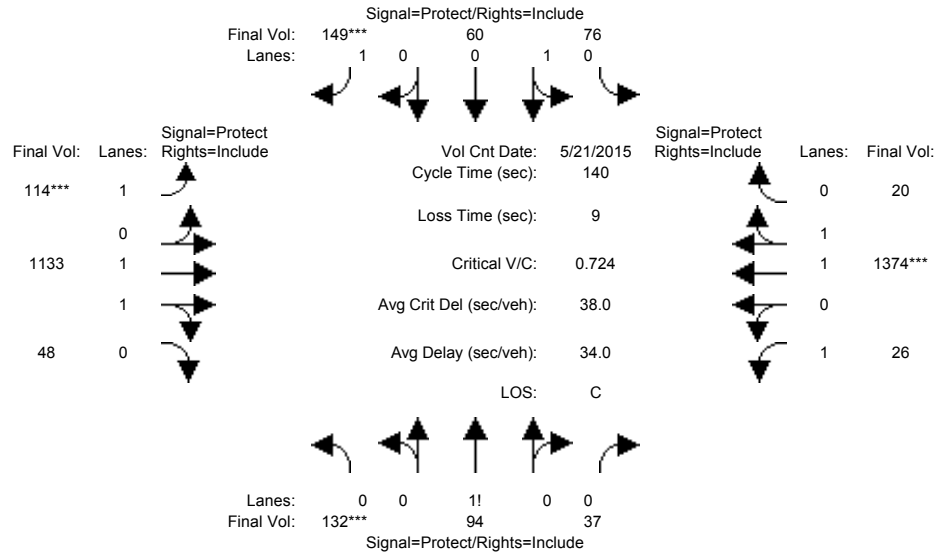

| Approach:  | North Bound |      |      | South Bound |      |      | East Bound |      |      | West Bound |      |      |
|--|-------------|------|------|-------------|------|------|------------|------|------|------------|------|------|
| Movement:  | L           | T    | R    | L           | T    | R    | L          | T    | R    | L          | T    | R    |
| Min. Green:  | 10          | 10   | 10   | 10          | 10   | 10   | 7          | 10   | 10   | 7          | 10   | 10   |
| Y+R:   | 4.0         | 4.0  | 4.0  | 4.0         | 4.0  | 4.0  | 4.0        | 4.0  | 4.0  | 4.0        | 4.0  | 4.0  |
| Volume Module: >> Count Date: 21 May 2015 << 7:30-8:30AM |             |      |      |             |      |      |            |      |      |            |      |      |
| Base Vol:  | 132         | 94   | 37   | 76          | 60   | 149  | 114        | 1133 | 48   | 26         | 1374 | 20   |
| Growth Adj:  | 1.00        | 1.00 | 1.00 | 1.00        | 1.00 | 1.00 | 1.00       | 1.00 | 1.00 | 1.00       | 1.00 | 1.00 |
| Initial Bse:   | 132         | 94   | 37   | 76          | 60   | 149  | 114        | 1133 | 48   | 26         | 1374 | 20   |
| Added Vol:   | 0           | 0    | 0    | 0           | 0    | 0    | 0          | 0    | 0    | 0          | 0    | 0    |
| PasserByVol:   | 0           | 0    | 0    | 0           | 0    | 0    | 0          | 0    | 0    | 0          | 0    | 0    |
| Initial Fut:   | 132         | 94   | 37   | 76          | 60   | 149  | 114        | 1133 | 48   | 26         | 1374 | 20   |
| User Adj:  | 1.00        | 1.00 | 1.00 | 1.00        | 1.00 | 1.00 | 1.00       | 1.00 | 1.00 | 1.00       | 1.00 | 1.00 |
| PHF Adj:   | 1.00        | 1.00 | 1.00 | 1.00        | 1.00 | 1.00 | 1.00       | 1.00 | 1.00 | 1.00       | 1.00 | 1.00 |
| PHF Volume:  | 132         | 94   | 37   | 76          | 60   | 149  | 114        | 1133 | 48   | 26         | 1374 | 20   |
| Reduct Vol:  | 0           | 0    | 0    | 0           | 0    | 0    | 0          | 0    | 0    | 0          | 0    | 0    |
| Reduced Vol:   | 132         | 94   | 37   | 76          | 60   | 149  | 114        | 1133 | 48   | 26         | 1374 | 20   |
| PCE Adj:   | 1.00        | 1.00 | 1.00 | 1.00        | 1.00 | 1.00 | 1.00       | 1.00 | 1.00 | 1.00       | 1.00 | 1.00 |
| MLF Adj:   | 1.00        | 1.00 | 1.00 | 1.00        | 1.00 | 1.00 | 1.00       | 1.00 | 1.00 | 1.00       | 1.00 | 1.00 |
| Final Volume:  | 132         | 94   | 37   | 76          | 60   | 149  | 114        | 1133 | 48   | 26         | 1374 | 20   |
| Saturation Flow Module:                                  |             |      |      |             |      |      |            |      |      |            |      |      |
| Sat/Lane:  | 1900        | 1900 | 1900 | 1900        | 1900 | 1900 | 1900       | 1900 | 1900 | 1900       | 1900 | 1900 |
| Adjustment:  | 0.92        | 0.92 | 0.92 | 0.95        | 0.95 | 0.92 | 0.92       | 0.97 | 0.95 | 0.92       | 0.97 | 0.95 |
| Lanes:   | 0.50        | 0.36 | 0.14 | 0.56        | 0.44 | 1.00 | 1.00       | 1.92 | 0.08 | 1.00       | 1.97 | 0.03 |
| Final Sat.:  | 878         | 625  | 246  | 1006        | 794  | 1750 | 1750       | 3550 | 150  | 1750       | 3647 | 53   |
| Capacity Analysis Module:                                |             |      |      |             |      |      |            |      |      |            |      |      |
| Vol/Sat:   | 0.15        | 0.15 | 0.15 | 0.08        | 0.08 | 0.09 | 0.07       | 0.32 | 0.32 | 0.01       | 0.38 | 0.38 |
| Crit Moves:  | ****        |      |      |             |      | **** | ****       |      |      | ****       |      |      |
| Green Time:  | 29.1        | 30.3 | 30.3 | 15.2        | 16.5 | 16.5 | 12.6       | 73.9 | 73.9 | 11.6       | 72.9 | 72.9 |
| Volume/Cap:  | 0.72        | 0.69 | 0.69 | 0.69        | 0.64 | 0.72 | 0.72       | 0.60 | 0.60 | 0.18       | 0.72 | 0.72 |
| Delay/Veh:   | 58.8        | 56.1 | 56.1 | 70.5        | 65.5 | 71.6 | 77.3       | 23.5 | 23.5 | 60.4       | 27.2 | 27.2 |
| User DelAdj:   | 1.00        | 1.00 | 1.00 | 1.00        | 1.00 | 1.00 | 1.00       | 1.00 | 1.00 | 1.00       | 1.00 | 1.00 |
| AdjDel/Veh:  | 58.8        | 56.1 | 56.1 | 70.5        | 65.5 | 71.6 | 77.3       | 23.5 | 23.5 | 60.4       | 27.2 | 27.2 |
| LOS by Move:   | E           | E    | E    | E           | E    | E    | E          | C    | C    | E          | C    | C    |
| HCM2k95thQ:  | 21          | 21   | 21   | 14          | 13   | 15   | 10         | 30   | 30   | 2          | 37   | 37   |

Note: Queue reported is the number of cars per lane.

BART

Level Of Service Computation Report  
 2000 HCM Operations (Future Volume Alternative)  
 PM - Background Conditions

Intersection #3678: MCKEE/33RD [Study Int 6]

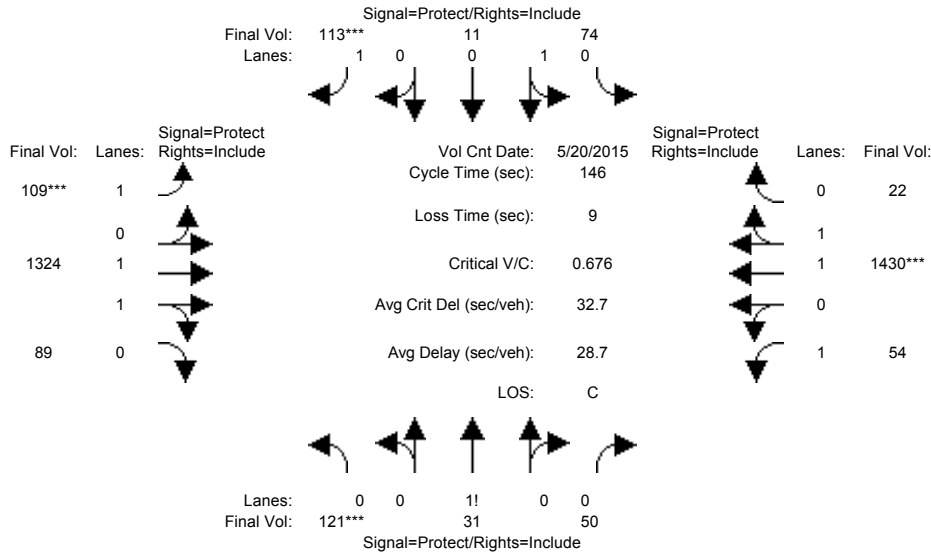

| Approach:  | North Bound |      |      | South Bound |      |      | East Bound |      |      | West Bound |      |      |
|--|-------------|------|------|-------------|------|------|------------|------|------|------------|------|------|
| Movement:  | L           | T    | R    | L           | T    | R    | L          | T    | R    | L          | T    | R    |
| Min. Green:  | 10          | 10   | 10   | 10          | 10   | 10   | 7          | 10   | 10   | 7          | 10   | 10   |
| Y+R:   | 4.0         | 4.0  | 4.0  | 4.0         | 4.0  | 4.0  | 4.0        | 4.0  | 4.0  | 4.0        | 4.0  | 4.0  |
| Volume Module: >> Count Date: 20 May 2015 << 5:00-6:00PM |             |      |      |             |      |      |            |      |      |            |      |      |
| Base Vol:  | 121         | 31   | 50   | 74          | 11   | 113  | 109        | 1324 | 89   | 54         | 1430 | 22   |
| Growth Adj:  | 1.00        | 1.00 | 1.00 | 1.00        | 1.00 | 1.00 | 1.00       | 1.00 | 1.00 | 1.00       | 1.00 | 1.00 |
| Initial Bse:   | 121         | 31   | 50   | 74          | 11   | 113  | 109        | 1324 | 89   | 54         | 1430 | 22   |
| Added Vol:   | 0           | 0    | 0    | 0           | 0    | 0    | 0          | 0    | 0    | 0          | 0    | 0    |
| PasserByVol:   | 0           | 0    | 0    | 0           | 0    | 0    | 0          | 0    | 0    | 0          | 0    | 0    |
| Initial Fut:   | 121         | 31   | 50   | 74          | 11   | 113  | 109        | 1324 | 89   | 54         | 1430 | 22   |
| User Adj:  | 1.00        | 1.00 | 1.00 | 1.00        | 1.00 | 1.00 | 1.00       | 1.00 | 1.00 | 1.00       | 1.00 | 1.00 |
| PHF Adj:   | 1.00        | 1.00 | 1.00 | 1.00        | 1.00 | 1.00 | 1.00       | 1.00 | 1.00 | 1.00       | 1.00 | 1.00 |
| PHF Volume:  | 121         | 31   | 50   | 74          | 11   | 113  | 109        | 1324 | 89   | 54         | 1430 | 22   |
| Reduct Vol:  | 0           | 0    | 0    | 0           | 0    | 0    | 0          | 0    | 0    | 0          | 0    | 0    |
| Reduced Vol:   | 121         | 31   | 50   | 74          | 11   | 113  | 109        | 1324 | 89   | 54         | 1430 | 22   |
| PCE Adj:   | 1.00        | 1.00 | 1.00 | 1.00        | 1.00 | 1.00 | 1.00       | 1.00 | 1.00 | 1.00       | 1.00 | 1.00 |
| MLF Adj:   | 1.00        | 1.00 | 1.00 | 1.00        | 1.00 | 1.00 | 1.00       | 1.00 | 1.00 | 1.00       | 1.00 | 1.00 |
| Final Volume:  | 121         | 31   | 50   | 74          | 11   | 113  | 109        | 1324 | 89   | 54         | 1430 | 22   |
| Saturation Flow Module:                                  |             |      |      |             |      |      |            |      |      |            |      |      |
| Sat/Lane:  | 1900        | 1900 | 1900 | 1900        | 1900 | 1900 | 1900       | 1900 | 1900 | 1900       | 1900 | 1900 |
| Adjustment:  | 0.92        | 0.92 | 0.92 | 0.95        | 0.95 | 0.92 | 0.92       | 0.98 | 0.95 | 0.92       | 0.97 | 0.95 |
| Lanes:   | 0.60        | 0.15 | 0.25 | 0.87        | 0.13 | 1.00 | 1.00       | 1.87 | 0.13 | 1.00       | 1.97 | 0.03 |
| Final Sat.:  | 1048        | 269  | 433  | 1567        | 233  | 1750 | 1750       | 3467 | 233  | 1750       | 3644 | 56   |
| Capacity Analysis Module:                                |             |      |      |             |      |      |            |      |      |            |      |      |
| Vol/Sat:   | 0.12        | 0.12 | 0.12 | 0.05        | 0.05 | 0.06 | 0.06       | 0.38 | 0.38 | 0.03       | 0.39 | 0.39 |
| Crit Moves:  | ****        |      |      | ****        | **** | **** | ****       |      |      | ****       |      |      |
| Green Time:  | 24.9        | 24.4 | 24.4 | 14.5        | 13.9 | 13.9 | 13.4       | 87.2 | 87.2 | 10.9       | 84.7 | 84.7 |
| Volume/Cap:  | 0.68        | 0.69 | 0.69 | 0.48        | 0.49 | 0.68 | 0.68       | 0.64 | 0.64 | 0.41       | 0.68 | 0.68 |
| Delay/Veh:   | 62.8        | 64.2 | 64.2 | 64.2        | 64.9 | 74.4 | 75.1       | 19.8 | 19.8 | 66.5       | 22.1 | 22.1 |
| User DelAdj:   | 1.00        | 1.00 | 1.00 | 1.00        | 1.00 | 1.00 | 1.00       | 1.00 | 1.00 | 1.00       | 1.00 | 1.00 |
| AdjDel/Veh:  | 62.8        | 64.2 | 64.2 | 64.2        | 64.9 | 74.4 | 75.1       | 19.8 | 19.8 | 66.5       | 22.1 | 22.1 |
| LOS by Move:   | E           | E    | E    | E           | E    | E    | E          | B    | B    | E          | C    | C    |
| HCM2k95thQ:  | 17          | 17   | 17   | 8           | 9    | 12   | 10         | 35   | 35   | 5          | 37   | 37   |

Note: Queue reported is the number of cars per lane.

BART

Level Of Service Computation Report  
2000 HCM Operations (Future Volume Alternative)  
AM - Background Conditions

Intersection #3683: McLAUGHLIN/STORY [Study Int 26]

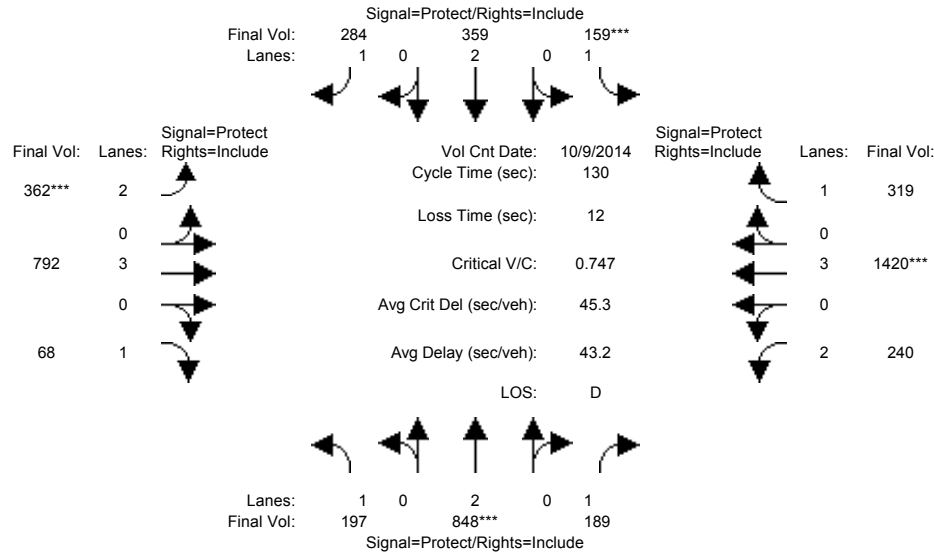

| Approach:                                   | North Bound |      |      | South Bound |      |      | East Bound |      |      | West Bound |      |      |
|---|-------------|------|------|-------------|------|------|------------|------|------|------------|------|------|
| Movement:                                   | L           | T    | R    | L           | T    | R    | L          | T    | R    | L          | T    | R    |
| Min. Green:                                 | 7           | 10   | 10   | 7           | 10   | 10   | 7          | 10   | 10   | 7          | 10   | 10   |
| Y+R:  | 4.0         | 4.0  | 4.0  | 4.0         | 4.0  | 4.0  | 4.0        | 4.0  | 4.0  | 4.0        | 4.0  | 4.0  |
| Volume Module: >> Count Date: 9 Oct 2014 << |             |      |      |             |      |      |            |      |      |            |      |      |
| Base Vol:                                   | 197         | 848  | 189  | 159         | 359  | 284  | 362        | 792  | 68   | 240        | 1420 | 319  |
| Growth Adj:                                 | 1.00        | 1.00 | 1.00 | 1.00        | 1.00 | 1.00 | 1.00       | 1.00 | 1.00 | 1.00       | 1.00 | 1.00 |
| Initial Bse:                                | 197         | 848  | 189  | 159         | 359  | 284  | 362        | 792  | 68   | 240        | 1420 | 319  |
| Added Vol:                                  | 0           | 0    | 0    | 0           | 0    | 0    | 0          | 0    | 0    | 0          | 0    | 0    |
| PasserByVol:                                | 0           | 0    | 0    | 0           | 0    | 0    | 0          | 0    | 0    | 0          | 0    | 0    |
| Initial Fut:                                | 197         | 848  | 189  | 159         | 359  | 284  | 362        | 792  | 68   | 240        | 1420 | 319  |
| User Adj:                                   | 1.00        | 1.00 | 1.00 | 1.00        | 1.00 | 1.00 | 1.00       | 1.00 | 1.00 | 1.00       | 1.00 | 1.00 |
| PHF Adj:                                    | 1.00        | 1.00 | 1.00 | 1.00        | 1.00 | 1.00 | 1.00       | 1.00 | 1.00 | 1.00       | 1.00 | 1.00 |
| PHF Volume:                                 | 197         | 848  | 189  | 159         | 359  | 284  | 362        | 792  | 68   | 240        | 1420 | 319  |
| Reduct Vol:                                 | 0           | 0    | 0    | 0           | 0    | 0    | 0          | 0    | 0    | 0          | 0    | 0    |
| Reduced Vol:                                | 197         | 848  | 189  | 159         | 359  | 284  | 362        | 792  | 68   | 240        | 1420 | 319  |
| PCE Adj:                                    | 1.00        | 1.00 | 1.00 | 1.00        | 1.00 | 1.00 | 1.00       | 1.00 | 1.00 | 1.00       | 1.00 | 1.00 |
| MLF Adj:                                    | 1.00        | 1.00 | 1.00 | 1.00        | 1.00 | 1.00 | 1.00       | 1.00 | 1.00 | 1.00       | 1.00 | 1.00 |
| Final Volume:                               | 197         | 848  | 189  | 159         | 359  | 284  | 362        | 792  | 68   | 240        | 1420 | 319  |
| Saturation Flow Module:                     |             |      |      |             |      |      |            |      |      |            |      |      |
| Sat/Lane:                                   | 1900        | 1900 | 1900 | 1900        | 1900 | 1900 | 1900       | 1900 | 1900 | 1900       | 1900 | 1900 |
| Adjustment:                                 | 0.92        | 1.00 | 0.92 | 0.92        | 1.00 | 0.92 | 0.83       | 1.00 | 0.92 | 0.83       | 1.00 | 0.92 |
| Lanes:                                      | 1.00        | 2.00 | 1.00 | 1.00        | 2.00 | 1.00 | 2.00       | 3.00 | 1.00 | 2.00       | 3.00 | 1.00 |
| Final Sat.:                                 | 1750        | 3800 | 1750 | 1750        | 3800 | 1750 | 3150       | 5700 | 1750 | 3150       | 5700 | 1750 |
| Capacity Analysis Module:                   |             |      |      |             |      |      |            |      |      |            |      |      |
| Vol/Sat:                                    | 0.11        | 0.22 | 0.11 | 0.09        | 0.09 | 0.16 | 0.11       | 0.14 | 0.04 | 0.08       | 0.25 | 0.18 |
| Crit Moves:                                 | ****        | **** | **** | ****        | **** | **** | ****       | **** | **** | ****       | **** | **** |
| Green Time:                                 | 22.4        | 38.8 | 38.8 | 15.8        | 32.3 | 32.3 | 20.0       | 40.9 | 40.9 | 22.4       | 43.4 | 43.4 |
| Volume/Cap:                                 | 0.65        | 0.75 | 0.36 | 0.75        | 0.38 | 0.65 | 0.75       | 0.44 | 0.12 | 0.44       | 0.75 | 0.55 |
| Delay/Veh:                                  | 55.3        | 43.9 | 36.3 | 68.7        | 40.8 | 47.4 | 58.9       | 35.6 | 31.9 | 48.7       | 40.1 | 36.4 |
| User DelAdj:                                | 1.00        | 1.00 | 1.00 | 1.00        | 1.00 | 1.00 | 1.00       | 1.00 | 1.00 | 1.00       | 1.00 | 1.00 |
| AdjDel/Veh:                                 | 55.3        | 43.9 | 36.3 | 68.7        | 40.8 | 47.4 | 58.9       | 35.6 | 31.9 | 48.7       | 40.1 | 36.4 |
| LOS by Move:                                | E           | D    | D    | E           | D    | D    | E          | D    | C    | D          | D    | D    |
| HCM2k95thQ:                                 | 17          | 29   | 12   | 13          | 11   | 20   | 18         | 16   | 4    | 10         | 29   | 20   |

Note: Queue reported is the number of cars per lane.

BART

Level Of Service Computation Report  
2000 HCM Operations (Future Volume Alternative)  
PM - Background Conditions

Intersection #3683: McLAUGHLIN/STORY [Study Int 26]

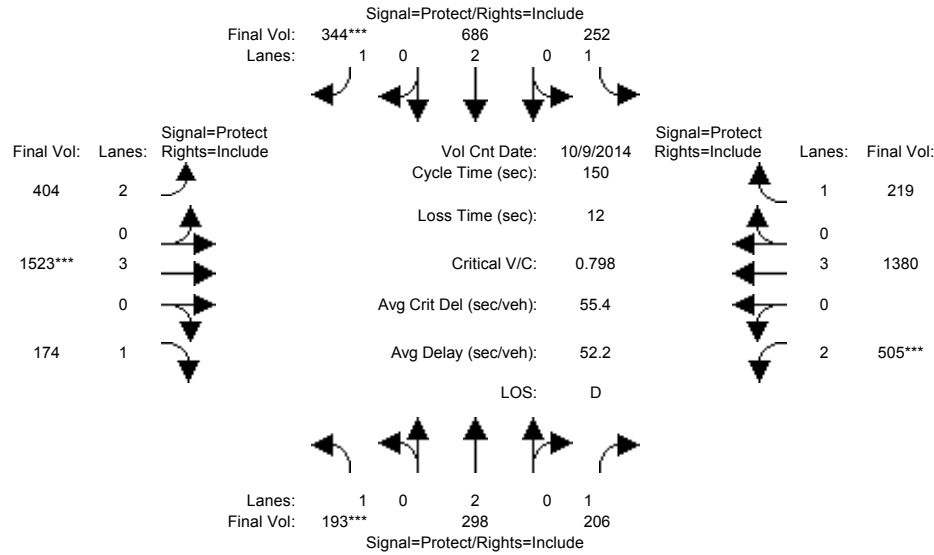

| Approach:                                   | North Bound |      |      | South Bound |      |      | East Bound |      |      | West Bound |      |      |
|---|-------------|------|------|-------------|------|------|------------|------|------|------------|------|------|
| Movement:                                   | L           | T    | R    | L           | T    | R    | L          | T    | R    | L          | T    | R    |
| Min. Green:                                 | 7           | 10   | 10   | 7           | 10   | 10   | 7          | 10   | 10   | 7          | 10   | 10   |
| Y+R:  | 4.0         | 4.0  | 4.0  | 4.0         | 4.0  | 4.0  | 4.0        | 4.0  | 4.0  | 4.0        | 4.0  | 4.0  |
| Volume Module: >> Count Date: 9 Oct 2014 << |             |      |      |             |      |      |            |      |      |            |      |      |
| Base Vol:                                   | 193         | 298  | 206  | 252         | 686  | 344  | 404        | 1523 | 174  | 505        | 1380 | 219  |
| Growth Adj:                                 | 1.00        | 1.00 | 1.00 | 1.00        | 1.00 | 1.00 | 1.00       | 1.00 | 1.00 | 1.00       | 1.00 | 1.00 |
| Initial Bse:                                | 193         | 298  | 206  | 252         | 686  | 344  | 404        | 1523 | 174  | 505        | 1380 | 219  |
| Added Vol:                                  | 0           | 0    | 0    | 0           | 0    | 0    | 0          | 0    | 0    | 0          | 0    | 0    |
| PasserByVol:                                | 0           | 0    | 0    | 0           | 0    | 0    | 0          | 0    | 0    | 0          | 0    | 0    |
| Initial Fut:                                | 193         | 298  | 206  | 252         | 686  | 344  | 404        | 1523 | 174  | 505        | 1380 | 219  |
| User Adj:                                   | 1.00        | 1.00 | 1.00 | 1.00        | 1.00 | 1.00 | 1.00       | 1.00 | 1.00 | 1.00       | 1.00 | 1.00 |
| PHF Adj:                                    | 1.00        | 1.00 | 1.00 | 1.00        | 1.00 | 1.00 | 1.00       | 1.00 | 1.00 | 1.00       | 1.00 | 1.00 |
| PHF Volume:                                 | 193         | 298  | 206  | 252         | 686  | 344  | 404        | 1523 | 174  | 505        | 1380 | 219  |
| Reduct Vol:                                 | 0           | 0    | 0    | 0           | 0    | 0    | 0          | 0    | 0    | 0          | 0    | 0    |
| Reduced Vol:                                | 193         | 298  | 206  | 252         | 686  | 344  | 404        | 1523 | 174  | 505        | 1380 | 219  |
| PCE Adj:                                    | 1.00        | 1.00 | 1.00 | 1.00        | 1.00 | 1.00 | 1.00       | 1.00 | 1.00 | 1.00       | 1.00 | 1.00 |
| MLF Adj:                                    | 1.00        | 1.00 | 1.00 | 1.00        | 1.00 | 1.00 | 1.00       | 1.00 | 1.00 | 1.00       | 1.00 | 1.00 |
| Final Volume:                               | 193         | 298  | 206  | 252         | 686  | 344  | 404        | 1523 | 174  | 505        | 1380 | 219  |
| Saturation Flow Module:                     |             |      |      |             |      |      |            |      |      |            |      |      |
| Sat/Lane:                                   | 1900        | 1900 | 1900 | 1900        | 1900 | 1900 | 1900       | 1900 | 1900 | 1900       | 1900 | 1900 |
| Adjustment:                                 | 0.92        | 1.00 | 0.92 | 0.92        | 1.00 | 0.92 | 0.83       | 1.00 | 0.92 | 0.83       | 1.00 | 0.92 |
| Lanes:                                      | 1.00        | 2.00 | 1.00 | 1.00        | 2.00 | 1.00 | 2.00       | 3.00 | 1.00 | 2.00       | 3.00 | 1.00 |
| Final Sat.:                                 | 1750        | 3800 | 1750 | 1750        | 3800 | 1750 | 3150       | 5700 | 1750 | 3150       | 5700 | 1750 |
| Capacity Analysis Module:                   |             |      |      |             |      |      |            |      |      |            |      |      |
| Vol/Sat:                                    | 0.11        | 0.08 | 0.12 | 0.14        | 0.18 | 0.20 | 0.13       | 0.27 | 0.10 | 0.16       | 0.24 | 0.13 |
| Crit Moves:                                 | ****        |      |      | ****        |      |      | ****       |      |      | ****       |      |      |
| Green Time:                                 | 20.7        | 25.9 | 25.9 | 31.7        | 36.9 | 36.9 | 27.8       | 50.2 | 50.2 | 30.1       | 52.5 | 52.5 |
| Volume/Cap:                                 | 0.80        | 0.45 | 0.68 | 0.68        | 0.73 | 0.80 | 0.69       | 0.80 | 0.30 | 0.80       | 0.69 | 0.36 |
| Delay/Veh:                                  | 79.4        | 56.2 | 64.3 | 59.6        | 55.0 | 63.1 | 60.6       | 47.8 | 37.1 | 64.1       | 42.9 | 36.6 |
| User DelAdj:                                | 1.00        | 1.00 | 1.00 | 1.00        | 1.00 | 1.00 | 1.00       | 1.00 | 1.00 | 1.00       | 1.00 | 1.00 |
| AdjDel/Veh:                                 | 79.4        | 56.2 | 64.3 | 59.6        | 55.0 | 63.1 | 60.6       | 47.8 | 37.1 | 64.1       | 42.9 | 36.6 |
| LOS by Move:                                | E           | E    | E    | E           | E    | E    | E          | D    | D    | E          | D    | D    |
| HCM2k95thQ:                                 | 20          | 12   | 19   | 21          | 26   | 29   | 21         | 38   | 12   | 25         | 31   | 15   |

Note: Queue reported is the number of cars per lane.

BART

Level Of Service Computation Report  
 2000 HCM Operations (Future Volume Alternative)  
 AM - Background Conditions

Intersection #3762: SAN ANTONIO/24TH [Study Int 21]

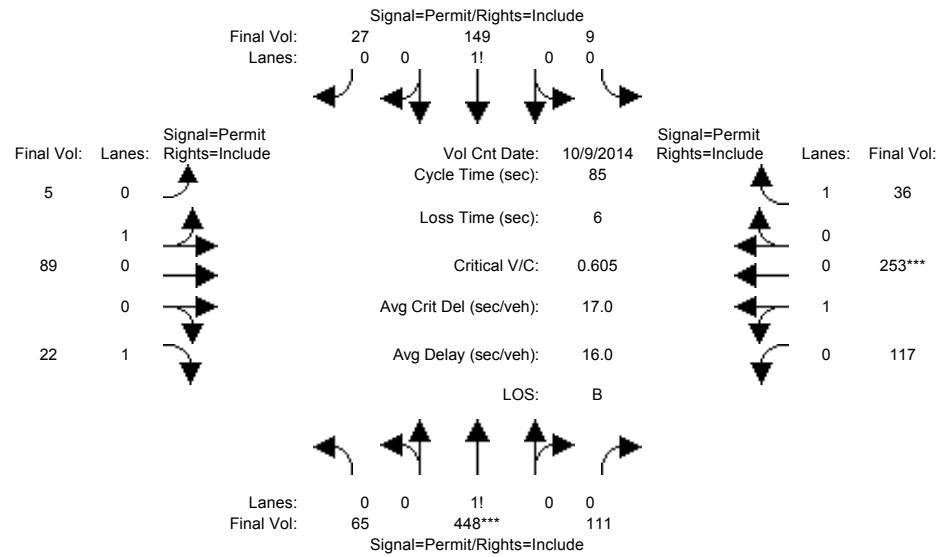

| Approach:                                   | North Bound |      |      | South Bound |      |      | East Bound |      |      | West Bound |      |      |
|---|-------------|------|------|-------------|------|------|------------|------|------|------------|------|------|
| Movement:                                   | L           | T    | R    | L           | T    | R    | L          | T    | R    | L          | T    | R    |
| Min. Green:                                 | 10          | 10   | 10   | 10          | 10   | 10   | 10         | 10   | 10   | 10         | 10   | 10   |
| Y+R:  | 4.0         | 4.0  | 4.0  | 4.0         | 4.0  | 4.0  | 4.0        | 4.0  | 4.0  | 4.0        | 4.0  | 4.0  |
| Volume Module: >> Count Date: 9 Oct 2014 << |             |      |      |             |      |      |            |      |      |            |      |      |
| Base Vol:                                   | 65          | 448  | 111  | 9           | 149  | 27   | 5          | 89   | 22   | 117        | 253  | 36   |
| Growth Adj:                                 | 1.00        | 1.00 | 1.00 | 1.00        | 1.00 | 1.00 | 1.00       | 1.00 | 1.00 | 1.00       | 1.00 | 1.00 |
| Initial Bse:                                | 65          | 448  | 111  | 9           | 149  | 27   | 5          | 89   | 22   | 117        | 253  | 36   |
| Added Vol:                                  | 0           | 0    | 0    | 0           | 0    | 0    | 0          | 0    | 0    | 0          | 0    | 0    |
| PasserByVol:                                | 0           | 0    | 0    | 0           | 0    | 0    | 0          | 0    | 0    | 0          | 0    | 0    |
| Initial Fut:                                | 65          | 448  | 111  | 9           | 149  | 27   | 5          | 89   | 22   | 117        | 253  | 36   |
| User Adj:                                   | 1.00        | 1.00 | 1.00 | 1.00        | 1.00 | 1.00 | 1.00       | 1.00 | 1.00 | 1.00       | 1.00 | 1.00 |
| PHF Adj:                                    | 1.00        | 1.00 | 1.00 | 1.00        | 1.00 | 1.00 | 1.00       | 1.00 | 1.00 | 1.00       | 1.00 | 1.00 |
| PHF Volume:                                 | 65          | 448  | 111  | 9           | 149  | 27   | 5          | 89   | 22   | 117        | 253  | 36   |
| Reduct Vol:                                 | 0           | 0    | 0    | 0           | 0    | 0    | 0          | 0    | 0    | 0          | 0    | 0    |
| Reduced Vol:                                | 65          | 448  | 111  | 9           | 149  | 27   | 5          | 89   | 22   | 117        | 253  | 36   |
| PCE Adj:                                    | 1.00        | 1.00 | 1.00 | 1.00        | 1.00 | 1.00 | 1.00       | 1.00 | 1.00 | 1.00       | 1.00 | 1.00 |
| MLF Adj:                                    | 1.00        | 1.00 | 1.00 | 1.00        | 1.00 | 1.00 | 1.00       | 1.00 | 1.00 | 1.00       | 1.00 | 1.00 |
| FinalVolume:                                | 65          | 448  | 111  | 9           | 149  | 27   | 5          | 89   | 22   | 117        | 253  | 36   |
| Saturation Flow Module:                     |             |      |      |             |      |      |            |      |      |            |      |      |
| Sat/Lane:                                   | 1900        | 1900 | 1900 | 1900        | 1900 | 1900 | 1900       | 1900 | 1900 | 1900       | 1900 | 1900 |
| Adjustment:                                 | 0.92        | 0.92 | 0.92 | 0.92        | 0.92 | 0.92 | 0.95       | 0.95 | 0.92 | 0.95       | 0.95 | 0.92 |
| Lanes:                                      | 0.10        | 0.72 | 0.18 | 0.05        | 0.80 | 0.15 | 0.05       | 0.95 | 1.00 | 0.32       | 0.68 | 1.00 |
| Final Sat.:                                 | 182         | 1256 | 311  | 85          | 1409 | 255  | 96         | 1704 | 1750 | 569        | 1231 | 1750 |
| Capacity Analysis Module:                   |             |      |      |             |      |      |            |      |      |            |      |      |
| Vol/Sat:                                    | 0.36        | 0.36 | 0.36 | 0.11        | 0.11 | 0.11 | 0.05       | 0.05 | 0.01 | 0.21       | 0.21 | 0.02 |
| Crit Moves:                                 | ****        |      |      |             |      |      |            |      |      |            | **** |      |
| Green Time:                                 | 50.1        | 50.1 | 50.1 | 50.1        | 50.1 | 50.1 | 28.9       | 28.9 | 28.9 | 28.9       | 28.9 | 28.9 |
| Volume/Cap:                                 | 0.60        | 0.60 | 0.60 | 0.18        | 0.18 | 0.18 | 0.15       | 0.15 | 0.04 | 0.60       | 0.60 | 0.06 |
| Delay/Veh:                                  | 12.2        | 12.2 | 12.2 | 8.1         | 8.1  | 8.1  | 19.7       | 19.7 | 18.8 | 25.0       | 25.0 | 19.0 |
| User DelAdj:                                | 1.00        | 1.00 | 1.00 | 1.00        | 1.00 | 1.00 | 1.00       | 1.00 | 1.00 | 1.00       | 1.00 | 1.00 |
| AdjDel/Veh:                                 | 12.2        | 12.2 | 12.2 | 8.1         | 8.1  | 8.1  | 19.7       | 19.7 | 18.8 | 25.0       | 25.0 | 19.0 |
| LOS by Move:                                | B           | B    | B    | A           | A    | A    | B          | B    | B    | C          | C    | B    |
| HCM2k95thQ:                                 | 20          | 20   | 20   | 5           | 5    | 5    | 4          | 4    | 1    | 16         | 16   | 1    |

Note: Queue reported is the number of cars per lane.

BART

Level Of Service Computation Report  
 2000 HCM Operations (Future Volume Alternative)  
 PM - Background Conditions

Intersection #3762: SAN ANTONIO/24TH [Study Int 21]

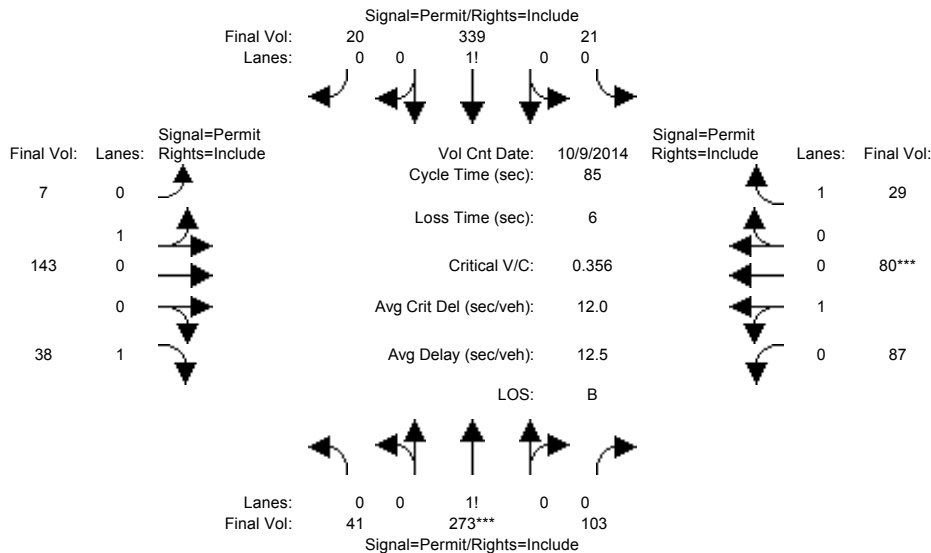

| Approach:                                   | North Bound |      |      | South Bound |      |      | East Bound |      |      | West Bound |      |      |
|---|-------------|------|------|-------------|------|------|------------|------|------|------------|------|------|
| Movement:                                   | L           | T    | R    | L           | T    | R    | L          | T    | R    | L          | T    | R    |
| Min. Green:                                 | 10          | 10   | 10   | 10          | 10   | 10   | 10         | 10   | 10   | 10         | 10   | 10   |
| Y+R:  | 4.0         | 4.0  | 4.0  | 4.0         | 4.0  | 4.0  | 4.0        | 4.0  | 4.0  | 4.0        | 4.0  | 4.0  |
| Volume Module: >> Count Date: 9 Oct 2014 << |             |      |      |             |      |      |            |      |      |            |      |      |
| Base Vol:                                   | 41          | 273  | 103  | 21          | 339  | 20   | 7          | 143  | 38   | 87         | 80   | 29   |
| Growth Adj:                                 | 1.00        | 1.00 | 1.00 | 1.00        | 1.00 | 1.00 | 1.00       | 1.00 | 1.00 | 1.00       | 1.00 | 1.00 |
| Initial Bse:                                | 41          | 273  | 103  | 21          | 339  | 20   | 7          | 143  | 38   | 87         | 80   | 29   |
| Added Vol:                                  | 0           | 0    | 0    | 0           | 0    | 0    | 0          | 0    | 0    | 0          | 0    | 0    |
| PasserByVol:                                | 0           | 0    | 0    | 0           | 0    | 0    | 0          | 0    | 0    | 0          | 0    | 0    |
| Initial Fut:                                | 41          | 273  | 103  | 21          | 339  | 20   | 7          | 143  | 38   | 87         | 80   | 29   |
| User Adj:                                   | 1.00        | 1.00 | 1.00 | 1.00        | 1.00 | 1.00 | 1.00       | 1.00 | 1.00 | 1.00       | 1.00 | 1.00 |
| PHF Adj:                                    | 1.00        | 1.00 | 1.00 | 1.00        | 1.00 | 1.00 | 1.00       | 1.00 | 1.00 | 1.00       | 1.00 | 1.00 |
| PHF Volume:                                 | 41          | 273  | 103  | 21          | 339  | 20   | 7          | 143  | 38   | 87         | 80   | 29   |
| Reduct Vol:                                 | 0           | 0    | 0    | 0           | 0    | 0    | 0          | 0    | 0    | 0          | 0    | 0    |
| Reduced Vol:                                | 41          | 273  | 103  | 21          | 339  | 20   | 7          | 143  | 38   | 87         | 80   | 29   |
| PCE Adj:                                    | 1.00        | 1.00 | 1.00 | 1.00        | 1.00 | 1.00 | 1.00       | 1.00 | 1.00 | 1.00       | 1.00 | 1.00 |
| MLF Adj:                                    | 1.00        | 1.00 | 1.00 | 1.00        | 1.00 | 1.00 | 1.00       | 1.00 | 1.00 | 1.00       | 1.00 | 1.00 |
| Final Volume:                               | 41          | 273  | 103  | 21          | 339  | 20   | 7          | 143  | 38   | 87         | 80   | 29   |
| Saturation Flow Module:                     |             |      |      |             |      |      |            |      |      |            |      |      |
| Sat/Lane:                                   | 1900        | 1900 | 1900 | 1900        | 1900 | 1900 | 1900       | 1900 | 1900 | 1900       | 1900 | 1900 |
| Adjustment:                                 | 0.92        | 0.92 | 0.92 | 0.92        | 0.92 | 0.92 | 0.95       | 0.95 | 0.92 | 0.95       | 0.95 | 0.92 |
| Lanes:                                      | 0.10        | 0.65 | 0.25 | 0.06        | 0.89 | 0.05 | 0.05       | 0.95 | 1.00 | 0.52       | 0.48 | 1.00 |
| Final Sat.:                                 | 172         | 1146 | 432  | 97          | 1561 | 92   | 84         | 1716 | 1750 | 938        | 862  | 1750 |
| Capacity Analysis Module:                   |             |      |      |             |      |      |            |      |      |            |      |      |
| Vol/Sat:                                    | 0.24        | 0.24 | 0.24 | 0.22        | 0.22 | 0.22 | 0.08       | 0.08 | 0.02 | 0.09       | 0.09 | 0.02 |
| Crit Moves:                                 | ****        |      |      |             |      |      |            |      |      | ****       |      |      |
| Green Time:                                 | 56.9        | 56.9 | 56.9 | 56.9        | 56.9 | 56.9 | 22.1       | 22.1 | 22.1 | 22.1       | 22.1 | 22.1 |
| Volume/Cap:                                 | 0.36        | 0.36 | 0.36 | 0.32        | 0.32 | 0.32 | 0.32       | 0.32 | 0.08 | 0.36       | 0.36 | 0.06 |
| Delay/Veh:                                  | 6.3         | 6.3  | 6.3  | 6.1         | 6.1  | 6.1  | 25.8       | 25.8 | 23.8 | 26.1       | 26.1 | 23.7 |
| User DelAdj:                                | 1.00        | 1.00 | 1.00 | 1.00        | 1.00 | 1.00 | 1.00       | 1.00 | 1.00 | 1.00       | 1.00 | 1.00 |
| AdjDel/Veh:                                 | 6.3         | 6.3  | 6.3  | 6.1         | 6.1  | 6.1  | 25.8       | 25.8 | 23.8 | 26.1       | 26.1 | 23.7 |
| LOS by Move:                                | A           | A    | A    | A           | A    | A    | C          | C    | C    | C          | C    | C    |
| HCM2k95thQ:                                 | 10          | 10   | 10   | 9           | 9    | 9    | 7          | 7    | 2    | 7          | 7    | 1    |

Note: Queue reported is the number of cars per lane.

BART

Level Of Service Computation Report  
2000 HCM Operations (Future Volume Alternative)  
AM - Background Conditions

Intersection #3783: SANTA CLARA/17TH [Study Int 9]

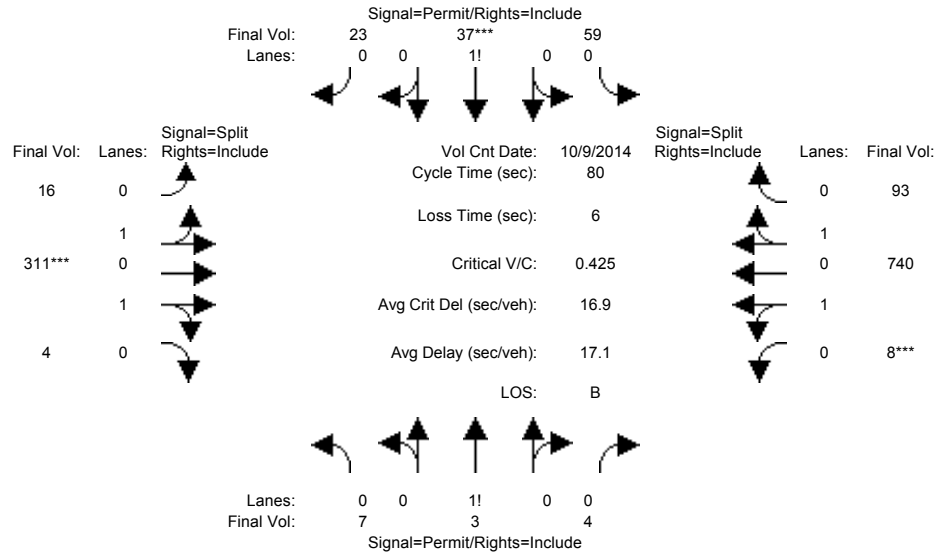

| Approach:                                   | North Bound |      |      | South Bound |      |      | East Bound |      |      | West Bound |      |      |
|---|-------------|------|------|-------------|------|------|------------|------|------|------------|------|------|
| Movement:                                   | L           | T    | R    | L           | T    | R    | L          | T    | R    | L          | T    | R    |
| Min. Green:                                 | 10          | 10   | 10   | 10          | 10   | 10   | 10         | 10   | 10   | 10         | 10   | 10   |
| Y+R:  | 4.0         | 4.0  | 4.0  | 4.0         | 4.0  | 4.0  | 4.0        | 4.0  | 4.0  | 4.0        | 4.0  | 4.0  |
| Volume Module: >> Count Date: 9 Oct 2014 << |             |      |      |             |      |      |            |      |      |            |      |      |
| Base Vol:                                   | 7           | 3    | 4    | 59          | 37   | 23   | 16         | 311  | 4    | 8          | 740  | 93   |
| Growth Adj:                                 | 1.00        | 1.00 | 1.00 | 1.00        | 1.00 | 1.00 | 1.00       | 1.00 | 1.00 | 1.00       | 1.00 | 1.00 |
| Initial Bse:                                | 7           | 3    | 4    | 59          | 37   | 23   | 16         | 311  | 4    | 8          | 740  | 93   |
| Added Vol:                                  | 0           | 0    | 0    | 0           | 0    | 0    | 0          | 0    | 0    | 0          | 0    | 0    |
| PasserByVol:                                | 0           | 0    | 0    | 0           | 0    | 0    | 0          | 0    | 0    | 0          | 0    | 0    |
| Initial Fut:                                | 7           | 3    | 4    | 59          | 37   | 23   | 16         | 311  | 4    | 8          | 740  | 93   |
| User Adj:                                   | 1.00        | 1.00 | 1.00 | 1.00        | 1.00 | 1.00 | 1.00       | 1.00 | 1.00 | 1.00       | 1.00 | 1.00 |
| PHF Adj:                                    | 1.00        | 1.00 | 1.00 | 1.00        | 1.00 | 1.00 | 1.00       | 1.00 | 1.00 | 1.00       | 1.00 | 1.00 |
| PHF Volume:                                 | 7           | 3    | 4    | 59          | 37   | 23   | 16         | 311  | 4    | 8          | 740  | 93   |
| Reduct Vol:                                 | 0           | 0    | 0    | 0           | 0    | 0    | 0          | 0    | 0    | 0          | 0    | 0    |
| Reduced Vol:                                | 7           | 3    | 4    | 59          | 37   | 23   | 16         | 311  | 4    | 8          | 740  | 93   |
| PCE Adj:                                    | 1.00        | 1.00 | 1.00 | 1.00        | 1.00 | 1.00 | 1.00       | 1.00 | 1.00 | 1.00       | 1.00 | 1.00 |
| MLF Adj:                                    | 1.00        | 1.00 | 1.00 | 1.00        | 1.00 | 1.00 | 1.00       | 1.00 | 1.00 | 1.00       | 1.00 | 1.00 |
| Final Volume:                               | 7           | 3    | 4    | 59          | 37   | 23   | 16         | 311  | 4    | 8          | 740  | 93   |
| Saturation Flow Module:                     |             |      |      |             |      |      |            |      |      |            |      |      |
| Sat/Lane:                                   | 1900        | 1900 | 1900 | 1900        | 1900 | 1900 | 1900       | 1900 | 1900 | 1900       | 1900 | 1900 |
| Adjustment:                                 | 0.92        | 0.92 | 0.92 | 0.92        | 0.92 | 0.92 | 0.95       | 0.95 | 0.95 | 0.95       | 0.95 | 0.95 |
| Lanes:                                      | 0.50        | 0.21 | 0.29 | 0.50        | 0.31 | 0.19 | 0.10       | 1.88 | 0.02 | 0.02       | 1.76 | 0.22 |
| Final Sat.:                                 | 875         | 375  | 500  | 868         | 544  | 338  | 174        | 3382 | 44   | 34         | 3168 | 398  |
| Capacity Analysis Module:                   |             |      |      |             |      |      |            |      |      |            |      |      |
| Vol/Sat:                                    | 0.01        | 0.01 | 0.01 | 0.07        | 0.07 | 0.07 | 0.09       | 0.09 | 0.09 | 0.23       | 0.23 | 0.23 |
| Crit Moves:                                 |             |      |      | ****        |      |      |            | **** |      |            |      | **** |
| Green Time:                                 | 12.8        | 12.8 | 12.8 | 12.8        | 12.8 | 12.8 | 17.3       | 17.3 | 17.3 | 43.9       | 43.9 | 43.9 |
| Volume/Cap:                                 | 0.05        | 0.05 | 0.05 | 0.43        | 0.43 | 0.43 | 0.43       | 0.43 | 0.43 | 0.43       | 0.43 | 0.43 |
| Delay/Veh:                                  | 28.5        | 28.5 | 28.5 | 31.3        | 31.3 | 31.3 | 27.4       | 27.4 | 27.4 | 10.8       | 10.8 | 10.8 |
| User DelAdj:                                | 1.00        | 1.00 | 1.00 | 1.00        | 1.00 | 1.00 | 1.00       | 1.00 | 1.00 | 1.00       | 1.00 | 1.00 |
| AdjDel/Veh:                                 | 28.5        | 28.5 | 28.5 | 31.3        | 31.3 | 31.3 | 27.4       | 27.4 | 27.4 | 10.8       | 10.8 | 10.8 |
| LOS by Move:                                | C           | C    | C    | C           | C    | C    | C          | C    | C    | B          | B    | B    |
| HCM2k95thQ:                                 | 1           | 1    | 1    | 7           | 7    | 7    | 8          | 8    | 8    | 12         | 12   | 12   |

Note: Queue reported is the number of cars per lane.



BART

Level Of Service Computation Report  
 2000 HCM Operations (Future Volume Alternative)  
 PM - Background Conditions

Intersection #3783: SANTA CLARA/17TH [Study Int 9]

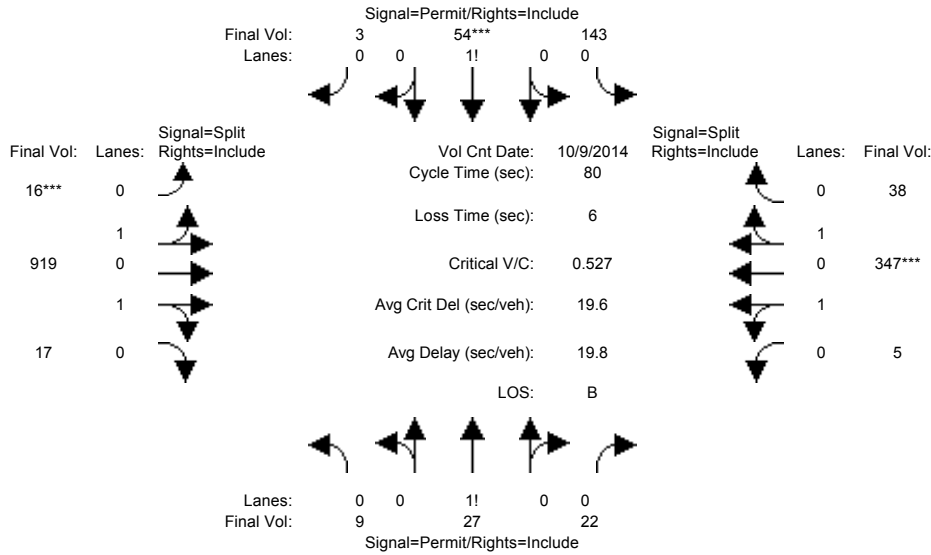

| Approach:                                   | North Bound |      |      | South Bound |      |      | East Bound |      |      | West Bound |      |      |
|---|-------------|------|------|-------------|------|------|------------|------|------|------------|------|------|
| Movement:                                   | L           | T    | R    | L           | T    | R    | L          | T    | R    | L          | T    | R    |
| Min. Green:                                 | 10          | 10   | 10   | 10          | 10   | 10   | 10         | 10   | 10   | 10         | 10   | 10   |
| Y+R:  | 4.0         | 4.0  | 4.0  | 4.0         | 4.0  | 4.0  | 4.0        | 4.0  | 4.0  | 4.0        | 4.0  | 4.0  |
| Volume Module: >> Count Date: 9 Oct 2014 << |             |      |      |             |      |      |            |      |      |            |      |      |
| Base Vol:                                   | 9           | 27   | 22   | 143         | 54   | 3    | 16         | 919  | 17   | 5          | 347  | 38   |
| Growth Adj:                                 | 1.00        | 1.00 | 1.00 | 1.00        | 1.00 | 1.00 | 1.00       | 1.00 | 1.00 | 1.00       | 1.00 | 1.00 |
| Initial Bse:                                | 9           | 27   | 22   | 143         | 54   | 3    | 16         | 919  | 17   | 5          | 347  | 38   |
| Added Vol:                                  | 0           | 0    | 0    | 0           | 0    | 0    | 0          | 0    | 0    | 0          | 0    | 0    |
| PasserByVol:                                | 0           | 0    | 0    | 0           | 0    | 0    | 0          | 0    | 0    | 0          | 0    | 0    |
| Initial Fut:                                | 9           | 27   | 22   | 143         | 54   | 3    | 16         | 919  | 17   | 5          | 347  | 38   |
| User Adj:                                   | 1.00        | 1.00 | 1.00 | 1.00        | 1.00 | 1.00 | 1.00       | 1.00 | 1.00 | 1.00       | 1.00 | 1.00 |
| PHF Adj:                                    | 1.00        | 1.00 | 1.00 | 1.00        | 1.00 | 1.00 | 1.00       | 1.00 | 1.00 | 1.00       | 1.00 | 1.00 |
| PHF Volume:                                 | 9           | 27   | 22   | 143         | 54   | 3    | 16         | 919  | 17   | 5          | 347  | 38   |
| Reduct Vol:                                 | 0           | 0    | 0    | 0           | 0    | 0    | 0          | 0    | 0    | 0          | 0    | 0    |
| Reduced Vol:                                | 9           | 27   | 22   | 143         | 54   | 3    | 16         | 919  | 17   | 5          | 347  | 38   |
| PCE Adj:                                    | 1.00        | 1.00 | 1.00 | 1.00        | 1.00 | 1.00 | 1.00       | 1.00 | 1.00 | 1.00       | 1.00 | 1.00 |
| MLF Adj:                                    | 1.00        | 1.00 | 1.00 | 1.00        | 1.00 | 1.00 | 1.00       | 1.00 | 1.00 | 1.00       | 1.00 | 1.00 |
| FinalVolume:                                | 9           | 27   | 22   | 143         | 54   | 3    | 16         | 919  | 17   | 5          | 347  | 38   |
| Saturation Flow Module:                     |             |      |      |             |      |      |            |      |      |            |      |      |
| Sat/Lane:                                   | 1900        | 1900 | 1900 | 1900        | 1900 | 1900 | 1900       | 1900 | 1900 | 1900       | 1900 | 1900 |
| Adjustment:                                 | 0.92        | 0.92 | 0.92 | 0.92        | 0.92 | 0.92 | 0.95       | 0.95 | 0.95 | 0.95       | 0.95 | 0.95 |
| Lanes:                                      | 0.15        | 0.47 | 0.38 | 0.72        | 0.27 | 0.01 | 0.03       | 1.93 | 0.04 | 0.03       | 1.78 | 0.19 |
| Final Sat.:                                 | 272         | 815  | 664  | 1251        | 473  | 26   | 61         | 3475 | 64   | 46         | 3203 | 351  |
| Capacity Analysis Module:                   |             |      |      |             |      |      |            |      |      |            |      |      |
| Vol/Sat:                                    | 0.03        | 0.03 | 0.03 | 0.11        | 0.11 | 0.11 | 0.26       | 0.26 | 0.26 | 0.11       | 0.11 | 0.11 |
| Crit Moves:                                 |             |      |      | ****        |      |      |            | **** |      |            |      | **** |
| Green Time:                                 | 17.4        | 17.4 | 17.4 | 17.4        | 17.4 | 17.4 | 40.2       | 40.2 | 40.2 | 16.5       | 16.5 | 16.5 |
| Volume/Cap:                                 | 0.15        | 0.15 | 0.15 | 0.53        | 0.53 | 0.53 | 0.53       | 0.53 | 0.53 | 0.53       | 0.53 | 0.53 |
| Delay/Veh:                                  | 25.5        | 25.5 | 25.5 | 29.1        | 29.1 | 29.1 | 13.8       | 13.8 | 13.8 | 29.0       | 29.0 | 29.0 |
| User DelAdj:                                | 1.00        | 1.00 | 1.00 | 1.00        | 1.00 | 1.00 | 1.00       | 1.00 | 1.00 | 1.00       | 1.00 | 1.00 |
| AdjDel/Veh:                                 | 25.5        | 25.5 | 25.5 | 29.1        | 29.1 | 29.1 | 13.8       | 13.8 | 13.8 | 29.0       | 29.0 | 29.0 |
| LOS by Move:                                | C           | C    | C    | C           | C    | C    | B          | B    | B    | C          | C    | C    |
| HCM2k95thQ:                                 | 3           | 3    | 3    | 10          | 10   | 10   | 16         | 16   | 16   | 9          | 9    | 9    |

Note: Queue reported is the number of cars per lane.

BART

Level Of Service Computation Report  
2000 HCM Operations (Future Volume Alternative)  
AM - Background Conditions

Intersection #3788: SANTA CLARA/28TH [Study Int 13]

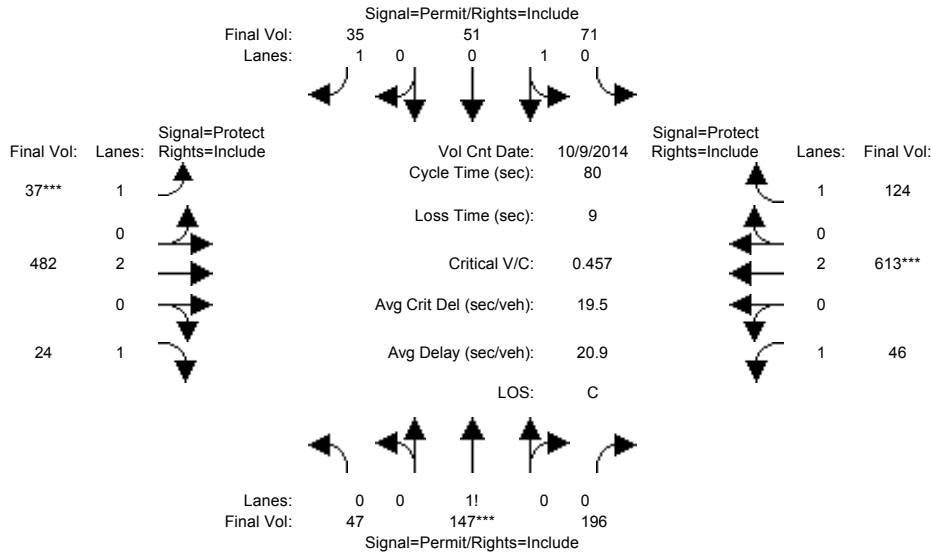

| Approach:                 | North Bound                  |      |      | South Bound |      |      | East Bound |      |      | West Bound |      |      |
|---------------------------|------------------------------|------|------|-------------|------|------|------------|------|------|------------|------|------|
| Movement:                 | L                            | T    | R    | L           | T    | R    | L          | T    | R    | L          | T    | R    |
| Min. Green:               | 10                           | 10   | 10   | 10          | 10   | 10   | 7          | 10   | 10   | 7          | 10   | 10   |
| Y+R:                      | 4.0                          | 4.0  | 4.0  | 4.0         | 4.0  | 4.0  | 4.0        | 4.0  | 4.0  | 4.0        | 4.0  | 4.0  |
| -----                     |                              |      |      |             |      |      |            |      |      |            |      |      |
| Volume Module:            | >> Count Date: 9 Oct 2014 << |      |      |             |      |      |            |      |      |            |      |      |
| Base Vol:                 | 47                           | 147  | 196  | 71          | 51   | 35   | 37         | 482  | 24   | 46         | 613  | 124  |
| Growth Adj:               | 1.00                         | 1.00 | 1.00 | 1.00        | 1.00 | 1.00 | 1.00       | 1.00 | 1.00 | 1.00       | 1.00 | 1.00 |
| Initial Bse:              | 47                           | 147  | 196  | 71          | 51   | 35   | 37         | 482  | 24   | 46         | 613  | 124  |
| Added Vol:                | 0                            | 0    | 0    | 0           | 0    | 0    | 0          | 0    | 0    | 0          | 0    | 0    |
| PasserByVol:              | 0                            | 0    | 0    | 0           | 0    | 0    | 0          | 0    | 0    | 0          | 0    | 0    |
| Initial Fut:              | 47                           | 147  | 196  | 71          | 51   | 35   | 37         | 482  | 24   | 46         | 613  | 124  |
| User Adj:                 | 1.00                         | 1.00 | 1.00 | 1.00        | 1.00 | 1.00 | 1.00       | 1.00 | 1.00 | 1.00       | 1.00 | 1.00 |
| PHF Adj:                  | 1.00                         | 1.00 | 1.00 | 1.00        | 1.00 | 1.00 | 1.00       | 1.00 | 1.00 | 1.00       | 1.00 | 1.00 |
| PHF Volume:               | 47                           | 147  | 196  | 71          | 51   | 35   | 37         | 482  | 24   | 46         | 613  | 124  |
| Reduct Vol:               | 0                            | 0    | 0    | 0           | 0    | 0    | 0          | 0    | 0    | 0          | 0    | 0    |
| Reduced Vol:              | 47                           | 147  | 196  | 71          | 51   | 35   | 37         | 482  | 24   | 46         | 613  | 124  |
| PCE Adj:                  | 1.00                         | 1.00 | 1.00 | 1.00        | 1.00 | 1.00 | 1.00       | 1.00 | 1.00 | 1.00       | 1.00 | 1.00 |
| MLF Adj:                  | 1.00                         | 1.00 | 1.00 | 1.00        | 1.00 | 1.00 | 1.00       | 1.00 | 1.00 | 1.00       | 1.00 | 1.00 |
| Final Volume:             | 47                           | 147  | 196  | 71          | 51   | 35   | 37         | 482  | 24   | 46         | 613  | 124  |
| -----                     |                              |      |      |             |      |      |            |      |      |            |      |      |
| Saturation Flow Module:   |                              |      |      |             |      |      |            |      |      |            |      |      |
| Sat/Lane:                 | 1900                         | 1900 | 1900 | 1900        | 1900 | 1900 | 1900       | 1900 | 1900 | 1900       | 1900 | 1900 |
| Adjustment:               | 0.92                         | 0.92 | 0.92 | 0.95        | 0.95 | 0.92 | 0.92       | 1.00 | 0.92 | 0.92       | 1.00 | 0.92 |
| Lanes:                    | 0.12                         | 0.38 | 0.50 | 0.58        | 0.42 | 1.00 | 1.00       | 2.00 | 1.00 | 1.00       | 2.00 | 1.00 |
| Final Sat.:               | 211                          | 660  | 879  | 1048        | 752  | 1750 | 1750       | 3800 | 1750 | 1750       | 3800 | 1750 |
| -----                     |                              |      |      |             |      |      |            |      |      |            |      |      |
| Capacity Analysis Module: |                              |      |      |             |      |      |            |      |      |            |      |      |
| Vol/Sat:                  | 0.22                         | 0.22 | 0.22 | 0.07        | 0.07 | 0.02 | 0.02       | 0.13 | 0.01 | 0.03       | 0.16 | 0.07 |
| Crit Moves:               | ****                         |      |      | ****        |      |      | ****       |      |      | ****       |      |      |
| Green Time:               | 37.1                         | 37.1 | 37.1 | 37.1        | 37.1 | 37.1 | 7.0        | 20.0 | 20.0 | 13.8       | 26.9 | 26.9 |
| Volume/Cap:               | 0.48                         | 0.48 | 0.48 | 0.15        | 0.15 | 0.04 | 0.24       | 0.51 | 0.05 | 0.15       | 0.48 | 0.21 |
| Delay/Veh:                | 15.2                         | 15.2 | 15.2 | 12.4        | 12.4 | 11.7 | 34.8       | 26.2 | 22.8 | 28.3       | 21.3 | 19.2 |
| User DelAdj:              | 1.00                         | 1.00 | 1.00 | 1.00        | 1.00 | 1.00 | 1.00       | 1.00 | 1.00 | 1.00       | 1.00 | 1.00 |
| AdjDel/Veh:               | 15.2                         | 15.2 | 15.2 | 12.4        | 12.4 | 11.7 | 34.8       | 26.2 | 22.8 | 28.3       | 21.3 | 19.2 |
| LOS by Move:              | B                            | B    | B    | B           | B    | B    | C          | C    | C    | C          | C    | B    |
| HCM2k95thQ:               | 13                           | 13   | 13   | 4           | 4    | 1    | 2          | 10   | 1    | 2          | 11   | 5    |

Note: Queue reported is the number of cars per lane.

BART

Level Of Service Computation Report  
 2000 HCM Operations (Future Volume Alternative)  
 PM - Background Conditions

Intersection #3788: SANTA CLARA/28TH [Study Int 13]

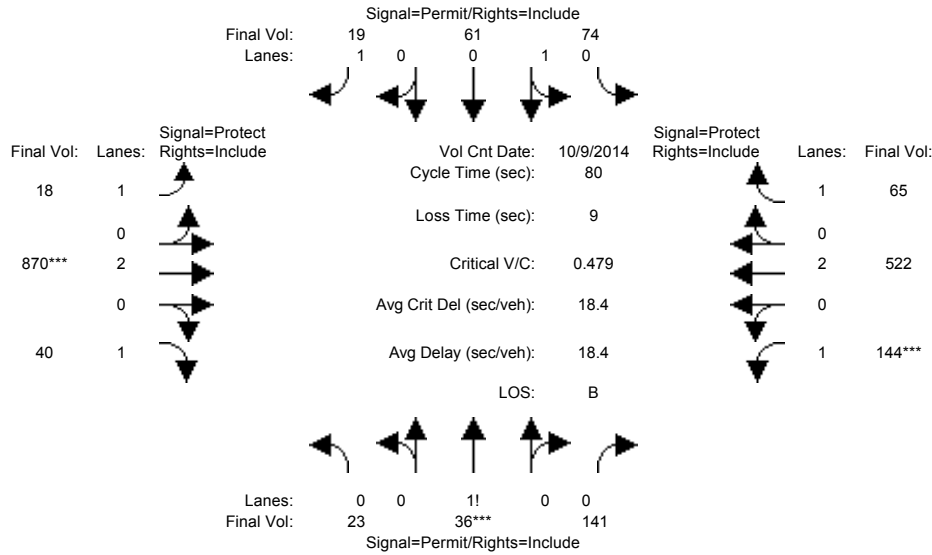

| Approach:                 | North Bound                  |      |      | South Bound |      |      | East Bound |      |      | West Bound |      |      |
|---------------------------|------------------------------|------|------|-------------|------|------|------------|------|------|------------|------|------|
| Movement:                 | L                            | T    | R    | L           | T    | R    | L          | T    | R    | L          | T    | R    |
| Min. Green:               | 10                           | 10   | 10   | 10          | 10   | 10   | 7          | 10   | 10   | 7          | 10   | 10   |
| Y+R:                      | 4.0                          | 4.0  | 4.0  | 4.0         | 4.0  | 4.0  | 4.0        | 4.0  | 4.0  | 4.0        | 4.0  | 4.0  |
| -----                     |                              |      |      |             |      |      |            |      |      |            |      |      |
| Volume Module:            | >> Count Date: 9 Oct 2014 << |      |      |             |      |      |            |      |      |            |      |      |
| Base Vol:                 | 23                           | 36   | 141  | 74          | 61   | 19   | 18         | 870  | 40   | 144        | 522  | 65   |
| Growth Adj:               | 1.00                         | 1.00 | 1.00 | 1.00        | 1.00 | 1.00 | 1.00       | 1.00 | 1.00 | 1.00       | 1.00 | 1.00 |
| Initial Bse:              | 23                           | 36   | 141  | 74          | 61   | 19   | 18         | 870  | 40   | 144        | 522  | 65   |
| Added Vol:                | 0                            | 0    | 0    | 0           | 0    | 0    | 0          | 0    | 0    | 0          | 0    | 0    |
| PasserByVol:              | 0                            | 0    | 0    | 0           | 0    | 0    | 0          | 0    | 0    | 0          | 0    | 0    |
| Initial Fut:              | 23                           | 36   | 141  | 74          | 61   | 19   | 18         | 870  | 40   | 144        | 522  | 65   |
| User Adj:                 | 1.00                         | 1.00 | 1.00 | 1.00        | 1.00 | 1.00 | 1.00       | 1.00 | 1.00 | 1.00       | 1.00 | 1.00 |
| PHF Adj:                  | 1.00                         | 1.00 | 1.00 | 1.00        | 1.00 | 1.00 | 1.00       | 1.00 | 1.00 | 1.00       | 1.00 | 1.00 |
| PHF Volume:               | 23                           | 36   | 141  | 74          | 61   | 19   | 18         | 870  | 40   | 144        | 522  | 65   |
| Reduct Vol:               | 0                            | 0    | 0    | 0           | 0    | 0    | 0          | 0    | 0    | 0          | 0    | 0    |
| Reduced Vol:              | 23                           | 36   | 141  | 74          | 61   | 19   | 18         | 870  | 40   | 144        | 522  | 65   |
| PCE Adj:                  | 1.00                         | 1.00 | 1.00 | 1.00        | 1.00 | 1.00 | 1.00       | 1.00 | 1.00 | 1.00       | 1.00 | 1.00 |
| MLF Adj:                  | 1.00                         | 1.00 | 1.00 | 1.00        | 1.00 | 1.00 | 1.00       | 1.00 | 1.00 | 1.00       | 1.00 | 1.00 |
| Final Volume:             | 23                           | 36   | 141  | 74          | 61   | 19   | 18         | 870  | 40   | 144        | 522  | 65   |
| -----                     |                              |      |      |             |      |      |            |      |      |            |      |      |
| Saturation Flow Module:   |                              |      |      |             |      |      |            |      |      |            |      |      |
| Sat/Lane:                 | 1900                         | 1900 | 1900 | 1900        | 1900 | 1900 | 1900       | 1900 | 1900 | 1900       | 1900 | 1900 |
| Adjustment:               | 0.92                         | 0.92 | 0.92 | 0.95        | 0.95 | 0.92 | 0.92       | 1.00 | 0.92 | 0.92       | 1.00 | 0.92 |
| Lanes:                    | 0.11                         | 0.18 | 0.71 | 0.55        | 0.45 | 1.00 | 1.00       | 2.00 | 1.00 | 1.00       | 2.00 | 1.00 |
| Final Sat.:               | 201                          | 315  | 1234 | 987         | 813  | 1750 | 1750       | 3800 | 1750 | 1750       | 3800 | 1750 |
| -----                     |                              |      |      |             |      |      |            |      |      |            |      |      |
| Capacity Analysis Module: |                              |      |      |             |      |      |            |      |      |            |      |      |
| Vol/Sat:                  | 0.11                         | 0.11 | 0.11 | 0.08        | 0.08 | 0.01 | 0.01       | 0.23 | 0.02 | 0.08       | 0.14 | 0.04 |
| Crit Moves:               | ****                         |      |      | ****        |      |      | ****       |      |      | ****       |      |      |
| Green Time:               | 19.1                         | 19.1 | 19.1 | 19.1        | 19.1 | 19.1 | 20.2       | 38.2 | 38.2 | 13.7       | 31.7 | 31.7 |
| Volume/Cap:               | 0.48                         | 0.48 | 0.48 | 0.31        | 0.31 | 0.05 | 0.04       | 0.48 | 0.05 | 0.48       | 0.35 | 0.09 |
| Delay/Veh:                | 27.1                         | 27.1 | 27.1 | 25.5        | 25.5 | 23.5 | 22.6       | 14.4 | 11.2 | 31.1       | 17.0 | 15.2 |
| User DelAdj:              | 1.00                         | 1.00 | 1.00 | 1.00        | 1.00 | 1.00 | 1.00       | 1.00 | 1.00 | 1.00       | 1.00 | 1.00 |
| AdjDel/Veh:               | 27.1                         | 27.1 | 27.1 | 25.5        | 25.5 | 23.5 | 22.6       | 14.4 | 11.2 | 31.1       | 17.0 | 15.2 |
| LOS by Move:              | C                            | C    | C    | C           | C    | C    | C          | B    | B    | C          | B    | B    |
| HCM2k95thQ:               | 9                            | 9    | 9    | 6           | 6    | 1    | 1          | 13   | 1    | 7          | 9    | 2    |

Note: Queue reported is the number of cars per lane.

BART

Level Of Service Computation Report  
 2000 HCM Operations (Future Volume Alternative)  
 AM - Background Conditions

Intersection #3789: SANTA CLARA/21ST [Study Int 10]

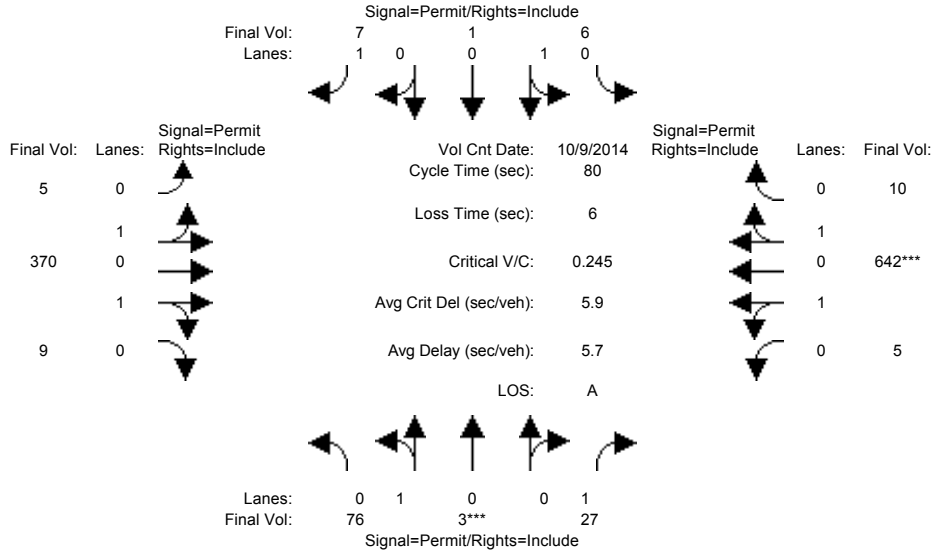

| Approach:                 | North Bound                  |      |      | South Bound |      |      | East Bound |      |      | West Bound |      |      |
|---------------------------|------------------------------|------|------|-------------|------|------|------------|------|------|------------|------|------|
| Movement:                 | L                            | T    | R    | L           | T    | R    | L          | T    | R    | L          | T    | R    |
| Min. Green:               | 10                           | 10   | 10   | 10          | 10   | 10   | 10         | 10   | 10   | 10         | 10   | 10   |
| Y+R:                      | 4.0                          | 4.0  | 4.0  | 4.0         | 4.0  | 4.0  | 4.0        | 4.0  | 4.0  | 4.0        | 4.0  | 4.0  |
| -----                     |                              |      |      |             |      |      |            |      |      |            |      |      |
| Volume Module:            | >> Count Date: 9 Oct 2014 << |      |      |             |      |      |            |      |      |            |      |      |
| Base Vol:                 | 76                           | 3    | 27   | 6           | 1    | 7    | 5          | 370  | 9    | 5          | 642  | 10   |
| Growth Adj:               | 1.00                         | 1.00 | 1.00 | 1.00        | 1.00 | 1.00 | 1.00       | 1.00 | 1.00 | 1.00       | 1.00 | 1.00 |
| Initial Bse:              | 76                           | 3    | 27   | 6           | 1    | 7    | 5          | 370  | 9    | 5          | 642  | 10   |
| Added Vol:                | 0                            | 0    | 0    | 0           | 0    | 0    | 0          | 0    | 0    | 0          | 0    | 0    |
| PasserByVol:              | 0                            | 0    | 0    | 0           | 0    | 0    | 0          | 0    | 0    | 0          | 0    | 0    |
| Initial Fut:              | 76                           | 3    | 27   | 6           | 1    | 7    | 5          | 370  | 9    | 5          | 642  | 10   |
| User Adj:                 | 1.00                         | 1.00 | 1.00 | 1.00        | 1.00 | 1.00 | 1.00       | 1.00 | 1.00 | 1.00       | 1.00 | 1.00 |
| PHF Adj:                  | 1.00                         | 1.00 | 1.00 | 1.00        | 1.00 | 1.00 | 1.00       | 1.00 | 1.00 | 1.00       | 1.00 | 1.00 |
| PHF Volume:               | 76                           | 3    | 27   | 6           | 1    | 7    | 5          | 370  | 9    | 5          | 642  | 10   |
| Reduct Vol:               | 0                            | 0    | 0    | 0           | 0    | 0    | 0          | 0    | 0    | 0          | 0    | 0    |
| Reduced Vol:              | 76                           | 3    | 27   | 6           | 1    | 7    | 5          | 370  | 9    | 5          | 642  | 10   |
| PCE Adj:                  | 1.00                         | 1.00 | 1.00 | 1.00        | 1.00 | 1.00 | 1.00       | 1.00 | 1.00 | 1.00       | 1.00 | 1.00 |
| MLF Adj:                  | 1.00                         | 1.00 | 1.00 | 1.00        | 1.00 | 1.00 | 1.00       | 1.00 | 1.00 | 1.00       | 1.00 | 1.00 |
| FinalVolume:              | 76                           | 3    | 27   | 6           | 1    | 7    | 5          | 370  | 9    | 5          | 642  | 10   |
| -----                     |                              |      |      |             |      |      |            |      |      |            |      |      |
| Saturation Flow Module:   |                              |      |      |             |      |      |            |      |      |            |      |      |
| Sat/Lane:                 | 1900                         | 1900 | 1900 | 1900        | 1900 | 1900 | 1900       | 1900 | 1900 | 1900       | 1900 | 1900 |
| Adjustment:               | 0.95                         | 0.95 | 0.92 | 0.95        | 0.95 | 0.92 | 0.95       | 0.95 | 0.95 | 0.95       | 0.95 | 0.95 |
| Lanes:                    | 0.96                         | 0.04 | 1.00 | 0.86        | 0.14 | 1.00 | 0.02       | 1.93 | 0.05 | 0.02       | 1.95 | 0.03 |
| Final Sat.:               | 1732                         | 68   | 1750 | 1543        | 257  | 1750 | 47         | 3469 | 84   | 27         | 3518 | 55   |
| -----                     |                              |      |      |             |      |      |            |      |      |            |      |      |
| Capacity Analysis Module: |                              |      |      |             |      |      |            |      |      |            |      |      |
| Vol/Sat:                  | 0.04                         | 0.04 | 0.02 | 0.00        | 0.00 | 0.00 | 0.11       | 0.11 | 0.11 | 0.18       | 0.18 | 0.18 |
| Crit Moves:               | *****                        |      |      |             |      |      |            |      |      |            |      |      |
| Green Time:               | 14.3                         | 14.3 | 14.3 | 14.3        | 14.3 | 14.3 | 59.7       | 59.7 | 59.7 | 59.7       | 59.7 | 59.7 |
| Volume/Cap:               | 0.24                         | 0.24 | 0.09 | 0.02        | 0.02 | 0.02 | 0.14       | 0.14 | 0.14 | 0.24       | 0.24 | 0.24 |
| Delay/Veh:                | 28.6                         | 28.6 | 27.5 | 27.1        | 27.1 | 27.1 | 2.9        | 2.9  | 2.9  | 3.2        | 3.2  | 3.2  |
| User DelAdj:              | 1.00                         | 1.00 | 1.00 | 1.00        | 1.00 | 1.00 | 1.00       | 1.00 | 1.00 | 1.00       | 1.00 | 1.00 |
| AdjDel/Veh:               | 28.6                         | 28.6 | 27.5 | 27.1        | 27.1 | 27.1 | 2.9        | 2.9  | 2.9  | 3.2        | 3.2  | 3.2  |
| LOS by Move:              | C                            | C    | C    | C           | C    | C    | A          | A    | A    | A          | A    | A    |
| HCM2k95thQ:               | 4                            | 4    | 1    | 0           | 0    | 0    | 3          | 3    | 3    | 5          | 5    | 5    |

Note: Queue reported is the number of cars per lane.

BART

Level Of Service Computation Report  
 2000 HCM Operations (Future Volume Alternative)  
 PM - Background Conditions

Intersection #3789: SANTA CLARA/21ST [Study Int 10]

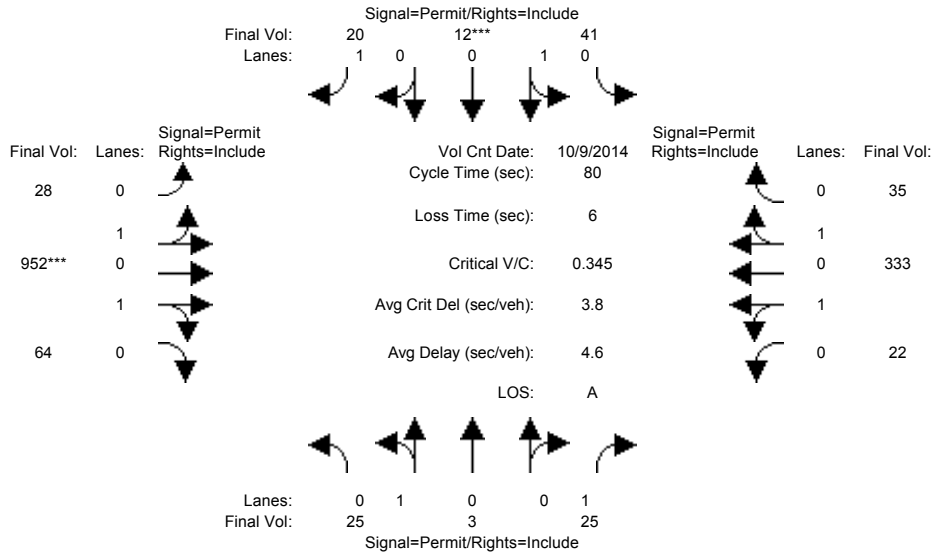

| Approach:                                   | North Bound |      |      | South Bound |      |      | East Bound |      |      | West Bound |      |      |
|---|-------------|------|------|-------------|------|------|------------|------|------|------------|------|------|
| Movement:                                   | L           | T    | R    | L           | T    | R    | L          | T    | R    | L          | T    | R    |
| Min. Green:                                 | 10          | 10   | 10   | 10          | 10   | 10   | 10         | 10   | 10   | 10         | 10   | 10   |
| Y+R:  | 4.0         | 4.0  | 4.0  | 4.0         | 4.0  | 4.0  | 4.0        | 4.0  | 4.0  | 4.0        | 4.0  | 4.0  |
| Volume Module: >> Count Date: 9 Oct 2014 << |             |      |      |             |      |      |            |      |      |            |      |      |
| Base Vol:                                   | 25          | 3    | 25   | 41          | 12   | 20   | 28         | 952  | 64   | 22         | 333  | 35   |
| Growth Adj:                                 | 1.00        | 1.00 | 1.00 | 1.00        | 1.00 | 1.00 | 1.00       | 1.00 | 1.00 | 1.00       | 1.00 | 1.00 |
| Initial Bse:                                | 25          | 3    | 25   | 41          | 12   | 20   | 28         | 952  | 64   | 22         | 333  | 35   |
| Added Vol:                                  | 0           | 0    | 0    | 0           | 0    | 0    | 0          | 0    | 0    | 0          | 0    | 0    |
| PasserByVol:                                | 0           | 0    | 0    | 0           | 0    | 0    | 0          | 0    | 0    | 0          | 0    | 0    |
| Initial Fut:                                | 25          | 3    | 25   | 41          | 12   | 20   | 28         | 952  | 64   | 22         | 333  | 35   |
| User Adj:                                   | 1.00        | 1.00 | 1.00 | 1.00        | 1.00 | 1.00 | 1.00       | 1.00 | 1.00 | 1.00       | 1.00 | 1.00 |
| PHF Adj:                                    | 1.00        | 1.00 | 1.00 | 1.00        | 1.00 | 1.00 | 1.00       | 1.00 | 1.00 | 1.00       | 1.00 | 1.00 |
| PHF Volume:                                 | 25          | 3    | 25   | 41          | 12   | 20   | 28         | 952  | 64   | 22         | 333  | 35   |
| Reduct Vol:                                 | 0           | 0    | 0    | 0           | 0    | 0    | 0          | 0    | 0    | 0          | 0    | 0    |
| Reduced Vol:                                | 25          | 3    | 25   | 41          | 12   | 20   | 28         | 952  | 64   | 22         | 333  | 35   |
| PCE Adj:                                    | 1.00        | 1.00 | 1.00 | 1.00        | 1.00 | 1.00 | 1.00       | 1.00 | 1.00 | 1.00       | 1.00 | 1.00 |
| MLF Adj:                                    | 1.00        | 1.00 | 1.00 | 1.00        | 1.00 | 1.00 | 1.00       | 1.00 | 1.00 | 1.00       | 1.00 | 1.00 |
| Final Volume:                               | 25          | 3    | 25   | 41          | 12   | 20   | 28         | 952  | 64   | 22         | 333  | 35   |
| Saturation Flow Module:                     |             |      |      |             |      |      |            |      |      |            |      |      |
| Sat/Lane:                                   | 1900        | 1900 | 1900 | 1900        | 1900 | 1900 | 1900       | 1900 | 1900 | 1900       | 1900 | 1900 |
| Adjustment:                                 | 0.95        | 0.95 | 0.92 | 0.95        | 0.95 | 0.92 | 0.95       | 0.95 | 0.95 | 0.95       | 0.95 | 0.95 |
| Lanes:                                      | 0.89        | 0.11 | 1.00 | 0.77        | 0.23 | 1.00 | 0.05       | 1.83 | 0.12 | 0.11       | 1.71 | 0.18 |
| Final Sat.:                                 | 1607        | 193  | 1750 | 1392        | 408  | 1750 | 97         | 3283 | 221  | 203        | 3074 | 323  |
| Capacity Analysis Module:                   |             |      |      |             |      |      |            |      |      |            |      |      |
| Vol/Sat:                                    | 0.02        | 0.02 | 0.01 | 0.03        | 0.03 | 0.01 | 0.29       | 0.29 | 0.29 | 0.11       | 0.11 | 0.11 |
| Crit Moves:                                 | *****       |      |      |             |      |      |            |      |      |            |      |      |
| Green Time:                                 | 10.0        | 10.0 | 10.0 | 10.0        | 10.0 | 10.0 | 64.0       | 64.0 | 64.0 | 64.0       | 64.0 | 64.0 |
| Volume/Cap:                                 | 0.12        | 0.12 | 0.11 | 0.24        | 0.24 | 0.09 | 0.36       | 0.36 | 0.36 | 0.14       | 0.14 | 0.14 |
| Delay/Veh:                                  | 31.4        | 31.4 | 31.3 | 32.1        | 32.1 | 31.2 | 2.3        | 2.3  | 2.3  | 1.8        | 1.8  | 1.8  |
| User DelAdj:                                | 1.00        | 1.00 | 1.00 | 1.00        | 1.00 | 1.00 | 1.00       | 1.00 | 1.00 | 1.00       | 1.00 | 1.00 |
| AdjDel/Veh:                                 | 31.4        | 31.4 | 31.3 | 32.1        | 32.1 | 31.2 | 2.3        | 2.3  | 2.3  | 1.8        | 1.8  | 1.8  |
| LOS by Move:                                | C           | C    | C    | C           | C    | C    | A          | A    | A    | A          | A    | A    |
| HCM2k95thQ:                                 | 2           | 2    | 1    | 3           | 3    | 1    | 8          | 8    | 8    | 2          | 2    | 2    |

Note: Queue reported is the number of cars per lane.

BART

Level Of Service Computation Report  
2000 HCM Operations (Future Volume Alternative)  
AM - Background Conditions

Intersection #3790: SANTA CLARA/24TH [Study Int 11]

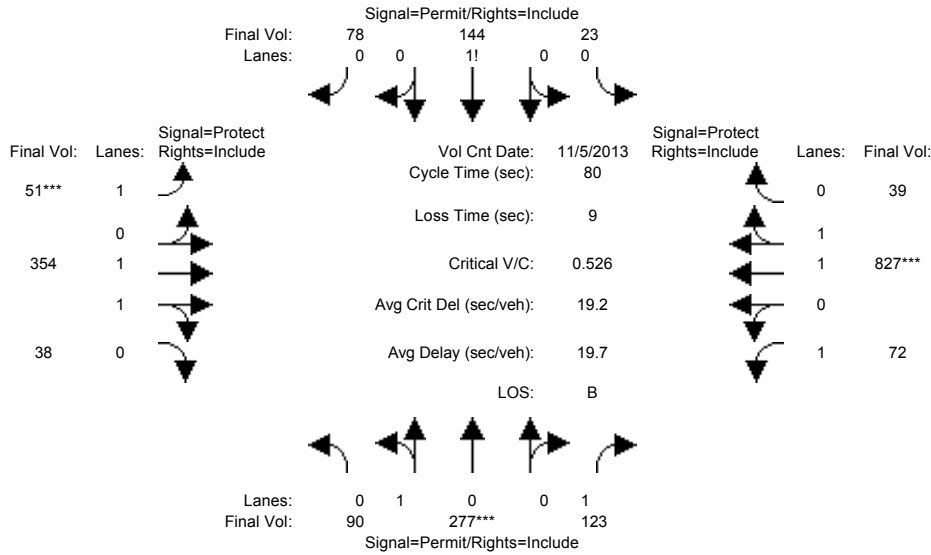

| Approach:                 | North Bound   |      |      | South Bound |      |      | East Bound |      |      | West Bound |      |      |
|---------------------------|---|------|------|-------------|------|------|------------|------|------|------------|------|------|
| Movement:                 | L   | T    | R    | L           | T    | R    | L          | T    | R    | L          | T    | R    |
| Min. Green:               | 10  | 10   | 10   | 10          | 10   | 10   | 7          | 10   | 10   | 7          | 10   | 10   |
| Y+R:                      | 4.0   | 4.0  | 4.0  | 4.0         | 4.0  | 4.0  | 4.0        | 4.0  | 4.0  | 4.0        | 4.0  | 4.0  |
| Volume Module:            | Count Date: 5 Nov 2013  |      |      |             |      |      |            |      |      |            |      |      |
| Base Vol:                 | 90  | 277  | 123  | 23          | 144  | 78   | 51         | 354  | 38   | 72         | 827  | 39   |
| Growth Adj:               | 1.00  | 1.00 | 1.00 | 1.00        | 1.00 | 1.00 | 1.00       | 1.00 | 1.00 | 1.00       | 1.00 | 1.00 |
| Initial Bse:              | 90  | 277  | 123  | 23          | 144  | 78   | 51         | 354  | 38   | 72         | 827  | 39   |
| Added Vol:                | 0   | 0    | 0    | 0           | 0    | 0    | 0          | 0    | 0    | 0          | 0    | 0    |
| PasserByVol:              | 0   | 0    | 0    | 0           | 0    | 0    | 0          | 0    | 0    | 0          | 0    | 0    |
| Initial Fut:              | 90  | 277  | 123  | 23          | 144  | 78   | 51         | 354  | 38   | 72         | 827  | 39   |
| User Adj:                 | 1.00  | 1.00 | 1.00 | 1.00        | 1.00 | 1.00 | 1.00       | 1.00 | 1.00 | 1.00       | 1.00 | 1.00 |
| PHF Adj:                  | 1.00  | 1.00 | 1.00 | 1.00        | 1.00 | 1.00 | 1.00       | 1.00 | 1.00 | 1.00       | 1.00 | 1.00 |
| PHF Volume:               | 90  | 277  | 123  | 23          | 144  | 78   | 51         | 354  | 38   | 72         | 827  | 39   |
| Reduct Vol:               | 0   | 0    | 0    | 0           | 0    | 0    | 0          | 0    | 0    | 0          | 0    | 0    |
| Reduced Vol:              | 90  | 277  | 123  | 23          | 144  | 78   | 51         | 354  | 38   | 72         | 827  | 39   |
| PCE Adj:                  | 1.00  | 1.00 | 1.00 | 1.00        | 1.00 | 1.00 | 1.00       | 1.00 | 1.00 | 1.00       | 1.00 | 1.00 |
| MLF Adj:                  | 1.00  | 1.00 | 1.00 | 1.00        | 1.00 | 1.00 | 1.00       | 1.00 | 1.00 | 1.00       | 1.00 | 1.00 |
| Final Volume:             | 90  | 277  | 123  | 23          | 144  | 78   | 51         | 354  | 38   | 72         | 827  | 39   |
| Saturation Flow Module:   | Sat/Lane: 1900 1900 1900 1900 1900 1900 1900 1900 1900 1900 1900 1900 |      |      |             |      |      |            |      |      |            |      |      |
| Adjustment:               | 0.95  | 0.95 | 0.92 | 0.92        | 0.92 | 0.92 | 0.92       | 0.98 | 0.95 | 0.92       | 0.97 | 0.95 |
| Lanes:                    | 0.25  | 0.75 | 1.00 | 0.09        | 0.59 | 0.32 | 1.00       | 1.80 | 0.20 | 1.00       | 1.91 | 0.09 |
| Final Sat.:               | 441   | 1359 | 1750 | 164         | 1029 | 557  | 1750       | 3341 | 359  | 1750       | 3533 | 167  |
| Capacity Analysis Module: | Vol/Sat: 0.20 0.20 0.07 0.14 0.14 0.14 0.03 0.11 0.11 0.04 0.23 0.23  |      |      |             |      |      |            |      |      |            |      |      |
| Crit Moves:               | *****   |      |      |             |      |      |            |      |      |            |      |      |
| Green Time:               | 29.8  | 29.8 | 29.8 | 29.8        | 29.8 | 29.8 | 7.0        | 24.2 | 24.2 | 17.0       | 34.2 | 34.2 |
| Volume/Cap:               | 0.55  | 0.55 | 0.19 | 0.38        | 0.38 | 0.38 | 0.33       | 0.35 | 0.35 | 0.19       | 0.55 | 0.55 |
| Delay/Veh:                | 20.7  | 20.7 | 17.1 | 18.7        | 18.7 | 18.7 | 35.6       | 21.9 | 21.9 | 26.2       | 17.5 | 17.5 |
| User DelAdj:              | 1.00  | 1.00 | 1.00 | 1.00        | 1.00 | 1.00 | 1.00       | 1.00 | 1.00 | 1.00       | 1.00 | 1.00 |
| AdjDel/Veh:               | 20.7  | 20.7 | 17.1 | 18.7        | 18.7 | 18.7 | 35.6       | 21.9 | 21.9 | 26.2       | 17.5 | 17.5 |
| LOS by Move:              | C   | C    | B    | B           | B    | B    | D          | C    | C    | C          | B    | B    |
| HCM2k95thQ:               | 14  | 14   | 4    | 10          | 10   | 10   | 3          | 7    | 7    | 3          | 15   | 15   |

Note: Queue reported is the number of cars per lane.

BART

Level Of Service Computation Report  
 2000 HCM Operations (Future Volume Alternative)  
 PM - Background Conditions

Intersection #3790: SANTA CLARA/24TH [Study Int 11]

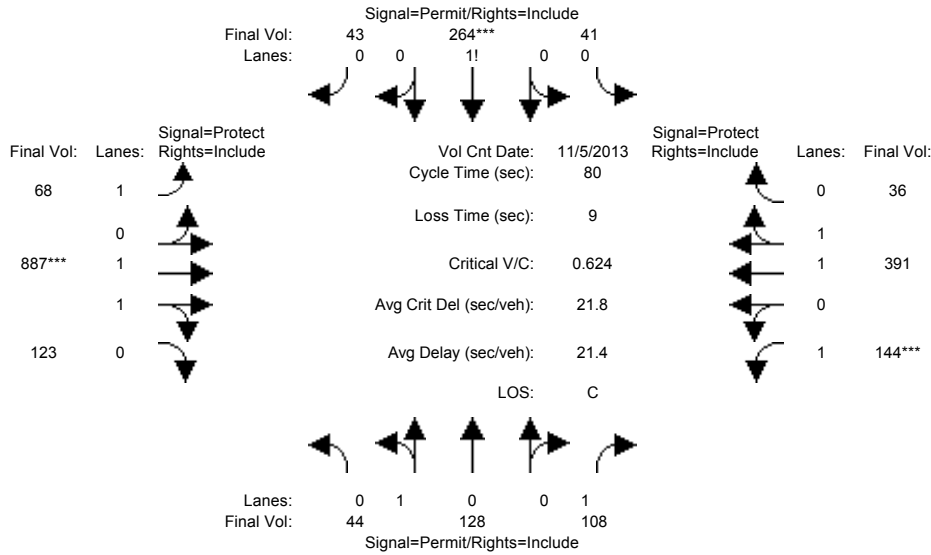

| Approach:                                   | North Bound |      |      | South Bound |      |      | East Bound |      |      | West Bound |      |      |
|---|-------------|------|------|-------------|------|------|------------|------|------|------------|------|------|
| Movement:                                   | L           | T    | R    | L           | T    | R    | L          | T    | R    | L          | T    | R    |
| Min. Green:                                 | 10          | 10   | 10   | 10          | 10   | 10   | 7          | 10   | 10   | 7          | 10   | 10   |
| Y+R:  | 4.0         | 4.0  | 4.0  | 4.0         | 4.0  | 4.0  | 4.0        | 4.0  | 4.0  | 4.0        | 4.0  | 4.0  |
| Volume Module: >> Count Date: 5 Nov 2013 << |             |      |      |             |      |      |            |      |      |            |      |      |
| Base Vol:                                   | 44          | 128  | 108  | 41          | 264  | 43   | 68         | 887  | 123  | 144        | 391  | 36   |
| Growth Adj:                                 | 1.00        | 1.00 | 1.00 | 1.00        | 1.00 | 1.00 | 1.00       | 1.00 | 1.00 | 1.00       | 1.00 | 1.00 |
| Initial Bse:                                | 44          | 128  | 108  | 41          | 264  | 43   | 68         | 887  | 123  | 144        | 391  | 36   |
| Added Vol:                                  | 0           | 0    | 0    | 0           | 0    | 0    | 0          | 0    | 0    | 0          | 0    | 0    |
| PasserByVol:                                | 0           | 0    | 0    | 0           | 0    | 0    | 0          | 0    | 0    | 0          | 0    | 0    |
| Initial Fut:                                | 44          | 128  | 108  | 41          | 264  | 43   | 68         | 887  | 123  | 144        | 391  | 36   |
| User Adj:                                   | 1.00        | 1.00 | 1.00 | 1.00        | 1.00 | 1.00 | 1.00       | 1.00 | 1.00 | 1.00       | 1.00 | 1.00 |
| PHF Adj:                                    | 1.00        | 1.00 | 1.00 | 1.00        | 1.00 | 1.00 | 1.00       | 1.00 | 1.00 | 1.00       | 1.00 | 1.00 |
| PHF Volume:                                 | 44          | 128  | 108  | 41          | 264  | 43   | 68         | 887  | 123  | 144        | 391  | 36   |
| Reduct Vol:                                 | 0           | 0    | 0    | 0           | 0    | 0    | 0          | 0    | 0    | 0          | 0    | 0    |
| Reduced Vol:                                | 44          | 128  | 108  | 41          | 264  | 43   | 68         | 887  | 123  | 144        | 391  | 36   |
| PCE Adj:                                    | 1.00        | 1.00 | 1.00 | 1.00        | 1.00 | 1.00 | 1.00       | 1.00 | 1.00 | 1.00       | 1.00 | 1.00 |
| MLF Adj:                                    | 1.00        | 1.00 | 1.00 | 1.00        | 1.00 | 1.00 | 1.00       | 1.00 | 1.00 | 1.00       | 1.00 | 1.00 |
| Final Volume:                               | 44          | 128  | 108  | 41          | 264  | 43   | 68         | 887  | 123  | 144        | 391  | 36   |
| Saturation Flow Module:                     |             |      |      |             |      |      |            |      |      |            |      |      |
| Sat/Lane:                                   | 1900        | 1900 | 1900 | 1900        | 1900 | 1900 | 1900       | 1900 | 1900 | 1900       | 1900 | 1900 |
| Adjustment:                                 | 0.95        | 0.95 | 0.92 | 0.92        | 0.92 | 0.92 | 0.92       | 0.98 | 0.95 | 0.92       | 0.98 | 0.95 |
| Lanes:                                      | 0.26        | 0.74 | 1.00 | 0.12        | 0.76 | 0.12 | 1.00       | 1.75 | 0.25 | 1.00       | 1.83 | 0.17 |
| Final Sat.:                                 | 460         | 1340 | 1750 | 206         | 1328 | 216  | 1750       | 3249 | 451  | 1750       | 3388 | 312  |
| Capacity Analysis Module:                   |             |      |      |             |      |      |            |      |      |            |      |      |
| Vol/Sat:                                    | 0.10        | 0.10 | 0.06 | 0.20        | 0.20 | 0.20 | 0.04       | 0.27 | 0.27 | 0.08       | 0.12 | 0.12 |
| Crit Moves:                                 | *****       |      |      |             |      |      |            |      |      |            |      |      |
| Green Time:                                 | 25.5        | 25.5 | 25.5 | 25.5        | 25.5 | 25.5 | 18.7       | 35.0 | 35.0 | 10.5       | 26.8 | 26.8 |
| Volume/Cap:                                 | 0.30        | 0.30 | 0.19 | 0.62        | 0.62 | 0.62 | 0.17       | 0.62 | 0.62 | 0.62       | 0.34 | 0.34 |
| Delay/Veh:                                  | 20.8        | 20.8 | 20.0 | 25.4        | 25.4 | 25.4 | 24.6       | 18.2 | 18.2 | 38.1       | 20.2 | 20.2 |
| User DelAdj:                                | 1.00        | 1.00 | 1.00 | 1.00        | 1.00 | 1.00 | 1.00       | 1.00 | 1.00 | 1.00       | 1.00 | 1.00 |
| AdjDel/Veh:                                 | 20.8        | 20.8 | 20.0 | 25.4        | 25.4 | 25.4 | 24.6       | 18.2 | 18.2 | 38.1       | 20.2 | 20.2 |
| LOS by Move:                                | C           | C    | B    | C           | C    | C    | C          | B    | B    | D          | C    | C    |
| HCM2k95thQ:                                 | 6           | 6    | 4    | 16          | 16   | 16   | 3          | 18   | 18   | 7          | 8    | 8    |

Note: Queue reported is the number of cars per lane.

BART

Level Of Service Computation Report  
 2000 HCM Operations (Future Volume Alternative)  
 AM - Background Conditions

Intersection #3832: 24TH/WILLIAM [Study Int 24]

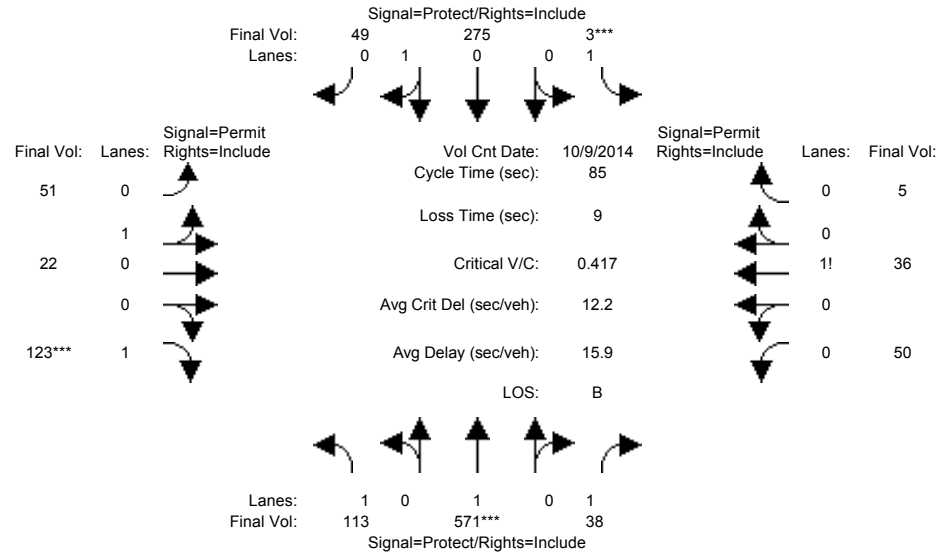

| Approach:                                   | North Bound |      |      | South Bound |      |      | East Bound |      |      | West Bound |      |      |
|---|-------------|------|------|-------------|------|------|------------|------|------|------------|------|------|
| Movement:                                   | L           | T    | R    | L           | T    | R    | L          | T    | R    | L          | T    | R    |
| Min. Green:                                 | 7           | 10   | 10   | 7           | 10   | 10   | 10         | 10   | 10   | 10         | 10   | 10   |
| Y+R:  | 4.0         | 4.0  | 4.0  | 4.0         | 4.0  | 4.0  | 4.0        | 4.0  | 4.0  | 4.0        | 4.0  | 4.0  |
| Volume Module: >> Count Date: 9 Oct 2014 << |             |      |      |             |      |      |            |      |      |            |      |      |
| Base Vol:                                   | 113         | 571  | 38   | 3           | 275  | 49   | 51         | 22   | 123  | 50         | 36   | 5    |
| Growth Adj:                                 | 1.00        | 1.00 | 1.00 | 1.00        | 1.00 | 1.00 | 1.00       | 1.00 | 1.00 | 1.00       | 1.00 | 1.00 |
| Initial Bse:                                | 113         | 571  | 38   | 3           | 275  | 49   | 51         | 22   | 123  | 50         | 36   | 5    |
| Added Vol:                                  | 0           | 0    | 0    | 0           | 0    | 0    | 0          | 0    | 0    | 0          | 0    | 0    |
| PasserByVol:                                | 0           | 0    | 0    | 0           | 0    | 0    | 0          | 0    | 0    | 0          | 0    | 0    |
| Initial Fut:                                | 113         | 571  | 38   | 3           | 275  | 49   | 51         | 22   | 123  | 50         | 36   | 5    |
| User Adj:                                   | 1.00        | 1.00 | 1.00 | 1.00        | 1.00 | 1.00 | 1.00       | 1.00 | 1.00 | 1.00       | 1.00 | 1.00 |
| PHF Adj:                                    | 1.00        | 1.00 | 1.00 | 1.00        | 1.00 | 1.00 | 1.00       | 1.00 | 1.00 | 1.00       | 1.00 | 1.00 |
| PHF Volume:                                 | 113         | 571  | 38   | 3           | 275  | 49   | 51         | 22   | 123  | 50         | 36   | 5    |
| Reduct Vol:                                 | 0           | 0    | 0    | 0           | 0    | 0    | 0          | 0    | 0    | 0          | 0    | 0    |
| Reduced Vol:                                | 113         | 571  | 38   | 3           | 275  | 49   | 51         | 22   | 123  | 50         | 36   | 5    |
| PCE Adj:                                    | 1.00        | 1.00 | 1.00 | 1.00        | 1.00 | 1.00 | 1.00       | 1.00 | 1.00 | 1.00       | 1.00 | 1.00 |
| MLF Adj:                                    | 1.00        | 1.00 | 1.00 | 1.00        | 1.00 | 1.00 | 1.00       | 1.00 | 1.00 | 1.00       | 1.00 | 1.00 |
| Final Volume:                               | 113         | 571  | 38   | 3           | 275  | 49   | 51         | 22   | 123  | 50         | 36   | 5    |
| Saturation Flow Module:                     |             |      |      |             |      |      |            |      |      |            |      |      |
| Sat/Lane:                                   | 1900        | 1900 | 1900 | 1900        | 1900 | 1900 | 1900       | 1900 | 1900 | 1900       | 1900 | 1900 |
| Adjustment:                                 | 0.92        | 1.00 | 0.92 | 0.92        | 0.95 | 0.95 | 0.95       | 0.95 | 0.92 | 0.92       | 0.92 | 0.92 |
| Lanes:                                      | 1.00        | 1.00 | 1.00 | 1.00        | 0.85 | 0.15 | 0.70       | 0.30 | 1.00 | 0.55       | 0.40 | 0.05 |
| Final Sat.:                                 | 1750        | 1900 | 1750 | 1750        | 1528 | 272  | 1258       | 542  | 1750 | 962        | 692  | 96   |
| Capacity Analysis Module:                   |             |      |      |             |      |      |            |      |      |            |      |      |
| Vol/Sat:                                    | 0.06        | 0.30 | 0.02 | 0.00        | 0.18 | 0.18 | 0.04       | 0.04 | 0.07 | 0.05       | 0.05 | 0.05 |
| Crit Moves:                                 | ****        | **** | **** | ****        | **** | **** | ****       | **** | **** | ****       | **** | **** |
| Green Time:                                 | 19.8        | 55.9 | 55.9 | 7.0         | 43.2 | 43.2 | 13.1       | 13.1 | 13.1 | 13.1       | 13.1 | 13.1 |
| Volume/Cap:                                 | 0.28        | 0.46 | 0.03 | 0.02        | 0.35 | 0.35 | 0.26       | 0.26 | 0.46 | 0.34       | 0.34 | 0.34 |
| Delay/Veh:                                  | 27.1        | 7.4  | 5.1  | 35.9        | 12.8 | 12.8 | 32.2       | 32.2 | 34.0 | 32.8       | 32.8 | 32.8 |
| User DelAdj:                                | 1.00        | 1.00 | 1.00 | 1.00        | 1.00 | 1.00 | 1.00       | 1.00 | 1.00 | 1.00       | 1.00 | 1.00 |
| AdjDel/Veh:                                 | 27.1        | 7.4  | 5.1  | 35.9        | 12.8 | 12.8 | 32.2       | 32.2 | 34.0 | 32.8       | 32.8 | 32.8 |
| LOS by Move:                                | C           | A    | A    | D           | B    | B    | C          | C    | C    | C          | C    | C    |
| HCM2k95thQ:                                 | 5           | 14   | 1    | 0           | 10   | 10   | 4          | 4    | 7    | 5          | 5    | 5    |

Note: Queue reported is the number of cars per lane.



BART

Level Of Service Computation Report  
2000 HCM Operations (Future Volume Alternative)  
PM - Background Conditions

Intersection #3832: 24TH/WILLIAM [Study Int 24]

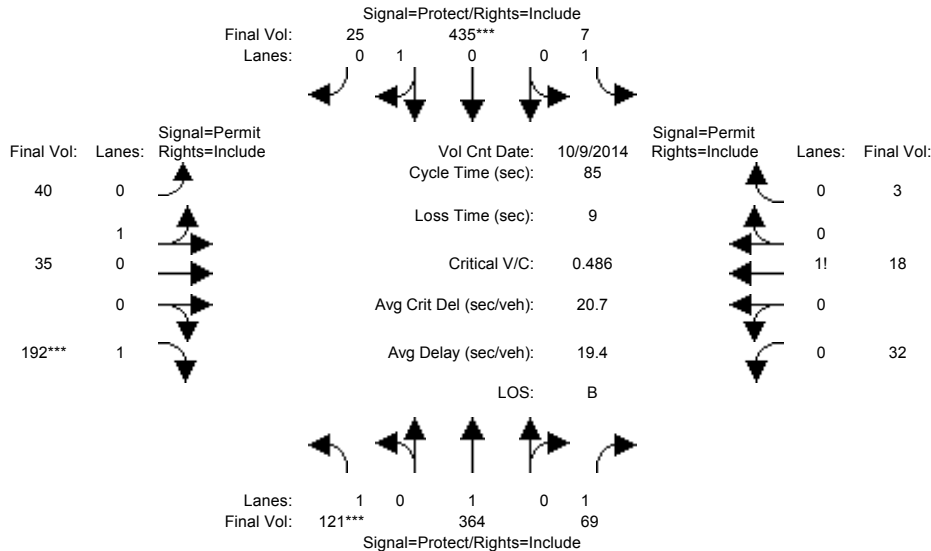

| Approach:                                   | North Bound |      |      | South Bound |      |      | East Bound |      |      | West Bound |      |      |
|---|-------------|------|------|-------------|------|------|------------|------|------|------------|------|------|
| Movement:                                   | L           | T    | R    | L           | T    | R    | L          | T    | R    | L          | T    | R    |
| Min. Green:                                 | 7           | 10   | 10   | 7           | 10   | 10   | 10         | 10   | 10   | 10         | 10   | 10   |
| Y+R:  | 4.0         | 4.0  | 4.0  | 4.0         | 4.0  | 4.0  | 4.0        | 4.0  | 4.0  | 4.0        | 4.0  | 4.0  |
| Volume Module: >> Count Date: 9 Oct 2014 << |             |      |      |             |      |      |            |      |      |            |      |      |
| Base Vol:                                   | 121         | 364  | 69   | 7           | 435  | 25   | 40         | 35   | 192  | 32         | 18   | 3    |
| Growth Adj:                                 | 1.00        | 1.00 | 1.00 | 1.00        | 1.00 | 1.00 | 1.00       | 1.00 | 1.00 | 1.00       | 1.00 | 1.00 |
| Initial Bse:                                | 121         | 364  | 69   | 7           | 435  | 25   | 40         | 35   | 192  | 32         | 18   | 3    |
| Added Vol:                                  | 0           | 0    | 0    | 0           | 0    | 0    | 0          | 0    | 0    | 0          | 0    | 0    |
| PasserByVol:                                | 0           | 0    | 0    | 0           | 0    | 0    | 0          | 0    | 0    | 0          | 0    | 0    |
| Initial Fut:                                | 121         | 364  | 69   | 7           | 435  | 25   | 40         | 35   | 192  | 32         | 18   | 3    |
| User Adj:                                   | 1.00        | 1.00 | 1.00 | 1.00        | 1.00 | 1.00 | 1.00       | 1.00 | 1.00 | 1.00       | 1.00 | 1.00 |
| PHF Adj:                                    | 1.00        | 1.00 | 1.00 | 1.00        | 1.00 | 1.00 | 1.00       | 1.00 | 1.00 | 1.00       | 1.00 | 1.00 |
| PHF Volume:                                 | 121         | 364  | 69   | 7           | 435  | 25   | 40         | 35   | 192  | 32         | 18   | 3    |
| Reduct Vol:                                 | 0           | 0    | 0    | 0           | 0    | 0    | 0          | 0    | 0    | 0          | 0    | 0    |
| Reduced Vol:                                | 121         | 364  | 69   | 7           | 435  | 25   | 40         | 35   | 192  | 32         | 18   | 3    |
| PCE Adj:                                    | 1.00        | 1.00 | 1.00 | 1.00        | 1.00 | 1.00 | 1.00       | 1.00 | 1.00 | 1.00       | 1.00 | 1.00 |
| MLF Adj:                                    | 1.00        | 1.00 | 1.00 | 1.00        | 1.00 | 1.00 | 1.00       | 1.00 | 1.00 | 1.00       | 1.00 | 1.00 |
| Final Volume:                               | 121         | 364  | 69   | 7           | 435  | 25   | 40         | 35   | 192  | 32         | 18   | 3    |
| Saturation Flow Module:                     |             |      |      |             |      |      |            |      |      |            |      |      |
| Sat/Lane:                                   | 1900        | 1900 | 1900 | 1900        | 1900 | 1900 | 1900       | 1900 | 1900 | 1900       | 1900 | 1900 |
| Adjustment:                                 | 0.92        | 1.00 | 0.92 | 0.92        | 0.95 | 0.95 | 0.95       | 0.95 | 0.92 | 0.92       | 0.92 | 0.92 |
| Lanes:                                      | 1.00        | 1.00 | 1.00 | 1.00        | 0.95 | 0.05 | 0.53       | 0.47 | 1.00 | 0.60       | 0.34 | 0.06 |
| Final Sat.:                                 | 1750        | 1900 | 1750 | 1750        | 1702 | 98   | 960        | 840  | 1750 | 1057       | 594  | 99   |
| Capacity Analysis Module:                   |             |      |      |             |      |      |            |      |      |            |      |      |
| Vol/Sat:                                    | 0.07        | 0.19 | 0.04 | 0.00        | 0.26 | 0.26 | 0.04       | 0.04 | 0.11 | 0.03       | 0.03 | 0.03 |
| Crit Moves:                                 | ****        | **** | **** | ****        | **** | **** | ****       | **** | **** | ****       | **** | **** |
| Green Time:                                 | 12.1        | 39.7 | 39.7 | 17.1        | 44.7 | 44.7 | 19.2       | 19.2 | 19.2 | 19.2       | 19.2 | 19.2 |
| Volume/Cap:                                 | 0.49        | 0.41 | 0.08 | 0.02        | 0.49 | 0.49 | 0.18       | 0.18 | 0.49 | 0.13       | 0.13 | 0.13 |
| Delay/Veh:                                  | 35.1        | 15.2 | 12.6 | 27.3        | 13.2 | 13.2 | 26.8       | 26.8 | 29.6 | 26.4       | 26.4 | 26.4 |
| User DelAdj:                                | 1.00        | 1.00 | 1.00 | 1.00        | 1.00 | 1.00 | 1.00       | 1.00 | 1.00 | 1.00       | 1.00 | 1.00 |
| AdjDel/Veh:                                 | 35.1        | 15.2 | 12.6 | 27.3        | 13.2 | 13.2 | 26.8       | 26.8 | 29.6 | 26.4       | 26.4 | 26.4 |
| LOS by Move:                                | D           | B    | B    | C           | B    | B    | C          | C    | C    | C          | C    | C    |
| HCM2k95thQ:                                 | 6           | 12   | 2    | 0           | 15   | 15   | 4          | 4    | 10   | 3          | 3    | 3    |

Note: Queue reported is the number of cars per lane.

BART

Level Of Service Computation Report  
2000 HCM Operations (Future Volume Alternative)  
AM - Background Conditions

Intersection #4005: JULIAN/28TH [Study Int 3]

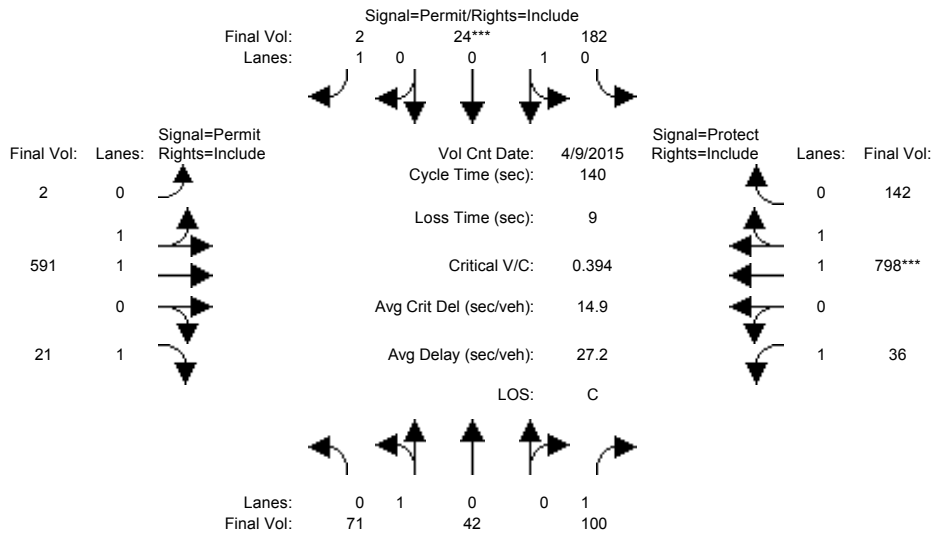

| Approach:                                   | North Bound |      |      | South Bound |      |      | East Bound |      |      | West Bound |      |       |
|---|-------------|------|------|-------------|------|------|------------|------|------|------------|------|-------|
| Movement:                                   | L           | T    | R    | L           | T    | R    | L          | T    | R    | L          | T    | R     |
| Min. Green:                                 | 10          | 10   | 10   | 10          | 10   | 10   | 10         | 10   | 10   | 7          | 10   | 10    |
| Y+R:  | 4.0         | 4.0  | 4.0  | 4.0         | 4.0  | 4.0  | 4.0        | 4.0  | 4.0  | 4.0        | 4.0  | 4.0   |
| Volume Module: >> Count Date: 9 Apr 2015 << |             |      |      |             |      |      |            |      |      |            |      |       |
| Base Vol:                                   | 71          | 42   | 100  | 182         | 24   | 2    | 2          | 591  | 21   | 36         | 798  | 142   |
| Growth Adj:                                 | 1.00        | 1.00 | 1.00 | 1.00        | 1.00 | 1.00 | 1.00       | 1.00 | 1.00 | 1.00       | 1.00 | 1.00  |
| Initial Bse:                                | 71          | 42   | 100  | 182         | 24   | 2    | 2          | 591  | 21   | 36         | 798  | 142   |
| Added Vol:                                  | 0           | 0    | 0    | 0           | 0    | 0    | 0          | 0    | 0    | 0          | 0    | 0     |
| PasserByVol:                                | 0           | 0    | 0    | 0           | 0    | 0    | 0          | 0    | 0    | 0          | 0    | 0     |
| Initial Fut:                                | 71          | 42   | 100  | 182         | 24   | 2    | 2          | 591  | 21   | 36         | 798  | 142   |
| User Adj:                                   | 1.00        | 1.00 | 1.00 | 1.00        | 1.00 | 1.00 | 1.00       | 1.00 | 1.00 | 1.00       | 1.00 | 1.00  |
| PHF Adj:                                    | 1.00        | 1.00 | 1.00 | 1.00        | 1.00 | 1.00 | 1.00       | 1.00 | 1.00 | 1.00       | 1.00 | 1.00  |
| PHF Volume:                                 | 71          | 42   | 100  | 182         | 24   | 2    | 2          | 591  | 21   | 36         | 798  | 142   |
| Reduct Vol:                                 | 0           | 0    | 0    | 0           | 0    | 0    | 0          | 0    | 0    | 0          | 0    | 0     |
| Reduced Vol:                                | 71          | 42   | 100  | 182         | 24   | 2    | 2          | 591  | 21   | 36         | 798  | 142   |
| PCE Adj:                                    | 1.00        | 1.00 | 1.00 | 1.00        | 1.00 | 1.00 | 1.00       | 1.00 | 1.00 | 1.00       | 1.00 | 1.00  |
| MLF Adj:                                    | 1.00        | 1.00 | 1.00 | 1.00        | 1.00 | 1.00 | 1.00       | 1.00 | 1.00 | 1.00       | 1.00 | 1.00  |
| FinalVolume:                                | 71          | 42   | 100  | 182         | 24   | 2    | 2          | 591  | 21   | 36         | 798  | 142   |
| Saturation Flow Module:                     |             |      |      |             |      |      |            |      |      |            |      |       |
| Sat/Lane:                                   | 1900        | 1900 | 1900 | 1900        | 1900 | 1900 | 1900       | 1900 | 1900 | 1900       | 1900 | 1900  |
| Adjustment:                                 | 0.95        | 0.95 | 0.92 | 0.95        | 0.95 | 0.92 | 0.95       | 0.97 | 0.92 | 0.92       | 0.98 | 0.95  |
| Lanes:                                      | 0.63        | 0.37 | 1.00 | 0.88        | 0.12 | 1.00 | 0.01       | 1.99 | 1.00 | 1.00       | 1.69 | 0.31  |
| Final Sat.:                                 | 1131        | 669  | 1750 | 1590        | 210  | 1750 | 12         | 3688 | 1750 | 1750       | 3141 | 559   |
| Capacity Analysis Module:                   |             |      |      |             |      |      |            |      |      |            |      |       |
| Vol/Sat:                                    | 0.06        | 0.06 | 0.06 | 0.11        | 0.11 | 0.00 | 0.16       | 0.16 | 0.01 | 0.02       | 0.25 | 0.25  |
| Crit Moves:                                 | *****       |      |      |             |      |      |            |      |      |            |      |       |
| Green Time:                                 | 28.4        | 28.4 | 28.4 | 28.4        | 28.4 | 28.4 | 39.7       | 39.7 | 39.7 | 62.9       | 103  | 102.6 |
| Volume/Cap:                                 | 0.31        | 0.31 | 0.28 | 0.57        | 0.57 | 0.01 | 0.57       | 0.57 | 0.04 | 0.05       | 0.35 | 0.35  |
| Delay/Veh:                                  | 48.0        | 48.0 | 47.7 | 52.3        | 52.3 | 44.6 | 43.5       | 43.5 | 36.4 | 21.7       | 6.8  | 6.8   |
| User DelAdj:                                | 1.00        | 1.00 | 1.00 | 1.00        | 1.00 | 1.00 | 1.00       | 1.00 | 1.00 | 1.00       | 1.00 | 1.00  |
| AdjDel/Veh:                                 | 48.0        | 48.0 | 47.7 | 52.3        | 52.3 | 44.6 | 43.5       | 43.5 | 36.4 | 21.7       | 6.8  | 6.8   |
| LOS by Move:                                | D           | D    | D    | D           | D    | D    | D          | D    | D    | C          | A    | A     |
| HCM2k95thQ:                                 | 8           | 8    | 7    | 17          | 17   | 0    | 20         | 20   | 1    | 2          | 14   | 14    |

Note: Queue reported is the number of cars per lane.

BART

Level Of Service Computation Report  
 2000 HCM Operations (Future Volume Alternative)  
 PM - Background Conditions

Intersection #4005: JULIAN/28TH [Study Int 3]

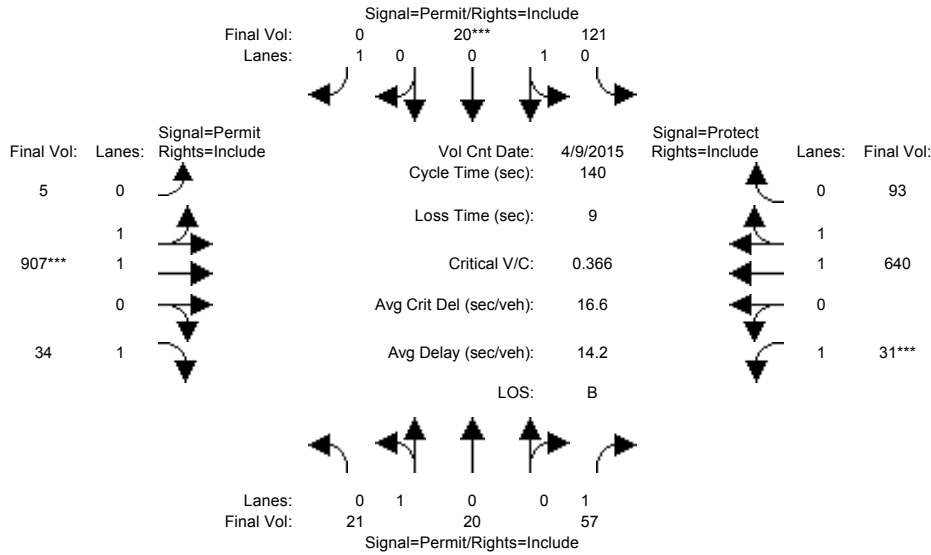

| Approach:                                   | North Bound |      |      | South Bound |      |      | East Bound |      |      | West Bound |      |       |
|---|-------------|------|------|-------------|------|------|------------|------|------|------------|------|-------|
| Movement:                                   | L           | T    | R    | L           | T    | R    | L          | T    | R    | L          | T    | R     |
| Min. Green:                                 | 10          | 10   | 10   | 10          | 10   | 10   | 10         | 10   | 10   | 7          | 10   | 10    |
| Y+R:  | 4.0         | 4.0  | 4.0  | 4.0         | 4.0  | 4.0  | 4.0        | 4.0  | 4.0  | 4.0        | 4.0  | 4.0   |
| Volume Module: >> Count Date: 9 Apr 2015 << |             |      |      |             |      |      |            |      |      |            |      |       |
| Base Vol:                                   | 21          | 20   | 57   | 121         | 20   | 0    | 5          | 907  | 34   | 31         | 640  | 93    |
| Growth Adj:                                 | 1.00        | 1.00 | 1.00 | 1.00        | 1.00 | 1.00 | 1.00       | 1.00 | 1.00 | 1.00       | 1.00 | 1.00  |
| Initial Bse:                                | 21          | 20   | 57   | 121         | 20   | 0    | 5          | 907  | 34   | 31         | 640  | 93    |
| Added Vol:                                  | 0           | 0    | 0    | 0           | 0    | 0    | 0          | 0    | 0    | 0          | 0    | 0     |
| PasserByVol:                                | 0           | 0    | 0    | 0           | 0    | 0    | 0          | 0    | 0    | 0          | 0    | 0     |
| Initial Fut:                                | 21          | 20   | 57   | 121         | 20   | 0    | 5          | 907  | 34   | 31         | 640  | 93    |
| User Adj:                                   | 1.00        | 1.00 | 1.00 | 1.00        | 1.00 | 1.00 | 1.00       | 1.00 | 1.00 | 1.00       | 1.00 | 1.00  |
| PHF Adj:                                    | 1.00        | 1.00 | 1.00 | 1.00        | 1.00 | 1.00 | 1.00       | 1.00 | 1.00 | 1.00       | 1.00 | 1.00  |
| PHF Volume:                                 | 21          | 20   | 57   | 121         | 20   | 0    | 5          | 907  | 34   | 31         | 640  | 93    |
| Reduct Vol:                                 | 0           | 0    | 0    | 0           | 0    | 0    | 0          | 0    | 0    | 0          | 0    | 0     |
| Reduced Vol:                                | 21          | 20   | 57   | 121         | 20   | 0    | 5          | 907  | 34   | 31         | 640  | 93    |
| PCE Adj:                                    | 1.00        | 1.00 | 1.00 | 1.00        | 1.00 | 1.00 | 1.00       | 1.00 | 1.00 | 1.00       | 1.00 | 1.00  |
| MLF Adj:                                    | 1.00        | 1.00 | 1.00 | 1.00        | 1.00 | 1.00 | 1.00       | 1.00 | 1.00 | 1.00       | 1.00 | 1.00  |
| Final Volume:                               | 21          | 20   | 57   | 121         | 20   | 0    | 5          | 907  | 34   | 31         | 640  | 93    |
| Saturation Flow Module:                     |             |      |      |             |      |      |            |      |      |            |      |       |
| Sat/Lane:                                   | 1900        | 1900 | 1900 | 1900        | 1900 | 1900 | 1900       | 1900 | 1900 | 1900       | 1900 | 1900  |
| Adjustment:                                 | 0.95        | 0.95 | 0.92 | 0.95        | 0.95 | 0.92 | 0.95       | 0.97 | 0.92 | 0.92       | 0.98 | 0.95  |
| Lanes:                                      | 0.51        | 0.49 | 1.00 | 0.86        | 0.14 | 1.00 | 0.01       | 1.99 | 1.00 | 1.00       | 1.74 | 0.26  |
| Final Sat.:                                 | 922         | 878  | 1750 | 1545        | 255  | 1750 | 20         | 3680 | 1750 | 1750       | 3230 | 469   |
| Capacity Analysis Module:                   |             |      |      |             |      |      |            |      |      |            |      |       |
| Vol/Sat:                                    | 0.02        | 0.02 | 0.03 | 0.08        | 0.08 | 0.00 | 0.25       | 0.25 | 0.02 | 0.02       | 0.20 | 0.20  |
| Crit Moves:                                 | *****       |      |      |             |      |      |            |      |      |            |      |       |
| Green Time:                                 | 29.9        | 29.9 | 29.9 | 29.9        | 29.9 | 0.0  | 94.1       | 94.1 | 94.1 | 7.0        | 101  | 101.1 |
| Volume/Cap:                                 | 0.11        | 0.11 | 0.15 | 0.37        | 0.37 | 0.00 | 0.37       | 0.37 | 0.03 | 0.35       | 0.27 | 0.27  |
| Delay/Veh:                                  | 44.4        | 44.4 | 44.9 | 47.6        | 47.6 | 0.0  | 10.1       | 10.1 | 7.7  | 66.8       | 6.8  | 6.8   |
| User DelAdj:                                | 1.00        | 1.00 | 1.00 | 1.00        | 1.00 | 1.00 | 1.00       | 1.00 | 1.00 | 1.00       | 1.00 | 1.00  |
| AdjDel/Veh:                                 | 44.4        | 44.4 | 44.9 | 47.6        | 47.6 | 0.0  | 10.1       | 10.1 | 7.7  | 66.8       | 6.8  | 6.8   |
| LOS by Move:                                | D           | D    | D    | D           | D    | A    | B          | B    | A    | E          | A    | A     |
| HCM2k95thQ:                                 | 3           | 3    | 4    | 11          | 11   | 0    | 16         | 16   | 1    | 3          | 11   | 11    |

Note: Queue reported is the number of cars per lane.

BART

Level Of Service Computation Report  
 2000 HCM Operations (Future Volume Alternative)  
 AM - Background Conditions

Intersection #4022: SANTA CLARA/26TH [Study Int 12]

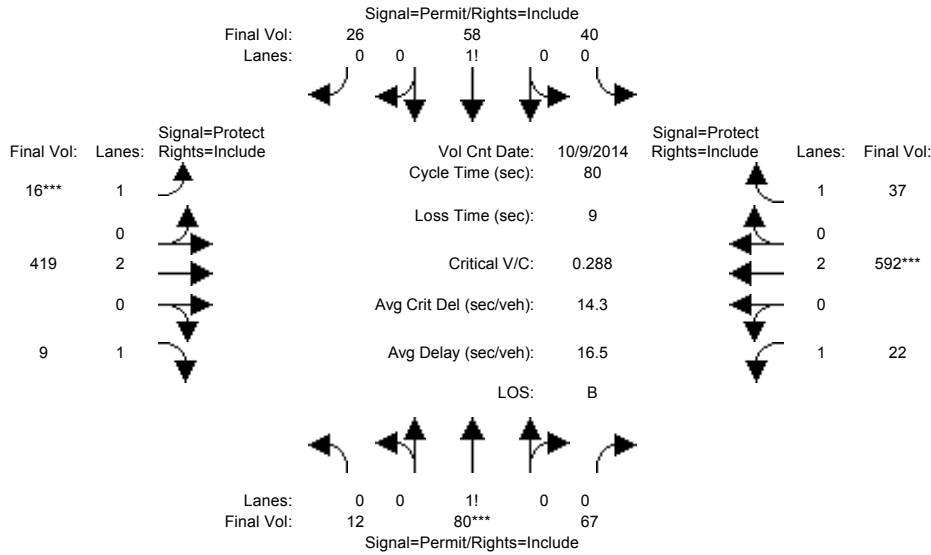

| Approach:                                   | North Bound |      |      | South Bound |      |      | East Bound |      |      | West Bound |      |      |
|---|-------------|------|------|-------------|------|------|------------|------|------|------------|------|------|
| Movement:                                   | L           | T    | R    | L           | T    | R    | L          | T    | R    | L          | T    | R    |
| Min. Green:                                 | 10          | 10   | 10   | 10          | 10   | 10   | 7          | 10   | 10   | 7          | 10   | 10   |
| Y+R:  | 4.0         | 4.0  | 4.0  | 4.0         | 4.0  | 4.0  | 4.0        | 4.0  | 4.0  | 4.0        | 4.0  | 4.0  |
| Volume Module: >> Count Date: 9 Oct 2014 << |             |      |      |             |      |      |            |      |      |            |      |      |
| Base Vol:                                   | 12          | 80   | 67   | 40          | 58   | 26   | 16         | 419  | 9    | 22         | 592  | 37   |
| Growth Adj:                                 | 1.00        | 1.00 | 1.00 | 1.00        | 1.00 | 1.00 | 1.00       | 1.00 | 1.00 | 1.00       | 1.00 | 1.00 |
| Initial Bse:                                | 12          | 80   | 67   | 40          | 58   | 26   | 16         | 419  | 9    | 22         | 592  | 37   |
| Added Vol:                                  | 0           | 0    | 0    | 0           | 0    | 0    | 0          | 0    | 0    | 0          | 0    | 0    |
| PasserByVol:                                | 0           | 0    | 0    | 0           | 0    | 0    | 0          | 0    | 0    | 0          | 0    | 0    |
| Initial Fut:                                | 12          | 80   | 67   | 40          | 58   | 26   | 16         | 419  | 9    | 22         | 592  | 37   |
| User Adj:                                   | 1.00        | 1.00 | 1.00 | 1.00        | 1.00 | 1.00 | 1.00       | 1.00 | 1.00 | 1.00       | 1.00 | 1.00 |
| PHF Adj:                                    | 1.00        | 1.00 | 1.00 | 1.00        | 1.00 | 1.00 | 1.00       | 1.00 | 1.00 | 1.00       | 1.00 | 1.00 |
| PHF Volume:                                 | 12          | 80   | 67   | 40          | 58   | 26   | 16         | 419  | 9    | 22         | 592  | 37   |
| Reduct Vol:                                 | 0           | 0    | 0    | 0           | 0    | 0    | 0          | 0    | 0    | 0          | 0    | 0    |
| Reduced Vol:                                | 12          | 80   | 67   | 40          | 58   | 26   | 16         | 419  | 9    | 22         | 592  | 37   |
| PCE Adj:                                    | 1.00        | 1.00 | 1.00 | 1.00        | 1.00 | 1.00 | 1.00       | 1.00 | 1.00 | 1.00       | 1.00 | 1.00 |
| MLF Adj:                                    | 1.00        | 1.00 | 1.00 | 1.00        | 1.00 | 1.00 | 1.00       | 1.00 | 1.00 | 1.00       | 1.00 | 1.00 |
| Final Volume:                               | 12          | 80   | 67   | 40          | 58   | 26   | 16         | 419  | 9    | 22         | 592  | 37   |
| Saturation Flow Module:                     |             |      |      |             |      |      |            |      |      |            |      |      |
| Sat/Lane:                                   | 1900        | 1900 | 1900 | 1900        | 1900 | 1900 | 1900       | 1900 | 1900 | 1900       | 1900 | 1900 |
| Adjustment:                                 | 0.92        | 0.92 | 0.92 | 0.92        | 0.92 | 0.92 | 0.92       | 1.00 | 0.92 | 0.92       | 1.00 | 0.92 |
| Lanes:                                      | 0.08        | 0.50 | 0.42 | 0.32        | 0.47 | 0.21 | 1.00       | 2.00 | 1.00 | 1.00       | 2.00 | 1.00 |
| Final Sat.:                                 | 132         | 881  | 737  | 565         | 819  | 367  | 1750       | 3800 | 1750 | 1750       | 3800 | 1750 |
| Capacity Analysis Module:                   |             |      |      |             |      |      |            |      |      |            |      |      |
| Vol/Sat:                                    | 0.09        | 0.09 | 0.09 | 0.07        | 0.07 | 0.07 | 0.01       | 0.11 | 0.01 | 0.01       | 0.16 | 0.02 |
| Crit Moves:                                 | ****        |      |      | ****        |      |      | ****       |      |      | ****       |      |      |
| Green Time:                                 | 23.6        | 23.6 | 23.6 | 23.6        | 23.6 | 23.6 | 7.0        | 27.9 | 27.9 | 19.5       | 40.4 | 40.4 |
| Volume/Cap:                                 | 0.31        | 0.31 | 0.31 | 0.24        | 0.24 | 0.24 | 0.10       | 0.32 | 0.01 | 0.05       | 0.31 | 0.04 |
| Delay/Veh:                                  | 22.2        | 22.2 | 22.2 | 21.7        | 21.7 | 21.7 | 33.9       | 19.2 | 17.1 | 23.2       | 11.7 | 10.0 |
| User DelAdj:                                | 1.00        | 1.00 | 1.00 | 1.00        | 1.00 | 1.00 | 1.00       | 1.00 | 1.00 | 1.00       | 1.00 | 1.00 |
| AdjDel/Veh:                                 | 22.2        | 22.2 | 22.2 | 21.7        | 21.7 | 21.7 | 33.9       | 19.2 | 17.1 | 23.2       | 11.7 | 10.0 |
| LOS by Move:                                | C           | C    | C    | C           | C    | C    | C          | B    | B    | C          | B    | B    |
| HCM2k95thQ:                                 | 7           | 7    | 7    | 5           | 5    | 5    | 1          | 7    | 0    | 1          | 8    | 1    |

Note: Queue reported is the number of cars per lane.

BART

Level Of Service Computation Report  
2000 HCM Operations (Future Volume Alternative)  
PM - Background Conditions

Intersection #4022: SANTA CLARA/26TH [Study Int 12]

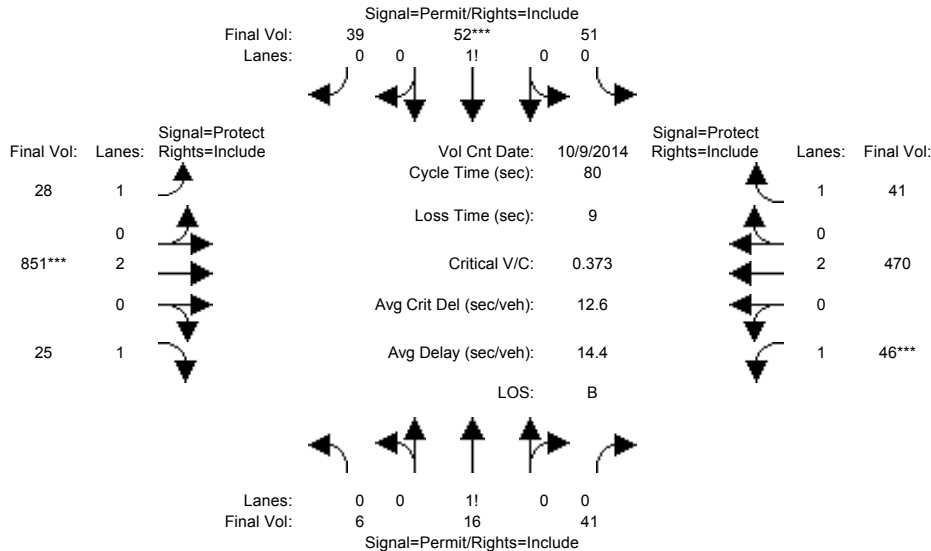

| Approach:                                   | North Bound |      |      | South Bound |      |      | East Bound |      |      | West Bound |      |      |
|---|-------------|------|------|-------------|------|------|------------|------|------|------------|------|------|
| Movement:                                   | L           | T    | R    | L           | T    | R    | L          | T    | R    | L          | T    | R    |
| Min. Green:                                 | 10          | 10   | 10   | 10          | 10   | 10   | 7          | 10   | 10   | 7          | 10   | 10   |
| Y+R:  | 4.0         | 4.0  | 4.0  | 4.0         | 4.0  | 4.0  | 4.0        | 4.0  | 4.0  | 4.0        | 4.0  | 4.0  |
| Volume Module: >> Count Date: 9 Oct 2014 << |             |      |      |             |      |      |            |      |      |            |      |      |
| Base Vol:                                   | 6           | 16   | 41   | 51          | 52   | 39   | 28         | 851  | 25   | 46         | 470  | 41   |
| Growth Adj:                                 | 1.00        | 1.00 | 1.00 | 1.00        | 1.00 | 1.00 | 1.00       | 1.00 | 1.00 | 1.00       | 1.00 | 1.00 |
| Initial Bse:                                | 6           | 16   | 41   | 51          | 52   | 39   | 28         | 851  | 25   | 46         | 470  | 41   |
| Added Vol:                                  | 0           | 0    | 0    | 0           | 0    | 0    | 0          | 0    | 0    | 0          | 0    | 0    |
| PasserByVol:                                | 0           | 0    | 0    | 0           | 0    | 0    | 0          | 0    | 0    | 0          | 0    | 0    |
| Initial Fut:                                | 6           | 16   | 41   | 51          | 52   | 39   | 28         | 851  | 25   | 46         | 470  | 41   |
| User Adj:                                   | 1.00        | 1.00 | 1.00 | 1.00        | 1.00 | 1.00 | 1.00       | 1.00 | 1.00 | 1.00       | 1.00 | 1.00 |
| PHF Adj:                                    | 1.00        | 1.00 | 1.00 | 1.00        | 1.00 | 1.00 | 1.00       | 1.00 | 1.00 | 1.00       | 1.00 | 1.00 |
| PHF Volume:                                 | 6           | 16   | 41   | 51          | 52   | 39   | 28         | 851  | 25   | 46         | 470  | 41   |
| Reduct Vol:                                 | 0           | 0    | 0    | 0           | 0    | 0    | 0          | 0    | 0    | 0          | 0    | 0    |
| Reduced Vol:                                | 6           | 16   | 41   | 51          | 52   | 39   | 28         | 851  | 25   | 46         | 470  | 41   |
| PCE Adj:                                    | 1.00        | 1.00 | 1.00 | 1.00        | 1.00 | 1.00 | 1.00       | 1.00 | 1.00 | 1.00       | 1.00 | 1.00 |
| MLF Adj:                                    | 1.00        | 1.00 | 1.00 | 1.00        | 1.00 | 1.00 | 1.00       | 1.00 | 1.00 | 1.00       | 1.00 | 1.00 |
| Final Volume:                               | 6           | 16   | 41   | 51          | 52   | 39   | 28         | 851  | 25   | 46         | 470  | 41   |
| Saturation Flow Module:                     |             |      |      |             |      |      |            |      |      |            |      |      |
| Sat/Lane:                                   | 1900        | 1900 | 1900 | 1900        | 1900 | 1900 | 1900       | 1900 | 1900 | 1900       | 1900 | 1900 |
| Adjustment:                                 | 0.92        | 0.92 | 0.92 | 0.92        | 0.92 | 0.92 | 0.92       | 1.00 | 0.92 | 0.92       | 1.00 | 0.92 |
| Lanes:                                      | 0.10        | 0.25 | 0.65 | 0.36        | 0.37 | 0.27 | 1.00       | 2.00 | 1.00 | 1.00       | 2.00 | 1.00 |
| Final Sat.:                                 | 167         | 444  | 1139 | 629         | 641  | 481  | 1750       | 3800 | 1750 | 1750       | 3800 | 1750 |
| Capacity Analysis Module:                   |             |      |      |             |      |      |            |      |      |            |      |      |
| Vol/Sat:                                    | 0.04        | 0.04 | 0.04 | 0.08        | 0.08 | 0.08 | 0.02       | 0.22 | 0.01 | 0.03       | 0.12 | 0.02 |
| Crit Moves:                                 |             |      |      | ****        |      |      | ****       |      |      | ****       |      |      |
| Green Time:                                 | 17.0        | 17.0 | 17.0 | 17.0        | 17.0 | 17.0 | 22.2       | 47.0 | 47.0 | 7.0        | 31.8 | 31.8 |
| Volume/Cap:                                 | 0.17        | 0.17 | 0.17 | 0.38        | 0.38 | 0.38 | 0.06       | 0.38 | 0.02 | 0.30       | 0.31 | 0.06 |
| Delay/Veh:                                  | 25.9        | 25.9 | 25.9 | 27.6        | 27.6 | 27.6 | 21.3       | 8.9  | 6.9  | 35.3       | 16.7 | 14.9 |
| User DelAdj:                                | 1.00        | 1.00 | 1.00 | 1.00        | 1.00 | 1.00 | 1.00       | 1.00 | 1.00 | 1.00       | 1.00 | 1.00 |
| AdjDel/Veh:                                 | 25.9        | 25.9 | 25.9 | 27.6        | 27.6 | 27.6 | 21.3       | 8.9  | 6.9  | 35.3       | 16.7 | 14.9 |
| LOS by Move:                                | C           | C    | C    | C           | C    | C    | C          | A    | A    | D          | B    | B    |
| HCM2k95thQ:                                 | 3           | 3    | 3    | 7           | 7    | 7    | 1          | 11   | 1    | 2          | 8    | 1    |

Note: Queue reported is the number of cars per lane.

BART

Level Of Service Computation Report  
2000 HCM Operations (Future Volume Alternative)  
AM - Background Conditions

Intersection #4038: 87/Taylor [Study Int 40]

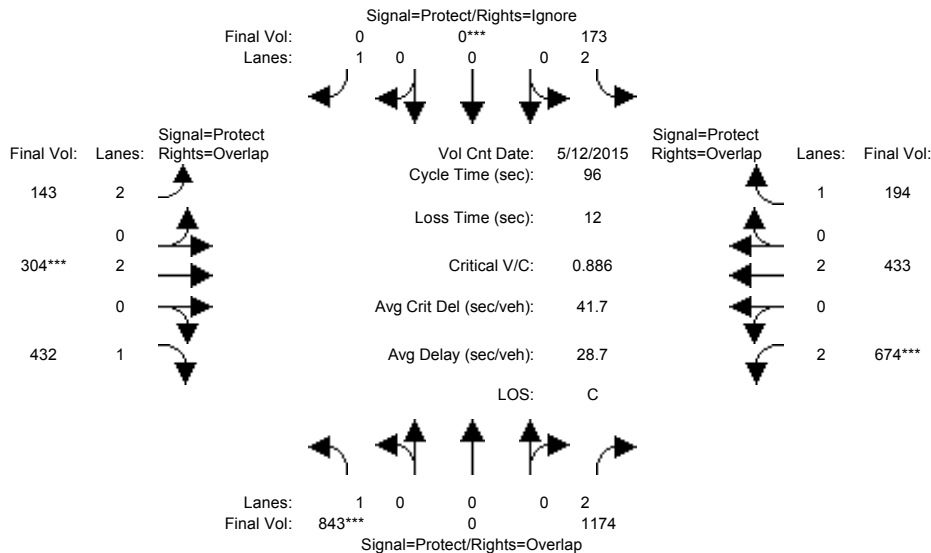

| Approach:  | North Bound |      |      | South Bound |      |      | East Bound |      |      | West Bound |      |      |
|--|-------------|------|------|-------------|------|------|------------|------|------|------------|------|------|
| Movement:  | L           | T    | R    | L           | T    | R    | L          | T    | R    | L          | T    | R    |
| Min. Green:  | 7           | 0    | 10   | 7           | 0    | 10   | 7          | 10   | 10   | 7          | 10   | 10   |
| Y+R:   | 4.0         | 4.0  | 4.0  | 4.0         | 4.0  | 4.0  | 4.0        | 4.0  | 4.0  | 4.0        | 4.0  | 4.0  |
| Volume Module: >> Count Date: 12 May 2015 << 7:30-8:30AM |             |      |      |             |      |      |            |      |      |            |      |      |
| Base Vol:  | 843         | 0    | 1174 | 173         | 0    | 146  | 143        | 304  | 432  | 674        | 433  | 194  |
| Growth Adj:  | 1.00        | 1.00 | 1.00 | 1.00        | 1.00 | 1.00 | 1.00       | 1.00 | 1.00 | 1.00       | 1.00 | 1.00 |
| Initial Bse:   | 843         | 0    | 1174 | 173         | 0    | 146  | 143        | 304  | 432  | 674        | 433  | 194  |
| Added Vol:   | 0           | 0    | 0    | 0           | 0    | 0    | 0          | 0    | 0    | 0          | 0    | 0    |
| PasserByVol:   | 0           | 0    | 0    | 0           | 0    | 0    | 0          | 0    | 0    | 0          | 0    | 0    |
| Initial Fut:   | 843         | 0    | 1174 | 173         | 0    | 146  | 143        | 304  | 432  | 674        | 433  | 194  |
| User Adj:  | 1.00        | 1.00 | 1.00 | 1.00        | 1.00 | 0.00 | 1.00       | 1.00 | 1.00 | 1.00       | 1.00 | 1.00 |
| PHF Adj:   | 1.00        | 1.00 | 1.00 | 1.00        | 1.00 | 0.00 | 1.00       | 1.00 | 1.00 | 1.00       | 1.00 | 1.00 |
| PHF Volume:  | 843         | 0    | 1174 | 173         | 0    | 0    | 143        | 304  | 432  | 674        | 433  | 194  |
| Reduct Vol:  | 0           | 0    | 0    | 0           | 0    | 0    | 0          | 0    | 0    | 0          | 0    | 0    |
| Reduced Vol:   | 843         | 0    | 1174 | 173         | 0    | 0    | 143        | 304  | 432  | 674        | 433  | 194  |
| PCE Adj:   | 1.00        | 1.00 | 1.00 | 1.00        | 1.00 | 0.00 | 1.00       | 1.00 | 1.00 | 1.00       | 1.00 | 1.00 |
| MLF Adj:   | 1.00        | 1.00 | 1.00 | 1.00        | 1.00 | 0.00 | 1.00       | 1.00 | 1.00 | 1.00       | 1.00 | 1.00 |
| Final Volume:  | 843         | 0    | 1174 | 173         | 0    | 0    | 143        | 304  | 432  | 674        | 433  | 194  |
| Saturation Flow Module:                                  |             |      |      |             |      |      |            |      |      |            |      |      |
| Sat/Lane:  | 1900        | 1900 | 1900 | 1900        | 1900 | 1900 | 1900       | 1900 | 1900 | 1900       | 1900 | 1900 |
| Adjustment:  | 0.92        | 1.00 | 0.83 | 0.83        | 1.00 | 0.92 | 0.83       | 1.00 | 0.92 | 0.83       | 1.00 | 0.92 |
| Lanes:   | 1.00        | 0.00 | 2.00 | 2.00        | 0.00 | 1.00 | 2.00       | 2.00 | 1.00 | 2.00       | 2.00 | 1.00 |
| Final Sat.:  | 1750        | 0    | 3150 | 3150        | 0    | 1750 | 3150       | 3800 | 1750 | 3150       | 3800 | 1750 |
| Capacity Analysis Module:                                |             |      |      |             |      |      |            |      |      |            |      |      |
| Vol/Sat:   | 0.48        | 0.00 | 0.37 | 0.05        | 0.00 | 0.00 | 0.05       | 0.08 | 0.25 | 0.21       | 0.11 | 0.11 |
| Crit Moves:  | ****        |      |      | ****        |      |      | ****       |      |      | ****       |      |      |
| Green Time:  | 51.2        | 0.0  | 57.9 | 16.1        | 0.0  | 0.0  | 12.8       | 10.0 | 61.2 | 22.8       | 20.0 | 36.1 |
| Volume/Cap:  | 0.90        | 0.00 | 0.62 | 0.33        | 0.00 | 0.00 | 0.34       | 0.77 | 0.39 | 0.90       | 0.55 | 0.29 |
| Delay/Veh:   | 32.0        | 0.0  | 12.7 | 35.5        | 0.0  | 0.0  | 38.3       | 50.7 | 8.6  | 49.8       | 34.8 | 21.3 |
| User DelAdj:   | 1.00        | 1.00 | 1.00 | 1.00        | 1.00 | 1.00 | 1.00       | 1.00 | 1.00 | 1.00       | 1.00 | 1.00 |
| AdjDel/Veh:  | 32.0        | 0.0  | 12.7 | 35.5        | 0.0  | 0.0  | 38.3       | 50.7 | 8.6  | 49.8       | 34.8 | 21.3 |
| LOS by Move:   | C           | A    | B    | D           | A    | A    | D          | D    | A    | D          | C    | C    |
| HCM2k95thQ:  | 46          | 0    | 24   | 6           | 0    | 0    | 4          | 9    | 12   | 27         | 12   | 9    |

Note: Queue reported is the number of cars per lane.

BART

Level Of Service Computation Report  
 2000 HCM Operations (Future Volume Alternative)  
 PM - Background Conditions

Intersection #4038: 87/Taylor [Study Int 40]

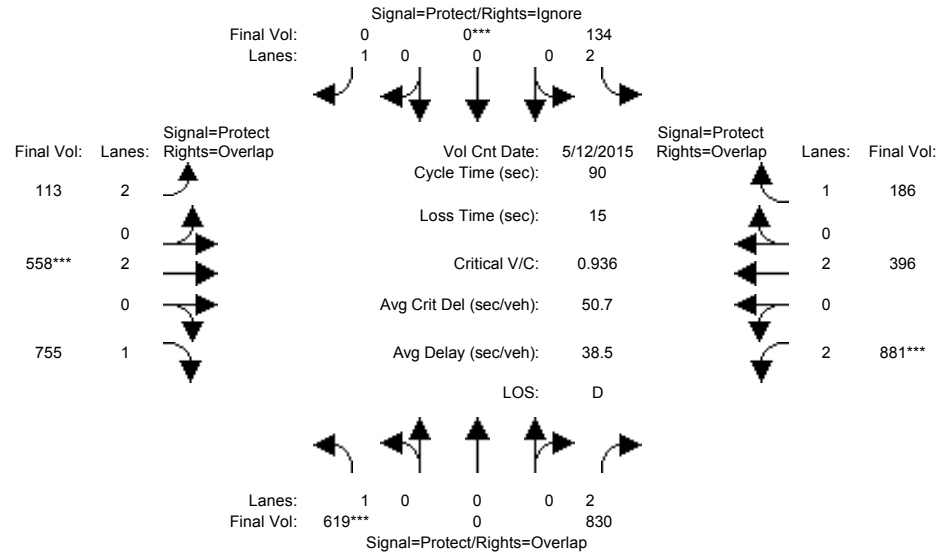

| Approach:  | North Bound |      |      | South Bound |      |      | East Bound |      |      | West Bound |      |      |
|--|-------------|------|------|-------------|------|------|------------|------|------|------------|------|------|
| Movement:  | L           | T    | R    | L           | T    | R    | L          | T    | R    | L          | T    | R    |
| Min. Green:  | 7           | 0    | 10   | 7           | 0    | 10   | 7          | 10   | 10   | 7          | 10   | 10   |
| Y+R:   | 4.0         | 4.0  | 4.0  | 4.0         | 4.0  | 4.0  | 4.0        | 4.0  | 4.0  | 4.0        | 4.0  | 4.0  |
| Volume Module: >> Count Date: 12 May 2015 << 5:00-6:00PM |             |      |      |             |      |      |            |      |      |            |      |      |
| Base Vol:  | 619         | 0    | 830  | 134         | 0    | 155  | 113        | 558  | 755  | 881        | 396  | 186  |
| Growth Adj:  | 1.00        | 1.00 | 1.00 | 1.00        | 1.00 | 1.00 | 1.00       | 1.00 | 1.00 | 1.00       | 1.00 | 1.00 |
| Initial Bse:   | 619         | 0    | 830  | 134         | 0    | 155  | 113        | 558  | 755  | 881        | 396  | 186  |
| Added Vol:   | 0           | 0    | 0    | 0           | 0    | 0    | 0          | 0    | 0    | 0          | 0    | 0    |
| PasserByVol:   | 0           | 0    | 0    | 0           | 0    | 0    | 0          | 0    | 0    | 0          | 0    | 0    |
| Initial Fut:   | 619         | 0    | 830  | 134         | 0    | 155  | 113        | 558  | 755  | 881        | 396  | 186  |
| User Adj:  | 1.00        | 1.00 | 1.00 | 1.00        | 1.00 | 0.00 | 1.00       | 1.00 | 1.00 | 1.00       | 1.00 | 1.00 |
| PHF Adj:   | 1.00        | 1.00 | 1.00 | 1.00        | 1.00 | 0.00 | 1.00       | 1.00 | 1.00 | 1.00       | 1.00 | 1.00 |
| PHF Volume:  | 619         | 0    | 830  | 134         | 0    | 0    | 113        | 558  | 755  | 881        | 396  | 186  |
| Reduct Vol:  | 0           | 0    | 0    | 0           | 0    | 0    | 0          | 0    | 0    | 0          | 0    | 0    |
| Reduced Vol:   | 619         | 0    | 830  | 134         | 0    | 0    | 113        | 558  | 755  | 881        | 396  | 186  |
| PCE Adj:   | 1.00        | 1.00 | 1.00 | 1.00        | 1.00 | 0.00 | 1.00       | 1.00 | 1.00 | 1.00       | 1.00 | 1.00 |
| MLF Adj:   | 1.00        | 1.00 | 1.00 | 1.00        | 1.00 | 0.00 | 1.00       | 1.00 | 1.00 | 1.00       | 1.00 | 1.00 |
| Final Volume:  | 619         | 0    | 830  | 134         | 0    | 0    | 113        | 558  | 755  | 881        | 396  | 186  |
| Saturation Flow Module:                                  |             |      |      |             |      |      |            |      |      |            |      |      |
| Sat/Lane:  | 1900        | 1900 | 1900 | 1900        | 1900 | 1900 | 1900       | 1900 | 1900 | 1900       | 1900 | 1900 |
| Adjustment:  | 0.92        | 1.00 | 0.83 | 0.83        | 1.00 | 0.92 | 0.83       | 1.00 | 0.92 | 0.83       | 1.00 | 0.92 |
| Lanes:   | 1.00        | 0.00 | 2.00 | 2.00        | 0.00 | 1.00 | 2.00       | 2.00 | 1.00 | 2.00       | 2.00 | 1.00 |
| Final Sat.:  | 1750        | 0    | 3150 | 3150        | 0    | 1750 | 3150       | 3800 | 1750 | 3150       | 3800 | 1750 |
| Capacity Analysis Module:                                |             |      |      |             |      |      |            |      |      |            |      |      |
| Vol/Sat:   | 0.35        | 0.00 | 0.26 | 0.04        | 0.00 | 0.00 | 0.04       | 0.15 | 0.43 | 0.28       | 0.10 | 0.11 |
| Crit Moves:  | ****        |      |      | ****        |      |      | ****       |      |      | ****       |      |      |
| Green Time:  | 34.0        | 0.0  | 26.9 | 34.0        | 0.0  | 0.0  | 16.9       | 14.1 | 48.1 | 26.9       | 24.1 | 58.1 |
| Volume/Cap:  | 0.94        | 0.00 | 0.88 | 0.11        | 0.00 | 0.00 | 0.19       | 0.94 | 0.81 | 0.94       | 0.39 | 0.16 |
| Delay/Veh:   | 47.8        | 0.0  | 39.8 | 18.2        | 0.0  | 0.0  | 31.0       | 59.9 | 22.4 | 46.9       | 27.2 | 6.4  |
| User DelAdj:   | 1.00        | 1.00 | 1.00 | 1.00        | 1.00 | 1.00 | 1.00       | 1.00 | 1.00 | 1.00       | 1.00 | 1.00 |
| AdjDel/Veh:  | 47.8        | 0.0  | 39.8 | 18.2        | 0.0  | 0.0  | 31.0       | 59.9 | 22.4 | 46.9       | 27.2 | 6.4  |
| LOS by Move:   | D           | A    | D    | B           | A    | A    | C          | E    | C    | D          | C    | A    |
| HCM2k95thQ:  | 38          | 0    | 29   | 3           | 0    | 0    | 3          | 14   | 30   | 33         | 9    | 4    |

Note: Queue reported is the number of cars per lane.

BART

Level Of Service Computation Report  
 2000 HCM Operations (Future Volume Alternative)  
 AM - Background Conditions

Intersection #4047: COLEMAN/NEWHALL [Study Int 35]

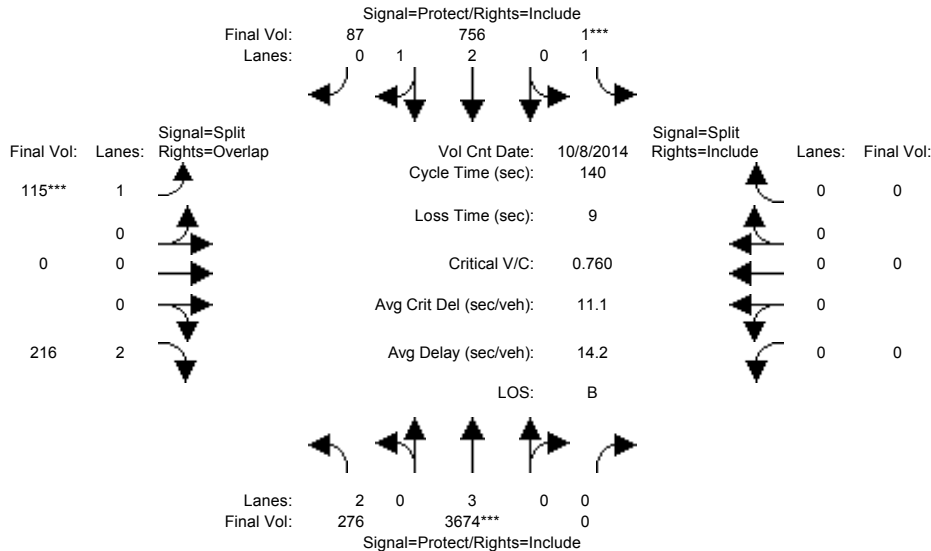

| Approach:                                   | North Bound |      |      | South Bound |      |      | East Bound |      |      | West Bound |      |      |
|---|-------------|------|------|-------------|------|------|------------|------|------|------------|------|------|
| Movement:                                   | L           | T    | R    | L           | T    | R    | L          | T    | R    | L          | T    | R    |
| Min. Green:                                 | 7           | 10   | 0    | 7           | 10   | 10   | 10         | 0    | 10   | 0          | 0    | 0    |
| Y+R:  | 4.0         | 4.0  | 4.0  | 4.0         | 4.0  | 4.0  | 4.0        | 4.0  | 4.0  | 4.0        | 4.0  | 4.0  |
| Volume Module: >> Count Date: 8 Oct 2014 << |             |      |      |             |      |      |            |      |      |            |      |      |
| Base Vol:                                   | 276         | 3674 | 0    | 1           | 756  | 87   | 115        | 0    | 216  | 0          | 0    | 0    |
| Growth Adj:                                 | 1.00        | 1.00 | 1.00 | 1.00        | 1.00 | 1.00 | 1.00       | 1.00 | 1.00 | 1.00       | 1.00 | 1.00 |
| Initial Bse:                                | 276         | 3674 | 0    | 1           | 756  | 87   | 115        | 0    | 216  | 0          | 0    | 0    |
| Added Vol:                                  | 0           | 0    | 0    | 0           | 0    | 0    | 0          | 0    | 0    | 0          | 0    | 0    |
| PasserByVol:                                | 0           | 0    | 0    | 0           | 0    | 0    | 0          | 0    | 0    | 0          | 0    | 0    |
| Initial Fut:                                | 276         | 3674 | 0    | 1           | 756  | 87   | 115        | 0    | 216  | 0          | 0    | 0    |
| User Adj:                                   | 1.00        | 1.00 | 1.00 | 1.00        | 1.00 | 1.00 | 1.00       | 1.00 | 1.00 | 1.00       | 1.00 | 1.00 |
| PHF Adj:                                    | 1.00        | 1.00 | 1.00 | 1.00        | 1.00 | 1.00 | 1.00       | 1.00 | 1.00 | 1.00       | 1.00 | 1.00 |
| PHF Volume:                                 | 276         | 3674 | 0    | 1           | 756  | 87   | 115        | 0    | 216  | 0          | 0    | 0    |
| Reduct Vol:                                 | 0           | 0    | 0    | 0           | 0    | 0    | 0          | 0    | 0    | 0          | 0    | 0    |
| Reduced Vol:                                | 276         | 3674 | 0    | 1           | 756  | 87   | 115        | 0    | 216  | 0          | 0    | 0    |
| PCE Adj:                                    | 1.00        | 1.00 | 1.00 | 1.00        | 1.00 | 1.00 | 1.00       | 1.00 | 1.00 | 1.00       | 1.00 | 1.00 |
| MLF Adj:                                    | 1.00        | 1.00 | 1.00 | 1.00        | 1.00 | 1.00 | 1.00       | 1.00 | 1.00 | 1.00       | 1.00 | 1.00 |
| FinalVolume:                                | 276         | 3674 | 0    | 1           | 756  | 87   | 115        | 0    | 216  | 0          | 0    | 0    |
| Saturation Flow Module:                     |             |      |      |             |      |      |            |      |      |            |      |      |
| Sat/Lane:                                   | 1900        | 1900 | 1900 | 1900        | 1900 | 1900 | 1900       | 1900 | 1900 | 1900       | 1900 | 1900 |
| Adjustment:                                 | 0.83        | 1.00 | 0.92 | 0.92        | 0.99 | 0.95 | 0.92       | 1.00 | 0.83 | 0.92       | 1.00 | 0.92 |
| Lanes:                                      | 2.00        | 3.00 | 0.00 | 1.00        | 2.68 | 0.32 | 1.00       | 0.00 | 2.00 | 0.00       | 0.00 | 0.00 |
| Final Sat.:                                 | 3150        | 5700 | 0    | 1750        | 5021 | 578  | 1750       | 0    | 3150 | 0          | 0    | 0    |
| Capacity Analysis Module:                   |             |      |      |             |      |      |            |      |      |            |      |      |
| Vol/Sat:                                    | 0.09        | 0.64 | 0.00 | 0.00        | 0.15 | 0.15 | 0.07       | 0.00 | 0.07 | 0.00       | 0.00 | 0.00 |
| Crit Moves:                                 | ****        | **** | **** | ****        | **** | **** | ****       | **** | **** | ****       | **** | **** |
| Green Time:                                 | 44.0        | 113  | 0.0  | 7.0         | 75.6 | 75.6 | 11.5       | 0.0  | 55.4 | 0.0        | 0.0  | 0.0  |
| Volume/Cap:                                 | 0.28        | 0.80 | 0.00 | 0.01        | 0.28 | 0.28 | 0.80       | 0.00 | 0.17 | 0.00       | 0.00 | 0.00 |
| Delay/Veh:                                  | 36.3        | 8.7  | 0.0  | 63.3        | 17.5 | 17.5 | 89.9       | 0.0  | 27.5 | 0.0        | 0.0  | 0.0  |
| User DelAdj:                                | 1.00        | 1.00 | 1.00 | 1.00        | 1.00 | 1.00 | 1.00       | 1.00 | 1.00 | 1.00       | 1.00 | 1.00 |
| AdjDel/Veh:                                 | 36.3        | 8.7  | 0.0  | 63.3        | 17.5 | 17.5 | 89.9       | 0.0  | 27.5 | 0.0        | 0.0  | 0.0  |
| LOS by Move:                                | D           | A    | A    | E           | B    | B    | F          | A    | C    | A          | A    | A    |
| HCM2k95thQ:                                 | 10          | 48   | 0    | 0           | 12   | 12   | 14         | 0    | 7    | 0          | 0    | 0    |

Note: Queue reported is the number of cars per lane.



BART

Level Of Service Computation Report  
 2000 HCM Operations (Future Volume Alternative)  
 PM - Background Conditions

Intersection #4047: COLEMAN/NEWHALL [Study Int 35]

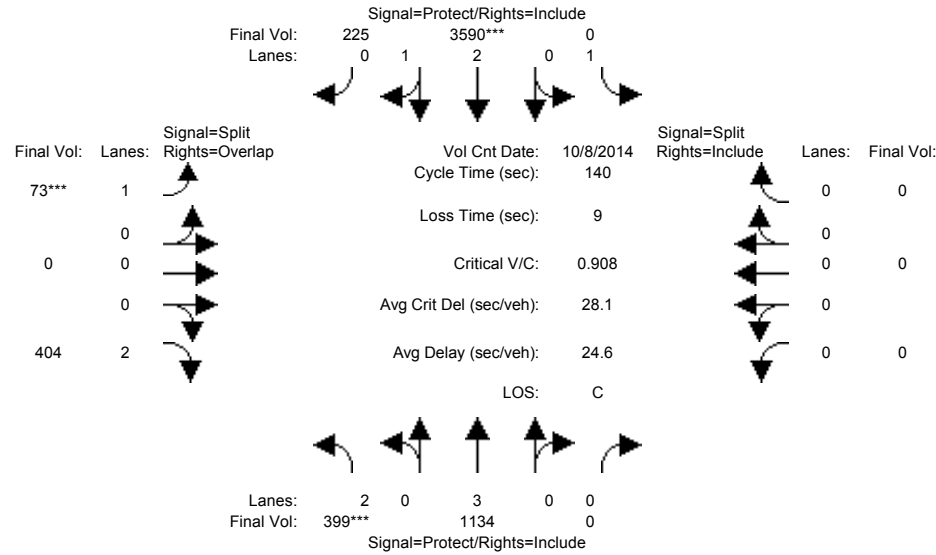

| Approach:   | North Bound                  |      |      | South Bound |      |       | East Bound |      |      | West Bound |      |      |
|---|------------------------------|------|------|-------------|------|-------|------------|------|------|------------|------|------|
| Movement:   | L                            | T    | R    | L           | T    | R     | L          | T    | R    | L          | T    | R    |
| Min. Green:   | 7                            | 10   | 0    | 7           | 10   | 10    | 10         | 0    | 10   | 0          | 0    | 0    |
| Y+R:  | 4.0                          | 4.0  | 4.0  | 4.0         | 4.0  | 4.0   | 4.0        | 4.0  | 4.0  | 4.0        | 4.0  | 4.0  |
| ----- ----- ----- ----- ----- ----- ----- ----- ----- ----- ----- ----- ----- |                              |      |      |             |      |       |            |      |      |            |      |      |
| Volume Module:  | >> Count Date: 8 Oct 2014 << |      |      |             |      |       |            |      |      |            |      |      |
| Base Vol:   | 399                          | 1134 | 0    | 0           | 3590 | 225   | 73         | 0    | 404  | 0          | 0    | 0    |
| Growth Adj:   | 1.00                         | 1.00 | 1.00 | 1.00        | 1.00 | 1.00  | 1.00       | 1.00 | 1.00 | 1.00       | 1.00 | 1.00 |
| Initial Bse:  | 399                          | 1134 | 0    | 0           | 3590 | 225   | 73         | 0    | 404  | 0          | 0    | 0    |
| Added Vol:  | 0                            | 0    | 0    | 0           | 0    | 0     | 0          | 0    | 0    | 0          | 0    | 0    |
| PasserByVol:  | 0                            | 0    | 0    | 0           | 0    | 0     | 0          | 0    | 0    | 0          | 0    | 0    |
| Initial Fut:  | 399                          | 1134 | 0    | 0           | 3590 | 225   | 73         | 0    | 404  | 0          | 0    | 0    |
| User Adj:   | 1.00                         | 1.00 | 1.00 | 1.00        | 1.00 | 1.00  | 1.00       | 1.00 | 1.00 | 1.00       | 1.00 | 1.00 |
| PHF Adj:  | 1.00                         | 1.00 | 1.00 | 1.00        | 1.00 | 1.00  | 1.00       | 1.00 | 1.00 | 1.00       | 1.00 | 1.00 |
| PHF Volume:   | 399                          | 1134 | 0    | 0           | 3590 | 225   | 73         | 0    | 404  | 0          | 0    | 0    |
| Reduct Vol:   | 0                            | 0    | 0    | 0           | 0    | 0     | 0          | 0    | 0    | 0          | 0    | 0    |
| Reduced Vol:  | 399                          | 1134 | 0    | 0           | 3590 | 225   | 73         | 0    | 404  | 0          | 0    | 0    |
| PCE Adj:  | 1.00                         | 1.00 | 1.00 | 1.00        | 1.00 | 1.00  | 1.00       | 1.00 | 1.00 | 1.00       | 1.00 | 1.00 |
| MLF Adj:  | 1.00                         | 1.00 | 1.00 | 1.00        | 1.00 | 1.00  | 1.00       | 1.00 | 1.00 | 1.00       | 1.00 | 1.00 |
| Final Volume:   | 399                          | 1134 | 0    | 0           | 3590 | 225   | 73         | 0    | 404  | 0          | 0    | 0    |
| ----- ----- ----- ----- ----- ----- ----- ----- ----- ----- ----- -----       |                              |      |      |             |      |       |            |      |      |            |      |      |
| Saturation Flow Module:   |                              |      |      |             |      |       |            |      |      |            |      |      |
| Sat/Lane:   | 1900                         | 1900 | 1900 | 1900        | 1900 | 1900  | 1900       | 1900 | 1900 | 1900       | 1900 | 1900 |
| Adjustment:   | 0.83                         | 1.00 | 0.92 | 0.92        | 0.98 | 0.95  | 0.92       | 1.00 | 0.83 | 0.92       | 1.00 | 0.92 |
| Lanes:  | 2.00                         | 3.00 | 0.00 | 1.00        | 2.82 | 0.18  | 1.00       | 0.00 | 2.00 | 0.00       | 0.00 | 0.00 |
| Final Sat.:   | 3150                         | 5700 | 0    | 1750        | 5269 | 330   | 1750       | 0    | 3150 | 0          | 0    | 0    |
| ----- ----- ----- ----- ----- ----- ----- ----- ----- ----- ----- -----       |                              |      |      |             |      |       |            |      |      |            |      |      |
| Capacity Analysis Module:   |                              |      |      |             |      |       |            |      |      |            |      |      |
| Vol/Sat:  | 0.13                         | 0.20 | 0.00 | 0.00        | 0.68 | 0.68  | 0.04       | 0.00 | 0.13 | 0.00       | 0.00 | 0.00 |
| Crit Moves:   | ****                         |      |      |             |      |       |            |      |      |            |      |      |
| Green Time:   | 19.0                         | 121  | 0.0  | 0.0         | 102  | 102.0 | 10.0       | 0.0  | 29.0 | 0.0        | 0.0  | 0.0  |
| Volume/Cap:   | 0.93                         | 0.23 | 0.00 | 0.00        | 0.93 | 0.93  | 0.58       | 0.00 | 0.62 | 0.00       | 0.00 | 0.00 |
| Delay/Veh:  | 87.7                         | 1.6  | 0.0  | 0.0         | 21.0 | 21.0  | 69.9       | 0.0  | 52.3 | 0.0        | 0.0  | 0.0  |
| User DelAdj:  | 1.00                         | 1.00 | 1.00 | 1.00        | 1.00 | 1.00  | 1.00       | 1.00 | 1.00 | 1.00       | 1.00 | 1.00 |
| AdjDel/Veh:   | 87.7                         | 1.6  | 0.0  | 0.0         | 21.0 | 21.0  | 69.9       | 0.0  | 52.3 | 0.0        | 0.0  | 0.0  |
| LOS by Move:  | F                            | A    | A    | A           | C    | C     | E          | A    | D    | A          | A    | A    |
| HCM2k95thQ:   | 25                           | 6    | 0    | 0           | 74   | 74    | 8          | 0    | 19   | 0          | 0    | 0    |

Note: Queue reported is the number of cars per lane.

BART

Level Of Service Computation Report  
2000 HCM Operations (Future Volume Alternative)  
AM - Background Conditions

Intersection #4069: 101/Trimble [Study Int 62]

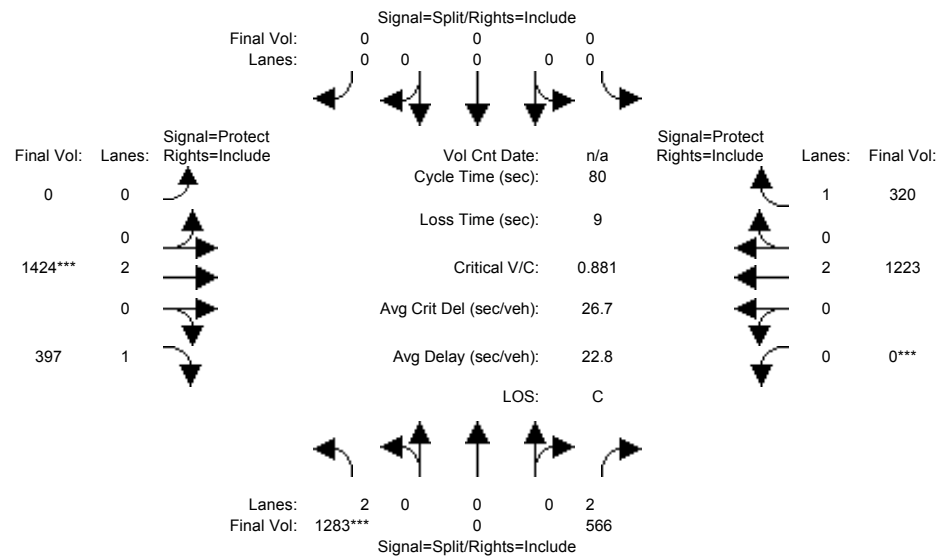

| Approach:                 | North Bound |      |      | South Bound |      |      | East Bound |      |      | West Bound |      |      |
|---------------------------|-------------|------|------|-------------|------|------|------------|------|------|------------|------|------|
| Movement:                 | L           | T    | R    | L           | T    | R    | L          | T    | R    | L          | T    | R    |
| Min. Green:               | 10          | 0    | 10   | 0           | 0    | 0    | 0          | 10   | 10   | 0          | 10   | 10   |
| Y+R:                      | 4.0         | 4.0  | 4.0  | 4.0         | 4.0  | 4.0  | 4.0        | 4.0  | 4.0  | 4.0        | 4.0  | 4.0  |
| Volume Module:            |             |      |      |             |      |      |            |      |      |            |      |      |
| Base Vol:                 | 1283        | 0    | 566  | 0           | 0    | 0    | 0          | 1424 | 397  | 0          | 1223 | 320  |
| Growth Adj:               | 1.00        | 1.00 | 1.00 | 1.00        | 1.00 | 1.00 | 1.00       | 1.00 | 1.00 | 1.00       | 1.00 | 1.00 |
| Initial Bse:              | 1283        | 0    | 566  | 0           | 0    | 0    | 0          | 1424 | 397  | 0          | 1223 | 320  |
| Added Vol:                | 0           | 0    | 0    | 0           | 0    | 0    | 0          | 0    | 0    | 0          | 0    | 0    |
| PasserByVol:              | 0           | 0    | 0    | 0           | 0    | 0    | 0          | 0    | 0    | 0          | 0    | 0    |
| Initial Fut:              | 1283        | 0    | 566  | 0           | 0    | 0    | 0          | 1424 | 397  | 0          | 1223 | 320  |
| User Adj:                 | 1.00        | 1.00 | 1.00 | 1.00        | 1.00 | 1.00 | 1.00       | 1.00 | 1.00 | 1.00       | 1.00 | 1.00 |
| PHF Adj:                  | 1.00        | 1.00 | 1.00 | 1.00        | 1.00 | 1.00 | 1.00       | 1.00 | 1.00 | 1.00       | 1.00 | 1.00 |
| PHF Volume:               | 1283        | 0    | 566  | 0           | 0    | 0    | 0          | 1424 | 397  | 0          | 1223 | 320  |
| Reduct Vol:               | 0           | 0    | 0    | 0           | 0    | 0    | 0          | 0    | 0    | 0          | 0    | 0    |
| Reduced Vol:              | 1283        | 0    | 566  | 0           | 0    | 0    | 0          | 1424 | 397  | 0          | 1223 | 320  |
| PCE Adj:                  | 1.00        | 1.00 | 1.00 | 1.00        | 1.00 | 1.00 | 1.00       | 1.00 | 1.00 | 1.00       | 1.00 | 1.00 |
| MLF Adj:                  | 1.00        | 1.00 | 1.00 | 1.00        | 1.00 | 1.00 | 1.00       | 1.00 | 1.00 | 1.00       | 1.00 | 1.00 |
| FinalVolume:              | 1283        | 0    | 566  | 0           | 0    | 0    | 0          | 1424 | 397  | 0          | 1223 | 320  |
| Saturation Flow Module:   |             |      |      |             |      |      |            |      |      |            |      |      |
| Sat/Lane:                 | 1900        | 1900 | 1900 | 1900        | 1900 | 1900 | 1900       | 1900 | 1900 | 1900       | 1900 | 1900 |
| Adjustment:               | 0.83        | 1.00 | 0.83 | 0.92        | 1.00 | 0.92 | 0.92       | 1.00 | 0.92 | 0.92       | 1.00 | 0.92 |
| Lanes:                    | 2.00        | 0.00 | 2.00 | 0.00        | 0.00 | 0.00 | 0.00       | 2.00 | 1.00 | 0.00       | 2.00 | 1.00 |
| Final Sat.:               | 3150        | 0    | 3150 | 0           | 0    | 0    | 0          | 3800 | 1750 | 0          | 3800 | 1750 |
| Capacity Analysis Module: |             |      |      |             |      |      |            |      |      |            |      |      |
| Vol/Sat:                  | 0.41        | 0.00 | 0.18 | 0.00        | 0.00 | 0.00 | 0.00       | 0.37 | 0.23 | 0.00       | 0.32 | 0.18 |
| Crit Moves:               | ****        |      |      |             |      |      |            | **** |      |            | **** |      |
| Green Time:               | 37.0        | 0.0  | 37.0 | 0.0         | 0.0  | 0.0  | 0.0        | 34.0 | 34.0 | 0.0        | 34.0 | 34.0 |
| Volume/Cap:               | 0.88        | 0.00 | 0.39 | 0.00        | 0.00 | 0.00 | 0.00       | 0.88 | 0.53 | 0.00       | 0.76 | 0.43 |
| Delay/Veh:                | 26.1        | 0.0  | 14.3 | 0.0         | 0.0  | 0.0  | 0.0        | 27.1 | 17.8 | 0.0        | 21.6 | 16.6 |
| User DelAdj:              | 1.00        | 1.00 | 1.00 | 1.00        | 1.00 | 1.00 | 1.00       | 1.00 | 1.00 | 1.00       | 1.00 | 1.00 |
| AdjDel/Veh:               | 26.1        | 0.0  | 14.3 | 0.0         | 0.0  | 0.0  | 0.0        | 27.1 | 17.8 | 0.0        | 21.6 | 16.6 |
| LOS by Move:              | C           | A    | B    | A           | A    | A    | A          | C    | B    | A          | C    | B    |
| HCM2k95thQ:               | 35          | 0    | 11   | 0           | 0    | 0    | 0          | 31   | 15   | 0          | 25   | 12   |

Note: Queue reported is the number of cars per lane.

BART

Level Of Service Computation Report  
 2000 HCM Operations (Future Volume Alternative)  
 PM - Background Conditions

Intersection #4069: 101/Trimble [Study Int 62]

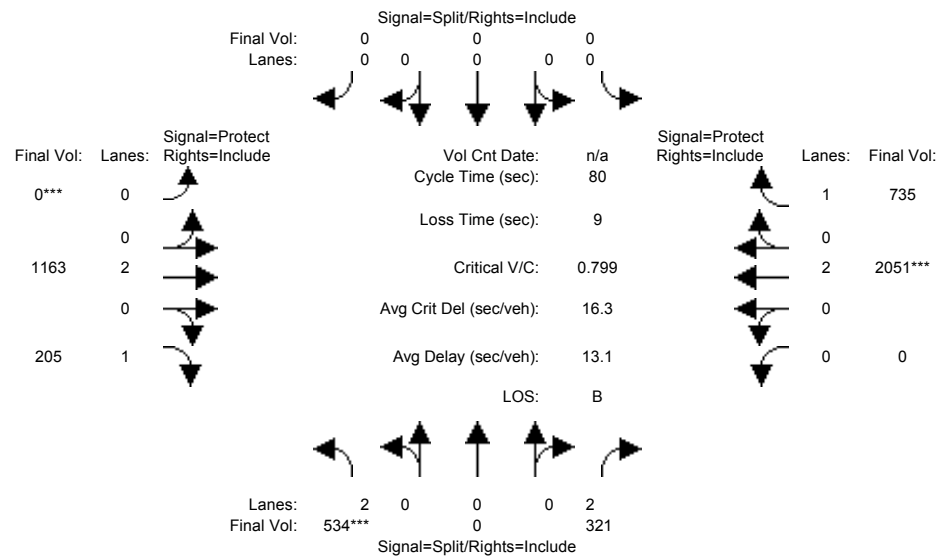

| Approach:                 | North Bound |      |      | South Bound |      |      | East Bound |      |      | West Bound |      |      |
|---------------------------|-------------|------|------|-------------|------|------|------------|------|------|------------|------|------|
| Movement:                 | L           | T    | R    | L           | T    | R    | L          | T    | R    | L          | T    | R    |
| Min. Green:               | 10          | 0    | 10   | 0           | 0    | 0    | 0          | 10   | 10   | 0          | 10   | 10   |
| Y+R:                      | 4.0         | 4.0  | 4.0  | 4.0         | 4.0  | 4.0  | 4.0        | 4.0  | 4.0  | 4.0        | 4.0  | 4.0  |
| Volume Module:            |             |      |      |             |      |      |            |      |      |            |      |      |
| Base Vol:                 | 534         | 0    | 321  | 0           | 0    | 0    | 0          | 1163 | 205  | 0          | 2051 | 735  |
| Growth Adj:               | 1.00        | 1.00 | 1.00 | 1.00        | 1.00 | 1.00 | 1.00       | 1.00 | 1.00 | 1.00       | 1.00 | 1.00 |
| Initial Bse:              | 534         | 0    | 321  | 0           | 0    | 0    | 0          | 1163 | 205  | 0          | 2051 | 735  |
| Added Vol:                | 0           | 0    | 0    | 0           | 0    | 0    | 0          | 0    | 0    | 0          | 0    | 0    |
| PasserByVol:              | 0           | 0    | 0    | 0           | 0    | 0    | 0          | 0    | 0    | 0          | 0    | 0    |
| Initial Fut:              | 534         | 0    | 321  | 0           | 0    | 0    | 0          | 1163 | 205  | 0          | 2051 | 735  |
| User Adj:                 | 1.00        | 1.00 | 1.00 | 1.00        | 1.00 | 1.00 | 1.00       | 1.00 | 1.00 | 1.00       | 1.00 | 1.00 |
| PHF Adj:                  | 1.00        | 1.00 | 1.00 | 1.00        | 1.00 | 1.00 | 1.00       | 1.00 | 1.00 | 1.00       | 1.00 | 1.00 |
| PHF Volume:               | 534         | 0    | 321  | 0           | 0    | 0    | 0          | 1163 | 205  | 0          | 2051 | 735  |
| Reduct Vol:               | 0           | 0    | 0    | 0           | 0    | 0    | 0          | 0    | 0    | 0          | 0    | 0    |
| Reduced Vol:              | 534         | 0    | 321  | 0           | 0    | 0    | 0          | 1163 | 205  | 0          | 2051 | 735  |
| PCE Adj:                  | 1.00        | 1.00 | 1.00 | 1.00        | 1.00 | 1.00 | 1.00       | 1.00 | 1.00 | 1.00       | 1.00 | 1.00 |
| MLF Adj:                  | 1.00        | 1.00 | 1.00 | 1.00        | 1.00 | 1.00 | 1.00       | 1.00 | 1.00 | 1.00       | 1.00 | 1.00 |
| FinalVolume:              | 534         | 0    | 321  | 0           | 0    | 0    | 0          | 1163 | 205  | 0          | 2051 | 735  |
| Saturation Flow Module:   |             |      |      |             |      |      |            |      |      |            |      |      |
| Sat/Lane:                 | 1900        | 1900 | 1900 | 1900        | 1900 | 1900 | 1900       | 1900 | 1900 | 1900       | 1900 | 1900 |
| Adjustment:               | 0.83        | 1.00 | 0.83 | 0.92        | 1.00 | 0.92 | 0.92       | 1.00 | 0.92 | 0.92       | 1.00 | 0.92 |
| Lanes:                    | 2.00        | 0.00 | 2.00 | 0.00        | 0.00 | 0.00 | 0.00       | 2.00 | 1.00 | 0.00       | 2.00 | 1.00 |
| Final Sat.:               | 3150        | 0    | 3150 | 0           | 0    | 0    | 0          | 3800 | 1750 | 0          | 3800 | 1750 |
| Capacity Analysis Module: |             |      |      |             |      |      |            |      |      |            |      |      |
| Vol/Sat:                  | 0.17        | 0.00 | 0.10 | 0.00        | 0.00 | 0.00 | 0.00       | 0.31 | 0.12 | 0.00       | 0.54 | 0.42 |
| Crit Moves:               | ****        |      |      |             |      |      | ****       |      |      | ****       |      |      |
| Green Time:               | 17.0        | 0.0  | 17.0 | 0.0         | 0.0  | 0.0  | 0.0        | 54.0 | 54.0 | 0.0        | 54.0 | 54.0 |
| Volume/Cap:               | 0.80        | 0.00 | 0.48 | 0.00        | 0.00 | 0.00 | 0.00       | 0.45 | 0.17 | 0.00       | 0.80 | 0.62 |
| Delay/Veh:                | 36.7        | 0.0  | 28.2 | 0.0         | 0.0  | 0.0  | 0.0        | 6.2  | 4.8  | 0.0        | 11.0 | 8.3  |
| User DelAdj:              | 1.00        | 1.00 | 1.00 | 1.00        | 1.00 | 1.00 | 1.00       | 1.00 | 1.00 | 1.00       | 1.00 | 1.00 |
| AdjDel/Veh:               | 36.7        | 0.0  | 28.2 | 0.0         | 0.0  | 0.0  | 0.0        | 6.2  | 4.8  | 0.0        | 11.0 | 8.3  |
| LOS by Move:              | D           | A    | C    | A           | A    | A    | A          | A    | A    | A          | B    | A    |
| HCM2k95thQ:               | 18          | 0    | 9    | 0           | 0    | 0    | 0          | 13   | 4    | 0          | 33   | 21   |

Note: Queue reported is the number of cars per lane.

BART

Level Of Service Computation Report  
2000 HCM Operations (Future Volume Alternative)  
AM - Background Conditions

Intersection #5332: CENTRAL EXPWY/SCOTT BLVD [Study Int 28]

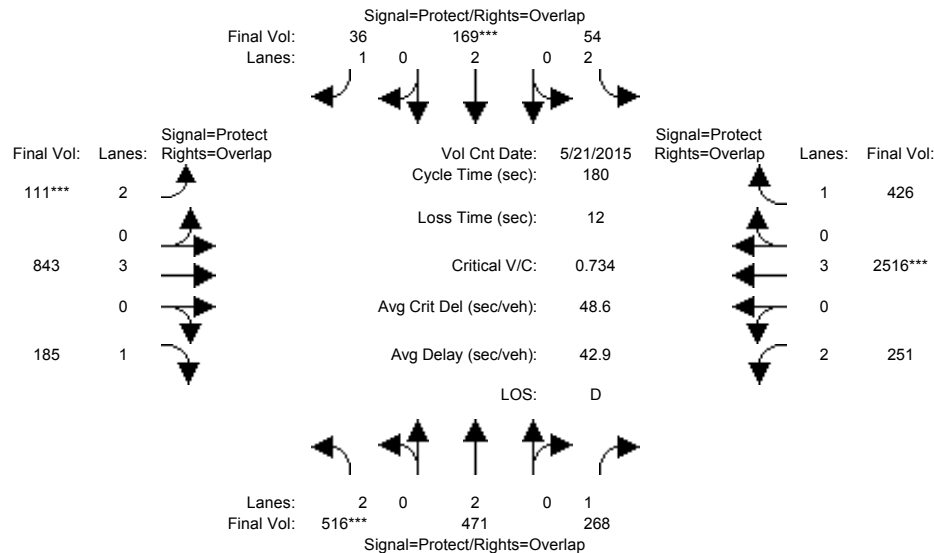

| Approach:  | North Bound |      |      | South Bound |      |      | East Bound |      |       | West Bound |      |       |
|--|-------------|------|------|-------------|------|------|------------|------|-------|------------|------|-------|
| Movement:  | L           | T    | R    | L           | T    | R    | L          | T    | R     | L          | T    | R     |
| Min. Green:  | 14          | 10   | 10   | 14          | 10   | 10   | 14         | 10   | 10    | 14         | 90   | 10    |
| Y+R:   | 4.0         | 4.0  | 4.0  | 4.0         | 4.0  | 4.0  | 4.0        | 4.0  | 4.0   | 4.0        | 4.0  | 4.0   |
| Volume Module: >> Count Date: 21 May 2015 << 5:00-6:00PM |             |      |      |             |      |      |            |      |       |            |      |       |
| Base Vol:  | 516         | 471  | 268  | 54          | 169  | 36   | 111        | 843  | 185   | 251        | 2516 | 426   |
| Growth Adj:  | 1.00        | 1.00 | 1.00 | 1.00        | 1.00 | 1.00 | 1.00       | 1.00 | 1.00  | 1.00       | 1.00 | 1.00  |
| Initial Bse:   | 516         | 471  | 268  | 54          | 169  | 36   | 111        | 843  | 185   | 251        | 2516 | 426   |
| Added Vol:   | 0           | 0    | 0    | 0           | 0    | 0    | 0          | 0    | 0     | 0          | 0    | 0     |
| PasserByVol:   | 0           | 0    | 0    | 0           | 0    | 0    | 0          | 0    | 0     | 0          | 0    | 0     |
| Initial Fut:   | 516         | 471  | 268  | 54          | 169  | 36   | 111        | 843  | 185   | 251        | 2516 | 426   |
| User Adj:  | 1.00        | 1.00 | 1.00 | 1.00        | 1.00 | 1.00 | 1.00       | 1.00 | 1.00  | 1.00       | 1.00 | 1.00  |
| PHF Adj:   | 1.00        | 1.00 | 1.00 | 1.00        | 1.00 | 1.00 | 1.00       | 1.00 | 1.00  | 1.00       | 1.00 | 1.00  |
| PHF Volume:  | 516         | 471  | 268  | 54          | 169  | 36   | 111        | 843  | 185   | 251        | 2516 | 426   |
| Reduct Vol:  | 0           | 0    | 0    | 0           | 0    | 0    | 0          | 0    | 0     | 0          | 0    | 0     |
| Reduced Vol:   | 516         | 471  | 268  | 54          | 169  | 36   | 111        | 843  | 185   | 251        | 2516 | 426   |
| PCE Adj:   | 1.00        | 1.00 | 1.00 | 1.00        | 1.00 | 1.00 | 1.00       | 1.00 | 1.00  | 1.00       | 1.00 | 1.00  |
| MLF Adj:   | 1.00        | 1.00 | 1.00 | 1.00        | 1.00 | 1.00 | 1.00       | 1.00 | 1.00  | 1.00       | 1.00 | 1.00  |
| Final Volume:  | 516         | 471  | 268  | 54          | 169  | 36   | 111        | 843  | 185   | 251        | 2516 | 426   |
| Saturation Flow Module:                                  |             |      |      |             |      |      |            |      |       |            |      |       |
| Sat/Lane:  | 1900        | 1900 | 1900 | 1900        | 1900 | 1900 | 1900       | 1900 | 1900  | 1900       | 1900 | 1900  |
| Adjustment:  | 0.83        | 1.00 | 0.92 | 0.83        | 1.00 | 0.92 | 0.83       | 1.00 | 0.92  | 0.83       | 1.00 | 0.92  |
| Lanes:   | 2.00        | 2.00 | 1.00 | 2.00        | 2.00 | 1.00 | 2.00       | 3.00 | 1.00  | 2.00       | 3.00 | 1.00  |
| Final Sat.:  | 3150        | 3800 | 1750 | 3150        | 3800 | 1750 | 3150       | 5700 | 1750  | 3150       | 5700 | 1750  |
| Capacity Analysis Module:                                |             |      |      |             |      |      |            |      |       |            |      |       |
| Vol/Sat:   | 0.16        | 0.12 | 0.15 | 0.02        | 0.04 | 0.02 | 0.04       | 0.15 | 0.11  | 0.08       | 0.44 | 0.24  |
| Crit Moves:  | ****        |      |      | ****        |      |      | ****       |      |       | ****       |      |       |
| Green Time:  | 38.8        | 30.3 | 71.9 | 19.0        | 10.5 | 24.5 | 14.0       | 77.1 | 115.9 | 41.5       | 105  | 123.7 |
| Volume/Cap:  | 0.76        | 0.74 | 0.38 | 0.16        | 0.76 | 0.15 | 0.45       | 0.35 | 0.16  | 0.35       | 0.76 | 0.35  |
| Delay/Veh:   | 71.2        | 75.5 | 38.7 | 73.5        | 97.6 | 68.8 | 76.2       | 17.4 | 0.1   | 59.5       | 39.5 | 18.9  |
| User DelAdj:   | 1.00        | 1.00 | 1.00 | 1.00        | 1.00 | 1.00 | 1.00       | 1.00 | 1.00  | 1.00       | 1.00 | 1.00  |
| AdjDel/Veh:  | 71.2        | 75.5 | 38.7 | 73.5        | 97.6 | 68.8 | 76.2       | 17.4 | 0.1   | 59.5       | 39.5 | 18.9  |
| LOS by Move:   | E           | E    | D    | E           | F    | E    | E          | B    | A     | E          | D    | B     |
| HCM2k95thQ:  | 29          | 23   | 22   | 3           | 10   | 4    | 8          | 11   | 0     | 13         | 60   | 27    |

Note: Queue reported is the number of cars per lane.

BART

Level Of Service Computation Report  
 2000 HCM Operations (Future Volume Alternative)  
 PM - Background Conditions

Intersection #5332: CENTRAL EXPWY/SCOTT BLVD [Study Int 28]

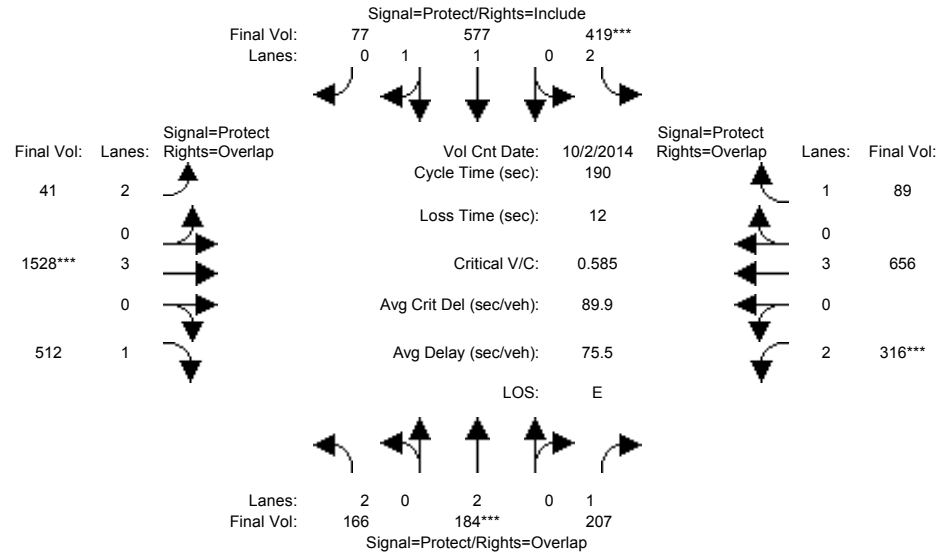

| Approach:   | North Bound |      |      | South Bound |      |       | East Bound |      |       | West Bound |      |       |
|---|-------------|------|------|-------------|------|-------|------------|------|-------|------------|------|-------|
| Movement:   | L           | T    | R    | L           | T    | R     | L          | T    | R     | L          | T    | R     |
| Min. Green:   | 28          | 42   | 42   | 20          | 34   | 34    | 19         | 105  | 105   | 23         | 109  | 109   |
| Y+R:  | 4.0         | 4.0  | 4.0  | 4.0         | 4.0  | 4.0   | 4.0        | 4.0  | 4.0   | 4.0        | 4.0  | 4.0   |
| Volume Module: >> Count Date: 2 Oct 2014 << 5:15-6:15PM |             |      |      |             |      |       |            |      |       |            |      |       |
| Base Vol:   | 166         | 184  | 207  | 419         | 577  | 77    | 41         | 2065 | 512   | 316        | 745  | 89    |
| Growth Adj:   | 1.00        | 1.00 | 1.00 | 1.00        | 1.00 | 1.00  | 1.00       | 0.74 | 1.00  | 1.00       | 0.88 | 1.00  |
| Initial Bse:  | 166         | 184  | 207  | 419         | 577  | 77    | 41         | 1528 | 512   | 316        | 656  | 89    |
| Added Vol:  | 0           | 0    | 0    | 0           | 0    | 0     | 0          | 0    | 0     | 0          | 0    | 0     |
| PasserByVol:  | 0           | 0    | 0    | 0           | 0    | 0     | 0          | 0    | 0     | 0          | 0    | 0     |
| Initial Fut:  | 166         | 184  | 207  | 419         | 577  | 77    | 41         | 1528 | 512   | 316        | 656  | 89    |
| User Adj:   | 1.00        | 1.00 | 1.00 | 1.00        | 1.00 | 1.00  | 1.00       | 1.00 | 1.00  | 1.00       | 1.00 | 1.00  |
| PHF Adj:  | 1.00        | 1.00 | 1.00 | 1.00        | 1.00 | 1.00  | 1.00       | 1.00 | 1.00  | 1.00       | 1.00 | 1.00  |
| PHF Volume:   | 166         | 184  | 207  | 419         | 577  | 77    | 41         | 1528 | 512   | 316        | 656  | 89    |
| Reduct Vol:   | 0           | 0    | 0    | 0           | 0    | 0     | 0          | 0    | 0     | 0          | 0    | 0     |
| Reduced Vol:  | 166         | 184  | 207  | 419         | 577  | 77    | 41         | 1528 | 512   | 316        | 656  | 89    |
| PCE Adj:  | 1.00        | 1.00 | 1.00 | 1.00        | 1.00 | 1.00  | 1.00       | 1.00 | 1.00  | 1.00       | 1.00 | 1.00  |
| MLF Adj:  | 1.00        | 1.00 | 1.00 | 1.00        | 1.00 | 1.00  | 1.00       | 1.00 | 1.00  | 1.00       | 1.00 | 1.00  |
| Final Volume:   | 166         | 184  | 207  | 419         | 577  | 77    | 41         | 1528 | 512   | 316        | 656  | 89    |
| Saturation Flow Module:                                 |             |      |      |             |      |       |            |      |       |            |      |       |
| Sat/Lane:   | 1900        | 1900 | 1900 | 1900        | 1900 | 1900  | 1900       | 1900 | 1900  | 1900       | 1900 | 1900  |
| Adjustment:   | 0.83        | 1.00 | 0.92 | 0.83        | 0.98 | 0.95  | 0.83       | 1.00 | 0.92  | 0.83       | 1.00 | 0.92  |
| Lanes:  | 2.00        | 2.00 | 1.00 | 2.00        | 1.76 | 0.24  | 2.00       | 3.00 | 1.00  | 2.00       | 3.00 | 1.00  |
| Final Sat.:   | 3150        | 3800 | 1750 | 3150        | 3264 | 436   | 3150       | 5700 | 1750  | 3150       | 5700 | 1750  |
| Capacity Analysis Module:                               |             |      |      |             |      |       |            |      |       |            |      |       |
| Vol/Sat:  | 0.05        | 0.05 | 0.12 | 0.13        | 0.18 | 0.18  | 0.01       | 0.27 | 0.29  | 0.10       | 0.12 | 0.05  |
| Crit Moves:   | ****        | **** | **** | ****        | **** | ****  | ****       | **** | ****  | ****       | **** | ****  |
| Green Time:   | 26.3        | 39.5 | 61.1 | 18.8        | 32.0 | 32.0  | 17.9       | 98.8 | 125.1 | 21.6       | 103  | 121.3 |
| Volume/Cap:   | 0.38        | 0.23 | 0.37 | 1.34        | 1.05 | 1.05  | 0.14       | 0.52 | 0.44  | 0.88       | 0.21 | 0.08  |
| Delay/Veh:  | 79.7        | 66.7 | 53.1 | 265.5       | 134  | 134.0 | 84.2       | 40.4 | 25.7  | 109.6      | 17.0 | 6.6   |
| User DelAdj:  | 1.00        | 1.00 | 1.00 | 1.00        | 1.00 | 1.00  | 1.00       | 1.00 | 1.00  | 1.00       | 1.00 | 1.00  |
| AdjDel/Veh:   | 79.7        | 66.7 | 53.1 | 265.5       | 134  | 134.0 | 84.2       | 40.4 | 25.7  | 109.6      | 17.0 | 6.6   |
| LOS by Move:  | E           | E    | D    | F           | F    | F     | F          | D    | C     | F          | B    | A     |
| HCM2k95thQ:   | 11          | 9    | 19   | 39          | 41   | 41    | 3          | 39   | 38    | 22         | 9    | 2     |

Note: Queue reported is the number of cars per lane.

BART

Level Of Service Computation Report  
2000 HCM Operations (Future Volume Alternative)  
AM - Background Conditions

Intersection #5334: CENTRAL EXPWY/LAFAYETTE ST [Study Int 29]

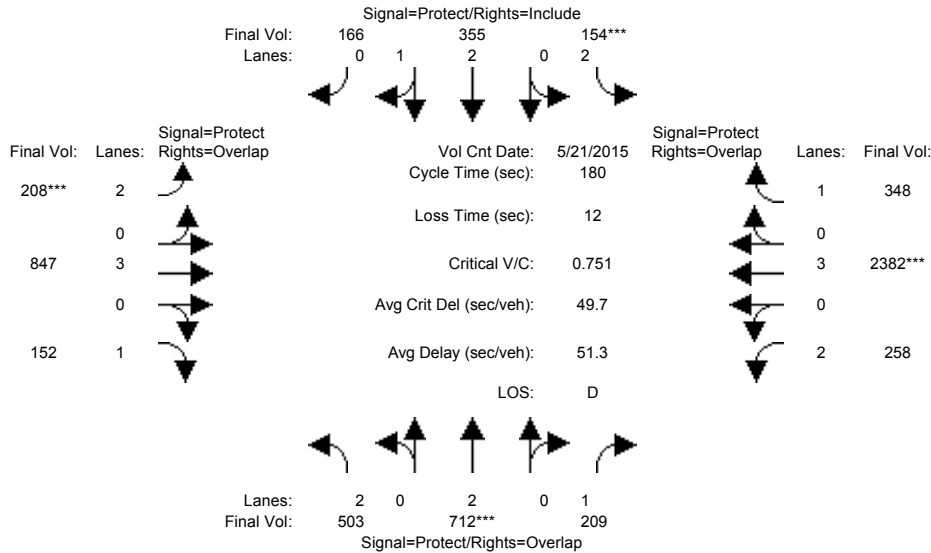

| Approach:  | North Bound |      |      | South Bound |      |      | East Bound |      |       | West Bound |      |       |
|--|-------------|------|------|-------------|------|------|------------|------|-------|------------|------|-------|
| Movement:  | L           | T    | R    | L           | T    | R    | L          | T    | R     | L          | T    | R     |
| Min. Green:  | 14          | 10   | 10   | 14          | 10   | 10   | 14         | 10   | 10    | 14         | 90   | 10    |
| Y+R:   | 4.0         | 4.0  | 4.0  | 4.0         | 4.0  | 4.0  | 4.0        | 4.0  | 4.0   | 4.0        | 4.0  | 4.0   |
| Volume Module: >> Count Date: 21 May 2015 << 7:00-9:00 |             |      |      |             |      |      |            |      |       |            |      |       |
| Base Vol:  | 503         | 712  | 209  | 154         | 355  | 166  | 208        | 847  | 152   | 258        | 2382 | 348   |
| Growth Adj:  | 1.00        | 1.00 | 1.00 | 1.00        | 1.00 | 1.00 | 1.00       | 1.00 | 1.00  | 1.00       | 1.00 | 1.00  |
| Initial Bse:   | 503         | 712  | 209  | 154         | 355  | 166  | 208        | 847  | 152   | 258        | 2382 | 348   |
| Added Vol:   | 0           | 0    | 0    | 0           | 0    | 0    | 0          | 0    | 0     | 0          | 0    | 0     |
| PasserByVol:   | 0           | 0    | 0    | 0           | 0    | 0    | 0          | 0    | 0     | 0          | 0    | 0     |
| Initial Fut:   | 503         | 712  | 209  | 154         | 355  | 166  | 208        | 847  | 152   | 258        | 2382 | 348   |
| User Adj:  | 1.00        | 1.00 | 1.00 | 1.00        | 1.00 | 1.00 | 1.00       | 1.00 | 1.00  | 1.00       | 1.00 | 1.00  |
| PHF Adj:   | 1.00        | 1.00 | 1.00 | 1.00        | 1.00 | 1.00 | 1.00       | 1.00 | 1.00  | 1.00       | 1.00 | 1.00  |
| PHF Volume:  | 503         | 712  | 209  | 154         | 355  | 166  | 208        | 847  | 152   | 258        | 2382 | 348   |
| Reduct Vol:  | 0           | 0    | 0    | 0           | 0    | 0    | 0          | 0    | 0     | 0          | 0    | 0     |
| Reduced Vol:   | 503         | 712  | 209  | 154         | 355  | 166  | 208        | 847  | 152   | 258        | 2382 | 348   |
| PCE Adj:   | 1.00        | 1.00 | 1.00 | 1.00        | 1.00 | 1.00 | 1.00       | 1.00 | 1.00  | 1.00       | 1.00 | 1.00  |
| MLF Adj:   | 1.00        | 1.00 | 1.00 | 1.00        | 1.00 | 1.00 | 1.00       | 1.00 | 1.00  | 1.00       | 1.00 | 1.00  |
| Final Volume:  | 503         | 712  | 209  | 154         | 355  | 166  | 208        | 847  | 152   | 258        | 2382 | 348   |
| Saturation Flow Module:                                |             |      |      |             |      |      |            |      |       |            |      |       |
| Sat/Lane:  | 1900        | 1900 | 1900 | 1900        | 1900 | 1900 | 1900       | 1900 | 1900  | 1900       | 1900 | 1900  |
| Adjustment:  | 1.00        | 1.00 | 1.00 | 1.00        | 1.00 | 1.00 | 1.00       | 0.85 | 1.00  | 1.00       | 1.00 | 1.00  |
| Lanes:   | 2.00        | 2.00 | 1.00 | 2.00        | 2.04 | 0.96 | 2.00       | 3.00 | 1.00  | 2.00       | 3.00 | 1.00  |
| Final Sat.:  | 3800        | 3800 | 1900 | 3800        | 3884 | 1816 | 3800       | 4845 | 1900  | 3800       | 5700 | 1900  |
| Capacity Analysis Module:                              |             |      |      |             |      |      |            |      |       |            |      |       |
| Vol/Sat:   | 0.13        | 0.19 | 0.11 | 0.04        | 0.09 | 0.09 | 0.05       | 0.17 | 0.08  | 0.07       | 0.42 | 0.18  |
| Crit Moves:  | ****        | **** | **** | ****        | **** | **** | ****       | **** | ****  | ****       | **** | ****  |
| Green Time:  | 33.9        | 43.3 | 77.4 | 14.0        | 23.4 | 23.4 | 14.0       | 76.6 | 110.5 | 34.1       | 96.7 | 110.7 |
| Volume/Cap:  | 0.70        | 0.78 | 0.26 | 0.52        | 0.70 | 0.70 | 0.70       | 0.41 | 0.13  | 0.36       | 0.78 | 0.30  |
| Delay/Veh:   | 82.0        | 81.6 | 49.5 | 85.9        | 85.5 | 85.5 | 88.4       | 36.1 | 14.6  | 63.8       | 34.5 | 16.5  |
| User DelAdj:   | 1.00        | 1.00 | 1.00 | 1.00        | 1.00 | 1.00 | 1.00       | 1.00 | 1.00  | 1.00       | 1.00 | 1.00  |
| AdjDel/Veh:  | 82.0        | 81.6 | 49.5 | 85.9        | 85.5 | 85.5 | 88.4       | 36.1 | 14.6  | 63.8       | 34.5 | 16.5  |
| LOS by Move:   | F           | F    | D    | F           | F    | F    | F          | D    | B     | E          | C    | B     |
| HCM2k95thQ:  | 24          | 33   | 18   | 8           | 18   | 18   | 11         | 19   | 7     | 12         | 61   | 22    |

Note: Queue reported is the number of cars per lane.

BART

Level Of Service Computation Report  
2000 HCM Operations (Future Volume Alternative)  
PM - Background Conditions

Intersection #5334: CENTRAL EXPWY/LAFAYETTE ST [Study Int 29]

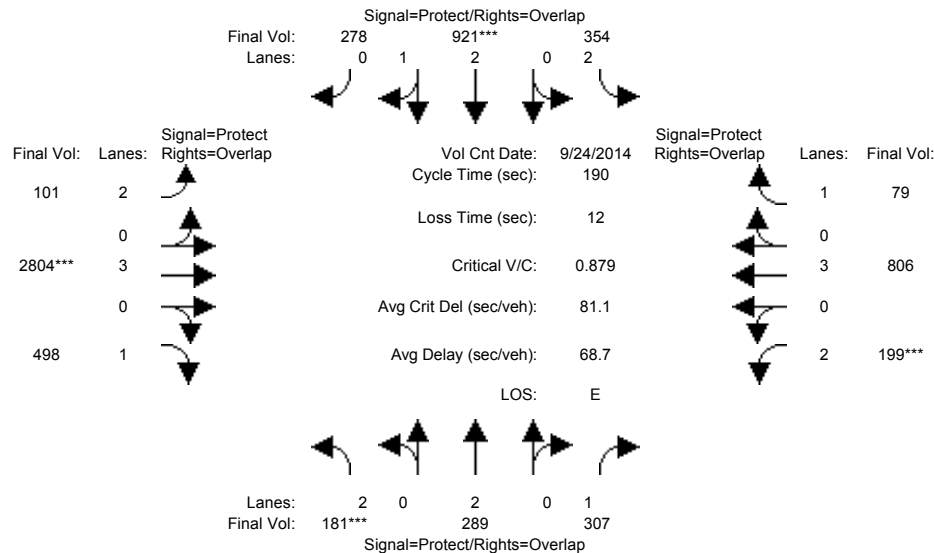

| Approach:  | North Bound |      |      | South Bound |      |      | East Bound |      |       | West Bound |      |       |
|--|-------------|------|------|-------------|------|------|------------|------|-------|------------|------|-------|
| Movement:  | L           | T    | R    | L           | T    | R    | L          | T    | R     | L          | T    | R     |
| Min. Green:  | 18          | 35   | 35   | 23          | 39   | 39   | 19         | 112  | 112   | 21         | 113  | 113   |
| Y+R:   | 4.0         | 4.0  | 4.0  | 4.0         | 4.0  | 4.0  | 4.0        | 4.0  | 4.0   | 4.0        | 4.0  | 4.0   |
| Volume Module: >> Count Date: 24 Sep 2014 << 5:00-6:00PM |             |      |      |             |      |      |            |      |       |            |      |       |
| Base Vol:  | 181         | 289  | 307  | 354         | 921  | 278  | 101        | 2804 | 498   | 199        | 806  | 79    |
| Growth Adj:  | 1.00        | 1.00 | 1.00 | 1.00        | 1.00 | 1.00 | 1.00       | 1.00 | 1.00  | 1.00       | 1.00 | 1.00  |
| Initial Bse:   | 181         | 289  | 307  | 354         | 921  | 278  | 101        | 2804 | 498   | 199        | 806  | 79    |
| Added Vol:   | 0           | 0    | 0    | 0           | 0    | 0    | 0          | 0    | 0     | 0          | 0    | 0     |
| PasserByVol:   | 0           | 0    | 0    | 0           | 0    | 0    | 0          | 0    | 0     | 0          | 0    | 0     |
| Initial Fut:   | 181         | 289  | 307  | 354         | 921  | 278  | 101        | 2804 | 498   | 199        | 806  | 79    |
| User Adj:  | 1.00        | 1.00 | 1.00 | 1.00        | 1.00 | 1.00 | 1.00       | 1.00 | 1.00  | 1.00       | 1.00 | 1.00  |
| PHF Adj:   | 1.00        | 1.00 | 1.00 | 1.00        | 1.00 | 1.00 | 1.00       | 1.00 | 1.00  | 1.00       | 1.00 | 1.00  |
| PHF Volume:  | 181         | 289  | 307  | 354         | 921  | 278  | 101        | 2804 | 498   | 199        | 806  | 79    |
| Reduct Vol:  | 0           | 0    | 0    | 0           | 0    | 0    | 0          | 0    | 0     | 0          | 0    | 0     |
| Reduced Vol:   | 181         | 289  | 307  | 354         | 921  | 278  | 101        | 2804 | 498   | 199        | 806  | 79    |
| PCE Adj:   | 1.00        | 1.00 | 1.00 | 1.00        | 1.00 | 1.00 | 1.00       | 1.00 | 1.00  | 1.00       | 1.00 | 1.00  |
| MLF Adj:   | 1.00        | 1.00 | 1.00 | 1.00        | 1.00 | 1.00 | 1.00       | 1.00 | 1.00  | 1.00       | 1.00 | 1.00  |
| Final Volume:  | 181         | 289  | 307  | 354         | 921  | 278  | 101        | 2804 | 498   | 199        | 806  | 79    |
| Saturation Flow Module:                                  |             |      |      |             |      |      |            |      |       |            |      |       |
| Sat/Lane:  | 1900        | 1900 | 1900 | 1900        | 1900 | 1900 | 1900       | 1900 | 1900  | 1900       | 1900 | 1900  |
| Adjustment:  | 0.83        | 1.00 | 0.92 | 0.83        | 0.99 | 0.95 | 0.83       | 1.00 | 0.92  | 0.83       | 1.00 | 0.92  |
| Lanes:   | 2.00        | 2.00 | 1.00 | 2.00        | 2.28 | 0.72 | 2.00       | 3.00 | 1.00  | 2.00       | 3.00 | 1.00  |
| Final Sat.:  | 3150        | 3800 | 1750 | 3150        | 4300 | 1298 | 3150       | 5700 | 1750  | 3150       | 5700 | 1750  |
| Capacity Analysis Module:                                |             |      |      |             |      |      |            |      |       |            |      |       |
| Vol/Sat:   | 0.06        | 0.08 | 0.18 | 0.11        | 0.21 | 0.21 | 0.03       | 0.49 | 0.28  | 0.06       | 0.14 | 0.05  |
| Crit Moves:  | ****        | **** | **** | ****        | **** | **** | ****       | **** | ****  | ****       | **** | ****  |
| Green Time:  | 16.8        | 32.8 | 52.4 | 21.5        | 37.4 | 55.4 | 17.9       | 105  | 121.7 | 19.7       | 107  | 128.1 |
| Volume/Cap:  | 0.65        | 0.44 | 0.64 | 0.99        | 1.09 | 0.74 | 0.34       | 0.89 | 0.44  | 0.61       | 0.25 | 0.07  |
| Delay/Veh:   | 94.7        | 75.7 | 67.3 | 135.3       | 135  | 66.6 | 86.7       | 56.3 | 27.5  | 90.5       | 22.8 | 11.3  |
| User DelAdj:   | 1.00        | 1.00 | 1.00 | 1.00        | 1.00 | 1.00 | 1.00       | 1.00 | 1.00  | 1.00       | 1.00 | 1.00  |
| AdjDel/Veh:  | 94.7        | 75.7 | 67.3 | 135.3       | 135  | 66.6 | 86.7       | 56.3 | 27.5  | 90.5       | 22.8 | 11.3  |
| LOS by Move:   | F           | E    | E    | F           | F    | E    | F          | E    | C     | F          | C    | B     |
| HCM2k95thQ:  | 13          | 15   | 31   | 27          | 50   | 38   | 7          | 84   | 37    | 14         | 15   | 4     |

Note: Queue reported is the number of cars per lane.

BART

Level Of Service Computation Report  
 2000 HCM Operations (Future Volume Alternative)  
 AM - Background Conditions

Intersection #5335: CENTRAL EXPWY/DE LA CRUZ BLVD [Study Int 30]

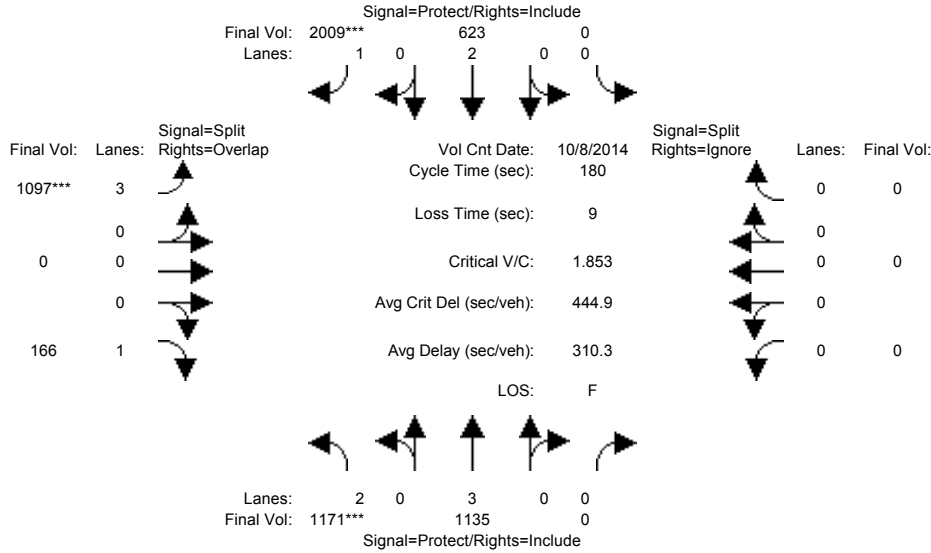

| Approach:                                   | North Bound |      |      | South Bound |      |       | East Bound |      |      | West Bound |      |      |
|---|-------------|------|------|-------------|------|-------|------------|------|------|------------|------|------|
| Movement:                                   | L           | T    | R    | L           | T    | R     | L          | T    | R    | L          | T    | R    |
| Min. Green:                                 | 7           | 10   | 0    | 0           | 10   | 10    | 10         | 0    | 10   | 0          | 0    | 0    |
| Y+R:  | 4.0         | 4.0  | 4.0  | 4.0         | 4.0  | 4.0   | 4.0        | 4.0  | 4.0  | 4.0        | 4.0  | 4.0  |
| Volume Module: >> Count Date: 8 Oct 2014 << |             |      |      |             |      |       |            |      |      |            |      |      |
| Base Vol:                                   | 1171        | 1135 | 0    | 0           | 623  | 2009  | 1097       | 0    | 166  | 0          | 0    | 0    |
| Growth Adj:                                 | 1.00        | 1.00 | 1.00 | 1.00        | 1.00 | 1.00  | 1.00       | 1.00 | 1.00 | 1.00       | 1.00 | 1.00 |
| Initial Bse:                                | 1171        | 1135 | 0    | 0           | 623  | 2009  | 1097       | 0    | 166  | 0          | 0    | 0    |
| Added Vol:                                  | 0           | 0    | 0    | 0           | 0    | 0     | 0          | 0    | 0    | 0          | 0    | 0    |
| PasserByVol:                                | 0           | 0    | 0    | 0           | 0    | 0     | 0          | 0    | 0    | 0          | 0    | 0    |
| Initial Fut:                                | 1171        | 1135 | 0    | 0           | 623  | 2009  | 1097       | 0    | 166  | 0          | 0    | 0    |
| User Adj:                                   | 1.00        | 1.00 | 1.00 | 1.00        | 1.00 | 1.00  | 1.00       | 1.00 | 1.00 | 1.00       | 1.00 | 0.00 |
| PHF Adj:                                    | 1.00        | 1.00 | 1.00 | 1.00        | 1.00 | 1.00  | 1.00       | 1.00 | 1.00 | 1.00       | 1.00 | 0.00 |
| PHF Volume:                                 | 1171        | 1135 | 0    | 0           | 623  | 2009  | 1097       | 0    | 166  | 0          | 0    | 0    |
| Reduct Vol:                                 | 0           | 0    | 0    | 0           | 0    | 0     | 0          | 0    | 0    | 0          | 0    | 0    |
| Reduced Vol:                                | 1171        | 1135 | 0    | 0           | 623  | 2009  | 1097       | 0    | 166  | 0          | 0    | 0    |
| PCE Adj:                                    | 1.00        | 1.00 | 1.00 | 1.00        | 1.00 | 1.00  | 1.00       | 1.00 | 1.00 | 1.00       | 1.00 | 0.00 |
| MLF Adj:                                    | 1.00        | 1.00 | 1.00 | 1.00        | 1.00 | 1.00  | 1.00       | 1.00 | 1.00 | 1.00       | 1.00 | 0.00 |
| Final Volume:                               | 1171        | 1135 | 0    | 0           | 623  | 2009  | 1097       | 0    | 166  | 0          | 0    | 0    |
| Saturation Flow Module:                     |             |      |      |             |      |       |            |      |      |            |      |      |
| Sat/Lane:                                   | 1900        | 1900 | 1900 | 1900        | 1900 | 1900  | 1900       | 1900 | 1900 | 1900       | 1900 | 1900 |
| Adjustment:                                 | 0.83        | 1.00 | 0.92 | 0.92        | 1.00 | 0.92  | 0.80       | 1.00 | 0.92 | 0.92       | 1.00 | 0.92 |
| Lanes:                                      | 2.00        | 3.00 | 0.00 | 0.00        | 2.00 | 1.00  | 3.00       | 0.00 | 1.00 | 0.00       | 0.00 | 0.00 |
| Final Sat.:                                 | 3150        | 5700 | 0    | 0           | 3800 | 1750  | 4551       | 0    | 1750 | 0          | 0    | 0    |
| Capacity Analysis Module:                   |             |      |      |             |      |       |            |      |      |            |      |      |
| Vol/Sat:                                    | 0.37        | 0.20 | 0.00 | 0.00        | 0.16 | 1.15  | 0.24       | 0.00 | 0.09 | 0.00       | 0.00 | 0.00 |
| Crit Moves:                                 | ****        |      |      |             |      | ****  | ****       |      |      |            |      |      |
| Green Time:                                 | 36.1        | 148  | 0.0  | 0.0         | 111  | 111.5 | 23.4       | 0.0  | 59.5 | 0.0        | 0.0  | 0.0  |
| Volume/Cap:                                 | 1.85        | 0.24 | 0.00 | 0.00        | 0.26 | 1.85  | 1.85       | 0.00 | 0.29 | 0.00       | 0.00 | 0.00 |
| Delay/Veh:                                  | 462.1       | 3.7  | 0.0  | 0.0         | 15.7 | 421.9 | 468.8      | 0.0  | 43.1 | 0.0        | 0.0  | 0.0  |
| User DelAdj:                                | 1.00        | 1.00 | 1.00 | 1.00        | 1.00 | 1.00  | 1.00       | 1.00 | 1.00 | 1.00       | 1.00 | 1.00 |
| AdjDel/Veh:                                 | 462.1       | 3.7  | 0.0  | 0.0         | 15.7 | 421.9 | 468.8      | 0.0  | 43.1 | 0.0        | 0.0  | 0.0  |
| LOS by Move:                                | F           | A    | A    | A           | B    | F     | F          | A    | D    | A          | A    | A    |
| HCM2k95thQ:                                 | 116         | 9    | 0    | 0           | 14   | 356   | 77         | 0    | 12   | 0          | 0    | 0    |

Note: Queue reported is the number of cars per lane.



BART

Level Of Service Computation Report  
 2000 HCM Operations (Future Volume Alternative)  
 PM - Background Conditions

Intersection #5335: CENTRAL EXPWY/DE LA CRUZ BLVD [Study Int 30]

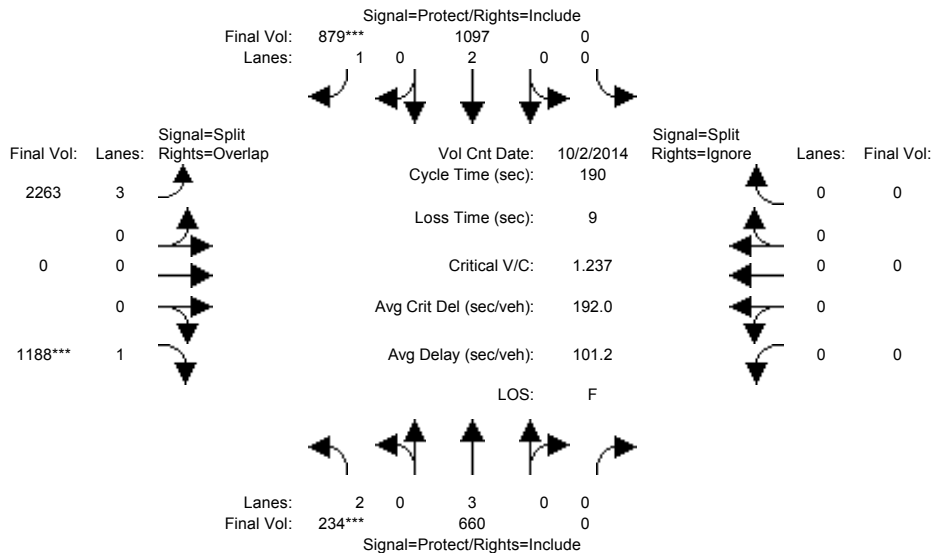

| Approach:                                   | North Bound |      |      | South Bound |      |       | East Bound |      |       | West Bound |      |      |
|---|-------------|------|------|-------------|------|-------|------------|------|-------|------------|------|------|
| Movement:                                   | L           | T    | R    | L           | T    | R     | L          | T    | R     | L          | T    | R    |
| Min. Green:                                 | 19          | 76   | 0    | 0           | 57   | 57    | 114        | 0    | 114   | 0          | 0    | 0    |
| Y+R:  | 4.0         | 4.0  | 4.0  | 4.0         | 4.0  | 4.0   | 4.0        | 4.0  | 4.0   | 4.0        | 4.0  | 4.0  |
| Volume Module: >> Count Date: 2 Oct 2014 << |             |      |      |             |      |       |            |      |       |            |      |      |
| Base Vol:                                   | 234         | 660  | 0    | 0           | 1097 | 879   | 2263       | 0    | 1188  | 0          | 0    | 0    |
| Growth Adj:                                 | 1.00        | 1.00 | 1.00 | 1.00        | 1.00 | 1.00  | 1.00       | 1.00 | 1.00  | 1.00       | 1.00 | 1.00 |
| Initial Bse:                                | 234         | 660  | 0    | 0           | 1097 | 879   | 2263       | 0    | 1188  | 0          | 0    | 0    |
| Added Vol:                                  | 0           | 0    | 0    | 0           | 0    | 0     | 0          | 0    | 0     | 0          | 0    | 0    |
| PasserByVol:                                | 0           | 0    | 0    | 0           | 0    | 0     | 0          | 0    | 0     | 0          | 0    | 0    |
| Initial Fut:                                | 234         | 660  | 0    | 0           | 1097 | 879   | 2263       | 0    | 1188  | 0          | 0    | 0    |
| User Adj:                                   | 1.00        | 1.00 | 1.00 | 1.00        | 1.00 | 1.00  | 1.00       | 1.00 | 1.00  | 1.00       | 1.00 | 0.00 |
| PHF Adj:                                    | 1.00        | 1.00 | 1.00 | 1.00        | 1.00 | 1.00  | 1.00       | 1.00 | 1.00  | 1.00       | 1.00 | 0.00 |
| PHF Volume:                                 | 234         | 660  | 0    | 0           | 1097 | 879   | 2263       | 0    | 1188  | 0          | 0    | 0    |
| Reduct Vol:                                 | 0           | 0    | 0    | 0           | 0    | 0     | 0          | 0    | 0     | 0          | 0    | 0    |
| Reduced Vol:                                | 234         | 660  | 0    | 0           | 1097 | 879   | 2263       | 0    | 1188  | 0          | 0    | 0    |
| PCE Adj:                                    | 1.00        | 1.00 | 1.00 | 1.00        | 1.00 | 1.00  | 1.00       | 1.00 | 1.00  | 1.00       | 1.00 | 0.00 |
| MLF Adj:                                    | 1.00        | 1.00 | 1.00 | 1.00        | 1.00 | 1.00  | 1.00       | 1.00 | 1.00  | 1.00       | 1.00 | 0.00 |
| Final Volume:                               | 234         | 660  | 0    | 0           | 1097 | 879   | 2263       | 0    | 1188  | 0          | 0    | 0    |
| Saturation Flow Module:                     |             |      |      |             |      |       |            |      |       |            |      |      |
| Sat/Lane:                                   | 1900        | 1900 | 1900 | 1900        | 1900 | 1900  | 1900       | 1900 | 1900  | 1900       | 1900 | 1900 |
| Adjustment:                                 | 0.83        | 1.00 | 0.92 | 0.92        | 1.00 | 0.92  | 0.80       | 1.00 | 0.92  | 0.92       | 1.00 | 0.92 |
| Lanes:                                      | 2.00        | 3.00 | 0.00 | 0.00        | 2.00 | 1.00  | 3.00       | 0.00 | 1.00  | 0.00       | 0.00 | 0.00 |
| Final Sat.:                                 | 3150        | 5700 | 0    | 0           | 3800 | 1750  | 4551       | 0    | 1750  | 0          | 0    | 0    |
| Capacity Analysis Module:                   |             |      |      |             |      |       |            |      |       |            |      |      |
| Vol/Sat:                                    | 0.07        | 0.12 | 0.00 | 0.00        | 0.29 | 0.50  | 0.50       | 0.00 | 0.68  | 0.00       | 0.00 | 0.00 |
| Crit Moves:                                 | ****        |      |      |             | **** |       |            | **** |       |            |      |      |
| Green Time:                                 | 18.1        | 72.6 | 0.0  | 0.0         | 54.4 | 54.4  | 108.8      | 0.0  | 127.0 | 0.0        | 0.0  | 0.0  |
| Volume/Cap:                                 | 0.78        | 0.30 | 0.00 | 0.00        | 1.01 | 1.75  | 0.87       | 0.00 | 1.02  | 0.00       | 0.00 | 0.00 |
| Delay/Veh:                                  | 100.1       | 43.1 | 0.0  | 0.0         | 100  | 418.3 | 26.3       | 0.0  | 42.8  | 0.0        | 0.0  | 0.0  |
| User DelAdj:                                | 1.00        | 1.00 | 1.00 | 1.00        | 1.00 | 1.00  | 1.00       | 1.00 | 1.00  | 1.00       | 1.00 | 1.00 |
| AdjDel/Veh:                                 | 100.1       | 43.1 | 0.0  | 0.0         | 100  | 418.3 | 26.3       | 0.0  | 42.8  | 0.0        | 0.0  | 0.0  |
| LOS by Move:                                | F           | D    | A    | A           | F    | F     | C          | A    | D     | A          | A    | A    |
| HCM2k95thQ:                                 | 16          | 17   | 0    | 0           | 60   | 159   | 61         | 0    | 122   | 0          | 0    | 0    |

Note: Queue reported is the number of cars per lane.

BART

Level Of Service Computation Report  
 2000 HCM Operations (Future Volume Alternative)  
 AM - Background Conditions

Intersection #5416: SAN TOMAS EXPWY/EL CAMINO REAL [Study Int 41]

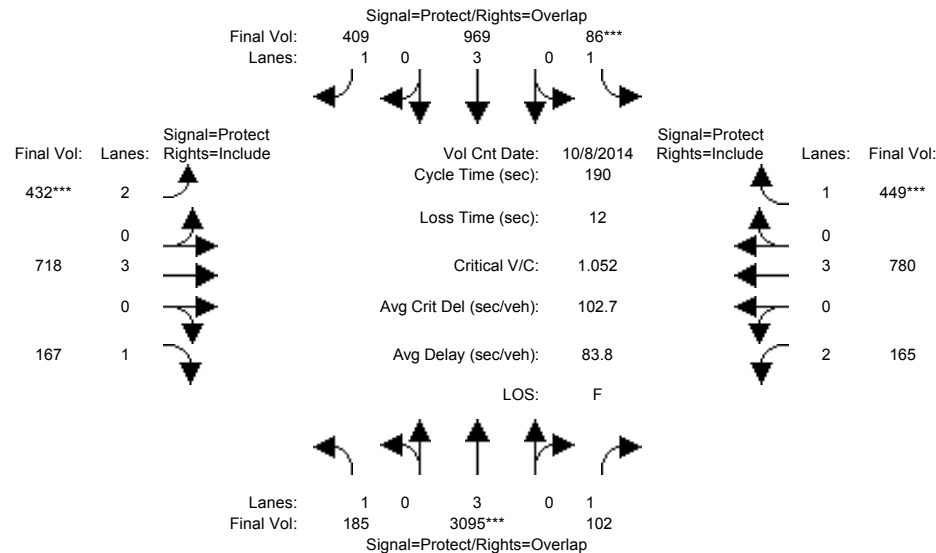

| Approach:                                   | North Bound |      |       | South Bound |      |      | East Bound |      |      | West Bound |      |       |
|---|-------------|------|-------|-------------|------|------|------------|------|------|------------|------|-------|
| Movement:                                   | L           | T    | R     | L           | T    | R    | L          | T    | R    | L          | T    | R     |
| Min. Green:                                 | 7           | 10   | 10    | 7           | 10   | 10   | 7          | 10   | 10   | 7          | 10   | 10    |
| Y+R:  | 4.0         | 4.0  | 4.0   | 4.0         | 4.0  | 4.0  | 4.0        | 4.0  | 4.0  | 4.0        | 4.0  | 4.0   |
| Volume Module: >> Count Date: 8 Oct 2014 << |             |      |       |             |      |      |            |      |      |            |      |       |
| Base Vol:                                   | 185         | 3684 | 102   | 86          | 1153 | 409  | 432        | 718  | 167  | 165        | 780  | 449   |
| Growth Adj:                                 | 1.00        | 1.00 | 1.00  | 1.00        | 1.00 | 1.00 | 1.00       | 1.00 | 1.00 | 1.00       | 1.00 | 1.00  |
| Initial Bse:                                | 185         | 3684 | 102   | 86          | 1153 | 409  | 432        | 718  | 167  | 165        | 780  | 449   |
| Added Vol:                                  | 0           | 0    | 0     | 0           | 0    | 0    | 0          | 0    | 0    | 0          | 0    | 0     |
| PasserByVol:                                | 0           | 0    | 0     | 0           | 0    | 0    | 0          | 0    | 0    | 0          | 0    | 0     |
| Initial Fut:                                | 185         | 3684 | 102   | 86          | 1153 | 409  | 432        | 718  | 167  | 165        | 780  | 449   |
| User Adj:                                   | 1.00        | 0.84 | 1.00  | 1.00        | 0.84 | 1.00 | 1.00       | 1.00 | 1.00 | 1.00       | 1.00 | 1.00  |
| PHF Adj:                                    | 1.00        | 1.00 | 1.00  | 1.00        | 1.00 | 1.00 | 1.00       | 1.00 | 1.00 | 1.00       | 1.00 | 1.00  |
| PHF Volume:                                 | 185         | 3095 | 102   | 86          | 969  | 409  | 432        | 718  | 167  | 165        | 780  | 449   |
| Reduct Vol:                                 | 0           | 0    | 0     | 0           | 0    | 0    | 0          | 0    | 0    | 0          | 0    | 0     |
| Reduced Vol:                                | 185         | 3095 | 102   | 86          | 969  | 409  | 432        | 718  | 167  | 165        | 780  | 449   |
| PCE Adj:                                    | 1.00        | 1.00 | 1.00  | 1.00        | 1.00 | 1.00 | 1.00       | 1.00 | 1.00 | 1.00       | 1.00 | 1.00  |
| MLF Adj:                                    | 1.00        | 1.00 | 1.00  | 1.00        | 1.00 | 1.00 | 1.00       | 1.00 | 1.00 | 1.00       | 1.00 | 1.00  |
| Final Volume:                               | 185         | 3095 | 102   | 86          | 969  | 409  | 432        | 718  | 167  | 165        | 780  | 449   |
| Saturation Flow Module:                     |             |      |       |             |      |      |            |      |      |            |      |       |
| Sat/Lane:                                   | 1900        | 1900 | 1900  | 1900        | 1900 | 1900 | 1900       | 1900 | 1900 | 1900       | 1900 | 1900  |
| Adjustment:                                 | 0.92        | 1.00 | 0.92  | 0.92        | 1.00 | 0.92 | 0.83       | 1.00 | 0.92 | 0.83       | 1.00 | 0.92  |
| Lanes:                                      | 1.00        | 3.00 | 1.00  | 1.00        | 3.00 | 1.00 | 2.00       | 3.00 | 1.00 | 2.00       | 3.00 | 1.00  |
| Final Sat.:                                 | 1750        | 5700 | 1750  | 1750        | 5700 | 1750 | 3150       | 5700 | 1750 | 3150       | 5700 | 1750  |
| Capacity Analysis Module:                   |             |      |       |             |      |      |            |      |      |            |      |       |
| Vol/Sat:                                    | 0.11        | 0.54 | 0.06  | 0.05        | 0.17 | 0.23 | 0.14       | 0.13 | 0.10 | 0.05       | 0.14 | 0.26  |
| Crit Moves:                                 | ****        | **** | ****  | ****        | **** | **** | ****       | **** | **** | ****       | **** | ****  |
| Green Time:                                 | 41.0        | 98.0 | 118.9 | 8.9         | 65.9 | 90.7 | 24.8       | 50.2 | 50.2 | 20.9       | 46.3 | 46.3  |
| Volume/Cap:                                 | 0.49        | 1.05 | 0.09  | 1.05        | 0.49 | 0.49 | 1.05       | 0.48 | 0.36 | 0.48       | 0.56 | 1.05  |
| Delay/Veh:                                  | 67.3        | 90.4 | 20.5  | 208.1       | 66.3 | 55.0 | 141.4      | 59.1 | 57.3 | 80.5       | 63.5 | 129.8 |
| User DelAdj:                                | 1.00        | 1.00 | 1.00  | 1.00        | 1.00 | 1.00 | 1.00       | 1.00 | 1.00 | 1.00       | 1.00 | 1.00  |
| AdjDel/Veh:                                 | 67.3        | 90.4 | 20.5  | 208.1       | 66.3 | 55.0 | 141.4      | 59.1 | 57.3 | 80.5       | 63.5 | 129.8 |
| LOS by Move:                                | E           | F    | C     | F           | E    | D    | F          | E    | E    | F          | E    | F     |
| HCM2k95thQ:                                 | 19          | 106  | 7     | 13          | 29   | 37   | 34         | 21   | 16   | 10         | 23   | 54    |

Note: Queue reported is the number of cars per lane.

BART

Level Of Service Computation Report  
 2000 HCM Operations (Future Volume Alternative)  
 PM - Background Conditions

Intersection #5416: SAN TOMAS EXPWY/EL CAMINO REAL [Study Int 41]

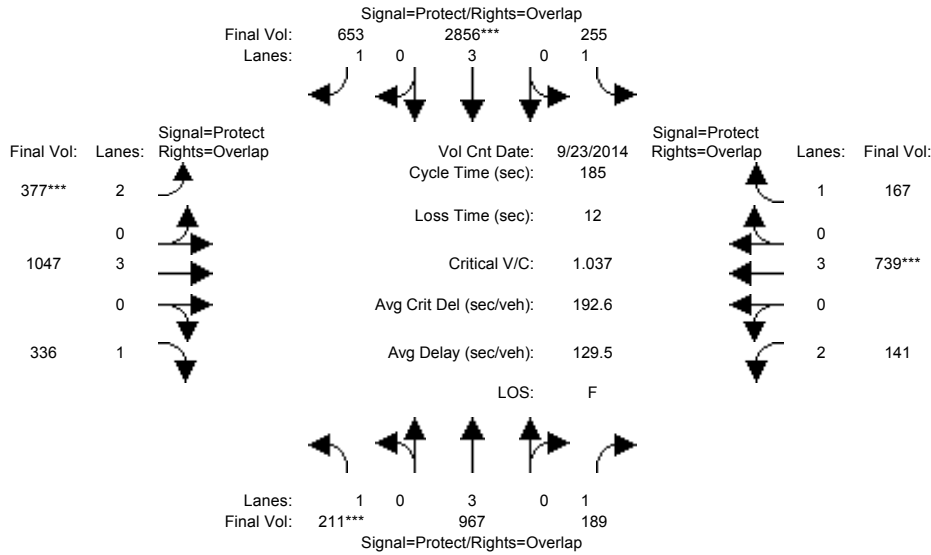

| Approach:                                    | North Bound |      |      | South Bound |      |       | East Bound |      |      | West Bound |      |      |
|--|-------------|------|------|-------------|------|-------|------------|------|------|------------|------|------|
| Movement:                                    | L           | T    | R    | L           | T    | R     | L          | T    | R    | L          | T    | R    |
| Min. Green:                                  | 12          | 72   | 72   | 33          | 93   | 93    | 39         | 50   | 50   | 29         | 41   | 41   |
| Y+R:   | 4.0         | 4.0  | 4.0  | 4.0         | 4.0  | 4.0   | 4.0        | 4.0  | 4.0  | 4.0        | 4.0  | 4.0  |
| Volume Module: >> Count Date: 23 Sep 2014 << |             |      |      |             |      |       |            |      |      |            |      |      |
| Base Vol:                                    | 211         | 1273 | 189  | 255         | 3709 | 653   | 377        | 1047 | 336  | 141        | 739  | 167  |
| Growth Adj:                                  | 1.00        | 1.00 | 1.00 | 1.00        | 1.00 | 1.00  | 1.00       | 1.00 | 1.00 | 1.00       | 1.00 | 1.00 |
| Initial Bse:                                 | 211         | 1273 | 189  | 255         | 3709 | 653   | 377        | 1047 | 336  | 141        | 739  | 167  |
| Added Vol:                                   | 0           | 0    | 0    | 0           | 0    | 0     | 0          | 0    | 0    | 0          | 0    | 0    |
| PasserByVol:                                 | 0           | 0    | 0    | 0           | 0    | 0     | 0          | 0    | 0    | 0          | 0    | 0    |
| Initial Fut:                                 | 211         | 1273 | 189  | 255         | 3709 | 653   | 377        | 1047 | 336  | 141        | 739  | 167  |
| User Adj:                                    | 1.00        | 0.76 | 1.00 | 1.00        | 0.77 | 1.00  | 1.00       | 1.00 | 1.00 | 1.00       | 1.00 | 1.00 |
| PHF Adj:                                     | 1.00        | 1.00 | 1.00 | 1.00        | 1.00 | 1.00  | 1.00       | 1.00 | 1.00 | 1.00       | 1.00 | 1.00 |
| PHF Volume:                                  | 211         | 967  | 189  | 255         | 2856 | 653   | 377        | 1047 | 336  | 141        | 739  | 167  |
| Reduct Vol:                                  | 0           | 0    | 0    | 0           | 0    | 0     | 0          | 0    | 0    | 0          | 0    | 0    |
| Reduced Vol:                                 | 211         | 967  | 189  | 255         | 2856 | 653   | 377        | 1047 | 336  | 141        | 739  | 167  |
| PCE Adj:                                     | 1.00        | 1.00 | 1.00 | 1.00        | 1.00 | 1.00  | 1.00       | 1.00 | 1.00 | 1.00       | 1.00 | 1.00 |
| MLF Adj:                                     | 1.00        | 1.00 | 1.00 | 1.00        | 1.00 | 1.00  | 1.00       | 1.00 | 1.00 | 1.00       | 1.00 | 1.00 |
| Final Volume:                                | 211         | 967  | 189  | 255         | 2856 | 653   | 377        | 1047 | 336  | 141        | 739  | 167  |
| Saturation Flow Module:                      |             |      |      |             |      |       |            |      |      |            |      |      |
| Sat/Lane:                                    | 1900        | 1900 | 1900 | 1900        | 1900 | 1900  | 1900       | 1900 | 1900 | 1900       | 1900 | 1900 |
| Adjustment:                                  | 0.92        | 1.00 | 0.92 | 0.92        | 0.83 | 0.92  | 0.83       | 1.00 | 0.92 | 0.83       | 1.00 | 0.92 |
| Lanes:                                       | 1.00        | 3.00 | 1.00 | 1.00        | 3.00 | 1.00  | 2.00       | 3.00 | 1.00 | 2.00       | 3.00 | 1.00 |
| Final Sat.:                                  | 1750        | 5700 | 1750 | 1750        | 4731 | 1750  | 3150       | 5700 | 1750 | 3150       | 5700 | 1750 |
| Capacity Analysis Module:                    |             |      |      |             |      |       |            |      |      |            |      |      |
| Vol/Sat:                                     | 0.12        | 0.17 | 0.11 | 0.15        | 0.60 | 0.37  | 0.12       | 0.18 | 0.19 | 0.04       | 0.13 | 0.10 |
| Crit Moves:                                  | ****        |      |      | ****        |      |       | ****       |      |      | ****       |      |      |
| Green Time:                                  | 11.3        | 67.6 | 95.2 | 31.0        | 87.3 | 124.0 | 36.6       | 47.5 | 58.8 | 27.6       | 38.5 | 69.5 |
| Volume/Cap:                                  | 1.98        | 0.46 | 0.21 | 0.87        | 1.28 | 0.56  | 0.60       | 0.71 | 0.60 | 0.30       | 0.62 | 0.25 |
| Delay/Veh:                                   | 565.0       | 53.1 | 32.9 | 113.9       | 212  | 40.9  | 73.7       | 68.3 | 58.6 | 75.0       | 72.0 | 42.7 |
| User DelAdj:                                 | 1.00        | 1.00 | 1.00 | 1.00        | 1.00 | 1.00  | 1.00       | 1.00 | 1.00 | 1.00       | 1.00 | 1.00 |
| AdjDel/Veh:                                  | 565.0       | 53.1 | 32.9 | 113.9       | 212  | 40.9  | 73.7       | 68.3 | 58.6 | 75.0       | 72.0 | 42.7 |
| LOS by Move:                                 | F           | D    | C    | F           | F    | D     | E          | E    | E    | E          | E    | D    |
| HCM2k95thQ:                                  | 45          | 28   | 15   | 30          | 123  | 57    | 23         | 33   | 31   | 9          | 24   | 14   |

Note: Queue reported is the number of cars per lane.

BART

Level Of Service Computation Report  
2000 HCM Operations (Future Volume Alternative)  
AM - Background Conditions

Intersection #5444: Lafayette/Lewis [Study Int 47]

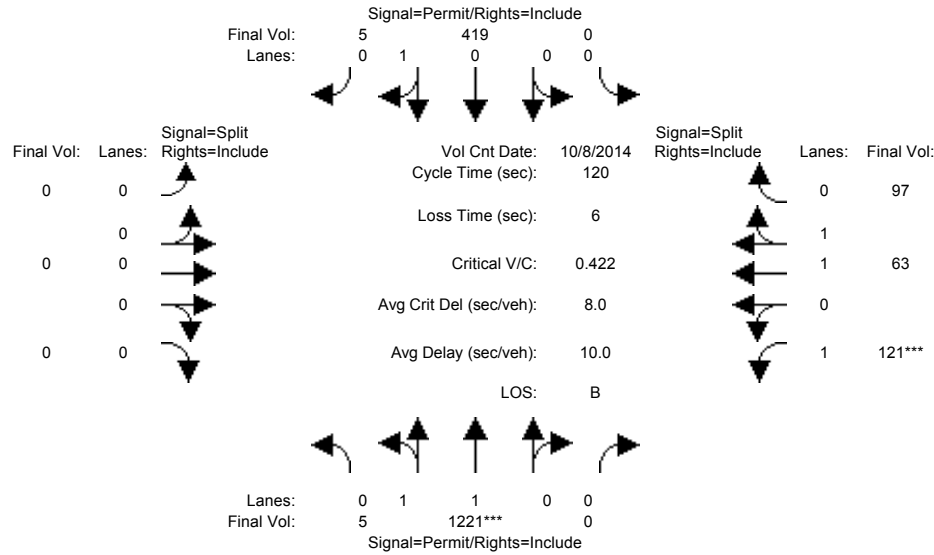

| Approach:   | North Bound                  |      |      | South Bound |      |      | East Bound |      |      | West Bound |      |      |    |
|---|------------------------------|------|------|-------------|------|------|------------|------|------|------------|------|------|----|
| Movement:   | L                            | T    | R    | L           | T    | R    | L          | T    | R    | L          | T    | R    |    |
| Min. Green:   | 10                           | 10   | 0    | 0           | 10   | 10   | 0          | 0    | 0    | 10         | 10   | 10   |    |
| Y+R:  | 4.0                          | 4.0  | 4.0  | 4.0         | 4.0  | 4.0  | 4.0        | 4.0  | 4.0  | 4.0        | 4.0  | 4.0  |    |
| ----- ----- ----- ----- ----- ----- ----- ----- ----- ----- ----- ----- ----- |                              |      |      |             |      |      |            |      |      |            |      |      |    |
| Volume Module:  | >> Count Date: 8 Oct 2014 << |      |      |             |      |      |            |      |      |            |      |      |    |
| Base Vol:   | 5                            | 1221 | 0    | 0           | 0    | 419  | 5          | 0    | 0    | 0          | 121  | 63   | 97 |
| Growth Adj:   | 1.00                         | 1.00 | 1.00 | 1.00        | 1.00 | 1.00 | 1.00       | 1.00 | 1.00 | 1.00       | 1.00 | 1.00 |    |
| Initial Bse:  | 5                            | 1221 | 0    | 0           | 0    | 419  | 5          | 0    | 0    | 0          | 121  | 63   | 97 |
| Added Vol:  | 0                            | 0    | 0    | 0           | 0    | 0    | 0          | 0    | 0    | 0          | 0    | 0    | 0  |
| PasserByVol:  | 0                            | 0    | 0    | 0           | 0    | 0    | 0          | 0    | 0    | 0          | 0    | 0    | 0  |
| Initial Fut:  | 5                            | 1221 | 0    | 0           | 0    | 419  | 5          | 0    | 0    | 0          | 121  | 63   | 97 |
| User Adj:   | 1.00                         | 1.00 | 1.00 | 1.00        | 1.00 | 1.00 | 1.00       | 1.00 | 1.00 | 1.00       | 1.00 | 1.00 |    |
| PHF Adj:  | 1.00                         | 1.00 | 1.00 | 1.00        | 1.00 | 1.00 | 1.00       | 1.00 | 1.00 | 1.00       | 1.00 | 1.00 |    |
| PHF Volume:   | 5                            | 1221 | 0    | 0           | 0    | 419  | 5          | 0    | 0    | 0          | 121  | 63   | 97 |
| Reduct Vol:   | 0                            | 0    | 0    | 0           | 0    | 0    | 0          | 0    | 0    | 0          | 0    | 0    | 0  |
| Reduced Vol:  | 5                            | 1221 | 0    | 0           | 0    | 419  | 5          | 0    | 0    | 0          | 121  | 63   | 97 |
| PCE Adj:  | 1.00                         | 1.00 | 1.00 | 1.00        | 1.00 | 1.00 | 1.00       | 1.00 | 1.00 | 1.00       | 1.00 | 1.00 |    |
| MLF Adj:  | 1.00                         | 1.00 | 1.00 | 1.00        | 1.00 | 1.00 | 1.00       | 1.00 | 1.00 | 1.00       | 1.00 | 1.00 |    |
| FinalVolume:  | 5                            | 1221 | 0    | 0           | 0    | 419  | 5          | 0    | 0    | 0          | 121  | 63   | 97 |
| ----- ----- ----- ----- ----- ----- ----- ----- ----- ----- ----- -----       |                              |      |      |             |      |      |            |      |      |            |      |      |    |
| Saturation Flow Module:   |                              |      |      |             |      |      |            |      |      |            |      |      |    |
| Sat/Lane:   | 1900                         | 1900 | 1900 | 1900        | 1900 | 1900 | 1900       | 1900 | 1900 | 1900       | 1900 | 1900 |    |
| Adjustment:   | 0.95                         | 0.97 | 0.92 | 0.92        | 0.95 | 0.95 | 0.92       | 1.00 | 0.92 | 0.92       | 1.00 | 0.92 |    |
| Lanes:  | 0.01                         | 1.99 | 0.00 | 0.00        | 0.99 | 0.01 | 0.00       | 0.00 | 0.00 | 1.00       | 1.00 | 1.00 |    |
| Final Sat.:   | 15                           | 3685 | 0    | 0           | 1779 | 21   | 0          | 0    | 0    | 1750       | 1900 | 1750 |    |
| ----- ----- ----- ----- ----- ----- ----- ----- ----- ----- ----- -----       |                              |      |      |             |      |      |            |      |      |            |      |      |    |
| Capacity Analysis Module:   |                              |      |      |             |      |      |            |      |      |            |      |      |    |
| Vol/Sat:  | 0.33                         | 0.33 | 0.00 | 0.00        | 0.24 | 0.24 | 0.00       | 0.00 | 0.00 | 0.07       | 0.03 | 0.06 |    |
| Crit Moves:   | *****                        |      |      |             |      |      |            |      |      |            |      |      |    |
| Green Time:   | 94.3                         | 94.3 | 0.0  | 0.0         | 94.3 | 94.3 | 0.0        | 0.0  | 0.0  | 19.7       | 19.7 | 19.7 |    |
| Volume/Cap:   | 0.42                         | 0.42 | 0.00 | 0.00        | 0.30 | 0.30 | 0.00       | 0.00 | 0.00 | 0.42       | 0.20 | 0.34 |    |
| Delay/Veh:  | 4.2                          | 4.2  | 0.0  | 0.0         | 3.7  | 3.7  | 0.0        | 0.0  | 0.0  | 46.0       | 43.5 | 44.8 |    |
| User DelAdj:  | 1.00                         | 1.00 | 1.00 | 1.00        | 1.00 | 1.00 | 1.00       | 1.00 | 1.00 | 1.00       | 1.00 | 1.00 |    |
| AdjDel/Veh:   | 4.2                          | 4.2  | 0.0  | 0.0         | 3.7  | 3.7  | 0.0        | 0.0  | 0.0  | 46.0       | 43.5 | 44.8 |    |
| LOS by Move:  | A                            | A    | A    | A           | A    | A    | A          | A    | A    | D          | D    | D    |    |
| HCM2k95thQ:   | 14                           | 14   | 0    | 0           | 9    | 9    | 0          | 0    | 0    | 9          | 4    | 7    |    |

Note: Queue reported is the number of cars per lane.

BART

Level Of Service Computation Report  
2000 HCM Operations (Future Volume Alternative)  
PM - Background Conditions

Intersection #5444: Lafayette/Lewis [Study Int 47]

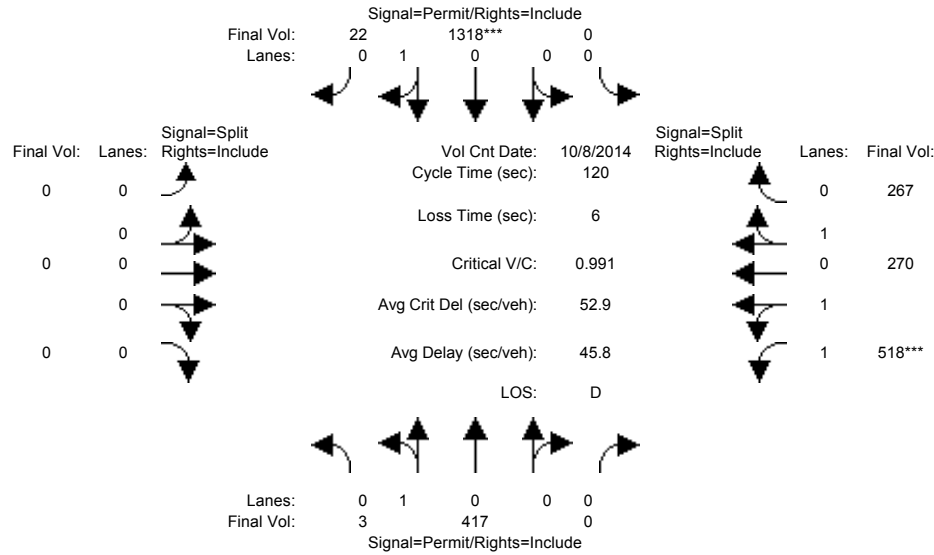

| Approach:                                   | North Bound |      |      | South Bound |      |      | East Bound |      |      | West Bound |      |      |
|---|-------------|------|------|-------------|------|------|------------|------|------|------------|------|------|
| Movement:                                   | L           | T    | R    | L           | T    | R    | L          | T    | R    | L          | T    | R    |
| Min. Green:                                 | 10          | 10   | 0    | 0           | 10   | 10   | 0          | 0    | 0    | 10         | 10   | 10   |
| Y+R:  | 4.0         | 4.0  | 4.0  | 4.0         | 4.0  | 4.0  | 4.0        | 4.0  | 4.0  | 4.0        | 4.0  | 4.0  |
| Volume Module: >> Count Date: 8 Oct 2014 << |             |      |      |             |      |      |            |      |      |            |      |      |
| Base Vol:                                   | 3           | 417  | 0    | 0           | 1318 | 22   | 0          | 0    | 0    | 518        | 270  | 267  |
| Growth Adj:                                 | 1.00        | 1.00 | 1.00 | 1.00        | 1.00 | 1.00 | 1.00       | 1.00 | 1.00 | 1.00       | 1.00 | 1.00 |
| Initial Bse:                                | 3           | 417  | 0    | 0           | 1318 | 22   | 0          | 0    | 0    | 518        | 270  | 267  |
| Added Vol:                                  | 0           | 0    | 0    | 0           | 0    | 0    | 0          | 0    | 0    | 0          | 0    | 0    |
| PasserByVol:                                | 0           | 0    | 0    | 0           | 0    | 0    | 0          | 0    | 0    | 0          | 0    | 0    |
| Initial Fut:                                | 3           | 417  | 0    | 0           | 1318 | 22   | 0          | 0    | 0    | 518        | 270  | 267  |
| User Adj:                                   | 1.00        | 1.00 | 1.00 | 1.00        | 1.00 | 1.00 | 1.00       | 1.00 | 1.00 | 1.00       | 1.00 | 1.00 |
| PHF Adj:                                    | 1.00        | 1.00 | 1.00 | 1.00        | 1.00 | 1.00 | 1.00       | 1.00 | 1.00 | 1.00       | 1.00 | 1.00 |
| PHF Volume:                                 | 3           | 417  | 0    | 0           | 1318 | 22   | 0          | 0    | 0    | 518        | 270  | 267  |
| Reduct Vol:                                 | 0           | 0    | 0    | 0           | 0    | 0    | 0          | 0    | 0    | 0          | 0    | 0    |
| Reduced Vol:                                | 3           | 417  | 0    | 0           | 1318 | 22   | 0          | 0    | 0    | 518        | 270  | 267  |
| PCE Adj:                                    | 1.00        | 1.00 | 1.00 | 1.00        | 1.00 | 1.00 | 1.00       | 1.00 | 1.00 | 1.00       | 1.00 | 1.00 |
| MLF Adj:                                    | 1.00        | 1.00 | 1.00 | 1.00        | 1.00 | 1.00 | 1.00       | 1.00 | 1.00 | 1.00       | 1.00 | 1.00 |
| Final Volume:                               | 3           | 417  | 0    | 0           | 1318 | 22   | 0          | 0    | 0    | 518        | 270  | 267  |
| Saturation Flow Module:                     |             |      |      |             |      |      |            |      |      |            |      |      |
| Sat/Lane:                                   | 1900        | 1900 | 1900 | 1900        | 1900 | 1900 | 1900       | 1900 | 1900 | 1900       | 1900 | 1900 |
| Adjustment:                                 | 0.95        | 0.95 | 0.92 | 0.92        | 0.95 | 0.95 | 0.92       | 1.00 | 0.92 | 0.93       | 0.95 | 0.95 |
| Lanes:                                      | 0.01        | 0.99 | 0.00 | 0.00        | 0.98 | 0.02 | 0.00       | 0.00 | 0.00 | 1.49       | 0.76 | 0.75 |
| Final Sat.:                                 | 13          | 1787 | 0    | 0           | 1770 | 30   | 0          | 0    | 0    | 2627       | 1369 | 1354 |
| Capacity Analysis Module:                   |             |      |      |             |      |      |            |      |      |            |      |      |
| Vol/Sat:                                    | 0.23        | 0.23 | 0.00 | 0.00        | 0.74 | 0.74 | 0.00       | 0.00 | 0.00 | 0.20       | 0.20 | 0.20 |
| Crit Moves:                                 | *****       |      |      |             |      |      |            |      |      |            |      |      |
| Green Time:                                 | 90.1        | 90.1 | 0.0  | 0.0         | 90.1 | 90.1 | 0.0        | 0.0  | 0.0  | 23.9       | 23.9 | 23.9 |
| Volume/Cap:                                 | 0.31        | 0.31 | 0.00 | 0.00        | 0.99 | 0.99 | 0.00       | 0.00 | 0.00 | 0.99       | 0.99 | 0.99 |
| Delay/Veh:                                  | 5.0         | 5.0  | 0.0  | 0.0         | 36.9 | 36.9 | 0.0        | 0.0  | 0.0  | 73.3       | 73.3 | 73.3 |
| User DelAdj:                                | 1.00        | 1.00 | 1.00 | 1.00        | 1.00 | 1.00 | 1.00       | 1.00 | 1.00 | 1.00       | 1.00 | 1.00 |
| AdjDel/Veh:                                 | 5.0         | 5.0  | 0.0  | 0.0         | 36.9 | 36.9 | 0.0        | 0.0  | 0.0  | 73.3       | 73.3 | 73.3 |
| LOS by Move:                                | A           | A    | A    | A           | D    | D    | A          | A    | A    | E          | E    | E    |
| HCM2k95thQ:                                 | 10          | 10   | 0    | 0           | 84   | 84   | 0          | 0    | 0    | 33         | 33   | 33   |

Note: Queue reported is the number of cars per lane.

BART

Level Of Service Computation Report  
 2000 HCM Operations (Future Volume Alternative)  
 AM - Bkgrd + Proj Conditions

Intersection #6: DE LA CRUZ/MARTIN [Study Int 31]

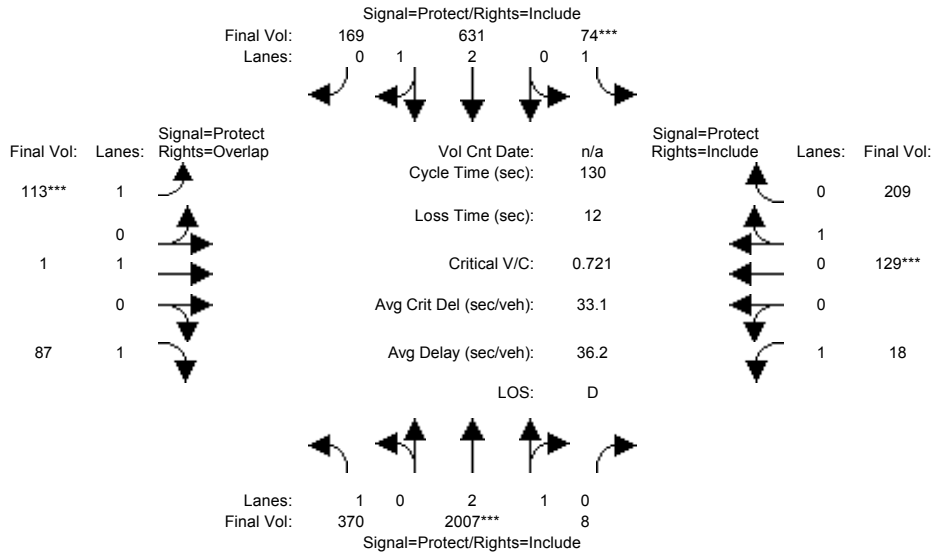

| Approach:                 | North Bound |      |      | South Bound |      |      | East Bound |      |      | West Bound |      |      |
|---------------------------|-------------|------|------|-------------|------|------|------------|------|------|------------|------|------|
|                           | L           | T    | R    | L           | T    | R    | L          | T    | R    | L          | T    | R    |
| Min. Green:               | 7           | 10   | 10   | 7           | 10   | 10   | 7          | 10   | 10   | 7          | 10   | 10   |
| Y+R:                      | 4.0         | 4.0  | 4.0  | 4.0         | 4.0  | 4.0  | 4.0        | 4.0  | 4.0  | 4.0        | 4.0  | 4.0  |
| Volume Module:            |             |      |      |             |      |      |            |      |      |            |      |      |
| Base Vol:                 | 370         | 2007 | 8    | 74          | 631  | 169  | 113        | 1    | 87   | 18         | 129  | 209  |
| Growth Adj:               | 1.00        | 1.00 | 1.00 | 1.00        | 1.00 | 1.00 | 1.00       | 1.00 | 1.00 | 1.00       | 1.00 | 1.00 |
| Initial Bse:              | 370         | 2007 | 8    | 74          | 631  | 169  | 113        | 1    | 87   | 18         | 129  | 209  |
| Added Vol:                | 0           | 0    | 0    | 0           | 0    | 0    | 0          | 0    | 0    | 0          | 0    | 0    |
| PasserByVol:              | 0           | 0    | 0    | 0           | 0    | 0    | 0          | 0    | 0    | 0          | 0    | 0    |
| Initial Fut:              | 370         | 2007 | 8    | 74          | 631  | 169  | 113        | 1    | 87   | 18         | 129  | 209  |
| User Adj:                 | 1.00        | 1.00 | 1.00 | 1.00        | 1.00 | 1.00 | 1.00       | 1.00 | 1.00 | 1.00       | 1.00 | 1.00 |
| PHF Adj:                  | 1.00        | 1.00 | 1.00 | 1.00        | 1.00 | 1.00 | 1.00       | 1.00 | 1.00 | 1.00       | 1.00 | 1.00 |
| PHF Volume:               | 370         | 2007 | 8    | 74          | 631  | 169  | 113        | 1    | 87   | 18         | 129  | 209  |
| Reduct Vol:               | 0           | 0    | 0    | 0           | 0    | 0    | 0          | 0    | 0    | 0          | 0    | 0    |
| Reduced Vol:              | 370         | 2007 | 8    | 74          | 631  | 169  | 113        | 1    | 87   | 18         | 129  | 209  |
| PCE Adj:                  | 1.00        | 1.00 | 1.00 | 1.00        | 1.00 | 1.00 | 1.00       | 1.00 | 1.00 | 1.00       | 1.00 | 1.00 |
| MLF Adj:                  | 1.00        | 1.00 | 1.00 | 1.00        | 1.00 | 1.00 | 1.00       | 1.00 | 1.00 | 1.00       | 1.00 | 1.00 |
| Final Volume:             | 370         | 2007 | 8    | 74          | 631  | 169  | 113        | 1    | 87   | 18         | 129  | 209  |
| Saturation Flow Module:   |             |      |      |             |      |      |            |      |      |            |      |      |
| Sat/Lane:                 | 1900        | 1900 | 1900 | 1900        | 1900 | 1900 | 1900       | 1900 | 1900 | 1900       | 1900 | 1900 |
| Adjustment:               | 0.92        | 0.98 | 0.95 | 0.92        | 0.99 | 0.95 | 0.92       | 1.00 | 0.92 | 0.92       | 0.95 | 0.95 |
| Lanes:                    | 1.00        | 2.99 | 0.01 | 1.00        | 2.34 | 0.66 | 1.00       | 1.00 | 1.00 | 1.00       | 0.38 | 0.62 |
| Final Sat.:               | 1750        | 5578 | 22   | 1750        | 4415 | 1183 | 1750       | 1900 | 1750 | 1750       | 687  | 1113 |
| Capacity Analysis Module: |             |      |      |             |      |      |            |      |      |            |      |      |
| Vol/Sat:                  | 0.21        | 0.36 | 0.36 | 0.04        | 0.14 | 0.14 | 0.06       | 0.00 | 0.05 | 0.01       | 0.19 | 0.19 |
| Crit Moves:               | ****        | **** | **** | ****        | **** | **** | ****       | **** | **** | ****       | **** | **** |
| Green Time:               | 43.3        | 64.9 | 64.9 | 7.6         | 29.2 | 29.2 | 11.6       | 26.8 | 70.0 | 18.7       | 33.9 | 33.9 |
| Volume/Cap:               | 0.64        | 0.72 | 0.72 | 0.72        | 0.64 | 0.64 | 0.72       | 0.00 | 0.09 | 0.07       | 0.72 | 0.72 |
| Delay/Veh:                | 39.0        | 26.4 | 26.4 | 82.1        | 46.6 | 46.6 | 72.7       | 41.0 | 14.6 | 48.2       | 49.2 | 49.2 |
| User DelAdj:              | 1.00        | 1.00 | 1.00 | 1.00        | 1.00 | 1.00 | 1.00       | 1.00 | 1.00 | 1.00       | 1.00 | 1.00 |
| AdjDel/Veh:               | 39.0        | 26.4 | 26.4 | 82.1        | 46.6 | 46.6 | 72.7       | 41.0 | 14.6 | 48.2       | 49.2 | 49.2 |
| LOS by Move:              | D           | C    | C    | F           | D    | D    | E          | D    | B    | D          | D    | D    |
| HCM2k95shQ:               | 24          | 36   | 36   | 7           | 18   | 18   | 10         | 0    | 4    | 1          | 25   | 25   |

Note: Queue reported is the number of cars per lane.

BART

Level Of Service Computation Report  
2000 HCM Operations (Future Volume Alternative)  
PM - Bkgrd + Proj Conditions

Intersection #6: DE LA CRUZ/MARTIN [Study Int 31]

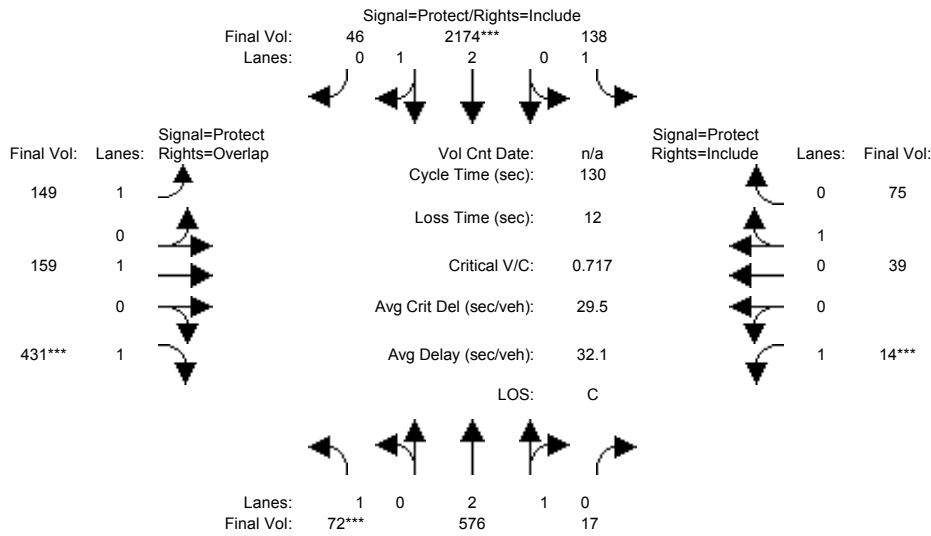

| Approach:                 | North Bound |      |      | South Bound |      |      | East Bound |      |      | West Bound |      |      |
|---------------------------|-------------|------|------|-------------|------|------|------------|------|------|------------|------|------|
| Movement:                 | L           | T    | R    | L           | T    | R    | L          | T    | R    | L          | T    | R    |
| Min. Green:               | 7           | 10   | 10   | 7           | 10   | 10   | 7          | 10   | 10   | 7          | 10   | 10   |
| Y+R:                      | 4.0         | 4.0  | 4.0  | 4.0         | 4.0  | 4.0  | 4.0        | 4.0  | 4.0  | 4.0        | 4.0  | 4.0  |
| Volume Module:            |             |      |      |             |      |      |            |      |      |            |      |      |
| Base Vol:                 | 72          | 576  | 17   | 138         | 2174 | 46   | 149        | 159  | 431  | 14         | 39   | 75   |
| Growth Adj:               | 1.00        | 1.00 | 1.00 | 1.00        | 1.00 | 1.00 | 1.00       | 1.00 | 1.00 | 1.00       | 1.00 | 1.00 |
| Initial Bse:              | 72          | 576  | 17   | 138         | 2174 | 46   | 149        | 159  | 431  | 14         | 39   | 75   |
| Added Vol:                | 0           | 0    | 0    | 0           | 0    | 0    | 0          | 0    | 0    | 0          | 0    | 0    |
| PasserByVol:              | 0           | 0    | 0    | 0           | 0    | 0    | 0          | 0    | 0    | 0          | 0    | 0    |
| Initial Fut:              | 72          | 576  | 17   | 138         | 2174 | 46   | 149        | 159  | 431  | 14         | 39   | 75   |
| User Adj:                 | 1.00        | 1.00 | 1.00 | 1.00        | 1.00 | 1.00 | 1.00       | 1.00 | 1.00 | 1.00       | 1.00 | 1.00 |
| PHF Adj:                  | 1.00        | 1.00 | 1.00 | 1.00        | 1.00 | 1.00 | 1.00       | 1.00 | 1.00 | 1.00       | 1.00 | 1.00 |
| PHF Volume:               | 72          | 576  | 17   | 138         | 2174 | 46   | 149        | 159  | 431  | 14         | 39   | 75   |
| Reduct Vol:               | 0           | 0    | 0    | 0           | 0    | 0    | 0          | 0    | 0    | 0          | 0    | 0    |
| Reduced Vol:              | 72          | 576  | 17   | 138         | 2174 | 46   | 149        | 159  | 431  | 14         | 39   | 75   |
| PCE Adj:                  | 1.00        | 1.00 | 1.00 | 1.00        | 1.00 | 1.00 | 1.00       | 1.00 | 1.00 | 1.00       | 1.00 | 1.00 |
| MLF Adj:                  | 1.00        | 1.00 | 1.00 | 1.00        | 1.00 | 1.00 | 1.00       | 1.00 | 1.00 | 1.00       | 1.00 | 1.00 |
| Final Volume:             | 72          | 576  | 17   | 138         | 2174 | 46   | 149        | 159  | 431  | 14         | 39   | 75   |
| Saturation Flow Module:   |             |      |      |             |      |      |            |      |      |            |      |      |
| Sat/Lane:                 | 1900        | 1900 | 1900 | 1900        | 1900 | 1900 | 1900       | 1900 | 1900 | 1900       | 1900 | 1900 |
| Adjustment:               | 0.92        | 0.98 | 0.95 | 0.92        | 0.98 | 0.95 | 0.92       | 1.00 | 0.92 | 0.92       | 0.95 | 0.95 |
| Lanes:                    | 1.00        | 2.91 | 0.09 | 1.00        | 2.94 | 0.06 | 1.00       | 1.00 | 1.00 | 1.00       | 0.34 | 0.66 |
| Final Sat.:               | 1750        | 5439 | 161  | 1750        | 5484 | 116  | 1750       | 1900 | 1750 | 1750       | 616  | 1184 |
| Capacity Analysis Module: |             |      |      |             |      |      |            |      |      |            |      |      |
| Vol/Sat:                  | 0.04        | 0.11 | 0.11 | 0.08        | 0.40 | 0.40 | 0.09       | 0.08 | 0.25 | 0.01       | 0.06 | 0.06 |
| Crit Moves:               | ****        |      |      | ****        |      |      | ****       |      | **** | ****       |      |      |
| Green Time:               | 7.2         | 44.2 | 44.2 | 32.9        | 69.8 | 69.8 | 21.5       | 33.9 | 41.2 | 7.0        | 19.4 | 19.4 |
| Volume/Cap:               | 0.74        | 0.31 | 0.31 | 0.31        | 0.74 | 0.74 | 0.52       | 0.32 | 0.78 | 0.15       | 0.42 | 0.42 |
| Delay/Veh:                | 85.8        | 31.8 | 31.8 | 39.8        | 24.0 | 24.0 | 51.1       | 39.1 | 47.2 | 59.4       | 51.3 | 51.3 |
| User DelAdj:              | 1.00        | 1.00 | 1.00 | 1.00        | 1.00 | 1.00 | 1.00       | 1.00 | 1.00 | 1.00       | 1.00 | 1.00 |
| AdjDel/Veh:               | 85.8        | 31.8 | 31.8 | 39.8        | 24.0 | 24.0 | 51.1       | 39.1 | 47.2 | 59.4       | 51.3 | 51.3 |
| LOS by Move:              | F           | C    | C    | D           | C    | C    | D          | D    | D    | E          | D    | D    |
| HCM2k95thQ:               | 7           | 11   | 11   | 9           | 39   | 39   | 11         | 10   | 30   | 1          | 9    | 9    |

Note: Queue reported is the number of cars per lane.

BART

Level Of Service Computation Report  
 2000 HCM Operations (Future Volume Alternative)  
 AM - Bkgrd + Proj Conditions

Intersection #7: LAFAYETTE/REED [Study Int 45]

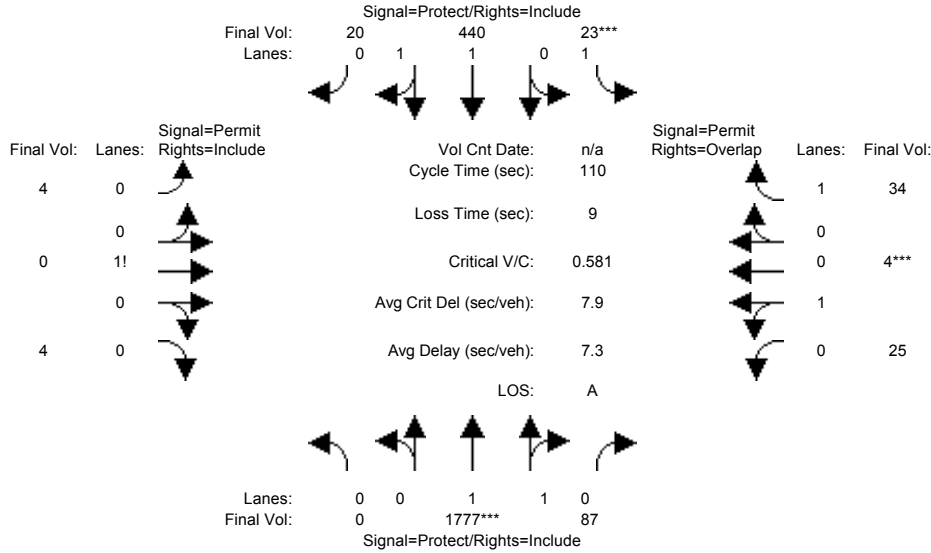

| Approach:                 | North Bound |      |      | South Bound |      |      | East Bound |      |      | West Bound |      |      |
|---------------------------|-------------|------|------|-------------|------|------|------------|------|------|------------|------|------|
| Movement:                 | L           | T    | R    | L           | T    | R    | L          | T    | R    | L          | T    | R    |
| Min. Green:               | 7           | 10   | 10   | 7           | 10   | 10   | 10         | 10   | 10   | 10         | 10   | 10   |
| Y+R:                      | 4.0         | 4.0  | 4.0  | 4.0         | 4.0  | 4.0  | 4.0        | 4.0  | 4.0  | 4.0        | 4.0  | 4.0  |
| Volume Module:            |             |      |      |             |      |      |            |      |      |            |      |      |
| Base Vol:                 | 0           | 1777 | 87   | 23          | 440  | 20   | 4          | 0    | 4    | 25         | 4    | 34   |
| Growth Adj:               | 1.00        | 1.00 | 1.00 | 1.00        | 1.00 | 1.00 | 1.00       | 1.00 | 1.00 | 1.00       | 1.00 | 1.00 |
| Initial Bse:              | 0           | 1777 | 87   | 23          | 440  | 20   | 4          | 0    | 4    | 25         | 4    | 34   |
| Added Vol:                | 0           | 0    | 0    | 0           | 0    | 0    | 0          | 0    | 0    | 0          | 0    | 0    |
| PasserByVol:              | 0           | 0    | 0    | 0           | 0    | 0    | 0          | 0    | 0    | 0          | 0    | 0    |
| Initial Fut:              | 0           | 1777 | 87   | 23          | 440  | 20   | 4          | 0    | 4    | 25         | 4    | 34   |
| User Adj:                 | 1.00        | 1.00 | 1.00 | 1.00        | 1.00 | 1.00 | 1.00       | 1.00 | 1.00 | 1.00       | 1.00 | 1.00 |
| PHF Adj:                  | 1.00        | 1.00 | 1.00 | 1.00        | 1.00 | 1.00 | 1.00       | 1.00 | 1.00 | 1.00       | 1.00 | 1.00 |
| PHF Volume:               | 0           | 1777 | 87   | 23          | 440  | 20   | 4          | 0    | 4    | 25         | 4    | 34   |
| Reduct Vol:               | 0           | 0    | 0    | 0           | 0    | 0    | 0          | 0    | 0    | 0          | 0    | 0    |
| Reduced Vol:              | 0           | 1777 | 87   | 23          | 440  | 20   | 4          | 0    | 4    | 25         | 4    | 34   |
| PCE Adj:                  | 1.00        | 1.00 | 1.00 | 1.00        | 1.00 | 1.00 | 1.00       | 1.00 | 1.00 | 1.00       | 1.00 | 1.00 |
| MLF Adj:                  | 1.00        | 1.00 | 1.00 | 1.00        | 1.00 | 1.00 | 1.00       | 1.00 | 1.00 | 1.00       | 1.00 | 1.00 |
| Final Volume:             | 0           | 1777 | 87   | 23          | 440  | 20   | 4          | 0    | 4    | 25         | 4    | 34   |
| Saturation Flow Module:   |             |      |      |             |      |      |            |      |      |            |      |      |
| Sat/Lane:                 | 1900        | 1900 | 1900 | 1900        | 1900 | 1900 | 1900       | 1900 | 1900 | 1900       | 1900 | 1900 |
| Adjustment:               | 0.92        | 0.97 | 0.95 | 0.92        | 0.97 | 0.95 | 0.92       | 0.92 | 0.92 | 0.95       | 0.95 | 0.92 |
| Lanes:                    | 0.00        | 1.90 | 0.10 | 1.00        | 1.91 | 0.09 | 0.50       | 0.00 | 0.50 | 0.86       | 0.14 | 1.00 |
| Final Sat.:               | 0           | 3527 | 173  | 1750        | 3539 | 161  | 875        | 0    | 875  | 1552       | 248  | 1750 |
| Capacity Analysis Module: |             |      |      |             |      |      |            |      |      |            |      |      |
| Vol/Sat:                  | 0.00        | 0.50 | 0.50 | 0.01        | 0.12 | 0.12 | 0.00       | 0.00 | 0.00 | 0.02       | 0.02 | 0.02 |
| Crit Moves:               | ****        | **** | **** | ****        | **** | **** | ****       | **** | **** | ****       | **** | **** |
| Green Time:               | 0.0         | 84.0 | 84.0 | 7.0         | 91.0 | 91.0 | 10.0       | 0.0  | 10.0 | 10.0       | 10.0 | 17.0 |
| Volume/Cap:               | 0.00        | 0.66 | 0.66 | 0.21        | 0.15 | 0.15 | 0.05       | 0.00 | 0.05 | 0.18       | 0.18 | 0.13 |
| Delay/Veh:                | 0.0         | 6.8  | 6.8  | 49.8        | 1.9  | 1.9  | 45.8       | 0.0  | 45.8 | 46.7       | 46.7 | 40.3 |
| User DelAdj:              | 1.00        | 1.00 | 1.00 | 1.00        | 1.00 | 1.00 | 1.00       | 1.00 | 1.00 | 1.00       | 1.00 | 1.00 |
| AdjDel/Veh:               | 0.0         | 6.8  | 6.8  | 49.8        | 1.9  | 1.9  | 45.8       | 0.0  | 45.8 | 46.7       | 46.7 | 40.3 |
| LOS by Move:              | A           | A    | A    | D           | A    | A    | D          | A    | D    | D          | D    | D    |
| HCM2k95thQ:               | 0           | 28   | 28   | 2           | 3    | 3    | 1          | 0    | 1    | 2          | 2    | 2    |

Note: Queue reported is the number of cars per lane.



BART

Level Of Service Computation Report  
 2000 HCM Operations (Future Volume Alternative)  
 PM - Bkgrd + Proj Conditions

Intersection #7: LAFAYETTE/REED [Study Int 45]

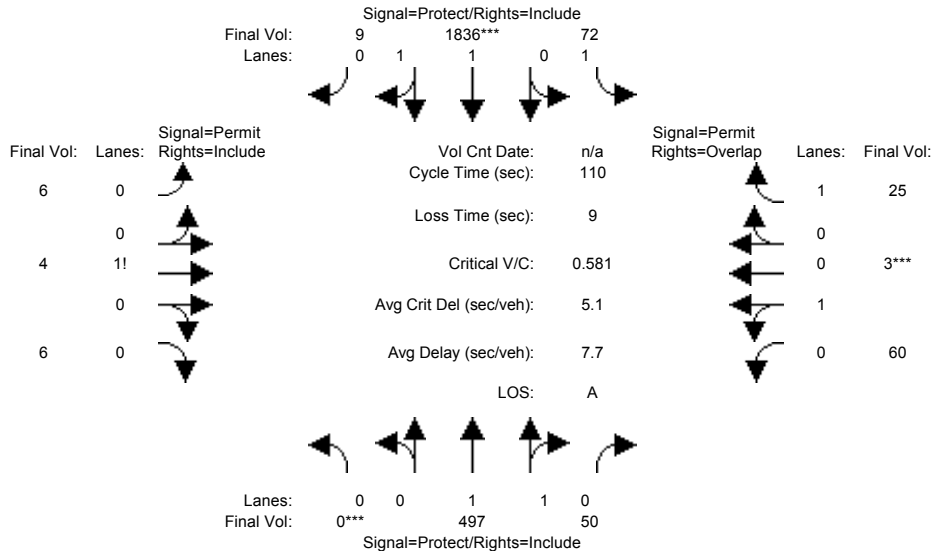

| Approach:                 | North Bound |      |      | South Bound |      |      | East Bound |      |      | West Bound |      |      |
|---------------------------|-------------|------|------|-------------|------|------|------------|------|------|------------|------|------|
| Movement:                 | L           | T    | R    | L           | T    | R    | L          | T    | R    | L          | T    | R    |
| Min. Green:               | 7           | 10   | 10   | 7           | 10   | 10   | 10         | 10   | 10   | 10         | 10   | 10   |
| Y+R:                      | 4.0         | 4.0  | 4.0  | 4.0         | 4.0  | 4.0  | 4.0        | 4.0  | 4.0  | 4.0        | 4.0  | 4.0  |
| Volume Module:            |             |      |      |             |      |      |            |      |      |            |      |      |
| Base Vol:                 | 0           | 497  | 50   | 72          | 1836 | 9    | 6          | 4    | 6    | 60         | 3    | 25   |
| Growth Adj:               | 1.00        | 1.00 | 1.00 | 1.00        | 1.00 | 1.00 | 1.00       | 1.00 | 1.00 | 1.00       | 1.00 | 1.00 |
| Initial Bse:              | 0           | 497  | 50   | 72          | 1836 | 9    | 6          | 4    | 6    | 60         | 3    | 25   |
| Added Vol:                | 0           | 0    | 0    | 0           | 0    | 0    | 0          | 0    | 0    | 0          | 0    | 0    |
| PasserByVol:              | 0           | 0    | 0    | 0           | 0    | 0    | 0          | 0    | 0    | 0          | 0    | 0    |
| Initial Fut:              | 0           | 497  | 50   | 72          | 1836 | 9    | 6          | 4    | 6    | 60         | 3    | 25   |
| User Adj:                 | 1.00        | 1.00 | 1.00 | 1.00        | 1.00 | 1.00 | 1.00       | 1.00 | 1.00 | 1.00       | 1.00 | 1.00 |
| PHF Adj:                  | 1.00        | 1.00 | 1.00 | 1.00        | 1.00 | 1.00 | 1.00       | 1.00 | 1.00 | 1.00       | 1.00 | 1.00 |
| PHF Volume:               | 0           | 497  | 50   | 72          | 1836 | 9    | 6          | 4    | 6    | 60         | 3    | 25   |
| Reduct Vol:               | 0           | 0    | 0    | 0           | 0    | 0    | 0          | 0    | 0    | 0          | 0    | 0    |
| Reduced Vol:              | 0           | 497  | 50   | 72          | 1836 | 9    | 6          | 4    | 6    | 60         | 3    | 25   |
| PCE Adj:                  | 1.00        | 1.00 | 1.00 | 1.00        | 1.00 | 1.00 | 1.00       | 1.00 | 1.00 | 1.00       | 1.00 | 1.00 |
| MLF Adj:                  | 1.00        | 1.00 | 1.00 | 1.00        | 1.00 | 1.00 | 1.00       | 1.00 | 1.00 | 1.00       | 1.00 | 1.00 |
| Final Volume:             | 0           | 497  | 50   | 72          | 1836 | 9    | 6          | 4    | 6    | 60         | 3    | 25   |
| Saturation Flow Module:   |             |      |      |             |      |      |            |      |      |            |      |      |
| Sat/Lane:                 | 1900        | 1900 | 1900 | 1900        | 1900 | 1900 | 1900       | 1900 | 1900 | 1900       | 1900 | 1900 |
| Adjustment:               | 0.92        | 0.98 | 0.95 | 0.92        | 0.97 | 0.95 | 0.92       | 0.92 | 0.92 | 0.95       | 0.95 | 0.92 |
| Lanes:                    | 0.00        | 1.81 | 0.19 | 1.00        | 1.99 | 0.01 | 0.37       | 0.25 | 0.38 | 0.95       | 0.05 | 1.00 |
| Final Sat.:               | 0           | 3362 | 338  | 1750        | 3682 | 18   | 656        | 438  | 656  | 1714       | 86   | 1750 |
| Capacity Analysis Module: |             |      |      |             |      |      |            |      |      |            |      |      |
| Vol/Sat:                  | 0.00        | 0.15 | 0.15 | 0.04        | 0.50 | 0.50 | 0.01       | 0.01 | 0.01 | 0.04       | 0.04 | 0.01 |
| Crit Moves:               | ****        |      |      | ****        |      |      |            |      |      | ****       |      |      |
| Green Time:               | 0.0         | 63.6 | 63.6 | 27.4        | 91.0 | 91.0 | 10.0       | 10.0 | 10.0 | 10.0       | 10.0 | 37.4 |
| Volume/Cap:               | 0.00        | 0.26 | 0.26 | 0.17        | 0.60 | 0.60 | 0.10       | 0.10 | 0.10 | 0.39       | 0.39 | 0.04 |
| Delay/Veh:                | 0.0         | 11.5 | 11.5 | 32.5        | 3.6  | 3.6  | 46.2       | 46.2 | 46.2 | 48.6       | 48.6 | 24.3 |
| User DelAdj:              | 1.00        | 1.00 | 1.00 | 1.00        | 1.00 | 1.00 | 1.00       | 1.00 | 1.00 | 1.00       | 1.00 | 1.00 |
| AdjDel/Veh:               | 0.0         | 11.5 | 11.5 | 32.5        | 3.6  | 3.6  | 46.2       | 46.2 | 46.2 | 48.6       | 48.6 | 24.3 |
| LOS by Move:              | A           | B    | B    | C           | A    | A    | D          | D    | D    | D          | D    | C    |
| HCM2k95thQ:               | 0           | 9    | 9    | 4           | 21   | 21   | 1          | 1    | 1    | 4          | 4    | 1    |

Note: Queue reported is the number of cars per lane.

BART

Level Of Service Computation Report  
 2000 HCM Operations (Future Volume Alternative)  
 AM - Bkgrd + Proj Conditions

Intersection #9: Coleman/Brokaw [Study Int 33]

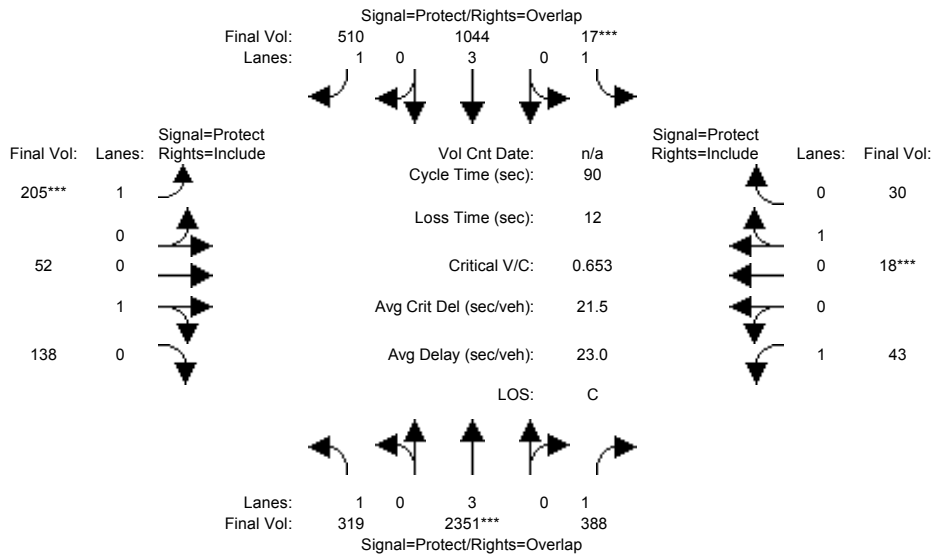

| Approach:                 | North Bound |      |      | South Bound |      |      | East Bound |      |      | West Bound |      |      |
|---------------------------|-------------|------|------|-------------|------|------|------------|------|------|------------|------|------|
| Movement:                 | L           | T    | R    | L           | T    | R    | L          | T    | R    | L          | T    | R    |
| Min. Green:               | 7           | 10   | 10   | 7           | 10   | 10   | 7          | 10   | 10   | 7          | 10   | 10   |
| Y+R:                      | 4.0         | 4.0  | 4.0  | 4.0         | 4.0  | 4.0  | 4.0        | 4.0  | 4.0  | 4.0        | 4.0  | 4.0  |
| Volume Module:            |             |      |      |             |      |      |            |      |      |            |      |      |
| Base Vol:                 | 319         | 2351 | 388  | 17          | 1044 | 510  | 205        | 52   | 138  | 43         | 18   | 30   |
| Growth Adj:               | 1.00        | 1.00 | 1.00 | 1.00        | 1.00 | 1.00 | 1.00       | 1.00 | 1.00 | 1.00       | 1.00 | 1.00 |
| Initial Bse:              | 319         | 2351 | 388  | 17          | 1044 | 510  | 205        | 52   | 138  | 43         | 18   | 30   |
| Added Vol:                | 0           | 0    | 0    | 0           | 0    | 0    | 0          | 0    | 0    | 0          | 0    | 0    |
| PasserByVol:              | 0           | 0    | 0    | 0           | 0    | 0    | 0          | 0    | 0    | 0          | 0    | 0    |
| Initial Fut:              | 319         | 2351 | 388  | 17          | 1044 | 510  | 205        | 52   | 138  | 43         | 18   | 30   |
| User Adj:                 | 1.00        | 1.00 | 1.00 | 1.00        | 1.00 | 1.00 | 1.00       | 1.00 | 1.00 | 1.00       | 1.00 | 1.00 |
| PHF Adj:                  | 1.00        | 1.00 | 1.00 | 1.00        | 1.00 | 1.00 | 1.00       | 1.00 | 1.00 | 1.00       | 1.00 | 1.00 |
| PHF Volume:               | 319         | 2351 | 388  | 17          | 1044 | 510  | 205        | 52   | 138  | 43         | 18   | 30   |
| Reduct Vol:               | 0           | 0    | 0    | 0           | 0    | 0    | 0          | 0    | 0    | 0          | 0    | 0    |
| Reduced Vol:              | 319         | 2351 | 388  | 17          | 1044 | 510  | 205        | 52   | 138  | 43         | 18   | 30   |
| PCE Adj:                  | 1.00        | 1.00 | 1.00 | 1.00        | 1.00 | 1.00 | 1.00       | 1.00 | 1.00 | 1.00       | 1.00 | 1.00 |
| MLF Adj:                  | 1.00        | 1.00 | 1.00 | 1.00        | 1.00 | 1.00 | 1.00       | 1.00 | 1.00 | 1.00       | 1.00 | 1.00 |
| Final Volume:             | 319         | 2351 | 388  | 17          | 1044 | 510  | 205        | 52   | 138  | 43         | 18   | 30   |
| Saturation Flow Module:   |             |      |      |             |      |      |            |      |      |            |      |      |
| Sat/Lane:                 | 1900        | 1900 | 1900 | 1900        | 1900 | 1900 | 1900       | 1900 | 1900 | 1900       | 1900 | 1900 |
| Adjustment:               | 0.92        | 1.00 | 0.92 | 0.92        | 1.00 | 0.92 | 0.92       | 0.95 | 0.95 | 0.92       | 0.95 | 0.95 |
| Lanes:                    | 1.00        | 3.00 | 1.00 | 1.00        | 3.00 | 1.00 | 1.00       | 0.27 | 0.73 | 1.00       | 0.37 | 0.63 |
| Final Sat.:               | 1750        | 5700 | 1750 | 1750        | 5700 | 1750 | 1750       | 493  | 1307 | 1750       | 675  | 1125 |
| Capacity Analysis Module: |             |      |      |             |      |      |            |      |      |            |      |      |
| Vol/Sat:                  | 0.18        | 0.41 | 0.22 | 0.01        | 0.18 | 0.29 | 0.12       | 0.11 | 0.11 | 0.02       | 0.03 | 0.03 |
| Crit Moves:               | ****        | **** | **** | ****        | **** | **** | ****       | **** | **** | ****       | **** | **** |
| Green Time:               | 27.2        | 47.5 | 57.2 | 7.0         | 27.3 | 40.8 | 13.5       | 13.8 | 13.8 | 9.7        | 10.0 | 10.0 |
| Volume/Cap:               | 0.60        | 0.78 | 0.35 | 0.12        | 0.60 | 0.64 | 0.78       | 0.69 | 0.69 | 0.23       | 0.24 | 0.24 |
| Delay/Veh:                | 28.8        | 18.5 | 7.9  | 39.1        | 27.3 | 20.8 | 50.9       | 43.1 | 43.1 | 37.4       | 37.2 | 37.2 |
| User DelAdj:              | 1.00        | 1.00 | 1.00 | 1.00        | 1.00 | 1.00 | 1.00       | 1.00 | 1.00 | 1.00       | 1.00 | 1.00 |
| AdjDel/Veh:               | 28.8        | 18.5 | 7.9  | 39.1        | 27.3 | 20.8 | 50.9       | 43.1 | 43.1 | 37.4       | 37.2 | 37.2 |
| LOS by Move:              | C           | B    | A    | D           | C    | C    | D          | D    | D    | D          | D    | D    |
| HCM2k95thQ:               | 14          | 28   | 10   | 1           | 15   | 21   | 15         | 13   | 13   | 2          | 3    | 3    |

Note: Queue reported is the number of cars per lane.

BART

Level Of Service Computation Report  
 2000 HCM Operations (Future Volume Alternative)  
 PM - Bkgrd + Proj Conditions

Intersection #9: Coleman/Brokaw [Study Int 33]

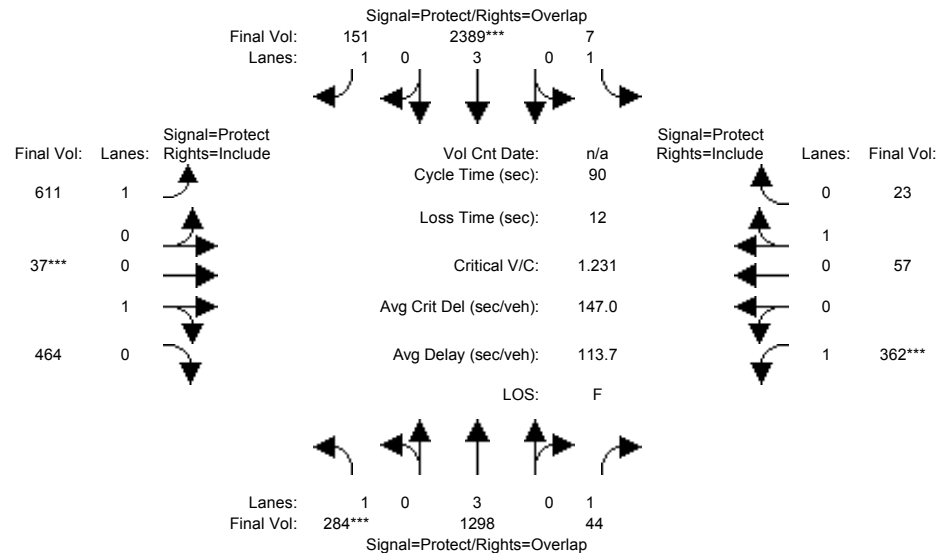

| Approach:                 | North Bound |      |      | South Bound |      |      | East Bound |      |       | West Bound |      |      |
|---------------------------|-------------|------|------|-------------|------|------|------------|------|-------|------------|------|------|
| Movement:                 | L           | T    | R    | L           | T    | R    | L          | T    | R     | L          | T    | R    |
| Min. Green:               | 7           | 10   | 10   | 7           | 10   | 10   | 7          | 10   | 10    | 7          | 10   | 10   |
| Y+R:                      | 4.0         | 4.0  | 4.0  | 4.0         | 4.0  | 4.0  | 4.0        | 4.0  | 4.0   | 4.0        | 4.0  | 4.0  |
| Volume Module:            |             |      |      |             |      |      |            |      |       |            |      |      |
| Base Vol:                 | 284         | 1298 | 44   | 7           | 2389 | 151  | 611        | 37   | 464   | 362        | 57   | 23   |
| Growth Adj:               | 1.00        | 1.00 | 1.00 | 1.00        | 1.00 | 1.00 | 1.00       | 1.00 | 1.00  | 1.00       | 1.00 | 1.00 |
| Initial Bse:              | 284         | 1298 | 44   | 7           | 2389 | 151  | 611        | 37   | 464   | 362        | 57   | 23   |
| Added Vol:                | 0           | 0    | 0    | 0           | 0    | 0    | 0          | 0    | 0     | 0          | 0    | 0    |
| PasserByVol:              | 0           | 0    | 0    | 0           | 0    | 0    | 0          | 0    | 0     | 0          | 0    | 0    |
| Initial Fut:              | 284         | 1298 | 44   | 7           | 2389 | 151  | 611        | 37   | 464   | 362        | 57   | 23   |
| User Adj:                 | 1.00        | 1.00 | 1.00 | 1.00        | 1.00 | 1.00 | 1.00       | 1.00 | 1.00  | 1.00       | 1.00 | 1.00 |
| PHF Adj:                  | 1.00        | 1.00 | 1.00 | 1.00        | 1.00 | 1.00 | 1.00       | 1.00 | 1.00  | 1.00       | 1.00 | 1.00 |
| PHF Volume:               | 284         | 1298 | 44   | 7           | 2389 | 151  | 611        | 37   | 464   | 362        | 57   | 23   |
| Reduct Vol:               | 0           | 0    | 0    | 0           | 0    | 0    | 0          | 0    | 0     | 0          | 0    | 0    |
| Reduced Vol:              | 284         | 1298 | 44   | 7           | 2389 | 151  | 611        | 37   | 464   | 362        | 57   | 23   |
| PCE Adj:                  | 1.00        | 1.00 | 1.00 | 1.00        | 1.00 | 1.00 | 1.00       | 1.00 | 1.00  | 1.00       | 1.00 | 1.00 |
| MLF Adj:                  | 1.00        | 1.00 | 1.00 | 1.00        | 1.00 | 1.00 | 1.00       | 1.00 | 1.00  | 1.00       | 1.00 | 1.00 |
| FinalVolume:              | 284         | 1298 | 44   | 7           | 2389 | 151  | 611        | 37   | 464   | 362        | 57   | 23   |
| Saturation Flow Module:   |             |      |      |             |      |      |            |      |       |            |      |      |
| Sat/Lane:                 | 1900        | 1900 | 1900 | 1900        | 1900 | 1900 | 1900       | 1900 | 1900  | 1900       | 1900 | 1900 |
| Adjustment:               | 0.92        | 1.00 | 0.92 | 0.92        | 1.00 | 0.92 | 0.92       | 0.95 | 0.95  | 0.92       | 0.95 | 0.95 |
| Lanes:                    | 1.00        | 3.00 | 1.00 | 1.00        | 3.00 | 1.00 | 1.00       | 0.07 | 0.93  | 1.00       | 0.71 | 0.29 |
| Final Sat.:               | 1750        | 5700 | 1750 | 1750        | 5700 | 1750 | 1750       | 133  | 1667  | 1750       | 1282 | 517  |
| Capacity Analysis Module: |             |      |      |             |      |      |            |      |       |            |      |      |
| Vol/Sat:                  | 0.16        | 0.23 | 0.03 | 0.00        | 0.42 | 0.09 | 0.35       | 0.28 | 0.28  | 0.21       | 0.04 | 0.04 |
| Crit Moves:               | ****        |      |      | ****        |      |      | ****       |      |       | ****       |      |      |
| Green Time:               | 11.9        | 31.7 | 46.8 | 10.8        | 30.7 | 56.1 | 25.5       | 20.4 | 20.4  | 15.1       | 10.0 | 10.0 |
| Volume/Cap:               | 1.23        | 0.65 | 0.05 | 0.03        | 1.23 | 0.14 | 1.23       | 1.23 | 1.23  | 1.23       | 0.40 | 0.40 |
| Delay/Veh:                | 174.7       | 25.2 | 10.6 | 35.0        | 138  | 7.0  | 153.8      | 158  | 158.4 | 167.3      | 38.5 | 38.5 |
| User DelAdj:              | 1.00        | 1.00 | 1.00 | 1.00        | 1.00 | 1.00 | 1.00       | 1.00 | 1.00  | 1.00       | 1.00 | 1.00 |
| AdjDel/Veh:               | 174.7       | 25.2 | 10.6 | 35.0        | 138  | 7.0  | 153.8      | 158  | 158.4 | 167.3      | 38.5 | 38.5 |
| LOS by Move:              | F           | C    | B    | D           | F    | A    | F          | F    | F     | F          | D    | D    |
| HCM2k95thQ:               | 28          | 18   | 1    | 0           | 64   | 4    | 58         | 48   | 48    | 35         | 4    | 4    |

Note: Queue reported is the number of cars per lane.

BART

Level Of Service Computation Report  
 2000 HCM Operations (Future Volume Alternative)  
 AM - Bkgrd + Proj Conditions

Intersection #106: Benton/E/ Camino Real [Study Int 52]

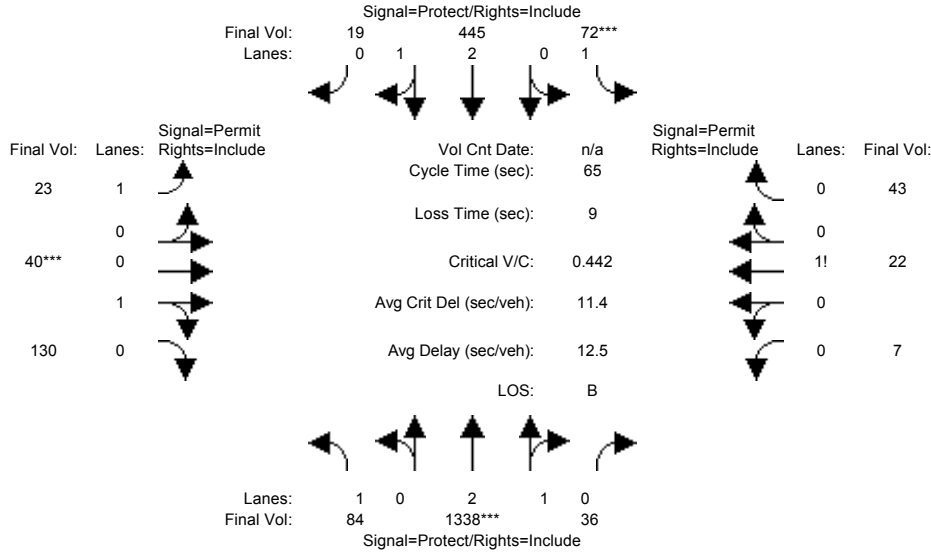

| Approach:                 | North Bound |      |      | South Bound |      |      | East Bound |      |      | West Bound |      |      |
|---------------------------|-------------|------|------|-------------|------|------|------------|------|------|------------|------|------|
| Movement:                 | L           | T    | R    | L           | T    | R    | L          | T    | R    | L          | T    | R    |
| Min. Green:               | 7           | 10   | 10   | 7           | 10   | 10   | 10         | 10   | 10   | 10         | 10   | 10   |
| Y+R:                      | 4.0         | 4.0  | 4.0  | 4.0         | 4.0  | 4.0  | 4.0        | 4.0  | 4.0  | 4.0        | 4.0  | 4.0  |
| Volume Module:            |             |      |      |             |      |      |            |      |      |            |      |      |
| Base Vol:                 | 84          | 1338 | 36   | 72          | 445  | 19   | 23         | 40   | 130  | 7          | 22   | 43   |
| Growth Adj:               | 1.00        | 1.00 | 1.00 | 1.00        | 1.00 | 1.00 | 1.00       | 1.00 | 1.00 | 1.00       | 1.00 | 1.00 |
| Initial Bse:              | 84          | 1338 | 36   | 72          | 445  | 19   | 23         | 40   | 130  | 7          | 22   | 43   |
| Added Vol:                | 0           | 0    | 0    | 0           | 0    | 0    | 0          | 0    | 0    | 0          | 0    | 0    |
| PasserByVol:              | 0           | 0    | 0    | 0           | 0    | 0    | 0          | 0    | 0    | 0          | 0    | 0    |
| Initial Fut:              | 84          | 1338 | 36   | 72          | 445  | 19   | 23         | 40   | 130  | 7          | 22   | 43   |
| User Adj:                 | 1.00        | 1.00 | 1.00 | 1.00        | 1.00 | 1.00 | 1.00       | 1.00 | 1.00 | 1.00       | 1.00 | 1.00 |
| PHF Adj:                  | 1.00        | 1.00 | 1.00 | 1.00        | 1.00 | 1.00 | 1.00       | 1.00 | 1.00 | 1.00       | 1.00 | 1.00 |
| PHF Volume:               | 84          | 1338 | 36   | 72          | 445  | 19   | 23         | 40   | 130  | 7          | 22   | 43   |
| Reduct Vol:               | 0           | 0    | 0    | 0           | 0    | 0    | 0          | 0    | 0    | 0          | 0    | 0    |
| Reduced Vol:              | 84          | 1338 | 36   | 72          | 445  | 19   | 23         | 40   | 130  | 7          | 22   | 43   |
| PCE Adj:                  | 1.00        | 1.00 | 1.00 | 1.00        | 1.00 | 1.00 | 1.00       | 1.00 | 1.00 | 1.00       | 1.00 | 1.00 |
| MLF Adj:                  | 1.00        | 1.00 | 1.00 | 1.00        | 1.00 | 1.00 | 1.00       | 1.00 | 1.00 | 1.00       | 1.00 | 1.00 |
| FinalVolume:              | 84          | 1338 | 36   | 72          | 445  | 19   | 23         | 40   | 130  | 7          | 22   | 43   |
| Saturation Flow Module:   |             |      |      |             |      |      |            |      |      |            |      |      |
| Sat/Lane:                 | 1900        | 1900 | 1900 | 1900        | 1900 | 1900 | 1900       | 1900 | 1900 | 1900       | 1900 | 1900 |
| Adjustment:               | 0.92        | 0.98 | 0.95 | 0.92        | 0.98 | 0.95 | 0.92       | 0.95 | 0.95 | 0.92       | 0.92 | 0.92 |
| Lanes:                    | 1.00        | 2.92 | 0.08 | 1.00        | 2.87 | 0.13 | 1.00       | 0.24 | 0.76 | 0.10       | 0.30 | 0.60 |
| Final Sat.:               | 1750        | 5453 | 147  | 1750        | 5370 | 229  | 1750       | 424  | 1376 | 170        | 535  | 1045 |
| Capacity Analysis Module: |             |      |      |             |      |      |            |      |      |            |      |      |
| Vol/Sat:                  | 0.05        | 0.25 | 0.25 | 0.04        | 0.08 | 0.08 | 0.01       | 0.09 | 0.09 | 0.04       | 0.04 | 0.04 |
| Crit Moves:               | ****        |      |      | ****        |      |      | ****       |      |      |            |      |      |
| Green Time:               | 17.5        | 35.4 | 35.4 | 7.0         | 24.9 | 24.9 | 13.6       | 13.6 | 13.6 | 13.6       | 13.6 | 13.6 |
| Volume/Cap:               | 0.18        | 0.45 | 0.45 | 0.38        | 0.22 | 0.22 | 0.06       | 0.45 | 0.45 | 0.20       | 0.20 | 0.20 |
| Delay/Veh:                | 18.5        | 9.0  | 9.0  | 28.3        | 13.5 | 13.5 | 20.7       | 23.3 | 23.3 | 21.4       | 21.4 | 21.4 |
| User DelAdj:              | 1.00        | 1.00 | 1.00 | 1.00        | 1.00 | 1.00 | 1.00       | 1.00 | 1.00 | 1.00       | 1.00 | 1.00 |
| AdjDel/Veh:               | 18.5        | 9.0  | 9.0  | 28.3        | 13.5 | 13.5 | 20.7       | 23.3 | 23.3 | 21.4       | 21.4 | 21.4 |
| LOS by Move:              | B           | A    | A    | C           | B    | B    | C          | C    | C    | C          | C    | C    |
| HCM2k95thQ:               | 3           | 11   | 11   | 3           | 4    | 4    | 1          | 6    | 6    | 3          | 3    | 3    |

Note: Queue reported is the number of cars per lane.

BART

Level Of Service Computation Report  
 2000 HCM Operations (Future Volume Alternative)  
 PM - Bkgrd + Proj Conditions

Intersection #106: Benton/E/ Camino Real [Study Int 52]

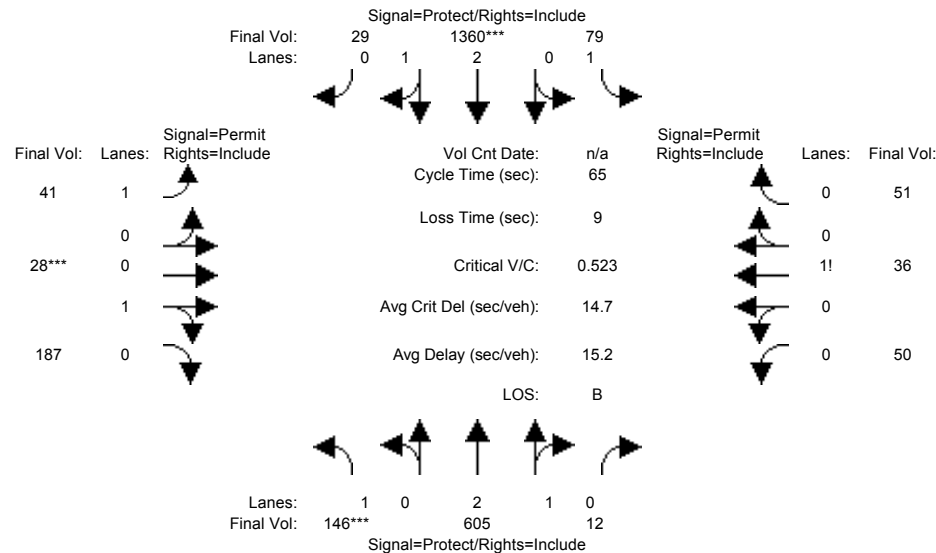

| Approach:                 | North Bound |      |      | South Bound |      |      | East Bound |      |      | West Bound |      |      |
|---------------------------|-------------|------|------|-------------|------|------|------------|------|------|------------|------|------|
| Movement:                 | L           | T    | R    | L           | T    | R    | L          | T    | R    | L          | T    | R    |
| Min. Green:               | 7           | 10   | 10   | 7           | 10   | 10   | 10         | 10   | 10   | 10         | 10   | 10   |
| Y+R:                      | 4.0         | 4.0  | 4.0  | 4.0         | 4.0  | 4.0  | 4.0        | 4.0  | 4.0  | 4.0        | 4.0  | 4.0  |
| Volume Module:            |             |      |      |             |      |      |            |      |      |            |      |      |
| Base Vol:                 | 146         | 605  | 12   | 79          | 1360 | 29   | 41         | 28   | 187  | 50         | 36   | 51   |
| Growth Adj:               | 1.00        | 1.00 | 1.00 | 1.00        | 1.00 | 1.00 | 1.00       | 1.00 | 1.00 | 1.00       | 1.00 | 1.00 |
| Initial Bse:              | 146         | 605  | 12   | 79          | 1360 | 29   | 41         | 28   | 187  | 50         | 36   | 51   |
| Added Vol:                | 0           | 0    | 0    | 0           | 0    | 0    | 0          | 0    | 0    | 0          | 0    | 0    |
| PasserByVol:              | 0           | 0    | 0    | 0           | 0    | 0    | 0          | 0    | 0    | 0          | 0    | 0    |
| Initial Fut:              | 146         | 605  | 12   | 79          | 1360 | 29   | 41         | 28   | 187  | 50         | 36   | 51   |
| User Adj:                 | 1.00        | 1.00 | 1.00 | 1.00        | 1.00 | 1.00 | 1.00       | 1.00 | 1.00 | 1.00       | 1.00 | 1.00 |
| PHF Adj:                  | 1.00        | 1.00 | 1.00 | 1.00        | 1.00 | 1.00 | 1.00       | 1.00 | 1.00 | 1.00       | 1.00 | 1.00 |
| PHF Volume:               | 146         | 605  | 12   | 79          | 1360 | 29   | 41         | 28   | 187  | 50         | 36   | 51   |
| Reduct Vol:               | 0           | 0    | 0    | 0           | 0    | 0    | 0          | 0    | 0    | 0          | 0    | 0    |
| Reduced Vol:              | 146         | 605  | 12   | 79          | 1360 | 29   | 41         | 28   | 187  | 50         | 36   | 51   |
| PCE Adj:                  | 1.00        | 1.00 | 1.00 | 1.00        | 1.00 | 1.00 | 1.00       | 1.00 | 1.00 | 1.00       | 1.00 | 1.00 |
| MLF Adj:                  | 1.00        | 1.00 | 1.00 | 1.00        | 1.00 | 1.00 | 1.00       | 1.00 | 1.00 | 1.00       | 1.00 | 1.00 |
| Final Volume:             | 146         | 605  | 12   | 79          | 1360 | 29   | 41         | 28   | 187  | 50         | 36   | 51   |
| Saturation Flow Module:   |             |      |      |             |      |      |            |      |      |            |      |      |
| Sat/Lane:                 | 1900        | 1900 | 1900 | 1900        | 1900 | 1900 | 1900       | 1900 | 1900 | 1900       | 1900 | 1900 |
| Adjustment:               | 0.92        | 0.98 | 0.95 | 0.92        | 0.98 | 0.95 | 0.92       | 0.95 | 0.95 | 0.92       | 0.92 | 0.92 |
| Lanes:                    | 1.00        | 2.94 | 0.06 | 1.00        | 2.94 | 0.06 | 1.00       | 0.13 | 0.87 | 0.36       | 0.26 | 0.38 |
| Final Sat.:               | 1750        | 5491 | 109  | 1750        | 5483 | 117  | 1750       | 234  | 1566 | 639        | 460  | 651  |
| Capacity Analysis Module: |             |      |      |             |      |      |            |      |      |            |      |      |
| Vol/Sat:                  | 0.08        | 0.11 | 0.11 | 0.05        | 0.25 | 0.25 | 0.02       | 0.12 | 0.12 | 0.08       | 0.08 | 0.08 |
| Crit Moves:               | ****        |      |      | ****        |      |      | ****       |      |      |            |      |      |
| Green Time:               | 10.4        | 24.2 | 24.2 | 17.0        | 30.8 | 30.8 | 14.8       | 14.8 | 14.8 | 14.8       | 14.8 | 14.8 |
| Volume/Cap:               | 0.52        | 0.30 | 0.30 | 0.17        | 0.52 | 0.52 | 0.10       | 0.52 | 0.52 | 0.34       | 0.34 | 0.34 |
| Delay/Veh:                | 26.9        | 14.5 | 14.5 | 18.8        | 12.2 | 12.2 | 19.9       | 23.2 | 23.2 | 21.5       | 21.5 | 21.5 |
| User DelAdj:              | 1.00        | 1.00 | 1.00 | 1.00        | 1.00 | 1.00 | 1.00       | 1.00 | 1.00 | 1.00       | 1.00 | 1.00 |
| AdjDel/Veh:               | 26.9        | 14.5 | 14.5 | 18.8        | 12.2 | 12.2 | 19.9       | 23.2 | 23.2 | 21.5       | 21.5 | 21.5 |
| LOS by Move:              | C           | B    | B    | B           | B    | B    | B          | C    | C    | C          | C    | C    |
| HCM2k95thQ:               | 6           | 6    | 6    | 3           | 13   | 13   | 1          | 8    | 8    | 6          | 6    | 6    |

Note: Queue reported is the number of cars per lane.

BART

Level Of Service Computation Report  
 2000 HCM Operations (Future Volume Alternative)  
 AM - Bkgrd + Proj Conditions

Intersection #107: Lafayette/Benton [Study Int 49]

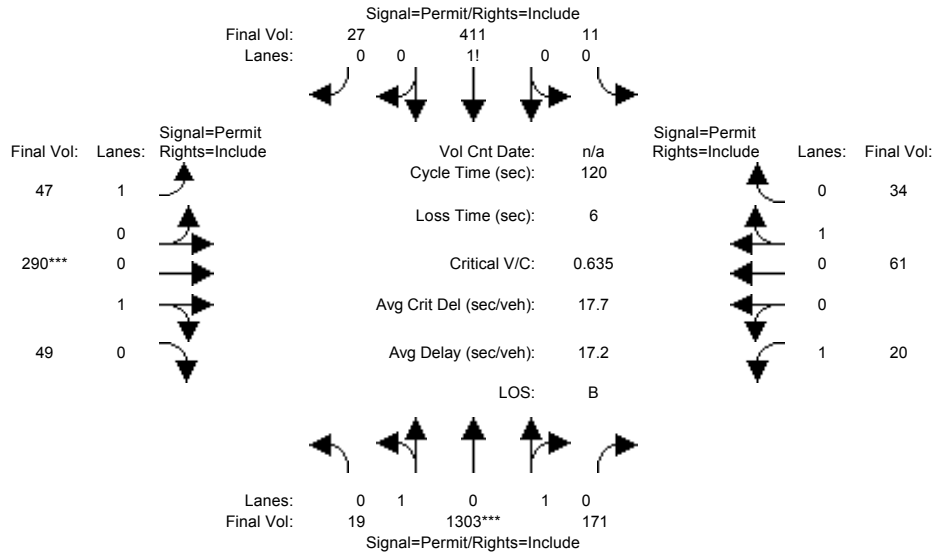

| Approach:                 | North Bound |      |      | South Bound |      |      | East Bound |      |      | West Bound |      |      |
|---------------------------|-------------|------|------|-------------|------|------|------------|------|------|------------|------|------|
| Movement:                 | L           | T    | R    | L           | T    | R    | L          | T    | R    | L          | T    | R    |
| Min. Green:               | 10          | 10   | 10   | 10          | 10   | 10   | 10         | 10   | 10   | 10         | 10   | 10   |
| Y+R:                      | 4.0         | 4.0  | 4.0  | 4.0         | 4.0  | 4.0  | 4.0        | 4.0  | 4.0  | 4.0        | 4.0  | 4.0  |
| Volume Module:            |             |      |      |             |      |      |            |      |      |            |      |      |
| Base Vol:                 | 19          | 1303 | 171  | 11          | 411  | 27   | 47         | 290  | 49   | 20         | 61   | 34   |
| Growth Adj:               | 1.00        | 1.00 | 1.00 | 1.00        | 1.00 | 1.00 | 1.00       | 1.00 | 1.00 | 1.00       | 1.00 | 1.00 |
| Initial Bse:              | 19          | 1303 | 171  | 11          | 411  | 27   | 47         | 290  | 49   | 20         | 61   | 34   |
| Added Vol:                | 0           | 0    | 0    | 0           | 0    | 0    | 0          | 0    | 0    | 0          | 0    | 0    |
| PasserByVol:              | 0           | 0    | 0    | 0           | 0    | 0    | 0          | 0    | 0    | 0          | 0    | 0    |
| Initial Fut:              | 19          | 1303 | 171  | 11          | 411  | 27   | 47         | 290  | 49   | 20         | 61   | 34   |
| User Adj:                 | 1.00        | 1.00 | 1.00 | 1.00        | 1.00 | 1.00 | 1.00       | 1.00 | 1.00 | 1.00       | 1.00 | 1.00 |
| PHF Adj:                  | 1.00        | 1.00 | 1.00 | 1.00        | 1.00 | 1.00 | 1.00       | 1.00 | 1.00 | 1.00       | 1.00 | 1.00 |
| PHF Volume:               | 19          | 1303 | 171  | 11          | 411  | 27   | 47         | 290  | 49   | 20         | 61   | 34   |
| Reduct Vol:               | 0           | 0    | 0    | 0           | 0    | 0    | 0          | 0    | 0    | 0          | 0    | 0    |
| Reduced Vol:              | 19          | 1303 | 171  | 11          | 411  | 27   | 47         | 290  | 49   | 20         | 61   | 34   |
| PCE Adj:                  | 1.00        | 1.00 | 1.00 | 1.00        | 1.00 | 1.00 | 1.00       | 1.00 | 1.00 | 1.00       | 1.00 | 1.00 |
| MLF Adj:                  | 1.00        | 1.00 | 1.00 | 1.00        | 1.00 | 1.00 | 1.00       | 1.00 | 1.00 | 1.00       | 1.00 | 1.00 |
| Final Volume:             | 19          | 1303 | 171  | 11          | 411  | 27   | 47         | 290  | 49   | 20         | 61   | 34   |
| Saturation Flow Module:   |             |      |      |             |      |      |            |      |      |            |      |      |
| Sat/Lane:                 | 1900        | 1900 | 1900 | 1900        | 1900 | 1900 | 1900       | 1900 | 1900 | 1900       | 1900 | 1900 |
| Adjustment:               | 0.95        | 0.95 | 0.95 | 0.92        | 0.92 | 0.92 | 0.92       | 0.95 | 0.95 | 0.92       | 0.95 | 0.95 |
| Lanes:                    | 0.02        | 1.75 | 0.23 | 0.02        | 0.92 | 0.06 | 1.00       | 0.86 | 0.14 | 1.00       | 0.64 | 0.36 |
| Final Sat.:               | 46          | 3142 | 412  | 43          | 1602 | 105  | 1750       | 1540 | 260  | 1750       | 1156 | 644  |
| Capacity Analysis Module: |             |      |      |             |      |      |            |      |      |            |      |      |
| Vol/Sat:                  | 0.41        | 0.41 | 0.41 | 0.26        | 0.26 | 0.26 | 0.03       | 0.19 | 0.19 | 0.01       | 0.05 | 0.05 |
| Crit Moves:               | ****        |      |      | ****        |      |      | ****       |      |      | ****       |      |      |
| Green Time:               | 78.4        | 78.4 | 78.4 | 78.4        | 78.4 | 78.4 | 35.6       | 35.6 | 35.6 | 35.6       | 35.6 | 35.6 |
| Volume/Cap:               | 0.63        | 0.63 | 0.63 | 0.39        | 0.39 | 0.39 | 0.09       | 0.63 | 0.63 | 0.04       | 0.18 | 0.18 |
| Delay/Veh:                | 12.9        | 12.9 | 12.9 | 9.9         | 9.9  | 9.9  | 30.6       | 39.1 | 39.1 | 30.1       | 31.5 | 31.5 |
| User DelAdj:              | 1.00        | 1.00 | 1.00 | 1.00        | 1.00 | 1.00 | 1.00       | 1.00 | 1.00 | 1.00       | 1.00 | 1.00 |
| AdjDel/Veh:               | 12.9        | 12.9 | 12.9 | 9.9         | 9.9  | 9.9  | 30.6       | 39.1 | 39.1 | 30.1       | 31.5 | 31.5 |
| LOS by Move:              | B           | B    | B    | A           | A    | A    | C          | D    | D    | C          | C    | C    |
| HCM2k95thQ:               | 28          | 28   | 28   | 15          | 15   | 15   | 3          | 21   | 21   | 1          | 5    | 5    |

Note: Queue reported is the number of cars per lane.

BART

Level Of Service Computation Report  
 2000 HCM Operations (Future Volume Alternative)  
 PM - Bkgrd + Proj Conditions

Intersection #107: Lafayette/Benton [Study Int 49]

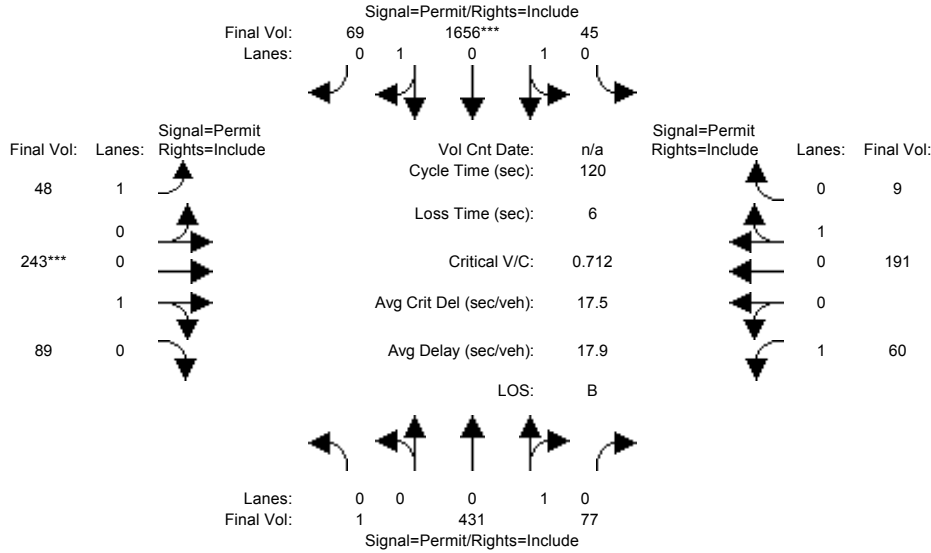

| Approach:                 | North Bound |      |      | South Bound |      |      | East Bound |      |      | West Bound |      |      |
|---------------------------|-------------|------|------|-------------|------|------|------------|------|------|------------|------|------|
| Movement:                 | L           | T    | R    | L           | T    | R    | L          | T    | R    | L          | T    | R    |
| Min. Green:               | 10          | 10   | 10   | 10          | 10   | 10   | 10         | 10   | 10   | 10         | 10   | 10   |
| Y+R:                      | 4.0         | 4.0  | 4.0  | 4.0         | 4.0  | 4.0  | 4.0        | 4.0  | 4.0  | 4.0        | 4.0  | 4.0  |
| Volume Module:            |             |      |      |             |      |      |            |      |      |            |      |      |
| Base Vol:                 | 1           | 431  | 77   | 45          | 1656 | 69   | 48         | 243  | 89   | 60         | 191  | 9    |
| Growth Adj:               | 1.00        | 1.00 | 1.00 | 1.00        | 1.00 | 1.00 | 1.00       | 1.00 | 1.00 | 1.00       | 1.00 | 1.00 |
| Initial Bse:              | 1           | 431  | 77   | 45          | 1656 | 69   | 48         | 243  | 89   | 60         | 191  | 9    |
| Added Vol:                | 0           | 0    | 0    | 0           | 0    | 0    | 0          | 0    | 0    | 0          | 0    | 0    |
| PasserByVol:              | 0           | 0    | 0    | 0           | 0    | 0    | 0          | 0    | 0    | 0          | 0    | 0    |
| Initial Fut:              | 1           | 431  | 77   | 45          | 1656 | 69   | 48         | 243  | 89   | 60         | 191  | 9    |
| User Adj:                 | 1.00        | 1.00 | 1.00 | 1.00        | 1.00 | 1.00 | 1.00       | 1.00 | 1.00 | 1.00       | 1.00 | 1.00 |
| PHF Adj:                  | 1.00        | 1.00 | 1.00 | 1.00        | 1.00 | 1.00 | 1.00       | 1.00 | 1.00 | 1.00       | 1.00 | 1.00 |
| PHF Volume:               | 1           | 431  | 77   | 45          | 1656 | 69   | 48         | 243  | 89   | 60         | 191  | 9    |
| Reduct Vol:               | 0           | 0    | 0    | 0           | 0    | 0    | 0          | 0    | 0    | 0          | 0    | 0    |
| Reduced Vol:              | 1           | 431  | 77   | 45          | 1656 | 69   | 48         | 243  | 89   | 60         | 191  | 9    |
| PCE Adj:                  | 1.00        | 1.00 | 1.00 | 1.00        | 1.00 | 1.00 | 1.00       | 1.00 | 1.00 | 1.00       | 1.00 | 1.00 |
| MLF Adj:                  | 1.00        | 1.00 | 1.00 | 1.00        | 1.00 | 1.00 | 1.00       | 1.00 | 1.00 | 1.00       | 1.00 | 1.00 |
| Final Volume:             | 1           | 431  | 77   | 45          | 1656 | 69   | 48         | 243  | 89   | 60         | 191  | 9    |
| Saturation Flow Module:   |             |      |      |             |      |      |            |      |      |            |      |      |
| Sat/Lane:                 | 1900        | 1900 | 1900 | 1900        | 1900 | 1900 | 1900       | 1900 | 1900 | 1900       | 1900 | 1900 |
| Adjustment:               | 0.92        | 0.92 | 0.92 | 0.95        | 0.95 | 0.95 | 0.92       | 0.95 | 0.95 | 0.92       | 0.95 | 0.95 |
| Lanes:                    | 0.01        | 0.84 | 0.15 | 0.05        | 1.87 | 0.08 | 1.00       | 0.73 | 0.27 | 1.00       | 0.95 | 0.05 |
| Final Sat.:               | 3           | 1482 | 265  | 92          | 3368 | 140  | 1750       | 1317 | 483  | 1750       | 1719 | 81   |
| Capacity Analysis Module: |             |      |      |             |      |      |            |      |      |            |      |      |
| Vol/Sat:                  | 0.29        | 0.29 | 0.29 | 0.49        | 0.49 | 0.49 | 0.03       | 0.18 | 0.18 | 0.03       | 0.11 | 0.11 |
| Crit Moves:               | ****        |      |      | ****        |      |      | ****       |      |      | ****       |      |      |
| Green Time:               | 82.9        | 82.9 | 82.9 | 82.9        | 82.9 | 82.9 | 31.1       | 31.1 | 31.1 | 31.1       | 31.1 | 31.1 |
| Volume/Cap:               | 0.42        | 0.42 | 0.42 | 0.71        | 0.71 | 0.71 | 0.11       | 0.71 | 0.71 | 0.13       | 0.43 | 0.43 |
| Delay/Veh:                | 8.3         | 8.3  | 8.3  | 12.3        | 12.3 | 12.3 | 34.0       | 45.5 | 45.5 | 34.2       | 37.7 | 37.7 |
| User DelAdj:              | 1.00        | 1.00 | 1.00 | 1.00        | 1.00 | 1.00 | 1.00       | 1.00 | 1.00 | 1.00       | 1.00 | 1.00 |
| AdjDel/Veh:               | 8.3         | 8.3  | 8.3  | 12.3        | 12.3 | 12.3 | 34.0       | 45.5 | 45.5 | 34.2       | 37.7 | 37.7 |
| LOS by Move:              | A           | A    | A    | B           | B    | B    | C          | D    | D    | C          | D    | D    |
| HCM2k95thQ:               | 16          | 16   | 16   | 33          | 33   | 33   | 3          | 21   | 21   | 4          | 13   | 13   |

Note: Queue reported is the number of cars per lane.

BART

Level Of Service Computation Report  
 2000 HCM Operations (Future Volume Alternative)  
 AM - Bkgrd + Proj Conditions

Intersection #121: Market/Lafayette [Study Int 51]

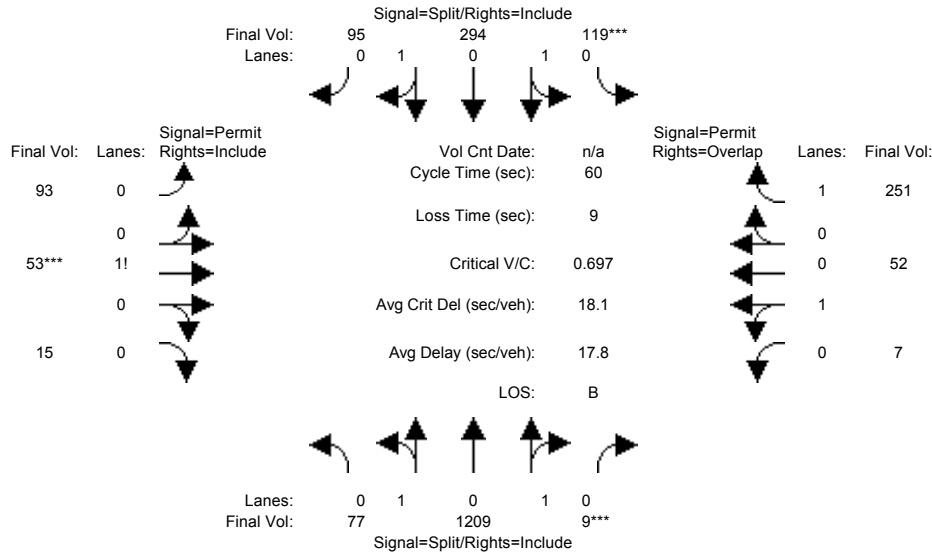

| Approach:                 | North Bound |      |      | South Bound |      |      | East Bound |      |      | West Bound |      |      |
|---------------------------|-------------|------|------|-------------|------|------|------------|------|------|------------|------|------|
| Movement:                 | L           | T    | R    | L           | T    | R    | L          | T    | R    | L          | T    | R    |
| Min. Green:               | 10          | 10   | 10   | 10          | 10   | 10   | 10         | 10   | 10   | 10         | 10   | 10   |
| Y+R:                      | 4.0         | 4.0  | 4.0  | 4.0         | 4.0  | 4.0  | 4.0        | 4.0  | 4.0  | 4.0        | 4.0  | 4.0  |
| Volume Module:            |             |      |      |             |      |      |            |      |      |            |      |      |
| Base Vol:                 | 77          | 1209 | 9    | 119         | 294  | 95   | 93         | 53   | 15   | 7          | 52   | 251  |
| Growth Adj:               | 1.00        | 1.00 | 1.00 | 1.00        | 1.00 | 1.00 | 1.00       | 1.00 | 1.00 | 1.00       | 1.00 | 1.00 |
| Initial Bse:              | 77          | 1209 | 9    | 119         | 294  | 95   | 93         | 53   | 15   | 7          | 52   | 251  |
| Added Vol:                | 0           | 0    | 0    | 0           | 0    | 0    | 0          | 0    | 0    | 0          | 0    | 0    |
| PasserByVol:              | 0           | 0    | 0    | 0           | 0    | 0    | 0          | 0    | 0    | 0          | 0    | 0    |
| Initial Fut:              | 77          | 1209 | 9    | 119         | 294  | 95   | 93         | 53   | 15   | 7          | 52   | 251  |
| User Adj:                 | 1.00        | 1.00 | 1.00 | 1.00        | 1.00 | 1.00 | 1.00       | 1.00 | 1.00 | 1.00       | 1.00 | 1.00 |
| PHF Adj:                  | 1.00        | 1.00 | 1.00 | 1.00        | 1.00 | 1.00 | 1.00       | 1.00 | 1.00 | 1.00       | 1.00 | 1.00 |
| PHF Volume:               | 77          | 1209 | 9    | 119         | 294  | 95   | 93         | 53   | 15   | 7          | 52   | 251  |
| Reduct Vol:               | 0           | 0    | 0    | 0           | 0    | 0    | 0          | 0    | 0    | 0          | 0    | 0    |
| Reduced Vol:              | 77          | 1209 | 9    | 119         | 294  | 95   | 93         | 53   | 15   | 7          | 52   | 251  |
| PCE Adj:                  | 1.00        | 1.00 | 1.00 | 1.00        | 1.00 | 1.00 | 1.00       | 1.00 | 1.00 | 1.00       | 1.00 | 1.00 |
| MLF Adj:                  | 1.00        | 1.00 | 1.00 | 1.00        | 1.00 | 1.00 | 1.00       | 1.00 | 1.00 | 1.00       | 1.00 | 1.00 |
| Final Volume:             | 77          | 1209 | 9    | 119         | 294  | 95   | 93         | 53   | 15   | 7          | 52   | 251  |
| Saturation Flow Module:   |             |      |      |             |      |      |            |      |      |            |      |      |
| Sat/Lane:                 | 1900        | 1900 | 1900 | 1900        | 1900 | 1900 | 1900       | 1900 | 1900 | 1900       | 1900 | 1900 |
| Adjustment:               | 0.95        | 0.95 | 0.95 | 0.95        | 0.95 | 0.95 | 0.92       | 0.92 | 0.92 | 0.95       | 0.95 | 0.92 |
| Lanes:                    | 0.12        | 1.87 | 0.01 | 0.47        | 1.16 | 0.37 | 0.58       | 0.33 | 0.09 | 0.12       | 0.88 | 1.00 |
| Final Sat.:               | 214         | 3361 | 25   | 843         | 2083 | 673  | 1011       | 576  | 163  | 214        | 1586 | 1750 |
| Capacity Analysis Module: |             |      |      |             |      |      |            |      |      |            |      |      |
| Vol/Sat:                  | 0.36        | 0.36 | 0.36 | 0.14        | 0.14 | 0.14 | 0.09       | 0.09 | 0.09 | 0.03       | 0.03 | 0.14 |
| Crit Moves:               | ****        | **** | **** | ****        | **** | **** | ****       | **** | **** | ****       | **** | **** |
| Green Time:               | 29.4        | 29.4 | 29.4 | 11.6        | 11.6 | 11.6 | 10.0       | 10.0 | 10.0 | 10.0       | 10.0 | 21.6 |
| Volume/Cap:               | 0.73        | 0.73 | 0.73 | 0.73        | 0.73 | 0.73 | 0.55       | 0.55 | 0.55 | 0.20       | 0.20 | 0.40 |
| Delay/Veh:                | 13.8        | 13.8 | 13.8 | 26.8        | 26.8 | 26.8 | 25.2       | 25.2 | 25.2 | 21.9       | 21.9 | 14.8 |
| User DelAdj:              | 1.00        | 1.00 | 1.00 | 1.00        | 1.00 | 1.00 | 1.00       | 1.00 | 1.00 | 1.00       | 1.00 | 1.00 |
| AdjDel/Veh:               | 13.8        | 13.8 | 13.8 | 26.8        | 26.8 | 26.8 | 25.2       | 25.2 | 25.2 | 21.9       | 21.9 | 14.8 |
| LOS by Move:              | B           | B    | B    | C           | C    | C    | C          | C    | C    | C          | C    | B    |
| HCM2k95thQ:               | 19          | 19   | 19   | 10          | 10   | 10   | 6          | 6    | 6    | 2          | 2    | 8    |

Note: Queue reported is the number of cars per lane.



BART

Level Of Service Computation Report  
 2000 HCM Operations (Future Volume Alternative)  
 PM - Bkgrd + Proj Conditions

Intersection #121: Market/Lafayette [Study Int 51]

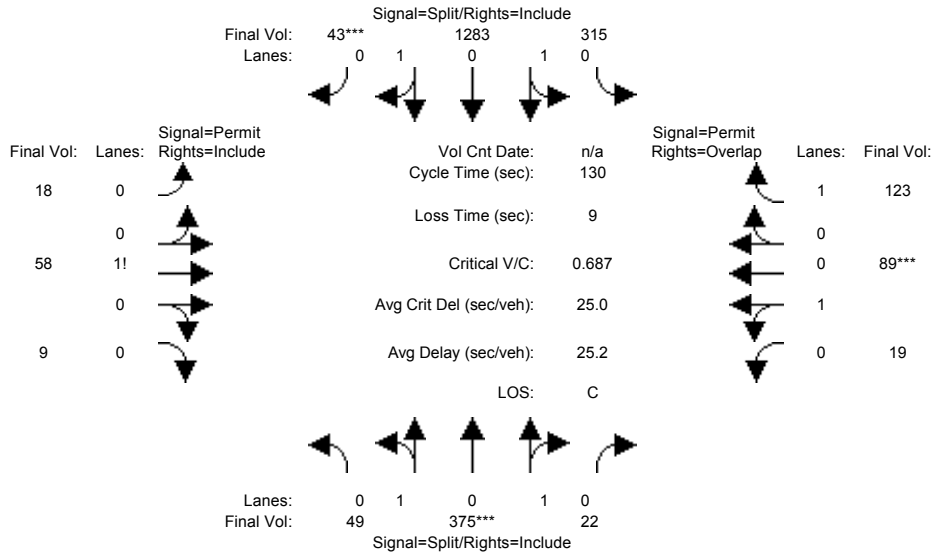

| Approach:                 | North Bound |      |      | South Bound |      |      | East Bound |      |      | West Bound |      |      |
|---------------------------|-------------|------|------|-------------|------|------|------------|------|------|------------|------|------|
| Movement:                 | L           | T    | R    | L           | T    | R    | L          | T    | R    | L          | T    | R    |
| Min. Green:               | 10          | 10   | 10   | 10          | 10   | 10   | 10         | 10   | 10   | 10         | 10   | 10   |
| Y+R:                      | 4.0         | 4.0  | 4.0  | 4.0         | 4.0  | 4.0  | 4.0        | 4.0  | 4.0  | 4.0        | 4.0  | 4.0  |
| Volume Module:            |             |      |      |             |      |      |            |      |      |            |      |      |
| Base Vol:                 | 49          | 375  | 22   | 315         | 1283 | 43   | 18         | 58   | 9    | 19         | 89   | 123  |
| Growth Adj:               | 1.00        | 1.00 | 1.00 | 1.00        | 1.00 | 1.00 | 1.00       | 1.00 | 1.00 | 1.00       | 1.00 | 1.00 |
| Initial Bse:              | 49          | 375  | 22   | 315         | 1283 | 43   | 18         | 58   | 9    | 19         | 89   | 123  |
| Added Vol:                | 0           | 0    | 0    | 0           | 0    | 0    | 0          | 0    | 0    | 0          | 0    | 0    |
| PasserByVol:              | 0           | 0    | 0    | 0           | 0    | 0    | 0          | 0    | 0    | 0          | 0    | 0    |
| Initial Fut:              | 49          | 375  | 22   | 315         | 1283 | 43   | 18         | 58   | 9    | 19         | 89   | 123  |
| User Adj:                 | 1.00        | 1.00 | 1.00 | 1.00        | 1.00 | 1.00 | 1.00       | 1.00 | 1.00 | 1.00       | 1.00 | 1.00 |
| PHF Adj:                  | 1.00        | 1.00 | 1.00 | 1.00        | 1.00 | 1.00 | 1.00       | 1.00 | 1.00 | 1.00       | 1.00 | 1.00 |
| PHF Volume:               | 49          | 375  | 22   | 315         | 1283 | 43   | 18         | 58   | 9    | 19         | 89   | 123  |
| Reduct Vol:               | 0           | 0    | 0    | 0           | 0    | 0    | 0          | 0    | 0    | 0          | 0    | 0    |
| Reduced Vol:              | 49          | 375  | 22   | 315         | 1283 | 43   | 18         | 58   | 9    | 19         | 89   | 123  |
| PCE Adj:                  | 1.00        | 1.00 | 1.00 | 1.00        | 1.00 | 1.00 | 1.00       | 1.00 | 1.00 | 1.00       | 1.00 | 1.00 |
| MLF Adj:                  | 1.00        | 1.00 | 1.00 | 1.00        | 1.00 | 1.00 | 1.00       | 1.00 | 1.00 | 1.00       | 1.00 | 1.00 |
| FinalVolume:              | 49          | 375  | 22   | 315         | 1283 | 43   | 18         | 58   | 9    | 19         | 89   | 123  |
| Saturation Flow Module:   |             |      |      |             |      |      |            |      |      |            |      |      |
| Sat/Lane:                 | 1900        | 1900 | 1900 | 1900        | 1900 | 1900 | 1900       | 1900 | 1900 | 1900       | 1900 | 1900 |
| Adjustment:               | 0.95        | 0.95 | 0.95 | 0.95        | 0.95 | 0.95 | 0.92       | 0.92 | 0.92 | 0.95       | 0.95 | 0.92 |
| Lanes:                    | 0.22        | 1.68 | 0.10 | 0.38        | 1.57 | 0.05 | 0.21       | 0.68 | 0.11 | 0.18       | 0.82 | 1.00 |
| Final Sat.:               | 396         | 3027 | 178  | 691         | 2815 | 94   | 371        | 1194 | 185  | 317        | 1483 | 1750 |
| Capacity Analysis Module: |             |      |      |             |      |      |            |      |      |            |      |      |
| Vol/Sat:                  | 0.12        | 0.12 | 0.12 | 0.46        | 0.46 | 0.46 | 0.05       | 0.05 | 0.05 | 0.06       | 0.06 | 0.07 |
| Crit Moves:               | ****        |      |      | ****        |      |      | ****       |      |      | ****       |      |      |
| Green Time:               | 23.4        | 23.4 | 23.4 | 86.2        | 86.2 | 86.2 | 11.3       | 11.3 | 11.3 | 11.3       | 11.3 | 97.6 |
| Volume/Cap:               | 0.69        | 0.69 | 0.69 | 0.69        | 0.69 | 0.69 | 0.56       | 0.56 | 0.56 | 0.69       | 0.69 | 0.09 |
| Delay/Veh:                | 53.0        | 53.0 | 53.0 | 14.4        | 14.4 | 14.4 | 61.4       | 61.4 | 61.4 | 69.7       | 69.7 | 4.4  |
| User DelAdj:              | 1.00        | 1.00 | 1.00 | 1.00        | 1.00 | 1.00 | 1.00       | 1.00 | 1.00 | 1.00       | 1.00 | 1.00 |
| AdjDel/Veh:               | 53.0        | 53.0 | 53.0 | 14.4        | 14.4 | 14.4 | 61.4       | 61.4 | 61.4 | 69.7       | 69.7 | 4.4  |
| LOS by Move:              | D           | D    | D    | B           | B    | B    | E          | E    | E    | E          | E    | A    |
| HCM2k95thQ:               | 17          | 17   | 17   | 36          | 36   | 36   | 7          | 7    | 7    | 11         | 11   | 3    |

Note: Queue reported is the number of cars per lane.

BART

Level Of Service Computation Report  
 2000 HCM Operations (Future Volume Alternative)  
 AM - Bkgrd + Proj Conditions

Intersection #123: Homestead/Monroe [Study Int 61]

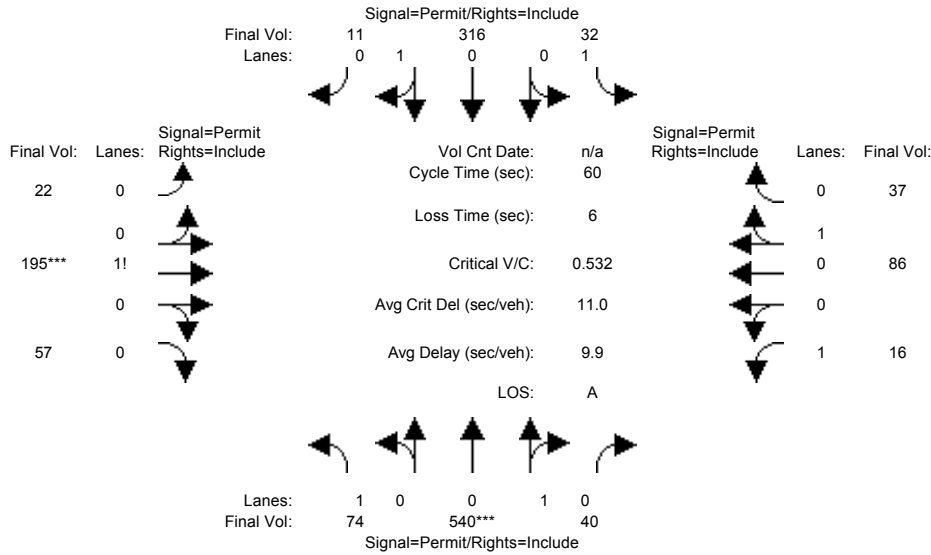

| Approach:                 | North Bound |      |      | South Bound |      |      | East Bound |      |      | West Bound |      |      |
|---------------------------|-------------|------|------|-------------|------|------|------------|------|------|------------|------|------|
| Movement:                 | L           | T    | R    | L           | T    | R    | L          | T    | R    | L          | T    | R    |
| Min. Green:               | 10          | 10   | 10   | 10          | 10   | 10   | 10         | 10   | 10   | 10         | 10   | 10   |
| Y+R:                      | 4.0         | 4.0  | 4.0  | 4.0         | 4.0  | 4.0  | 4.0        | 4.0  | 4.0  | 4.0        | 4.0  | 4.0  |
| Volume Module:            |             |      |      |             |      |      |            |      |      |            |      |      |
| Base Vol:                 | 74          | 540  | 40   | 32          | 316  | 11   | 22         | 195  | 57   | 16         | 86   | 37   |
| Growth Adj:               | 1.00        | 1.00 | 1.00 | 1.00        | 1.00 | 1.00 | 1.00       | 1.00 | 1.00 | 1.00       | 1.00 | 1.00 |
| Initial Bse:              | 74          | 540  | 40   | 32          | 316  | 11   | 22         | 195  | 57   | 16         | 86   | 37   |
| Added Vol:                | 0           | 0    | 0    | 0           | 0    | 0    | 0          | 0    | 0    | 0          | 0    | 0    |
| PasserByVol:              | 0           | 0    | 0    | 0           | 0    | 0    | 0          | 0    | 0    | 0          | 0    | 0    |
| Initial Fut:              | 74          | 540  | 40   | 32          | 316  | 11   | 22         | 195  | 57   | 16         | 86   | 37   |
| User Adj:                 | 1.00        | 1.00 | 1.00 | 1.00        | 1.00 | 1.00 | 1.00       | 1.00 | 1.00 | 1.00       | 1.00 | 1.00 |
| PHF Adj:                  | 1.00        | 1.00 | 1.00 | 1.00        | 1.00 | 1.00 | 1.00       | 1.00 | 1.00 | 1.00       | 1.00 | 1.00 |
| PHF Volume:               | 74          | 540  | 40   | 32          | 316  | 11   | 22         | 195  | 57   | 16         | 86   | 37   |
| Reduct Vol:               | 0           | 0    | 0    | 0           | 0    | 0    | 0          | 0    | 0    | 0          | 0    | 0    |
| Reduced Vol:              | 74          | 540  | 40   | 32          | 316  | 11   | 22         | 195  | 57   | 16         | 86   | 37   |
| PCE Adj:                  | 1.00        | 1.00 | 1.00 | 1.00        | 1.00 | 1.00 | 1.00       | 1.00 | 1.00 | 1.00       | 1.00 | 1.00 |
| MLF Adj:                  | 1.00        | 1.00 | 1.00 | 1.00        | 1.00 | 1.00 | 1.00       | 1.00 | 1.00 | 1.00       | 1.00 | 1.00 |
| FinalVolume:              | 74          | 540  | 40   | 32          | 316  | 11   | 22         | 195  | 57   | 16         | 86   | 37   |
| Saturation Flow Module:   |             |      |      |             |      |      |            |      |      |            |      |      |
| Sat/Lane:                 | 1900        | 1900 | 1900 | 1900        | 1900 | 1900 | 1900       | 1900 | 1900 | 1900       | 1900 | 1900 |
| Adjustment:               | 0.92        | 0.95 | 0.95 | 0.92        | 0.95 | 0.95 | 0.92       | 0.92 | 0.92 | 0.92       | 0.95 | 0.95 |
| Lanes:                    | 1.00        | 0.93 | 0.07 | 1.00        | 0.97 | 0.03 | 0.08       | 0.71 | 0.21 | 1.00       | 0.70 | 0.30 |
| Final Sat.:               | 1750        | 1676 | 124  | 1750        | 1739 | 61   | 141        | 1245 | 364  | 1750       | 1259 | 541  |
| Capacity Analysis Module: |             |      |      |             |      |      |            |      |      |            |      |      |
| Vol/Sat:                  | 0.04        | 0.32 | 0.32 | 0.02        | 0.18 | 0.18 | 0.16       | 0.16 | 0.16 | 0.01       | 0.07 | 0.07 |
| Crit Moves:               | ****        |      |      | ****        |      |      | ****       |      |      | ****       |      |      |
| Green Time:               | 36.3        | 36.3 | 36.3 | 36.3        | 36.3 | 36.3 | 17.7       | 17.7 | 17.7 | 17.7       | 17.7 | 17.7 |
| Volume/Cap:               | 0.07        | 0.53 | 0.53 | 0.03        | 0.30 | 0.30 | 0.53       | 0.53 | 0.53 | 0.03       | 0.23 | 0.23 |
| Delay/Veh:                | 4.9         | 7.4  | 7.4  | 4.8         | 5.9  | 5.9  | 18.8       | 18.8 | 18.8 | 15.1       | 16.3 | 16.3 |
| User DelAdj:              | 1.00        | 1.00 | 1.00 | 1.00        | 1.00 | 1.00 | 1.00       | 1.00 | 1.00 | 1.00       | 1.00 | 1.00 |
| AdjDel/Veh:               | 4.9         | 7.4  | 7.4  | 4.8         | 5.9  | 5.9  | 18.8       | 18.8 | 18.8 | 15.1       | 16.3 | 16.3 |
| LOS by Move:              | A           | A    | A    | A           | A    | A    | B          | B    | B    | B          | B    | B    |
| HCM2k95thQ:               | 1           | 13   | 13   | 1           | 6    | 6    | 9          | 9    | 9    | 0          | 4    | 4    |

Note: Queue reported is the number of cars per lane.

BART

Level Of Service Computation Report  
 2000 HCM Operations (Future Volume Alternative)  
 PM - Bkgrd + Proj Conditions

Intersection #123: Homestead/Monroe [Study Int 61]

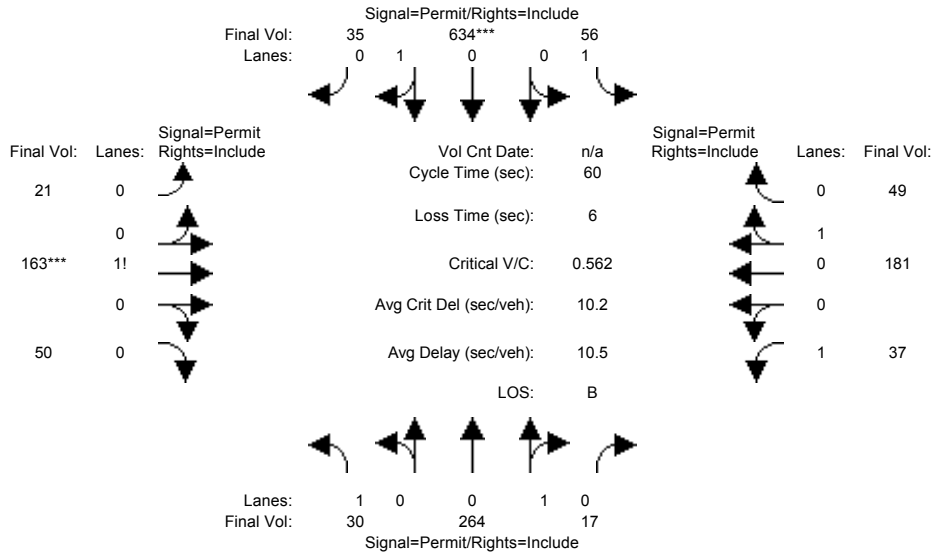

| Approach:                 | North Bound |      |      | South Bound |      |      | East Bound |      |      | West Bound |      |      |
|---------------------------|-------------|------|------|-------------|------|------|------------|------|------|------------|------|------|
| Movement:                 | L           | T    | R    | L           | T    | R    | L          | T    | R    | L          | T    | R    |
| Min. Green:               | 10          | 10   | 10   | 10          | 10   | 10   | 10         | 10   | 10   | 10         | 10   | 10   |
| Y+R:                      | 4.0         | 4.0  | 4.0  | 4.0         | 4.0  | 4.0  | 4.0        | 4.0  | 4.0  | 4.0        | 4.0  | 4.0  |
| Volume Module:            |             |      |      |             |      |      |            |      |      |            |      |      |
| Base Vol:                 | 30          | 264  | 17   | 56          | 634  | 35   | 21         | 163  | 50   | 37         | 181  | 49   |
| Growth Adj:               | 1.00        | 1.00 | 1.00 | 1.00        | 1.00 | 1.00 | 1.00       | 1.00 | 1.00 | 1.00       | 1.00 | 1.00 |
| Initial Bse:              | 30          | 264  | 17   | 56          | 634  | 35   | 21         | 163  | 50   | 37         | 181  | 49   |
| Added Vol:                | 0           | 0    | 0    | 0           | 0    | 0    | 0          | 0    | 0    | 0          | 0    | 0    |
| PasserByVol:              | 0           | 0    | 0    | 0           | 0    | 0    | 0          | 0    | 0    | 0          | 0    | 0    |
| Initial Fut:              | 30          | 264  | 17   | 56          | 634  | 35   | 21         | 163  | 50   | 37         | 181  | 49   |
| User Adj:                 | 1.00        | 1.00 | 1.00 | 1.00        | 1.00 | 1.00 | 1.00       | 1.00 | 1.00 | 1.00       | 1.00 | 1.00 |
| PHF Adj:                  | 1.00        | 1.00 | 1.00 | 1.00        | 1.00 | 1.00 | 1.00       | 1.00 | 1.00 | 1.00       | 1.00 | 1.00 |
| PHF Volume:               | 30          | 264  | 17   | 56          | 634  | 35   | 21         | 163  | 50   | 37         | 181  | 49   |
| Reduct Vol:               | 0           | 0    | 0    | 0           | 0    | 0    | 0          | 0    | 0    | 0          | 0    | 0    |
| Reduced Vol:              | 30          | 264  | 17   | 56          | 634  | 35   | 21         | 163  | 50   | 37         | 181  | 49   |
| PCE Adj:                  | 1.00        | 1.00 | 1.00 | 1.00        | 1.00 | 1.00 | 1.00       | 1.00 | 1.00 | 1.00       | 1.00 | 1.00 |
| MLF Adj:                  | 1.00        | 1.00 | 1.00 | 1.00        | 1.00 | 1.00 | 1.00       | 1.00 | 1.00 | 1.00       | 1.00 | 1.00 |
| Final Volume:             | 30          | 264  | 17   | 56          | 634  | 35   | 21         | 163  | 50   | 37         | 181  | 49   |
| Saturation Flow Module:   |             |      |      |             |      |      |            |      |      |            |      |      |
| Sat/Lane:                 | 1900        | 1900 | 1900 | 1900        | 1900 | 1900 | 1900       | 1900 | 1900 | 1900       | 1900 | 1900 |
| Adjustment:               | 0.92        | 0.95 | 0.95 | 0.92        | 0.95 | 0.95 | 0.92       | 0.92 | 0.92 | 0.92       | 0.95 | 0.95 |
| Lanes:                    | 1.00        | 0.94 | 0.06 | 1.00        | 0.95 | 0.05 | 0.09       | 0.70 | 0.21 | 1.00       | 0.79 | 0.21 |
| Final Sat.:               | 1750        | 1691 | 109  | 1750        | 1706 | 94   | 157        | 1219 | 374  | 1750       | 1417 | 383  |
| Capacity Analysis Module: |             |      |      |             |      |      |            |      |      |            |      |      |
| Vol/Sat:                  | 0.02        | 0.16 | 0.16 | 0.03        | 0.37 | 0.37 | 0.13       | 0.13 | 0.13 | 0.02       | 0.13 | 0.13 |
| Crit Moves:               |             |      |      | ****        |      |      | ****       |      |      |            |      |      |
| Green Time:               | 39.7        | 39.7 | 39.7 | 39.7        | 39.7 | 39.7 | 14.3       | 14.3 | 14.3 | 14.3       | 14.3 | 14.3 |
| Volume/Cap:               | 0.03        | 0.24 | 0.24 | 0.05        | 0.56 | 0.56 | 0.56       | 0.56 | 0.56 | 0.09       | 0.54 | 0.54 |
| Delay/Veh:                | 3.5         | 4.2  | 4.2  | 3.6         | 6.1  | 6.1  | 21.8       | 21.8 | 21.8 | 17.9       | 21.3 | 21.3 |
| User DelAdj:              | 1.00        | 1.00 | 1.00 | 1.00        | 1.00 | 1.00 | 1.00       | 1.00 | 1.00 | 1.00       | 1.00 | 1.00 |
| AdjDel/Veh:               | 3.5         | 4.2  | 4.2  | 3.6         | 6.1  | 6.1  | 21.8       | 21.8 | 21.8 | 17.9       | 21.3 | 21.3 |
| LOS by Move:              | A           | A    | A    | A           | A    | A    | C          | C    | C    | B          | C    | C    |
| HCM2k95thQ:               | 0           | 4    | 4    | 1           | 14   | 14   | 8          | 8    | 8    | 1          | 8    | 8    |

Note: Queue reported is the number of cars per lane.

BART

Level Of Service Computation Report  
 2000 HCM Operations (Future Volume Alternative)  
 AM - Bkgrd + Proj Conditions

Intersection #127: Lincoln/Homestead [Study Int 60]

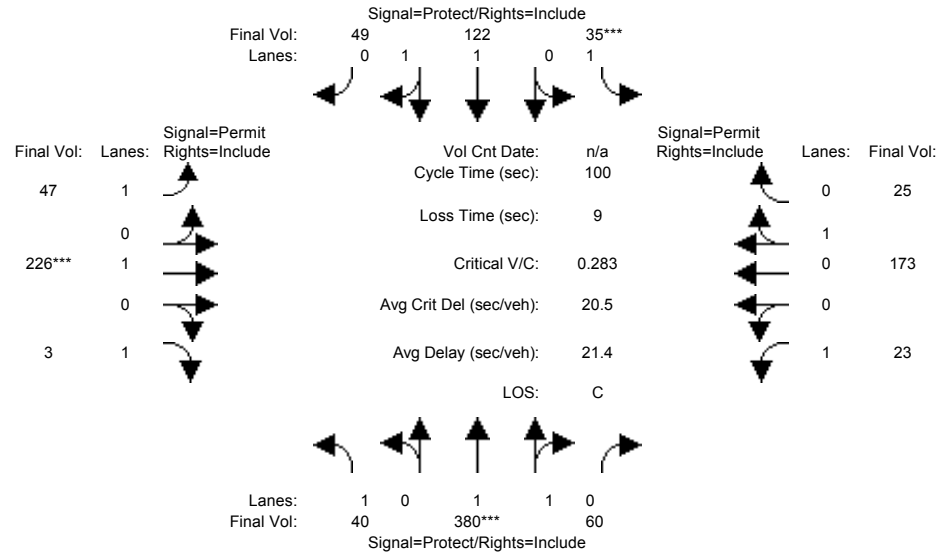

| Approach:                 | North Bound |      |      | South Bound |      |      | East Bound |      |      | West Bound |      |      |
|---------------------------|-------------|------|------|-------------|------|------|------------|------|------|------------|------|------|
| Movement:                 | L           | T    | R    | L           | T    | R    | L          | T    | R    | L          | T    | R    |
| Min. Green:               | 7           | 10   | 10   | 7           | 10   | 10   | 7          | 10   | 10   | 7          | 10   | 10   |
| Y+R:                      | 4.0         | 4.0  | 4.0  | 4.0         | 4.0  | 4.0  | 4.0        | 4.0  | 4.0  | 4.0        | 4.0  | 4.0  |
| Volume Module:            |             |      |      |             |      |      |            |      |      |            |      |      |
| Base Vol:                 | 40          | 380  | 60   | 35          | 122  | 49   | 47         | 226  | 3    | 23         | 173  | 25   |
| Growth Adj:               | 1.00        | 1.00 | 1.00 | 1.00        | 1.00 | 1.00 | 1.00       | 1.00 | 1.00 | 1.00       | 1.00 | 1.00 |
| Initial Bse:              | 40          | 380  | 60   | 35          | 122  | 49   | 47         | 226  | 3    | 23         | 173  | 25   |
| Added Vol:                | 0           | 0    | 0    | 0           | 0    | 0    | 0          | 0    | 0    | 0          | 0    | 0    |
| PasserByVol:              | 0           | 0    | 0    | 0           | 0    | 0    | 0          | 0    | 0    | 0          | 0    | 0    |
| Initial Fut:              | 40          | 380  | 60   | 35          | 122  | 49   | 47         | 226  | 3    | 23         | 173  | 25   |
| User Adj:                 | 1.00        | 1.00 | 1.00 | 1.00        | 1.00 | 1.00 | 1.00       | 1.00 | 1.00 | 1.00       | 1.00 | 1.00 |
| PHF Adj:                  | 1.00        | 1.00 | 1.00 | 1.00        | 1.00 | 1.00 | 1.00       | 1.00 | 1.00 | 1.00       | 1.00 | 1.00 |
| PHF Volume:               | 40          | 380  | 60   | 35          | 122  | 49   | 47         | 226  | 3    | 23         | 173  | 25   |
| Reduct Vol:               | 0           | 0    | 0    | 0           | 0    | 0    | 0          | 0    | 0    | 0          | 0    | 0    |
| Reduced Vol:              | 40          | 380  | 60   | 35          | 122  | 49   | 47         | 226  | 3    | 23         | 173  | 25   |
| PCE Adj:                  | 1.00        | 1.00 | 1.00 | 1.00        | 1.00 | 1.00 | 1.00       | 1.00 | 1.00 | 1.00       | 1.00 | 1.00 |
| MLF Adj:                  | 1.00        | 1.00 | 1.00 | 1.00        | 1.00 | 1.00 | 1.00       | 1.00 | 1.00 | 1.00       | 1.00 | 1.00 |
| Final Volume:             | 40          | 380  | 60   | 35          | 122  | 49   | 47         | 226  | 3    | 23         | 173  | 25   |
| Saturation Flow Module:   |             |      |      |             |      |      |            |      |      |            |      |      |
| Sat/Lane:                 | 1900        | 1900 | 1900 | 1900        | 1900 | 1900 | 1900       | 1900 | 1900 | 1900       | 1900 | 1900 |
| Adjustment:               | 0.92        | 0.98 | 0.95 | 0.92        | 0.98 | 0.95 | 0.92       | 1.00 | 0.92 | 0.92       | 0.95 | 0.95 |
| Lanes:                    | 1.00        | 1.72 | 0.28 | 1.00        | 1.41 | 0.59 | 1.00       | 1.00 | 1.00 | 1.00       | 0.87 | 0.13 |
| Final Sat.:               | 1750        | 3195 | 504  | 1750        | 2639 | 1060 | 1750       | 1900 | 1750 | 1750       | 1573 | 227  |
| Capacity Analysis Module: |             |      |      |             |      |      |            |      |      |            |      |      |
| Vol/Sat:                  | 0.02        | 0.12 | 0.12 | 0.02        | 0.05 | 0.05 | 0.03       | 0.12 | 0.00 | 0.01       | 0.11 | 0.11 |
| Crit Moves:               | ****        |      |      | ****        |      |      | ****       |      |      | ****       |      |      |
| Green Time:               | 20.2        | 42.0 | 42.0 | 7.1         | 28.8 | 28.8 | 42.0       | 42.0 | 42.0 | 42.0       | 42.0 | 42.0 |
| Volume/Cap:               | 0.11        | 0.28 | 0.28 | 0.28        | 0.16 | 0.16 | 0.06       | 0.28 | 0.00 | 0.03       | 0.26 | 0.26 |
| Delay/Veh:                | 32.7        | 19.2 | 19.2 | 45.3        | 26.6 | 26.6 | 17.3       | 19.3 | 16.9 | 17.1       | 19.1 | 19.1 |
| User DelAdj:              | 1.00        | 1.00 | 1.00 | 1.00        | 1.00 | 1.00 | 1.00       | 1.00 | 1.00 | 1.00       | 1.00 | 1.00 |
| AdjDel/Veh:               | 32.7        | 19.2 | 19.2 | 45.3        | 26.6 | 26.6 | 17.3       | 19.3 | 16.9 | 17.1       | 19.1 | 19.1 |
| LOS by Move:              | C           | B    | B    | D           | C    | C    | B          | B    | B    | B          | B    | B    |
| HCM2k95thQ:               | 2           | 9    | 9    | 2           | 4    | 4    | 2          | 9    | 0    | 1          | 8    | 8    |

Note: Queue reported is the number of cars per lane.

BART

Level Of Service Computation Report  
 2000 HCM Operations (Future Volume Alternative)  
 PM - Bkgrd + Proj Conditions

Intersection #127: Lincoln/Homestead [Study Int 60]

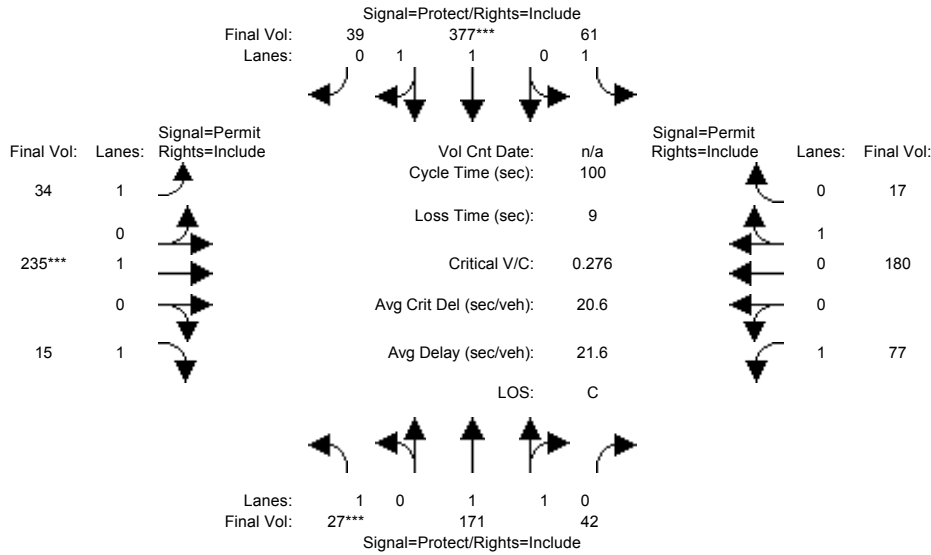

| Approach:                 | North Bound |      |      | South Bound |      |      | East Bound |      |      | West Bound |      |      |
|---------------------------|-------------|------|------|-------------|------|------|------------|------|------|------------|------|------|
| Movement:                 | L           | T    | R    | L           | T    | R    | L          | T    | R    | L          | T    | R    |
| Min. Green:               | 7           | 10   | 10   | 7           | 10   | 10   | 7          | 10   | 10   | 7          | 10   | 10   |
| Y+R:                      | 4.0         | 4.0  | 4.0  | 4.0         | 4.0  | 4.0  | 4.0        | 4.0  | 4.0  | 4.0        | 4.0  | 4.0  |
| Volume Module:            |             |      |      |             |      |      |            |      |      |            |      |      |
| Base Vol:                 | 27          | 171  | 42   | 61          | 377  | 39   | 34         | 235  | 15   | 77         | 180  | 17   |
| Growth Adj:               | 1.00        | 1.00 | 1.00 | 1.00        | 1.00 | 1.00 | 1.00       | 1.00 | 1.00 | 1.00       | 1.00 | 1.00 |
| Initial Bse:              | 27          | 171  | 42   | 61          | 377  | 39   | 34         | 235  | 15   | 77         | 180  | 17   |
| Added Vol:                | 0           | 0    | 0    | 0           | 0    | 0    | 0          | 0    | 0    | 0          | 0    | 0    |
| PasserByVol:              | 0           | 0    | 0    | 0           | 0    | 0    | 0          | 0    | 0    | 0          | 0    | 0    |
| Initial Fut:              | 27          | 171  | 42   | 61          | 377  | 39   | 34         | 235  | 15   | 77         | 180  | 17   |
| User Adj:                 | 1.00        | 1.00 | 1.00 | 1.00        | 1.00 | 1.00 | 1.00       | 1.00 | 1.00 | 1.00       | 1.00 | 1.00 |
| PHF Adj:                  | 1.00        | 1.00 | 1.00 | 1.00        | 1.00 | 1.00 | 1.00       | 1.00 | 1.00 | 1.00       | 1.00 | 1.00 |
| PHF Volume:               | 27          | 171  | 42   | 61          | 377  | 39   | 34         | 235  | 15   | 77         | 180  | 17   |
| Reduct Vol:               | 0           | 0    | 0    | 0           | 0    | 0    | 0          | 0    | 0    | 0          | 0    | 0    |
| Reduced Vol:              | 27          | 171  | 42   | 61          | 377  | 39   | 34         | 235  | 15   | 77         | 180  | 17   |
| PCE Adj:                  | 1.00        | 1.00 | 1.00 | 1.00        | 1.00 | 1.00 | 1.00       | 1.00 | 1.00 | 1.00       | 1.00 | 1.00 |
| MLF Adj:                  | 1.00        | 1.00 | 1.00 | 1.00        | 1.00 | 1.00 | 1.00       | 1.00 | 1.00 | 1.00       | 1.00 | 1.00 |
| FinalVolume:              | 27          | 171  | 42   | 61          | 377  | 39   | 34         | 235  | 15   | 77         | 180  | 17   |
| Saturation Flow Module:   |             |      |      |             |      |      |            |      |      |            |      |      |
| Sat/Lane:                 | 1900        | 1900 | 1900 | 1900        | 1900 | 1900 | 1900       | 1900 | 1900 | 1900       | 1900 | 1900 |
| Adjustment:               | 0.92        | 0.98 | 0.95 | 0.92        | 0.98 | 0.95 | 0.92       | 1.00 | 0.92 | 0.92       | 0.95 | 0.95 |
| Lanes:                    | 1.00        | 1.59 | 0.41 | 1.00        | 1.81 | 0.19 | 1.00       | 1.00 | 1.00 | 1.00       | 0.91 | 0.09 |
| Final Sat.:               | 1750        | 2970 | 729  | 1750        | 3353 | 347  | 1750       | 1900 | 1750 | 1750       | 1645 | 155  |
| Capacity Analysis Module: |             |      |      |             |      |      |            |      |      |            |      |      |
| Vol/Sat:                  | 0.02        | 0.06 | 0.06 | 0.03        | 0.11 | 0.11 | 0.02       | 0.12 | 0.01 | 0.04       | 0.11 | 0.11 |
| Crit Moves:               | ****        |      |      | ****        |      |      | ****       |      |      |            |      |      |
| Green Time:               | 7.0         | 27.6 | 27.6 | 19.4        | 40.0 | 40.0 | 44.0       | 44.0 | 44.0 | 44.0       | 44.0 | 44.0 |
| Volume/Cap:               | 0.22        | 0.21 | 0.21 | 0.18        | 0.28 | 0.28 | 0.04       | 0.28 | 0.02 | 0.10       | 0.25 | 0.25 |
| Delay/Veh:                | 44.8        | 27.9 | 27.9 | 34.0        | 20.4 | 20.4 | 16.0       | 18.1 | 15.8 | 16.5       | 17.8 | 17.8 |
| User DelAdj:              | 1.00        | 1.00 | 1.00 | 1.00        | 1.00 | 1.00 | 1.00       | 1.00 | 1.00 | 1.00       | 1.00 | 1.00 |
| AdjDel/Veh:               | 44.8        | 27.9 | 27.9 | 34.0        | 20.4 | 20.4 | 16.0       | 18.1 | 15.8 | 16.5       | 17.8 | 17.8 |
| LOS by Move:              | D           | C    | C    | C           | C    | C    | B          | B    | B    | B          | B    | B    |
| HCM2k95thQ:               | 2           | 5    | 5    | 3           | 8    | 8    | 1          | 9    | 1    | 3          | 8    | 8    |

Note: Queue reported is the number of cars per lane.

BART

Level Of Service Computation Report  
 2000 HCM Operations (Future Volume Alternative)  
 AM - Bkgrd + Proj Conditions

Intersection #128: Homestead/Lafayette [Study Int 50]

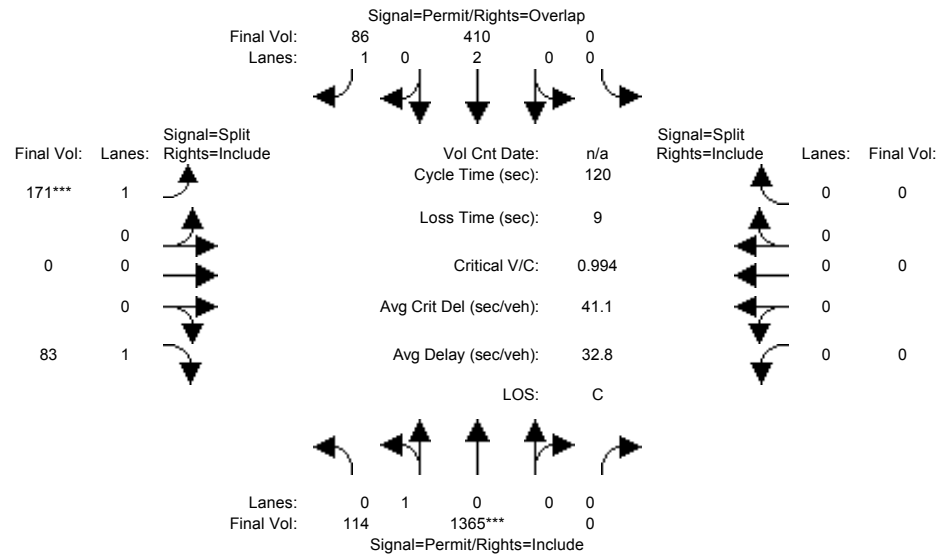

| Approach:                 | North Bound |      |      | South Bound |      |       | East Bound |      |      | West Bound |      |      |
|---------------------------|-------------|------|------|-------------|------|-------|------------|------|------|------------|------|------|
| Movement:                 | L           | T    | R    | L           | T    | R     | L          | T    | R    | L          | T    | R    |
| Min. Green:               | 10          | 10   | 10   | 10          | 10   | 10    | 10         | 10   | 10   | 10         | 10   | 10   |
| Y+R:                      | 4.0         | 4.0  | 4.0  | 4.0         | 4.0  | 4.0   | 4.0        | 4.0  | 4.0  | 4.0        | 4.0  | 4.0  |
| Volume Module:            |             |      |      |             |      |       |            |      |      |            |      |      |
| Base Vol:                 | 114         | 1365 | 0    | 0           | 0    | 410   | 86         | 171  | 0    | 83         | 0    | 0    |
| Growth Adj:               | 1.00        | 1.00 | 1.00 | 1.00        | 1.00 | 1.00  | 1.00       | 1.00 | 1.00 | 1.00       | 1.00 | 1.00 |
| Initial Bse:              | 114         | 1365 | 0    | 0           | 0    | 410   | 86         | 171  | 0    | 83         | 0    | 0    |
| Added Vol:                | 0           | 0    | 0    | 0           | 0    | 0     | 0          | 0    | 0    | 0          | 0    | 0    |
| PasserByVol:              | 0           | 0    | 0    | 0           | 0    | 0     | 0          | 0    | 0    | 0          | 0    | 0    |
| Initial Fut:              | 114         | 1365 | 0    | 0           | 0    | 410   | 86         | 171  | 0    | 83         | 0    | 0    |
| User Adj:                 | 1.00        | 1.00 | 1.00 | 1.00        | 1.00 | 1.00  | 1.00       | 1.00 | 1.00 | 1.00       | 1.00 | 1.00 |
| PHF Adj:                  | 1.00        | 1.00 | 1.00 | 1.00        | 1.00 | 1.00  | 1.00       | 1.00 | 1.00 | 1.00       | 1.00 | 1.00 |
| PHF Volume:               | 114         | 1365 | 0    | 0           | 0    | 410   | 86         | 171  | 0    | 83         | 0    | 0    |
| Reduct Vol:               | 0           | 0    | 0    | 0           | 0    | 0     | 0          | 0    | 0    | 0          | 0    | 0    |
| Reduced Vol:              | 114         | 1365 | 0    | 0           | 0    | 410   | 86         | 171  | 0    | 83         | 0    | 0    |
| PCE Adj:                  | 1.00        | 1.00 | 1.00 | 1.00        | 1.00 | 1.00  | 1.00       | 1.00 | 1.00 | 1.00       | 1.00 | 1.00 |
| MLF Adj:                  | 1.00        | 1.00 | 1.00 | 1.00        | 1.00 | 1.00  | 1.00       | 1.00 | 1.00 | 1.00       | 1.00 | 1.00 |
| Final Volume:             | 114         | 1365 | 0    | 0           | 0    | 410   | 86         | 171  | 0    | 83         | 0    | 0    |
| Saturation Flow Module:   |             |      |      |             |      |       |            |      |      |            |      |      |
| Sat/Lane:                 | 1900        | 1900 | 1900 | 1900        | 1900 | 1900  | 1900       | 1900 | 1900 | 1900       | 1900 | 1900 |
| Adjustment:               | 0.95        | 0.95 | 0.92 | 0.92        | 1.00 | 0.92  | 0.92       | 1.00 | 0.92 | 0.92       | 1.00 | 0.92 |
| Lanes:                    | 0.08        | 0.92 | 0.00 | 0.00        | 2.00 | 1.00  | 1.00       | 0.00 | 1.00 | 0.00       | 0.00 | 0.00 |
| Final Sat.:               | 139         | 1661 | 0    | 0           | 3800 | 1750  | 1750       | 0    | 1750 | 0          | 0    | 0    |
| Capacity Analysis Module: |             |      |      |             |      |       |            |      |      |            |      |      |
| Vol/Sat:                  | 0.82        | 0.82 | 0.00 | 0.00        | 0.11 | 0.05  | 0.10       | 0.00 | 0.05 | 0.00       | 0.00 | 0.00 |
| Crit Moves:               | ****        |      |      | ****        |      |       | ****       |      |      | ****       |      |      |
| Green Time:               | 99.2        | 99.2 | 0.0  | 0.0         | 99.2 | 111.0 | 11.8       | 0.0  | 11.8 | 0.0        | 0.0  | 0.0  |
| Volume/Cap:               | 0.99        | 0.99 | 0.00 | 0.00        | 0.13 | 0.05  | 0.99       | 0.00 | 0.48 | 0.00       | 0.00 | 0.00 |
| Delay/Veh:                | 31.9        | 31.9 | 0.0  | 0.0         | 2.0  | 0.4   | 120.8      | 0.0  | 53.3 | 0.0        | 0.0  | 0.0  |
| User DelAdj:              | 1.00        | 1.00 | 1.00 | 1.00        | 1.00 | 1.00  | 1.00       | 1.00 | 1.00 | 1.00       | 1.00 | 1.00 |
| AdjDel/Veh:               | 31.9        | 31.9 | 0.0  | 0.0         | 2.0  | 0.4   | 120.8      | 0.0  | 53.3 | 0.0        | 0.0  | 0.0  |
| LOS by Move:              | C           | C    | A    | A           | A    | A     | F          | A    | D    | A          | A    | A    |
| HCM2k95thQ:               | 98          | 98   | 0    | 0           | 3    | 1     | 16         | 0    | 6    | 0          | 0    | 0    |

Note: Queue reported is the number of cars per lane.

BART

Level Of Service Computation Report  
 2000 HCM Operations (Future Volume Alternative)  
 PM - Bkgrd + Proj Conditions

Intersection #128: Homestead/Lafayette [Study Int 50]

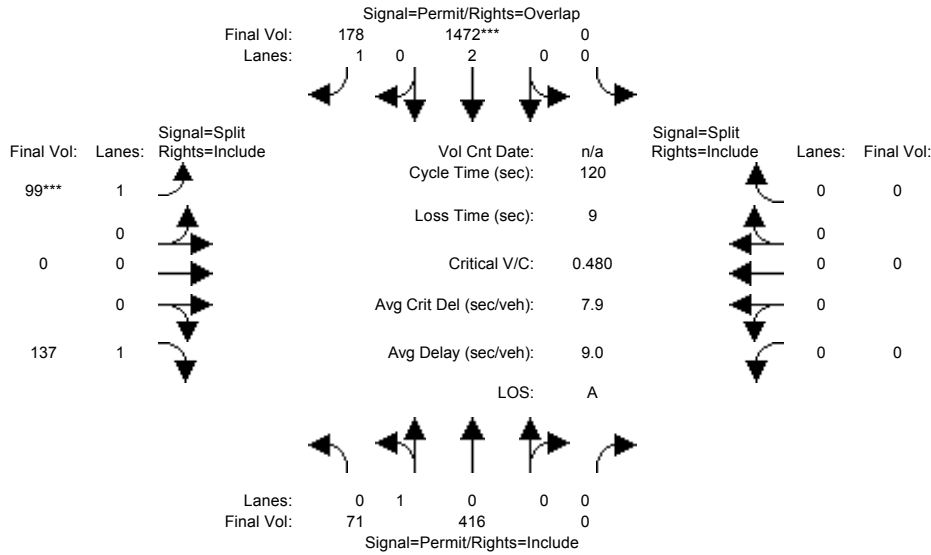

| Approach:                 | North Bound |      |      | South Bound |      |       | East Bound |      |      | West Bound |      |      |
|---------------------------|-------------|------|------|-------------|------|-------|------------|------|------|------------|------|------|
| Movement:                 | L           | T    | R    | L           | T    | R     | L          | T    | R    | L          | T    | R    |
| Min. Green:               | 10          | 10   | 10   | 10          | 10   | 10    | 10         | 10   | 10   | 10         | 10   | 10   |
| Y+R:                      | 4.0         | 4.0  | 4.0  | 4.0         | 4.0  | 4.0   | 4.0        | 4.0  | 4.0  | 4.0        | 4.0  | 4.0  |
| Volume Module:            |             |      |      |             |      |       |            |      |      |            |      |      |
| Base Vol:                 | 71          | 416  | 0    | 0           | 1472 | 178   | 99         | 0    | 137  | 0          | 0    | 0    |
| Growth Adj:               | 1.00        | 1.00 | 1.00 | 1.00        | 1.00 | 1.00  | 1.00       | 1.00 | 1.00 | 1.00       | 1.00 | 1.00 |
| Initial Bse:              | 71          | 416  | 0    | 0           | 1472 | 178   | 99         | 0    | 137  | 0          | 0    | 0    |
| Added Vol:                | 0           | 0    | 0    | 0           | 0    | 0     | 0          | 0    | 0    | 0          | 0    | 0    |
| PasserByVol:              | 0           | 0    | 0    | 0           | 0    | 0     | 0          | 0    | 0    | 0          | 0    | 0    |
| Initial Fut:              | 71          | 416  | 0    | 0           | 1472 | 178   | 99         | 0    | 137  | 0          | 0    | 0    |
| User Adj:                 | 1.00        | 1.00 | 1.00 | 1.00        | 1.00 | 1.00  | 1.00       | 1.00 | 1.00 | 1.00       | 1.00 | 1.00 |
| PHF Adj:                  | 1.00        | 1.00 | 1.00 | 1.00        | 1.00 | 1.00  | 1.00       | 1.00 | 1.00 | 1.00       | 1.00 | 1.00 |
| PHF Volume:               | 71          | 416  | 0    | 0           | 1472 | 178   | 99         | 0    | 137  | 0          | 0    | 0    |
| Reduct Vol:               | 0           | 0    | 0    | 0           | 0    | 0     | 0          | 0    | 0    | 0          | 0    | 0    |
| Reduced Vol:              | 71          | 416  | 0    | 0           | 1472 | 178   | 99         | 0    | 137  | 0          | 0    | 0    |
| PCE Adj:                  | 1.00        | 1.00 | 1.00 | 1.00        | 1.00 | 1.00  | 1.00       | 1.00 | 1.00 | 1.00       | 1.00 | 1.00 |
| MLF Adj:                  | 1.00        | 1.00 | 1.00 | 1.00        | 1.00 | 1.00  | 1.00       | 1.00 | 1.00 | 1.00       | 1.00 | 1.00 |
| FinalVolume:              | 71          | 416  | 0    | 0           | 1472 | 178   | 99         | 0    | 137  | 0          | 0    | 0    |
| Saturation Flow Module:   |             |      |      |             |      |       |            |      |      |            |      |      |
| Sat/Lane:                 | 1900        | 1900 | 1900 | 1900        | 1900 | 1900  | 1900       | 1900 | 1900 | 1900       | 1900 | 1900 |
| Adjustment:               | 0.95        | 0.95 | 0.92 | 0.92        | 1.00 | 0.92  | 0.92       | 1.00 | 0.92 | 0.92       | 1.00 | 0.92 |
| Lanes:                    | 0.15        | 0.85 | 0.00 | 0.00        | 2.00 | 1.00  | 1.00       | 0.00 | 1.00 | 0.00       | 0.00 | 0.00 |
| Final Sat.:               | 262         | 1538 | 0    | 0           | 3800 | 1750  | 0          | 1750 | 0    | 0          | 0    | 0    |
| Capacity Analysis Module: |             |      |      |             |      |       |            |      |      |            |      |      |
| Vol/Sat:                  | 0.27        | 0.27 | 0.00 | 0.00        | 0.39 | 0.10  | 0.06       | 0.00 | 0.08 | 0.00       | 0.00 | 0.00 |
| Crit Moves:               | ****        |      |      | ****        |      |       | ****       |      |      | ****       |      |      |
| Green Time:               | 92.3        | 92.3 | 0.0  | 0.0         | 92.3 | 111.0 | 18.7       | 0.0  | 18.7 | 0.0        | 0.0  | 0.0  |
| Volume/Cap:               | 0.35        | 0.35 | 0.00 | 0.00        | 0.50 | 0.11  | 0.36       | 0.00 | 0.50 | 0.00       | 0.00 | 0.00 |
| Delay/Veh:                | 4.5         | 4.5  | 0.0  | 0.0         | 5.3  | 0.4   | 46.2       | 0.0  | 47.9 | 0.0        | 0.0  | 0.0  |
| User DelAdj:              | 1.00        | 1.00 | 1.00 | 1.00        | 1.00 | 1.00  | 1.00       | 1.00 | 1.00 | 1.00       | 1.00 | 1.00 |
| AdjDel/Veh:               | 4.5         | 4.5  | 0.0  | 0.0         | 5.3  | 0.4   | 46.2       | 0.0  | 47.9 | 0.0        | 0.0  | 0.0  |
| LOS by Move:              | A           | A    | A    | A           | A    | A     | D          | A    | D    | A          | A    | A    |
| HCM2k95thQ:               | 12          | 12   | 0    | 0           | 18   | 1     | 7          | 0    | 10   | 0          | 0    | 0    |

Note: Queue reported is the number of cars per lane.

BART

Level Of Service Computation Report  
 2000 HCM Operations (Future Volume Alternative)  
 AM - Bkgrd + Proj Conditions

Intersection #175: Reed/De La Cruz [Study Int 32]

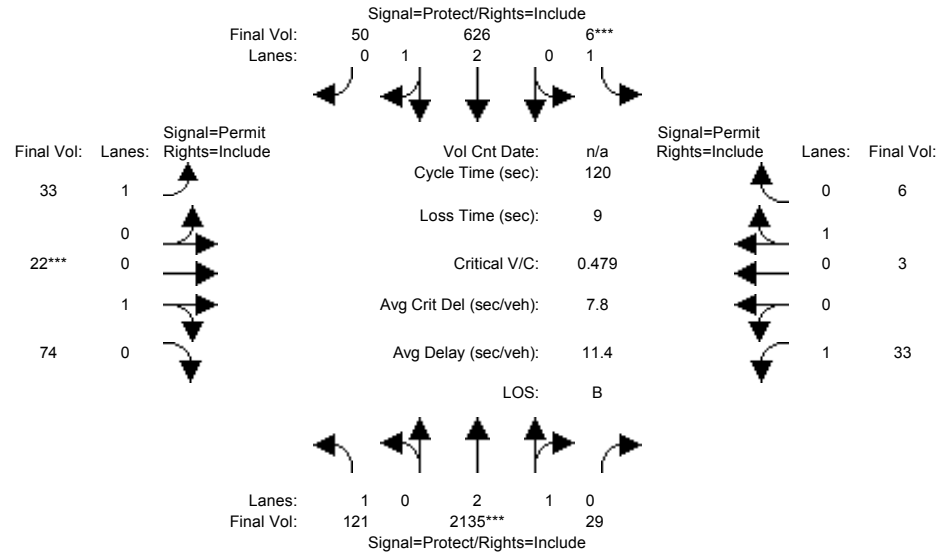

| Approach:                 | North Bound |      |      | South Bound |      |      | East Bound |      |      | West Bound |      |      |
|---------------------------|-------------|------|------|-------------|------|------|------------|------|------|------------|------|------|
| Movement:                 | L           | T    | R    | L           | T    | R    | L          | T    | R    | L          | T    | R    |
| Min. Green:               | 7           | 10   | 10   | 7           | 10   | 10   | 10         | 10   | 10   | 10         | 10   | 10   |
| Y+R:                      | 4.0         | 4.0  | 4.0  | 4.0         | 4.0  | 4.0  | 4.0        | 4.0  | 4.0  | 4.0        | 4.0  | 4.0  |
| Volume Module:            |             |      |      |             |      |      |            |      |      |            |      |      |
| Base Vol:                 | 121         | 2135 | 29   | 6           | 626  | 50   | 33         | 22   | 74   | 33         | 3    | 6    |
| Growth Adj:               | 1.00        | 1.00 | 1.00 | 1.00        | 1.00 | 1.00 | 1.00       | 1.00 | 1.00 | 1.00       | 1.00 | 1.00 |
| Initial Bse:              | 121         | 2135 | 29   | 6           | 626  | 50   | 33         | 22   | 74   | 33         | 3    | 6    |
| Added Vol:                | 0           | 0    | 0    | 0           | 0    | 0    | 0          | 0    | 0    | 0          | 0    | 0    |
| PasserByVol:              | 0           | 0    | 0    | 0           | 0    | 0    | 0          | 0    | 0    | 0          | 0    | 0    |
| Initial Fut:              | 121         | 2135 | 29   | 6           | 626  | 50   | 33         | 22   | 74   | 33         | 3    | 6    |
| User Adj:                 | 1.00        | 1.00 | 1.00 | 1.00        | 1.00 | 1.00 | 1.00       | 1.00 | 1.00 | 1.00       | 1.00 | 1.00 |
| PHF Adj:                  | 1.00        | 1.00 | 1.00 | 1.00        | 1.00 | 1.00 | 1.00       | 1.00 | 1.00 | 1.00       | 1.00 | 1.00 |
| PHF Volume:               | 121         | 2135 | 29   | 6           | 626  | 50   | 33         | 22   | 74   | 33         | 3    | 6    |
| Reduct Vol:               | 0           | 0    | 0    | 0           | 0    | 0    | 0          | 0    | 0    | 0          | 0    | 0    |
| Reduced Vol:              | 121         | 2135 | 29   | 6           | 626  | 50   | 33         | 22   | 74   | 33         | 3    | 6    |
| PCE Adj:                  | 1.00        | 1.00 | 1.00 | 1.00        | 1.00 | 1.00 | 1.00       | 1.00 | 1.00 | 1.00       | 1.00 | 1.00 |
| MLF Adj:                  | 1.00        | 1.00 | 1.00 | 1.00        | 1.00 | 1.00 | 1.00       | 1.00 | 1.00 | 1.00       | 1.00 | 1.00 |
| Final Volume:             | 121         | 2135 | 29   | 6           | 626  | 50   | 33         | 22   | 74   | 33         | 3    | 6    |
| Saturation Flow Module:   |             |      |      |             |      |      |            |      |      |            |      |      |
| Sat/Lane:                 | 1900        | 1900 | 1900 | 1900        | 1900 | 1900 | 1900       | 1900 | 1900 | 1900       | 1900 | 1900 |
| Adjustment:               | 0.92        | 0.98 | 0.95 | 0.92        | 0.99 | 0.95 | 0.92       | 0.95 | 0.95 | 0.92       | 0.95 | 0.95 |
| Lanes:                    | 1.00        | 2.96 | 0.04 | 1.00        | 2.77 | 0.23 | 1.00       | 0.23 | 0.77 | 1.00       | 0.33 | 0.67 |
| Final Sat.:               | 1750        | 5525 | 75   | 1750        | 5185 | 414  | 1750       | 412  | 1387 | 1750       | 600  | 1200 |
| Capacity Analysis Module: |             |      |      |             |      |      |            |      |      |            |      |      |
| Vol/Sat:                  | 0.07        | 0.39 | 0.39 | 0.00        | 0.12 | 0.12 | 0.02       | 0.05 | 0.05 | 0.02       | 0.01 | 0.01 |
| Crit Moves:               | ****        |      |      | ****        |      |      | ****       |      |      | ****       |      |      |
| Green Time:               | 35.8        | 91.4 | 91.4 | 7.0         | 62.6 | 62.6 | 12.6       | 12.6 | 12.6 | 12.6       | 12.6 | 12.6 |
| Volume/Cap:               | 0.23        | 0.51 | 0.51 | 0.06        | 0.23 | 0.23 | 0.18       | 0.51 | 0.51 | 0.18       | 0.05 | 0.05 |
| Delay/Veh:                | 31.9        | 5.7  | 5.7  | 53.6        | 15.7 | 15.7 | 49.4       | 53.0 | 53.0 | 49.4       | 48.4 | 48.4 |
| User DelAdj:              | 1.00        | 1.00 | 1.00 | 1.00        | 1.00 | 1.00 | 1.00       | 1.00 | 1.00 | 1.00       | 1.00 | 1.00 |
| AdjDel/Veh:               | 31.9        | 5.7  | 5.7  | 53.6        | 15.7 | 15.7 | 49.4       | 53.0 | 53.0 | 49.4       | 48.4 | 48.4 |
| LOS by Move:              | C           | A    | A    | D           | B    | B    | D          | D    | D    | D          | D    | D    |
| HCM2k95thQ:               | 7           | 19   | 19   | 0           | 9    | 9    | 2          | 7    | 7    | 3          | 1    | 1    |

Note: Queue reported is the number of cars per lane.



BART

Level Of Service Computation Report  
 2000 HCM Operations (Future Volume Alternative)  
 PM - Bkgrd + Proj Conditions

Intersection #175: Reed/De La Cruz [Study Int 32]

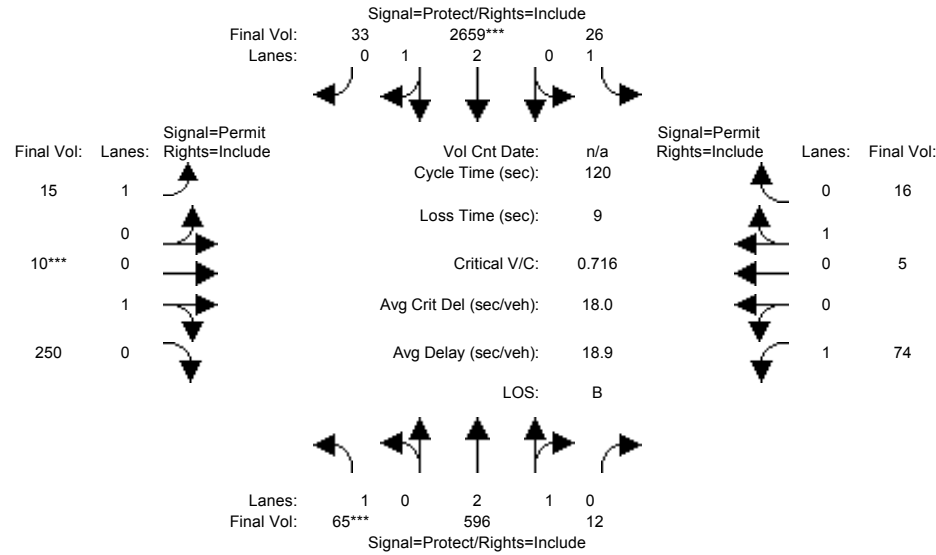

| Approach:                 | North Bound |      |      | South Bound |      |      | East Bound |      |      | West Bound |      |      |
|---------------------------|-------------|------|------|-------------|------|------|------------|------|------|------------|------|------|
| Movement:                 | L           | T    | R    | L           | T    | R    | L          | T    | R    | L          | T    | R    |
| Min. Green:               | 7           | 10   | 10   | 7           | 10   | 10   | 10         | 10   | 10   | 10         | 10   | 10   |
| Y+R:                      | 4.0         | 4.0  | 4.0  | 4.0         | 4.0  | 4.0  | 4.0        | 4.0  | 4.0  | 4.0        | 4.0  | 4.0  |
| Volume Module:            |             |      |      |             |      |      |            |      |      |            |      |      |
| Base Vol:                 | 65          | 596  | 12   | 26          | 2659 | 33   | 15         | 10   | 250  | 74         | 5    | 16   |
| Growth Adj:               | 1.00        | 1.00 | 1.00 | 1.00        | 1.00 | 1.00 | 1.00       | 1.00 | 1.00 | 1.00       | 1.00 | 1.00 |
| Initial Bse:              | 65          | 596  | 12   | 26          | 2659 | 33   | 15         | 10   | 250  | 74         | 5    | 16   |
| Added Vol:                | 0           | 0    | 0    | 0           | 0    | 0    | 0          | 0    | 0    | 0          | 0    | 0    |
| PasserByVol:              | 0           | 0    | 0    | 0           | 0    | 0    | 0          | 0    | 0    | 0          | 0    | 0    |
| Initial Fut:              | 65          | 596  | 12   | 26          | 2659 | 33   | 15         | 10   | 250  | 74         | 5    | 16   |
| User Adj:                 | 1.00        | 1.00 | 1.00 | 1.00        | 1.00 | 1.00 | 1.00       | 1.00 | 1.00 | 1.00       | 1.00 | 1.00 |
| PHF Adj:                  | 1.00        | 1.00 | 1.00 | 1.00        | 1.00 | 1.00 | 1.00       | 1.00 | 1.00 | 1.00       | 1.00 | 1.00 |
| PHF Volume:               | 65          | 596  | 12   | 26          | 2659 | 33   | 15         | 10   | 250  | 74         | 5    | 16   |
| Reduct Vol:               | 0           | 0    | 0    | 0           | 0    | 0    | 0          | 0    | 0    | 0          | 0    | 0    |
| Reduced Vol:              | 65          | 596  | 12   | 26          | 2659 | 33   | 15         | 10   | 250  | 74         | 5    | 16   |
| PCE Adj:                  | 1.00        | 1.00 | 1.00 | 1.00        | 1.00 | 1.00 | 1.00       | 1.00 | 1.00 | 1.00       | 1.00 | 1.00 |
| MLF Adj:                  | 1.00        | 1.00 | 1.00 | 1.00        | 1.00 | 1.00 | 1.00       | 1.00 | 1.00 | 1.00       | 1.00 | 1.00 |
| FinalVolume:              | 65          | 596  | 12   | 26          | 2659 | 33   | 15         | 10   | 250  | 74         | 5    | 16   |
| Saturation Flow Module:   |             |      |      |             |      |      |            |      |      |            |      |      |
| Sat/Lane:                 | 1900        | 1900 | 1900 | 1900        | 1900 | 1900 | 1900       | 1900 | 1900 | 1900       | 1900 | 1900 |
| Adjustment:               | 0.92        | 0.98 | 0.95 | 0.92        | 0.98 | 0.95 | 0.92       | 0.95 | 0.95 | 0.92       | 0.95 | 0.95 |
| Lanes:                    | 1.00        | 2.94 | 0.06 | 1.00        | 2.96 | 0.04 | 1.00       | 0.04 | 0.96 | 1.00       | 0.24 | 0.76 |
| Final Sat.:               | 1750        | 5489 | 111  | 1750        | 5531 | 69   | 1750       | 69   | 1731 | 1750       | 429  | 1371 |
| Capacity Analysis Module: |             |      |      |             |      |      |            |      |      |            |      |      |
| Vol/Sat:                  | 0.04        | 0.11 | 0.11 | 0.01        | 0.48 | 0.48 | 0.01       | 0.14 | 0.14 | 0.04       | 0.01 | 0.01 |
| Crit Moves:               | ****        |      |      | ****        |      |      | ****       |      |      |            |      |      |
| Green Time:               | 7.0         | 56.6 | 56.6 | 30.4        | 80.0 | 80.0 | 24.0       | 24.0 | 24.0 | 24.0       | 24.0 | 24.0 |
| Volume/Cap:               | 0.64        | 0.23 | 0.23 | 0.06        | 0.72 | 0.72 | 0.04       | 0.72 | 0.72 | 0.21       | 0.06 | 0.06 |
| Delay/Veh:                | 67.8        | 18.8 | 18.8 | 34.0        | 13.6 | 13.6 | 38.8       | 51.8 | 51.8 | 40.4       | 38.9 | 38.9 |
| User DelAdj:              | 1.00        | 1.00 | 1.00 | 1.00        | 1.00 | 1.00 | 1.00       | 1.00 | 1.00 | 1.00       | 1.00 | 1.00 |
| AdjDel/Veh:               | 67.8        | 18.8 | 18.8 | 34.0        | 13.6 | 13.6 | 38.8       | 51.8 | 51.8 | 40.4       | 38.9 | 38.9 |
| LOS by Move:              | E           | B    | B    | C           | B    | B    | D          | D    | D    | D          | D    | D    |
| HCM2k95thQ:               | 7           | 9    | 9    | 2           | 37   | 37   | 1          | 18   | 18   | 5          | 1    | 1    |

Note: Queue reported is the number of cars per lane.

BART

Level Of Service Computation Report
2000 HCM Unsignalized (Future Volume Alternative)
AM - Bkgrd + Proj Conditions

Intersection #1008: Lafayette/Harrison (unsignalized) [Study Int 48]

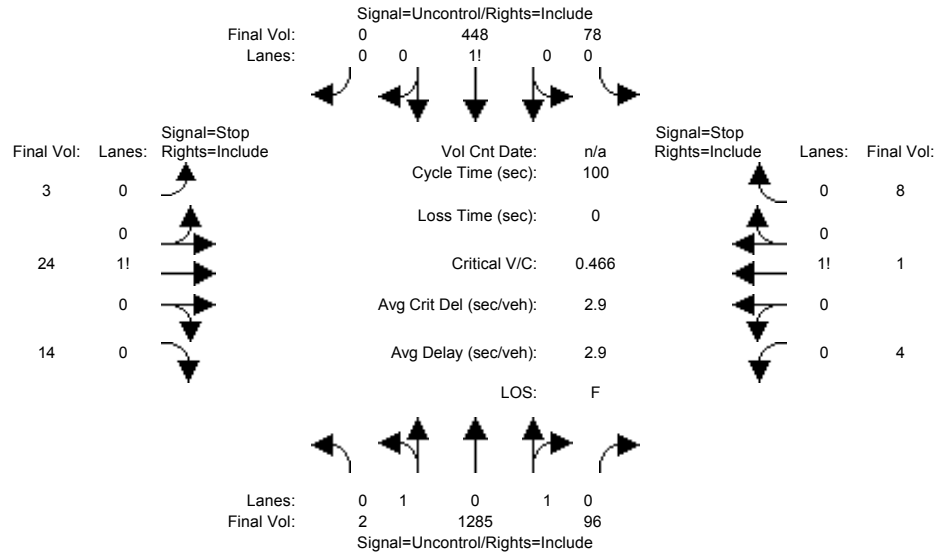

Table with columns for Approach (North, South, East, West Bound) and Movement (L, T, R). Rows include Volume Module, Critical Gap Module, Capacity Module, Level of Service Module, and various performance metrics like delay, saturation, and queue lengths.

```
ConflictVol: 448 xxxxx xxxxx 1381 xxxxx xxxxx 1251 1989 448 1960 1941 691
*** Computation 5: Capacity for Subject Movement During Unblocked Period
InitPotCap: 1123 xxxxx xxxxx 503 xxxxx xxxxx 151 62 615 48 66 448
UpstreamAdj:1.00 x.xxx x.xxx 1.00 x.xxx x.xxx 1.00 1.000 1.000 1.00 1.000 1.000
Potent Cap.:1123 xxxxx xxxxx 503 xxxxx xxxxx 151 62 615 48 66 448
```

BART

Level Of Service Computation Report  
2000 HCM Unsignalized (Future Volume Alternative)  
PM - Bkgrd + Proj Conditions

Intersection #1008: Lafayette/Harrison (unsignalized) [Study Int 48]

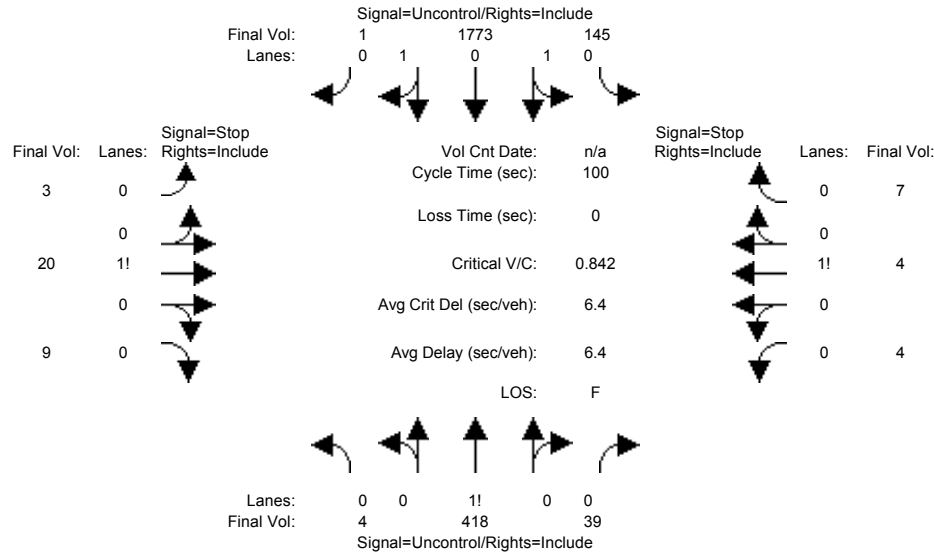

| Approach:   | North Bound   |               |               | South Bound   |               |               | East Bound    |               |               | West Bound    |               |               |
|---|---|---------------|---------------|---------------|---------------|---------------|---------------|---------------|---------------|---------------|---------------|---------------|
| Movement:   | L   | T             | R             | L             | T             | R             | L             | T             | R             | L             | T             | R             |
| Volume Module:  | ----- ----- ----- ----- ----- ----- ----- ----- ----- ----- ----- ----- |               |               |               |               |               |               |               |               |               |               |               |
| Base Vol:   | 4   | 418           | 39            | 145           | 1773          | 1             | 3             | 20            | 9             | 4             | 4             | 7             |
| Growth Adj:   | 1.00  | 1.00          | 1.00          | 1.00          | 1.00          | 1.00          | 1.00          | 1.00          | 1.00          | 1.00          | 1.00          | 1.00          |
| Initial Bse:  | 4   | 418           | 39            | 145           | 1773          | 1             | 3             | 20            | 9             | 4             | 4             | 7             |
| Added Vol:  | 0   | 0             | 0             | 0             | 0             | 0             | 0             | 0             | 0             | 0             | 0             | 0             |
| PasserByVol:  | 0   | 0             | 0             | 0             | 0             | 0             | 0             | 0             | 0             | 0             | 0             | 0             |
| Initial Fut:  | 4   | 418           | 39            | 145           | 1773          | 1             | 3             | 20            | 9             | 4             | 4             | 7             |
| User Adj:   | 1.00  | 1.00          | 1.00          | 1.00          | 1.00          | 1.00          | 1.00          | 1.00          | 1.00          | 1.00          | 1.00          | 1.00          |
| PHF Adj:  | 1.00  | 1.00          | 1.00          | 1.00          | 1.00          | 1.00          | 1.00          | 1.00          | 1.00          | 1.00          | 1.00          | 1.00          |
| PHF Volume:   | 4   | 418           | 39            | 145           | 1773          | 1             | 3             | 20            | 9             | 4             | 4             | 7             |
| Reduct Vol:   | 0   | 0             | 0             | 0             | 0             | 0             | 0             | 0             | 0             | 0             | 0             | 0             |
| FinalVolume:  | 4   | 418           | 39            | 145           | 1773          | 1             | 3             | 20            | 9             | 4             | 4             | 7             |
| Critical Gap Module:  | ----- ----- ----- ----- ----- ----- ----- ----- ----- ----- ----- ----- |               |               |               |               |               |               |               |               |               |               |               |
| Critical Gap:   | 4.1   | xxxx          | xxxxx         | 4.1           | xxxx          | xxxxx         | 7.1           | 6.5           | 6.2           | 7.1           | 6.5           | 6.2           |
| FollowUpTim:  | 2.2   | xxxx          | xxxxx         | 2.2           | xxxx          | xxxxx         | 3.5           | 4.0           | 3.3           | 3.5           | 4.0           | 3.3           |
| Capacity Module:  | ----- ----- ----- ----- ----- ----- ----- ----- ----- ----- ----- ----- |               |               |               |               |               |               |               |               |               |               |               |
| Cnflct Vol:   | 1774  | xxxx          | xxxxx         | 457           | xxxx          | xxxxx         | 2515          | 2529          | 887           | 1632          | 2510          | 438           |
| Potent Cap.:  | 355   | xxxx          | xxxxx         | 1114          | xxxx          | xxxxx         | 19            | 28            | 346           | 82            | 29            | 623           |
| Move Cap.:  | 355   | xxxx          | xxxxx         | 1114          | xxxx          | xxxxx         | 15            | 24            | 346           | 21            | 24            | 623           |
| Volume/Cap:   | 0.01  | xxxx          | xxxx          | 0.13          | xxxx          | xxxx          | 0.20          | 0.84          | 0.03          | 0.19          | 0.16          | 0.01          |
| Level Of Service Module:  | ----- ----- ----- ----- ----- ----- ----- ----- ----- ----- ----- ----- |               |               |               |               |               |               |               |               |               |               |               |
| 2Way95thQ:  | 0.0   | xxxx          | xxxxx         | 0.4           | xxxx          | xxxxx         | xxxx          | xxxx          | xxxxx         | xxxx          | xxxx          | xxxxx         |
| Control Del:  | 15.2  | xxxx          | xxxxx         | 8.7           | xxxx          | xxxxx         | xxxxx         | xxxx          | xxxxx         | xxxxx         | xxxx          | xxxxx         |
| LOS by Move:  | C   | *             | *             | A             | *             | *             | *             | *             | *             | *             | *             | *             |
| Movement:   | LT - LTR - RT   | LT - LTR - RT | LT - LTR - RT | LT - LTR - RT | LT - LTR - RT | LT - LTR - RT | LT - LTR - RT | LT - LTR - RT | LT - LTR - RT | LT - LTR - RT | LT - LTR - RT | LT - LTR - RT |
| Shared Cap.:  | xxxx  | xxxx          | xxxxx         | xxxx          | xxxx          | xxxxx         | xxxx          | 30            | xxxxx         | xxxx          | 41            | xxxxx         |
| SharedQueue:  | xxxxx   | xxxx          | xxxxx         | 0.4           | xxxx          | xxxxx         | 3.6           | xxxxx         | xxxxx         | 1.2           | xxxxx         | xxxxx         |
| Shrd ConDel:  | xxxxx   | xxxx          | xxxxx         | 8.7           | xxxx          | xxxxx         | 382           | xxxxx         | xxxxx         | 136           | xxxxx         | xxxxx         |
| Shared LOS:   | *   | *             | *             | A             | *             | *             | F             | *             | *             | F             | *             | *             |
| ApproachDel:  | xxxxxx  | xxxxxx        | xxxxxx        | xxxxxx        | xxxxxx        | xxxxxx        | 382.4         | xxxxxx        | xxxxxx        | 135.8         | xxxxxx        | xxxxxx        |
| ApproachLOS:  | *   | *             | *             | *             | *             | *             | F             | *             | *             | F             | *             | *             |
| Note:   | Queue reported is the number of cars per lane.                          |               |               |               |               |               |               |               |               |               |               |               |
| HevVeh:   | 0%  | 0%            | 0%            | 0%            | 0%            | 0%            | 0%            | 0%            | 0%            | 0%            | 0%            | 0%            |
| Grade:  | 0%  | 0%            | 0%            | 0%            | 0%            | 0%            | 0%            | 0%            | 0%            | 0%            | 0%            | 0%            |
| Peds/Hour:  | 0   | 0             | 0             | 0             | 0             | 0             | 0             | 0             | 0             | 0             | 0             | 0             |
| Pedestrian Walk Speed:  | 4.00 feet/sec   |               |               |               |               |               |               |               |               |               |               |               |
| LaneWidth:  | 12 feet   |               |               | 12 feet       |               |               | 12 feet       |               |               | 12 feet       |               |               |
| Time Period:  | 0.25 hour   |               |               |               |               |               |               |               |               |               |               |               |
| Upstream Signals:   | ----- ----- ----- ----- ----- ----- ----- ----- ----- ----- ----- ----- |               |               |               |               |               |               |               |               |               |               |               |
| Link Index:   | #718  |               |               | #974          |               |               |               |               |               |               |               |               |
| Dist(miles):  | 0.000   |               |               | 0.000         |               |               |               |               |               |               |               |               |
| Speed (mph):  | 0.00  |               |               | 0.00          |               |               |               |               |               |               |               |               |
| SignalIndex:  | #107  |               |               | #5444         |               |               |               |               |               |               |               |               |
| Cycle Time:   | 0 secs  |               |               | 0 secs        |               |               |               |               |               |               |               |               |
| InitVolume:   | 0   | 0             | 0             | 0             | 0             | 0             | 0             | 0             | 0             | 0             | 0             | 0             |
| Saturation:   | 0   | 0             | 0             | 0             | 0             | 0             | 0             | 0             | 0             | 0             | 0             | 0             |
| ArrivalType:  | 0   | 0             | 0             | 0             | 0             | 0             | 0             | 0             | 0             | 0             | 0             | 0             |
| G/C:  | 0.00  | 0.00          | 0.00          | 0.00          | 0.00          | 0.00          | 0.00          | 0.00          | 0.00          | 0.00          | 0.00          | 0.00          |
| *** Computation 1: Time for Queue to Clear at Each Upstream Intersection  | ----- ----- ----- ----- ----- ----- ----- ----- ----- ----- ----- ----- |               |               |               |               |               |               |               |               |               |               |               |
| P:  | 0.000   | 0.000         | 0.000         | 0.000         | 0.000         | 0.000         | 0.000         | 0.000         | 0.000         | 0.000         | 0.000         | 0.000         |
| gg1:  | 0.00  | 0.00          | 0.00          | 0.00          | 0.00          | 0.00          | 0.00          | 0.00          | 0.00          | 0.00          | 0.00          | 0.00          |
| gg2:  | 0.00  | 0.00          | 0.00          | 0.00          | 0.00          | 0.00          | 0.00          | 0.00          | 0.00          | 0.00          | 0.00          | 0.00          |
| gg:   | 0.00  | 0.00          | 0.00          | 0.00          | 0.00          | 0.00          | 0.00          | 0.00          | 0.00          | 0.00          | 0.00          | 0.00          |
| *** Computation 2: Time Intersection Blocked Because of Upstream Platoons | ----- ----- ----- ----- ----- ----- ----- ----- ----- ----- ----- ----- |               |               |               |               |               |               |               |               |               |               |               |
| alpha:  | 0.000   | 0.000         | 0.000         | 0.000         | 0.000         | 0.000         | 0.000         | 0.000         | 0.000         | 0.000         | 0.000         | 0.000         |
| beta:   | 0.000   | 0.000         | 0.000         | 0.000         | 0.000         | 0.000         | 0.000         | 0.000         | 0.000         | 0.000         | 0.000         | 0.000         |
| ta (secs):  | 0.000   | 0.000         | 0.000         | 0.000         | 0.000         | 0.000         | 0.000         | 0.000         | 0.000         | 0.000         | 0.000         | 0.000         |
| F:  | 0.000   | 0.000         | 0.000         | 0.000         | 0.000         | 0.000         | 0.000         | 0.000         | 0.000         | 0.000         | 0.000         | 0.000         |
| f:  | 0.000   | 0.000         | 0.000         | 0.000         | 0.000         | 0.000         | 0.000         | 0.000         | 0.000         | 0.000         | 0.000         | 0.000         |
| vcmax:  | 0   | 0             | 0             | 0             | 0             | 0             | 0             | 0             | 0             | 0             | 0             | 0             |
| vcg:  | 0   | 0             | 0             | 0             | 0             | 0             | 0             | 0             | 0             | 0             | 0             | 0             |
| vcmin:  | 0   | 0             | 0             | 0             | 0             | 0             | 0             | 0             | 0             | 0             | 0             | 0             |
| tp:   | 0.0   | 0.0           | 0.0           | 0.0           | 0.0           | 0.0           | 0.0           | 0.0           | 0.0           | 0.0           | 0.0           | 0.0           |
| P1:   | 0.000   | 0.000         | 0.000         | 0.000         | 0.000         | 0.000         | 0.000         | 0.000         | 0.000         | 0.000         | 0.000         | 0.000         |
| *** Computation 3: Platoon Event Periods                                  | ----- ----- ----- ----- ----- ----- ----- ----- ----- ----- ----- ----- |               |               |               |               |               |               |               |               |               |               |               |
| pdom/psubo:   | 0.000/0.000/Unconstrained   |               |               |               |               |               |               |               |               |               |               |               |
| *** Computation 4: Conflicting Flows During Each Unblocked Period         | ----- ----- ----- ----- ----- ----- ----- ----- ----- ----- ----- ----- |               |               |               |               |               |               |               |               |               |               |               |
| InitCnflVol:  | 1774  | xxxxx         | xxxxx         | 457           | xxxxx         | xxxxx         | 2515          | 2529          | 887           | 1632          | 2510          | 438           |
| AdjCnflVol:   | 1774  | xxxxx         | xxxxx         | 457           | xxxxx         | xxxxx         | 2515          | 2529          | 887           | 1632          | 2510          | 438           |
| UpstreamAdj:  | 1.00  | x.xxx         | x.xxx         | 1.00          | x.xxx         | x.xxx         | 1.00          | 1.000         | 1.000         | 1.00          | 1.000         | 1.000         |

ConflictVol:1774 xxxxx xxxxx 457 xxxxx xxxxx 2515 2529 887 1632 2510 438  
\*\*\* Computation 5: Capacity for Subject Movement During Unblocked Period  
InitPotCap: 355 xxxxx xxxxx 1114 xxxxx xxxxx 19 28 346 82 29 623  
UpstreamAdj:1.00 x.xxx x.xxx 1.00 x.xxx x.xxx 1.00 1.000 1.000 1.00 1.000 1.000  
Potent Cap.: 355 xxxxx xxxxx 1114 xxxxx xxxxx 19 28 346 82 29 623

BART

Level Of Service Computation Report  
 2000 HCM Operations (Future Volume Alternative)  
 AM - Bkgrd + Proj Conditions

Intersection #1012: El Camino Real/Railroad Ave [Study Int 53]

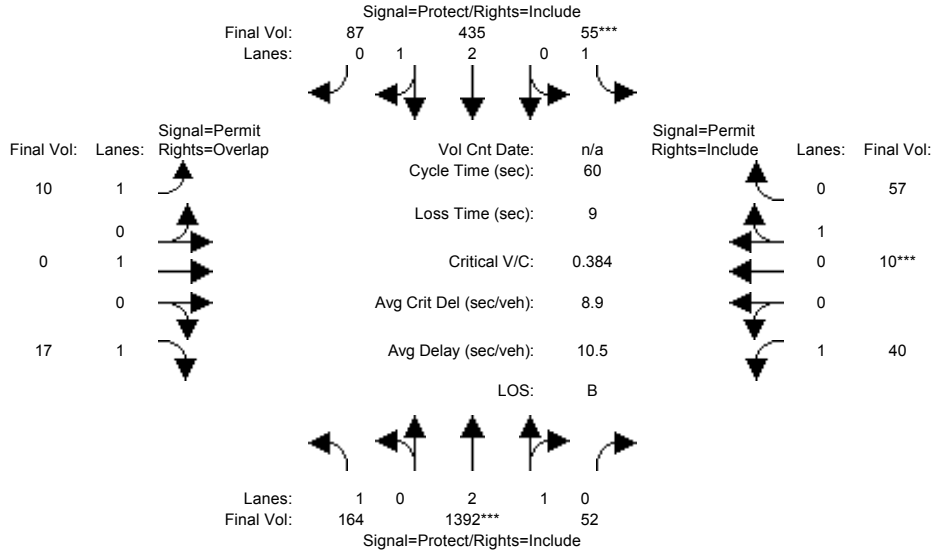

| Approach:                 | North Bound |      |      | South Bound |      |      | East Bound |      |      | West Bound |      |      |
|---------------------------|-------------|------|------|-------------|------|------|------------|------|------|------------|------|------|
| Movement:                 | L           | T    | R    | L           | T    | R    | L          | T    | R    | L          | T    | R    |
| Min. Green:               | 7           | 10   | 10   | 7           | 10   | 10   | 10         | 10   | 10   | 10         | 10   | 10   |
| Y+R:                      | 4.0         | 4.0  | 4.0  | 4.0         | 4.0  | 4.0  | 4.0        | 4.0  | 4.0  | 4.0        | 4.0  | 4.0  |
| Volume Module:            |             |      |      |             |      |      |            |      |      |            |      |      |
| Base Vol:                 | 164         | 1392 | 52   | 55          | 435  | 87   | 10         | 0    | 17   | 40         | 10   | 57   |
| Growth Adj:               | 1.00        | 1.00 | 1.00 | 1.00        | 1.00 | 1.00 | 1.00       | 1.00 | 1.00 | 1.00       | 1.00 | 1.00 |
| Initial Bse:              | 164         | 1392 | 52   | 55          | 435  | 87   | 10         | 0    | 17   | 40         | 10   | 57   |
| Added Vol:                | 0           | 0    | 0    | 0           | 0    | 0    | 0          | 0    | 0    | 0          | 0    | 0    |
| PasserByVol:              | 0           | 0    | 0    | 0           | 0    | 0    | 0          | 0    | 0    | 0          | 0    | 0    |
| Initial Fut:              | 164         | 1392 | 52   | 55          | 435  | 87   | 10         | 0    | 17   | 40         | 10   | 57   |
| User Adj:                 | 1.00        | 1.00 | 1.00 | 1.00        | 1.00 | 1.00 | 1.00       | 1.00 | 1.00 | 1.00       | 1.00 | 1.00 |
| PHF Adj:                  | 1.00        | 1.00 | 1.00 | 1.00        | 1.00 | 1.00 | 1.00       | 1.00 | 1.00 | 1.00       | 1.00 | 1.00 |
| PHF Volume:               | 164         | 1392 | 52   | 55          | 435  | 87   | 10         | 0    | 17   | 40         | 10   | 57   |
| Reduct Vol:               | 0           | 0    | 0    | 0           | 0    | 0    | 0          | 0    | 0    | 0          | 0    | 0    |
| Reduced Vol:              | 164         | 1392 | 52   | 55          | 435  | 87   | 10         | 0    | 17   | 40         | 10   | 57   |
| PCE Adj:                  | 1.00        | 1.00 | 1.00 | 1.00        | 1.00 | 1.00 | 1.00       | 1.00 | 1.00 | 1.00       | 1.00 | 1.00 |
| MLF Adj:                  | 1.00        | 1.00 | 1.00 | 1.00        | 1.00 | 1.00 | 1.00       | 1.00 | 1.00 | 1.00       | 1.00 | 1.00 |
| FinalVolume:              | 164         | 1392 | 52   | 55          | 435  | 87   | 10         | 0    | 17   | 40         | 10   | 57   |
| Saturation Flow Module:   |             |      |      |             |      |      |            |      |      |            |      |      |
| Sat/Lane:                 | 1900        | 1900 | 1900 | 1900        | 1900 | 1900 | 1900       | 1900 | 1900 | 1900       | 1900 | 1900 |
| Adjustment:               | 0.92        | 0.98 | 0.95 | 0.92        | 0.99 | 0.95 | 0.92       | 1.00 | 0.92 | 0.92       | 0.95 | 0.95 |
| Lanes:                    | 1.00        | 2.89 | 0.11 | 1.00        | 2.48 | 0.52 | 1.00       | 1.00 | 1.00 | 1.00       | 0.15 | 0.85 |
| Final Sat.:               | 1750        | 5398 | 202  | 1750        | 4665 | 933  | 1750       | 1900 | 1750 | 1750       | 269  | 1531 |
| Capacity Analysis Module: |             |      |      |             |      |      |            |      |      |            |      |      |
| Vol/Sat:                  | 0.09        | 0.26 | 0.26 | 0.03        | 0.09 | 0.09 | 0.01       | 0.00 | 0.01 | 0.02       | 0.04 | 0.04 |
| Crit Moves:               | ****        |      |      | ****        |      |      |            |      |      | ****       |      |      |
| Green Time:               | 16.9        | 34.0 | 34.0 | 7.0         | 24.1 | 24.1 | 10.0       | 0.0  | 26.9 | 10.0       | 10.0 | 10.0 |
| Volume/Cap:               | 0.33        | 0.46 | 0.46 | 0.27        | 0.23 | 0.23 | 0.03       | 0.00 | 0.02 | 0.14       | 0.22 | 0.22 |
| Delay/Veh:                | 17.5        | 7.7  | 7.7  | 24.9        | 11.9 | 11.9 | 21.0       | 0.0  | 9.2  | 21.5       | 22.0 | 22.0 |
| User DelAdj:              | 1.00        | 1.00 | 1.00 | 1.00        | 1.00 | 1.00 | 1.00       | 1.00 | 1.00 | 1.00       | 1.00 | 1.00 |
| AdjDel/Veh:               | 17.5        | 7.7  | 7.7  | 24.9        | 11.9 | 11.9 | 21.0       | 0.0  | 9.2  | 21.5       | 22.0 | 22.0 |
| LOS by Move:              | B           | A    | A    | C           | B    | B    | C          | A    | A    | C          | C    | C    |
| HCM2k95thQ:               | 6           | 11   | 11   | 2           | 4    | 4    | 0          | 0    | 0    | 2          | 3    | 3    |

Note: Queue reported is the number of cars per lane.

BART

Level Of Service Computation Report  
 2000 HCM Operations (Future Volume Alternative)  
 PM - Bkgrd + Proj Conditions

Intersection #1012: El Camino Real/Railroad Ave [Study Int 53]

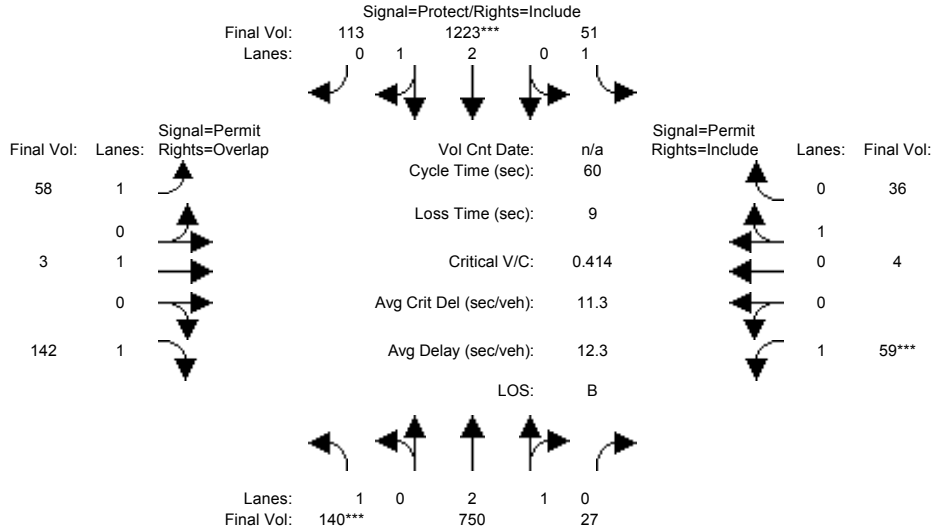

| Approach:                 | North Bound |      |      | South Bound |      |      | East Bound |      |      | West Bound |      |      |
|---------------------------|-------------|------|------|-------------|------|------|------------|------|------|------------|------|------|
| Movement:                 | L           | T    | R    | L           | T    | R    | L          | T    | R    | L          | T    | R    |
| Min. Green:               | 7           | 10   | 10   | 7           | 10   | 10   | 10         | 10   | 10   | 10         | 10   | 10   |
| Y+R:                      | 4.0         | 4.0  | 4.0  | 4.0         | 4.0  | 4.0  | 4.0        | 4.0  | 4.0  | 4.0        | 4.0  | 4.0  |
| Volume Module:            |             |      |      |             |      |      |            |      |      |            |      |      |
| Base Vol:                 | 140         | 750  | 27   | 51          | 1223 | 113  | 58         | 3    | 142  | 59         | 4    | 36   |
| Growth Adj:               | 1.00        | 1.00 | 1.00 | 1.00        | 1.00 | 1.00 | 1.00       | 1.00 | 1.00 | 1.00       | 1.00 | 1.00 |
| Initial Bse:              | 140         | 750  | 27   | 51          | 1223 | 113  | 58         | 3    | 142  | 59         | 4    | 36   |
| Added Vol:                | 0           | 0    | 0    | 0           | 0    | 0    | 0          | 0    | 0    | 0          | 0    | 0    |
| PasserByVol:              | 0           | 0    | 0    | 0           | 0    | 0    | 0          | 0    | 0    | 0          | 0    | 0    |
| Initial Fut:              | 140         | 750  | 27   | 51          | 1223 | 113  | 58         | 3    | 142  | 59         | 4    | 36   |
| User Adj:                 | 1.00        | 1.00 | 1.00 | 1.00        | 1.00 | 1.00 | 1.00       | 1.00 | 1.00 | 1.00       | 1.00 | 1.00 |
| PHF Adj:                  | 1.00        | 1.00 | 1.00 | 1.00        | 1.00 | 1.00 | 1.00       | 1.00 | 1.00 | 1.00       | 1.00 | 1.00 |
| PHF Volume:               | 140         | 750  | 27   | 51          | 1223 | 113  | 58         | 3    | 142  | 59         | 4    | 36   |
| Reduct Vol:               | 0           | 0    | 0    | 0           | 0    | 0    | 0          | 0    | 0    | 0          | 0    | 0    |
| Reduced Vol:              | 140         | 750  | 27   | 51          | 1223 | 113  | 58         | 3    | 142  | 59         | 4    | 36   |
| PCE Adj:                  | 1.00        | 1.00 | 1.00 | 1.00        | 1.00 | 1.00 | 1.00       | 1.00 | 1.00 | 1.00       | 1.00 | 1.00 |
| MLF Adj:                  | 1.00        | 1.00 | 1.00 | 1.00        | 1.00 | 1.00 | 1.00       | 1.00 | 1.00 | 1.00       | 1.00 | 1.00 |
| Final Volume:             | 140         | 750  | 27   | 51          | 1223 | 113  | 58         | 3    | 142  | 59         | 4    | 36   |
| Saturation Flow Module:   |             |      |      |             |      |      |            |      |      |            |      |      |
| Sat/Lane:                 | 1900        | 1900 | 1900 | 1900        | 1900 | 1900 | 1900       | 1900 | 1900 | 1900       | 1900 | 1900 |
| Adjustment:               | 0.92        | 0.98 | 0.95 | 0.92        | 0.99 | 0.95 | 0.92       | 1.00 | 0.92 | 0.92       | 0.95 | 0.95 |
| Lanes:                    | 1.00        | 2.89 | 0.11 | 1.00        | 2.74 | 0.26 | 1.00       | 1.00 | 1.00 | 1.00       | 0.10 | 0.90 |
| Final Sat.:               | 1750        | 5405 | 195  | 1750        | 5126 | 474  | 1750       | 1900 | 1750 | 1750       | 180  | 1620 |
| Capacity Analysis Module: |             |      |      |             |      |      |            |      |      |            |      |      |
| Vol/Sat:                  | 0.08        | 0.14 | 0.14 | 0.03        | 0.24 | 0.24 | 0.03       | 0.00 | 0.08 | 0.03       | 0.02 | 0.02 |
| Crit Moves:               | ****        |      |      | ****        |      |      |            |      | **** | ****       |      |      |
| Green Time:               | 10.3        | 24.1 | 24.1 | 16.9        | 30.7 | 30.7 | 10.0       | 10.0 | 20.3 | 10.0       | 10.0 | 10.0 |
| Volume/Cap:               | 0.47        | 0.35 | 0.35 | 0.10        | 0.47 | 0.47 | 0.20       | 0.01 | 0.24 | 0.20       | 0.13 | 0.13 |
| Delay/Veh:                | 23.5        | 12.6 | 12.6 | 16.1        | 9.5  | 9.5  | 21.9       | 20.9 | 14.5 | 21.9       | 21.5 | 21.5 |
| User DelAdj:              | 1.00        | 1.00 | 1.00 | 1.00        | 1.00 | 1.00 | 1.00       | 1.00 | 1.00 | 1.00       | 1.00 | 1.00 |
| AdjDel/Veh:               | 23.5        | 12.6 | 12.6 | 16.1        | 9.5  | 9.5  | 21.9       | 20.9 | 14.5 | 21.9       | 21.5 | 21.5 |
| LOS by Move:              | C           | B    | B    | B           | A    | A    | C          | C    | B    | C          | C    | C    |
| HCM2k95thQ:               | 6           | 7    | 7    | 1           | 10   | 10   | 2          | 0    | 4    | 2          | 2    | 2    |

Note: Queue reported is the number of cars per lane.

BART

Level Of Service Computation Report  
 2000 HCM Operations (Future Volume Alternative)  
 AM - Bkgrd + Proj Conditions

Intersection #1202: LAFAYETTE/EL CAMINO REAL [Study Int 46]

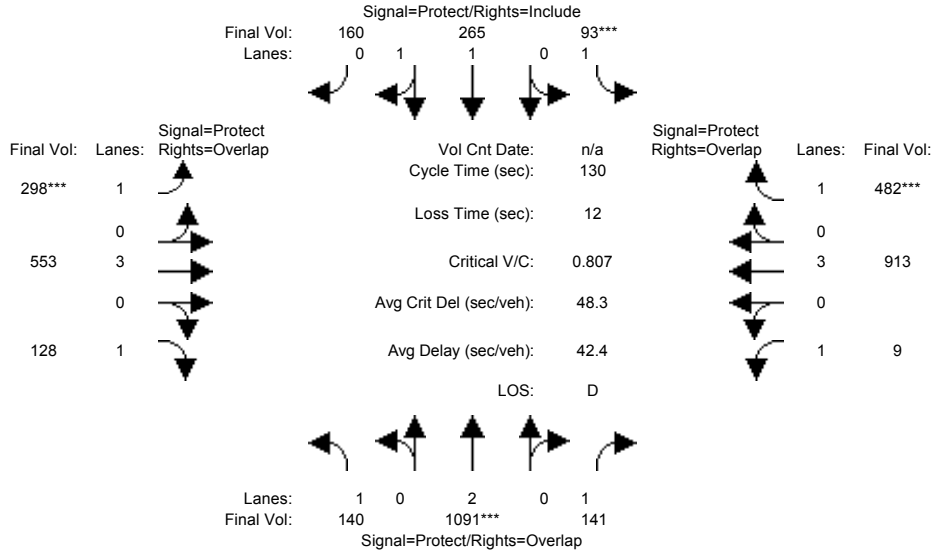

| Approach:                 | North Bound |      |      | South Bound |      |      | East Bound |      |      | West Bound |      |      |
|---------------------------|-------------|------|------|-------------|------|------|------------|------|------|------------|------|------|
| Movement:                 | L           | T    | R    | L           | T    | R    | L          | T    | R    | L          | T    | R    |
| Min. Green:               | 7           | 10   | 10   | 7           | 10   | 10   | 7          | 10   | 10   | 7          | 10   | 10   |
| Y+R:                      | 4.0         | 4.0  | 4.0  | 4.0         | 4.0  | 4.0  | 4.0        | 4.0  | 4.0  | 4.0        | 4.0  | 4.0  |
| Volume Module:            |             |      |      |             |      |      |            |      |      |            |      |      |
| Base Vol:                 | 140         | 1091 | 141  | 93          | 265  | 160  | 298        | 553  | 128  | 9          | 913  | 482  |
| Growth Adj:               | 1.00        | 1.00 | 1.00 | 1.00        | 1.00 | 1.00 | 1.00       | 1.00 | 1.00 | 1.00       | 1.00 | 1.00 |
| Initial Bse:              | 140         | 1091 | 141  | 93          | 265  | 160  | 298        | 553  | 128  | 9          | 913  | 482  |
| Added Vol:                | 0           | 0    | 0    | 0           | 0    | 0    | 0          | 0    | 0    | 0          | 0    | 0    |
| PasserByVol:              | 0           | 0    | 0    | 0           | 0    | 0    | 0          | 0    | 0    | 0          | 0    | 0    |
| Initial Fut:              | 140         | 1091 | 141  | 93          | 265  | 160  | 298        | 553  | 128  | 9          | 913  | 482  |
| User Adj:                 | 1.00        | 1.00 | 1.00 | 1.00        | 1.00 | 1.00 | 1.00       | 1.00 | 1.00 | 1.00       | 1.00 | 1.00 |
| PHF Adj:                  | 1.00        | 1.00 | 1.00 | 1.00        | 1.00 | 1.00 | 1.00       | 1.00 | 1.00 | 1.00       | 1.00 | 1.00 |
| PHF Volume:               | 140         | 1091 | 141  | 93          | 265  | 160  | 298        | 553  | 128  | 9          | 913  | 482  |
| Reduct Vol:               | 0           | 0    | 0    | 0           | 0    | 0    | 0          | 0    | 0    | 0          | 0    | 0    |
| Reduced Vol:              | 140         | 1091 | 141  | 93          | 265  | 160  | 298        | 553  | 128  | 9          | 913  | 482  |
| PCE Adj:                  | 1.00        | 1.00 | 1.00 | 1.00        | 1.00 | 1.00 | 1.00       | 1.00 | 1.00 | 1.00       | 1.00 | 1.00 |
| MLF Adj:                  | 1.00        | 1.00 | 1.00 | 1.00        | 1.00 | 1.00 | 1.00       | 1.00 | 1.00 | 1.00       | 1.00 | 1.00 |
| Final Volume:             | 140         | 1091 | 141  | 93          | 265  | 160  | 298        | 553  | 128  | 9          | 913  | 482  |
| Saturation Flow Module:   |             |      |      |             |      |      |            |      |      |            |      |      |
| Sat/Lane:                 | 1900        | 1900 | 1900 | 1900        | 1900 | 1900 | 1900       | 1900 | 1900 | 1900       | 1900 | 1900 |
| Adjustment:               | 0.92        | 1.00 | 0.92 | 0.92        | 0.99 | 0.95 | 0.92       | 1.00 | 0.92 | 0.92       | 1.00 | 0.92 |
| Lanes:                    | 1.00        | 2.00 | 1.00 | 1.00        | 1.23 | 0.77 | 1.00       | 3.00 | 1.00 | 1.00       | 3.00 | 1.00 |
| Final Sat.:               | 1750        | 3800 | 1750 | 1750        | 2306 | 1392 | 1750       | 5700 | 1750 | 1750       | 5700 | 1750 |
| Capacity Analysis Module: |             |      |      |             |      |      |            |      |      |            |      |      |
| Vol/Sat:                  | 0.08        | 0.29 | 0.08 | 0.05        | 0.11 | 0.11 | 0.17       | 0.10 | 0.07 | 0.01       | 0.16 | 0.28 |
| Crit Moves:               | ****        | **** | **** | ****        | **** | **** | ****       | **** | **** | ****       | **** | **** |
| Green Time:               | 22.5        | 46.2 | 68.8 | 8.6         | 32.3 | 32.3 | 27.4       | 40.6 | 63.1 | 22.5       | 35.7 | 44.2 |
| Volume/Cap:               | 0.46        | 0.81 | 0.15 | 0.81        | 0.46 | 0.46 | 0.81       | 0.31 | 0.15 | 0.03       | 0.58 | 0.81 |
| Delay/Veh:                | 49.4        | 41.6 | 15.8 | 92.8        | 41.8 | 41.8 | 61.1       | 34.2 | 18.7 | 44.7       | 41.3 | 47.2 |
| User DelAdj:              | 1.00        | 1.00 | 1.00 | 1.00        | 1.00 | 1.00 | 1.00       | 1.00 | 1.00 | 1.00       | 1.00 | 1.00 |
| AdjDel/Veh:               | 49.4        | 41.6 | 15.8 | 92.8        | 41.8 | 41.8 | 61.1       | 34.2 | 18.7 | 44.7       | 41.3 | 47.2 |
| LOS by Move:              | D           | D    | B    | F           | D    | D    | E          | C    | B    | D          | D    | D    |
| HCM2k95thQ:               | 10          | 34   | 6    | 9           | 14   | 14   | 22         | 10   | 6    | 1          | 20   | 35   |

Note: Queue reported is the number of cars per lane.



BART

Level Of Service Computation Report  
2000 HCM Operations (Future Volume Alternative)  
PM - Bkgrd + Proj Conditions

Intersection #1202: LAFAYETTE/EL CAMINO REAL [Study Int 46]

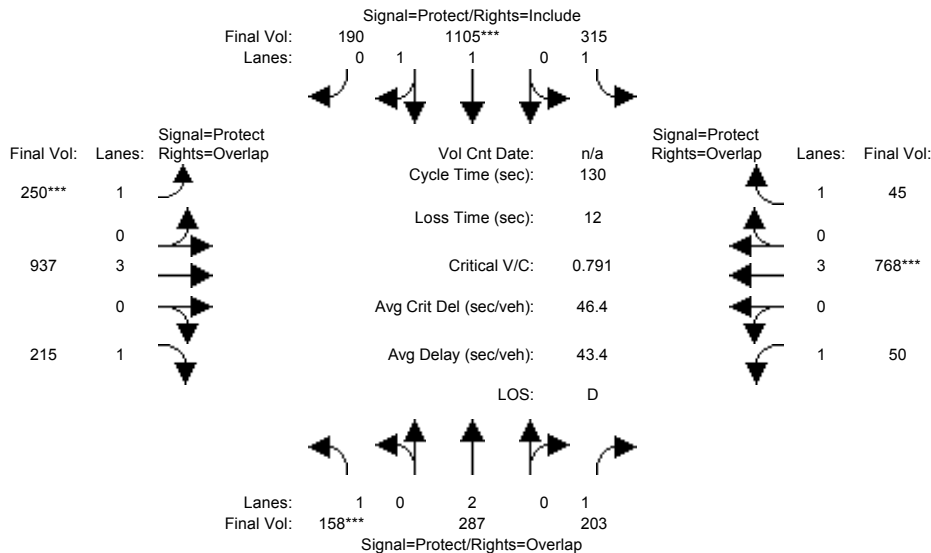

| Approach:                 | North Bound |      |      | South Bound |      |      | East Bound |      |      | West Bound |      |      |
|---------------------------|-------------|------|------|-------------|------|------|------------|------|------|------------|------|------|
| Movement:                 | L           | T    | R    | L           | T    | R    | L          | T    | R    | L          | T    | R    |
| Min. Green:               | 7           | 10   | 10   | 7           | 10   | 10   | 7          | 10   | 10   | 7          | 10   | 10   |
| Y+R:                      | 4.0         | 4.0  | 4.0  | 4.0         | 4.0  | 4.0  | 4.0        | 4.0  | 4.0  | 4.0        | 4.0  | 4.0  |
| Volume Module:            |             |      |      |             |      |      |            |      |      |            |      |      |
| Base Vol:                 | 158         | 287  | 203  | 315         | 1105 | 190  | 250        | 937  | 215  | 50         | 768  | 45   |
| Growth Adj:               | 1.00        | 1.00 | 1.00 | 1.00        | 1.00 | 1.00 | 1.00       | 1.00 | 1.00 | 1.00       | 1.00 | 1.00 |
| Initial Bse:              | 158         | 287  | 203  | 315         | 1105 | 190  | 250        | 937  | 215  | 50         | 768  | 45   |
| Added Vol:                | 0           | 0    | 0    | 0           | 0    | 0    | 0          | 0    | 0    | 0          | 0    | 0    |
| PasserByVol:              | 0           | 0    | 0    | 0           | 0    | 0    | 0          | 0    | 0    | 0          | 0    | 0    |
| Initial Fut:              | 158         | 287  | 203  | 315         | 1105 | 190  | 250        | 937  | 215  | 50         | 768  | 45   |
| User Adj:                 | 1.00        | 1.00 | 1.00 | 1.00        | 1.00 | 1.00 | 1.00       | 1.00 | 1.00 | 1.00       | 1.00 | 1.00 |
| PHF Adj:                  | 1.00        | 1.00 | 1.00 | 1.00        | 1.00 | 1.00 | 1.00       | 1.00 | 1.00 | 1.00       | 1.00 | 1.00 |
| PHF Volume:               | 158         | 287  | 203  | 315         | 1105 | 190  | 250        | 937  | 215  | 50         | 768  | 45   |
| Reduct Vol:               | 0           | 0    | 0    | 0           | 0    | 0    | 0          | 0    | 0    | 0          | 0    | 0    |
| Reduced Vol:              | 158         | 287  | 203  | 315         | 1105 | 190  | 250        | 937  | 215  | 50         | 768  | 45   |
| PCE Adj:                  | 1.00        | 1.00 | 1.00 | 1.00        | 1.00 | 1.00 | 1.00       | 1.00 | 1.00 | 1.00       | 1.00 | 1.00 |
| MLF Adj:                  | 1.00        | 1.00 | 1.00 | 1.00        | 1.00 | 1.00 | 1.00       | 1.00 | 1.00 | 1.00       | 1.00 | 1.00 |
| Final Volume:             | 158         | 287  | 203  | 315         | 1105 | 190  | 250        | 937  | 215  | 50         | 768  | 45   |
| Saturation Flow Module:   |             |      |      |             |      |      |            |      |      |            |      |      |
| Sat/Lane:                 | 1900        | 1900 | 1900 | 1900        | 1900 | 1900 | 1900       | 1900 | 1900 | 1900       | 1900 | 1900 |
| Adjustment:               | 0.92        | 1.00 | 0.92 | 0.92        | 0.98 | 0.95 | 0.92       | 1.00 | 0.92 | 0.92       | 1.00 | 0.92 |
| Lanes:                    | 1.00        | 2.00 | 1.00 | 1.00        | 1.70 | 0.30 | 1.00       | 3.00 | 1.00 | 1.00       | 3.00 | 1.00 |
| Final Sat.:               | 1750        | 3800 | 1750 | 1750        | 3157 | 543  | 1750       | 5700 | 1750 | 1750       | 5700 | 1750 |
| Capacity Analysis Module: |             |      |      |             |      |      |            |      |      |            |      |      |
| Vol/Sat:                  | 0.09        | 0.08 | 0.12 | 0.18        | 0.35 | 0.35 | 0.14       | 0.16 | 0.12 | 0.03       | 0.13 | 0.03 |
| Crit Moves:               | ****        |      |      | ****        |      |      | ****       |      |      | ****       |      |      |
| Green Time:               | 14.8        | 23.7 | 34.9 | 48.7        | 57.5 | 57.5 | 23.5       | 34.4 | 49.2 | 11.3       | 22.1 | 70.9 |
| Volume/Cap:               | 0.79        | 0.41 | 0.43 | 0.48        | 0.79 | 0.79 | 0.79       | 0.62 | 0.32 | 0.33       | 0.79 | 0.05 |
| Delay/Veh:                | 75.0        | 47.5 | 40.0 | 31.5        | 33.8 | 33.8 | 63.6       | 42.9 | 28.9 | 57.1       | 56.2 | 13.8 |
| User DelAdj:              | 1.00        | 1.00 | 1.00 | 1.00        | 1.00 | 1.00 | 1.00       | 1.00 | 1.00 | 1.00       | 1.00 | 1.00 |
| AdjDel/Veh:               | 75.0        | 47.5 | 40.0 | 31.5        | 33.8 | 33.8 | 63.6       | 42.9 | 28.9 | 57.1       | 56.2 | 13.8 |
| LOS by Move:              | E           | D    | D    | C           | C    | C    | E          | D    | C    | E          | E    | B    |
| HCM2k95thQ:               | 13          | 10   | 13   | 19          | 39   | 39   | 20         | 20   | 12   | 5          | 21   | 2    |

Note: Queue reported is the number of cars per lane.

BART

Level Of Service Computation Report  
 2000 HCM Operations (Future Volume Alternative)  
 AM - Bkgrd + Proj Conditions

Intersection #1203: ECR/Lincoln 1203 [Study Int 43]

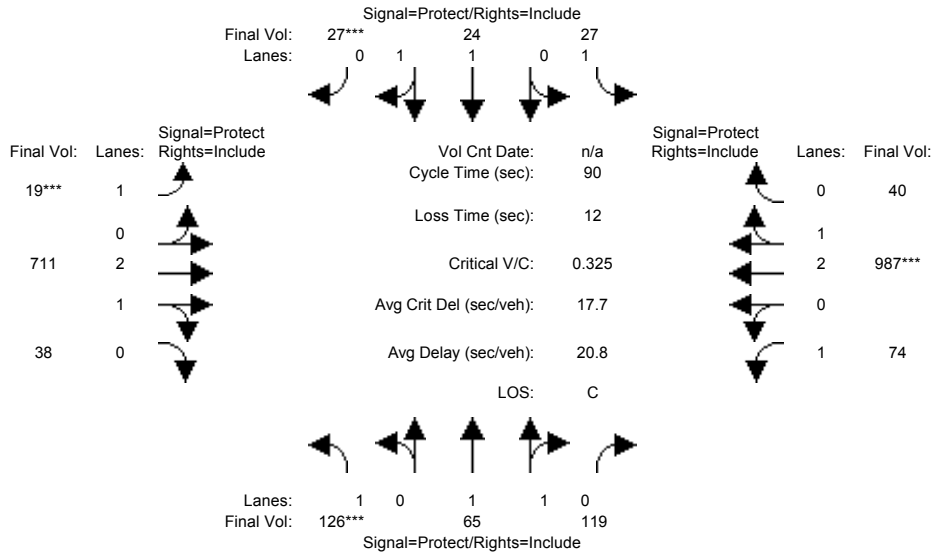

| Approach:                 | North Bound |      |      | South Bound |      |      | East Bound |      |      | West Bound |      |      |
|---------------------------|-------------|------|------|-------------|------|------|------------|------|------|------------|------|------|
| Movement:                 | L           | T    | R    | L           | T    | R    | L          | T    | R    | L          | T    | R    |
| Min. Green:               | 7           | 10   | 10   | 7           | 10   | 10   | 7          | 10   | 10   | 7          | 10   | 10   |
| Y+R:                      | 4.0         | 4.0  | 4.0  | 4.0         | 4.0  | 4.0  | 4.0        | 4.0  | 4.0  | 4.0        | 4.0  | 4.0  |
| Volume Module:            |             |      |      |             |      |      |            |      |      |            |      |      |
| Base Vol:                 | 126         | 65   | 119  | 27          | 24   | 27   | 19         | 711  | 38   | 74         | 987  | 40   |
| Growth Adj:               | 1.00        | 1.00 | 1.00 | 1.00        | 1.00 | 1.00 | 1.00       | 1.00 | 1.00 | 1.00       | 1.00 | 1.00 |
| Initial Bse:              | 126         | 65   | 119  | 27          | 24   | 27   | 19         | 711  | 38   | 74         | 987  | 40   |
| Added Vol:                | 0           | 0    | 0    | 0           | 0    | 0    | 0          | 0    | 0    | 0          | 0    | 0    |
| PasserByVol:              | 0           | 0    | 0    | 0           | 0    | 0    | 0          | 0    | 0    | 0          | 0    | 0    |
| Initial Fut:              | 126         | 65   | 119  | 27          | 24   | 27   | 19         | 711  | 38   | 74         | 987  | 40   |
| User Adj:                 | 1.00        | 1.00 | 1.00 | 1.00        | 1.00 | 1.00 | 1.00       | 1.00 | 1.00 | 1.00       | 1.00 | 1.00 |
| PHF Adj:                  | 1.00        | 1.00 | 1.00 | 1.00        | 1.00 | 1.00 | 1.00       | 1.00 | 1.00 | 1.00       | 1.00 | 1.00 |
| PHF Volume:               | 126         | 65   | 119  | 27          | 24   | 27   | 19         | 711  | 38   | 74         | 987  | 40   |
| Reduct Vol:               | 0           | 0    | 0    | 0           | 0    | 0    | 0          | 0    | 0    | 0          | 0    | 0    |
| Reduced Vol:              | 126         | 65   | 119  | 27          | 24   | 27   | 19         | 711  | 38   | 74         | 987  | 40   |
| PCE Adj:                  | 1.00        | 1.00 | 1.00 | 1.00        | 1.00 | 1.00 | 1.00       | 1.00 | 1.00 | 1.00       | 1.00 | 1.00 |
| MLF Adj:                  | 1.00        | 1.00 | 1.00 | 1.00        | 1.00 | 1.00 | 1.00       | 1.00 | 1.00 | 1.00       | 1.00 | 1.00 |
| FinalVolume:              | 126         | 65   | 119  | 27          | 24   | 27   | 19         | 711  | 38   | 74         | 987  | 40   |
| Saturation Flow Module:   |             |      |      |             |      |      |            |      |      |            |      |      |
| Sat/Lane:                 | 1900        | 1900 | 1900 | 1900        | 1900 | 1900 | 1900       | 1900 | 1900 | 1900       | 1900 | 1900 |
| Adjustment:               | 0.92        | 1.00 | 0.92 | 0.92        | 1.00 | 0.92 | 0.92       | 0.98 | 0.95 | 0.92       | 0.98 | 0.95 |
| Lanes:                    | 1.00        | 1.00 | 1.00 | 1.00        | 1.00 | 1.00 | 1.00       | 2.84 | 0.16 | 1.00       | 2.88 | 0.12 |
| Final Sat.:               | 1750        | 1900 | 1750 | 1750        | 1900 | 1750 | 1750       | 5316 | 284  | 1750       | 5382 | 218  |
| Capacity Analysis Module: |             |      |      |             |      |      |            |      |      |            |      |      |
| Vol/Sat:                  | 0.07        | 0.03 | 0.07 | 0.02        | 0.01 | 0.02 | 0.01       | 0.13 | 0.13 | 0.04       | 0.18 | 0.18 |
| Crit Moves:               | ****        |      |      | ****        | **** | **** | ****       | **** | **** | ****       | **** | **** |
| Green Time:               | 17.2        | 16.0 | 16.0 | 11.2        | 10.0 | 10.0 | 7.0        | 32.1 | 32.1 | 18.7       | 43.8 | 43.8 |
| Volume/Cap:               | 0.38        | 0.19 | 0.38 | 0.12        | 0.11 | 0.14 | 0.14       | 0.37 | 0.37 | 0.20       | 0.38 | 0.38 |
| Delay/Veh:                | 32.4        | 31.6 | 33.2 | 35.3        | 36.1 | 36.3 | 39.2       | 21.6 | 21.6 | 29.8       | 14.6 | 14.6 |
| User DelAdj:              | 1.00        | 1.00 | 1.00 | 1.00        | 1.00 | 1.00 | 1.00       | 1.00 | 1.00 | 1.00       | 1.00 | 1.00 |
| AdjDel/Veh:               | 32.4        | 31.6 | 33.2 | 35.3        | 36.1 | 36.3 | 39.2       | 21.6 | 21.6 | 29.8       | 14.6 | 14.6 |
| LOS by Move:              | C           | C    | C    | D           | D    | D    | D          | C    | C    | C          | B    | B    |
| HCM2k95thQ:               | 6           | 3    | 6    | 2           | 1    | 2    | 1          | 10   | 10   | 4          | 11   | 11   |

Note: Queue reported is the number of cars per lane.

BART

Level Of Service Computation Report  
 2000 HCM Operations (Future Volume Alternative)  
 PM - Bkgrd + Proj Conditions

Intersection #1203: ECR/Lincoln 1203 [Study Int 43]

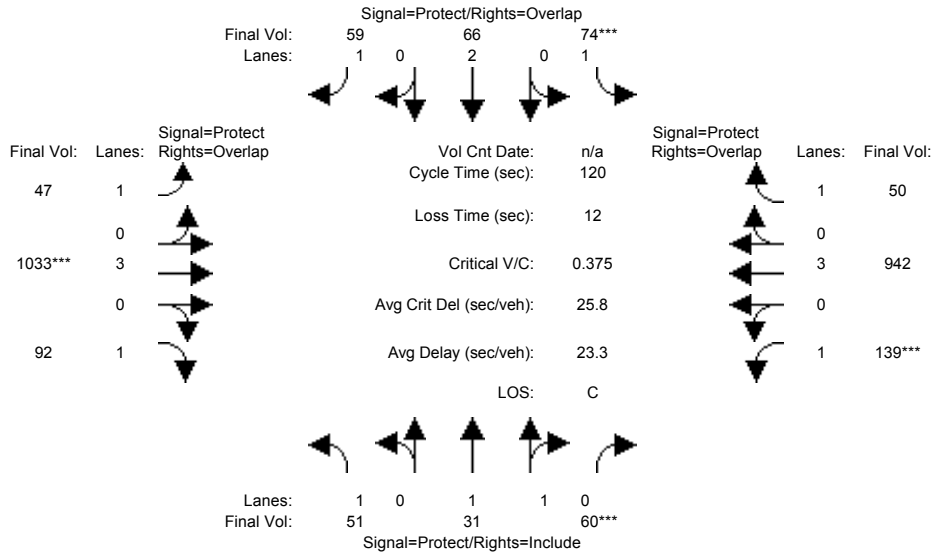

| Approach:                 | North Bound |      |      | South Bound |      |      | East Bound |      |      | West Bound |      |      |
|---------------------------|-------------|------|------|-------------|------|------|------------|------|------|------------|------|------|
| Movement:                 | L           | T    | R    | L           | T    | R    | L          | T    | R    | L          | T    | R    |
| Min. Green:               | 7           | 10   | 10   | 7           | 10   | 10   | 7          | 10   | 10   | 7          | 10   | 10   |
| Y+R:                      | 4.0         | 4.0  | 4.0  | 4.0         | 4.0  | 4.0  | 4.0        | 4.0  | 4.0  | 4.0        | 4.0  | 4.0  |
| Volume Module:            |             |      |      |             |      |      |            |      |      |            |      |      |
| Base Vol:                 | 51          | 31   | 60   | 74          | 66   | 59   | 47         | 1033 | 92   | 139        | 942  | 50   |
| Growth Adj:               | 1.00        | 1.00 | 1.00 | 1.00        | 1.00 | 1.00 | 1.00       | 1.00 | 1.00 | 1.00       | 1.00 | 1.00 |
| Initial Bse:              | 51          | 31   | 60   | 74          | 66   | 59   | 47         | 1033 | 92   | 139        | 942  | 50   |
| Added Vol:                | 0           | 0    | 0    | 0           | 0    | 0    | 0          | 0    | 0    | 0          | 0    | 0    |
| PasserByVol:              | 0           | 0    | 0    | 0           | 0    | 0    | 0          | 0    | 0    | 0          | 0    | 0    |
| Initial Fut:              | 51          | 31   | 60   | 74          | 66   | 59   | 47         | 1033 | 92   | 139        | 942  | 50   |
| User Adj:                 | 1.00        | 1.00 | 1.00 | 1.00        | 1.00 | 1.00 | 1.00       | 1.00 | 1.00 | 1.00       | 1.00 | 1.00 |
| PHF Adj:                  | 1.00        | 1.00 | 1.00 | 1.00        | 1.00 | 1.00 | 1.00       | 1.00 | 1.00 | 1.00       | 1.00 | 1.00 |
| PHF Volume:               | 51          | 31   | 60   | 74          | 66   | 59   | 47         | 1033 | 92   | 139        | 942  | 50   |
| Reduct Vol:               | 0           | 0    | 0    | 0           | 0    | 0    | 0          | 0    | 0    | 0          | 0    | 0    |
| Reduced Vol:              | 51          | 31   | 60   | 74          | 66   | 59   | 47         | 1033 | 92   | 139        | 942  | 50   |
| PCE Adj:                  | 1.00        | 1.00 | 1.00 | 1.00        | 1.00 | 1.00 | 1.00       | 1.00 | 1.00 | 1.00       | 1.00 | 1.00 |
| MLF Adj:                  | 1.00        | 1.00 | 1.00 | 1.00        | 1.00 | 1.00 | 1.00       | 1.00 | 1.00 | 1.00       | 1.00 | 1.00 |
| Final Volume:             | 51          | 31   | 60   | 74          | 66   | 59   | 47         | 1033 | 92   | 139        | 942  | 50   |
| Saturation Flow Module:   |             |      |      |             |      |      |            |      |      |            |      |      |
| Sat/Lane:                 | 1900        | 1900 | 1900 | 1900        | 1900 | 1900 | 1900       | 1900 | 1900 | 1900       | 1900 | 1900 |
| Adjustment:               | 0.92        | 1.00 | 0.92 | 0.92        | 1.00 | 0.92 | 0.92       | 1.00 | 0.92 | 0.92       | 1.00 | 0.92 |
| Lanes:                    | 1.00        | 1.00 | 1.00 | 1.00        | 2.00 | 1.00 | 1.00       | 3.00 | 1.00 | 1.00       | 3.00 | 1.00 |
| Final Sat.:               | 1750        | 1900 | 1750 | 1750        | 3800 | 1750 | 1750       | 5700 | 1750 | 1750       | 5700 | 1750 |
| Capacity Analysis Module: |             |      |      |             |      |      |            |      |      |            |      |      |
| Vol/Sat:                  | 0.03        | 0.02 | 0.03 | 0.04        | 0.02 | 0.03 | 0.03       | 0.18 | 0.05 | 0.08       | 0.17 | 0.03 |
| Crit Moves:               | ****        | **** | **** | ****        | **** | **** | ****       | **** | **** | ****       | **** | **** |
| Green Time:               | 10.1        | 11.0 | 11.0 | 13.5        | 14.4 | 36.2 | 21.8       | 58.0 | 68.1 | 25.4       | 61.7 | 75.2 |
| Volume/Cap:               | 0.35        | 0.18 | 0.37 | 0.37        | 0.14 | 0.11 | 0.15       | 0.37 | 0.09 | 0.37       | 0.32 | 0.05 |
| Delay/Veh:                | 53.3        | 50.5 | 52.3 | 50.5        | 47.4 | 30.4 | 41.5       | 19.6 | 11.9 | 41.1       | 17.0 | 8.6  |
| User DelAdj:              | 1.00        | 1.00 | 1.00 | 1.00        | 1.00 | 1.00 | 1.00       | 1.00 | 1.00 | 1.00       | 1.00 | 1.00 |
| AdjDel/Veh:               | 53.3        | 50.5 | 52.3 | 50.5        | 47.4 | 30.4 | 41.5       | 19.6 | 11.9 | 41.1       | 17.0 | 8.6  |
| LOS by Move:              | D           | D    | D    | D           | D    | C    | D          | B    | B    | D          | B    | A    |
| HCM2k95thQ:               | 4           | 2    | 4    | 6           | 2    | 3    | 3          | 14   | 3    | 9          | 12   | 2    |

Note: Queue reported is the number of cars per lane.

BART

Level Of Service Computation Report  
 2000 HCM Operations (Future Volume Alternative)  
 AM - Bkgrd + Proj Conditions

Intersection #1204: MONROE/EL CAMINO REAL [Study Int 44]

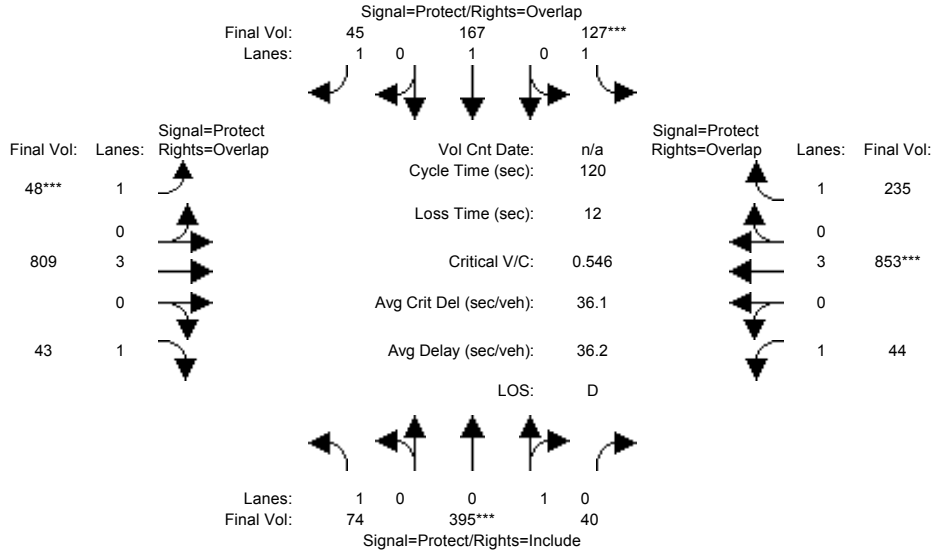

| Approach:                 | North Bound |      |      | South Bound |      |      | East Bound |      |      | West Bound |      |      |
|---------------------------|-------------|------|------|-------------|------|------|------------|------|------|------------|------|------|
| Movement:                 | L           | T    | R    | L           | T    | R    | L          | T    | R    | L          | T    | R    |
| Min. Green:               | 7           | 10   | 10   | 7           | 10   | 10   | 7          | 10   | 10   | 7          | 10   | 10   |
| Y+R:                      | 4.0         | 4.0  | 4.0  | 4.0         | 4.0  | 4.0  | 4.0        | 4.0  | 4.0  | 4.0        | 4.0  | 4.0  |
| Volume Module:            |             |      |      |             |      |      |            |      |      |            |      |      |
| Base Vol:                 | 74          | 395  | 40   | 127         | 167  | 45   | 48         | 809  | 43   | 44         | 853  | 235  |
| Growth Adj:               | 1.00        | 1.00 | 1.00 | 1.00        | 1.00 | 1.00 | 1.00       | 1.00 | 1.00 | 1.00       | 1.00 | 1.00 |
| Initial Bse:              | 74          | 395  | 40   | 127         | 167  | 45   | 48         | 809  | 43   | 44         | 853  | 235  |
| Added Vol:                | 0           | 0    | 0    | 0           | 0    | 0    | 0          | 0    | 0    | 0          | 0    | 0    |
| PasserByVol:              | 0           | 0    | 0    | 0           | 0    | 0    | 0          | 0    | 0    | 0          | 0    | 0    |
| Initial Fut:              | 74          | 395  | 40   | 127         | 167  | 45   | 48         | 809  | 43   | 44         | 853  | 235  |
| User Adj:                 | 1.00        | 1.00 | 1.00 | 1.00        | 1.00 | 1.00 | 1.00       | 1.00 | 1.00 | 1.00       | 1.00 | 1.00 |
| PHF Adj:                  | 1.00        | 1.00 | 1.00 | 1.00        | 1.00 | 1.00 | 1.00       | 1.00 | 1.00 | 1.00       | 1.00 | 1.00 |
| PHF Volume:               | 74          | 395  | 40   | 127         | 167  | 45   | 48         | 809  | 43   | 44         | 853  | 235  |
| Reduct Vol:               | 0           | 0    | 0    | 0           | 0    | 0    | 0          | 0    | 0    | 0          | 0    | 0    |
| Reduced Vol:              | 74          | 395  | 40   | 127         | 167  | 45   | 48         | 809  | 43   | 44         | 853  | 235  |
| PCE Adj:                  | 1.00        | 1.00 | 1.00 | 1.00        | 1.00 | 1.00 | 1.00       | 1.00 | 1.00 | 1.00       | 1.00 | 1.00 |
| MLF Adj:                  | 1.00        | 1.00 | 1.00 | 1.00        | 1.00 | 1.00 | 1.00       | 1.00 | 1.00 | 1.00       | 1.00 | 1.00 |
| Final Volume:             | 74          | 395  | 40   | 127         | 167  | 45   | 48         | 809  | 43   | 44         | 853  | 235  |
| Saturation Flow Module:   |             |      |      |             |      |      |            |      |      |            |      |      |
| Sat/Lane:                 | 1900        | 1900 | 1900 | 1900        | 1900 | 1900 | 1900       | 1900 | 1900 | 1900       | 1900 | 1900 |
| Adjustment:               | 0.92        | 0.95 | 0.95 | 0.92        | 1.00 | 0.92 | 0.92       | 1.00 | 0.92 | 0.92       | 1.00 | 0.92 |
| Lanes:                    | 1.00        | 0.91 | 0.09 | 1.00        | 1.00 | 1.00 | 1.00       | 3.00 | 1.00 | 1.00       | 3.00 | 1.00 |
| Final Sat.:               | 1750        | 1634 | 166  | 1750        | 1900 | 1750 | 1750       | 5700 | 1750 | 1750       | 5700 | 1750 |
| Capacity Analysis Module: |             |      |      |             |      |      |            |      |      |            |      |      |
| Vol/Sat:                  | 0.04        | 0.24 | 0.24 | 0.07        | 0.09 | 0.03 | 0.03       | 0.14 | 0.02 | 0.03       | 0.15 | 0.13 |
| Crit Moves:               | ****        | **** | **** | ****        | **** | **** | ****       | **** | **** | ****       | **** | **** |
| Green Time:               | 27.3        | 52.6 | 52.6 | 15.8        | 41.1 | 48.1 | 7.0        | 28.1 | 55.3 | 11.5       | 32.6 | 48.4 |
| Volume/Cap:               | 0.19        | 0.55 | 0.55 | 0.55        | 0.26 | 0.06 | 0.47       | 0.61 | 0.05 | 0.26       | 0.55 | 0.33 |
| Delay/Veh:                | 37.6        | 25.8 | 25.8 | 51.6        | 28.6 | 22.1 | 58.1       | 41.9 | 17.9 | 51.1       | 37.9 | 25.0 |
| User DelAdj:              | 1.00        | 1.00 | 1.00 | 1.00        | 1.00 | 1.00 | 1.00       | 1.00 | 1.00 | 1.00       | 1.00 | 1.00 |
| AdjDel/Veh:               | 37.6        | 25.8 | 25.8 | 51.6        | 28.6 | 22.1 | 58.1       | 41.9 | 17.9 | 51.1       | 37.9 | 25.0 |
| LOS by Move:              | D           | C    | C    | D           | C    | C    | E          | D    | B    | D          | D    | C    |
| HCM2k95thQ:               | 5           | 23   | 23   | 9           | 8    | 2    | 4          | 16   | 2    | 3          | 16   | 12   |

Note: Queue reported is the number of cars per lane.

BART

Level Of Service Computation Report  
 2000 HCM Operations (Future Volume Alternative)  
 PM - Bkgrd + Proj Conditions

Intersection #1204: MONROE/EL CAMINO REAL [Study Int 44]

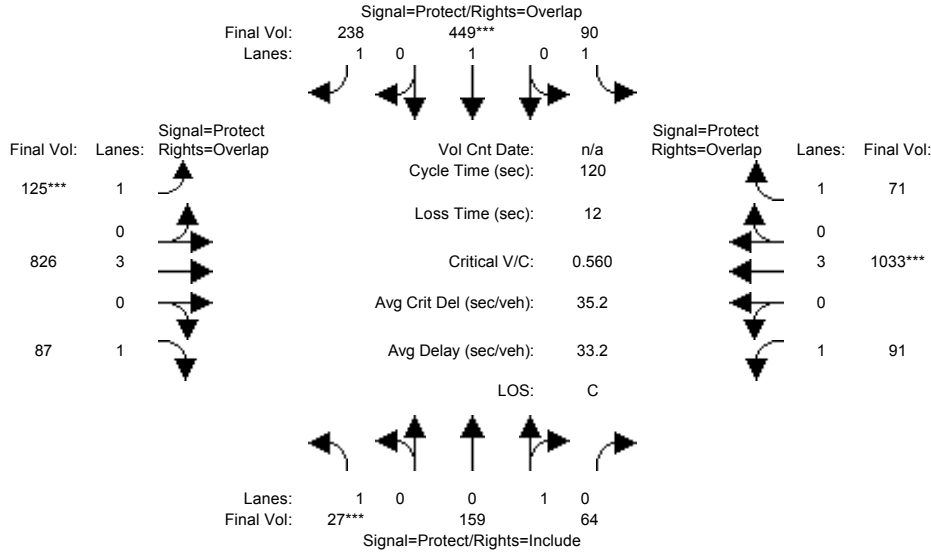

| Approach:                 | North Bound |      |      | South Bound |      |      | East Bound |      |      | West Bound |      |      |
|---------------------------|-------------|------|------|-------------|------|------|------------|------|------|------------|------|------|
| Movement:                 | L           | T    | R    | L           | T    | R    | L          | T    | R    | L          | T    | R    |
| Min. Green:               | 7           | 10   | 10   | 7           | 10   | 10   | 7          | 10   | 10   | 7          | 10   | 10   |
| Y+R:                      | 4.0         | 4.0  | 4.0  | 4.0         | 4.0  | 4.0  | 4.0        | 4.0  | 4.0  | 4.0        | 4.0  | 4.0  |
| Volume Module:            |             |      |      |             |      |      |            |      |      |            |      |      |
| Base Vol:                 | 27          | 159  | 64   | 90          | 449  | 238  | 125        | 826  | 87   | 91         | 1033 | 71   |
| Growth Adj:               | 1.00        | 1.00 | 1.00 | 1.00        | 1.00 | 1.00 | 1.00       | 1.00 | 1.00 | 1.00       | 1.00 | 1.00 |
| Initial Bse:              | 27          | 159  | 64   | 90          | 449  | 238  | 125        | 826  | 87   | 91         | 1033 | 71   |
| Added Vol:                | 0           | 0    | 0    | 0           | 0    | 0    | 0          | 0    | 0    | 0          | 0    | 0    |
| PasserByVol:              | 0           | 0    | 0    | 0           | 0    | 0    | 0          | 0    | 0    | 0          | 0    | 0    |
| Initial Fut:              | 27          | 159  | 64   | 90          | 449  | 238  | 125        | 826  | 87   | 91         | 1033 | 71   |
| User Adj:                 | 1.00        | 1.00 | 1.00 | 1.00        | 1.00 | 1.00 | 1.00       | 1.00 | 1.00 | 1.00       | 1.00 | 1.00 |
| PHF Adj:                  | 1.00        | 1.00 | 1.00 | 1.00        | 1.00 | 1.00 | 1.00       | 1.00 | 1.00 | 1.00       | 1.00 | 1.00 |
| PHF Volume:               | 27          | 159  | 64   | 90          | 449  | 238  | 125        | 826  | 87   | 91         | 1033 | 71   |
| Reduct Vol:               | 0           | 0    | 0    | 0           | 0    | 0    | 0          | 0    | 0    | 0          | 0    | 0    |
| Reduced Vol:              | 27          | 159  | 64   | 90          | 449  | 238  | 125        | 826  | 87   | 91         | 1033 | 71   |
| PCE Adj:                  | 1.00        | 1.00 | 1.00 | 1.00        | 1.00 | 1.00 | 1.00       | 1.00 | 1.00 | 1.00       | 1.00 | 1.00 |
| MLF Adj:                  | 1.00        | 1.00 | 1.00 | 1.00        | 1.00 | 1.00 | 1.00       | 1.00 | 1.00 | 1.00       | 1.00 | 1.00 |
| Final Volume:             | 27          | 159  | 64   | 90          | 449  | 238  | 125        | 826  | 87   | 91         | 1033 | 71   |
| Saturation Flow Module:   |             |      |      |             |      |      |            |      |      |            |      |      |
| Sat/Lane:                 | 1900        | 1900 | 1900 | 1900        | 1900 | 1900 | 1900       | 1900 | 1900 | 1900       | 1900 | 1900 |
| Adjustment:               | 0.92        | 0.95 | 0.95 | 0.92        | 1.00 | 0.92 | 0.92       | 1.00 | 0.92 | 0.92       | 1.00 | 0.92 |
| Lanes:                    | 1.00        | 0.71 | 0.29 | 1.00        | 1.00 | 1.00 | 1.00       | 3.00 | 1.00 | 1.00       | 3.00 | 1.00 |
| Final Sat.:               | 1750        | 1283 | 517  | 1750        | 1900 | 1750 | 1750       | 5700 | 1750 | 1750       | 5700 | 1750 |
| Capacity Analysis Module: |             |      |      |             |      |      |            |      |      |            |      |      |
| Vol/Sat:                  | 0.02        | 0.12 | 0.12 | 0.05        | 0.24 | 0.14 | 0.07       | 0.14 | 0.05 | 0.05       | 0.18 | 0.04 |
| Crit Moves:               | ****        |      |      | ****        |      |      | ****       |      |      | ****       |      |      |
| Green Time:               | 7.0         | 37.9 | 37.9 | 17.9        | 48.8 | 63.6 | 14.8       | 37.2 | 44.2 | 15.0       | 37.4 | 55.3 |
| Volume/Cap:               | 0.26        | 0.39 | 0.39 | 0.35        | 0.58 | 0.26 | 0.58       | 0.47 | 0.13 | 0.42       | 0.58 | 0.09 |
| Delay/Veh:                | 55.4        | 32.5 | 32.5 | 46.6        | 28.8 | 15.5 | 53.7       | 33.6 | 25.3 | 49.8       | 35.2 | 18.2 |
| User DelAdj:              | 1.00        | 1.00 | 1.00 | 1.00        | 1.00 | 1.00 | 1.00       | 1.00 | 1.00 | 1.00       | 1.00 | 1.00 |
| AdjDel/Veh:               | 55.4        | 32.5 | 32.5 | 46.6        | 28.8 | 15.5 | 53.7       | 33.6 | 25.3 | 49.8       | 35.2 | 18.2 |
| LOS by Move:              | E           | C    | C    | D           | C    | B    | D          | C    | C    | D          | D    | B    |
| HCM2k95thQ:               | 3           | 13   | 13   | 6           | 23   | 10   | 9          | 15   | 4    | 6          | 19   | 3    |

Note: Queue reported is the number of cars per lane.

BART

Level Of Service Computation Report  
 2000 HCM Operations (Future Volume Alternative)  
 AM - Bkgrd + Proj Conditions

Intersection #1205: SCOTT/EL CAMINO REAL [Study Int 42]

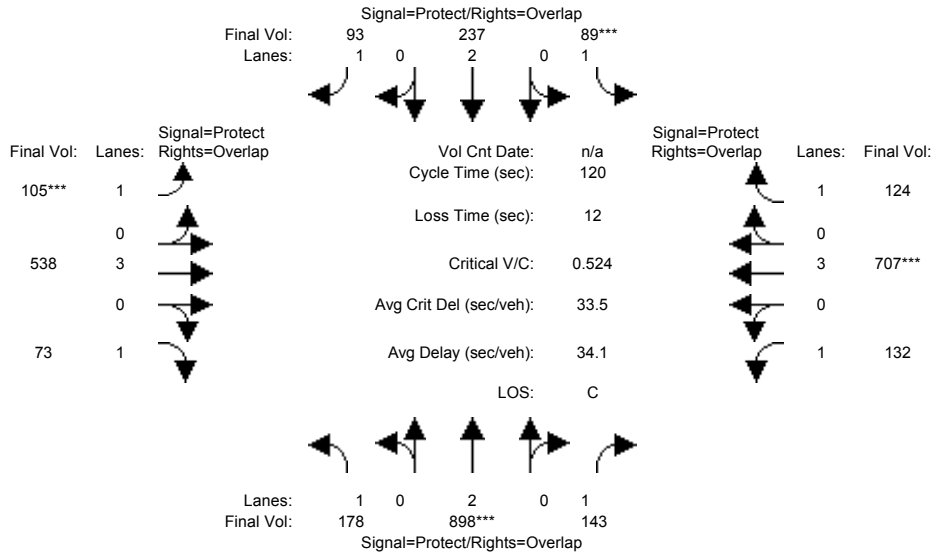

| Approach:                 | North Bound |      |      | South Bound |      |      | East Bound |      |      | West Bound |      |      |
|---------------------------|-------------|------|------|-------------|------|------|------------|------|------|------------|------|------|
| Movement:                 | L           | T    | R    | L           | T    | R    | L          | T    | R    | L          | T    | R    |
| Min. Green:               | 7           | 10   | 10   | 7           | 10   | 10   | 7          | 10   | 10   | 7          | 10   | 10   |
| Y+R:                      | 4.0         | 4.0  | 4.0  | 4.0         | 4.0  | 4.0  | 4.0        | 4.0  | 4.0  | 4.0        | 4.0  | 4.0  |
| Volume Module:            |             |      |      |             |      |      |            |      |      |            |      |      |
| Base Vol:                 | 178         | 898  | 143  | 89          | 237  | 93   | 105        | 538  | 73   | 132        | 707  | 124  |
| Growth Adj:               | 1.00        | 1.00 | 1.00 | 1.00        | 1.00 | 1.00 | 1.00       | 1.00 | 1.00 | 1.00       | 1.00 | 1.00 |
| Initial Bse:              | 178         | 898  | 143  | 89          | 237  | 93   | 105        | 538  | 73   | 132        | 707  | 124  |
| Added Vol:                | 0           | 0    | 0    | 0           | 0    | 0    | 0          | 0    | 0    | 0          | 0    | 0    |
| PasserByVol:              | 0           | 0    | 0    | 0           | 0    | 0    | 0          | 0    | 0    | 0          | 0    | 0    |
| Initial Fut:              | 178         | 898  | 143  | 89          | 237  | 93   | 105        | 538  | 73   | 132        | 707  | 124  |
| User Adj:                 | 1.00        | 1.00 | 1.00 | 1.00        | 1.00 | 1.00 | 1.00       | 1.00 | 1.00 | 1.00       | 1.00 | 1.00 |
| PHF Adj:                  | 1.00        | 1.00 | 1.00 | 1.00        | 1.00 | 1.00 | 1.00       | 1.00 | 1.00 | 1.00       | 1.00 | 1.00 |
| PHF Volume:               | 178         | 898  | 143  | 89          | 237  | 93   | 105        | 538  | 73   | 132        | 707  | 124  |
| Reduct Vol:               | 0           | 0    | 0    | 0           | 0    | 0    | 0          | 0    | 0    | 0          | 0    | 0    |
| Reduced Vol:              | 178         | 898  | 143  | 89          | 237  | 93   | 105        | 538  | 73   | 132        | 707  | 124  |
| PCE Adj:                  | 1.00        | 1.00 | 1.00 | 1.00        | 1.00 | 1.00 | 1.00       | 1.00 | 1.00 | 1.00       | 1.00 | 1.00 |
| MLF Adj:                  | 1.00        | 1.00 | 1.00 | 1.00        | 1.00 | 1.00 | 1.00       | 1.00 | 1.00 | 1.00       | 1.00 | 1.00 |
| Final Volume:             | 178         | 898  | 143  | 89          | 237  | 93   | 105        | 538  | 73   | 132        | 707  | 124  |
| Saturation Flow Module:   |             |      |      |             |      |      |            |      |      |            |      |      |
| Sat/Lane:                 | 1900        | 1900 | 1900 | 1900        | 1900 | 1900 | 1900       | 1900 | 1900 | 1900       | 1900 | 1900 |
| Adjustment:               | 0.92        | 1.00 | 0.92 | 0.92        | 1.00 | 0.92 | 0.92       | 1.00 | 0.92 | 0.92       | 1.00 | 0.92 |
| Lanes:                    | 1.00        | 2.00 | 1.00 | 1.00        | 2.00 | 1.00 | 1.00       | 3.00 | 1.00 | 1.00       | 3.00 | 1.00 |
| Final Sat.:               | 1750        | 3800 | 1750 | 1750        | 3800 | 1750 | 1750       | 5700 | 1750 | 1750       | 5700 | 1750 |
| Capacity Analysis Module: |             |      |      |             |      |      |            |      |      |            |      |      |
| Vol/Sat:                  | 0.10        | 0.24 | 0.08 | 0.05        | 0.06 | 0.05 | 0.06       | 0.09 | 0.04 | 0.08       | 0.12 | 0.07 |
| Crit Moves:               | ****        | **** | **** | ****        | **** | **** | ****       | **** | **** | ****       | **** | **** |
| Green Time:               | 36.2        | 54.2 | 72.9 | 11.7        | 29.6 | 43.4 | 13.8       | 23.4 | 59.6 | 18.7       | 28.4 | 40.1 |
| Volume/Cap:               | 0.34        | 0.52 | 0.13 | 0.52        | 0.25 | 0.15 | 0.52       | 0.48 | 0.08 | 0.48       | 0.52 | 0.21 |
| Delay/Veh:                | 33.0        | 23.9 | 10.1 | 54.5        | 36.4 | 25.9 | 52.6       | 43.2 | 15.9 | 47.6       | 40.3 | 28.8 |
| User DelAdj:              | 1.00        | 1.00 | 1.00 | 1.00        | 1.00 | 1.00 | 1.00       | 1.00 | 1.00 | 1.00       | 1.00 | 1.00 |
| AdjDel/Veh:               | 33.0        | 23.9 | 10.1 | 54.5        | 36.4 | 25.9 | 52.6       | 43.2 | 15.9 | 47.6       | 40.3 | 28.8 |
| LOS by Move:              | C           | C    | B    | D           | D    | C    | D          | D    | B    | D          | D    | C    |
| HCM2k95thQ:               | 10          | 21   | 5    | 7           | 7    | 5    | 8          | 11   | 3    | 9          | 14   | 7    |

Note: Queue reported is the number of cars per lane.

BART

Level Of Service Computation Report  
 2000 HCM Operations (Future Volume Alternative)  
 PM - Bkgrd + Proj Conditions

Intersection #1205: SCOTT/EL CAMINO REAL [Study Int 42]

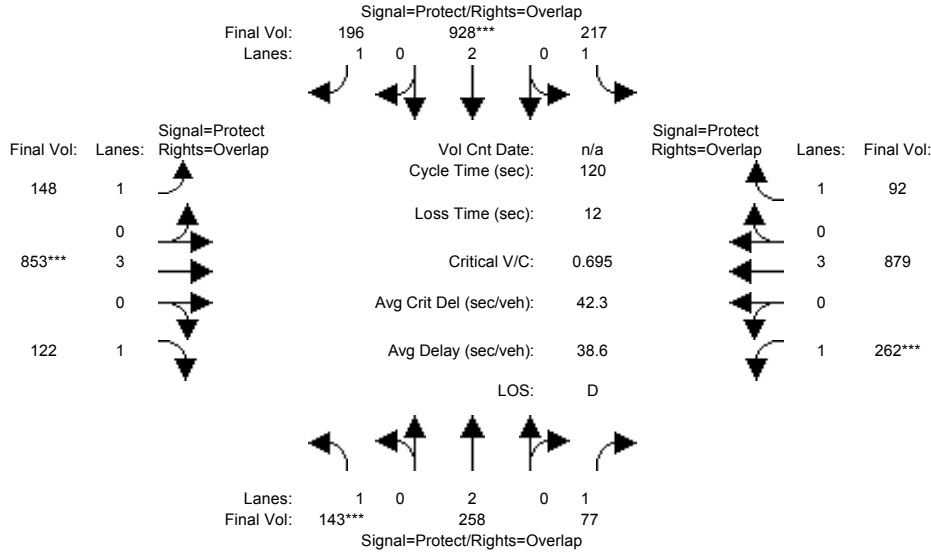

| Approach:                 | North Bound |      |      | South Bound |      |      | East Bound |      |      | West Bound |      |      |
|---------------------------|-------------|------|------|-------------|------|------|------------|------|------|------------|------|------|
| Movement:                 | L           | T    | R    | L           | T    | R    | L          | T    | R    | L          | T    | R    |
| Min. Green:               | 7           | 10   | 10   | 7           | 10   | 10   | 7          | 10   | 10   | 7          | 10   | 10   |
| Y+R:                      | 4.0         | 4.0  | 4.0  | 4.0         | 4.0  | 4.0  | 4.0        | 4.0  | 4.0  | 4.0        | 4.0  | 4.0  |
| Volume Module:            |             |      |      |             |      |      |            |      |      |            |      |      |
| Base Vol:                 | 143         | 258  | 77   | 217         | 928  | 196  | 148        | 853  | 122  | 262        | 879  | 92   |
| Growth Adj:               | 1.00        | 1.00 | 1.00 | 1.00        | 1.00 | 1.00 | 1.00       | 1.00 | 1.00 | 1.00       | 1.00 | 1.00 |
| Initial Bse:              | 143         | 258  | 77   | 217         | 928  | 196  | 148        | 853  | 122  | 262        | 879  | 92   |
| Added Vol:                | 0           | 0    | 0    | 0           | 0    | 0    | 0          | 0    | 0    | 0          | 0    | 0    |
| PasserByVol:              | 0           | 0    | 0    | 0           | 0    | 0    | 0          | 0    | 0    | 0          | 0    | 0    |
| Initial Fut:              | 143         | 258  | 77   | 217         | 928  | 196  | 148        | 853  | 122  | 262        | 879  | 92   |
| User Adj:                 | 1.00        | 1.00 | 1.00 | 1.00        | 1.00 | 1.00 | 1.00       | 1.00 | 1.00 | 1.00       | 1.00 | 1.00 |
| PHF Adj:                  | 1.00        | 1.00 | 1.00 | 1.00        | 1.00 | 1.00 | 1.00       | 1.00 | 1.00 | 1.00       | 1.00 | 1.00 |
| PHF Volume:               | 143         | 258  | 77   | 217         | 928  | 196  | 148        | 853  | 122  | 262        | 879  | 92   |
| Reduct Vol:               | 0           | 0    | 0    | 0           | 0    | 0    | 0          | 0    | 0    | 0          | 0    | 0    |
| Reduced Vol:              | 143         | 258  | 77   | 217         | 928  | 196  | 148        | 853  | 122  | 262        | 879  | 92   |
| PCE Adj:                  | 1.00        | 1.00 | 1.00 | 1.00        | 1.00 | 1.00 | 1.00       | 1.00 | 1.00 | 1.00       | 1.00 | 1.00 |
| MLF Adj:                  | 1.00        | 1.00 | 1.00 | 1.00        | 1.00 | 1.00 | 1.00       | 1.00 | 1.00 | 1.00       | 1.00 | 1.00 |
| Final Volume:             | 143         | 258  | 77   | 217         | 928  | 196  | 148        | 853  | 122  | 262        | 879  | 92   |
| Saturation Flow Module:   |             |      |      |             |      |      |            |      |      |            |      |      |
| Sat/Lane:                 | 1900        | 1900 | 1900 | 1900        | 1900 | 1900 | 1900       | 1900 | 1900 | 1900       | 1900 | 1900 |
| Adjustment:               | 0.92        | 1.00 | 0.92 | 0.92        | 1.00 | 0.92 | 0.92       | 1.00 | 0.92 | 0.92       | 1.00 | 0.92 |
| Lanes:                    | 1.00        | 2.00 | 1.00 | 1.00        | 2.00 | 1.00 | 1.00       | 3.00 | 1.00 | 1.00       | 3.00 | 1.00 |
| Final Sat.:               | 1750        | 3800 | 1750 | 1750        | 3800 | 1750 | 1750       | 5700 | 1750 | 1750       | 5700 | 1750 |
| Capacity Analysis Module: |             |      |      |             |      |      |            |      |      |            |      |      |
| Vol/Sat:                  | 0.08        | 0.07 | 0.04 | 0.12        | 0.24 | 0.11 | 0.08       | 0.15 | 0.07 | 0.15       | 0.15 | 0.05 |
| Crit Moves:               | ****        |      |      | ****        |      |      | ****       |      |      | ****       |      |      |
| Green Time:               | 14.1        | 22.6 | 48.5 | 33.7        | 42.2 | 60.5 | 18.3       | 25.8 | 40.0 | 25.9       | 33.4 | 67.1 |
| Volume/Cap:               | 0.69        | 0.36 | 0.11 | 0.44        | 0.69 | 0.22 | 0.55       | 0.69 | 0.21 | 0.69       | 0.55 | 0.09 |
| Delay/Veh:                | 60.7        | 42.7 | 22.4 | 36.1        | 35.0 | 16.7 | 49.6       | 45.2 | 28.9 | 49.0       | 37.4 | 12.4 |
| User DelAdj:              | 1.00        | 1.00 | 1.00 | 1.00        | 1.00 | 1.00 | 1.00       | 1.00 | 1.00 | 1.00       | 1.00 | 1.00 |
| AdjDel/Veh:               | 60.7        | 42.7 | 22.4 | 36.1        | 35.0 | 16.7 | 49.6       | 45.2 | 28.9 | 49.0       | 37.4 | 12.4 |
| LOS by Move:              | E           | D    | C    | D           | C    | B    | D          | D    | C    | D          | D    | B    |
| HCM2k95thQ:               | 11          | 8    | 4    | 13          | 26   | 8    | 11         | 18   | 7    | 18         | 17   | 3    |

Note: Queue reported is the number of cars per lane.

BART

Level Of Service Computation Report  
 2000 HCM Operations (Future Volume Alternative)  
 AM - Bkgrd + Proj Conditions

Intersection #1213: THE ALAMEDA/EL CAMINO REAL [Study Int 54]

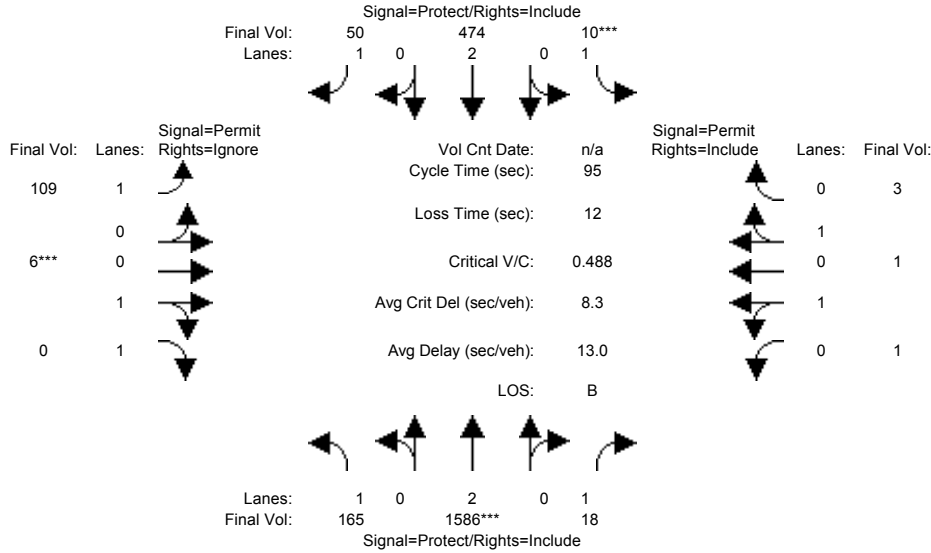

| Approach:                 | North Bound |      |      | South Bound |      |      | East Bound |      |      | West Bound |      |      |
|---------------------------|-------------|------|------|-------------|------|------|------------|------|------|------------|------|------|
| Movement:                 | L           | T    | R    | L           | T    | R    | L          | T    | R    | L          | T    | R    |
| Min. Green:               | 7           | 10   | 10   | 7           | 10   | 10   | 7          | 10   | 10   | 7          | 10   | 10   |
| Y+R:                      | 4.0         | 4.0  | 4.0  | 4.0         | 4.0  | 4.0  | 4.0        | 4.0  | 4.0  | 4.0        | 4.0  | 4.0  |
| Volume Module:            |             |      |      |             |      |      |            |      |      |            |      |      |
| Base Vol:                 | 165         | 1586 | 18   | 10          | 474  | 50   | 109        | 6    | 97   | 1          | 1    | 3    |
| Growth Adj:               | 1.00        | 1.00 | 1.00 | 1.00        | 1.00 | 1.00 | 1.00       | 1.00 | 1.00 | 1.00       | 1.00 | 1.00 |
| Initial Bse:              | 165         | 1586 | 18   | 10          | 474  | 50   | 109        | 6    | 97   | 1          | 1    | 3    |
| Added Vol:                | 0           | 0    | 0    | 0           | 0    | 0    | 0          | 0    | 0    | 0          | 0    | 0    |
| PasserByVol:              | 0           | 0    | 0    | 0           | 0    | 0    | 0          | 0    | 0    | 0          | 0    | 0    |
| Initial Fut:              | 165         | 1586 | 18   | 10          | 474  | 50   | 109        | 6    | 97   | 1          | 1    | 3    |
| User Adj:                 | 1.00        | 1.00 | 1.00 | 1.00        | 1.00 | 1.00 | 1.00       | 1.00 | 0.00 | 1.00       | 1.00 | 1.00 |
| PHF Adj:                  | 1.00        | 1.00 | 1.00 | 1.00        | 1.00 | 1.00 | 1.00       | 1.00 | 0.00 | 1.00       | 1.00 | 1.00 |
| PHF Volume:               | 165         | 1586 | 18   | 10          | 474  | 50   | 109        | 6    | 0    | 1          | 1    | 3    |
| Reduct Vol:               | 0           | 0    | 0    | 0           | 0    | 0    | 0          | 0    | 0    | 0          | 0    | 0    |
| Reduced Vol:              | 165         | 1586 | 18   | 10          | 474  | 50   | 109        | 6    | 0    | 1          | 1    | 3    |
| PCE Adj:                  | 1.00        | 1.00 | 1.00 | 1.00        | 1.00 | 1.00 | 1.00       | 1.00 | 0.00 | 1.00       | 1.00 | 1.00 |
| MLF Adj:                  | 1.00        | 1.00 | 1.00 | 1.00        | 1.00 | 1.00 | 1.00       | 1.00 | 0.00 | 1.00       | 1.00 | 1.00 |
| FinalVolume:              | 165         | 1586 | 18   | 10          | 474  | 50   | 109        | 6    | 0    | 1          | 1    | 3    |
| Saturation Flow Module:   |             |      |      |             |      |      |            |      |      |            |      |      |
| Sat/Lane:                 | 1900        | 1900 | 1900 | 1900        | 1900 | 1900 | 1900       | 1900 | 1900 | 1900       | 1900 | 1900 |
| Adjustment:               | 0.92        | 1.00 | 0.92 | 0.92        | 1.00 | 0.92 | 0.92       | 0.95 | 0.92 | 0.95       | 0.95 | 0.95 |
| Lanes:                    | 1.00        | 2.00 | 1.00 | 1.00        | 2.00 | 1.00 | 1.00       | 1.00 | 1.00 | 0.50       | 0.50 | 1.00 |
| Final Sat.:               | 1750        | 3800 | 1750 | 1750        | 3800 | 1750 | 1750       | 1800 | 1750 | 900        | 900  | 1800 |
| Capacity Analysis Module: |             |      |      |             |      |      |            |      |      |            |      |      |
| Vol/Sat:                  | 0.09        | 0.42 | 0.01 | 0.01        | 0.12 | 0.03 | 0.06       | 0.00 | 0.00 | 0.00       | 0.00 | 0.00 |
| Crit Moves:               | ****        | **** | **** | ****        | **** | **** | ****       | **** | **** | ****       | **** | **** |
| Green Time:               | 31.4        | 66.0 | 66.0 | 7.0         | 41.6 | 41.6 | 10.0       | 10.0 | 0.0  | 10.0       | 10.0 | 10.0 |
| Volume/Cap:               | 0.29        | 0.60 | 0.01 | 0.08        | 0.29 | 0.07 | 0.59       | 0.03 | 0.00 | 0.01       | 0.01 | 0.02 |
| Delay/Veh:                | 23.8        | 8.0  | 4.5  | 41.3        | 17.3 | 15.5 | 45.6       | 38.2 | 0.0  | 38.1       | 38.1 | 38.1 |
| User DelAdj:              | 1.00        | 1.00 | 1.00 | 1.00        | 1.00 | 1.00 | 1.00       | 1.00 | 1.00 | 1.00       | 1.00 | 1.00 |
| AdjDel/Veh:               | 23.8        | 8.0  | 4.5  | 41.3        | 17.3 | 15.5 | 45.6       | 38.2 | 0.0  | 38.1       | 38.1 | 38.1 |
| LOS by Move:              | C           | A    | A    | D           | B    | B    | D          | D    | A    | D          | D    | D    |
| HCM2k95thQ:               | 7           | 22   | 0    | 1           | 9    | 2    | 8          | 0    | 0    | 0          | 0    | 0    |

Note: Queue reported is the number of cars per lane.



BART

Level Of Service Computation Report  
 2000 HCM Operations (Future Volume Alternative)  
 PM - Bkgrd + Proj Conditions

Intersection #1213: THE ALAMEDA/EL CAMINO REAL [Study Int 54]

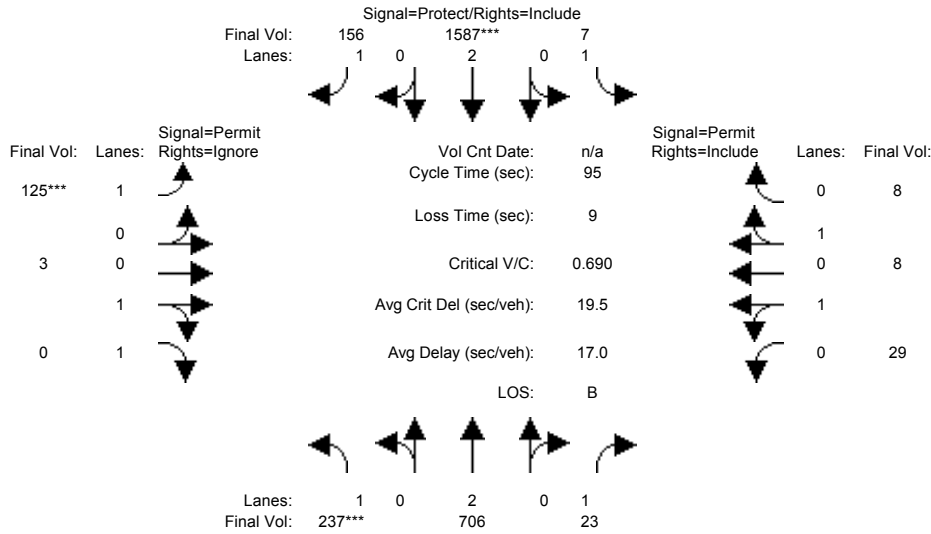

| Approach:                 | North Bound |      |      | South Bound |      |      | East Bound |      |      | West Bound |      |      |
|---------------------------|-------------|------|------|-------------|------|------|------------|------|------|------------|------|------|
| Movement:                 | L           | T    | R    | L           | T    | R    | L          | T    | R    | L          | T    | R    |
| Min. Green:               | 7           | 10   | 10   | 7           | 10   | 10   | 10         | 10   | 10   | 10         | 10   | 10   |
| Y+R:                      | 4.0         | 4.0  | 4.0  | 4.0         | 4.0  | 4.0  | 4.0        | 4.0  | 4.0  | 4.0        | 4.0  | 4.0  |
| Volume Module:            |             |      |      |             |      |      |            |      |      |            |      |      |
| Base Vol:                 | 237         | 706  | 23   | 7           | 1587 | 156  | 125        | 3    | 272  | 29         | 8    | 8    |
| Growth Adj:               | 1.00        | 1.00 | 1.00 | 1.00        | 1.00 | 1.00 | 1.00       | 1.00 | 1.00 | 1.00       | 1.00 | 1.00 |
| Initial Bse:              | 237         | 706  | 23   | 7           | 1587 | 156  | 125        | 3    | 272  | 29         | 8    | 8    |
| Added Vol:                | 0           | 0    | 0    | 0           | 0    | 0    | 0          | 0    | 0    | 0          | 0    | 0    |
| PasserByVol:              | 0           | 0    | 0    | 0           | 0    | 0    | 0          | 0    | 0    | 0          | 0    | 0    |
| Initial Fut:              | 237         | 706  | 23   | 7           | 1587 | 156  | 125        | 3    | 272  | 29         | 8    | 8    |
| User Adj:                 | 1.00        | 1.00 | 1.00 | 1.00        | 1.00 | 1.00 | 1.00       | 1.00 | 0.00 | 1.00       | 1.00 | 1.00 |
| PHF Adj:                  | 1.00        | 1.00 | 1.00 | 1.00        | 1.00 | 1.00 | 1.00       | 1.00 | 0.00 | 1.00       | 1.00 | 1.00 |
| PHF Volume:               | 237         | 706  | 23   | 7           | 1587 | 156  | 125        | 3    | 0    | 29         | 8    | 8    |
| Reduct Vol:               | 0           | 0    | 0    | 0           | 0    | 0    | 0          | 0    | 0    | 0          | 0    | 0    |
| Reduced Vol:              | 237         | 706  | 23   | 7           | 1587 | 156  | 125        | 3    | 0    | 29         | 8    | 8    |
| PCE Adj:                  | 1.00        | 1.00 | 1.00 | 1.00        | 1.00 | 1.00 | 1.00       | 1.00 | 0.00 | 1.00       | 1.00 | 1.00 |
| MLF Adj:                  | 1.00        | 1.00 | 1.00 | 1.00        | 1.00 | 1.00 | 1.00       | 1.00 | 0.00 | 1.00       | 1.00 | 1.00 |
| Final Volume:             | 237         | 706  | 23   | 7           | 1587 | 156  | 125        | 3    | 0    | 29         | 8    | 8    |
| Saturation Flow Module:   |             |      |      |             |      |      |            |      |      |            |      |      |
| Sat/Lane:                 | 1900        | 1900 | 1900 | 1900        | 1900 | 1900 | 1900       | 1900 | 1900 | 1900       | 1900 | 1900 |
| Adjustment:               | 0.92        | 1.00 | 0.92 | 0.92        | 1.00 | 0.92 | 0.92       | 0.95 | 0.92 | 0.95       | 0.95 | 0.95 |
| Lanes:                    | 1.00        | 2.00 | 1.00 | 1.00        | 2.00 | 1.00 | 1.00       | 1.00 | 1.00 | 1.00       | 0.50 | 0.50 |
| Final Sat.:               | 1750        | 3800 | 1750 | 1750        | 3800 | 1750 | 1750       | 1800 | 1750 | 1800       | 900  | 900  |
| Capacity Analysis Module: |             |      |      |             |      |      |            |      |      |            |      |      |
| Vol/Sat:                  | 0.14        | 0.19 | 0.01 | 0.00        | 0.42 | 0.09 | 0.07       | 0.00 | 0.00 | 0.02       | 0.01 | 0.01 |
| Crit Moves:               | ****        |      |      | ****        |      |      | ****       |      |      |            |      |      |
| Green Time:               | 18.6        | 54.4 | 54.4 | 21.6        | 57.4 | 57.4 | 10.0       | 10.0 | 0.0  | 10.0       | 10.0 | 10.0 |
| Volume/Cap:               | 0.69        | 0.32 | 0.02 | 0.02        | 0.69 | 0.15 | 0.68       | 0.02 | 0.00 | 0.15       | 0.08 | 0.08 |
| Delay/Veh:                | 41.5        | 10.7 | 8.8  | 28.5        | 13.7 | 8.2  | 50.7       | 38.1 | 0.0  | 38.9       | 38.4 | 38.4 |
| User DelAdj:              | 1.00        | 1.00 | 1.00 | 1.00        | 1.00 | 1.00 | 1.00       | 1.00 | 1.00 | 1.00       | 1.00 | 1.00 |
| AdjDel/Veh:               | 41.5        | 10.7 | 8.8  | 28.5        | 13.7 | 8.2  | 50.7       | 38.1 | 0.0  | 38.9       | 38.4 | 38.4 |
| LOS by Move:              | D           | B    | A    | C           | B    | A    | D          | D    | A    | D          | D    | D    |
| HCM2k95thQ:               | 13          | 10   | 1    | 0           | 29   | 4    | 10         | 0    | 0    | 2          | 1    | 1    |

Note: Queue reported is the number of cars per lane.

BART

Level Of Service Computation Report  
 2000 HCM Operations (Future Volume Alternative)  
 AM - Bkgrd + Proj Conditions

Intersection #1214: THE ALAMEDA/NEWHALL [Study Int 55]

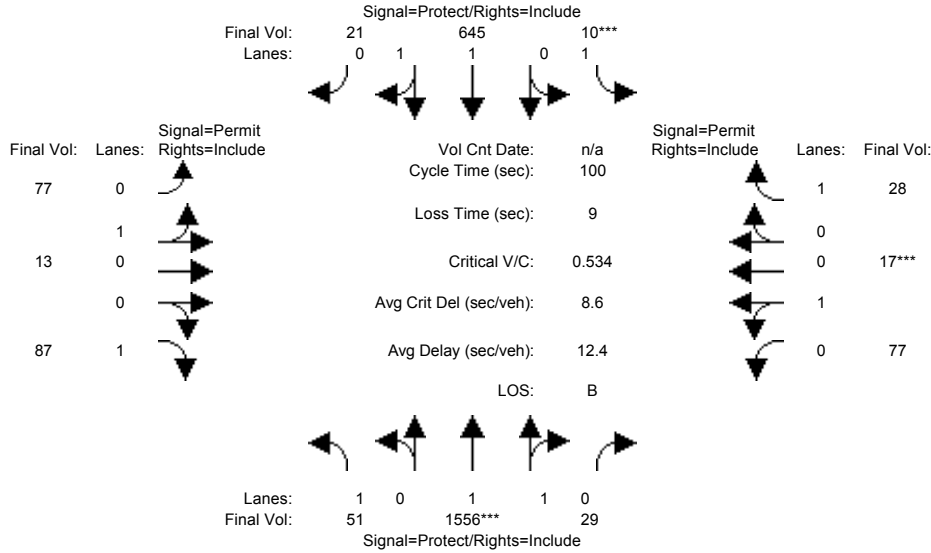

| Approach:                 | North Bound |      |      | South Bound |      |      | East Bound |      |      | West Bound |      |      |
|---------------------------|-------------|------|------|-------------|------|------|------------|------|------|------------|------|------|
| Movement:                 | L           | T    | R    | L           | T    | R    | L          | T    | R    | L          | T    | R    |
| Min. Green:               | 7           | 10   | 10   | 7           | 10   | 10   | 7          | 10   | 10   | 7          | 10   | 10   |
| Y+R:                      | 4.0         | 4.0  | 4.0  | 4.0         | 4.0  | 4.0  | 4.0        | 4.0  | 4.0  | 4.0        | 4.0  | 4.0  |
| Volume Module:            |             |      |      |             |      |      |            |      |      |            |      |      |
| Base Vol:                 | 51          | 1556 | 29   | 10          | 645  | 21   | 77         | 13   | 87   | 77         | 17   | 28   |
| Growth Adj:               | 1.00        | 1.00 | 1.00 | 1.00        | 1.00 | 1.00 | 1.00       | 1.00 | 1.00 | 1.00       | 1.00 | 1.00 |
| Initial Bse:              | 51          | 1556 | 29   | 10          | 645  | 21   | 77         | 13   | 87   | 77         | 17   | 28   |
| Added Vol:                | 0           | 0    | 0    | 0           | 0    | 0    | 0          | 0    | 0    | 0          | 0    | 0    |
| PasserByVol:              | 0           | 0    | 0    | 0           | 0    | 0    | 0          | 0    | 0    | 0          | 0    | 0    |
| Initial Fut:              | 51          | 1556 | 29   | 10          | 645  | 21   | 77         | 13   | 87   | 77         | 17   | 28   |
| User Adj:                 | 1.00        | 1.00 | 1.00 | 1.00        | 1.00 | 1.00 | 1.00       | 1.00 | 1.00 | 1.00       | 1.00 | 1.00 |
| PHF Adj:                  | 1.00        | 1.00 | 1.00 | 1.00        | 1.00 | 1.00 | 1.00       | 1.00 | 1.00 | 1.00       | 1.00 | 1.00 |
| PHF Volume:               | 51          | 1556 | 29   | 10          | 645  | 21   | 77         | 13   | 87   | 77         | 17   | 28   |
| Reduct Vol:               | 0           | 0    | 0    | 0           | 0    | 0    | 0          | 0    | 0    | 0          | 0    | 0    |
| Reduced Vol:              | 51          | 1556 | 29   | 10          | 645  | 21   | 77         | 13   | 87   | 77         | 17   | 28   |
| PCE Adj:                  | 1.00        | 1.00 | 1.00 | 1.00        | 1.00 | 1.00 | 1.00       | 1.00 | 1.00 | 1.00       | 1.00 | 1.00 |
| MLF Adj:                  | 1.00        | 1.00 | 1.00 | 1.00        | 1.00 | 1.00 | 1.00       | 1.00 | 1.00 | 1.00       | 1.00 | 1.00 |
| FinalVolume:              | 51          | 1556 | 29   | 10          | 645  | 21   | 77         | 13   | 87   | 77         | 17   | 28   |
| Saturation Flow Module:   |             |      |      |             |      |      |            |      |      |            |      |      |
| Sat/Lane:                 | 1900        | 1900 | 1900 | 1900        | 1900 | 1900 | 1900       | 1900 | 1900 | 1900       | 1900 | 1900 |
| Adjustment:               | 0.92        | 0.97 | 0.95 | 0.92        | 0.97 | 0.95 | 0.95       | 0.95 | 0.92 | 0.95       | 0.95 | 0.92 |
| Lanes:                    | 1.00        | 1.96 | 0.04 | 1.00        | 1.94 | 0.06 | 0.86       | 0.14 | 1.00 | 0.82       | 0.18 | 1.00 |
| Final Sat.:               | 1750        | 3632 | 68   | 1750        | 3583 | 117  | 1540       | 260  | 1750 | 1474       | 326  | 1750 |
| Capacity Analysis Module: |             |      |      |             |      |      |            |      |      |            |      |      |
| Vol/Sat:                  | 0.03        | 0.43 | 0.43 | 0.01        | 0.18 | 0.18 | 0.05       | 0.05 | 0.05 | 0.05       | 0.05 | 0.02 |
| Crit Moves:               | ****        | **** | **** | ****        | **** | **** | ****       | **** | **** | ****       | **** | **** |
| Green Time:               | 22.7        | 74.0 | 74.0 | 7.0         | 58.3 | 58.3 | 10.0       | 10.0 | 10.0 | 10.0       | 10.0 | 10.0 |
| Volume/Cap:               | 0.13        | 0.58 | 0.58 | 0.08        | 0.31 | 0.31 | 0.50       | 0.50 | 0.50 | 0.52       | 0.52 | 0.16 |
| Delay/Veh:                | 30.9        | 6.2  | 6.2  | 43.8        | 10.7 | 10.7 | 44.8       | 44.8 | 44.8 | 45.5       | 45.5 | 41.6 |
| User DelAdj:              | 1.00        | 1.00 | 1.00 | 1.00        | 1.00 | 1.00 | 1.00       | 1.00 | 1.00 | 1.00       | 1.00 | 1.00 |
| AdjDel/Veh:               | 30.9        | 6.2  | 6.2  | 43.8        | 10.7 | 10.7 | 44.8       | 44.8 | 44.8 | 45.5       | 45.5 | 41.6 |
| LOS by Move:              | C           | A    | A    | D           | B    | B    | D          | D    | D    | D          | D    | D    |
| HCM2k95thQ:               | 3           | 20   | 20   | 1           | 10   | 10   | 6          | 6    | 6    | 7          | 7    | 2    |

Note: Queue reported is the number of cars per lane.

BART

Level Of Service Computation Report  
 2000 HCM Operations (Future Volume Alternative)  
 PM - Bkgrd + Proj Conditions

Intersection #1214: THE ALAMEDA/NEWHALL [Study Int 55]

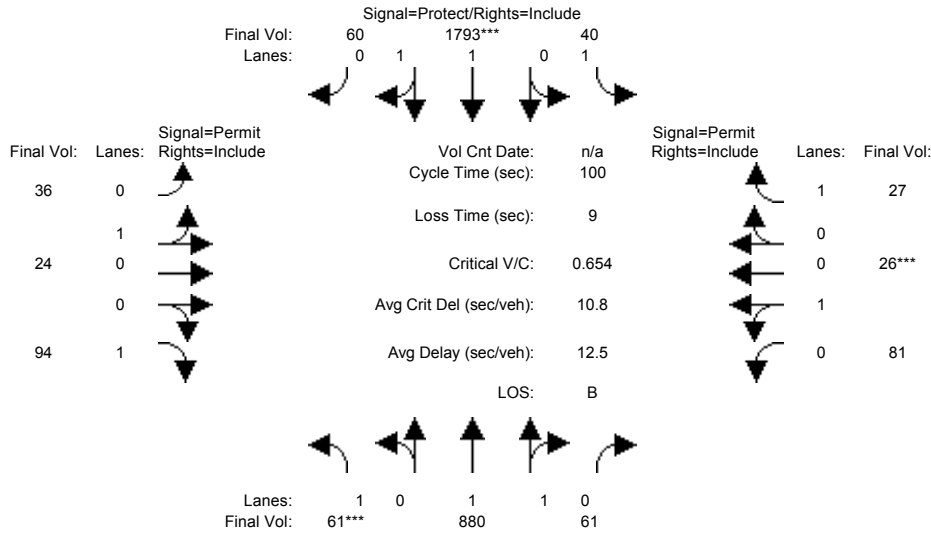

| Approach:                 | North Bound |      |      | South Bound |      |      | East Bound |      |      | West Bound |      |      |
|---------------------------|-------------|------|------|-------------|------|------|------------|------|------|------------|------|------|
| Movement:                 | L           | T    | R    | L           | T    | R    | L          | T    | R    | L          | T    | R    |
| Min. Green:               | 7           | 10   | 10   | 7           | 10   | 10   | 7          | 10   | 10   | 7          | 10   | 10   |
| Y+R:                      | 4.0         | 4.0  | 4.0  | 4.0         | 4.0  | 4.0  | 4.0        | 4.0  | 4.0  | 4.0        | 4.0  | 4.0  |
| Volume Module:            |             |      |      |             |      |      |            |      |      |            |      |      |
| Base Vol:                 | 61          | 880  | 61   | 40          | 1793 | 60   | 36         | 24   | 94   | 81         | 26   | 27   |
| Growth Adj:               | 1.00        | 1.00 | 1.00 | 1.00        | 1.00 | 1.00 | 1.00       | 1.00 | 1.00 | 1.00       | 1.00 | 1.00 |
| Initial Bse:              | 61          | 880  | 61   | 40          | 1793 | 60   | 36         | 24   | 94   | 81         | 26   | 27   |
| Added Vol:                | 0           | 0    | 0    | 0           | 0    | 0    | 0          | 0    | 0    | 0          | 0    | 0    |
| PasserByVol:              | 0           | 0    | 0    | 0           | 0    | 0    | 0          | 0    | 0    | 0          | 0    | 0    |
| Initial Fut:              | 61          | 880  | 61   | 40          | 1793 | 60   | 36         | 24   | 94   | 81         | 26   | 27   |
| User Adj:                 | 1.00        | 1.00 | 1.00 | 1.00        | 1.00 | 1.00 | 1.00       | 1.00 | 1.00 | 1.00       | 1.00 | 1.00 |
| PHF Adj:                  | 1.00        | 1.00 | 1.00 | 1.00        | 1.00 | 1.00 | 1.00       | 1.00 | 1.00 | 1.00       | 1.00 | 1.00 |
| PHF Volume:               | 61          | 880  | 61   | 40          | 1793 | 60   | 36         | 24   | 94   | 81         | 26   | 27   |
| Reduct Vol:               | 0           | 0    | 0    | 0           | 0    | 0    | 0          | 0    | 0    | 0          | 0    | 0    |
| Reduced Vol:              | 61          | 880  | 61   | 40          | 1793 | 60   | 36         | 24   | 94   | 81         | 26   | 27   |
| PCE Adj:                  | 1.00        | 1.00 | 1.00 | 1.00        | 1.00 | 1.00 | 1.00       | 1.00 | 1.00 | 1.00       | 1.00 | 1.00 |
| MLF Adj:                  | 1.00        | 1.00 | 1.00 | 1.00        | 1.00 | 1.00 | 1.00       | 1.00 | 1.00 | 1.00       | 1.00 | 1.00 |
| FinalVolume:              | 61          | 880  | 61   | 40          | 1793 | 60   | 36         | 24   | 94   | 81         | 26   | 27   |
| Saturation Flow Module:   |             |      |      |             |      |      |            |      |      |            |      |      |
| Sat/Lane:                 | 1900        | 1900 | 1900 | 1900        | 1900 | 1900 | 1900       | 1900 | 1900 | 1900       | 1900 | 1900 |
| Adjustment:               | 0.92        | 0.98 | 0.95 | 0.92        | 0.97 | 0.95 | 0.95       | 0.95 | 0.92 | 0.95       | 0.95 | 0.92 |
| Lanes:                    | 1.00        | 1.87 | 0.13 | 1.00        | 1.93 | 0.07 | 0.60       | 0.40 | 1.00 | 0.76       | 0.24 | 1.00 |
| Final Sat.:               | 1750        | 3460 | 240  | 1750        | 3580 | 120  | 1080       | 720  | 1750 | 1363       | 437  | 1750 |
| Capacity Analysis Module: |             |      |      |             |      |      |            |      |      |            |      |      |
| Vol/Sat:                  | 0.03        | 0.25 | 0.25 | 0.02        | 0.50 | 0.50 | 0.03       | 0.03 | 0.05 | 0.06       | 0.06 | 0.02 |
| Crit Moves:               | ****        |      |      | ****        |      |      |            |      |      | ****       |      |      |
| Green Time:               | 7.0         | 63.5 | 63.5 | 17.5        | 74.0 | 74.0 | 10.0       | 10.0 | 10.0 | 10.0       | 10.0 | 10.0 |
| Volume/Cap:               | 0.50        | 0.40 | 0.40 | 0.13        | 0.68 | 0.68 | 0.33       | 0.33 | 0.54 | 0.59       | 0.59 | 0.15 |
| Delay/Veh:                | 48.0        | 9.0  | 9.0  | 35.0        | 7.5  | 7.5  | 43.0       | 43.0 | 46.1 | 48.3       | 48.3 | 41.5 |
| User DelAdj:              | 1.00        | 1.00 | 1.00 | 1.00        | 1.00 | 1.00 | 1.00       | 1.00 | 1.00 | 1.00       | 1.00 | 1.00 |
| AdjDel/Veh:               | 48.0        | 9.0  | 9.0  | 35.0        | 7.5  | 7.5  | 43.0       | 43.0 | 46.1 | 48.3       | 48.3 | 41.5 |
| LOS by Move:              | D           | A    | A    | D           | A    | A    | D          | D    | D    | D          | D    | D    |
| HCM2k95thQ:               | 4           | 14   | 14   | 2           | 26   | 26   | 4          | 4    | 6    | 8          | 8    | 2    |

Note: Queue reported is the number of cars per lane.

BART

Level Of Service Computation Report  
 2000 HCM Operations (Future Volume Alternative)  
 AM - Bkgrd + Proj Conditions

Intersection #3016: 101/ALUM ROCK [Study Int 15]

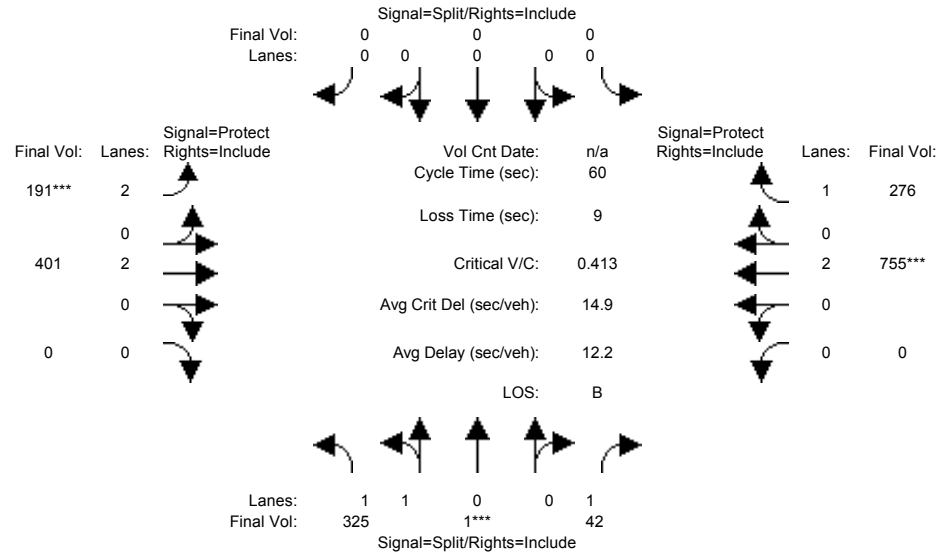

| Approach:                 | North Bound |      |      | South Bound |      |      | East Bound |      |      | West Bound |      |      |
|---------------------------|-------------|------|------|-------------|------|------|------------|------|------|------------|------|------|
| Movement:                 | L           | T    | R    | L           | T    | R    | L          | T    | R    | L          | T    | R    |
| Min. Green:               | 10          | 10   | 10   | 0           | 0    | 0    | 7          | 10   | 0    | 0          | 10   | 10   |
| Y+R:                      | 4.0         | 4.0  | 4.0  | 4.0         | 4.0  | 4.0  | 4.0        | 4.0  | 4.0  | 4.0        | 4.0  | 4.0  |
| Volume Module:            |             |      |      |             |      |      |            |      |      |            |      |      |
| Base Vol:                 | 325         | 1    | 42   | 0           | 0    | 0    | 191        | 401  | 0    | 0          | 755  | 276  |
| Growth Adj:               | 1.00        | 1.00 | 1.00 | 1.00        | 1.00 | 1.00 | 1.00       | 1.00 | 1.00 | 1.00       | 1.00 | 1.00 |
| Initial Bse:              | 325         | 1    | 42   | 0           | 0    | 0    | 191        | 401  | 0    | 0          | 755  | 276  |
| Added Vol:                | 0           | 0    | 0    | 0           | 0    | 0    | 0          | 0    | 0    | 0          | 0    | 0    |
| PasserByVol:              | 0           | 0    | 0    | 0           | 0    | 0    | 0          | 0    | 0    | 0          | 0    | 0    |
| Initial Fut:              | 325         | 1    | 42   | 0           | 0    | 0    | 191        | 401  | 0    | 0          | 755  | 276  |
| User Adj:                 | 1.00        | 1.00 | 1.00 | 1.00        | 1.00 | 1.00 | 1.00       | 1.00 | 1.00 | 1.00       | 1.00 | 1.00 |
| PHF Adj:                  | 1.00        | 1.00 | 1.00 | 1.00        | 1.00 | 1.00 | 1.00       | 1.00 | 1.00 | 1.00       | 1.00 | 1.00 |
| PHF Volume:               | 325         | 1    | 42   | 0           | 0    | 0    | 191        | 401  | 0    | 0          | 755  | 276  |
| Reduct Vol:               | 0           | 0    | 0    | 0           | 0    | 0    | 0          | 0    | 0    | 0          | 0    | 0    |
| Reduced Vol:              | 325         | 1    | 42   | 0           | 0    | 0    | 191        | 401  | 0    | 0          | 755  | 276  |
| PCE Adj:                  | 1.00        | 1.00 | 1.00 | 1.00        | 1.00 | 1.00 | 1.00       | 1.00 | 1.00 | 1.00       | 1.00 | 1.00 |
| MLF Adj:                  | 1.00        | 1.00 | 1.00 | 1.00        | 1.00 | 1.00 | 1.00       | 1.00 | 1.00 | 1.00       | 1.00 | 1.00 |
| FinalVolume:              | 325         | 1    | 42   | 0           | 0    | 0    | 191        | 401  | 0    | 0          | 755  | 276  |
| Saturation Flow Module:   |             |      |      |             |      |      |            |      |      |            |      |      |
| Sat/Lane:                 | 1900        | 1900 | 1900 | 1900        | 1900 | 1900 | 1900       | 1900 | 1900 | 1900       | 1900 | 1900 |
| Adjustment:               | 0.93        | 0.95 | 0.92 | 0.92        | 1.00 | 0.92 | 0.83       | 1.00 | 0.92 | 0.92       | 1.00 | 0.92 |
| Lanes:                    | 1.99        | 0.01 | 1.00 | 0.00        | 0.00 | 0.00 | 2.00       | 2.00 | 0.00 | 0.00       | 2.00 | 1.00 |
| Final Sat.:               | 3539        | 11   | 1750 | 0           | 0    | 0    | 3150       | 3800 | 0    | 0          | 3800 | 1750 |
| Capacity Analysis Module: |             |      |      |             |      |      |            |      |      |            |      |      |
| Vol/Sat:                  | 0.09        | 0.09 | 0.02 | 0.00        | 0.00 | 0.00 | 0.06       | 0.11 | 0.00 | 0.00       | 0.20 | 0.16 |
| Crit Moves:               | ****        |      |      |             |      |      | ****       |      |      | ****       |      |      |
| Green Time:               | 13.3        | 13.3 | 13.3 | 0.0         | 0.0  | 0.0  | 8.8        | 37.7 | 0.0  | 0.0        | 28.9 | 28.9 |
| Volume/Cap:               | 0.41        | 0.41 | 0.11 | 0.00        | 0.00 | 0.00 | 0.41       | 0.17 | 0.00 | 0.00       | 0.41 | 0.33 |
| Delay/Veh:                | 20.3        | 20.3 | 18.7 | 0.0         | 0.0  | 0.0  | 23.9       | 4.7  | 0.0  | 0.0        | 10.2 | 9.8  |
| User DelAdj:              | 1.00        | 1.00 | 1.00 | 1.00        | 1.00 | 1.00 | 1.00       | 1.00 | 1.00 | 1.00       | 1.00 | 1.00 |
| AdjDel/Veh:               | 20.3        | 20.3 | 18.7 | 0.0         | 0.0  | 0.0  | 23.9       | 4.7  | 0.0  | 0.0        | 10.2 | 9.8  |
| LOS by Move:              | C           | C    | B    | A           | A    | A    | C          | A    | A    | A          | B    | A    |
| HCM2k95thQ:               | 6           | 6    | 2    | 0           | 0    | 0    | 4          | 3    | 0    | 0          | 9    | 7    |

Note: Queue reported is the number of cars per lane.

BART

Level Of Service Computation Report  
 2000 HCM Operations (Future Volume Alternative)  
 PM - Bkgrd + Proj Conditions

Intersection #3016: 101/ALUM ROCK [Study Int 15]

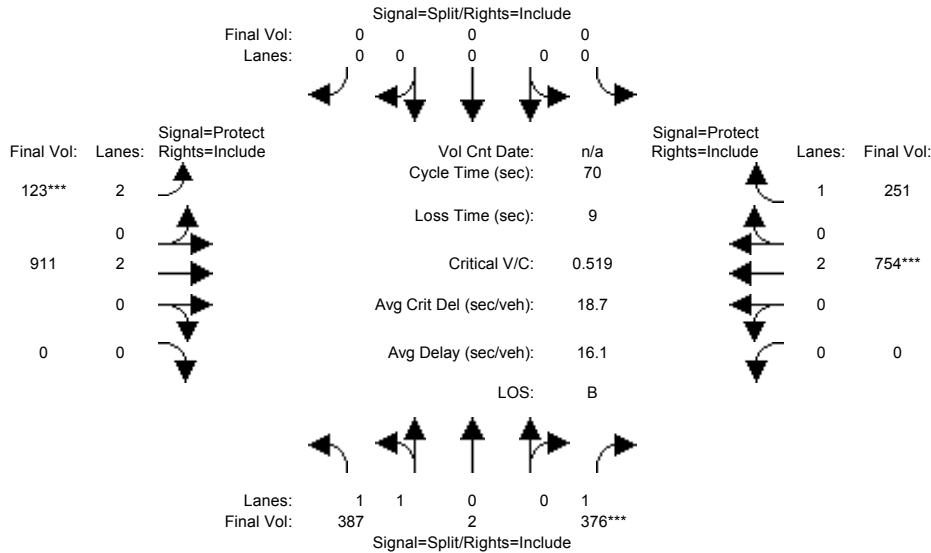

| Approach:                 | North Bound |      |      | South Bound |      |      | East Bound |      |      | West Bound |      |      |
|---------------------------|-------------|------|------|-------------|------|------|------------|------|------|------------|------|------|
| Movement:                 | L           | T    | R    | L           | T    | R    | L          | T    | R    | L          | T    | R    |
| Min. Green:               | 10          | 10   | 10   | 0           | 0    | 0    | 7          | 10   | 0    | 0          | 10   | 10   |
| Y+R:                      | 4.0         | 4.0  | 4.0  | 4.0         | 4.0  | 4.0  | 4.0        | 4.0  | 4.0  | 4.0        | 4.0  | 4.0  |
| Volume Module:            |             |      |      |             |      |      |            |      |      |            |      |      |
| Base Vol:                 | 387         | 2    | 376  | 0           | 0    | 0    | 123        | 911  | 0    | 0          | 754  | 251  |
| Growth Adj:               | 1.00        | 1.00 | 1.00 | 1.00        | 1.00 | 1.00 | 1.00       | 1.00 | 1.00 | 1.00       | 1.00 | 1.00 |
| Initial Bse:              | 387         | 2    | 376  | 0           | 0    | 0    | 123        | 911  | 0    | 0          | 754  | 251  |
| Added Vol:                | 0           | 0    | 0    | 0           | 0    | 0    | 0          | 0    | 0    | 0          | 0    | 0    |
| PasserByVol:              | 0           | 0    | 0    | 0           | 0    | 0    | 0          | 0    | 0    | 0          | 0    | 0    |
| Initial Fut:              | 387         | 2    | 376  | 0           | 0    | 0    | 123        | 911  | 0    | 0          | 754  | 251  |
| User Adj:                 | 1.00        | 1.00 | 1.00 | 1.00        | 1.00 | 1.00 | 1.00       | 1.00 | 1.00 | 1.00       | 1.00 | 1.00 |
| PHF Adj:                  | 1.00        | 1.00 | 1.00 | 1.00        | 1.00 | 1.00 | 1.00       | 1.00 | 1.00 | 1.00       | 1.00 | 1.00 |
| PHF Volume:               | 387         | 2    | 376  | 0           | 0    | 0    | 123        | 911  | 0    | 0          | 754  | 251  |
| Reduct Vol:               | 0           | 0    | 0    | 0           | 0    | 0    | 0          | 0    | 0    | 0          | 0    | 0    |
| Reduced Vol:              | 387         | 2    | 376  | 0           | 0    | 0    | 123        | 911  | 0    | 0          | 754  | 251  |
| PCE Adj:                  | 1.00        | 1.00 | 1.00 | 1.00        | 1.00 | 1.00 | 1.00       | 1.00 | 1.00 | 1.00       | 1.00 | 1.00 |
| MLF Adj:                  | 1.00        | 1.00 | 1.00 | 1.00        | 1.00 | 1.00 | 1.00       | 1.00 | 1.00 | 1.00       | 1.00 | 1.00 |
| FinalVolume:              | 387         | 2    | 376  | 0           | 0    | 0    | 123        | 911  | 0    | 0          | 754  | 251  |
| Saturation Flow Module:   |             |      |      |             |      |      |            |      |      |            |      |      |
| Sat/Lane:                 | 1900        | 1900 | 1900 | 1900        | 1900 | 1900 | 1900       | 1900 | 1900 | 1900       | 1900 | 1900 |
| Adjustment:               | 0.93        | 0.95 | 0.92 | 0.92        | 1.00 | 0.92 | 0.83       | 1.00 | 0.92 | 0.92       | 1.00 | 0.92 |
| Lanes:                    | 1.99        | 0.01 | 1.00 | 0.00        | 0.00 | 0.00 | 2.00       | 2.00 | 0.00 | 0.00       | 2.00 | 1.00 |
| Final Sat.:               | 3532        | 18   | 1750 | 0           | 0    | 0    | 3150       | 3800 | 0    | 0          | 3800 | 1750 |
| Capacity Analysis Module: |             |      |      |             |      |      |            |      |      |            |      |      |
| Vol/Sat:                  | 0.11        | 0.11 | 0.21 | 0.00        | 0.00 | 0.00 | 0.04       | 0.24 | 0.00 | 0.00       | 0.20 | 0.14 |
| Crit Moves:               | ****        |      |      | ****        |      |      | ****       |      |      | ****       |      |      |
| Green Time:               | 28.1        | 28.1 | 28.1 | 0.0         | 0.0  | 0.0  | 7.0        | 32.9 | 0.0  | 0.0        | 25.9 | 25.9 |
| Volume/Cap:               | 0.27        | 0.27 | 0.54 | 0.00        | 0.00 | 0.00 | 0.39       | 0.51 | 0.00 | 0.00       | 0.54 | 0.39 |
| Delay/Veh:                | 14.2        | 14.2 | 16.8 | 0.0         | 0.0  | 0.0  | 30.3       | 13.2 | 0.0  | 0.0        | 17.7 | 16.6 |
| User DelAdj:              | 1.00        | 1.00 | 1.00 | 1.00        | 1.00 | 1.00 | 1.00       | 1.00 | 1.00 | 1.00       | 1.00 | 1.00 |
| AdjDel/Veh:               | 14.2        | 14.2 | 16.8 | 0.0         | 0.0  | 0.0  | 30.3       | 13.2 | 0.0  | 0.0        | 17.7 | 16.6 |
| LOS by Move:              | B           | B    | B    | A           | A    | A    | C          | B    | A    | A          | B    | B    |
| HCM2k95thQ:               | 6           | 6    | 14   | 0           | 0    | 0    | 3          | 13   | 0    | 0          | 12   | 8    |

Note: Queue reported is the number of cars per lane.

BART

Level Of Service Computation Report  
 2000 HCM Operations (Future Volume Alternative)  
 AM - Bkgrd + Proj Conditions

Intersection #3023: 101/SANTA CLARA [Study Int 14]

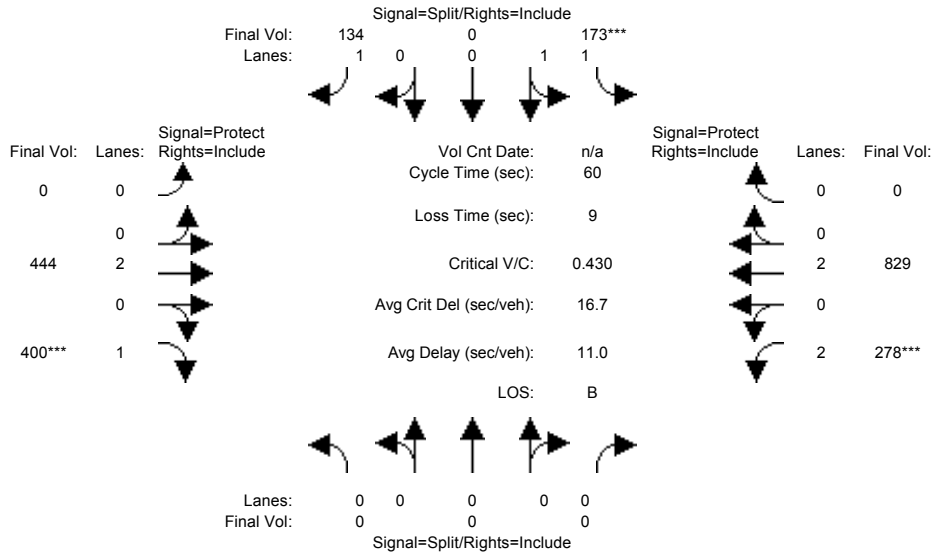

| Approach:                 | North Bound |      |      | South Bound |      |      | East Bound |      |      | West Bound |      |      |
|---------------------------|-------------|------|------|-------------|------|------|------------|------|------|------------|------|------|
| Movement:                 | L           | T    | R    | L           | T    | R    | L          | T    | R    | L          | T    | R    |
| Min. Green:               | 0           | 0    | 0    | 10          | 10   | 10   | 0          | 10   | 10   | 7          | 10   | 0    |
| Y+R:                      | 4.0         | 4.0  | 4.0  | 4.0         | 4.0  | 4.0  | 4.0        | 4.0  | 4.0  | 4.0        | 4.0  | 4.0  |
| Volume Module:            |             |      |      |             |      |      |            |      |      |            |      |      |
| Base Vol:                 | 0           | 0    | 0    | 173         | 0    | 134  | 0          | 444  | 400  | 278        | 829  | 0    |
| Growth Adj:               | 1.00        | 1.00 | 1.00 | 1.00        | 1.00 | 1.00 | 1.00       | 1.00 | 1.00 | 1.00       | 1.00 | 1.00 |
| Initial Bse:              | 0           | 0    | 0    | 173         | 0    | 134  | 0          | 444  | 400  | 278        | 829  | 0    |
| Added Vol:                | 0           | 0    | 0    | 0           | 0    | 0    | 0          | 0    | 0    | 0          | 0    | 0    |
| PasserByVol:              | 0           | 0    | 0    | 0           | 0    | 0    | 0          | 0    | 0    | 0          | 0    | 0    |
| Initial Fut:              | 0           | 0    | 0    | 173         | 0    | 134  | 0          | 444  | 400  | 278        | 829  | 0    |
| User Adj:                 | 1.00        | 1.00 | 1.00 | 1.00        | 1.00 | 1.00 | 1.00       | 1.00 | 1.00 | 1.00       | 1.00 | 1.00 |
| PHF Adj:                  | 1.00        | 1.00 | 1.00 | 1.00        | 1.00 | 1.00 | 1.00       | 1.00 | 1.00 | 1.00       | 1.00 | 1.00 |
| PHF Volume:               | 0           | 0    | 0    | 173         | 0    | 134  | 0          | 444  | 400  | 278        | 829  | 0    |
| Reduct Vol:               | 0           | 0    | 0    | 0           | 0    | 0    | 0          | 0    | 0    | 0          | 0    | 0    |
| Reduced Vol:              | 0           | 0    | 0    | 173         | 0    | 134  | 0          | 444  | 400  | 278        | 829  | 0    |
| PCE Adj:                  | 1.00        | 1.00 | 1.00 | 1.00        | 1.00 | 1.00 | 1.00       | 1.00 | 1.00 | 1.00       | 1.00 | 1.00 |
| MLF Adj:                  | 1.00        | 1.00 | 1.00 | 1.00        | 1.00 | 1.00 | 1.00       | 1.00 | 1.00 | 1.00       | 1.00 | 1.00 |
| FinalVolume:              | 0           | 0    | 0    | 173         | 0    | 134  | 0          | 444  | 400  | 278        | 829  | 0    |
| Saturation Flow Module:   |             |      |      |             |      |      |            |      |      |            |      |      |
| Sat/Lane:                 | 1900        | 1900 | 1900 | 1900        | 1900 | 1900 | 1900       | 1900 | 1900 | 1900       | 1900 | 1900 |
| Adjustment:               | 0.92        | 1.00 | 0.92 | 0.93        | 1.00 | 0.92 | 0.92       | 1.00 | 0.92 | 0.83       | 1.00 | 0.92 |
| Lanes:                    | 0.00        | 0.00 | 0.00 | 2.00        | 0.00 | 1.00 | 0.00       | 2.00 | 1.00 | 2.00       | 2.00 | 0.00 |
| Final Sat.:               | 0           | 0    | 0    | 3550        | 0    | 1750 | 0          | 3800 | 1750 | 3150       | 3800 | 0    |
| Capacity Analysis Module: |             |      |      |             |      |      |            |      |      |            |      |      |
| Vol/Sat:                  | 0.00        | 0.00 | 0.00 | 0.05        | 0.00 | 0.08 | 0.00       | 0.12 | 0.23 | 0.09       | 0.22 | 0.00 |
| Crit Moves:               |             |      |      | ****        |      |      |            |      | **** | ****       |      |      |
| Green Time:               | 0.0         | 0.0  | 0.0  | 10.7        | 0.0  | 10.7 | 0.0        | 29.1 | 29.1 | 11.2       | 40.3 | 0.0  |
| Volume/Cap:               | 0.00        | 0.00 | 0.00 | 0.27        | 0.00 | 0.43 | 0.00       | 0.24 | 0.47 | 0.47       | 0.32 | 0.00 |
| Delay/Veh:                | 0.0         | 0.0  | 0.0  | 21.5        | 0.0  | 22.9 | 0.0        | 9.1  | 10.7 | 22.3       | 4.2  | 0.0  |
| User DelAdj:              | 1.00        | 1.00 | 1.00 | 1.00        | 1.00 | 1.00 | 1.00       | 1.00 | 1.00 | 1.00       | 1.00 | 1.00 |
| AdjDel/Veh:               | 0.0         | 0.0  | 0.0  | 21.5        | 0.0  | 22.9 | 0.0        | 9.1  | 10.7 | 22.3       | 4.2  | 0.0  |
| LOS by Move:              | A           | A    | A    | C           | A    | C    | A          | A    | B    | C          | A    | A    |
| HCM2k95thQ:               | 0           | 0    | 0    | 3           | 0    | 6    | 0          | 5    | 10   | 5          | 6    | 0    |

Note: Queue reported is the number of cars per lane.

BART

Level Of Service Computation Report  
 2000 HCM Operations (Future Volume Alternative)  
 PM - Bkgrd + Proj Conditions

Intersection #3023: 101/SANTA CLARA [Study Int 14]

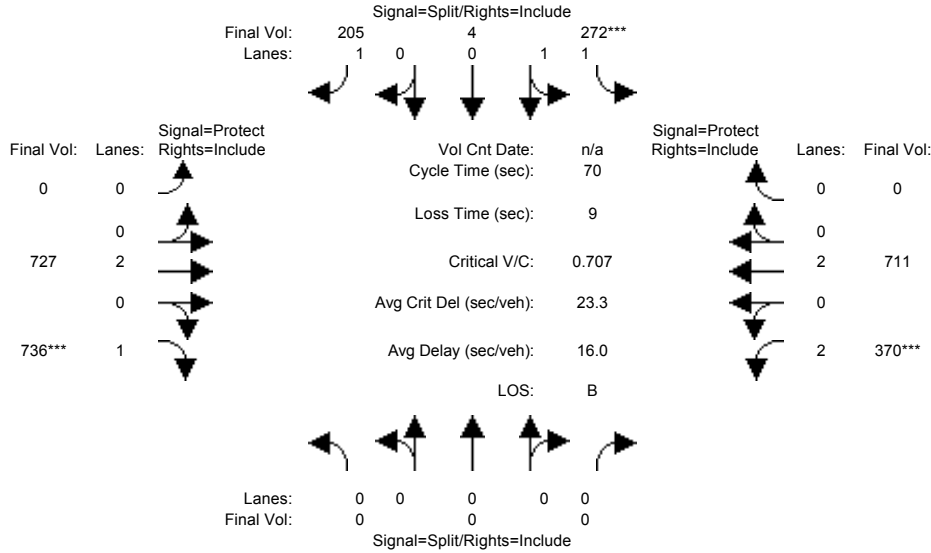

| Approach:                 | North Bound |      |      | South Bound |      |      | East Bound |      |      | West Bound |      |      |
|---------------------------|-------------|------|------|-------------|------|------|------------|------|------|------------|------|------|
| Movement:                 | L           | T    | R    | L           | T    | R    | L          | T    | R    | L          | T    | R    |
| Min. Green:               | 0           | 0    | 0    | 10          | 10   | 10   | 0          | 10   | 10   | 7          | 10   | 0    |
| Y+R:                      | 4.0         | 4.0  | 4.0  | 4.0         | 4.0  | 4.0  | 4.0        | 4.0  | 4.0  | 4.0        | 4.0  | 4.0  |
| Volume Module:            |             |      |      |             |      |      |            |      |      |            |      |      |
| Base Vol:                 | 0           | 0    | 0    | 272         | 4    | 205  | 0          | 727  | 736  | 370        | 711  | 0    |
| Growth Adj:               | 1.00        | 1.00 | 1.00 | 1.00        | 1.00 | 1.00 | 1.00       | 1.00 | 1.00 | 1.00       | 1.00 | 1.00 |
| Initial Bse:              | 0           | 0    | 0    | 272         | 4    | 205  | 0          | 727  | 736  | 370        | 711  | 0    |
| Added Vol:                | 0           | 0    | 0    | 0           | 0    | 0    | 0          | 0    | 0    | 0          | 0    | 0    |
| PasserByVol:              | 0           | 0    | 0    | 0           | 0    | 0    | 0          | 0    | 0    | 0          | 0    | 0    |
| Initial Fut:              | 0           | 0    | 0    | 272         | 4    | 205  | 0          | 727  | 736  | 370        | 711  | 0    |
| User Adj:                 | 1.00        | 1.00 | 1.00 | 1.00        | 1.00 | 1.00 | 1.00       | 1.00 | 1.00 | 1.00       | 1.00 | 1.00 |
| PHF Adj:                  | 1.00        | 1.00 | 1.00 | 1.00        | 1.00 | 1.00 | 1.00       | 1.00 | 1.00 | 1.00       | 1.00 | 1.00 |
| PHF Volume:               | 0           | 0    | 0    | 272         | 4    | 205  | 0          | 727  | 736  | 370        | 711  | 0    |
| Reduct Vol:               | 0           | 0    | 0    | 0           | 0    | 0    | 0          | 0    | 0    | 0          | 0    | 0    |
| Reduced Vol:              | 0           | 0    | 0    | 272         | 4    | 205  | 0          | 727  | 736  | 370        | 711  | 0    |
| PCE Adj:                  | 1.00        | 1.00 | 1.00 | 1.00        | 1.00 | 1.00 | 1.00       | 1.00 | 1.00 | 1.00       | 1.00 | 1.00 |
| MLF Adj:                  | 1.00        | 1.00 | 1.00 | 1.00        | 1.00 | 1.00 | 1.00       | 1.00 | 1.00 | 1.00       | 1.00 | 1.00 |
| FinalVolume:              | 0           | 0    | 0    | 272         | 4    | 205  | 0          | 727  | 736  | 370        | 711  | 0    |
| Saturation Flow Module:   |             |      |      |             |      |      |            |      |      |            |      |      |
| Sat/Lane:                 | 1900        | 1900 | 1900 | 1900        | 1900 | 1900 | 1900       | 1900 | 1900 | 1900       | 1900 | 1900 |
| Adjustment:               | 0.92        | 1.00 | 0.92 | 0.93        | 0.95 | 0.92 | 0.92       | 1.00 | 0.92 | 0.83       | 1.00 | 0.92 |
| Lanes:                    | 0.00        | 0.00 | 0.00 | 1.97        | 0.03 | 1.00 | 0.00       | 2.00 | 1.00 | 2.00       | 2.00 | 0.00 |
| Final Sat.:               | 0           | 0    | 0    | 3499        | 51   | 1750 | 0          | 3800 | 1750 | 3150       | 3800 | 0    |
| Capacity Analysis Module: |             |      |      |             |      |      |            |      |      |            |      |      |
| Vol/Sat:                  | 0.00        | 0.00 | 0.00 | 0.08        | 0.08 | 0.12 | 0.00       | 0.19 | 0.42 | 0.12       | 0.19 | 0.00 |
| Crit Moves:               |             |      |      | ****        |      |      | ****       |      | **** | ****       |      |      |
| Green Time:               | 0.0         | 0.0  | 0.0  | 11.6        | 11.6 | 11.6 | 0.0        | 38.6 | 38.6 | 10.8       | 49.4 | 0.0  |
| Volume/Cap:               | 0.00        | 0.00 | 0.00 | 0.47        | 0.47 | 0.71 | 0.00       | 0.35 | 0.76 | 0.76       | 0.27 | 0.00 |
| Delay/Veh:                | 0.0         | 0.0  | 0.0  | 27.0        | 27.0 | 35.3 | 0.0        | 8.8  | 15.8 | 35.4       | 3.8  | 0.0  |
| User DelAdj:              | 1.00        | 1.00 | 1.00 | 1.00        | 1.00 | 1.00 | 1.00       | 1.00 | 1.00 | 1.00       | 1.00 | 1.00 |
| AdjDel/Veh:               | 0.0         | 0.0  | 0.0  | 27.0        | 27.0 | 35.3 | 0.0        | 8.8  | 15.8 | 35.4       | 3.8  | 0.0  |
| LOS by Move:              | A           | A    | A    | C           | C    | D    | A          | A    | B    | D          | A    | A    |
| HCM2k95thQ:               | 0           | 0    | 0    | 7           | 7    | 12   | 0          | 8    | 24   | 10         | 5    | 0    |

Note: Queue reported is the number of cars per lane.

BART

Level Of Service Computation Report  
 2000 HCM Operations (Future Volume Alternative)  
 AM - Bkgrd + Proj Conditions

Intersection #3036: 280/MCLAUGHLIN [Study Int 25]

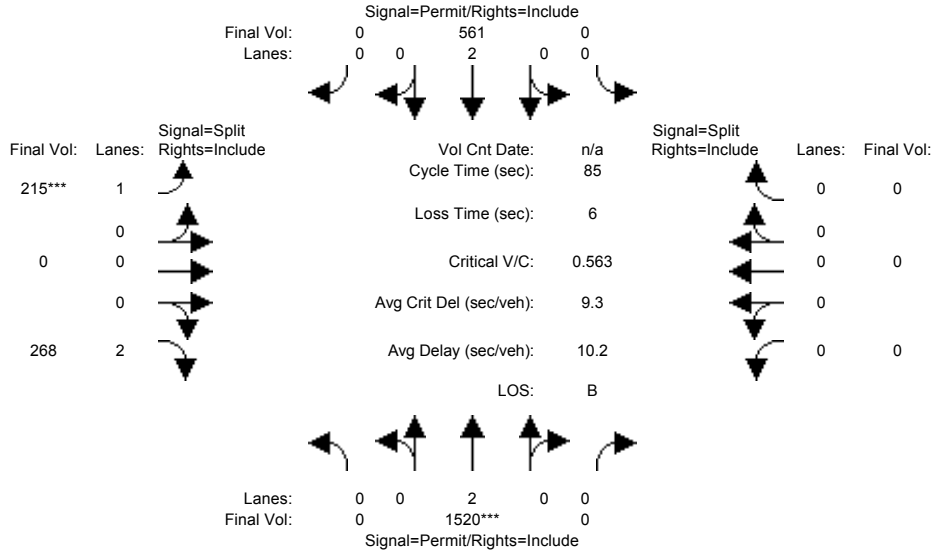

| Approach:                 | North Bound |      |      | South Bound |      |      | East Bound |      |      | West Bound |      |      |
|---------------------------|-------------|------|------|-------------|------|------|------------|------|------|------------|------|------|
| Movement:                 | L           | T    | R    | L           | T    | R    | L          | T    | R    | L          | T    | R    |
| Min. Green:               | 0           | 10   | 0    | 0           | 10   | 0    | 10         | 0    | 10   | 0          | 0    | 0    |
| Y+R:                      | 4.0         | 4.0  | 4.0  | 4.0         | 4.0  | 4.0  | 4.0        | 4.0  | 4.0  | 4.0        | 4.0  | 4.0  |
| Volume Module:            |             |      |      |             |      |      |            |      |      |            |      |      |
| Base Vol:                 | 0           | 1520 | 0    | 0           | 0    | 561  | 0          | 215  | 0    | 268        | 0    | 0    |
| Growth Adj:               | 1.00        | 1.00 | 1.00 | 1.00        | 1.00 | 1.00 | 1.00       | 1.00 | 1.00 | 1.00       | 1.00 | 1.00 |
| Initial Bse:              | 0           | 1520 | 0    | 0           | 0    | 561  | 0          | 215  | 0    | 268        | 0    | 0    |
| Added Vol:                | 0           | 0    | 0    | 0           | 0    | 0    | 0          | 0    | 0    | 0          | 0    | 0    |
| PasserByVol:              | 0           | 0    | 0    | 0           | 0    | 0    | 0          | 0    | 0    | 0          | 0    | 0    |
| Initial Fut:              | 0           | 1520 | 0    | 0           | 0    | 561  | 0          | 215  | 0    | 268        | 0    | 0    |
| User Adj:                 | 1.00        | 1.00 | 1.00 | 1.00        | 1.00 | 1.00 | 1.00       | 1.00 | 1.00 | 1.00       | 1.00 | 1.00 |
| PHF Adj:                  | 1.00        | 1.00 | 1.00 | 1.00        | 1.00 | 1.00 | 1.00       | 1.00 | 1.00 | 1.00       | 1.00 | 1.00 |
| PHF Volume:               | 0           | 1520 | 0    | 0           | 0    | 561  | 0          | 215  | 0    | 268        | 0    | 0    |
| Reduct Vol:               | 0           | 0    | 0    | 0           | 0    | 0    | 0          | 0    | 0    | 0          | 0    | 0    |
| Reduced Vol:              | 0           | 1520 | 0    | 0           | 0    | 561  | 0          | 215  | 0    | 268        | 0    | 0    |
| PCE Adj:                  | 1.00        | 1.00 | 1.00 | 1.00        | 1.00 | 1.00 | 1.00       | 1.00 | 1.00 | 1.00       | 1.00 | 1.00 |
| MLF Adj:                  | 1.00        | 1.00 | 1.00 | 1.00        | 1.00 | 1.00 | 1.00       | 1.00 | 1.00 | 1.00       | 1.00 | 1.00 |
| Final Volume:             | 0           | 1520 | 0    | 0           | 0    | 561  | 0          | 215  | 0    | 268        | 0    | 0    |
| Saturation Flow Module:   |             |      |      |             |      |      |            |      |      |            |      |      |
| Sat/Lane:                 | 1900        | 1900 | 1900 | 1900        | 1900 | 1900 | 1900       | 1900 | 1900 | 1900       | 1900 | 1900 |
| Adjustment:               | 0.92        | 1.00 | 0.92 | 0.92        | 1.00 | 0.92 | 0.92       | 1.00 | 0.83 | 0.92       | 1.00 | 0.92 |
| Lanes:                    | 0.00        | 2.00 | 0.00 | 0.00        | 2.00 | 0.00 | 1.00       | 0.00 | 2.00 | 0.00       | 0.00 | 0.00 |
| Final Sat.:               | 0           | 3800 | 0    | 0           | 3800 | 0    | 1750       | 0    | 3150 | 0          | 0    | 0    |
| Capacity Analysis Module: |             |      |      |             |      |      |            |      |      |            |      |      |
| Vol/Sat:                  | 0.00        | 0.40 | 0.00 | 0.00        | 0.15 | 0.00 | 0.12       | 0.00 | 0.09 | 0.00       | 0.00 | 0.00 |
| Crit Moves:               | ****        |      |      | ****        |      |      | ****       |      |      | ****       |      |      |
| Green Time:               | 0.0         | 60.4 | 0.0  | 0.0         | 60.4 | 0.0  | 18.6       | 0.0  | 18.6 | 0.0        | 0.0  | 0.0  |
| Volume/Cap:               | 0.00        | 0.56 | 0.00 | 0.00        | 0.21 | 0.00 | 0.56       | 0.00 | 0.39 | 0.00       | 0.00 | 0.00 |
| Delay/Veh:                | 0.0         | 6.2  | 0.0  | 0.0         | 4.2  | 0.0  | 31.5       | 0.0  | 28.7 | 0.0        | 0.0  | 0.0  |
| User DelAdj:              | 1.00        | 1.00 | 1.00 | 1.00        | 1.00 | 1.00 | 1.00       | 1.00 | 1.00 | 1.00       | 1.00 | 1.00 |
| AdjDel/Veh:               | 0.0         | 6.2  | 0.0  | 0.0         | 4.2  | 0.0  | 31.5       | 0.0  | 28.7 | 0.0        | 0.0  | 0.0  |
| LOS by Move:              | A           | A    | A    | A           | A    | A    | C          | A    | C    | A          | A    | A    |
| HCM2k95thQ:               | 0           | 18   | 0    | 0           | 5    | 0    | 12         | 0    | 8    | 0          | 0    | 0    |

Note: Queue reported is the number of cars per lane.



BART

Level Of Service Computation Report  
 2000 HCM Operations (Future Volume Alternative)  
 PM - Bkgrd + Proj Conditions

Intersection #3036: 280/MCLAUGHLIN [Study Int 25]

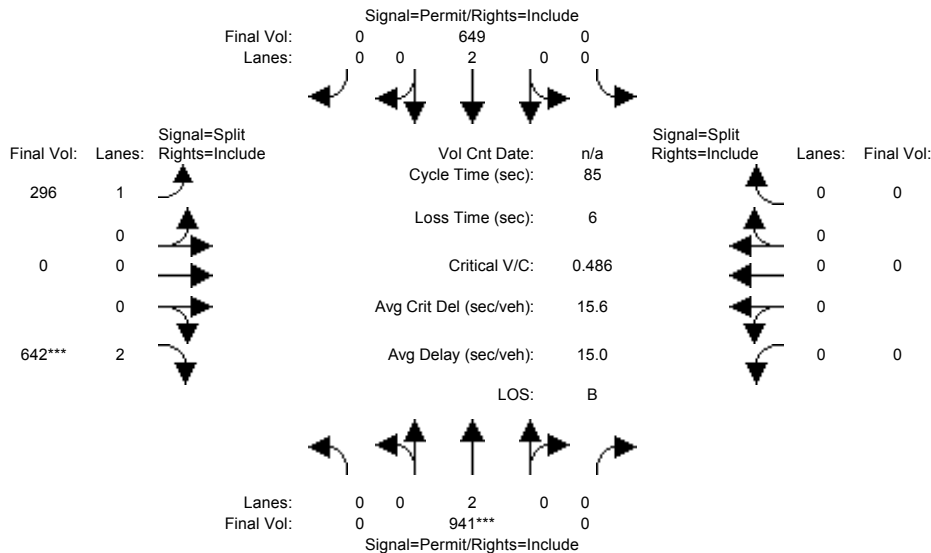

| Approach:                 | North Bound |      |      | South Bound |      |      | East Bound |      |      | West Bound |      |      |
|---------------------------|-------------|------|------|-------------|------|------|------------|------|------|------------|------|------|
| Movement:                 | L           | T    | R    | L           | T    | R    | L          | T    | R    | L          | T    | R    |
| Min. Green:               | 0           | 10   | 0    | 0           | 10   | 0    | 10         | 0    | 10   | 0          | 0    | 0    |
| Y+R:                      | 4.0         | 4.0  | 4.0  | 4.0         | 4.0  | 4.0  | 4.0        | 4.0  | 4.0  | 4.0        | 4.0  | 4.0  |
| Volume Module:            |             |      |      |             |      |      |            |      |      |            |      |      |
| Base Vol:                 | 0           | 941  | 0    | 0           | 649  | 0    | 296        | 0    | 642  | 0          | 0    | 0    |
| Growth Adj:               | 1.00        | 1.00 | 1.00 | 1.00        | 1.00 | 1.00 | 1.00       | 1.00 | 1.00 | 1.00       | 1.00 | 1.00 |
| Initial Bse:              | 0           | 941  | 0    | 0           | 649  | 0    | 296        | 0    | 642  | 0          | 0    | 0    |
| Added Vol:                | 0           | 0    | 0    | 0           | 0    | 0    | 0          | 0    | 0    | 0          | 0    | 0    |
| PasserByVol:              | 0           | 0    | 0    | 0           | 0    | 0    | 0          | 0    | 0    | 0          | 0    | 0    |
| Initial Fut:              | 0           | 941  | 0    | 0           | 649  | 0    | 296        | 0    | 642  | 0          | 0    | 0    |
| User Adj:                 | 1.00        | 1.00 | 1.00 | 1.00        | 1.00 | 1.00 | 1.00       | 1.00 | 1.00 | 1.00       | 1.00 | 1.00 |
| PHF Adj:                  | 1.00        | 1.00 | 1.00 | 1.00        | 1.00 | 1.00 | 1.00       | 1.00 | 1.00 | 1.00       | 1.00 | 1.00 |
| PHF Volume:               | 0           | 941  | 0    | 0           | 649  | 0    | 296        | 0    | 642  | 0          | 0    | 0    |
| Reduct Vol:               | 0           | 0    | 0    | 0           | 0    | 0    | 0          | 0    | 0    | 0          | 0    | 0    |
| Reduced Vol:              | 0           | 941  | 0    | 0           | 649  | 0    | 296        | 0    | 642  | 0          | 0    | 0    |
| PCE Adj:                  | 1.00        | 1.00 | 1.00 | 1.00        | 1.00 | 1.00 | 1.00       | 1.00 | 1.00 | 1.00       | 1.00 | 1.00 |
| MLF Adj:                  | 1.00        | 1.00 | 1.00 | 1.00        | 1.00 | 1.00 | 1.00       | 1.00 | 1.00 | 1.00       | 1.00 | 1.00 |
| Final Volume:             | 0           | 941  | 0    | 0           | 649  | 0    | 296        | 0    | 642  | 0          | 0    | 0    |
| Saturation Flow Module:   |             |      |      |             |      |      |            |      |      |            |      |      |
| Sat/Lane:                 | 1900        | 1900 | 1900 | 1900        | 1900 | 1900 | 1900       | 1900 | 1900 | 1900       | 1900 | 1900 |
| Adjustment:               | 0.92        | 1.00 | 0.92 | 0.92        | 1.00 | 0.92 | 0.92       | 1.00 | 0.83 | 0.92       | 1.00 | 0.92 |
| Lanes:                    | 0.00        | 2.00 | 0.00 | 0.00        | 2.00 | 0.00 | 1.00       | 0.00 | 2.00 | 0.00       | 0.00 | 0.00 |
| Final Sat.:               | 0           | 3800 | 0    | 0           | 3800 | 0    | 1750       | 0    | 3150 | 0          | 0    | 0    |
| Capacity Analysis Module: |             |      |      |             |      |      |            |      |      |            |      |      |
| Vol/Sat:                  | 0.00        | 0.25 | 0.00 | 0.00        | 0.17 | 0.00 | 0.17       | 0.00 | 0.20 | 0.00       | 0.00 | 0.00 |
| Crit Moves:               | ****        |      |      | ****        |      |      | ****       |      |      | ****       |      |      |
| Green Time:               | 0.0         | 43.3 | 0.0  | 0.0         | 43.3 | 0.0  | 35.7       | 0.0  | 35.7 | 0.0        | 0.0  | 0.0  |
| Volume/Cap:               | 0.00        | 0.49 | 0.00 | 0.00        | 0.34 | 0.00 | 0.40       | 0.00 | 0.49 | 0.00       | 0.00 | 0.00 |
| Delay/Veh:                | 0.0         | 13.8 | 0.0  | 0.0         | 12.4 | 0.0  | 17.6       | 0.0  | 18.3 | 0.0        | 0.0  | 0.0  |
| User DelAdj:              | 1.00        | 1.00 | 1.00 | 1.00        | 1.00 | 1.00 | 1.00       | 1.00 | 1.00 | 1.00       | 1.00 | 1.00 |
| AdjDel/Veh:               | 0.0         | 13.8 | 0.0  | 0.0         | 12.4 | 0.0  | 17.6       | 0.0  | 18.3 | 0.0        | 0.0  | 0.0  |
| LOS by Move:              | A           | B    | A    | A           | B    | A    | B          | A    | B    | A          | A    | A    |
| HCM2k95thQ:               | 0           | 15   | 0    | 0           | 10   | 0    | 12         | 0    | 14   | 0          | 0    | 0    |

Note: Queue reported is the number of cars per lane.

BART

Level Of Service Computation Report  
 2000 HCM Operations (Future Volume Alternative)  
 AM - Bkgrd + Proj Conditions

Intersection #3042: 680N/ALUM ROCK (E) [Study Int 20]

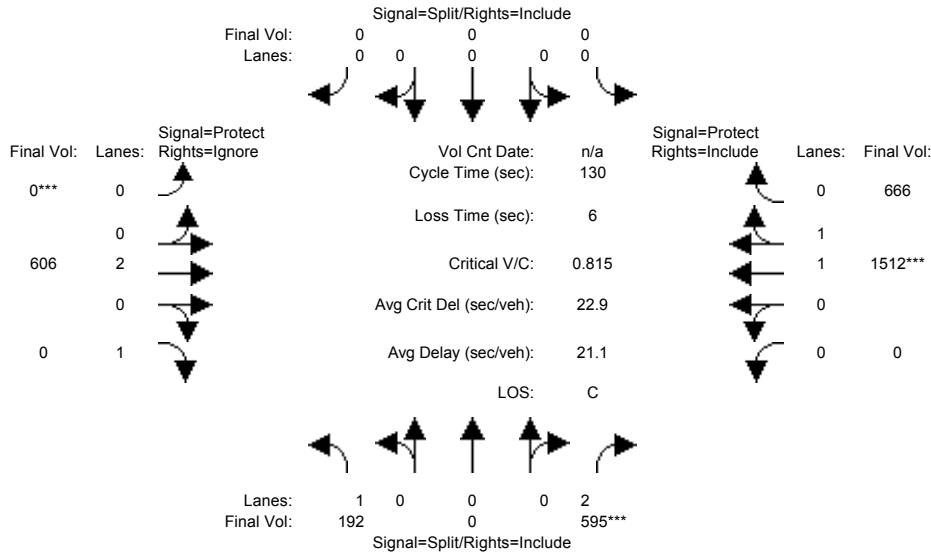

| Approach:                 | North Bound |      |      | South Bound |      |      | East Bound |      |      | West Bound |      |      |
|---------------------------|-------------|------|------|-------------|------|------|------------|------|------|------------|------|------|
| Movement:                 | L           | T    | R    | L           | T    | R    | L          | T    | R    | L          | T    | R    |
| Min. Green:               | 10          | 0    | 10   | 0           | 0    | 0    | 0          | 10   | 10   | 0          | 10   | 10   |
| Y+R:                      | 4.0         | 4.0  | 4.0  | 4.0         | 4.0  | 4.0  | 4.0        | 4.0  | 4.0  | 4.0        | 4.0  | 4.0  |
| Volume Module:            |             |      |      |             |      |      |            |      |      |            |      |      |
| Base Vol:                 | 192         | 0    | 595  | 0           | 0    | 0    | 0          | 606  | 361  | 0          | 1512 | 666  |
| Growth Adj:               | 1.00        | 1.00 | 1.00 | 1.00        | 1.00 | 1.00 | 1.00       | 1.00 | 1.00 | 1.00       | 1.00 | 1.00 |
| Initial Bse:              | 192         | 0    | 595  | 0           | 0    | 0    | 0          | 606  | 361  | 0          | 1512 | 666  |
| Added Vol:                | 0           | 0    | 0    | 0           | 0    | 0    | 0          | 0    | 0    | 0          | 0    | 0    |
| PasserByVol:              | 0           | 0    | 0    | 0           | 0    | 0    | 0          | 0    | 0    | 0          | 0    | 0    |
| Initial Fut:              | 192         | 0    | 595  | 0           | 0    | 0    | 0          | 606  | 361  | 0          | 1512 | 666  |
| User Adj:                 | 1.00        | 1.00 | 1.00 | 1.00        | 1.00 | 1.00 | 1.00       | 1.00 | 0.00 | 1.00       | 1.00 | 1.00 |
| PHF Adj:                  | 1.00        | 1.00 | 1.00 | 1.00        | 1.00 | 1.00 | 1.00       | 1.00 | 0.00 | 1.00       | 1.00 | 1.00 |
| PHF Volume:               | 192         | 0    | 595  | 0           | 0    | 0    | 0          | 606  | 0    | 0          | 1512 | 666  |
| Reduct Vol:               | 0           | 0    | 0    | 0           | 0    | 0    | 0          | 0    | 0    | 0          | 0    | 0    |
| Reduced Vol:              | 192         | 0    | 595  | 0           | 0    | 0    | 0          | 606  | 0    | 0          | 1512 | 666  |
| PCE Adj:                  | 1.00        | 1.00 | 1.00 | 1.00        | 1.00 | 1.00 | 1.00       | 1.00 | 0.00 | 1.00       | 1.00 | 1.00 |
| MLF Adj:                  | 1.00        | 1.00 | 1.00 | 1.00        | 1.00 | 1.00 | 1.00       | 1.00 | 0.00 | 1.00       | 1.00 | 1.00 |
| Final Volume:             | 192         | 0    | 595  | 0           | 0    | 0    | 0          | 606  | 0    | 0          | 1512 | 666  |
| Saturation Flow Module:   |             |      |      |             |      |      |            |      |      |            |      |      |
| Sat/Lane:                 | 1900        | 1900 | 1900 | 1900        | 1900 | 1900 | 1900       | 1900 | 1900 | 1900       | 1900 | 1900 |
| Adjustment:               | 0.92        | 1.00 | 0.83 | 0.92        | 1.00 | 0.92 | 0.92       | 1.00 | 0.92 | 0.92       | 0.99 | 0.95 |
| Lanes:                    | 1.00        | 0.00 | 2.00 | 0.00        | 0.00 | 0.00 | 0.00       | 2.00 | 1.00 | 0.00       | 1.37 | 0.63 |
| Final Sat.:               | 1750        | 0    | 3150 | 0           | 0    | 0    | 0          | 3800 | 1750 | 0          | 2568 | 1131 |
| Capacity Analysis Module: |             |      |      |             |      |      |            |      |      |            |      |      |
| Vol/Sat:                  | 0.11        | 0.00 | 0.19 | 0.00        | 0.00 | 0.00 | 0.00       | 0.16 | 0.00 | 0.00       | 0.59 | 0.59 |
| Crit Moves:               | ****        |      |      | ****        |      |      | ****       |      |      | ****       |      |      |
| Green Time:               | 30.1        | 0.0  | 30.1 | 0.0         | 0.0  | 0.0  | 0.0        | 93.9 | 0.0  | 0.0        | 93.9 | 93.9 |
| Volume/Cap:               | 0.47        | 0.00 | 0.82 | 0.00        | 0.00 | 0.00 | 0.00       | 0.22 | 0.00 | 0.00       | 0.82 | 0.82 |
| Delay/Veh:                | 44.0        | 0.0  | 54.4 | 0.0         | 0.0  | 0.0  | 0.0        | 6.0  | 0.0  | 0.0        | 14.2 | 14.2 |
| User DelAdj:              | 1.00        | 1.00 | 1.00 | 1.00        | 1.00 | 1.00 | 1.00       | 1.00 | 1.00 | 1.00       | 1.00 | 1.00 |
| AdjDel/Veh:               | 44.0        | 0.0  | 54.4 | 0.0         | 0.0  | 0.0  | 0.0        | 6.0  | 0.0  | 0.0        | 14.2 | 14.2 |
| LOS by Move:              | D           | A    | D    | A           | A    | A    | A          | A    | A    | A          | B    | B    |
| HCM2k95thQ:               | 14          | 0    | 27   | 0           | 0    | 0    | 0          | 8    | 0    | 0          | 50   | 50   |

Note: Queue reported is the number of cars per lane.

BART

Level Of Service Computation Report  
 2000 HCM Operations (Future Volume Alternative)  
 PM - Bkgrd + Proj Conditions

Intersection #3042: 680N/ALUM ROCK (E) [Study Int 20]

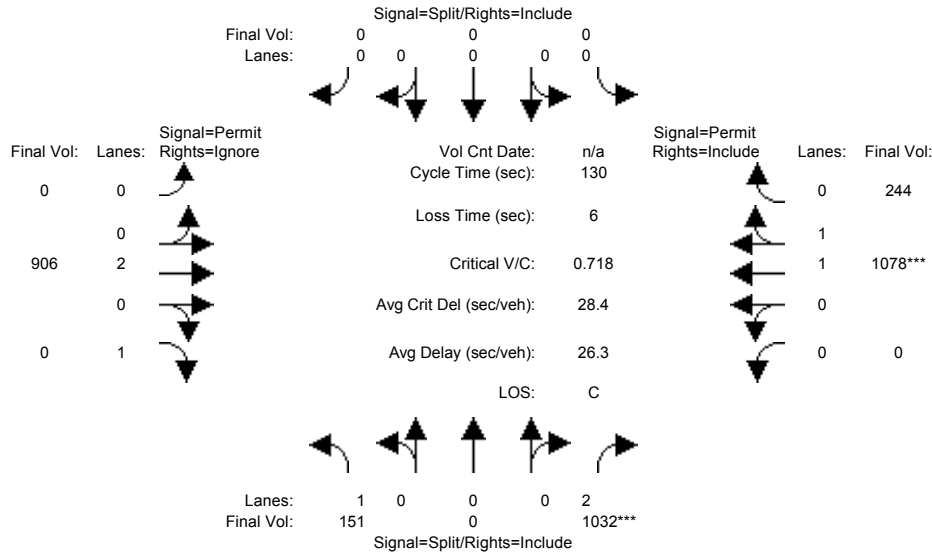

| Approach:                 | North Bound |      |      | South Bound |      |      | East Bound |      |      | West Bound |      |      |
|---------------------------|-------------|------|------|-------------|------|------|------------|------|------|------------|------|------|
| Movement:                 | L           | T    | R    | L           | T    | R    | L          | T    | R    | L          | T    | R    |
| Min. Green:               | 10          | 0    | 10   | 0           | 0    | 0    | 0          | 10   | 10   | 0          | 10   | 10   |
| Y+R:                      | 4.0         | 4.0  | 4.0  | 4.0         | 4.0  | 4.0  | 4.0        | 4.0  | 4.0  | 4.0        | 4.0  | 4.0  |
| Volume Module:            |             |      |      |             |      |      |            |      |      |            |      |      |
| Base Vol:                 | 151         | 0    | 1032 | 0           | 0    | 0    | 0          | 906  | 8    | 0          | 1078 | 244  |
| Growth Adj:               | 1.00        | 1.00 | 1.00 | 1.00        | 1.00 | 1.00 | 1.00       | 1.00 | 1.00 | 1.00       | 1.00 | 1.00 |
| Initial Bse:              | 151         | 0    | 1032 | 0           | 0    | 0    | 0          | 906  | 8    | 0          | 1078 | 244  |
| Added Vol:                | 0           | 0    | 0    | 0           | 0    | 0    | 0          | 0    | 0    | 0          | 0    | 0    |
| PasserByVol:              | 0           | 0    | 0    | 0           | 0    | 0    | 0          | 0    | 0    | 0          | 0    | 0    |
| Initial Fut:              | 151         | 0    | 1032 | 0           | 0    | 0    | 0          | 906  | 8    | 0          | 1078 | 244  |
| User Adj:                 | 1.00        | 1.00 | 1.00 | 1.00        | 1.00 | 1.00 | 1.00       | 1.00 | 0.00 | 1.00       | 1.00 | 1.00 |
| PHF Adj:                  | 1.00        | 1.00 | 1.00 | 1.00        | 1.00 | 1.00 | 1.00       | 1.00 | 0.00 | 1.00       | 1.00 | 1.00 |
| PHF Volume:               | 151         | 0    | 1032 | 0           | 0    | 0    | 0          | 906  | 0    | 0          | 1078 | 244  |
| Reduct Vol:               | 0           | 0    | 0    | 0           | 0    | 0    | 0          | 0    | 0    | 0          | 0    | 0    |
| Reduced Vol:              | 151         | 0    | 1032 | 0           | 0    | 0    | 0          | 906  | 0    | 0          | 1078 | 244  |
| PCE Adj:                  | 1.00        | 1.00 | 1.00 | 1.00        | 1.00 | 1.00 | 1.00       | 1.00 | 0.00 | 1.00       | 1.00 | 1.00 |
| MLF Adj:                  | 1.00        | 1.00 | 1.00 | 1.00        | 1.00 | 1.00 | 1.00       | 1.00 | 0.00 | 1.00       | 1.00 | 1.00 |
| Final Volume:             | 151         | 0    | 1032 | 0           | 0    | 0    | 0          | 906  | 0    | 0          | 1078 | 244  |
| Saturation Flow Module:   |             |      |      |             |      |      |            |      |      |            |      |      |
| Sat/Lane:                 | 1900        | 1900 | 1900 | 1900        | 1900 | 1900 | 1900       | 1900 | 1900 | 1900       | 1900 | 1900 |
| Adjustment:               | 0.92        | 1.00 | 0.83 | 0.92        | 1.00 | 0.92 | 0.92       | 1.00 | 0.92 | 0.92       | 0.98 | 0.95 |
| Lanes:                    | 1.00        | 0.00 | 2.00 | 0.00        | 0.00 | 0.00 | 0.00       | 2.00 | 1.00 | 0.00       | 1.62 | 0.38 |
| Final Sat.:               | 1750        | 0    | 3150 | 0           | 0    | 0    | 0          | 3800 | 1750 | 0          | 3017 | 683  |
| Capacity Analysis Module: |             |      |      |             |      |      |            |      |      |            |      |      |
| Vol/Sat:                  | 0.09        | 0.00 | 0.33 | 0.00        | 0.00 | 0.00 | 0.00       | 0.24 | 0.00 | 0.00       | 0.36 | 0.36 |
| Crit Moves:               | ****        |      |      | ****        |      |      | ****       |      |      | ****       |      |      |
| Green Time:               | 59.3        | 0.0  | 59.3 | 0.0         | 0.0  | 0.0  | 0.0        | 64.7 | 0.0  | 0.0        | 64.7 | 64.7 |
| Volume/Cap:               | 0.19        | 0.00 | 0.72 | 0.00        | 0.00 | 0.00 | 0.00       | 0.48 | 0.00 | 0.00       | 0.72 | 0.72 |
| Delay/Veh:                | 21.2        | 0.0  | 30.4 | 0.0         | 0.0  | 0.0  | 0.0        | 21.7 | 0.0  | 0.0        | 26.9 | 26.9 |
| User DelAdj:              | 1.00        | 1.00 | 1.00 | 1.00        | 1.00 | 1.00 | 1.00       | 1.00 | 1.00 | 1.00       | 1.00 | 1.00 |
| AdjDel/Veh:               | 21.2        | 0.0  | 30.4 | 0.0         | 0.0  | 0.0  | 0.0        | 21.7 | 0.0  | 0.0        | 26.9 | 26.9 |
| LOS by Move:              | C           | A    | C    | A           | A    | A    | A          | C    | A    | A          | C    | C    |
| HCM2k95thQ:               | 7           | 0    | 35   | 0           | 0    | 0    | 0          | 21   | 0    | 0          | 36   | 36   |

Note: Queue reported is the number of cars per lane.

BART

Level Of Service Computation Report  
 2000 HCM Operations (Future Volume Alternative)  
 AM - Bkgrd + Proj Conditions

Intersection #3043: 680S/ALUM ROCK (W) [Study Int 19]

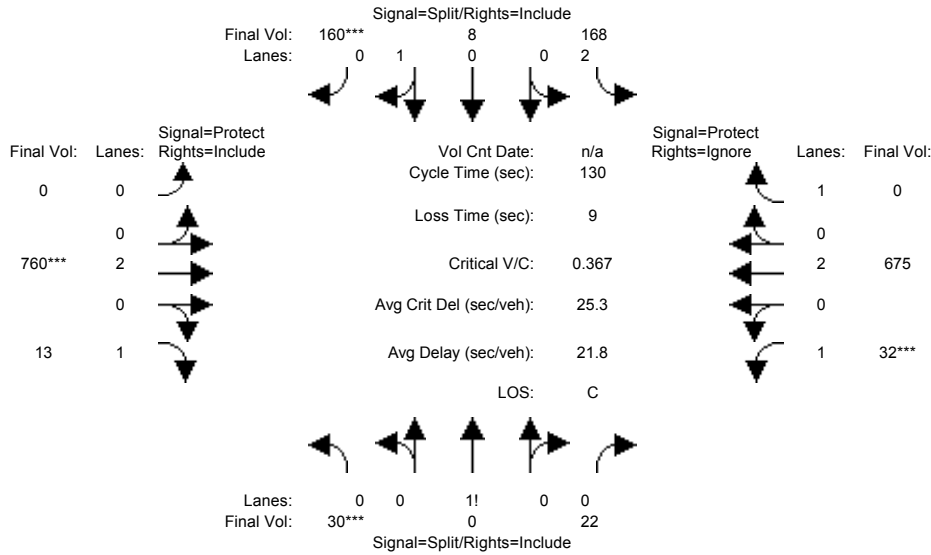

| Approach:                 | North Bound |      |      | South Bound |      |      | East Bound |      |      | West Bound |      |      |
|---------------------------|-------------|------|------|-------------|------|------|------------|------|------|------------|------|------|
| Movement:                 | L           | T    | R    | L           | T    | R    | L          | T    | R    | L          | T    | R    |
| Min. Green:               | 10          | 0    | 10   | 10          | 10   | 10   | 0          | 10   | 10   | 10         | 10   | 10   |
| Y+R:                      | 4.0         | 4.0  | 4.0  | 4.0         | 4.0  | 4.0  | 4.0        | 4.0  | 4.0  | 4.0        | 4.0  | 4.0  |
| Volume Module:            |             |      |      |             |      |      |            |      |      |            |      |      |
| Base Vol:                 | 30          | 0    | 22   | 168         | 8    | 160  | 0          | 760  | 13   | 32         | 675  | 0    |
| Growth Adj:               | 1.00        | 1.00 | 1.00 | 1.00        | 1.00 | 1.00 | 1.00       | 1.00 | 1.00 | 1.00       | 1.00 | 1.00 |
| Initial Bse:              | 30          | 0    | 22   | 168         | 8    | 160  | 0          | 760  | 13   | 32         | 675  | 0    |
| Added Vol:                | 0           | 0    | 0    | 0           | 0    | 0    | 0          | 0    | 0    | 0          | 0    | 0    |
| PasserByVol:              | 0           | 0    | 0    | 0           | 0    | 0    | 0          | 0    | 0    | 0          | 0    | 0    |
| Initial Fut:              | 30          | 0    | 22   | 168         | 8    | 160  | 0          | 760  | 13   | 32         | 675  | 0    |
| User Adj:                 | 1.00        | 1.00 | 1.00 | 1.00        | 1.00 | 1.00 | 1.00       | 1.00 | 1.00 | 1.00       | 1.00 | 0.00 |
| PHF Adj:                  | 1.00        | 1.00 | 1.00 | 1.00        | 1.00 | 1.00 | 1.00       | 1.00 | 1.00 | 1.00       | 1.00 | 0.00 |
| PHF Volume:               | 30          | 0    | 22   | 168         | 8    | 160  | 0          | 760  | 13   | 32         | 675  | 0    |
| Reduct Vol:               | 0           | 0    | 0    | 0           | 0    | 0    | 0          | 0    | 0    | 0          | 0    | 0    |
| Reduced Vol:              | 30          | 0    | 22   | 168         | 8    | 160  | 0          | 760  | 13   | 32         | 675  | 0    |
| PCE Adj:                  | 1.00        | 1.00 | 1.00 | 1.00        | 1.00 | 1.00 | 1.00       | 1.00 | 1.00 | 1.00       | 1.00 | 0.00 |
| MLF Adj:                  | 1.00        | 1.00 | 1.00 | 1.00        | 1.00 | 1.00 | 1.00       | 1.00 | 1.00 | 1.00       | 1.00 | 0.00 |
| Final Volume:             | 30          | 0    | 22   | 168         | 8    | 160  | 0          | 760  | 13   | 32         | 675  | 0    |
| Saturation Flow Module:   |             |      |      |             |      |      |            |      |      |            |      |      |
| Sat/Lane:                 | 1900        | 1900 | 1900 | 1900        | 1900 | 1900 | 1900       | 1900 | 1900 | 1900       | 1900 | 1900 |
| Adjustment:               | 0.92        | 0.92 | 0.92 | 0.83        | 0.95 | 0.95 | 0.92       | 1.00 | 0.92 | 0.92       | 1.00 | 0.92 |
| Lanes:                    | 0.58        | 0.00 | 0.42 | 2.00        | 0.05 | 0.95 | 0.00       | 2.00 | 1.00 | 1.00       | 2.00 | 1.00 |
| Final Sat.:               | 1010        | 0    | 740  | 3150        | 86   | 1714 | 0          | 3800 | 1750 | 1750       | 3800 | 1750 |
| Capacity Analysis Module: |             |      |      |             |      |      |            |      |      |            |      |      |
| Vol/Sat:                  | 0.03        | 0.00 | 0.03 | 0.05        | 0.09 | 0.09 | 0.00       | 0.20 | 0.01 | 0.02       | 0.18 | 0.00 |
| Crit Moves:               | ****        |      |      | ****        |      |      | ****       |      |      | ****       |      |      |
| Green Time:               | 10.2        | 0.0  | 10.2 | 32.1        | 32.1 | 32.1 | 0.0        | 68.7 | 68.7 | 10.0       | 78.7 | 0.0  |
| Volume/Cap:               | 0.38        | 0.00 | 0.38 | 0.22        | 0.38 | 0.38 | 0.00       | 0.38 | 0.01 | 0.24       | 0.29 | 0.00 |
| Delay/Veh:                | 58.6        | 0.0  | 58.6 | 39.1        | 41.2 | 41.2 | 0.0        | 18.2 | 14.6 | 57.3       | 12.4 | 0.0  |
| User DelAdj:              | 1.00        | 1.00 | 1.00 | 1.00        | 1.00 | 1.00 | 1.00       | 1.00 | 1.00 | 1.00       | 1.00 | 1.00 |
| AdjDel/Veh:               | 58.6        | 0.0  | 58.6 | 39.1        | 41.2 | 41.2 | 0.0        | 18.2 | 14.6 | 57.3       | 12.4 | 0.0  |
| LOS by Move:              | E           | A    | E    | D           | D    | D    | A          | B    | B    | E          | B    | A    |
| HCM2k95thQ:               | 5           | 0    | 5    | 6           | 11   | 11   | 0          | 16   | 1    | 3          | 12   | 0    |

Note: Queue reported is the number of cars per lane.

BART

Level Of Service Computation Report  
 2000 HCM Operations (Future Volume Alternative)  
 PM - Bkgrd + Proj Conditions

Intersection #3043: 680S/ALUM ROCK (W) [Study Int 19]

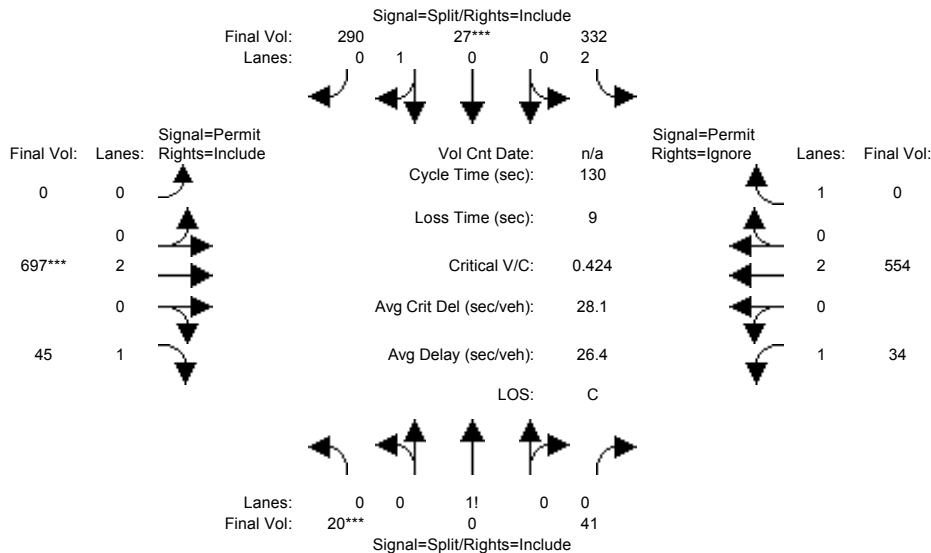

| Approach:                 | North Bound |      |      | South Bound |      |      | East Bound |      |      | West Bound |      |      |
|---------------------------|-------------|------|------|-------------|------|------|------------|------|------|------------|------|------|
| Movement:                 | L           | T    | R    | L           | T    | R    | L          | T    | R    | L          | T    | R    |
| Min. Green:               | 10          | 0    | 10   | 10          | 10   | 10   | 0          | 10   | 10   | 10         | 10   | 10   |
| Y+R:                      | 4.0         | 4.0  | 4.0  | 4.0         | 4.0  | 4.0  | 4.0        | 4.0  | 4.0  | 4.0        | 4.0  | 4.0  |
| Volume Module:            |             |      |      |             |      |      |            |      |      |            |      |      |
| Base Vol:                 | 20          | 0    | 41   | 332         | 27   | 290  | 0          | 697  | 45   | 34         | 554  | 592  |
| Growth Adj:               | 1.00        | 1.00 | 1.00 | 1.00        | 1.00 | 1.00 | 1.00       | 1.00 | 1.00 | 1.00       | 1.00 | 1.00 |
| Initial Bse:              | 20          | 0    | 41   | 332         | 27   | 290  | 0          | 697  | 45   | 34         | 554  | 592  |
| Added Vol:                | 0           | 0    | 0    | 0           | 0    | 0    | 0          | 0    | 0    | 0          | 0    | 0    |
| PasserByVol:              | 0           | 0    | 0    | 0           | 0    | 0    | 0          | 0    | 0    | 0          | 0    | 0    |
| Initial Fut:              | 20          | 0    | 41   | 332         | 27   | 290  | 0          | 697  | 45   | 34         | 554  | 592  |
| User Adj:                 | 1.00        | 1.00 | 1.00 | 1.00        | 1.00 | 1.00 | 1.00       | 1.00 | 1.00 | 1.00       | 1.00 | 0.00 |
| PHF Adj:                  | 1.00        | 1.00 | 1.00 | 1.00        | 1.00 | 1.00 | 1.00       | 1.00 | 1.00 | 1.00       | 1.00 | 0.00 |
| PHF Volume:               | 20          | 0    | 41   | 332         | 27   | 290  | 0          | 697  | 45   | 34         | 554  | 0    |
| Reduct Vol:               | 0           | 0    | 0    | 0           | 0    | 0    | 0          | 0    | 0    | 0          | 0    | 0    |
| Reduced Vol:              | 20          | 0    | 41   | 332         | 27   | 290  | 0          | 697  | 45   | 34         | 554  | 0    |
| PCE Adj:                  | 1.00        | 1.00 | 1.00 | 1.00        | 1.00 | 1.00 | 1.00       | 1.00 | 1.00 | 1.00       | 1.00 | 0.00 |
| MLF Adj:                  | 1.00        | 1.00 | 1.00 | 1.00        | 1.00 | 1.00 | 1.00       | 1.00 | 1.00 | 1.00       | 1.00 | 0.00 |
| FinalVolume:              | 20          | 0    | 41   | 332         | 27   | 290  | 0          | 697  | 45   | 34         | 554  | 0    |
| Saturation Flow Module:   |             |      |      |             |      |      |            |      |      |            |      |      |
| Sat/Lane:                 | 1900        | 1900 | 1900 | 1900        | 1900 | 1900 | 1900       | 1900 | 1900 | 1900       | 1900 | 1900 |
| Adjustment:               | 0.92        | 0.92 | 0.92 | 0.83        | 0.95 | 0.95 | 0.92       | 1.00 | 0.92 | 0.92       | 1.00 | 0.92 |
| Lanes:                    | 0.33        | 0.00 | 0.67 | 2.00        | 0.09 | 0.91 | 0.00       | 2.00 | 1.00 | 1.00       | 2.00 | 1.00 |
| Final Sat.:               | 574         | 0    | 1176 | 3150        | 153  | 1647 | 0          | 3800 | 1750 | 1750       | 3800 | 1750 |
| Capacity Analysis Module: |             |      |      |             |      |      |            |      |      |            |      |      |
| Vol/Sat:                  | 0.03        | 0.00 | 0.03 | 0.11        | 0.18 | 0.18 | 0.00       | 0.18 | 0.03 | 0.02       | 0.15 | 0.00 |
| Crit Moves:               | ****        |      |      | ****        |      |      | ****       |      |      |            |      |      |
| Green Time:               | 10.7        | 0.0  | 10.7 | 54.0        | 54.0 | 54.0 | 0.0        | 56.3 | 56.3 | 56.3       | 56.3 | 0.0  |
| Volume/Cap:               | 0.42        | 0.00 | 0.42 | 0.25        | 0.42 | 0.42 | 0.00       | 0.42 | 0.06 | 0.04       | 0.34 | 0.00 |
| Delay/Veh:                | 58.7        | 0.0  | 58.7 | 24.9        | 27.3 | 27.3 | 0.0        | 25.8 | 21.5 | 21.3       | 24.6 | 0.0  |
| User DelAdj:              | 1.00        | 1.00 | 1.00 | 1.00        | 1.00 | 1.00 | 1.00       | 1.00 | 1.00 | 1.00       | 1.00 | 1.00 |
| AdjDel/Veh:               | 58.7        | 0.0  | 58.7 | 24.9        | 27.3 | 27.3 | 0.0        | 25.8 | 21.5 | 21.3       | 24.6 | 0.0  |
| LOS by Move:              | E           | A    | E    | C           | C    | C    | A          | C    | C    | C          | C    | A    |
| HCM2k95thQ:               | 6           | 0    | 6    | 10          | 17   | 17   | 0          | 17   | 2    | 2          | 14   | 0    |

Note: Queue reported is the number of cars per lane.

BART

Level Of Service Computation Report  
 2000 HCM Operations (Future Volume Alternative)  
 AM - Bkgrd + Proj Conditions

Intersection #3046: The Alameda/880 SB Ramps [Study Int 56]

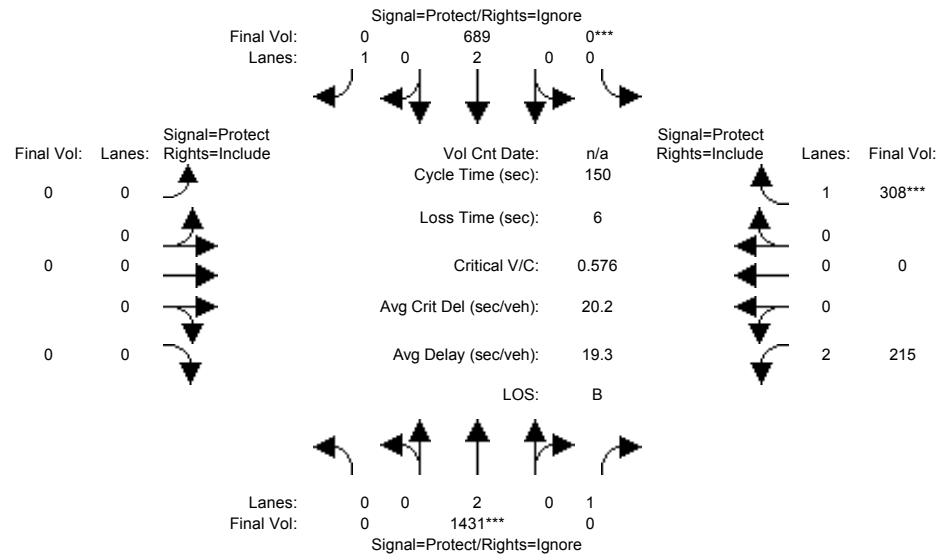

| Approach:                 | North Bound |      |      | South Bound |      |      | East Bound |      |      | West Bound |      |      |
|---------------------------|-------------|------|------|-------------|------|------|------------|------|------|------------|------|------|
| Movement:                 | L           | T    | R    | L           | T    | R    | L          | T    | R    | L          | T    | R    |
| Min. Green:               | 0           | 10   | 10   | 0           | 10   | 10   | 0          | 0    | 0    | 10         | 0    | 10   |
| Y+R:                      | 4.0         | 4.0  | 4.0  | 4.0         | 4.0  | 4.0  | 4.0        | 4.0  | 4.0  | 4.0        | 4.0  | 4.0  |
| Volume Module:            |             |      |      |             |      |      |            |      |      |            |      |      |
| Base Vol:                 | 0           | 1431 | 313  | 0           | 689  | 193  | 0          | 0    | 0    | 215        | 0    | 308  |
| Growth Adj:               | 1.00        | 1.00 | 1.00 | 1.00        | 1.00 | 1.00 | 1.00       | 1.00 | 1.00 | 1.00       | 1.00 | 1.00 |
| Initial Bse:              | 0           | 1431 | 313  | 0           | 689  | 193  | 0          | 0    | 0    | 215        | 0    | 308  |
| Added Vol:                | 0           | 0    | 0    | 0           | 0    | 0    | 0          | 0    | 0    | 0          | 0    | 0    |
| PasserByVol:              | 0           | 0    | 0    | 0           | 0    | 0    | 0          | 0    | 0    | 0          | 0    | 0    |
| Initial Fut:              | 0           | 1431 | 313  | 0           | 689  | 193  | 0          | 0    | 0    | 215        | 0    | 308  |
| User Adj:                 | 1.00        | 1.00 | 0.00 | 1.00        | 1.00 | 0.00 | 1.00       | 1.00 | 1.00 | 1.00       | 1.00 | 1.00 |
| PHF Adj:                  | 1.00        | 1.00 | 0.00 | 1.00        | 1.00 | 0.00 | 1.00       | 1.00 | 1.00 | 1.00       | 1.00 | 1.00 |
| PHF Volume:               | 0           | 1431 | 0    | 0           | 689  | 0    | 0          | 0    | 0    | 215        | 0    | 308  |
| Reduct Vol:               | 0           | 0    | 0    | 0           | 0    | 0    | 0          | 0    | 0    | 0          | 0    | 0    |
| Reduced Vol:              | 0           | 1431 | 0    | 0           | 689  | 0    | 0          | 0    | 0    | 215        | 0    | 308  |
| PCE Adj:                  | 1.00        | 1.00 | 0.00 | 1.00        | 1.00 | 0.00 | 1.00       | 1.00 | 1.00 | 1.00       | 1.00 | 1.00 |
| MLF Adj:                  | 1.00        | 1.00 | 0.00 | 1.00        | 1.00 | 0.00 | 1.00       | 1.00 | 1.00 | 1.00       | 1.00 | 1.00 |
| Final Volume:             | 0           | 1431 | 0    | 0           | 689  | 0    | 0          | 0    | 0    | 215        | 0    | 308  |
| Saturation Flow Module:   |             |      |      |             |      |      |            |      |      |            |      |      |
| Sat/Lane:                 | 1900        | 1900 | 1900 | 1900        | 1900 | 1900 | 1900       | 1900 | 1900 | 1900       | 1900 | 1900 |
| Adjustment:               | 0.92        | 1.00 | 0.92 | 0.92        | 1.00 | 0.92 | 0.92       | 1.00 | 0.92 | 0.83       | 1.00 | 0.92 |
| Lanes:                    | 0.00        | 2.00 | 1.00 | 0.00        | 2.00 | 1.00 | 0.00       | 0.00 | 0.00 | 2.00       | 0.00 | 1.00 |
| Final Sat.:               | 0           | 3800 | 1750 | 0           | 3800 | 1750 | 0          | 0    | 0    | 3150       | 0    | 1750 |
| Capacity Analysis Module: |             |      |      |             |      |      |            |      |      |            |      |      |
| Vol/Sat:                  | 0.00        | 0.38 | 0.00 | 0.00        | 0.18 | 0.00 | 0.00       | 0.00 | 0.00 | 0.07       | 0.00 | 0.18 |
| Crit Moves:               | ****        | **** | **** | ****        | **** | **** | ****       | **** | **** | ****       | **** | **** |
| Green Time:               | 0.0         | 98.1 | 0.0  | 0.0         | 98.1 | 0.0  | 0.0        | 0.0  | 0.0  | 45.9       | 0.0  | 45.9 |
| Volume/Cap:               | 0.00        | 0.58 | 0.00 | 0.00        | 0.28 | 0.00 | 0.00       | 0.00 | 0.00 | 0.22       | 0.00 | 0.58 |
| Delay/Veh:                | 0.0         | 14.7 | 0.0  | 0.0         | 11.0 | 0.0  | 0.0        | 0.0  | 0.0  | 38.9       | 0.0  | 45.4 |
| User DelAdj:              | 1.00        | 1.00 | 1.00 | 1.00        | 1.00 | 1.00 | 1.00       | 1.00 | 1.00 | 1.00       | 1.00 | 1.00 |
| AdjDel/Veh:               | 0.0         | 14.7 | 0.0  | 0.0         | 11.0 | 0.0  | 0.0        | 0.0  | 0.0  | 38.9       | 0.0  | 45.4 |
| LOS by Move:              | A           | B    | A    | A           | B    | A    | A          | A    | A    | D          | A    | D    |
| HCM2k95thQ:               | 0           | 31   | 0    | 0           | 12   | 0    | 0          | 0    | 0    | 9          | 0    | 23   |

Note: Queue reported is the number of cars per lane.

BART

Level Of Service Computation Report  
 2000 HCM Operations (Future Volume Alternative)  
 PM - Bkgrd + Proj Conditions

Intersection #3046: The Alameda/880 SB Ramps [Study Int 56]

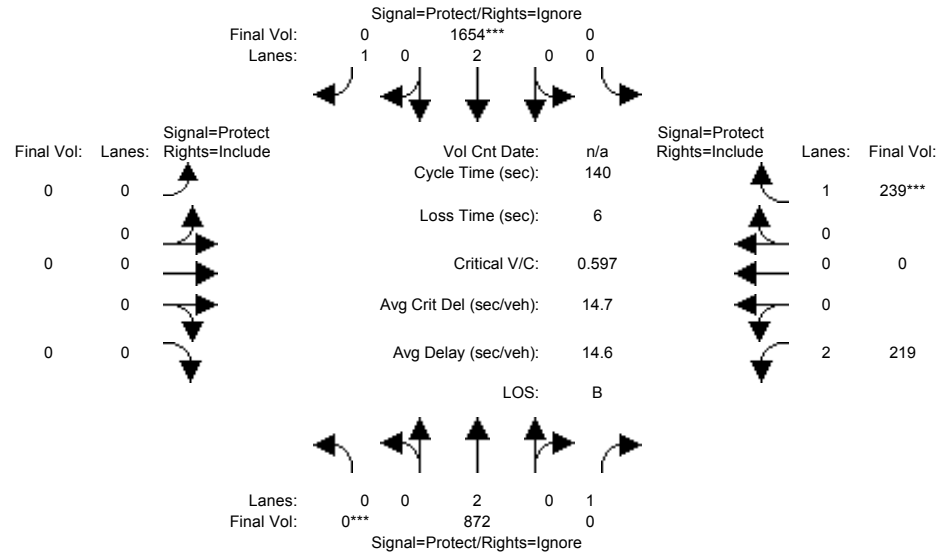

| Approach:                 | North Bound |      |      | South Bound |      |      | East Bound |      |      | West Bound |      |      |
|---------------------------|-------------|------|------|-------------|------|------|------------|------|------|------------|------|------|
| Movement:                 | L           | T    | R    | L           | T    | R    | L          | T    | R    | L          | T    | R    |
| Min. Green:               | 0           | 10   | 10   | 0           | 10   | 10   | 0          | 0    | 0    | 10         | 0    | 10   |
| Y+R:                      | 4.0         | 4.0  | 4.0  | 4.0         | 4.0  | 4.0  | 4.0        | 4.0  | 4.0  | 4.0        | 4.0  | 4.0  |
| Volume Module:            |             |      |      |             |      |      |            |      |      |            |      |      |
| Base Vol:                 | 0           | 872  | 394  | 0           | 1654 | 362  | 0          | 0    | 0    | 219        | 0    | 239  |
| Growth Adj:               | 1.00        | 1.00 | 1.00 | 1.00        | 1.00 | 1.00 | 1.00       | 1.00 | 1.00 | 1.00       | 1.00 | 1.00 |
| Initial Bse:              | 0           | 872  | 394  | 0           | 1654 | 362  | 0          | 0    | 0    | 219        | 0    | 239  |
| Added Vol:                | 0           | 0    | 0    | 0           | 0    | 0    | 0          | 0    | 0    | 0          | 0    | 0    |
| PasserByVol:              | 0           | 0    | 0    | 0           | 0    | 0    | 0          | 0    | 0    | 0          | 0    | 0    |
| Initial Fut:              | 0           | 872  | 394  | 0           | 1654 | 362  | 0          | 0    | 0    | 219        | 0    | 239  |
| User Adj:                 | 1.00        | 1.00 | 0.00 | 1.00        | 1.00 | 0.00 | 1.00       | 1.00 | 1.00 | 1.00       | 1.00 | 1.00 |
| PHF Adj:                  | 1.00        | 1.00 | 0.00 | 1.00        | 1.00 | 0.00 | 1.00       | 1.00 | 1.00 | 1.00       | 1.00 | 1.00 |
| PHF Volume:               | 0           | 872  | 0    | 0           | 1654 | 0    | 0          | 0    | 0    | 219        | 0    | 239  |
| Reduct Vol:               | 0           | 0    | 0    | 0           | 0    | 0    | 0          | 0    | 0    | 0          | 0    | 0    |
| Reduced Vol:              | 0           | 872  | 0    | 0           | 1654 | 0    | 0          | 0    | 0    | 219        | 0    | 239  |
| PCE Adj:                  | 1.00        | 1.00 | 0.00 | 1.00        | 1.00 | 0.00 | 1.00       | 1.00 | 1.00 | 1.00       | 1.00 | 1.00 |
| MLF Adj:                  | 1.00        | 1.00 | 0.00 | 1.00        | 1.00 | 0.00 | 1.00       | 1.00 | 1.00 | 1.00       | 1.00 | 1.00 |
| Final Volume:             | 0           | 872  | 0    | 0           | 1654 | 0    | 0          | 0    | 0    | 219        | 0    | 239  |
| Saturation Flow Module:   |             |      |      |             |      |      |            |      |      |            |      |      |
| Sat/Lane:                 | 1900        | 1900 | 1900 | 1900        | 1900 | 1900 | 1900       | 1900 | 1900 | 1900       | 1900 | 1900 |
| Adjustment:               | 0.92        | 1.00 | 0.92 | 0.92        | 1.00 | 0.92 | 0.92       | 1.00 | 0.92 | 0.83       | 1.00 | 0.92 |
| Lanes:                    | 0.00        | 2.00 | 1.00 | 0.00        | 2.00 | 1.00 | 0.00       | 0.00 | 0.00 | 2.00       | 0.00 | 1.00 |
| Final Sat.:               | 0           | 3800 | 1750 | 0           | 3800 | 1750 | 0          | 0    | 0    | 3150       | 0    | 1750 |
| Capacity Analysis Module: |             |      |      |             |      |      |            |      |      |            |      |      |
| Vol/Sat:                  | 0.00        | 0.23 | 0.00 | 0.00        | 0.44 | 0.00 | 0.00       | 0.00 | 0.00 | 0.07       | 0.00 | 0.14 |
| Crit Moves:               | ****        |      |      | ****        |      |      |            |      |      |            |      | **** |
| Green Time:               | 0.0         | 102  | 0.0  | 0.0         | 102  | 0.0  | 0.0        | 0.0  | 0.0  | 32.0       | 0.0  | 32.0 |
| Volume/Cap:               | 0.00        | 0.31 | 0.00 | 0.00        | 0.60 | 0.00 | 0.00       | 0.00 | 0.00 | 0.30       | 0.00 | 0.60 |
| Delay/Veh:                | 0.0         | 6.8  | 0.0  | 0.0         | 9.5  | 0.0  | 0.0        | 0.0  | 0.0  | 45.0       | 0.0  | 50.7 |
| User DelAdj:              | 1.00        | 1.00 | 1.00 | 1.00        | 1.00 | 1.00 | 1.00       | 1.00 | 1.00 | 1.00       | 1.00 | 1.00 |
| AdjDel/Veh:               | 0.0         | 6.8  | 0.0  | 0.0         | 9.5  | 0.0  | 0.0        | 0.0  | 0.0  | 45.0       | 0.0  | 50.7 |
| LOS by Move:              | A           | A    | A    | A           | A    | A    | A          | A    | A    | D          | A    | D    |
| HCM2k95thQ:               | 0           | 12   | 0    | 0           | 29   | 0    | 0          | 0    | 0    | 9          | 0    | 19   |

Note: Queue reported is the number of cars per lane.

BART

Level Of Service Computation Report  
 2000 HCM Operations (Future Volume Alternative)  
 AM - Bkgrd + Proj Conditions

Intersection #3047: The Alameda/880 NB Ramps [Study Int 57]

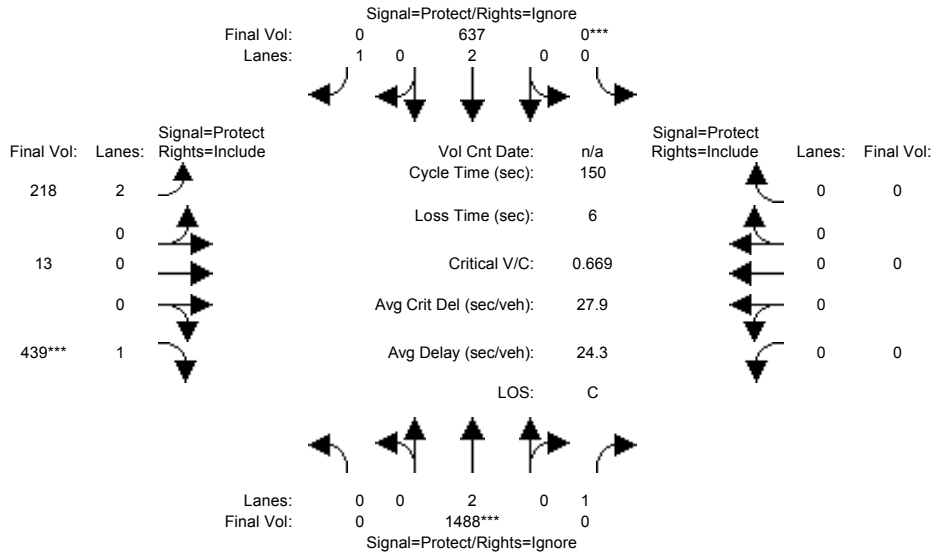

| Approach:                 | North Bound |      |      | South Bound |      |      | East Bound |      |      | West Bound |      |      |
|---------------------------|-------------|------|------|-------------|------|------|------------|------|------|------------|------|------|
| Movement:                 | L           | T    | R    | L           | T    | R    | L          | T    | R    | L          | T    | R    |
| Min. Green:               | 0           | 10   | 10   | 0           | 10   | 10   | 10         | 0    | 10   | 0          | 0    | 0    |
| Y+R:                      | 4.0         | 4.0  | 4.0  | 4.0         | 4.0  | 4.0  | 4.0        | 4.0  | 4.0  | 4.0        | 4.0  | 4.0  |
| Volume Module:            |             |      |      |             |      |      |            |      |      |            |      |      |
| Base Vol:                 | 0           | 1488 | 469  | 0           | 637  | 269  | 218        | 13   | 439  | 0          | 0    | 0    |
| Growth Adj:               | 1.00        | 1.00 | 1.00 | 1.00        | 1.00 | 1.00 | 1.00       | 1.00 | 1.00 | 1.00       | 1.00 | 1.00 |
| Initial Bse:              | 0           | 1488 | 469  | 0           | 637  | 269  | 218        | 13   | 439  | 0          | 0    | 0    |
| Added Vol:                | 0           | 0    | 0    | 0           | 0    | 0    | 0          | 0    | 0    | 0          | 0    | 0    |
| PasserByVol:              | 0           | 0    | 0    | 0           | 0    | 0    | 0          | 0    | 0    | 0          | 0    | 0    |
| Initial Fut:              | 0           | 1488 | 469  | 0           | 637  | 269  | 218        | 13   | 439  | 0          | 0    | 0    |
| User Adj:                 | 1.00        | 1.00 | 0.00 | 1.00        | 1.00 | 0.00 | 1.00       | 1.00 | 1.00 | 1.00       | 1.00 | 1.00 |
| PHF Adj:                  | 1.00        | 1.00 | 0.00 | 1.00        | 1.00 | 0.00 | 1.00       | 1.00 | 1.00 | 1.00       | 1.00 | 1.00 |
| PHF Volume:               | 0           | 1488 | 0    | 0           | 637  | 0    | 218        | 13   | 439  | 0          | 0    | 0    |
| Reduct Vol:               | 0           | 0    | 0    | 0           | 0    | 0    | 0          | 0    | 0    | 0          | 0    | 0    |
| Reduced Vol:              | 0           | 1488 | 0    | 0           | 637  | 0    | 218        | 13   | 439  | 0          | 0    | 0    |
| PCE Adj:                  | 1.00        | 1.00 | 0.00 | 1.00        | 1.00 | 0.00 | 1.00       | 1.00 | 1.00 | 1.00       | 1.00 | 1.00 |
| MLF Adj:                  | 1.00        | 1.00 | 0.00 | 1.00        | 1.00 | 0.00 | 1.00       | 1.00 | 1.00 | 1.00       | 1.00 | 1.00 |
| Final Volume:             | 0           | 1488 | 0    | 0           | 637  | 0    | 218        | 13   | 439  | 0          | 0    | 0    |
| Saturation Flow Module:   |             |      |      |             |      |      |            |      |      |            |      |      |
| Sat/Lane:                 | 1900        | 1900 | 1900 | 1900        | 1900 | 1900 | 1900       | 1900 | 1900 | 1900       | 1900 | 1900 |
| Adjustment:               | 0.92        | 1.00 | 0.92 | 0.92        | 1.00 | 0.92 | 0.92       | 1.00 | 0.92 | 0.92       | 1.00 | 0.92 |
| Lanes:                    | 0.00        | 2.00 | 1.00 | 0.00        | 2.00 | 1.00 | 1.90       | 0.10 | 1.00 | 0.00       | 0.00 | 0.00 |
| Final Sat.:               | 0           | 3800 | 1750 | 0           | 3800 | 1750 | 3318       | 198  | 1750 | 0          | 0    | 0    |
| Capacity Analysis Module: |             |      |      |             |      |      |            |      |      |            |      |      |
| Vol/Sat:                  | 0.00        | 0.39 | 0.00 | 0.00        | 0.17 | 0.00 | 0.07       | 0.07 | 0.25 | 0.00       | 0.00 | 0.00 |
| Crit Moves:               | ****        | **** | **** | ****        | **** | **** | ****       | **** | **** | ****       | **** | **** |
| Green Time:               | 0.0         | 87.8 | 0.0  | 0.0         | 87.8 | 0.0  | 56.2       | 56.2 | 56.2 | 0.0        | 0.0  | 0.0  |
| Volume/Cap:               | 0.00        | 0.67 | 0.00 | 0.00        | 0.29 | 0.00 | 0.18       | 0.18 | 0.67 | 0.00       | 0.00 | 0.00 |
| Delay/Veh:                | 0.0         | 22.0 | 0.0  | 0.0         | 15.6 | 0.0  | 31.4       | 31.4 | 40.9 | 0.0        | 0.0  | 0.0  |
| User DelAdj:              | 1.00        | 1.00 | 1.00 | 1.00        | 1.00 | 1.00 | 1.00       | 1.00 | 1.00 | 1.00       | 1.00 | 1.00 |
| AdjDel/Veh:               | 0.0         | 22.0 | 0.0  | 0.0         | 15.6 | 0.0  | 31.4       | 31.4 | 40.9 | 0.0        | 0.0  | 0.0  |
| LOS by Move:              | A           | C    | A    | A           | B    | A    | C          | C    | D    | A          | A    | A    |
| HCM2k95thQ:               | 0           | 38   | 0    | 0           | 13   | 0    | 7          | 7    | 32   | 0          | 0    | 0    |

Note: Queue reported is the number of cars per lane.



BART

Level Of Service Computation Report  
 2000 HCM Operations (Future Volume Alternative)  
 PM - Bkgrd + Proj Conditions

Intersection #3047: The Alameda/880 NB Ramps [Study Int 57]

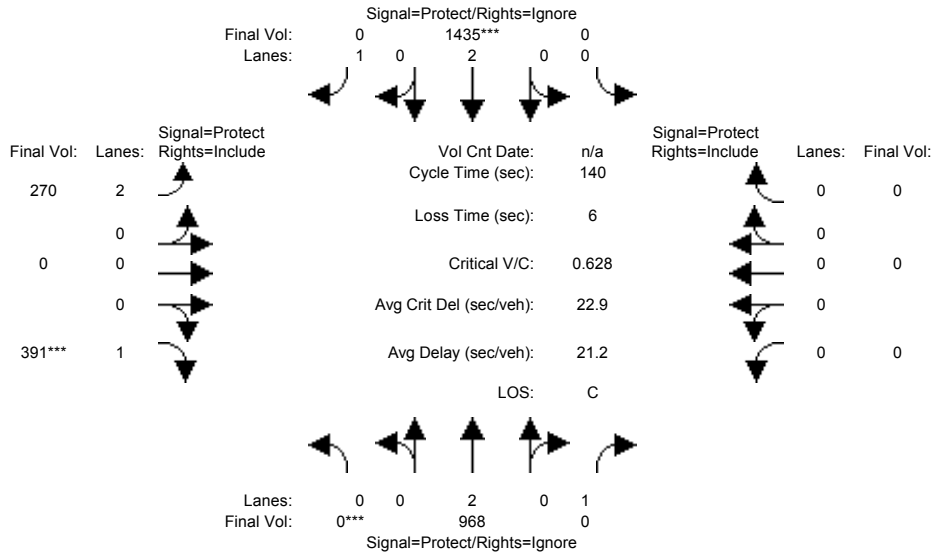

| Approach:                 | North Bound |      |      | South Bound |      |      | East Bound |      |      | West Bound |      |      |
|---------------------------|-------------|------|------|-------------|------|------|------------|------|------|------------|------|------|
| Movement:                 | L           | T    | R    | L           | T    | R    | L          | T    | R    | L          | T    | R    |
| Min. Green:               | 0           | 10   | 10   | 0           | 10   | 10   | 10         | 0    | 10   | 0          | 0    | 0    |
| Y+R:                      | 4.0         | 4.0  | 4.0  | 4.0         | 4.0  | 4.0  | 4.0        | 4.0  | 4.0  | 4.0        | 4.0  | 4.0  |
| Volume Module:            |             |      |      |             |      |      |            |      |      |            |      |      |
| Base Vol:                 | 0           | 968  | 225  | 0           | 1435 | 466  | 270        | 0    | 391  | 0          | 0    | 0    |
| Growth Adj:               | 1.00        | 1.00 | 1.00 | 1.00        | 1.00 | 1.00 | 1.00       | 1.00 | 1.00 | 1.00       | 1.00 | 1.00 |
| Initial Bse:              | 0           | 968  | 225  | 0           | 1435 | 466  | 270        | 0    | 391  | 0          | 0    | 0    |
| Added Vol:                | 0           | 0    | 0    | 0           | 0    | 0    | 0          | 0    | 0    | 0          | 0    | 0    |
| PasserByVol:              | 0           | 0    | 0    | 0           | 0    | 0    | 0          | 0    | 0    | 0          | 0    | 0    |
| Initial Fut:              | 0           | 968  | 225  | 0           | 1435 | 466  | 270        | 0    | 391  | 0          | 0    | 0    |
| User Adj:                 | 1.00        | 1.00 | 0.00 | 1.00        | 1.00 | 0.00 | 1.00       | 1.00 | 1.00 | 1.00       | 1.00 | 1.00 |
| PHF Adj:                  | 1.00        | 1.00 | 0.00 | 1.00        | 1.00 | 0.00 | 1.00       | 1.00 | 1.00 | 1.00       | 1.00 | 1.00 |
| PHF Volume:               | 0           | 968  | 0    | 0           | 1435 | 0    | 270        | 0    | 391  | 0          | 0    | 0    |
| Reduct Vol:               | 0           | 0    | 0    | 0           | 0    | 0    | 0          | 0    | 0    | 0          | 0    | 0    |
| Reduced Vol:              | 0           | 968  | 0    | 0           | 1435 | 0    | 270        | 0    | 391  | 0          | 0    | 0    |
| PCE Adj:                  | 1.00        | 1.00 | 0.00 | 1.00        | 1.00 | 0.00 | 1.00       | 1.00 | 1.00 | 1.00       | 1.00 | 1.00 |
| MLF Adj:                  | 1.00        | 1.00 | 0.00 | 1.00        | 1.00 | 0.00 | 1.00       | 1.00 | 1.00 | 1.00       | 1.00 | 1.00 |
| FinalVolume:              | 0           | 968  | 0    | 0           | 1435 | 0    | 270        | 0    | 391  | 0          | 0    | 0    |
| Saturation Flow Module:   |             |      |      |             |      |      |            |      |      |            |      |      |
| Sat/Lane:                 | 1900        | 1900 | 1900 | 1900        | 1900 | 1900 | 1900       | 1900 | 1900 | 1900       | 1900 | 1900 |
| Adjustment:               | 0.92        | 1.00 | 0.92 | 0.92        | 1.00 | 0.92 | 0.83       | 1.00 | 0.92 | 0.92       | 1.00 | 0.92 |
| Lanes:                    | 0.00        | 2.00 | 1.00 | 0.00        | 2.00 | 1.00 | 2.00       | 0.00 | 1.00 | 0.00       | 0.00 | 0.00 |
| Final Sat.:               | 0           | 3800 | 1750 | 0           | 3800 | 1750 | 3150       | 0    | 1750 | 0          | 0    | 0    |
| Capacity Analysis Module: |             |      |      |             |      |      |            |      |      |            |      |      |
| Vol/Sat:                  | 0.00        | 0.25 | 0.00 | 0.00        | 0.38 | 0.00 | 0.09       | 0.00 | 0.22 | 0.00       | 0.00 | 0.00 |
| Crit Moves:               | ****        |      |      | ****        |      |      | ****       |      |      | ****       |      |      |
| Green Time:               | 0.0         | 84.2 | 0.0  | 0.0         | 84.2 | 0.0  | 49.8       | 0.0  | 49.8 | 0.0        | 0.0  | 0.0  |
| Volume/Cap:               | 0.00        | 0.42 | 0.00 | 0.00        | 0.63 | 0.00 | 0.24       | 0.00 | 0.63 | 0.00       | 0.00 | 0.00 |
| Delay/Veh:                | 0.0         | 15.1 | 0.0  | 0.0         | 18.4 | 0.0  | 31.9       | 0.0  | 39.5 | 0.0        | 0.0  | 0.0  |
| User DelAdj:              | 1.00        | 1.00 | 1.00 | 1.00        | 1.00 | 1.00 | 1.00       | 1.00 | 1.00 | 1.00       | 1.00 | 1.00 |
| AdjDel/Veh:               | 0.0         | 15.1 | 0.0  | 0.0         | 18.4 | 0.0  | 31.9       | 0.0  | 39.5 | 0.0        | 0.0  | 0.0  |
| LOS by Move:              | A           | B    | A    | A           | B    | A    | C          | A    | D    | A          | A    | A    |
| HCM2k95thQ:               | 0           | 20   | 0    | 0           | 33   | 0    | 9          | 0    | 27   | 0          | 0    | 0    |

Note: Queue reported is the number of cars per lane.

BART

Level Of Service Computation Report  
 2000 HCM Operations (Future Volume Alternative)  
 AM - Bkgrd + Proj Conditions

Intersection #3052: 880 SB Ramps/Coleman [Study Int 36]

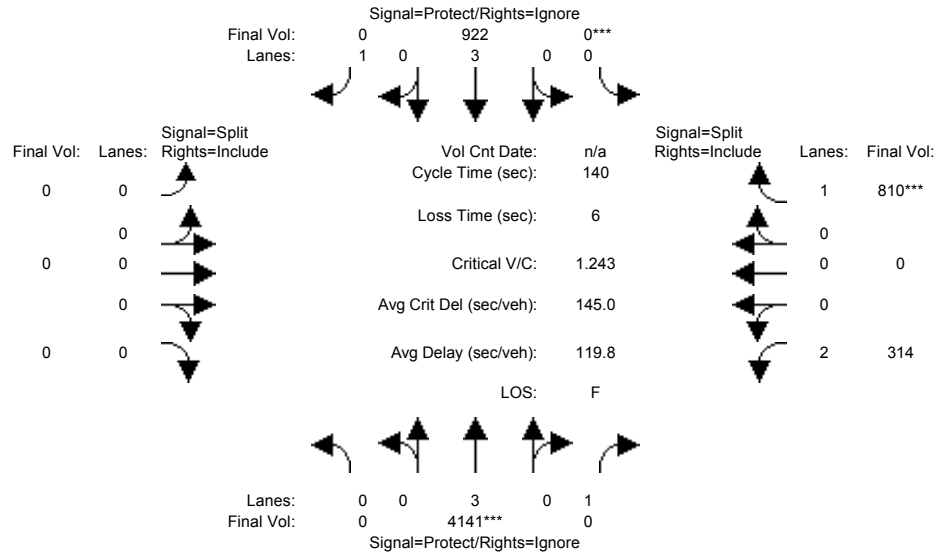

| Approach:                 | North Bound |      |      | South Bound |      |      | East Bound |      |      | West Bound |      |       |
|---------------------------|-------------|------|------|-------------|------|------|------------|------|------|------------|------|-------|
| Movement:                 | L           | T    | R    | L           | T    | R    | L          | T    | R    | L          | T    | R     |
| Min. Green:               | 0           | 10   | 10   | 0           | 10   | 10   | 0          | 0    | 0    | 10         | 0    | 10    |
| Y+R:                      | 4.0         | 4.0  | 4.0  | 4.0         | 4.0  | 4.0  | 4.0        | 4.0  | 4.0  | 4.0        | 4.0  | 4.0   |
| Volume Module:            |             |      |      |             |      |      |            |      |      |            |      |       |
| Base Vol:                 | 0           | 4141 | 179  | 0           | 922  | 193  | 0          | 0    | 0    | 314        | 0    | 810   |
| Growth Adj:               | 1.00        | 1.00 | 1.00 | 1.00        | 1.00 | 1.00 | 1.00       | 1.00 | 1.00 | 1.00       | 1.00 | 1.00  |
| Initial Bse:              | 0           | 4141 | 179  | 0           | 922  | 193  | 0          | 0    | 0    | 314        | 0    | 810   |
| Added Vol:                | 0           | 0    | 0    | 0           | 0    | 0    | 0          | 0    | 0    | 0          | 0    | 0     |
| PasserByVol:              | 0           | 0    | 0    | 0           | 0    | 0    | 0          | 0    | 0    | 0          | 0    | 0     |
| Initial Fut:              | 0           | 4141 | 179  | 0           | 922  | 193  | 0          | 0    | 0    | 314        | 0    | 810   |
| User Adj:                 | 1.00        | 1.00 | 0.00 | 1.00        | 1.00 | 0.00 | 1.00       | 1.00 | 1.00 | 1.00       | 1.00 | 1.00  |
| PHF Adj:                  | 1.00        | 1.00 | 0.00 | 1.00        | 1.00 | 0.00 | 1.00       | 1.00 | 1.00 | 1.00       | 1.00 | 1.00  |
| PHF Volume:               | 0           | 4141 | 0    | 0           | 922  | 0    | 0          | 0    | 0    | 314        | 0    | 810   |
| Reduct Vol:               | 0           | 0    | 0    | 0           | 0    | 0    | 0          | 0    | 0    | 0          | 0    | 0     |
| Reduced Vol:              | 0           | 4141 | 0    | 0           | 922  | 0    | 0          | 0    | 0    | 314        | 0    | 810   |
| PCE Adj:                  | 1.00        | 1.00 | 0.00 | 1.00        | 1.00 | 0.00 | 1.00       | 1.00 | 1.00 | 1.00       | 1.00 | 1.00  |
| MLF Adj:                  | 1.00        | 1.00 | 0.00 | 1.00        | 1.00 | 0.00 | 1.00       | 1.00 | 1.00 | 1.00       | 1.00 | 1.00  |
| Final Volume:             | 0           | 4141 | 0    | 0           | 922  | 0    | 0          | 0    | 0    | 314        | 0    | 810   |
| Saturation Flow Module:   |             |      |      |             |      |      |            |      |      |            |      |       |
| Sat/Lane:                 | 1900        | 1900 | 1900 | 1900        | 1900 | 1900 | 1900       | 1900 | 1900 | 1900       | 1900 | 1900  |
| Adjustment:               | 0.92        | 1.00 | 0.92 | 0.92        | 1.00 | 0.92 | 0.92       | 1.00 | 0.92 | 0.83       | 1.00 | 0.92  |
| Lanes:                    | 0.00        | 3.00 | 1.00 | 0.00        | 3.00 | 1.00 | 0.00       | 0.00 | 0.00 | 2.00       | 0.00 | 1.00  |
| Final Sat.:               | 0           | 5700 | 1750 | 0           | 5700 | 1750 | 0          | 0    | 0    | 3150       | 0    | 1750  |
| Capacity Analysis Module: |             |      |      |             |      |      |            |      |      |            |      |       |
| Vol/Sat:                  | 0.00        | 0.73 | 0.00 | 0.00        | 0.16 | 0.00 | 0.00       | 0.00 | 0.00 | 0.10       | 0.00 | 0.46  |
| Crit Moves:               | ****        | **** | **** | ****        | **** | **** | ****       | **** | **** | ****       | **** | ****  |
| Green Time:               | 0.0         | 81.9 | 0.0  | 0.0         | 81.9 | 0.0  | 0.0        | 0.0  | 0.0  | 52.1       | 0.0  | 52.1  |
| Volume/Cap:               | 0.00        | 1.24 | 0.00 | 0.00        | 0.28 | 0.00 | 0.00       | 0.00 | 0.00 | 0.27       | 0.00 | 1.24  |
| Delay/Veh:                | 0.0         | 141  | 0.0  | 0.0         | 14.5 | 0.0  | 0.0        | 0.0  | 0.0  | 30.7       | 0.0  | 165.8 |
| User DelAdj:              | 1.00        | 1.00 | 1.00 | 1.00        | 1.00 | 1.00 | 1.00       | 1.00 | 1.00 | 1.00       | 1.00 | 1.00  |
| AdjDel/Veh:               | 0.0         | 141  | 0.0  | 0.0         | 14.5 | 0.0  | 0.0        | 0.0  | 0.0  | 30.7       | 0.0  | 165.8 |
| LOS by Move:              | A           | F    | A    | A           | B    | A    | A          | A    | A    | C          | A    | F     |
| HCM2k95thQ:               | 0           | 138  | 0    | 0           | 12   | 0    | 0          | 0    | 0    | 11         | 0    | 91    |

Note: Queue reported is the number of cars per lane.

BART

Level Of Service Computation Report  
 2000 HCM Operations (Future Volume Alternative)  
 PM - Bkgrd + Proj Conditions

Intersection #3052: 880 SB Ramps/Coleman [Study Int 36]

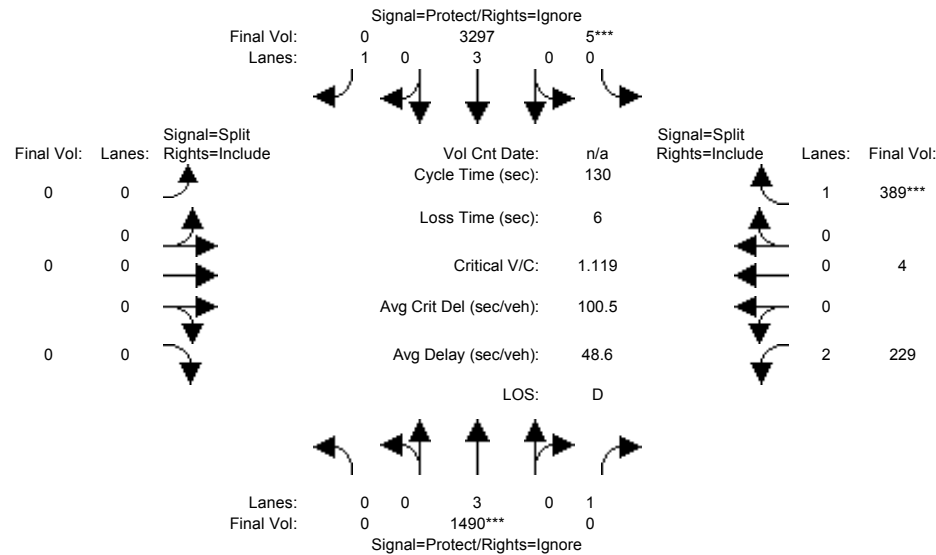

| Approach:                 | North Bound |      |      | South Bound |      |      | East Bound |      |      | West Bound |      |       |
|---------------------------|-------------|------|------|-------------|------|------|------------|------|------|------------|------|-------|
| Movement:                 | L           | T    | R    | L           | T    | R    | L          | T    | R    | L          | T    | R     |
| Min. Green:               | 0           | 10   | 10   | 0           | 10   | 10   | 0          | 0    | 0    | 10         | 0    | 10    |
| Y+R:                      | 4.0         | 4.0  | 4.0  | 4.0         | 4.0  | 4.0  | 4.0        | 4.0  | 4.0  | 4.0        | 4.0  | 4.0   |
| Volume Module:            |             |      |      |             |      |      |            |      |      |            |      |       |
| Base Vol:                 | 0           | 1490 | 301  | 5           | 3297 | 773  | 0          | 0    | 0    | 229        | 4    | 389   |
| Growth Adj:               | 1.00        | 1.00 | 1.00 | 1.00        | 1.00 | 1.00 | 1.00       | 1.00 | 1.00 | 1.00       | 1.00 | 1.00  |
| Initial Bse:              | 0           | 1490 | 301  | 5           | 3297 | 773  | 0          | 0    | 0    | 229        | 4    | 389   |
| Added Vol:                | 0           | 0    | 0    | 0           | 0    | 0    | 0          | 0    | 0    | 0          | 0    | 0     |
| PasserByVol:              | 0           | 0    | 0    | 0           | 0    | 0    | 0          | 0    | 0    | 0          | 0    | 0     |
| Initial Fut:              | 0           | 1490 | 301  | 5           | 3297 | 773  | 0          | 0    | 0    | 229        | 4    | 389   |
| User Adj:                 | 1.00        | 1.00 | 0.00 | 1.00        | 1.00 | 0.00 | 1.00       | 1.00 | 1.00 | 1.00       | 1.00 | 1.00  |
| PHF Adj:                  | 1.00        | 1.00 | 0.00 | 1.00        | 1.00 | 0.00 | 1.00       | 1.00 | 1.00 | 1.00       | 1.00 | 1.00  |
| PHF Volume:               | 0           | 1490 | 0    | 5           | 3297 | 0    | 0          | 0    | 0    | 229        | 4    | 389   |
| Reduct Vol:               | 0           | 0    | 0    | 0           | 0    | 0    | 0          | 0    | 0    | 0          | 0    | 0     |
| Reduced Vol:              | 0           | 1490 | 0    | 5           | 3297 | 0    | 0          | 0    | 0    | 229        | 4    | 389   |
| PCE Adj:                  | 1.00        | 1.00 | 0.00 | 1.00        | 1.00 | 0.00 | 1.00       | 1.00 | 1.00 | 1.00       | 1.00 | 1.00  |
| MLF Adj:                  | 1.00        | 1.00 | 0.00 | 1.00        | 1.00 | 0.00 | 1.00       | 1.00 | 1.00 | 1.00       | 1.00 | 1.00  |
| Final Volume:             | 0           | 1490 | 0    | 5           | 3297 | 0    | 0          | 0    | 0    | 229        | 4    | 389   |
| Saturation Flow Module:   |             |      |      |             |      |      |            |      |      |            |      |       |
| Sat/Lane:                 | 1900        | 1900 | 1900 | 1900        | 1900 | 1900 | 1900       | 1900 | 1900 | 1900       | 1900 | 1900  |
| Adjustment:               | 0.92        | 1.00 | 0.92 | 0.95        | 0.98 | 0.92 | 0.92       | 1.00 | 0.92 | 0.92       | 0.95 | 0.95  |
| Lanes:                    | 0.00        | 3.00 | 1.00 | 0.01        | 2.99 | 1.00 | 0.00       | 0.00 | 0.00 | 1.97       | 0.03 | 1.00  |
| Final Sat.:               | 0           | 5700 | 1750 | 8           | 5592 | 1750 | 0          | 0    | 0    | 3451       | 60   | 1800  |
| Capacity Analysis Module: |             |      |      |             |      |      |            |      |      |            |      |       |
| Vol/Sat:                  | 0.00        | 0.26 | 0.00 | 0.59        | 0.59 | 0.00 | 0.00       | 0.00 | 0.00 | 0.07       | 0.07 | 0.22  |
| Crit Moves:               | ****        | **** | **** | ****        | **** | **** | ****       | **** | **** | ****       | **** |       |
| Green Time:               | 0.0         | 30.4 | 0.0  | 68.5        | 98.9 | 0.0  | 0.0        | 0.0  | 0.0  | 25.1       | 25.1 | 25.1  |
| Volume/Cap:               | 0.00        | 1.12 | 0.00 | 1.12        | 0.78 | 0.00 | 0.00       | 0.00 | 0.00 | 0.34       | 0.34 | 1.12  |
| Delay/Veh:                | 0.0         | 114  | 0.0  | 89.4        | 10.0 | 0.0  | 0.0        | 0.0  | 0.0  | 45.4       | 45.4 | 127.6 |
| User DelAdj:              | 1.00        | 1.00 | 1.00 | 1.00        | 1.00 | 1.00 | 1.00       | 1.00 | 1.00 | 1.00       | 1.00 | 1.00  |
| AdjDel/Veh:               | 0.0         | 114  | 0.0  | 89.4        | 10.0 | 0.0  | 0.0        | 0.0  | 0.0  | 45.4       | 45.4 | 127.6 |
| LOS by Move:              | A           | F    | A    | F           | B    | A    | A          | A    | A    | D          | D    | F     |
| HCM2k95thQ:               | 0           | 48   | 0    | 93          | 44   | 0    | 0          | 0    | 0    | 9          | 9    | 42    |

Note: Queue reported is the number of cars per lane.

BART

Level Of Service Computation Report  
 2000 HCM Operations (Future Volume Alternative)  
 AM - Bkgrd + Proj Conditions

Intersection #3053: 880 NB Ramps/Coleman [Study Int 37]

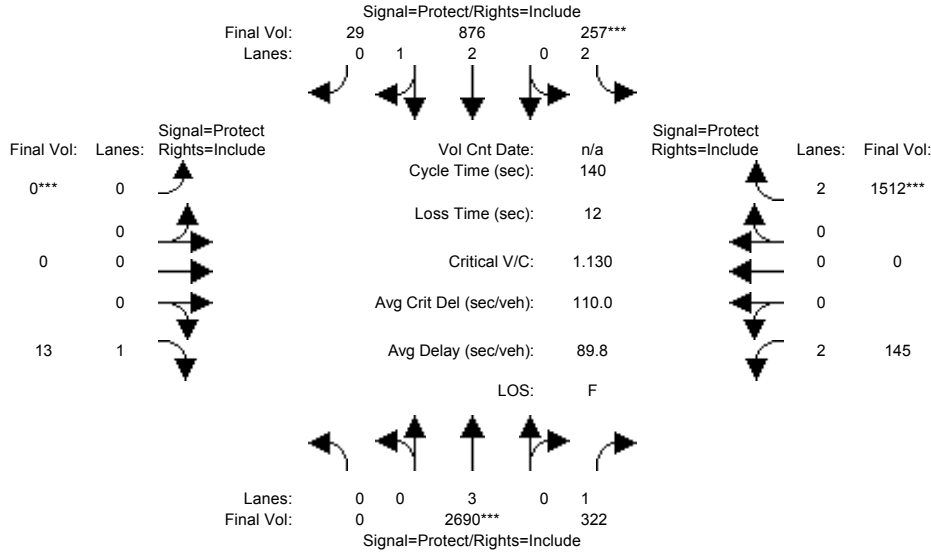

| Approach:                 | North Bound |      |      | South Bound |      |      | East Bound |      |      | West Bound |      |       |
|---------------------------|-------------|------|------|-------------|------|------|------------|------|------|------------|------|-------|
| Movement:                 | L           | T    | R    | L           | T    | R    | L          | T    | R    | L          | T    | R     |
| Min. Green:               | 0           | 10   | 10   | 7           | 10   | 10   | 0          | 0    | 10   | 10         | 0    | 10    |
| Y+R:                      | 4.0         | 4.0  | 4.0  | 4.0         | 4.0  | 4.0  | 4.0        | 4.0  | 4.0  | 4.0        | 4.0  | 4.0   |
| Volume Module:            |             |      |      |             |      |      |            |      |      |            |      |       |
| Base Vol:                 | 0           | 2690 | 322  | 257         | 876  | 29   | 0          | 0    | 13   | 145        | 0    | 1512  |
| Growth Adj:               | 1.00        | 1.00 | 1.00 | 1.00        | 1.00 | 1.00 | 1.00       | 1.00 | 1.00 | 1.00       | 1.00 | 1.00  |
| Initial Bse:              | 0           | 2690 | 322  | 257         | 876  | 29   | 0          | 0    | 13   | 145        | 0    | 1512  |
| Added Vol:                | 0           | 0    | 0    | 0           | 0    | 0    | 0          | 0    | 0    | 0          | 0    | 0     |
| PasserByVol:              | 0           | 0    | 0    | 0           | 0    | 0    | 0          | 0    | 0    | 0          | 0    | 0     |
| Initial Fut:              | 0           | 2690 | 322  | 257         | 876  | 29   | 0          | 0    | 13   | 145        | 0    | 1512  |
| User Adj:                 | 1.00        | 1.00 | 1.00 | 1.00        | 1.00 | 1.00 | 1.00       | 1.00 | 1.00 | 1.00       | 1.00 | 1.00  |
| PHF Adj:                  | 1.00        | 1.00 | 1.00 | 1.00        | 1.00 | 1.00 | 1.00       | 1.00 | 1.00 | 1.00       | 1.00 | 1.00  |
| PHF Volume:               | 0           | 2690 | 322  | 257         | 876  | 29   | 0          | 0    | 13   | 145        | 0    | 1512  |
| Reduct Vol:               | 0           | 0    | 0    | 0           | 0    | 0    | 0          | 0    | 0    | 0          | 0    | 0     |
| Reduced Vol:              | 0           | 2690 | 322  | 257         | 876  | 29   | 0          | 0    | 13   | 145        | 0    | 1512  |
| PCE Adj:                  | 1.00        | 1.00 | 1.00 | 1.00        | 1.00 | 1.00 | 1.00       | 1.00 | 1.00 | 1.00       | 1.00 | 1.00  |
| MLF Adj:                  | 1.00        | 1.00 | 1.00 | 1.00        | 1.00 | 1.00 | 1.00       | 1.00 | 1.00 | 1.00       | 1.00 | 1.00  |
| Final Volume:             | 0           | 2690 | 322  | 257         | 876  | 29   | 0          | 0    | 13   | 145        | 0    | 1512  |
| Saturation Flow Module:   |             |      |      |             |      |      |            |      |      |            |      |       |
| Sat/Lane:                 | 1900        | 1900 | 1900 | 1900        | 1900 | 1900 | 1900       | 1900 | 1900 | 1900       | 1900 | 1900  |
| Adjustment:               | 0.92        | 1.00 | 0.92 | 0.83        | 0.98 | 0.95 | 0.92       | 1.00 | 0.92 | 0.83       | 1.00 | 0.83  |
| Lanes:                    | 0.00        | 3.00 | 1.00 | 2.00        | 2.90 | 0.10 | 0.00       | 0.00 | 1.00 | 2.00       | 0.00 | 2.00  |
| Final Sat.:               | 0           | 5700 | 1750 | 3150        | 5420 | 179  | 0          | 0    | 1750 | 3150       | 0    | 3150  |
| Capacity Analysis Module: |             |      |      |             |      |      |            |      |      |            |      |       |
| Vol/Sat:                  | 0.00        | 0.47 | 0.18 | 0.08        | 0.16 | 0.16 | 0.00       | 0.00 | 0.01 | 0.05       | 0.00 | 0.48  |
| Crit Moves:               | ****        | **** | **** | ****        | **** | **** | ****       | **** | **** | ****       | **** | ****  |
| Green Time:               | 0.0         | 58.4 | 58.4 | 10.1        | 68.6 | 68.6 | 0.0        | 0.0  | 5.6  | 53.8       | 0.0  | 59.4  |
| Volume/Cap:               | 0.00        | 1.13 | 0.44 | 1.13        | 0.33 | 0.33 | 0.00       | 0.00 | 0.19 | 0.12       | 0.00 | 1.13  |
| Delay/Veh:                | 0.0         | 105  | 29.5 | 164.2       | 21.8 | 21.8 | 0.0        | 0.0  | 66.3 | 27.8       | 0.0  | 108.9 |
| User DelAdj:              | 1.00        | 1.00 | 1.00 | 1.00        | 1.00 | 1.00 | 1.00       | 1.00 | 1.00 | 1.00       | 1.00 | 1.00  |
| AdjDel/Veh:               | 0.0         | 105  | 29.5 | 164.2       | 21.8 | 21.8 | 0.0        | 0.0  | 66.3 | 27.8       | 0.0  | 108.9 |
| LOS by Move:              | A           | F    | C    | F           | C    | C    | A          | A    | E    | C          | A    | F     |
| HCM2k95thQ:               | 0           | 77   | 18   | 21          | 15   | 15   | 0          | 0    | 2    | 5          | 0    | 83    |

Note: Queue reported is the number of cars per lane.

BART

Level Of Service Computation Report  
 2000 HCM Operations (Future Volume Alternative)  
 PM - Bkgrd + Proj Conditions

Intersection #3053: 880 NB Ramps/Coleman [Study Int 37]

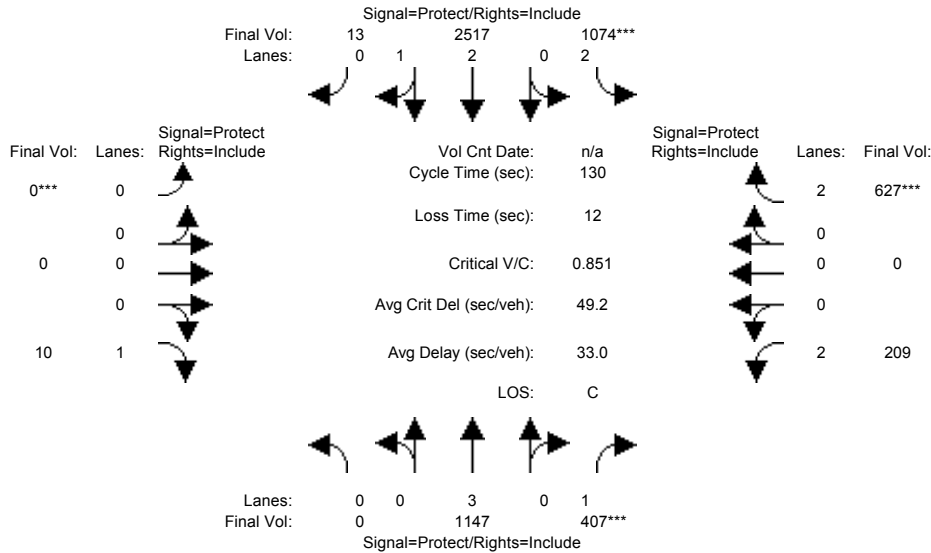

| Approach:                 | North Bound |      |      | South Bound |      |      | East Bound |      |      | West Bound |      |      |
|---------------------------|-------------|------|------|-------------|------|------|------------|------|------|------------|------|------|
| Movement:                 | L           | T    | R    | L           | T    | R    | L          | T    | R    | L          | T    | R    |
| Min. Green:               | 0           | 10   | 10   | 7           | 10   | 10   | 0          | 0    | 10   | 10         | 0    | 10   |
| Y+R:                      | 4.0         | 4.0  | 4.0  | 4.0         | 4.0  | 4.0  | 4.0        | 4.0  | 4.0  | 4.0        | 4.0  | 4.0  |
| Volume Module:            |             |      |      |             |      |      |            |      |      |            |      |      |
| Base Vol:                 | 0           | 1147 | 407  | 1074        | 2517 | 13   | 0          | 0    | 10   | 209        | 0    | 627  |
| Growth Adj:               | 1.00        | 1.00 | 1.00 | 1.00        | 1.00 | 1.00 | 1.00       | 1.00 | 1.00 | 1.00       | 1.00 | 1.00 |
| Initial Bse:              | 0           | 1147 | 407  | 1074        | 2517 | 13   | 0          | 0    | 10   | 209        | 0    | 627  |
| Added Vol:                | 0           | 0    | 0    | 0           | 0    | 0    | 0          | 0    | 0    | 0          | 0    | 0    |
| PasserByVol:              | 0           | 0    | 0    | 0           | 0    | 0    | 0          | 0    | 0    | 0          | 0    | 0    |
| Initial Fut:              | 0           | 1147 | 407  | 1074        | 2517 | 13   | 0          | 0    | 10   | 209        | 0    | 627  |
| User Adj:                 | 1.00        | 1.00 | 1.00 | 1.00        | 1.00 | 1.00 | 1.00       | 1.00 | 1.00 | 1.00       | 1.00 | 1.00 |
| PHF Adj:                  | 1.00        | 1.00 | 1.00 | 1.00        | 1.00 | 1.00 | 1.00       | 1.00 | 1.00 | 1.00       | 1.00 | 1.00 |
| PHF Volume:               | 0           | 1147 | 407  | 1074        | 2517 | 13   | 0          | 0    | 10   | 209        | 0    | 627  |
| Reduct Vol:               | 0           | 0    | 0    | 0           | 0    | 0    | 0          | 0    | 0    | 0          | 0    | 0    |
| Reduced Vol:              | 0           | 1147 | 407  | 1074        | 2517 | 13   | 0          | 0    | 10   | 209        | 0    | 627  |
| PCE Adj:                  | 1.00        | 1.00 | 1.00 | 1.00        | 1.00 | 1.00 | 1.00       | 1.00 | 1.00 | 1.00       | 1.00 | 1.00 |
| MLF Adj:                  | 1.00        | 1.00 | 1.00 | 1.00        | 1.00 | 1.00 | 1.00       | 1.00 | 1.00 | 1.00       | 1.00 | 1.00 |
| Final Volume:             | 0           | 1147 | 407  | 1074        | 2517 | 13   | 0          | 0    | 10   | 209        | 0    | 627  |
| Saturation Flow Module:   |             |      |      |             |      |      |            |      |      |            |      |      |
| Sat/Lane:                 | 1900        | 1900 | 1900 | 1900        | 1900 | 1900 | 1900       | 1900 | 1900 | 1900       | 1900 | 1900 |
| Adjustment:               | 0.92        | 1.00 | 0.92 | 0.83        | 0.98 | 0.95 | 0.92       | 1.00 | 0.92 | 0.83       | 1.00 | 0.83 |
| Lanes:                    | 0.00        | 3.00 | 1.00 | 2.00        | 2.98 | 0.02 | 0.00       | 0.00 | 1.00 | 2.00       | 0.00 | 2.00 |
| Final Sat.:               | 0           | 5700 | 1750 | 3150        | 5571 | 29   | 0          | 0    | 1750 | 3150       | 0    | 3150 |
| Capacity Analysis Module: |             |      |      |             |      |      |            |      |      |            |      |      |
| Vol/Sat:                  | 0.00        | 0.20 | 0.23 | 0.34        | 0.45 | 0.45 | 0.00       | 0.00 | 0.01 | 0.07       | 0.00 | 0.20 |
| Crit Moves:               | 0.0         | 35.5 | 35.5 | 52.1        | 87.6 | 87.6 | 0.0        | 0.0  | 2.1  | 28.3       | 0.0  | 30.4 |
| Green Time:               | 0.0         | 44.9 | 58.4 | 41.2        | 13.1 | 13.1 | 0.0        | 0.0  | 70.7 | 42.9       | 0.0  | 57.0 |
| Volume/Cap:               | 0.00        | 0.74 | 0.85 | 0.85        | 0.67 | 0.67 | 0.00       | 0.00 | 0.35 | 0.30       | 0.00 | 0.85 |
| Delay/Veh:                | 1.00        | 1.00 | 1.00 | 1.00        | 1.00 | 1.00 | 1.00       | 1.00 | 1.00 | 1.00       | 1.00 | 1.00 |
| User DelAdj:              | 0.0         | 44.9 | 58.4 | 41.2        | 13.1 | 13.1 | 0.0        | 0.0  | 70.7 | 42.9       | 0.0  | 57.0 |
| AdjDel/Veh:               | A           | D    | E    | D           | B    | B    | A          | A    | E    | D          | A    | E    |
| LOS by Move:              | 0           | 24   | 29   | 42          | 35   | 35   | 0          | 0    | 2    | 8          | 0    | 29   |
| HCM2k95thQ:               | 0           | 24   | 29   | 42          | 35   | 35   | 0          | 0    | 2    | 8          | 0    | 29   |

Note: Queue reported is the number of cars per lane.

BART

Level Of Service Computation Report  
 2000 HCM Operations (Future Volume Alternative)  
 AM - Bkgrd + Proj Conditions

Intersection #3057: The Alameda/Hedding [Study Int 58]

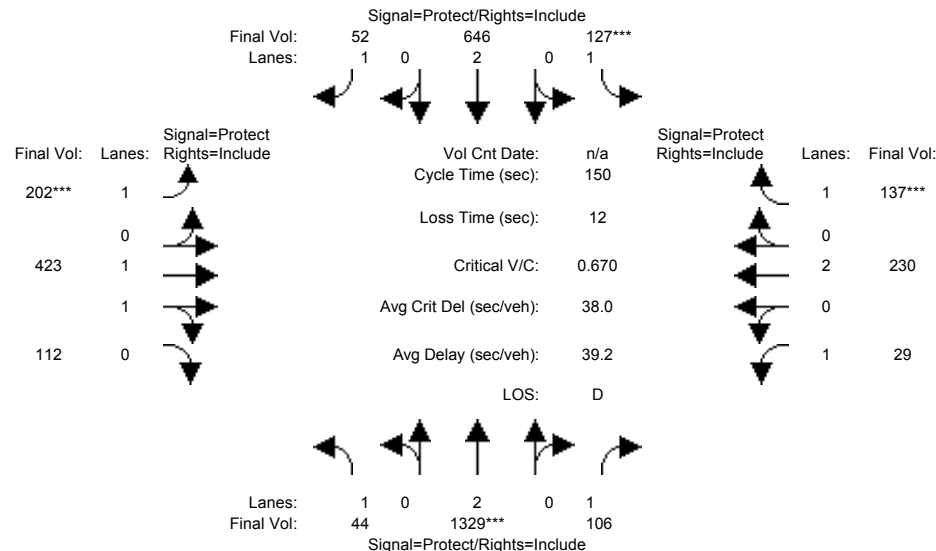

| Approach:                 | North Bound |      |      | South Bound |      |      | East Bound |      |      | West Bound |      |      |
|---------------------------|-------------|------|------|-------------|------|------|------------|------|------|------------|------|------|
| Movement:                 | L           | T    | R    | L           | T    | R    | L          | T    | R    | L          | T    | R    |
| Min. Green:               | 7           | 10   | 10   | 7           | 10   | 10   | 7          | 10   | 10   | 7          | 10   | 10   |
| Y+R:                      | 4.0         | 4.0  | 4.0  | 4.0         | 4.0  | 4.0  | 4.0        | 4.0  | 4.0  | 4.0        | 4.0  | 4.0  |
| Volume Module:            |             |      |      |             |      |      |            |      |      |            |      |      |
| Base Vol:                 | 44          | 1329 | 106  | 127         | 646  | 52   | 202        | 423  | 112  | 29         | 230  | 137  |
| Growth Adj:               | 1.00        | 1.00 | 1.00 | 1.00        | 1.00 | 1.00 | 1.00       | 1.00 | 1.00 | 1.00       | 1.00 | 1.00 |
| Initial Bse:              | 44          | 1329 | 106  | 127         | 646  | 52   | 202        | 423  | 112  | 29         | 230  | 137  |
| Added Vol:                | 0           | 0    | 0    | 0           | 0    | 0    | 0          | 0    | 0    | 0          | 0    | 0    |
| PasserByVol:              | 0           | 0    | 0    | 0           | 0    | 0    | 0          | 0    | 0    | 0          | 0    | 0    |
| Initial Fut:              | 44          | 1329 | 106  | 127         | 646  | 52   | 202        | 423  | 112  | 29         | 230  | 137  |
| User Adj:                 | 1.00        | 1.00 | 1.00 | 1.00        | 1.00 | 1.00 | 1.00       | 1.00 | 1.00 | 1.00       | 1.00 | 1.00 |
| PHF Adj:                  | 1.00        | 1.00 | 1.00 | 1.00        | 1.00 | 1.00 | 1.00       | 1.00 | 1.00 | 1.00       | 1.00 | 1.00 |
| PHF Volume:               | 44          | 1329 | 106  | 127         | 646  | 52   | 202        | 423  | 112  | 29         | 230  | 137  |
| Reduct Vol:               | 0           | 0    | 0    | 0           | 0    | 0    | 0          | 0    | 0    | 0          | 0    | 0    |
| Reduced Vol:              | 44          | 1329 | 106  | 127         | 646  | 52   | 202        | 423  | 112  | 29         | 230  | 137  |
| PCE Adj:                  | 1.00        | 1.00 | 1.00 | 1.00        | 1.00 | 1.00 | 1.00       | 1.00 | 1.00 | 1.00       | 1.00 | 1.00 |
| MLF Adj:                  | 1.00        | 1.00 | 1.00 | 1.00        | 1.00 | 1.00 | 1.00       | 1.00 | 1.00 | 1.00       | 1.00 | 1.00 |
| Final Volume:             | 44          | 1329 | 106  | 127         | 646  | 52   | 202        | 423  | 112  | 29         | 230  | 137  |
| Saturation Flow Module:   |             |      |      |             |      |      |            |      |      |            |      |      |
| Sat/Lane:                 | 1900        | 1900 | 1900 | 1900        | 1900 | 1900 | 1900       | 1900 | 1900 | 1900       | 1900 | 1900 |
| Adjustment:               | 0.92        | 1.00 | 0.92 | 0.92        | 1.00 | 0.92 | 0.92       | 0.98 | 0.95 | 0.92       | 1.00 | 0.92 |
| Lanes:                    | 1.00        | 2.00 | 1.00 | 1.00        | 2.00 | 1.00 | 1.00       | 1.57 | 0.43 | 1.00       | 2.00 | 1.00 |
| Final Sat.:               | 1750        | 3800 | 1750 | 1750        | 3800 | 1750 | 1750       | 2925 | 774  | 1750       | 3800 | 1750 |
| Capacity Analysis Module: |             |      |      |             |      |      |            |      |      |            |      |      |
| Vol/Sat:                  | 0.03        | 0.35 | 0.06 | 0.07        | 0.17 | 0.03 | 0.12       | 0.14 | 0.14 | 0.02       | 0.06 | 0.08 |
| Crit Moves:               | ****        | **** | **** | ****        | **** | **** | ****       | **** | **** | ****       | **** | **** |
| Green Time:               | 20.4        | 78.3 | 78.3 | 16.3        | 74.2 | 74.2 | 25.9       | 32.8 | 32.8 | 10.6       | 17.5 | 17.5 |
| Volume/Cap:               | 0.19        | 0.67 | 0.12 | 0.67        | 0.34 | 0.06 | 0.67       | 0.66 | 0.66 | 0.23       | 0.52 | 0.67 |
| Delay/Veh:                | 57.8        | 27.2 | 18.3 | 73.2        | 23.2 | 19.8 | 63.8       | 55.6 | 55.6 | 66.9       | 63.3 | 71.8 |
| User DelAdj:              | 1.00        | 1.00 | 1.00 | 1.00        | 1.00 | 1.00 | 1.00       | 1.00 | 1.00 | 1.00       | 1.00 | 1.00 |
| AdjDel/Veh:               | 57.8        | 27.2 | 18.3 | 73.2        | 23.2 | 19.8 | 63.8       | 55.6 | 55.6 | 66.9       | 63.3 | 71.8 |
| LOS by Move:              | E           | C    | B    | E           | C    | B    | E          | E    | E    | E          | E    | E    |
| HCM2k95thQ:               | 4           | 36   | 5    | 12          | 16   | 3    | 19         | 22   | 22   | 3          | 9    | 12   |

Note: Queue reported is the number of cars per lane.

BART

Level Of Service Computation Report  
 2000 HCM Operations (Future Volume Alternative)  
 PM - Bkgrd + Proj Conditions

Intersection #3057: The Alameda/Hedding [Study Int 58]

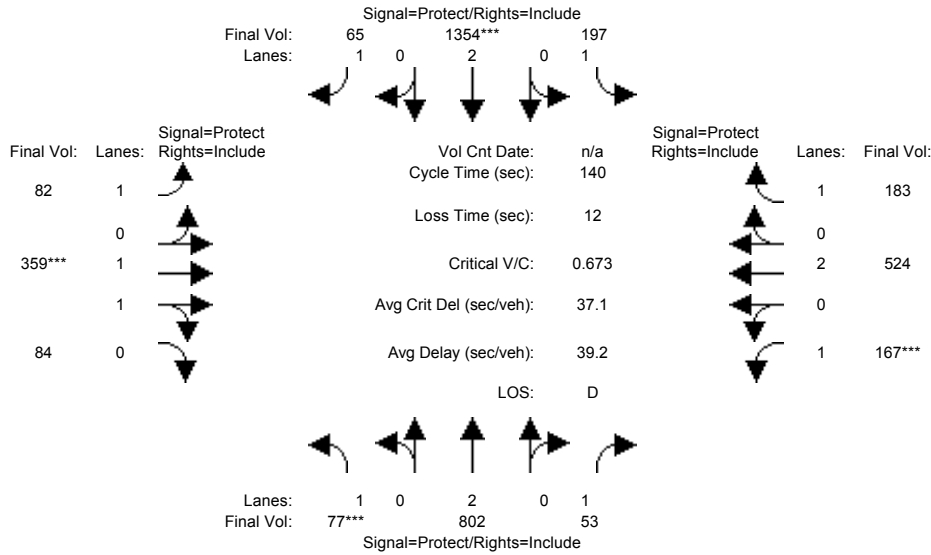

| Approach:                 | North Bound |      |      | South Bound |      |      | East Bound |      |      | West Bound |      |      |
|---------------------------|-------------|------|------|-------------|------|------|------------|------|------|------------|------|------|
| Movement:                 | L           | T    | R    | L           | T    | R    | L          | T    | R    | L          | T    | R    |
| Min. Green:               | 7           | 10   | 10   | 7           | 10   | 10   | 7          | 10   | 10   | 7          | 10   | 10   |
| Y+R:                      | 4.0         | 4.0  | 4.0  | 4.0         | 4.0  | 4.0  | 4.0        | 4.0  | 4.0  | 4.0        | 4.0  | 4.0  |
| Volume Module:            |             |      |      |             |      |      |            |      |      |            |      |      |
| Base Vol:                 | 77          | 802  | 53   | 197         | 1354 | 65   | 82         | 359  | 84   | 167        | 524  | 183  |
| Growth Adj:               | 1.00        | 1.00 | 1.00 | 1.00        | 1.00 | 1.00 | 1.00       | 1.00 | 1.00 | 1.00       | 1.00 | 1.00 |
| Initial Bse:              | 77          | 802  | 53   | 197         | 1354 | 65   | 82         | 359  | 84   | 167        | 524  | 183  |
| Added Vol:                | 0           | 0    | 0    | 0           | 0    | 0    | 0          | 0    | 0    | 0          | 0    | 0    |
| PasserByVol:              | 0           | 0    | 0    | 0           | 0    | 0    | 0          | 0    | 0    | 0          | 0    | 0    |
| Initial Fut:              | 77          | 802  | 53   | 197         | 1354 | 65   | 82         | 359  | 84   | 167        | 524  | 183  |
| User Adj:                 | 1.00        | 1.00 | 1.00 | 1.00        | 1.00 | 1.00 | 1.00       | 1.00 | 1.00 | 1.00       | 1.00 | 1.00 |
| PHF Adj:                  | 1.00        | 1.00 | 1.00 | 1.00        | 1.00 | 1.00 | 1.00       | 1.00 | 1.00 | 1.00       | 1.00 | 1.00 |
| PHF Volume:               | 77          | 802  | 53   | 197         | 1354 | 65   | 82         | 359  | 84   | 167        | 524  | 183  |
| Reduct Vol:               | 0           | 0    | 0    | 0           | 0    | 0    | 0          | 0    | 0    | 0          | 0    | 0    |
| Reduced Vol:              | 77          | 802  | 53   | 197         | 1354 | 65   | 82         | 359  | 84   | 167        | 524  | 183  |
| PCE Adj:                  | 1.00        | 1.00 | 1.00 | 1.00        | 1.00 | 1.00 | 1.00       | 1.00 | 1.00 | 1.00       | 1.00 | 1.00 |
| MLF Adj:                  | 1.00        | 1.00 | 1.00 | 1.00        | 1.00 | 1.00 | 1.00       | 1.00 | 1.00 | 1.00       | 1.00 | 1.00 |
| Final Volume:             | 77          | 802  | 53   | 197         | 1354 | 65   | 82         | 359  | 84   | 167        | 524  | 183  |
| Saturation Flow Module:   |             |      |      |             |      |      |            |      |      |            |      |      |
| Sat/Lane:                 | 1900        | 1900 | 1900 | 1900        | 1900 | 1900 | 1900       | 1900 | 1900 | 1900       | 1900 | 1900 |
| Adjustment:               | 0.92        | 1.00 | 0.92 | 0.92        | 1.00 | 0.92 | 0.92       | 0.98 | 0.95 | 0.92       | 1.00 | 0.92 |
| Lanes:                    | 1.00        | 2.00 | 1.00 | 1.00        | 2.00 | 1.00 | 1.00       | 1.61 | 0.39 | 1.00       | 2.00 | 1.00 |
| Final Sat.:               | 1750        | 3800 | 1750 | 1750        | 3800 | 1750 | 1750       | 2998 | 701  | 1750       | 3800 | 1750 |
| Capacity Analysis Module: |             |      |      |             |      |      |            |      |      |            |      |      |
| Vol/Sat:                  | 0.04        | 0.21 | 0.03 | 0.11        | 0.36 | 0.04 | 0.05       | 0.12 | 0.12 | 0.10       | 0.14 | 0.10 |
| Crit Moves:               | ****        |      |      | ****        |      |      | ****       |      |      | ****       |      |      |
| Green Time:               | 9.2         | 54.3 | 54.3 | 29.0        | 74.1 | 74.1 | 11.9       | 24.9 | 24.9 | 19.8       | 32.8 | 32.8 |
| Volume/Cap:               | 0.67        | 0.54 | 0.08 | 0.54        | 0.67 | 0.07 | 0.55       | 0.67 | 0.67 | 0.67       | 0.59 | 0.45 |
| Delay/Veh:                | 78.6        | 33.7 | 27.1 | 51.3        | 25.0 | 16.1 | 65.9       | 56.5 | 56.5 | 64.1       | 48.6 | 46.6 |
| User DelAdj:              | 1.00        | 1.00 | 1.00 | 1.00        | 1.00 | 1.00 | 1.00       | 1.00 | 1.00 | 1.00       | 1.00 | 1.00 |
| AdjDel/Veh:               | 78.6        | 33.7 | 27.1 | 51.3        | 25.0 | 16.1 | 65.9       | 56.5 | 56.5 | 64.1       | 48.6 | 46.6 |
| LOS by Move:              | E           | C    | C    | D           | C    | B    | E          | E    | E    | E          | D    | D    |
| HCM2k95thQ:               | 7           | 23   | 3    | 15          | 35   | 3    | 9          | 19   | 19   | 14         | 18   | 13   |

Note: Queue reported is the number of cars per lane.

BART

Level Of Service Computation Report  
 2000 HCM Operations (Future Volume Alternative)  
 AM - Bkgrd + Proj Conditions

Intersection #3058: The Alameda/Naglee [Study Int 59]

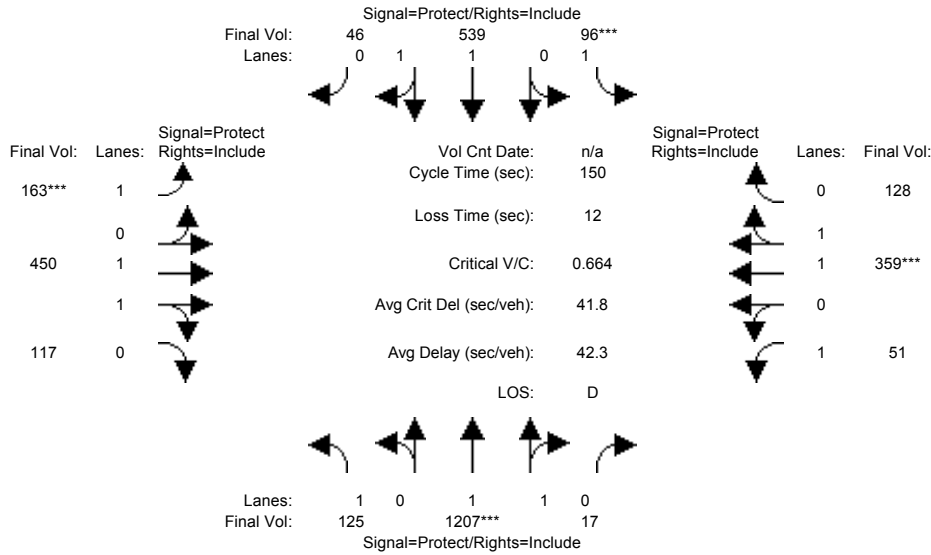

| Approach:                 | North Bound |      |      | South Bound |      |      | East Bound |      |      | West Bound |      |      |
|---------------------------|-------------|------|------|-------------|------|------|------------|------|------|------------|------|------|
| Movement:                 | L           | T    | R    | L           | T    | R    | L          | T    | R    | L          | T    | R    |
| Min. Green:               | 7           | 10   | 10   | 7           | 10   | 10   | 7          | 10   | 10   | 7          | 10   | 10   |
| Y+R:                      | 4.0         | 4.0  | 4.0  | 4.0         | 4.0  | 4.0  | 4.0        | 4.0  | 4.0  | 4.0        | 4.0  | 4.0  |
| Volume Module:            |             |      |      |             |      |      |            |      |      |            |      |      |
| Base Vol:                 | 125         | 1207 | 17   | 96          | 539  | 46   | 163        | 450  | 117  | 51         | 359  | 128  |
| Growth Adj:               | 1.00        | 1.00 | 1.00 | 1.00        | 1.00 | 1.00 | 1.00       | 1.00 | 1.00 | 1.00       | 1.00 | 1.00 |
| Initial Bse:              | 125         | 1207 | 17   | 96          | 539  | 46   | 163        | 450  | 117  | 51         | 359  | 128  |
| Added Vol:                | 0           | 0    | 0    | 0           | 0    | 0    | 0          | 0    | 0    | 0          | 0    | 0    |
| PasserByVol:              | 0           | 0    | 0    | 0           | 0    | 0    | 0          | 0    | 0    | 0          | 0    | 0    |
| Initial Fut:              | 125         | 1207 | 17   | 96          | 539  | 46   | 163        | 450  | 117  | 51         | 359  | 128  |
| User Adj:                 | 1.00        | 1.00 | 1.00 | 1.00        | 1.00 | 1.00 | 1.00       | 1.00 | 1.00 | 1.00       | 1.00 | 1.00 |
| PHF Adj:                  | 1.00        | 1.00 | 1.00 | 1.00        | 1.00 | 1.00 | 1.00       | 1.00 | 1.00 | 1.00       | 1.00 | 1.00 |
| PHF Volume:               | 125         | 1207 | 17   | 96          | 539  | 46   | 163        | 450  | 117  | 51         | 359  | 128  |
| Reduct Vol:               | 0           | 0    | 0    | 0           | 0    | 0    | 0          | 0    | 0    | 0          | 0    | 0    |
| Reduced Vol:              | 125         | 1207 | 17   | 96          | 539  | 46   | 163        | 450  | 117  | 51         | 359  | 128  |
| PCE Adj:                  | 1.00        | 1.00 | 1.00 | 1.00        | 1.00 | 1.00 | 1.00       | 1.00 | 1.00 | 1.00       | 1.00 | 1.00 |
| MLF Adj:                  | 1.00        | 1.00 | 1.00 | 1.00        | 1.00 | 1.00 | 1.00       | 1.00 | 1.00 | 1.00       | 1.00 | 1.00 |
| FinalVolume:              | 125         | 1207 | 17   | 96          | 539  | 46   | 163        | 450  | 117  | 51         | 359  | 128  |
| Saturation Flow Module:   |             |      |      |             |      |      |            |      |      |            |      |      |
| Sat/Lane:                 | 1900        | 1900 | 1900 | 1900        | 1900 | 1900 | 1900       | 1900 | 1900 | 1900       | 1900 | 1900 |
| Adjustment:               | 0.92        | 0.97 | 0.95 | 0.92        | 0.98 | 0.95 | 0.92       | 0.98 | 0.95 | 0.92       | 0.98 | 0.95 |
| Lanes:                    | 1.00        | 1.97 | 0.03 | 1.00        | 1.84 | 0.16 | 1.00       | 1.58 | 0.42 | 1.00       | 1.46 | 0.54 |
| Final Sat.:               | 1750        | 3649 | 51   | 1750        | 3409 | 291  | 1750       | 2936 | 763  | 1750       | 2727 | 972  |
| Capacity Analysis Module: |             |      |      |             |      |      |            |      |      |            |      |      |
| Vol/Sat:                  | 0.07        | 0.33 | 0.33 | 0.05        | 0.16 | 0.16 | 0.09       | 0.15 | 0.15 | 0.03       | 0.13 | 0.13 |
| Crit Moves:               | ****        | **** | **** | ****        | **** | **** | ****       | **** | **** | ****       | **** | **** |
| Green Time:               | 27.1        | 74.8 | 74.8 | 12.4        | 60.1 | 60.1 | 21.1       | 39.0 | 39.0 | 11.9       | 29.8 | 29.8 |
| Volume/Cap:               | 0.39        | 0.66 | 0.66 | 0.66        | 0.39 | 0.39 | 0.66       | 0.59 | 0.59 | 0.37       | 0.66 | 0.66 |
| Delay/Veh:                | 55.0        | 29.1 | 29.1 | 77.8        | 32.2 | 32.2 | 67.8       | 49.5 | 49.5 | 67.2       | 57.8 | 57.8 |
| User DelAdj:              | 1.00        | 1.00 | 1.00 | 1.00        | 1.00 | 1.00 | 1.00       | 1.00 | 1.00 | 1.00       | 1.00 | 1.00 |
| AdjDel/Veh:               | 55.0        | 29.1 | 29.1 | 77.8        | 32.2 | 32.2 | 67.8       | 49.5 | 49.5 | 67.2       | 57.8 | 57.8 |
| LOS by Move:              | E           | C    | C    | E           | C    | C    | E          | D    | D    | E          | E    | E    |
| HCM2k95thQ:               | 11          | 36   | 36   | 9           | 17   | 17   | 16         | 22   | 22   | 5          | 19   | 19   |

Note: Queue reported is the number of cars per lane.



BART

Level Of Service Computation Report  
 2000 HCM Operations (Future Volume Alternative)  
 PM - Bkgrd + Proj Conditions

Intersection #3058: The Alameda/Naglee [Study Int 59]

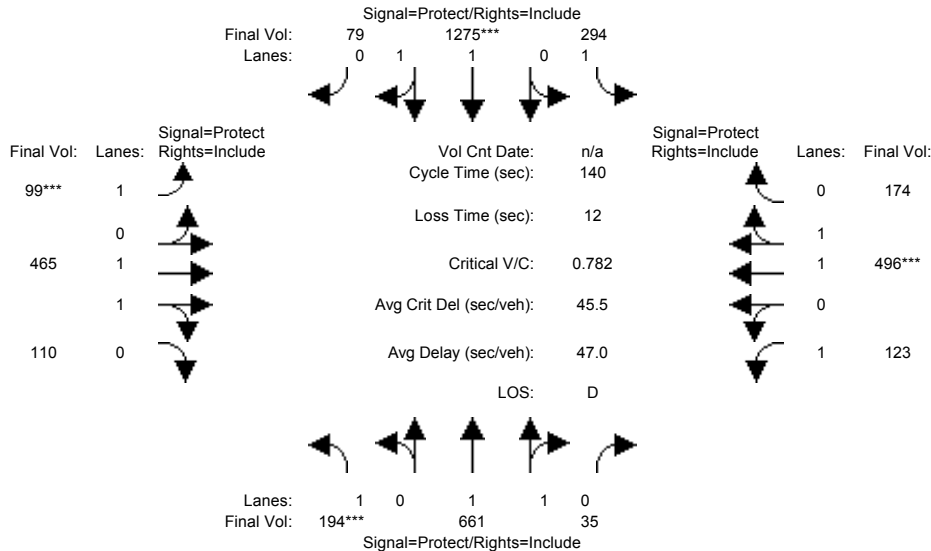

| Approach:                 | North Bound |      |      | South Bound |      |      | East Bound |      |      | West Bound |      |      |
|---------------------------|-------------|------|------|-------------|------|------|------------|------|------|------------|------|------|
| Movement:                 | L           | T    | R    | L           | T    | R    | L          | T    | R    | L          | T    | R    |
| Min. Green:               | 7           | 10   | 10   | 7           | 10   | 10   | 7          | 10   | 10   | 7          | 10   | 10   |
| Y+R:                      | 4.0         | 4.0  | 4.0  | 4.0         | 4.0  | 4.0  | 4.0        | 4.0  | 4.0  | 4.0        | 4.0  | 4.0  |
| Volume Module:            |             |      |      |             |      |      |            |      |      |            |      |      |
| Base Vol:                 | 194         | 661  | 35   | 294         | 1275 | 79   | 99         | 465  | 110  | 123        | 496  | 174  |
| Growth Adj:               | 1.00        | 1.00 | 1.00 | 1.00        | 1.00 | 1.00 | 1.00       | 1.00 | 1.00 | 1.00       | 1.00 | 1.00 |
| Initial Bse:              | 194         | 661  | 35   | 294         | 1275 | 79   | 99         | 465  | 110  | 123        | 496  | 174  |
| Added Vol:                | 0           | 0    | 0    | 0           | 0    | 0    | 0          | 0    | 0    | 0          | 0    | 0    |
| PasserByVol:              | 0           | 0    | 0    | 0           | 0    | 0    | 0          | 0    | 0    | 0          | 0    | 0    |
| Initial Fut:              | 194         | 661  | 35   | 294         | 1275 | 79   | 99         | 465  | 110  | 123        | 496  | 174  |
| User Adj:                 | 1.00        | 1.00 | 1.00 | 1.00        | 1.00 | 1.00 | 1.00       | 1.00 | 1.00 | 1.00       | 1.00 | 1.00 |
| PHF Adj:                  | 1.00        | 1.00 | 1.00 | 1.00        | 1.00 | 1.00 | 1.00       | 1.00 | 1.00 | 1.00       | 1.00 | 1.00 |
| PHF Volume:               | 194         | 661  | 35   | 294         | 1275 | 79   | 99         | 465  | 110  | 123        | 496  | 174  |
| Reduct Vol:               | 0           | 0    | 0    | 0           | 0    | 0    | 0          | 0    | 0    | 0          | 0    | 0    |
| Reduced Vol:              | 194         | 661  | 35   | 294         | 1275 | 79   | 99         | 465  | 110  | 123        | 496  | 174  |
| PCE Adj:                  | 1.00        | 1.00 | 1.00 | 1.00        | 1.00 | 1.00 | 1.00       | 1.00 | 1.00 | 1.00       | 1.00 | 1.00 |
| MLF Adj:                  | 1.00        | 1.00 | 1.00 | 1.00        | 1.00 | 1.00 | 1.00       | 1.00 | 1.00 | 1.00       | 1.00 | 1.00 |
| FinalVolume:              | 194         | 661  | 35   | 294         | 1275 | 79   | 99         | 465  | 110  | 123        | 496  | 174  |
| Saturation Flow Module:   |             |      |      |             |      |      |            |      |      |            |      |      |
| Sat/Lane:                 | 1900        | 1900 | 1900 | 1900        | 1900 | 1900 | 1900       | 1900 | 1900 | 1900       | 1900 | 1900 |
| Adjustment:               | 0.92        | 0.98 | 0.95 | 0.92        | 0.98 | 0.95 | 0.92       | 0.98 | 0.95 | 0.92       | 0.98 | 0.95 |
| Lanes:                    | 1.00        | 1.90 | 0.10 | 1.00        | 1.88 | 0.12 | 1.00       | 1.61 | 0.39 | 1.00       | 1.47 | 0.53 |
| Final Sat.:               | 1750        | 3514 | 186  | 1750        | 3484 | 216  | 1750       | 2992 | 708  | 1750       | 2738 | 961  |
| Capacity Analysis Module: |             |      |      |             |      |      |            |      |      |            |      |      |
| Vol/Sat:                  | 0.11        | 0.19 | 0.19 | 0.17        | 0.37 | 0.37 | 0.06       | 0.16 | 0.16 | 0.07       | 0.18 | 0.18 |
| Crit Moves:               | ****        |      |      | ****        |      |      | ****       |      |      | ****       |      |      |
| Green Time:               | 19.9        | 45.1 | 45.1 | 40.3        | 65.6 | 65.6 | 10.1       | 29.3 | 29.3 | 13.3       | 32.4 | 32.4 |
| Volume/Cap:               | 0.78        | 0.58 | 0.58 | 0.58        | 0.78 | 0.78 | 0.78       | 0.74 | 0.74 | 0.74       | 0.78 | 0.78 |
| Delay/Veh:                | 72.7        | 40.3 | 40.3 | 44.4        | 33.6 | 33.6 | 90.1       | 55.7 | 55.7 | 78.1       | 55.1 | 55.1 |
| User DelAdj:              | 1.00        | 1.00 | 1.00 | 1.00        | 1.00 | 1.00 | 1.00       | 1.00 | 1.00 | 1.00       | 1.00 | 1.00 |
| AdjDel/Veh:               | 72.7        | 40.3 | 40.3 | 44.4        | 33.6 | 33.6 | 90.1       | 55.7 | 55.7 | 78.1       | 55.1 | 55.1 |
| LOS by Move:              | E           | D    | D    | D           | C    | C    | F          | E    | E    | E          | E    | E    |
| HCM2k95thQ:               | 19          | 23   | 23   | 20          | 41   | 41   | 12         | 24   | 24   | 11         | 25   | 25   |

Note: Queue reported is the number of cars per lane.

BART

Level Of Service Computation Report  
 2000 HCM Operations (Future Volume Alternative)  
 AM - Bkgrd + Proj Conditions

Intersection #3063: ALUM ROCK/JACKSON [Study Int 18]

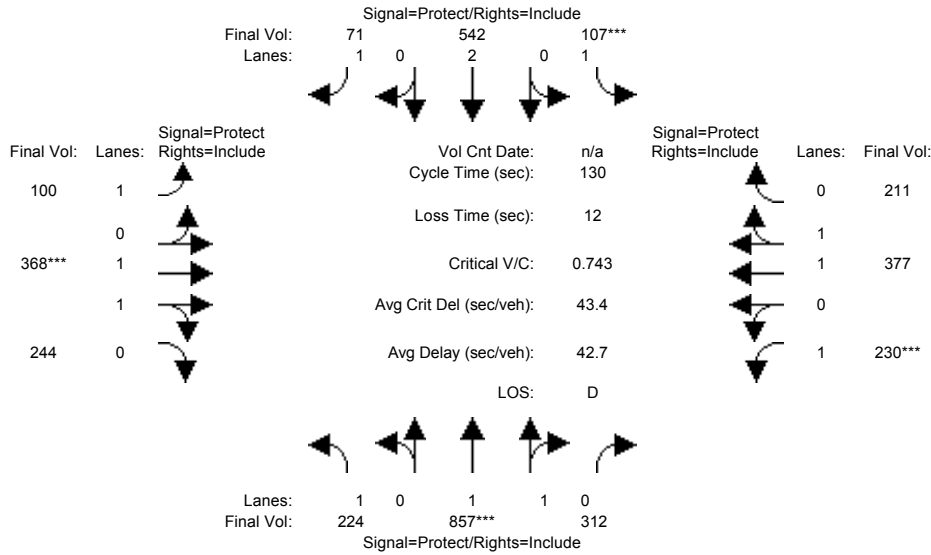

| Approach:                 | North Bound |      |      | South Bound |      |      | East Bound |      |      | West Bound |      |      |
|---------------------------|-------------|------|------|-------------|------|------|------------|------|------|------------|------|------|
| Movement:                 | L           | T    | R    | L           | T    | R    | L          | T    | R    | L          | T    | R    |
| Min. Green:               | 7           | 10   | 10   | 7           | 10   | 10   | 7          | 10   | 10   | 7          | 10   | 10   |
| Y+R:                      | 4.0         | 4.0  | 4.0  | 4.0         | 4.0  | 4.0  | 4.0        | 4.0  | 4.0  | 4.0        | 4.0  | 4.0  |
| Volume Module:            |             |      |      |             |      |      |            |      |      |            |      |      |
| Base Vol:                 | 224         | 857  | 312  | 107         | 542  | 71   | 100        | 368  | 244  | 230        | 377  | 211  |
| Growth Adj:               | 1.00        | 1.00 | 1.00 | 1.00        | 1.00 | 1.00 | 1.00       | 1.00 | 1.00 | 1.00       | 1.00 | 1.00 |
| Initial Bse:              | 224         | 857  | 312  | 107         | 542  | 71   | 100        | 368  | 244  | 230        | 377  | 211  |
| Added Vol:                | 0           | 0    | 0    | 0           | 0    | 0    | 0          | 0    | 0    | 0          | 0    | 0    |
| PasserByVol:              | 0           | 0    | 0    | 0           | 0    | 0    | 0          | 0    | 0    | 0          | 0    | 0    |
| Initial Fut:              | 224         | 857  | 312  | 107         | 542  | 71   | 100        | 368  | 244  | 230        | 377  | 211  |
| User Adj:                 | 1.00        | 1.00 | 1.00 | 1.00        | 1.00 | 1.00 | 1.00       | 1.00 | 1.00 | 1.00       | 1.00 | 1.00 |
| PHF Adj:                  | 1.00        | 1.00 | 1.00 | 1.00        | 1.00 | 1.00 | 1.00       | 1.00 | 1.00 | 1.00       | 1.00 | 1.00 |
| PHF Volume:               | 224         | 857  | 312  | 107         | 542  | 71   | 100        | 368  | 244  | 230        | 377  | 211  |
| Reduct Vol:               | 0           | 0    | 0    | 0           | 0    | 0    | 0          | 0    | 0    | 0          | 0    | 0    |
| Reduced Vol:              | 224         | 857  | 312  | 107         | 542  | 71   | 100        | 368  | 244  | 230        | 377  | 211  |
| PCE Adj:                  | 1.00        | 1.00 | 1.00 | 1.00        | 1.00 | 1.00 | 1.00       | 1.00 | 1.00 | 1.00       | 1.00 | 1.00 |
| MLF Adj:                  | 1.00        | 1.00 | 1.00 | 1.00        | 1.00 | 1.00 | 1.00       | 1.00 | 1.00 | 1.00       | 1.00 | 1.00 |
| FinalVolume:              | 224         | 857  | 312  | 107         | 542  | 71   | 100        | 368  | 244  | 230        | 377  | 211  |
| Saturation Flow Module:   |             |      |      |             |      |      |            |      |      |            |      |      |
| Sat/Lane:                 | 1900        | 1900 | 1900 | 1900        | 1900 | 1900 | 1900       | 1900 | 1900 | 1900       | 1900 | 1900 |
| Adjustment:               | 0.92        | 0.98 | 0.95 | 0.92        | 1.00 | 0.92 | 0.92       | 0.99 | 0.95 | 0.92       | 0.99 | 0.95 |
| Lanes:                    | 1.00        | 1.45 | 0.55 | 1.00        | 2.00 | 1.00 | 1.00       | 1.18 | 0.82 | 1.00       | 1.26 | 0.74 |
| Final Sat.:               | 1750        | 2712 | 987  | 1750        | 3800 | 1750 | 1750       | 2224 | 1474 | 1750       | 2371 | 1327 |
| Capacity Analysis Module: |             |      |      |             |      |      |            |      |      |            |      |      |
| Vol/Sat:                  | 0.13        | 0.32 | 0.32 | 0.06        | 0.14 | 0.04 | 0.06       | 0.17 | 0.17 | 0.13       | 0.16 | 0.16 |
| Crit Moves:               | ****        | **** | **** | ****        | **** | **** | ****       | **** | **** | ****       | **** | **** |
| Green Time:               | 31.2        | 55.3 | 55.3 | 10.7        | 34.8 | 34.8 | 13.7       | 29.0 | 29.0 | 23.0       | 38.2 | 38.2 |
| Volume/Cap:               | 0.53        | 0.74 | 0.74 | 0.74        | 0.53 | 0.15 | 0.54       | 0.74 | 0.74 | 0.74       | 0.54 | 0.54 |
| Delay/Veh:                | 44.4        | 33.3 | 33.3 | 76.9        | 41.2 | 36.5 | 58.3       | 50.7 | 50.7 | 60.0       | 39.1 | 39.1 |
| User DelAdj:              | 1.00        | 1.00 | 1.00 | 1.00        | 1.00 | 1.00 | 1.00       | 1.00 | 1.00 | 1.00       | 1.00 | 1.00 |
| AdjDel/Veh:               | 44.4        | 33.3 | 33.3 | 76.9        | 41.2 | 36.5 | 58.3       | 50.7 | 50.7 | 60.0       | 39.1 | 39.1 |
| LOS by Move:              | D           | C    | C    | E           | D    | D    | E          | D    | D    | E          | D    | D    |
| HCM2k95thQ:               | 16          | 35   | 35   | 12          | 18   | 5    | 8          | 22   | 22   | 18         | 18   | 18   |

Note: Queue reported is the number of cars per lane.

BART

Level Of Service Computation Report  
 2000 HCM Operations (Future Volume Alternative)  
 PM - Bkgrd + Proj Conditions

Intersection #3063: ALUM ROCK/JACKSON [Study Int 18]

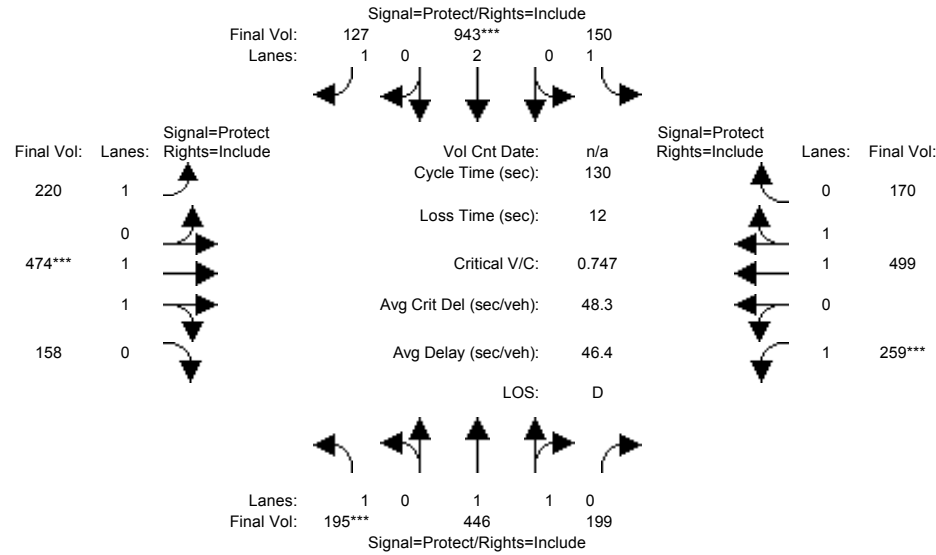

| Approach:                 | North Bound |      |      | South Bound |      |      | East Bound |      |      | West Bound |      |      |
|---------------------------|-------------|------|------|-------------|------|------|------------|------|------|------------|------|------|
| Movement:                 | L           | T    | R    | L           | T    | R    | L          | T    | R    | L          | T    | R    |
| Min. Green:               | 7           | 10   | 10   | 7           | 10   | 10   | 7          | 10   | 10   | 7          | 10   | 10   |
| Y+R:                      | 4.0         | 4.0  | 4.0  | 4.0         | 4.0  | 4.0  | 4.0        | 4.0  | 4.0  | 4.0        | 4.0  | 4.0  |
| Volume Module:            |             |      |      |             |      |      |            |      |      |            |      |      |
| Base Vol:                 | 195         | 446  | 199  | 150         | 943  | 127  | 220        | 474  | 158  | 259        | 499  | 170  |
| Growth Adj:               | 1.00        | 1.00 | 1.00 | 1.00        | 1.00 | 1.00 | 1.00       | 1.00 | 1.00 | 1.00       | 1.00 | 1.00 |
| Initial Bse:              | 195         | 446  | 199  | 150         | 943  | 127  | 220        | 474  | 158  | 259        | 499  | 170  |
| Added Vol:                | 0           | 0    | 0    | 0           | 0    | 0    | 0          | 0    | 0    | 0          | 0    | 0    |
| PasserByVol:              | 0           | 0    | 0    | 0           | 0    | 0    | 0          | 0    | 0    | 0          | 0    | 0    |
| Initial Fut:              | 195         | 446  | 199  | 150         | 943  | 127  | 220        | 474  | 158  | 259        | 499  | 170  |
| User Adj:                 | 1.00        | 1.00 | 1.00 | 1.00        | 1.00 | 1.00 | 1.00       | 1.00 | 1.00 | 1.00       | 1.00 | 1.00 |
| PHF Adj:                  | 1.00        | 1.00 | 1.00 | 1.00        | 1.00 | 1.00 | 1.00       | 1.00 | 1.00 | 1.00       | 1.00 | 1.00 |
| PHF Volume:               | 195         | 446  | 199  | 150         | 943  | 127  | 220        | 474  | 158  | 259        | 499  | 170  |
| Reduct Vol:               | 0           | 0    | 0    | 0           | 0    | 0    | 0          | 0    | 0    | 0          | 0    | 0    |
| Reduced Vol:              | 195         | 446  | 199  | 150         | 943  | 127  | 220        | 474  | 158  | 259        | 499  | 170  |
| PCE Adj:                  | 1.00        | 1.00 | 1.00 | 1.00        | 1.00 | 1.00 | 1.00       | 1.00 | 1.00 | 1.00       | 1.00 | 1.00 |
| MLF Adj:                  | 1.00        | 1.00 | 1.00 | 1.00        | 1.00 | 1.00 | 1.00       | 1.00 | 1.00 | 1.00       | 1.00 | 1.00 |
| Final Volume:             | 195         | 446  | 199  | 150         | 943  | 127  | 220        | 474  | 158  | 259        | 499  | 170  |
| Saturation Flow Module:   |             |      |      |             |      |      |            |      |      |            |      |      |
| Sat/Lane:                 | 1900        | 1900 | 1900 | 1900        | 1900 | 1900 | 1900       | 1900 | 1900 | 1900       | 1900 | 1900 |
| Adjustment:               | 0.92        | 0.99 | 0.95 | 0.92        | 1.00 | 0.92 | 0.92       | 0.98 | 0.95 | 0.92       | 0.98 | 0.95 |
| Lanes:                    | 1.00        | 1.37 | 0.63 | 1.00        | 2.00 | 1.00 | 1.00       | 1.49 | 0.51 | 1.00       | 1.48 | 0.52 |
| Final Sat.:               | 1750        | 2558 | 1141 | 1750        | 3800 | 1750 | 1750       | 2774 | 925  | 1750       | 2759 | 940  |
| Capacity Analysis Module: |             |      |      |             |      |      |            |      |      |            |      |      |
| Vol/Sat:                  | 0.11        | 0.17 | 0.17 | 0.09        | 0.25 | 0.07 | 0.13       | 0.17 | 0.17 | 0.15       | 0.18 | 0.18 |
| Crit Moves:               | ****        |      |      | ****        |      |      | ****       |      |      | ****       |      |      |
| Green Time:               | 19.4        | 41.9 | 41.9 | 20.6        | 43.2 | 43.2 | 22.7       | 29.7 | 29.7 | 25.7       | 32.7 | 32.7 |
| Volume/Cap:               | 0.75        | 0.54 | 0.54 | 0.54        | 0.75 | 0.22 | 0.72       | 0.75 | 0.75 | 0.75       | 0.72 | 0.72 |
| Delay/Veh:                | 64.2        | 36.6 | 36.6 | 52.5        | 41.1 | 31.5 | 58.6       | 50.4 | 50.4 | 57.7       | 47.2 | 47.2 |
| User DelAdj:              | 1.00        | 1.00 | 1.00 | 1.00        | 1.00 | 1.00 | 1.00       | 1.00 | 1.00 | 1.00       | 1.00 | 1.00 |
| AdjDel/Veh:               | 64.2        | 36.6 | 36.6 | 52.5        | 41.1 | 31.5 | 58.6       | 50.4 | 50.4 | 57.7       | 47.2 | 47.2 |
| LOS by Move:              | E           | D    | D    | D           | D    | C    | E          | D    | D    | E          | D    | D    |
| HCM2k95thQ:               | 18          | 20   | 20   | 13          | 31   | 8    | 17         | 22   | 22   | 20         | 23   | 23   |

Note: Queue reported is the number of cars per lane.

BART

Level Of Service Computation Report  
 2000 HCM Operations (Future Volume Alternative)  
 AM - Bkgrd + Proj Conditions

Intersection #3064: ALUM ROCK/KING [Study Int 17]

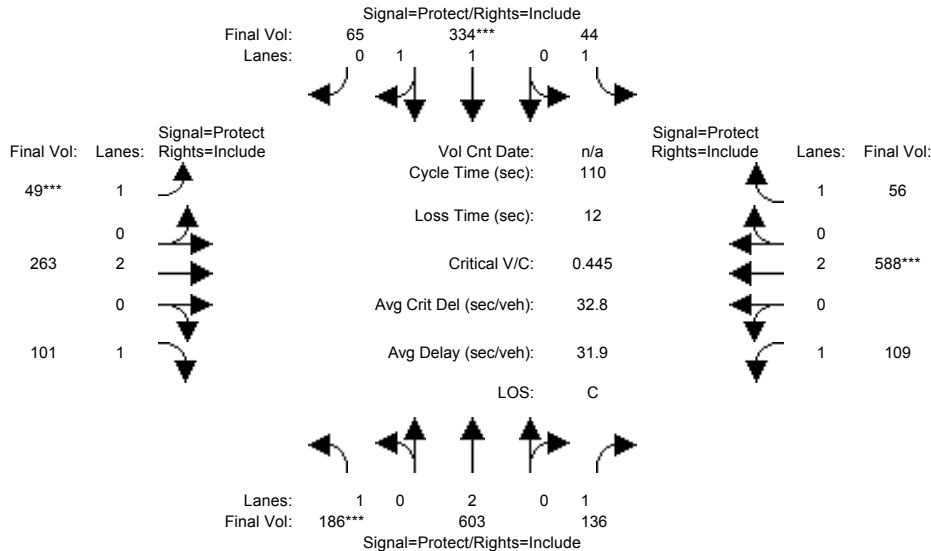

| Approach:                 | North Bound |      |      | South Bound |      |      | East Bound |      |      | West Bound |      |      |
|---------------------------|-------------|------|------|-------------|------|------|------------|------|------|------------|------|------|
| Movement:                 | L           | T    | R    | L           | T    | R    | L          | T    | R    | L          | T    | R    |
| Min. Green:               | 7           | 10   | 10   | 7           | 10   | 10   | 7          | 10   | 10   | 7          | 10   | 10   |
| Y+R:                      | 4.0         | 4.0  | 4.0  | 4.0         | 4.0  | 4.0  | 4.0        | 4.0  | 4.0  | 4.0        | 4.0  | 4.0  |
| Volume Module:            |             |      |      |             |      |      |            |      |      |            |      |      |
| Base Vol:                 | 186         | 603  | 136  | 44          | 334  | 65   | 49         | 263  | 101  | 109        | 588  | 56   |
| Growth Adj:               | 1.00        | 1.00 | 1.00 | 1.00        | 1.00 | 1.00 | 1.00       | 1.00 | 1.00 | 1.00       | 1.00 | 1.00 |
| Initial Bse:              | 186         | 603  | 136  | 44          | 334  | 65   | 49         | 263  | 101  | 109        | 588  | 56   |
| Added Vol:                | 0           | 0    | 0    | 0           | 0    | 0    | 0          | 0    | 0    | 0          | 0    | 0    |
| PasserByVol:              | 0           | 0    | 0    | 0           | 0    | 0    | 0          | 0    | 0    | 0          | 0    | 0    |
| Initial Fut:              | 186         | 603  | 136  | 44          | 334  | 65   | 49         | 263  | 101  | 109        | 588  | 56   |
| User Adj:                 | 1.00        | 1.00 | 1.00 | 1.00        | 1.00 | 1.00 | 1.00       | 1.00 | 1.00 | 1.00       | 1.00 | 1.00 |
| PHF Adj:                  | 1.00        | 1.00 | 1.00 | 1.00        | 1.00 | 1.00 | 1.00       | 1.00 | 1.00 | 1.00       | 1.00 | 1.00 |
| PHF Volume:               | 186         | 603  | 136  | 44          | 334  | 65   | 49         | 263  | 101  | 109        | 588  | 56   |
| Reduct Vol:               | 0           | 0    | 0    | 0           | 0    | 0    | 0          | 0    | 0    | 0          | 0    | 0    |
| Reduced Vol:              | 186         | 603  | 136  | 44          | 334  | 65   | 49         | 263  | 101  | 109        | 588  | 56   |
| PCE Adj:                  | 1.00        | 1.00 | 1.00 | 1.00        | 1.00 | 1.00 | 1.00       | 1.00 | 1.00 | 1.00       | 1.00 | 1.00 |
| MLF Adj:                  | 1.00        | 1.00 | 1.00 | 1.00        | 1.00 | 1.00 | 1.00       | 1.00 | 1.00 | 1.00       | 1.00 | 1.00 |
| FinalVolume:              | 186         | 603  | 136  | 44          | 334  | 65   | 49         | 263  | 101  | 109        | 588  | 56   |
| Saturation Flow Module:   |             |      |      |             |      |      |            |      |      |            |      |      |
| Sat/Lane:                 | 1900        | 1900 | 1900 | 1900        | 1900 | 1900 | 1900       | 1900 | 1900 | 1900       | 1900 | 1900 |
| Adjustment:               | 0.92        | 1.00 | 0.92 | 0.92        | 0.98 | 0.95 | 0.92       | 1.00 | 0.92 | 0.92       | 1.00 | 0.92 |
| Lanes:                    | 1.00        | 2.00 | 1.00 | 1.00        | 1.67 | 0.33 | 1.00       | 2.00 | 1.00 | 1.00       | 2.00 | 1.00 |
| Final Sat.:               | 1750        | 3800 | 1750 | 1750        | 3097 | 603  | 1750       | 3800 | 1750 | 1750       | 3800 | 1750 |
| Capacity Analysis Module: |             |      |      |             |      |      |            |      |      |            |      |      |
| Vol/Sat:                  | 0.11        | 0.16 | 0.08 | 0.03        | 0.11 | 0.11 | 0.03       | 0.07 | 0.06 | 0.06       | 0.15 | 0.03 |
| Crit Moves:               | ****        |      |      | ****        |      |      | ****       |      |      | ****       |      |      |
| Green Time:               | 26.2        | 37.7 | 37.7 | 15.1        | 26.6 | 26.6 | 7.0        | 26.6 | 26.6 | 18.6       | 38.2 | 38.2 |
| Volume/Cap:               | 0.45        | 0.46 | 0.23 | 0.18        | 0.45 | 0.45 | 0.44       | 0.29 | 0.24 | 0.37       | 0.45 | 0.09 |
| Delay/Veh:                | 36.5        | 28.5 | 26.0 | 42.3        | 35.8 | 35.8 | 52.4       | 34.2 | 33.9 | 41.3       | 28.0 | 24.3 |
| User DelAdj:              | 1.00        | 1.00 | 1.00 | 1.00        | 1.00 | 1.00 | 1.00       | 1.00 | 1.00 | 1.00       | 1.00 | 1.00 |
| AdjDel/Veh:               | 36.5        | 28.5 | 26.0 | 42.3        | 35.8 | 35.8 | 52.4       | 34.2 | 33.9 | 41.3       | 28.0 | 24.3 |
| LOS by Move:              | D           | C    | C    | D           | D    | D    | D          | C    | C    | D          | C    | C    |
| HCM2k95thQ:               | 11          | 15   | 7    | 3           | 11   | 11   | 4          | 7    | 6    | 7          | 15   | 3    |

Note: Queue reported is the number of cars per lane.

BART

Level Of Service Computation Report  
 2000 HCM Operations (Future Volume Alternative)  
 PM - Bkgrd + Proj Conditions

Intersection #3064: ALUM ROCK/KING [Study Int 17]

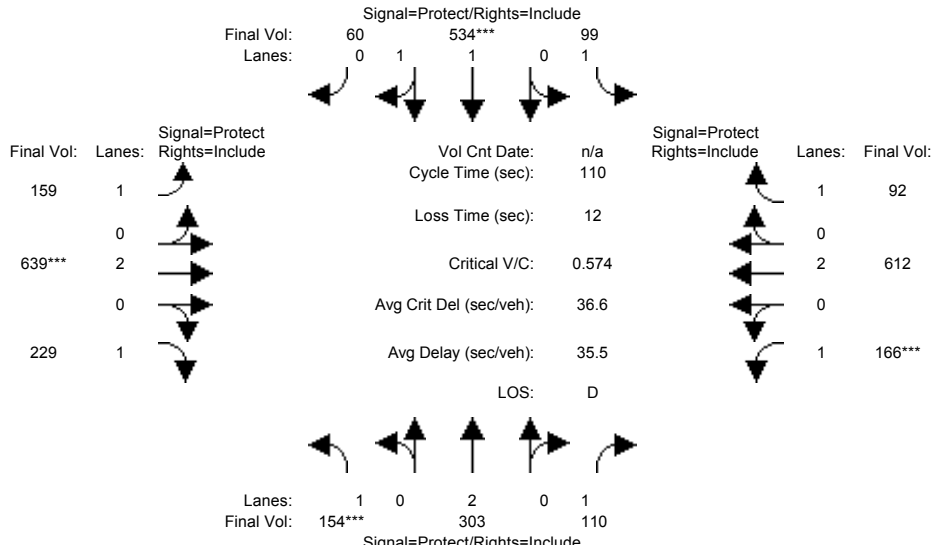

| Approach:                 | North Bound |      |      | South Bound |      |      | East Bound |      |      | West Bound |      |      |
|---------------------------|-------------|------|------|-------------|------|------|------------|------|------|------------|------|------|
| Movement:                 | L           | T    | R    | L           | T    | R    | L          | T    | R    | L          | T    | R    |
| Min. Green:               | 7           | 10   | 10   | 7           | 10   | 10   | 7          | 10   | 10   | 7          | 10   | 10   |
| Y+R:                      | 4.0         | 4.0  | 4.0  | 4.0         | 4.0  | 4.0  | 4.0        | 4.0  | 4.0  | 4.0        | 4.0  | 4.0  |
| Volume Module:            |             |      |      |             |      |      |            |      |      |            |      |      |
| Base Vol:                 | 154         | 303  | 110  | 99          | 534  | 60   | 159        | 639  | 229  | 166        | 612  | 92   |
| Growth Adj:               | 1.00        | 1.00 | 1.00 | 1.00        | 1.00 | 1.00 | 1.00       | 1.00 | 1.00 | 1.00       | 1.00 | 1.00 |
| Initial Bse:              | 154         | 303  | 110  | 99          | 534  | 60   | 159        | 639  | 229  | 166        | 612  | 92   |
| Added Vol:                | 0           | 0    | 0    | 0           | 0    | 0    | 0          | 0    | 0    | 0          | 0    | 0    |
| PasserByVol:              | 0           | 0    | 0    | 0           | 0    | 0    | 0          | 0    | 0    | 0          | 0    | 0    |
| Initial Fut:              | 154         | 303  | 110  | 99          | 534  | 60   | 159        | 639  | 229  | 166        | 612  | 92   |
| User Adj:                 | 1.00        | 1.00 | 1.00 | 1.00        | 1.00 | 1.00 | 1.00       | 1.00 | 1.00 | 1.00       | 1.00 | 1.00 |
| PHF Adj:                  | 1.00        | 1.00 | 1.00 | 1.00        | 1.00 | 1.00 | 1.00       | 1.00 | 1.00 | 1.00       | 1.00 | 1.00 |
| PHF Volume:               | 154         | 303  | 110  | 99          | 534  | 60   | 159        | 639  | 229  | 166        | 612  | 92   |
| Reduct Vol:               | 0           | 0    | 0    | 0           | 0    | 0    | 0          | 0    | 0    | 0          | 0    | 0    |
| Reduced Vol:              | 154         | 303  | 110  | 99          | 534  | 60   | 159        | 639  | 229  | 166        | 612  | 92   |
| PCE Adj:                  | 1.00        | 1.00 | 1.00 | 1.00        | 1.00 | 1.00 | 1.00       | 1.00 | 1.00 | 1.00       | 1.00 | 1.00 |
| MLF Adj:                  | 1.00        | 1.00 | 1.00 | 1.00        | 1.00 | 1.00 | 1.00       | 1.00 | 1.00 | 1.00       | 1.00 | 1.00 |
| FinalVolume:              | 154         | 303  | 110  | 99          | 534  | 60   | 159        | 639  | 229  | 166        | 612  | 92   |
| Saturation Flow Module:   |             |      |      |             |      |      |            |      |      |            |      |      |
| Sat/Lane:                 | 1900        | 1900 | 1900 | 1900        | 1900 | 1900 | 1900       | 1900 | 1900 | 1900       | 1900 | 1900 |
| Adjustment:               | 0.92        | 1.00 | 0.92 | 0.92        | 0.98 | 0.95 | 0.92       | 1.00 | 0.92 | 0.92       | 1.00 | 0.92 |
| Lanes:                    | 1.00        | 2.00 | 1.00 | 1.00        | 1.79 | 0.21 | 1.00       | 2.00 | 1.00 | 1.00       | 2.00 | 1.00 |
| Final Sat.:               | 1750        | 3800 | 1750 | 1750        | 3326 | 374  | 1750       | 3800 | 1750 | 1750       | 3800 | 1750 |
| Capacity Analysis Module: |             |      |      |             |      |      |            |      |      |            |      |      |
| Vol/Sat:                  | 0.09        | 0.08 | 0.06 | 0.06        | 0.16 | 0.16 | 0.09       | 0.17 | 0.13 | 0.09       | 0.16 | 0.05 |
| Crit Moves:               | ****        |      |      | ****        |      |      | ****       |      |      | ****       |      |      |
| Green Time:               | 16.9        | 28.0 | 28.0 | 19.6        | 30.8 | 30.8 | 18.2       | 32.2 | 32.2 | 18.2       | 32.2 | 32.2 |
| Volume/Cap:               | 0.57        | 0.31 | 0.25 | 0.32        | 0.57 | 0.57 | 0.55       | 0.57 | 0.45 | 0.57       | 0.55 | 0.18 |
| Delay/Veh:                | 46.3        | 33.4 | 32.9 | 40.0        | 34.8 | 34.8 | 44.4       | 33.8 | 32.3 | 45.1       | 33.4 | 29.2 |
| User DelAdj:              | 1.00        | 1.00 | 1.00 | 1.00        | 1.00 | 1.00 | 1.00       | 1.00 | 1.00 | 1.00       | 1.00 | 1.00 |
| AdjDel/Veh:               | 46.3        | 33.4 | 32.9 | 40.0        | 34.8 | 34.8 | 44.4       | 33.8 | 32.3 | 45.1       | 33.4 | 29.2 |
| LOS by Move:              | D           | C    | C    | D           | C    | C    | D          | C    | C    | D          | C    | C    |
| HCM2k95thQ:               | 10          | 8    | 6    | 6           | 16   | 16   | 10         | 17   | 13   | 12         | 17   | 5    |

Note: Queue reported is the number of cars per lane.

BART

Level Of Service Computation Report  
 2000 HCM Operations (Future Volume Alternative)  
 AM - Bkgrd + Proj Conditions

Intersection #3210: 101/Julian-McKee (W) [Study Int 4]

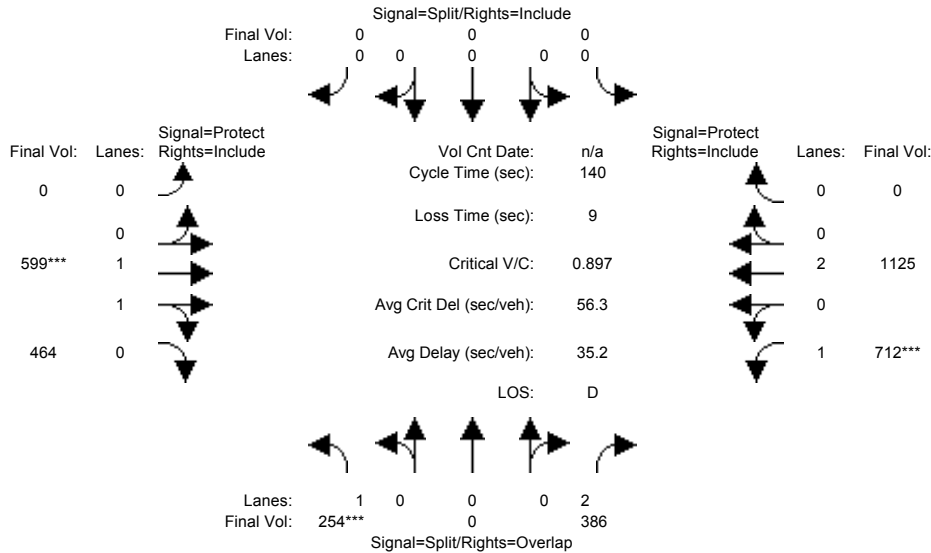

| Approach:                 | North Bound |      |      | South Bound |      |      | East Bound |      |      | West Bound |      |      |
|---------------------------|-------------|------|------|-------------|------|------|------------|------|------|------------|------|------|
| Movement:                 | L           | T    | R    | L           | T    | R    | L          | T    | R    | L          | T    | R    |
| Min. Green:               | 10          | 0    | 10   | 0           | 0    | 0    | 0          | 10   | 10   | 7          | 10   | 0    |
| Y+R:                      | 4.0         | 4.0  | 4.0  | 4.0         | 4.0  | 4.0  | 4.0        | 4.0  | 4.0  | 4.0        | 4.0  | 0    |
| Volume Module:            |             |      |      |             |      |      |            |      |      |            |      |      |
| Base Vol:                 | 254         | 0    | 386  | 0           | 0    | 0    | 0          | 599  | 464  | 712        | 1125 | 0    |
| Growth Adj:               | 1.00        | 1.00 | 1.00 | 1.00        | 1.00 | 1.00 | 1.00       | 1.00 | 1.00 | 1.00       | 1.00 | 1.00 |
| Initial Bse:              | 254         | 0    | 386  | 0           | 0    | 0    | 0          | 599  | 464  | 712        | 1125 | 0    |
| Added Vol:                | 0           | 0    | 0    | 0           | 0    | 0    | 0          | 0    | 0    | 0          | 0    | 0    |
| PasserByVol:              | 0           | 0    | 0    | 0           | 0    | 0    | 0          | 0    | 0    | 0          | 0    | 0    |
| Initial Fut:              | 254         | 0    | 386  | 0           | 0    | 0    | 0          | 599  | 464  | 712        | 1125 | 0    |
| User Adj:                 | 1.00        | 1.00 | 1.00 | 1.00        | 1.00 | 1.00 | 1.00       | 1.00 | 1.00 | 1.00       | 1.00 | 1.00 |
| PHF Adj:                  | 1.00        | 1.00 | 1.00 | 1.00        | 1.00 | 1.00 | 1.00       | 1.00 | 1.00 | 1.00       | 1.00 | 1.00 |
| PHF Volume:               | 254         | 0    | 386  | 0           | 0    | 0    | 0          | 599  | 464  | 712        | 1125 | 0    |
| Reduct Vol:               | 0           | 0    | 0    | 0           | 0    | 0    | 0          | 0    | 0    | 0          | 0    | 0    |
| Reduced Vol:              | 254         | 0    | 386  | 0           | 0    | 0    | 0          | 599  | 464  | 712        | 1125 | 0    |
| PCE Adj:                  | 1.00        | 1.00 | 1.00 | 1.00        | 1.00 | 1.00 | 1.00       | 1.00 | 1.00 | 1.00       | 1.00 | 1.00 |
| MLF Adj:                  | 1.00        | 1.00 | 1.00 | 1.00        | 1.00 | 1.00 | 1.00       | 1.00 | 1.00 | 1.00       | 1.00 | 1.00 |
| FinalVolume:              | 254         | 0    | 386  | 0           | 0    | 0    | 0          | 599  | 464  | 712        | 1125 | 0    |
| Saturation Flow Module:   |             |      |      |             |      |      |            |      |      |            |      |      |
| Sat/Lane:                 | 1900        | 1900 | 1900 | 1900        | 1900 | 1900 | 1900       | 1900 | 1900 | 1900       | 1900 | 1900 |
| Adjustment:               | 0.92        | 1.00 | 0.83 | 0.92        | 1.00 | 0.92 | 0.92       | 0.99 | 0.95 | 0.92       | 1.00 | 0.92 |
| Lanes:                    | 1.00        | 0.00 | 2.00 | 0.00        | 0.00 | 0.00 | 0.00       | 1.10 | 0.90 | 1.00       | 2.00 | 0.00 |
| Final Sat.:               | 1750        | 0    | 3150 | 0           | 0    | 0    | 0          | 2084 | 1614 | 1750       | 3800 | 0    |
| Capacity Analysis Module: |             |      |      |             |      |      |            |      |      |            |      |      |
| Vol/Sat:                  | 0.15        | 0.00 | 0.12 | 0.00        | 0.00 | 0.00 | 0.00       | 0.29 | 0.29 | 0.41       | 0.30 | 0.00 |
| Crit Moves:               | ****        |      |      |             |      |      | ****       |      |      | ****       |      |      |
| Green Time:               | 22.6        | 0.0  | 86.1 | 0.0         | 0.0  | 0.0  | 0.0        | 44.9 | 44.9 | 63.5       | 108  | 0.0  |
| Volume/Cap:               | 0.90        | 0.00 | 0.20 | 0.00        | 0.00 | 0.00 | 0.00       | 0.90 | 0.90 | 0.90       | 0.38 | 0.00 |
| Delay/Veh:                | 86.2        | 0.0  | 11.9 | 0.0         | 0.0  | 0.0  | 0.0        | 54.6 | 54.6 | 48.2       | 5.2  | 0.0  |
| User DelAdj:              | 1.00        | 1.00 | 1.00 | 1.00        | 1.00 | 1.00 | 1.00       | 1.00 | 1.00 | 1.00       | 1.00 | 1.00 |
| AdjDel/Veh:               | 86.2        | 0.0  | 11.9 | 0.0         | 0.0  | 0.0  | 0.0        | 54.6 | 54.6 | 48.2       | 5.2  | 0.0  |
| LOS by Move:              | F           | A    | B    | A           | A    | A    | A          | D    | D    | D          | A    | A    |
| HCM2k95thQ:               | 26          | 0    | 8    | 0           | 0    | 0    | 0          | 39   | 39   | 53         | 14   | 0    |

Note: Queue reported is the number of cars per lane.

BART

Level Of Service Computation Report  
 2000 HCM Operations (Future Volume Alternative)  
 PM - Bkgrd + Proj Conditions

Intersection #3210: 101/Julian-McKee (W) [Study Int 4]

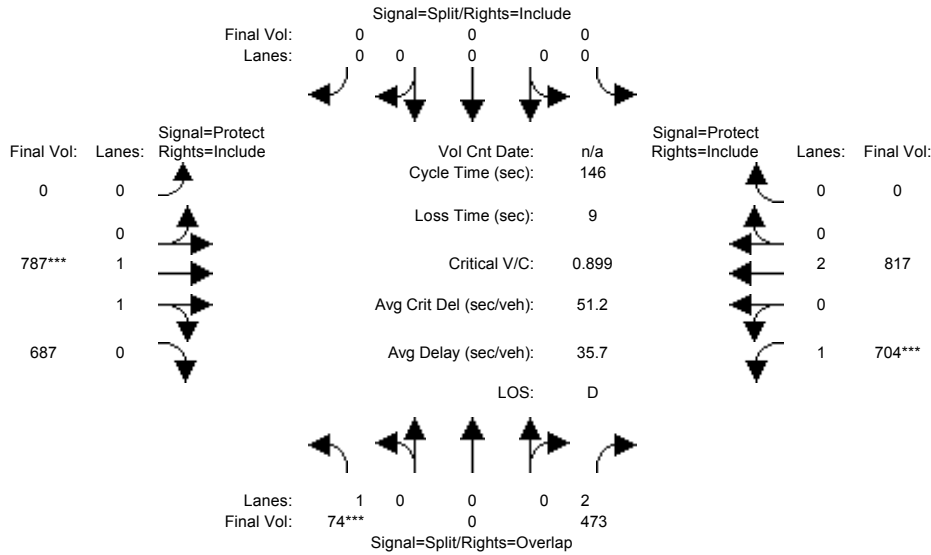

| Approach:                 | North Bound |      |      | South Bound |      |      | East Bound |      |      | West Bound |      |      |
|---------------------------|-------------|------|------|-------------|------|------|------------|------|------|------------|------|------|
| Movement:                 | L           | T    | R    | L           | T    | R    | L          | T    | R    | L          | T    | R    |
| Min. Green:               | 10          | 0    | 10   | 0           | 0    | 0    | 0          | 10   | 10   | 7          | 10   | 0    |
| Y+R:                      | 4.0         | 4.0  | 4.0  | 4.0         | 4.0  | 4.0  | 4.0        | 4.0  | 4.0  | 4.0        | 4.0  | 4.0  |
| Volume Module:            |             |      |      |             |      |      |            |      |      |            |      |      |
| Base Vol:                 | 74          | 0    | 473  | 0           | 0    | 0    | 0          | 787  | 687  | 704        | 817  | 0    |
| Growth Adj:               | 1.00        | 1.00 | 1.00 | 1.00        | 1.00 | 1.00 | 1.00       | 1.00 | 1.00 | 1.00       | 1.00 | 1.00 |
| Initial Bse:              | 74          | 0    | 473  | 0           | 0    | 0    | 0          | 787  | 687  | 704        | 817  | 0    |
| Added Vol:                | 0           | 0    | 0    | 0           | 0    | 0    | 0          | 0    | 0    | 0          | 0    | 0    |
| PasserByVol:              | 0           | 0    | 0    | 0           | 0    | 0    | 0          | 0    | 0    | 0          | 0    | 0    |
| Initial Fut:              | 74          | 0    | 473  | 0           | 0    | 0    | 0          | 787  | 687  | 704        | 817  | 0    |
| User Adj:                 | 1.00        | 1.00 | 1.00 | 1.00        | 1.00 | 1.00 | 1.00       | 1.00 | 1.00 | 1.00       | 1.00 | 1.00 |
| PHF Adj:                  | 1.00        | 1.00 | 1.00 | 1.00        | 1.00 | 1.00 | 1.00       | 1.00 | 1.00 | 1.00       | 1.00 | 1.00 |
| PHF Volume:               | 74          | 0    | 473  | 0           | 0    | 0    | 0          | 787  | 687  | 704        | 817  | 0    |
| Reduct Vol:               | 0           | 0    | 0    | 0           | 0    | 0    | 0          | 0    | 0    | 0          | 0    | 0    |
| Reduced Vol:              | 74          | 0    | 473  | 0           | 0    | 0    | 0          | 787  | 687  | 704        | 817  | 0    |
| PCE Adj:                  | 1.00        | 1.00 | 1.00 | 1.00        | 1.00 | 1.00 | 1.00       | 1.00 | 1.00 | 1.00       | 1.00 | 1.00 |
| MLF Adj:                  | 1.00        | 1.00 | 1.00 | 1.00        | 1.00 | 1.00 | 1.00       | 1.00 | 1.00 | 1.00       | 1.00 | 1.00 |
| FinalVolume:              | 74          | 0    | 473  | 0           | 0    | 0    | 0          | 787  | 687  | 704        | 817  | 0    |
| Saturation Flow Module:   |             |      |      |             |      |      |            |      |      |            |      |      |
| Sat/Lane:                 | 1900        | 1900 | 1900 | 1900        | 1900 | 1900 | 1900       | 1900 | 1900 | 1900       | 1900 | 1900 |
| Adjustment:               | 0.92        | 1.00 | 0.83 | 0.92        | 1.00 | 0.92 | 0.92       | 1.00 | 0.95 | 0.92       | 1.00 | 0.92 |
| Lanes:                    | 1.00        | 0.00 | 2.00 | 0.00        | 0.00 | 0.00 | 0.00       | 1.04 | 0.96 | 1.00       | 2.00 | 0.00 |
| Final Sat.:               | 1750        | 0    | 3150 | 0           | 0    | 0    | 0          | 1974 | 1723 | 1750       | 3800 | 0    |
| Capacity Analysis Module: |             |      |      |             |      |      |            |      |      |            |      |      |
| Vol/Sat:                  | 0.04        | 0.00 | 0.15 | 0.00        | 0.00 | 0.00 | 0.00       | 0.40 | 0.40 | 0.40       | 0.22 | 0.00 |
| Crit Moves:               | ****        |      |      |             |      |      | ****       |      | **** |            |      |      |
| Green Time:               | 10.0        | 0.0  | 73.8 | 0.0         | 0.0  | 0.0  | 0.0        | 63.2 | 63.2 | 63.8       | 127  | 0.0  |
| Volume/Cap:               | 0.62        | 0.00 | 0.30 | 0.00        | 0.00 | 0.00 | 0.00       | 0.92 | 0.92 | 0.92       | 0.25 | 0.00 |
| Delay/Veh:                | 75.5        | 0.0  | 21.1 | 0.0         | 0.0  | 0.0  | 0.0        | 48.1 | 48.1 | 55.1       | 1.6  | 0.0  |
| User DelAdj:              | 1.00        | 1.00 | 1.00 | 1.00        | 1.00 | 1.00 | 1.00       | 1.00 | 1.00 | 1.00       | 1.00 | 1.00 |
| AdjDel/Veh:               | 75.5        | 0.0  | 21.1 | 0.0         | 0.0  | 0.0  | 0.0        | 48.1 | 48.1 | 55.1       | 1.6  | 0.0  |
| LOS by Move:              | E           | A    | C    | A           | A    | A    | A          | D    | D    | E          | A    | A    |
| HCM2k95thQ:               | 9           | 0    | 14   | 0           | 0    | 0    | 0          | 54   | 54   | 56         | 6    | 0    |

Note: Queue reported is the number of cars per lane.

BART

Level Of Service Computation Report  
 2000 HCM Operations (Future Volume Alternative)  
 AM - Bkgrd + Proj Conditions

Intersection #3211: 101/McKee(E) [Study Int 5]

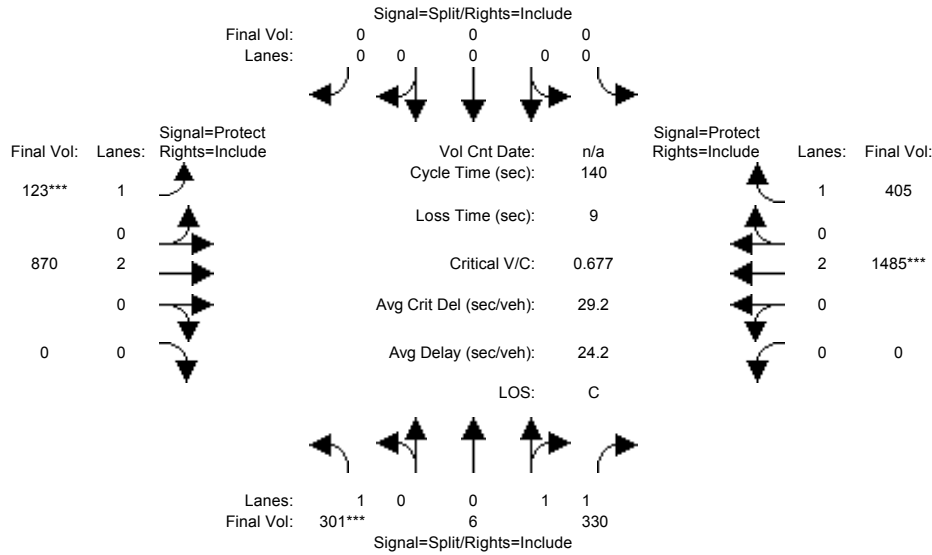

| Approach:                 | North Bound |      |      | South Bound |      |      | East Bound |      |      | West Bound |      |      |
|---------------------------|-------------|------|------|-------------|------|------|------------|------|------|------------|------|------|
| Movement:                 | L           | T    | R    | L           | T    | R    | L          | T    | R    | L          | T    | R    |
| Min. Green:               | 10          | 10   | 10   | 0           | 0    | 0    | 7          | 10   | 0    | 0          | 10   | 10   |
| Y+R:                      | 4.0         | 4.0  | 4.0  | 4.0         | 4.0  | 4.0  | 4.0        | 4.0  | 4.0  | 4.0        | 4.0  | 4.0  |
| Volume Module:            |             |      |      |             |      |      |            |      |      |            |      |      |
| Base Vol:                 | 301         | 6    | 330  | 0           | 0    | 0    | 123        | 870  | 0    | 0          | 1485 | 405  |
| Growth Adj:               | 1.00        | 1.00 | 1.00 | 1.00        | 1.00 | 1.00 | 1.00       | 1.00 | 1.00 | 1.00       | 1.00 | 1.00 |
| Initial Bse:              | 301         | 6    | 330  | 0           | 0    | 0    | 123        | 870  | 0    | 0          | 1485 | 405  |
| Added Vol:                | 0           | 0    | 0    | 0           | 0    | 0    | 0          | 0    | 0    | 0          | 0    | 0    |
| PasserByVol:              | 0           | 0    | 0    | 0           | 0    | 0    | 0          | 0    | 0    | 0          | 0    | 0    |
| Initial Fut:              | 301         | 6    | 330  | 0           | 0    | 0    | 123        | 870  | 0    | 0          | 1485 | 405  |
| User Adj:                 | 1.00        | 1.00 | 1.00 | 1.00        | 1.00 | 1.00 | 1.00       | 1.00 | 1.00 | 1.00       | 1.00 | 1.00 |
| PHF Adj:                  | 1.00        | 1.00 | 1.00 | 1.00        | 1.00 | 1.00 | 1.00       | 1.00 | 1.00 | 1.00       | 1.00 | 1.00 |
| PHF Volume:               | 301         | 6    | 330  | 0           | 0    | 0    | 123        | 870  | 0    | 0          | 1485 | 405  |
| Reduct Vol:               | 0           | 0    | 0    | 0           | 0    | 0    | 0          | 0    | 0    | 0          | 0    | 0    |
| Reduced Vol:              | 301         | 6    | 330  | 0           | 0    | 0    | 123        | 870  | 0    | 0          | 1485 | 405  |
| PCE Adj:                  | 1.00        | 1.00 | 1.00 | 1.00        | 1.00 | 1.00 | 1.00       | 1.00 | 1.00 | 1.00       | 1.00 | 1.00 |
| MLF Adj:                  | 1.00        | 1.00 | 1.00 | 1.00        | 1.00 | 1.00 | 1.00       | 1.00 | 1.00 | 1.00       | 1.00 | 1.00 |
| FinalVolume:              | 301         | 6    | 330  | 0           | 0    | 0    | 123        | 870  | 0    | 0          | 1485 | 405  |
| Saturation Flow Module:   |             |      |      |             |      |      |            |      |      |            |      |      |
| Sat/Lane:                 | 1900        | 1900 | 1900 | 1900        | 1900 | 1900 | 1900       | 1900 | 1900 | 1900       | 1900 | 1900 |
| Adjustment:               | 0.92        | 0.95 | 0.95 | 0.92        | 1.00 | 0.92 | 0.92       | 1.00 | 0.92 | 0.92       | 1.00 | 0.92 |
| Lanes:                    | 1.00        | 0.04 | 1.96 | 0.00        | 0.00 | 0.00 | 1.00       | 2.00 | 0.00 | 0.00       | 2.00 | 1.00 |
| Final Sat.:               | 1750        | 64   | 3536 | 0           | 0    | 0    | 1750       | 3800 | 0    | 0          | 3800 | 1750 |
| Capacity Analysis Module: |             |      |      |             |      |      |            |      |      |            |      |      |
| Vol/Sat:                  | 0.17        | 0.09 | 0.09 | 0.00        | 0.00 | 0.00 | 0.07       | 0.23 | 0.00 | 0.00       | 0.39 | 0.23 |
| Crit Moves:               | ****        |      |      |             |      |      | ****       |      |      | ****       |      |      |
| Green Time:               | 35.6        | 35.6 | 35.6 | 0.0         | 0.0  | 0.0  | 14.5       | 95.4 | 0.0  | 0.0        | 80.9 | 80.9 |
| Volume/Cap:               | 0.68        | 0.37 | 0.37 | 0.00        | 0.00 | 0.00 | 0.68       | 0.34 | 0.00 | 0.00       | 0.68 | 0.40 |
| Delay/Veh:                | 51.2        | 43.2 | 43.2 | 0.0         | 0.0  | 0.0  | 70.2       | 9.3  | 0.0  | 0.0        | 21.4 | 16.5 |
| User DelAdj:              | 1.00        | 1.00 | 1.00 | 1.00        | 1.00 | 1.00 | 1.00       | 1.00 | 1.00 | 1.00       | 1.00 | 1.00 |
| AdjDel/Veh:               | 51.2        | 43.2 | 43.2 | 0.0         | 0.0  | 0.0  | 70.2       | 9.3  | 0.0  | 0.0        | 21.4 | 16.5 |
| LOS by Move:              | D           | D    | D    | A           | A    | A    | E          | A    | A    | A          | C    | B    |
| HCM2k95thQ:               | 24          | 12   | 12   | 0           | 0    | 0    | 13         | 14   | 0    | 0          | 36   | 18   |

Note: Queue reported is the number of cars per lane.



BART

Level Of Service Computation Report  
 2000 HCM Operations (Future Volume Alternative)  
 PM - Bkgrd + Proj Conditions

Intersection #3211: 101/McKee(E) [Study Int 5]

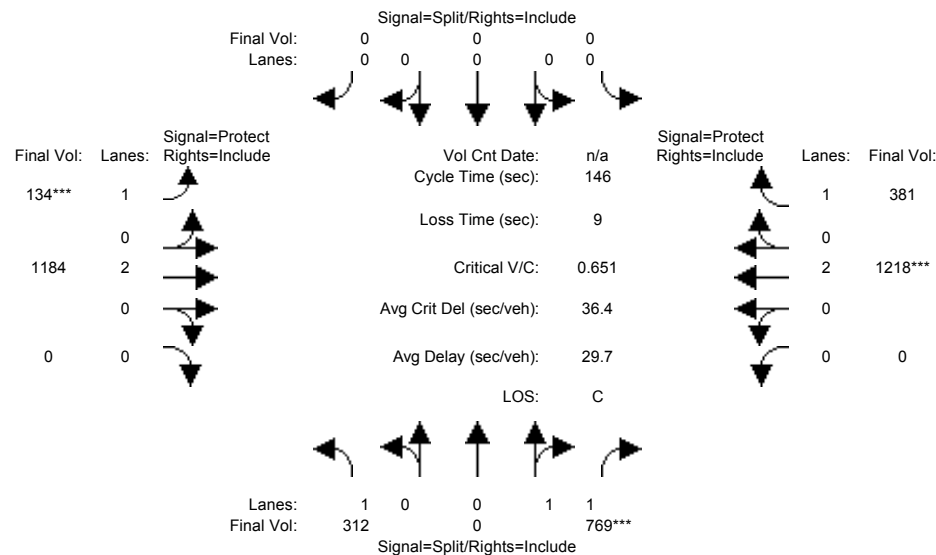

| Approach:                 | North Bound |      |      | South Bound |      |      | East Bound |      |      | West Bound |      |      |
|---------------------------|-------------|------|------|-------------|------|------|------------|------|------|------------|------|------|
| Movement:                 | L           | T    | R    | L           | T    | R    | L          | T    | R    | L          | T    | R    |
| Min. Green:               | 10          | 10   | 10   | 0           | 0    | 0    | 7          | 10   | 0    | 0          | 10   | 10   |
| Y+R:                      | 4.0         | 4.0  | 4.0  | 4.0         | 4.0  | 4.0  | 4.0        | 4.0  | 4.0  | 4.0        | 4.0  | 4.0  |
| Volume Module:            |             |      |      |             |      |      |            |      |      |            |      |      |
| Base Vol:                 | 312         | 0    | 769  | 0           | 0    | 0    | 134        | 1184 | 0    | 0          | 1218 | 381  |
| Growth Adj:               | 1.00        | 1.00 | 1.00 | 1.00        | 1.00 | 1.00 | 1.00       | 1.00 | 1.00 | 1.00       | 1.00 | 1.00 |
| Initial Bse:              | 312         | 0    | 769  | 0           | 0    | 0    | 134        | 1184 | 0    | 0          | 1218 | 381  |
| Added Vol:                | 0           | 0    | 0    | 0           | 0    | 0    | 0          | 0    | 0    | 0          | 0    | 0    |
| PasserByVol:              | 0           | 0    | 0    | 0           | 0    | 0    | 0          | 0    | 0    | 0          | 0    | 0    |
| Initial Fut:              | 312         | 0    | 769  | 0           | 0    | 0    | 134        | 1184 | 0    | 0          | 1218 | 381  |
| User Adj:                 | 1.00        | 1.00 | 1.00 | 1.00        | 1.00 | 1.00 | 1.00       | 1.00 | 1.00 | 1.00       | 1.00 | 1.00 |
| PHF Adj:                  | 1.00        | 1.00 | 1.00 | 1.00        | 1.00 | 1.00 | 1.00       | 1.00 | 1.00 | 1.00       | 1.00 | 1.00 |
| PHF Volume:               | 312         | 0    | 769  | 0           | 0    | 0    | 134        | 1184 | 0    | 0          | 1218 | 381  |
| Reduct Vol:               | 0           | 0    | 0    | 0           | 0    | 0    | 0          | 0    | 0    | 0          | 0    | 0    |
| Reduced Vol:              | 312         | 0    | 769  | 0           | 0    | 0    | 134        | 1184 | 0    | 0          | 1218 | 381  |
| PCE Adj:                  | 1.00        | 1.00 | 1.00 | 1.00        | 1.00 | 1.00 | 1.00       | 1.00 | 1.00 | 1.00       | 1.00 | 1.00 |
| MLF Adj:                  | 1.00        | 1.00 | 1.00 | 1.00        | 1.00 | 1.00 | 1.00       | 1.00 | 1.00 | 1.00       | 1.00 | 1.00 |
| Final Volume:             | 312         | 0    | 769  | 0           | 0    | 0    | 134        | 1184 | 0    | 0          | 1218 | 381  |
| Saturation Flow Module:   |             |      |      |             |      |      |            |      |      |            |      |      |
| Sat/Lane:                 | 1900        | 1900 | 1900 | 1900        | 1900 | 1900 | 1900       | 1900 | 1900 | 1900       | 1900 | 1900 |
| Adjustment:               | 0.92        | 1.00 | 0.95 | 0.92        | 1.00 | 0.92 | 0.92       | 1.00 | 0.92 | 0.92       | 1.00 | 0.92 |
| Lanes:                    | 1.00        | 0.00 | 2.00 | 0.00        | 0.00 | 0.00 | 1.00       | 2.00 | 0.00 | 0.00       | 2.00 | 1.00 |
| Final Sat.:               | 1750        | 0    | 3600 | 0           | 0    | 0    | 1750       | 3800 | 0    | 0          | 3800 | 1750 |
| Capacity Analysis Module: |             |      |      |             |      |      |            |      |      |            |      |      |
| Vol/Sat:                  | 0.18        | 0.00 | 0.21 | 0.00        | 0.00 | 0.00 | 0.08       | 0.31 | 0.00 | 0.00       | 0.32 | 0.22 |
| Crit Moves:               | ****        |      |      | ****        |      |      | ****       |      |      | ****       |      |      |
| Green Time:               | 47.9        | 0.0  | 47.9 | 0.0         | 0.0  | 0.0  | 17.2       | 89.1 | 0.0  | 0.0        | 71.9 | 71.9 |
| Volume/Cap:               | 0.54        | 0.00 | 0.65 | 0.00        | 0.00 | 0.00 | 0.65       | 0.51 | 0.00 | 0.00       | 0.65 | 0.44 |
| Delay/Veh:                | 41.2        | 0.0  | 43.2 | 0.0         | 0.0  | 0.0  | 68.7       | 16.3 | 0.0  | 0.0        | 28.5 | 24.4 |
| User DelAdj:              | 1.00        | 1.00 | 1.00 | 1.00        | 1.00 | 1.00 | 1.00       | 1.00 | 1.00 | 1.00       | 1.00 | 1.00 |
| AdjDel/Veh:               | 41.2        | 0.0  | 43.2 | 0.0         | 0.0  | 0.0  | 68.7       | 16.3 | 0.0  | 0.0        | 28.5 | 24.4 |
| LOS by Move:              | D           | A    | D    | A           | A    | A    | E          | B    | A    | A          | C    | C    |
| HCM2k95thQ:               | 22          | 0    | 28   | 0           | 0    | 0    | 14         | 26   | 0    | 0          | 33   | 21   |

Note: Queue reported is the number of cars per lane.

BART

Level Of Service Computation Report  
 2000 HCM Operations (Future Volume Alternative)  
 AM - Bkgrd + Proj Conditions

Intersection #3260: ALUM ROCK/33rd [Study Int 16]

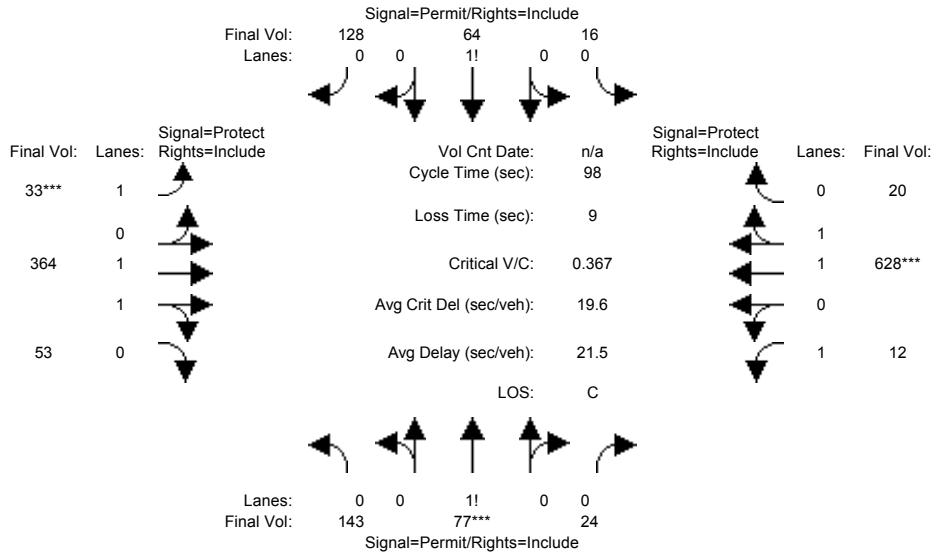

| Approach:                 | North Bound |      |      | South Bound |      |      | East Bound |      |      | West Bound |      |      |
|---------------------------|-------------|------|------|-------------|------|------|------------|------|------|------------|------|------|
| Movement:                 | L           | T    | R    | L           | T    | R    | L          | T    | R    | L          | T    | R    |
| Min. Green:               | 10          | 10   | 10   | 10          | 10   | 10   | 7          | 10   | 10   | 7          | 10   | 10   |
| Y+R:                      | 4.0         | 4.0  | 4.0  | 4.0         | 4.0  | 4.0  | 4.0        | 4.0  | 4.0  | 4.0        | 4.0  | 4.0  |
| Volume Module:            |             |      |      |             |      |      |            |      |      |            |      |      |
| Base Vol:                 | 143         | 77   | 24   | 16          | 64   | 128  | 33         | 364  | 53   | 12         | 628  | 20   |
| Growth Adj:               | 1.00        | 1.00 | 1.00 | 1.00        | 1.00 | 1.00 | 1.00       | 1.00 | 1.00 | 1.00       | 1.00 | 1.00 |
| Initial Bse:              | 143         | 77   | 24   | 16          | 64   | 128  | 33         | 364  | 53   | 12         | 628  | 20   |
| Added Vol:                | 0           | 0    | 0    | 0           | 0    | 0    | 0          | 0    | 0    | 0          | 0    | 0    |
| PasserByVol:              | 0           | 0    | 0    | 0           | 0    | 0    | 0          | 0    | 0    | 0          | 0    | 0    |
| Initial Fut:              | 143         | 77   | 24   | 16          | 64   | 128  | 33         | 364  | 53   | 12         | 628  | 20   |
| User Adj:                 | 1.00        | 1.00 | 1.00 | 1.00        | 1.00 | 1.00 | 1.00       | 1.00 | 1.00 | 1.00       | 1.00 | 1.00 |
| PHF Adj:                  | 1.00        | 1.00 | 1.00 | 1.00        | 1.00 | 1.00 | 1.00       | 1.00 | 1.00 | 1.00       | 1.00 | 1.00 |
| PHF Volume:               | 143         | 77   | 24   | 16          | 64   | 128  | 33         | 364  | 53   | 12         | 628  | 20   |
| Reduct Vol:               | 0           | 0    | 0    | 0           | 0    | 0    | 0          | 0    | 0    | 0          | 0    | 0    |
| Reduced Vol:              | 143         | 77   | 24   | 16          | 64   | 128  | 33         | 364  | 53   | 12         | 628  | 20   |
| PCE Adj:                  | 1.00        | 1.00 | 1.00 | 1.00        | 1.00 | 1.00 | 1.00       | 1.00 | 1.00 | 1.00       | 1.00 | 1.00 |
| MLF Adj:                  | 1.00        | 1.00 | 1.00 | 1.00        | 1.00 | 1.00 | 1.00       | 1.00 | 1.00 | 1.00       | 1.00 | 1.00 |
| Final Volume:             | 143         | 77   | 24   | 16          | 64   | 128  | 33         | 364  | 53   | 12         | 628  | 20   |
| Saturation Flow Module:   |             |      |      |             |      |      |            |      |      |            |      |      |
| Sat/Lane:                 | 1900        | 1900 | 1900 | 1900        | 1900 | 1900 | 1900       | 1900 | 1900 | 1900       | 1900 | 1900 |
| Adjustment:               | 0.92        | 0.92 | 0.92 | 0.92        | 0.92 | 0.92 | 0.92       | 0.98 | 0.95 | 0.92       | 0.97 | 0.95 |
| Lanes:                    | 0.59        | 0.31 | 0.10 | 0.08        | 0.31 | 0.61 | 1.00       | 1.74 | 0.26 | 1.00       | 1.94 | 0.06 |
| Final Sat.:               | 1026        | 552  | 172  | 135         | 538  | 1077 | 1750       | 3229 | 470  | 1750       | 3586 | 114  |
| Capacity Analysis Module: |             |      |      |             |      |      |            |      |      |            |      |      |
| Vol/Sat:                  | 0.14        | 0.14 | 0.14 | 0.12        | 0.12 | 0.12 | 0.02       | 0.11 | 0.11 | 0.01       | 0.18 | 0.18 |
| Crit Moves:               | ****        |      |      | ****        |      |      | ****       |      |      | ****       |      |      |
| Green Time:               | 36.3        | 36.3 | 36.3 | 36.3        | 36.3 | 36.3 | 7.0        | 32.2 | 32.2 | 20.4       | 45.7 | 45.7 |
| Volume/Cap:               | 0.38        | 0.38 | 0.38 | 0.32        | 0.32 | 0.32 | 0.26       | 0.34 | 0.34 | 0.03       | 0.38 | 0.38 |
| Delay/Veh:                | 22.9        | 22.9 | 22.9 | 22.3        | 22.3 | 22.3 | 44.2       | 25.0 | 25.0 | 31.0       | 17.1 | 17.1 |
| User DelAdj:              | 1.00        | 1.00 | 1.00 | 1.00        | 1.00 | 1.00 | 1.00       | 1.00 | 1.00 | 1.00       | 1.00 | 1.00 |
| AdjDel/Veh:               | 22.9        | 22.9 | 22.9 | 22.3        | 22.3 | 22.3 | 44.2       | 25.0 | 25.0 | 31.0       | 17.1 | 17.1 |
| LOS by Move:              | C           | C    | C    | C           | C    | C    | D          | C    | C    | C          | B    | B    |
| HCM2k95thQ:               | 11          | 11   | 11   | 9           | 9    | 9    | 2          | 9    | 9    | 1          | 12   | 12   |

Note: Queue reported is the number of cars per lane.

BART

Level Of Service Computation Report  
 2000 HCM Operations (Future Volume Alternative)  
 PM - Bkgrd + Proj Conditions

Intersection #3260: ALUM ROCK/33rd [Study Int 16]

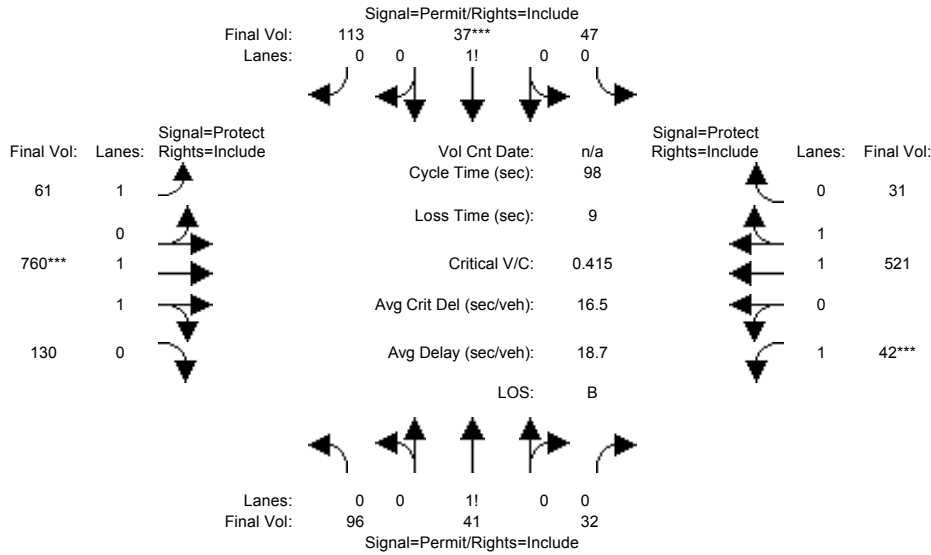

| Approach:                 | North Bound |      |      | South Bound |      |      | East Bound |      |      | West Bound |      |      |
|---------------------------|-------------|------|------|-------------|------|------|------------|------|------|------------|------|------|
| Movement:                 | L           | T    | R    | L           | T    | R    | L          | T    | R    | L          | T    | R    |
| Min. Green:               | 10          | 10   | 10   | 10          | 10   | 10   | 7          | 10   | 10   | 7          | 10   | 10   |
| Y+R:                      | 4.0         | 4.0  | 4.0  | 4.0         | 4.0  | 4.0  | 4.0        | 4.0  | 4.0  | 4.0        | 4.0  | 4.0  |
| Volume Module:            |             |      |      |             |      |      |            |      |      |            |      |      |
| Base Vol:                 | 96          | 41   | 32   | 47          | 37   | 113  | 61         | 760  | 130  | 42         | 521  | 31   |
| Growth Adj:               | 1.00        | 1.00 | 1.00 | 1.00        | 1.00 | 1.00 | 1.00       | 1.00 | 1.00 | 1.00       | 1.00 | 1.00 |
| Initial Bse:              | 96          | 41   | 32   | 47          | 37   | 113  | 61         | 760  | 130  | 42         | 521  | 31   |
| Added Vol:                | 0           | 0    | 0    | 0           | 0    | 0    | 0          | 0    | 0    | 0          | 0    | 0    |
| PasserByVol:              | 0           | 0    | 0    | 0           | 0    | 0    | 0          | 0    | 0    | 0          | 0    | 0    |
| Initial Fut:              | 96          | 41   | 32   | 47          | 37   | 113  | 61         | 760  | 130  | 42         | 521  | 31   |
| User Adj:                 | 1.00        | 1.00 | 1.00 | 1.00        | 1.00 | 1.00 | 1.00       | 1.00 | 1.00 | 1.00       | 1.00 | 1.00 |
| PHF Adj:                  | 1.00        | 1.00 | 1.00 | 1.00        | 1.00 | 1.00 | 1.00       | 1.00 | 1.00 | 1.00       | 1.00 | 1.00 |
| PHF Volume:               | 96          | 41   | 32   | 47          | 37   | 113  | 61         | 760  | 130  | 42         | 521  | 31   |
| Reduct Vol:               | 0           | 0    | 0    | 0           | 0    | 0    | 0          | 0    | 0    | 0          | 0    | 0    |
| Reduced Vol:              | 96          | 41   | 32   | 47          | 37   | 113  | 61         | 760  | 130  | 42         | 521  | 31   |
| PCE Adj:                  | 1.00        | 1.00 | 1.00 | 1.00        | 1.00 | 1.00 | 1.00       | 1.00 | 1.00 | 1.00       | 1.00 | 1.00 |
| MLF Adj:                  | 1.00        | 1.00 | 1.00 | 1.00        | 1.00 | 1.00 | 1.00       | 1.00 | 1.00 | 1.00       | 1.00 | 1.00 |
| Final Volume:             | 96          | 41   | 32   | 47          | 37   | 113  | 61         | 760  | 130  | 42         | 521  | 31   |
| Saturation Flow Module:   |             |      |      |             |      |      |            |      |      |            |      |      |
| Sat/Lane:                 | 1900        | 1900 | 1900 | 1900        | 1900 | 1900 | 1900       | 1900 | 1900 | 1900       | 1900 | 1900 |
| Adjustment:               | 0.92        | 0.92 | 0.92 | 0.92        | 0.92 | 0.92 | 0.92       | 0.98 | 0.95 | 0.92       | 0.98 | 0.95 |
| Lanes:                    | 0.57        | 0.24 | 0.19 | 0.24        | 0.19 | 0.57 | 1.00       | 1.70 | 0.30 | 1.00       | 1.88 | 0.12 |
| Final Sat.:               | 994         | 425  | 331  | 418         | 329  | 1004 | 1750       | 3159 | 540  | 1750       | 3492 | 208  |
| Capacity Analysis Module: |             |      |      |             |      |      |            |      |      |            |      |      |
| Vol/Sat:                  | 0.10        | 0.10 | 0.10 | 0.11        | 0.11 | 0.11 | 0.03       | 0.24 | 0.24 | 0.02       | 0.15 | 0.15 |
| Crit Moves:               |             |      |      | ****        |      |      | ****       |      |      | ****       |      |      |
| Green Time:               | 26.1        | 26.1 | 26.1 | 26.1        | 26.1 | 26.1 | 20.4       | 55.9 | 55.9 | 7.0        | 42.5 | 42.5 |
| Volume/Cap:               | 0.36        | 0.36 | 0.36 | 0.42        | 0.42 | 0.42 | 0.17       | 0.42 | 0.42 | 0.34       | 0.34 | 0.34 |
| Delay/Veh:                | 29.6        | 29.6 | 29.6 | 30.3        | 30.3 | 30.3 | 32.1       | 12.1 | 12.1 | 44.9       | 18.6 | 18.6 |
| User DelAdj:              | 1.00        | 1.00 | 1.00 | 1.00        | 1.00 | 1.00 | 1.00       | 1.00 | 1.00 | 1.00       | 1.00 | 1.00 |
| AdjDel/Veh:               | 29.6        | 29.6 | 29.6 | 30.3        | 30.3 | 30.3 | 32.1       | 12.1 | 12.1 | 44.9       | 18.6 | 18.6 |
| LOS by Move:              | C           | C    | C    | C           | C    | C    | C          | B    | B    | D          | B    | B    |
| HCM2k95thQ:               | 9           | 9    | 9    | 10          | 10   | 10   | 3          | 14   | 14   | 3          | 11   | 11   |

Note: Queue reported is the number of cars per lane.

BART

Level Of Service Computation Report  
 2000 HCM Operations (Future Volume Alternative)  
 AM - Bkgrd + Proj Conditions

Intersection #3384: JACKSON/CAPITOL/SAN ANTONIO [Study Int 23]

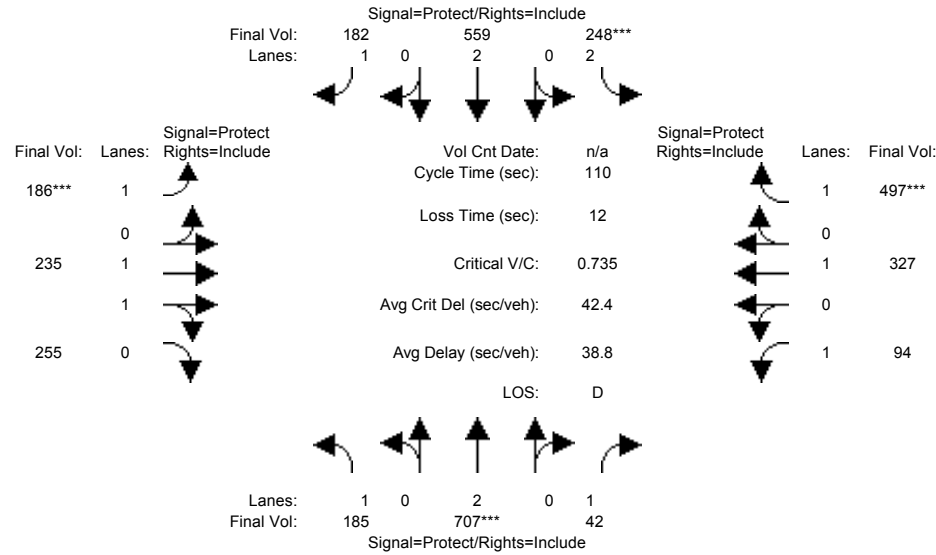

| Approach:                 | North Bound |      |      | South Bound |      |      | East Bound |      |      | West Bound |      |      |
|---------------------------|-------------|------|------|-------------|------|------|------------|------|------|------------|------|------|
| Movement:                 | L           | T    | R    | L           | T    | R    | L          | T    | R    | L          | T    | R    |
| Min. Green:               | 7           | 10   | 10   | 7           | 10   | 10   | 7          | 10   | 10   | 7          | 10   | 10   |
| Y+R:                      | 4.0         | 4.0  | 4.0  | 4.0         | 4.0  | 4.0  | 4.0        | 4.0  | 4.0  | 4.0        | 4.0  | 4.0  |
| Volume Module:            |             |      |      |             |      |      |            |      |      |            |      |      |
| Base Vol:                 | 185         | 707  | 42   | 248         | 559  | 182  | 186        | 235  | 255  | 94         | 327  | 497  |
| Growth Adj:               | 1.00        | 1.00 | 1.00 | 1.00        | 1.00 | 1.00 | 1.00       | 1.00 | 1.00 | 1.00       | 1.00 | 1.00 |
| Initial Bse:              | 185         | 707  | 42   | 248         | 559  | 182  | 186        | 235  | 255  | 94         | 327  | 497  |
| Added Vol:                | 0           | 0    | 0    | 0           | 0    | 0    | 0          | 0    | 0    | 0          | 0    | 0    |
| PasserByVol:              | 0           | 0    | 0    | 0           | 0    | 0    | 0          | 0    | 0    | 0          | 0    | 0    |
| Initial Fut:              | 185         | 707  | 42   | 248         | 559  | 182  | 186        | 235  | 255  | 94         | 327  | 497  |
| User Adj:                 | 1.00        | 1.00 | 1.00 | 1.00        | 1.00 | 1.00 | 1.00       | 1.00 | 1.00 | 1.00       | 1.00 | 1.00 |
| PHF Adj:                  | 1.00        | 1.00 | 1.00 | 1.00        | 1.00 | 1.00 | 1.00       | 1.00 | 1.00 | 1.00       | 1.00 | 1.00 |
| PHF Volume:               | 185         | 707  | 42   | 248         | 559  | 182  | 186        | 235  | 255  | 94         | 327  | 497  |
| Reduct Vol:               | 0           | 0    | 0    | 0           | 0    | 0    | 0          | 0    | 0    | 0          | 0    | 0    |
| Reduced Vol:              | 185         | 707  | 42   | 248         | 559  | 182  | 186        | 235  | 255  | 94         | 327  | 497  |
| PCE Adj:                  | 1.00        | 1.00 | 1.00 | 1.00        | 1.00 | 1.00 | 1.00       | 1.00 | 1.00 | 1.00       | 1.00 | 1.00 |
| MLF Adj:                  | 1.00        | 1.00 | 1.00 | 1.00        | 1.00 | 1.00 | 1.00       | 1.00 | 1.00 | 1.00       | 1.00 | 1.00 |
| Final Volume:             | 185         | 707  | 42   | 248         | 559  | 182  | 186        | 235  | 255  | 94         | 327  | 497  |
| Saturation Flow Module:   |             |      |      |             |      |      |            |      |      |            |      |      |
| Sat/Lane:                 | 1900        | 1900 | 1900 | 1900        | 1900 | 1900 | 1900       | 1900 | 1900 | 1900       | 1900 | 1900 |
| Adjustment:               | 0.92        | 1.00 | 0.92 | 0.83        | 1.00 | 0.92 | 0.92       | 1.00 | 0.92 | 0.92       | 1.00 | 0.92 |
| Lanes:                    | 1.00        | 2.00 | 1.00 | 2.00        | 2.00 | 1.00 | 1.00       | 1.00 | 1.00 | 1.00       | 1.00 | 1.00 |
| Final Sat.:               | 1750        | 3800 | 1750 | 3150        | 3800 | 1750 | 1750       | 1900 | 1750 | 1750       | 1900 | 1750 |
| Capacity Analysis Module: |             |      |      |             |      |      |            |      |      |            |      |      |
| Vol/Sat:                  | 0.11        | 0.19 | 0.02 | 0.08        | 0.15 | 0.10 | 0.11       | 0.12 | 0.15 | 0.05       | 0.17 | 0.28 |
| Crit Moves:               | ****        | **** | **** | ****        | **** | **** | ****       | **** | **** | ****       | **** | **** |
| Green Time:               | 16.6        | 27.8 | 27.8 | 11.8        | 23.0 | 23.0 | 15.9       | 40.6 | 40.6 | 17.7       | 42.5 | 42.5 |
| Volume/Cap:               | 0.70        | 0.74 | 0.09 | 0.74        | 0.70 | 0.50 | 0.74       | 0.33 | 0.39 | 0.33       | 0.45 | 0.74 |
| Delay/Veh:                | 52.6        | 40.7 | 31.5 | 55.8        | 43.1 | 39.4 | 55.7       | 25.1 | 25.8 | 41.6       | 25.5 | 33.1 |
| User DelAdj:              | 1.00        | 1.00 | 1.00 | 1.00        | 1.00 | 1.00 | 1.00       | 1.00 | 1.00 | 1.00       | 1.00 | 1.00 |
| AdjDel/Veh:               | 52.6        | 40.7 | 31.5 | 55.8        | 43.1 | 39.4 | 55.7       | 25.1 | 25.8 | 41.6       | 25.5 | 33.1 |
| LOS by Move:              | D           | D    | C    | E           | D    | D    | E          | C    | C    | D          | C    | C    |
| HCM2k95thQ:               | 13          | 20   | 2    | 13          | 18   | 12   | 13         | 11   | 13   | 7          | 15   | 29   |

Note: Queue reported is the number of cars per lane.

BART

Level Of Service Computation Report  
 2000 HCM Operations (Future Volume Alternative)  
 PM - Bkgrd + Proj Conditions

Intersection #3384: JACKSON/CAPITOL/SAN ANTONIO [Study Int 23]

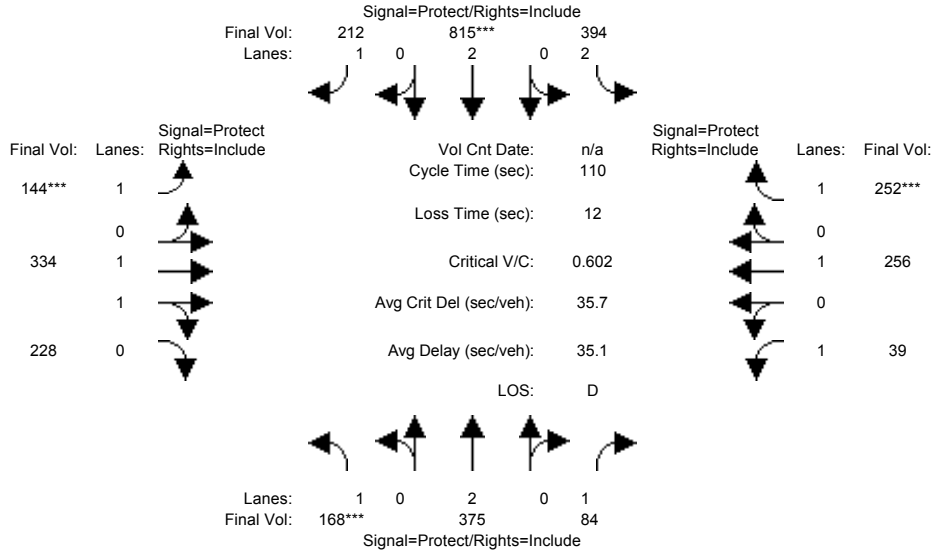

| Approach:                 | North Bound |      |      | South Bound |      |      | East Bound |      |      | West Bound |      |      |
|---------------------------|-------------|------|------|-------------|------|------|------------|------|------|------------|------|------|
| Movement:                 | L           | T    | R    | L           | T    | R    | L          | T    | R    | L          | T    | R    |
| Min. Green:               | 7           | 10   | 10   | 7           | 10   | 10   | 7          | 10   | 10   | 7          | 10   | 10   |
| Y+R:                      | 4.0         | 4.0  | 4.0  | 4.0         | 4.0  | 4.0  | 4.0        | 4.0  | 4.0  | 4.0        | 4.0  | 4.0  |
| Volume Module:            |             |      |      |             |      |      |            |      |      |            |      |      |
| Base Vol:                 | 168         | 375  | 84   | 394         | 815  | 212  | 144        | 334  | 228  | 39         | 256  | 252  |
| Growth Adj:               | 1.00        | 1.00 | 1.00 | 1.00        | 1.00 | 1.00 | 1.00       | 1.00 | 1.00 | 1.00       | 1.00 | 1.00 |
| Initial Bse:              | 168         | 375  | 84   | 394         | 815  | 212  | 144        | 334  | 228  | 39         | 256  | 252  |
| Added Vol:                | 0           | 0    | 0    | 0           | 0    | 0    | 0          | 0    | 0    | 0          | 0    | 0    |
| PasserByVol:              | 0           | 0    | 0    | 0           | 0    | 0    | 0          | 0    | 0    | 0          | 0    | 0    |
| Initial Fut:              | 168         | 375  | 84   | 394         | 815  | 212  | 144        | 334  | 228  | 39         | 256  | 252  |
| User Adj:                 | 1.00        | 1.00 | 1.00 | 1.00        | 1.00 | 1.00 | 1.00       | 1.00 | 1.00 | 1.00       | 1.00 | 1.00 |
| PHF Adj:                  | 1.00        | 1.00 | 1.00 | 1.00        | 1.00 | 1.00 | 1.00       | 1.00 | 1.00 | 1.00       | 1.00 | 1.00 |
| PHF Volume:               | 168         | 375  | 84   | 394         | 815  | 212  | 144        | 334  | 228  | 39         | 256  | 252  |
| Reduct Vol:               | 0           | 0    | 0    | 0           | 0    | 0    | 0          | 0    | 0    | 0          | 0    | 0    |
| Reduced Vol:              | 168         | 375  | 84   | 394         | 815  | 212  | 144        | 334  | 228  | 39         | 256  | 252  |
| PCE Adj:                  | 1.00        | 1.00 | 1.00 | 1.00        | 1.00 | 1.00 | 1.00       | 1.00 | 1.00 | 1.00       | 1.00 | 1.00 |
| MLF Adj:                  | 1.00        | 1.00 | 1.00 | 1.00        | 1.00 | 1.00 | 1.00       | 1.00 | 1.00 | 1.00       | 1.00 | 1.00 |
| FinalVolume:              | 168         | 375  | 84   | 394         | 815  | 212  | 144        | 334  | 228  | 39         | 256  | 252  |
| Saturation Flow Module:   |             |      |      |             |      |      |            |      |      |            |      |      |
| Sat/Lane:                 | 1900        | 1900 | 1900 | 1900        | 1900 | 1900 | 1900       | 1900 | 1900 | 1900       | 1900 | 1900 |
| Adjustment:               | 0.92        | 1.00 | 0.92 | 0.83        | 1.00 | 0.92 | 0.92       | 0.99 | 0.95 | 0.92       | 1.00 | 0.92 |
| Lanes:                    | 1.00        | 2.00 | 1.00 | 2.00        | 2.00 | 1.00 | 1.00       | 1.17 | 0.83 | 1.00       | 1.00 | 1.00 |
| Final Sat.:               | 1750        | 3800 | 1750 | 3150        | 3800 | 1750 | 1750       | 2198 | 1500 | 1750       | 1900 | 1750 |
| Capacity Analysis Module: |             |      |      |             |      |      |            |      |      |            |      |      |
| Vol/Sat:                  | 0.10        | 0.10 | 0.05 | 0.13        | 0.21 | 0.12 | 0.08       | 0.15 | 0.15 | 0.02       | 0.13 | 0.14 |
| Crit Moves:               | ****        |      |      | ****        |      |      | ****       |      |      | ****       |      |      |
| Green Time:               | 17.5        | 25.0 | 25.0 | 31.7        | 39.2 | 39.2 | 15.0       | 29.1 | 29.1 | 12.2       | 26.3 | 26.3 |
| Volume/Cap:               | 0.60        | 0.43 | 0.21 | 0.43        | 0.60 | 0.34 | 0.60       | 0.57 | 0.57 | 0.20       | 0.56 | 0.60 |
| Delay/Veh:                | 46.7        | 36.8 | 34.8 | 32.2        | 29.8 | 26.3 | 49.0       | 35.9 | 35.9 | 45.0       | 38.4 | 39.7 |
| User DelAdj:              | 1.00        | 1.00 | 1.00 | 1.00        | 1.00 | 1.00 | 1.00       | 1.00 | 1.00 | 1.00       | 1.00 | 1.00 |
| AdjDel/Veh:               | 46.7        | 36.8 | 34.8 | 32.2        | 29.8 | 26.3 | 49.0       | 35.9 | 35.9 | 45.0       | 38.4 | 39.7 |
| LOS by Move:              | D           | D    | C    | C           | C    | C    | D          | D    | D    | D          | D    | D    |
| HCM2k95thQ:               | 11          | 10   | 5    | 13          | 21   | 11   | 10         | 16   | 16   | 3          | 15   | 17   |

Note: Queue reported is the number of cars per lane.

BART

Level Of Service Computation Report  
 2000 HCM Operations (Future Volume Alternative)  
 AM - Bkgrd + Proj Conditions

Intersection #3411: AVIATION/COLEMAN [Study Int 34]

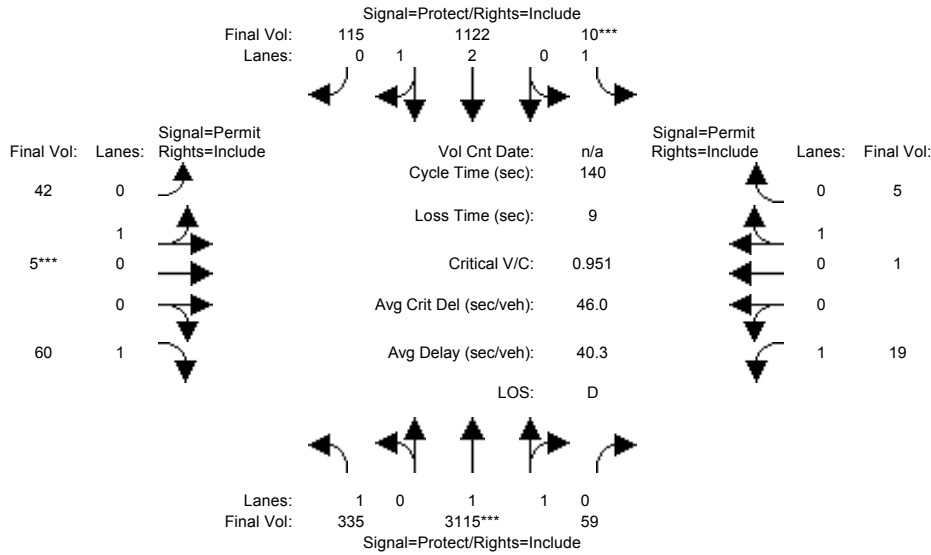

| Approach:                 | North Bound |      |       | South Bound |      |      | East Bound |      |      | West Bound |      |      |
|---------------------------|-------------|------|-------|-------------|------|------|------------|------|------|------------|------|------|
| Movement:                 | L           | T    | R     | L           | T    | R    | L          | T    | R    | L          | T    | R    |
| Min. Green:               | 7           | 10   | 10    | 7           | 10   | 10   | 10         | 10   | 10   | 10         | 10   | 10   |
| Y+R:                      | 4.0         | 4.0  | 4.0   | 4.0         | 4.0  | 4.0  | 4.0        | 4.0  | 4.0  | 4.0        | 4.0  | 4.0  |
| Volume Module:            |             |      |       |             |      |      |            |      |      |            |      |      |
| Base Vol:                 | 335         | 3115 | 59    | 10          | 1122 | 115  | 42         | 5    | 60   | 19         | 1    | 5    |
| Growth Adj:               | 1.00        | 1.00 | 1.00  | 1.00        | 1.00 | 1.00 | 1.00       | 1.00 | 1.00 | 1.00       | 1.00 | 1.00 |
| Initial Bse:              | 335         | 3115 | 59    | 10          | 1122 | 115  | 42         | 5    | 60   | 19         | 1    | 5    |
| Added Vol:                | 0           | 0    | 0     | 0           | 0    | 0    | 0          | 0    | 0    | 0          | 0    | 0    |
| PasserByVol:              | 0           | 0    | 0     | 0           | 0    | 0    | 0          | 0    | 0    | 0          | 0    | 0    |
| Initial Fut:              | 335         | 3115 | 59    | 10          | 1122 | 115  | 42         | 5    | 60   | 19         | 1    | 5    |
| User Adj:                 | 1.00        | 1.00 | 1.00  | 1.00        | 1.00 | 1.00 | 1.00       | 1.00 | 1.00 | 1.00       | 1.00 | 1.00 |
| PHF Adj:                  | 1.00        | 1.00 | 1.00  | 1.00        | 1.00 | 1.00 | 1.00       | 1.00 | 1.00 | 1.00       | 1.00 | 1.00 |
| PHF Volume:               | 335         | 3115 | 59    | 10          | 1122 | 115  | 42         | 5    | 60   | 19         | 1    | 5    |
| Reduct Vol:               | 0           | 0    | 0     | 0           | 0    | 0    | 0          | 0    | 0    | 0          | 0    | 0    |
| Reduced Vol:              | 335         | 3115 | 59    | 10          | 1122 | 115  | 42         | 5    | 60   | 19         | 1    | 5    |
| PCE Adj:                  | 1.00        | 1.00 | 1.00  | 1.00        | 1.00 | 1.00 | 1.00       | 1.00 | 1.00 | 1.00       | 1.00 | 1.00 |
| MLF Adj:                  | 1.00        | 1.00 | 1.00  | 1.00        | 1.00 | 1.00 | 1.00       | 1.00 | 1.00 | 1.00       | 1.00 | 1.00 |
| Final Volume:             | 335         | 3115 | 59    | 10          | 1122 | 115  | 42         | 5    | 60   | 19         | 1    | 5    |
| Saturation Flow Module:   |             |      |       |             |      |      |            |      |      |            |      |      |
| Sat/Lane:                 | 1900        | 1900 | 1900  | 1900        | 1900 | 1900 | 1900       | 1900 | 1900 | 1900       | 1900 | 1900 |
| Adjustment:               | 0.92        | 0.97 | 0.95  | 0.92        | 0.99 | 0.95 | 0.95       | 0.95 | 0.92 | 0.92       | 0.95 | 0.95 |
| Lanes:                    | 1.00        | 1.96 | 0.04  | 1.00        | 2.71 | 0.29 | 0.89       | 0.11 | 1.00 | 1.00       | 0.17 | 0.83 |
| Final Sat.:               | 1750        | 3631 | 69    | 1750        | 5079 | 521  | 1609       | 191  | 1750 | 1750       | 300  | 1500 |
| Capacity Analysis Module: |             |      |       |             |      |      |            |      |      |            |      |      |
| Vol/Sat:                  | 0.19        | 0.86 | 0.86  | 0.01        | 0.22 | 0.22 | 0.03       | 0.03 | 0.03 | 0.01       | 0.00 | 0.00 |
| Crit Moves:               | ****        | **** | ****  | ****        | **** | **** | ****       | **** | **** | ****       | **** | **** |
| Green Time:               | 56.2        | 114  | 114.0 | 7.0         | 64.8 | 64.8 | 10.0       | 10.0 | 10.0 | 10.0       | 10.0 | 10.0 |
| Volume/Cap:               | 0.48        | 1.05 | 1.05  | 0.11        | 0.48 | 0.48 | 0.37       | 0.37 | 0.48 | 0.15       | 0.05 | 0.05 |
| Delay/Veh:                | 31.6        | 45.7 | 45.7  | 64.1        | 26.0 | 26.0 | 63.7       | 63.7 | 65.4 | 61.6       | 60.7 | 60.7 |
| User DelAdj:              | 1.00        | 1.00 | 1.00  | 1.00        | 1.00 | 1.00 | 1.00       | 1.00 | 1.00 | 1.00       | 1.00 | 1.00 |
| AdjDel/Veh:               | 31.6        | 45.7 | 45.7  | 64.1        | 26.0 | 26.0 | 63.7       | 63.7 | 65.4 | 61.6       | 60.7 | 60.7 |
| LOS by Move:              | C           | D    | D     | E           | C    | C    | E          | E    | E    | E          | E    | E    |
| HCM2k95thQ:               | 20          | 121  | 121   | 1           | 21   | 21   | 5          | 5    | 7    | 2          | 1    | 1    |

Note: Queue reported is the number of cars per lane.

BART

Level Of Service Computation Report  
 2000 HCM Operations (Future Volume Alternative)  
 PM - Bkgrd + Proj Conditions

Intersection #3411: AVIATION/COLEMAN [Study Int 34]

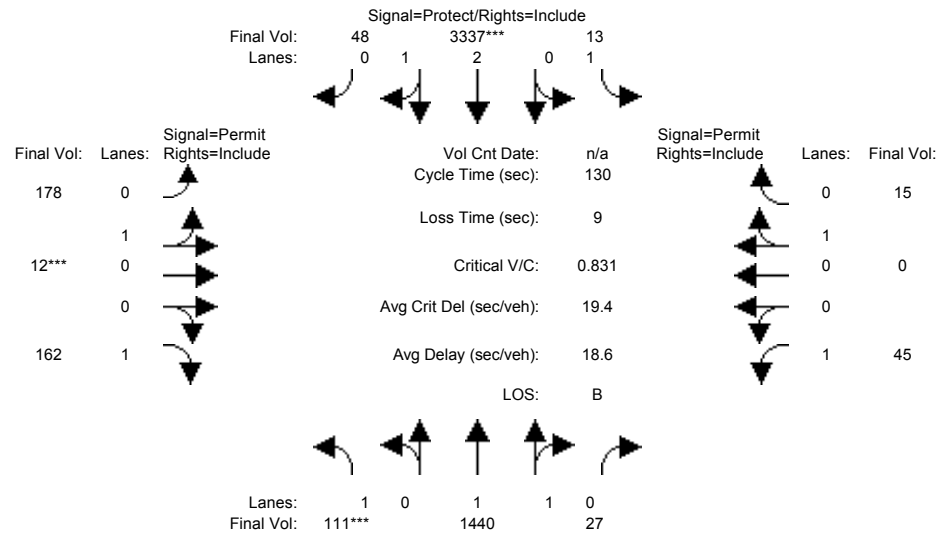

| Approach:                 | North Bound |      |      | South Bound |      |      | East Bound |      |      | West Bound |      |      |
|---------------------------|-------------|------|------|-------------|------|------|------------|------|------|------------|------|------|
| Movement:                 | L           | T    | R    | L           | T    | R    | L          | T    | R    | L          | T    | R    |
| Min. Green:               | 7           | 10   | 10   | 7           | 10   | 10   | 10         | 10   | 10   | 10         | 10   | 10   |
| Y+R:                      | 4.0         | 4.0  | 4.0  | 4.0         | 4.0  | 4.0  | 4.0        | 4.0  | 4.0  | 4.0        | 4.0  | 4.0  |
| Volume Module:            |             |      |      |             |      |      |            |      |      |            |      |      |
| Base Vol:                 | 111         | 1440 | 27   | 13          | 3337 | 48   | 178        | 12   | 162  | 45         | 0    | 15   |
| Growth Adj:               | 1.00        | 1.00 | 1.00 | 1.00        | 1.00 | 1.00 | 1.00       | 1.00 | 1.00 | 1.00       | 1.00 | 1.00 |
| Initial Bse:              | 111         | 1440 | 27   | 13          | 3337 | 48   | 178        | 12   | 162  | 45         | 0    | 15   |
| Added Vol:                | 0           | 0    | 0    | 0           | 0    | 0    | 0          | 0    | 0    | 0          | 0    | 0    |
| PasserByVol:              | 0           | 0    | 0    | 0           | 0    | 0    | 0          | 0    | 0    | 0          | 0    | 0    |
| Initial Fut:              | 111         | 1440 | 27   | 13          | 3337 | 48   | 178        | 12   | 162  | 45         | 0    | 15   |
| User Adj:                 | 1.00        | 1.00 | 1.00 | 1.00        | 1.00 | 1.00 | 1.00       | 1.00 | 1.00 | 1.00       | 1.00 | 1.00 |
| PHF Adj:                  | 1.00        | 1.00 | 1.00 | 1.00        | 1.00 | 1.00 | 1.00       | 1.00 | 1.00 | 1.00       | 1.00 | 1.00 |
| PHF Volume:               | 111         | 1440 | 27   | 13          | 3337 | 48   | 178        | 12   | 162  | 45         | 0    | 15   |
| Reduct Vol:               | 0           | 0    | 0    | 0           | 0    | 0    | 0          | 0    | 0    | 0          | 0    | 0    |
| Reduced Vol:              | 111         | 1440 | 27   | 13          | 3337 | 48   | 178        | 12   | 162  | 45         | 0    | 15   |
| PCE Adj:                  | 1.00        | 1.00 | 1.00 | 1.00        | 1.00 | 1.00 | 1.00       | 1.00 | 1.00 | 1.00       | 1.00 | 1.00 |
| MLF Adj:                  | 1.00        | 1.00 | 1.00 | 1.00        | 1.00 | 1.00 | 1.00       | 1.00 | 1.00 | 1.00       | 1.00 | 1.00 |
| Final Volume:             | 111         | 1440 | 27   | 13          | 3337 | 48   | 178        | 12   | 162  | 45         | 0    | 15   |
| Saturation Flow Module:   |             |      |      |             |      |      |            |      |      |            |      |      |
| Sat/Lane:                 | 1900        | 1900 | 1900 | 1900        | 1900 | 1900 | 1900       | 1900 | 1900 | 1900       | 1900 | 1900 |
| Adjustment:               | 0.92        | 0.97 | 0.95 | 0.92        | 0.98 | 0.95 | 0.95       | 0.95 | 0.92 | 0.92       | 1.00 | 0.95 |
| Lanes:                    | 1.00        | 1.96 | 0.04 | 1.00        | 2.96 | 0.04 | 0.94       | 0.06 | 1.00 | 1.00       | 0.00 | 1.00 |
| Final Sat.:               | 1750        | 3632 | 68   | 1750        | 5520 | 79   | 1686       | 114  | 1750 | 1750       | 0    | 1800 |
| Capacity Analysis Module: |             |      |      |             |      |      |            |      |      |            |      |      |
| Vol/Sat:                  | 0.06        | 0.40 | 0.40 | 0.01        | 0.60 | 0.60 | 0.11       | 0.11 | 0.09 | 0.03       | 0.00 | 0.01 |
| Crit Moves:               | ****        |      |      | ****        |      |      | ****       |      |      |            |      |      |
| Green Time:               | 9.9         | 92.0 | 92.0 | 12.5        | 94.6 | 94.6 | 16.5       | 16.5 | 16.5 | 16.5       | 0.0  | 16.5 |
| Volume/Cap:               | 0.83        | 0.56 | 0.56 | 0.08        | 0.83 | 0.83 | 0.83       | 0.83 | 0.73 | 0.20       | 0.00 | 0.07 |
| Delay/Veh:                | 92.8        | 9.5  | 9.5  | 53.7        | 13.8 | 13.8 | 77.3       | 77.3 | 66.1 | 51.3       | 0.0  | 50.1 |
| User DelAdj:              | 1.00        | 1.00 | 1.00 | 1.00        | 1.00 | 1.00 | 1.00       | 1.00 | 1.00 | 1.00       | 1.00 | 1.00 |
| AdjDel/Veh:               | 92.8        | 9.5  | 9.5  | 53.7        | 13.8 | 13.8 | 77.3       | 77.3 | 66.1 | 51.3       | 0.0  | 50.1 |
| LOS by Move:              | F           | A    | A    | D           | B    | B    | E          | E    | E    | D          | A    | D    |
| HCM2k95thQ:               | 10          | 26   | 26   | 1           | 47   | 47   | 19         | 19   | 15   | 4          | 0    | 1    |

Note: Queue reported is the number of cars per lane.

BART

Level Of Service Computation Report  
 2000 HCM Operations (Future Volume Alternative)  
 AM - Bkgrd + Proj Conditions

Intersection #3413: Coleman/Hedding [Study Int 38]

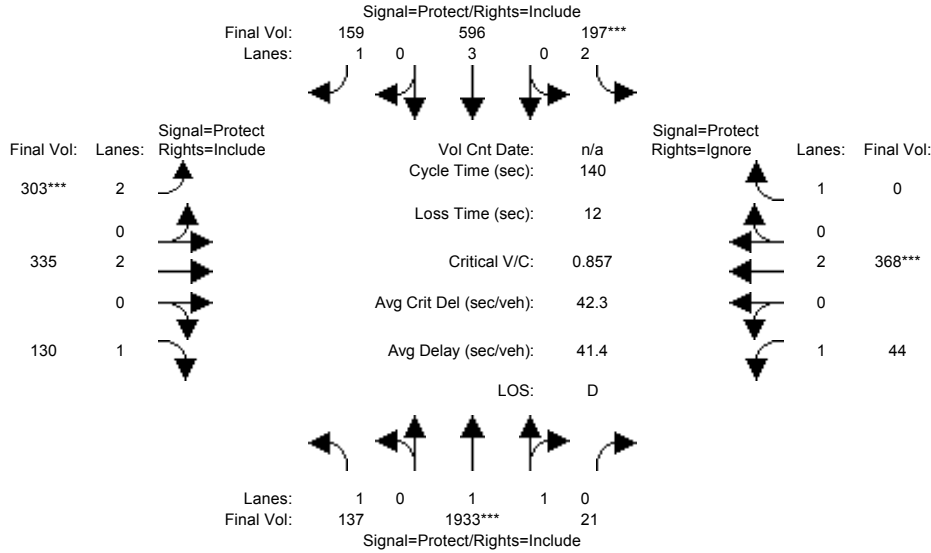

| Approach:                 | North Bound |      |      | South Bound |      |      | East Bound |      |      | West Bound |      |      |
|---------------------------|-------------|------|------|-------------|------|------|------------|------|------|------------|------|------|
| Movement:                 | L           | T    | R    | L           | T    | R    | L          | T    | R    | L          | T    | R    |
| Min. Green:               | 7           | 10   | 10   | 7           | 10   | 10   | 7          | 10   | 10   | 7          | 10   | 10   |
| Y+R:                      | 4.0         | 4.0  | 4.0  | 4.0         | 4.0  | 4.0  | 4.0        | 4.0  | 4.0  | 4.0        | 4.0  | 4.0  |
| Volume Module:            |             |      |      |             |      |      |            |      |      |            |      |      |
| Base Vol:                 | 137         | 1933 | 21   | 197         | 596  | 159  | 303        | 335  | 130  | 44         | 368  | 792  |
| Growth Adj:               | 1.00        | 1.00 | 1.00 | 1.00        | 1.00 | 1.00 | 1.00       | 1.00 | 1.00 | 1.00       | 1.00 | 1.00 |
| Initial Bse:              | 137         | 1933 | 21   | 197         | 596  | 159  | 303        | 335  | 130  | 44         | 368  | 792  |
| Added Vol:                | 0           | 0    | 0    | 0           | 0    | 0    | 0          | 0    | 0    | 0          | 0    | 0    |
| PasserByVol:              | 0           | 0    | 0    | 0           | 0    | 0    | 0          | 0    | 0    | 0          | 0    | 0    |
| Initial Fut:              | 137         | 1933 | 21   | 197         | 596  | 159  | 303        | 335  | 130  | 44         | 368  | 792  |
| User Adj:                 | 1.00        | 1.00 | 1.00 | 1.00        | 1.00 | 1.00 | 1.00       | 1.00 | 1.00 | 1.00       | 1.00 | 0.00 |
| PHF Adj:                  | 1.00        | 1.00 | 1.00 | 1.00        | 1.00 | 1.00 | 1.00       | 1.00 | 1.00 | 1.00       | 1.00 | 0.00 |
| PHF Volume:               | 137         | 1933 | 21   | 197         | 596  | 159  | 303        | 335  | 130  | 44         | 368  | 0    |
| Reduct Vol:               | 0           | 0    | 0    | 0           | 0    | 0    | 0          | 0    | 0    | 0          | 0    | 0    |
| Reduced Vol:              | 137         | 1933 | 21   | 197         | 596  | 159  | 303        | 335  | 130  | 44         | 368  | 0    |
| PCE Adj:                  | 1.00        | 1.00 | 1.00 | 1.00        | 1.00 | 1.00 | 1.00       | 1.00 | 1.00 | 1.00       | 1.00 | 0.00 |
| MLF Adj:                  | 1.00        | 1.00 | 1.00 | 1.00        | 1.00 | 1.00 | 1.00       | 1.00 | 1.00 | 1.00       | 1.00 | 0.00 |
| Final Volume:             | 137         | 1933 | 21   | 197         | 596  | 159  | 303        | 335  | 130  | 44         | 368  | 0    |
| Saturation Flow Module:   |             |      |      |             |      |      |            |      |      |            |      |      |
| Sat/Lane:                 | 1900        | 1900 | 1900 | 1900        | 1900 | 1900 | 1900       | 1900 | 1900 | 1900       | 1900 | 1900 |
| Adjustment:               | 0.92        | 0.97 | 0.95 | 0.83        | 0.83 | 0.92 | 0.83       | 1.00 | 0.92 | 0.92       | 1.00 | 0.92 |
| Lanes:                    | 1.00        | 1.98 | 0.02 | 2.00        | 3.00 | 1.00 | 2.00       | 2.00 | 1.00 | 1.00       | 2.00 | 1.00 |
| Final Sat.:               | 1750        | 3660 | 40   | 3150        | 4750 | 1750 | 3150       | 3800 | 1750 | 1750       | 3800 | 1750 |
| Capacity Analysis Module: |             |      |      |             |      |      |            |      |      |            |      |      |
| Vol/Sat:                  | 0.08        | 0.53 | 0.53 | 0.06        | 0.13 | 0.09 | 0.10       | 0.09 | 0.07 | 0.03       | 0.10 | 0.00 |
| Crit Moves:               | ****        | **** | **** | ****        | **** | **** | ****       | **** | **** | ****       | **** | **** |
| Green Time:               | 37.1        | 86.3 | 86.3 | 10.2        | 59.4 | 59.4 | 15.7       | 20.1 | 20.1 | 11.4       | 15.8 | 0.0  |
| Volume/Cap:               | 0.30        | 0.86 | 0.86 | 0.86        | 0.30 | 0.21 | 0.86       | 0.61 | 0.52 | 0.31       | 0.86 | 0.00 |
| Delay/Veh:                | 41.4        | 25.3 | 25.3 | 90.0        | 26.6 | 25.7 | 79.4       | 58.4 | 57.3 | 61.8       | 76.6 | 0.0  |
| User DelAdj:              | 1.00        | 1.00 | 1.00 | 1.00        | 1.00 | 1.00 | 1.00       | 1.00 | 1.00 | 1.00       | 1.00 | 1.00 |
| AdjDel/Veh:               | 41.4        | 25.3 | 25.3 | 90.0        | 26.6 | 25.7 | 79.4       | 58.4 | 57.3 | 61.8       | 76.6 | 0.0  |
| LOS by Move:              | D           | C    | C    | F           | C    | C    | E          | E    | E    | E          | E    | A    |
| HCM2k95thQ:               | 9           | 52   | 52   | 11          | 10   | 9    | 15         | 13   | 10   | 4          | 19   | 0    |

Note: Queue reported is the number of cars per lane.



BART

Level Of Service Computation Report  
 2000 HCM Operations (Future Volume Alternative)  
 PM - Bkgrd + Proj Conditions

Intersection #3413: Coleman/Hedding [Study Int 38]

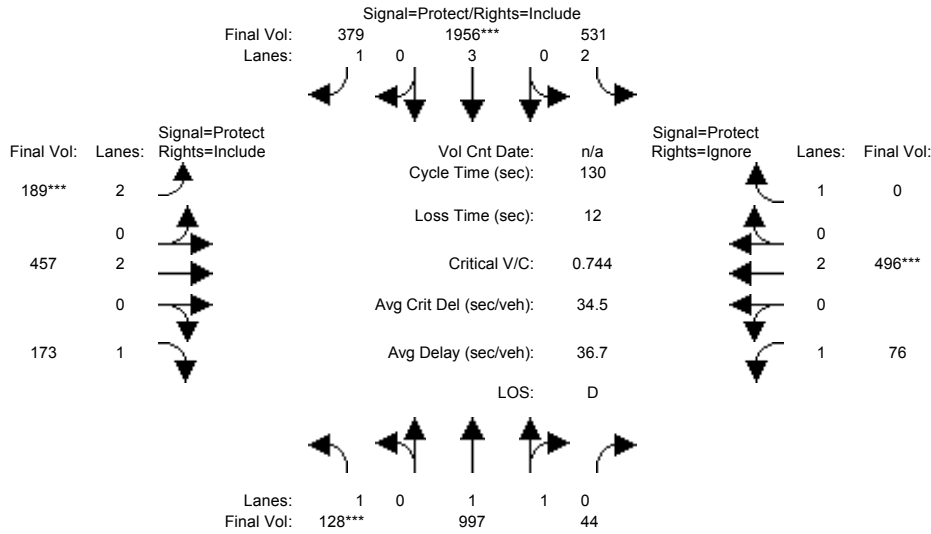

| Approach:                 | North Bound |      |      | South Bound |      |      | East Bound |      |      | West Bound |      |      |
|---------------------------|-------------|------|------|-------------|------|------|------------|------|------|------------|------|------|
| Movement:                 | L           | T    | R    | L           | T    | R    | L          | T    | R    | L          | T    | R    |
| Min. Green:               | 7           | 10   | 10   | 7           | 10   | 10   | 7          | 10   | 10   | 7          | 10   | 10   |
| Y+R:                      | 4.0         | 4.0  | 4.0  | 4.0         | 4.0  | 4.0  | 4.0        | 4.0  | 4.0  | 4.0        | 4.0  | 4.0  |
| Volume Module:            |             |      |      |             |      |      |            |      |      |            |      |      |
| Base Vol:                 | 128         | 997  | 44   | 531         | 1956 | 379  | 189        | 457  | 173  | 76         | 496  | 346  |
| Growth Adj:               | 1.00        | 1.00 | 1.00 | 1.00        | 1.00 | 1.00 | 1.00       | 1.00 | 1.00 | 1.00       | 1.00 | 1.00 |
| Initial Bse:              | 128         | 997  | 44   | 531         | 1956 | 379  | 189        | 457  | 173  | 76         | 496  | 346  |
| Added Vol:                | 0           | 0    | 0    | 0           | 0    | 0    | 0          | 0    | 0    | 0          | 0    | 0    |
| PasserByVol:              | 0           | 0    | 0    | 0           | 0    | 0    | 0          | 0    | 0    | 0          | 0    | 0    |
| Initial Fut:              | 128         | 997  | 44   | 531         | 1956 | 379  | 189        | 457  | 173  | 76         | 496  | 346  |
| User Adj:                 | 1.00        | 1.00 | 1.00 | 1.00        | 1.00 | 1.00 | 1.00       | 1.00 | 1.00 | 1.00       | 1.00 | 0.00 |
| PHF Adj:                  | 1.00        | 1.00 | 1.00 | 1.00        | 1.00 | 1.00 | 1.00       | 1.00 | 1.00 | 1.00       | 1.00 | 0.00 |
| PHF Volume:               | 128         | 997  | 44   | 531         | 1956 | 379  | 189        | 457  | 173  | 76         | 496  | 0    |
| Reduct Vol:               | 0           | 0    | 0    | 0           | 0    | 0    | 0          | 0    | 0    | 0          | 0    | 0    |
| Reduced Vol:              | 128         | 997  | 44   | 531         | 1956 | 379  | 189        | 457  | 173  | 76         | 496  | 0    |
| PCE Adj:                  | 1.00        | 1.00 | 1.00 | 1.00        | 1.00 | 1.00 | 1.00       | 1.00 | 1.00 | 1.00       | 1.00 | 0.00 |
| MLF Adj:                  | 1.00        | 1.00 | 1.00 | 1.00        | 1.00 | 1.00 | 1.00       | 1.00 | 1.00 | 1.00       | 1.00 | 0.00 |
| Final Volume:             | 128         | 997  | 44   | 531         | 1956 | 379  | 189        | 457  | 173  | 76         | 496  | 0    |
| Saturation Flow Module:   |             |      |      |             |      |      |            |      |      |            |      |      |
| Sat/Lane:                 | 1900        | 1900 | 1900 | 1900        | 1900 | 1900 | 1900       | 1900 | 1900 | 1900       | 1900 | 1900 |
| Adjustment:               | 0.92        | 0.97 | 0.95 | 0.83        | 0.83 | 0.92 | 0.83       | 1.00 | 0.92 | 0.92       | 1.00 | 0.92 |
| Lanes:                    | 1.00        | 1.91 | 0.09 | 2.00        | 3.00 | 1.00 | 2.00       | 2.00 | 1.00 | 1.00       | 2.00 | 1.00 |
| Final Sat.:               | 1750        | 3543 | 156  | 3150        | 4750 | 1750 | 3150       | 3800 | 1750 | 1750       | 3800 | 1750 |
| Capacity Analysis Module: |             |      |      |             |      |      |            |      |      |            |      |      |
| Vol/Sat:                  | 0.07        | 0.28 | 0.28 | 0.17        | 0.41 | 0.22 | 0.06       | 0.12 | 0.10 | 0.04       | 0.13 | 0.00 |
| Crit Moves:               | ****        |      |      | ****        |      |      | ****       |      |      | ****       |      |      |
| Green Time:               | 12.8        | 53.0 | 53.0 | 31.7        | 71.9 | 71.9 | 10.5       | 23.0 | 23.0 | 10.3       | 22.8 | 0.0  |
| Volume/Cap:               | 0.74        | 0.69 | 0.69 | 0.69        | 0.74 | 0.39 | 0.74       | 0.68 | 0.56 | 0.55       | 0.74 | 0.00 |
| Delay/Veh:                | 73.1        | 33.1 | 33.1 | 47.4        | 23.2 | 16.8 | 69.7       | 52.9 | 51.2 | 62.2       | 55.4 | 0.0  |
| User DelAdj:              | 1.00        | 1.00 | 1.00 | 1.00        | 1.00 | 1.00 | 1.00       | 1.00 | 1.00 | 1.00       | 1.00 | 1.00 |
| AdjDel/Veh:               | 73.1        | 33.1 | 33.1 | 47.4        | 23.2 | 16.8 | 69.7       | 52.9 | 51.2 | 62.2       | 55.4 | 0.0  |
| LOS by Move:              | E           | C    | C    | D           | C    | B    | E          | D    | D    | E          | E    | A    |
| HCM2k95thQ:               | 10          | 29   | 29   | 21          | 33   | 17   | 9          | 16   | 13   | 8          | 20   | 0    |

Note: Queue reported is the number of cars per lane.

BART

Level Of Service Computation Report  
 2000 HCM Operations (Future Volume Alternative)  
 AM - Bkgrd + Proj Conditions

Intersection #3417: Coleman/Taylor [Study Int 39]

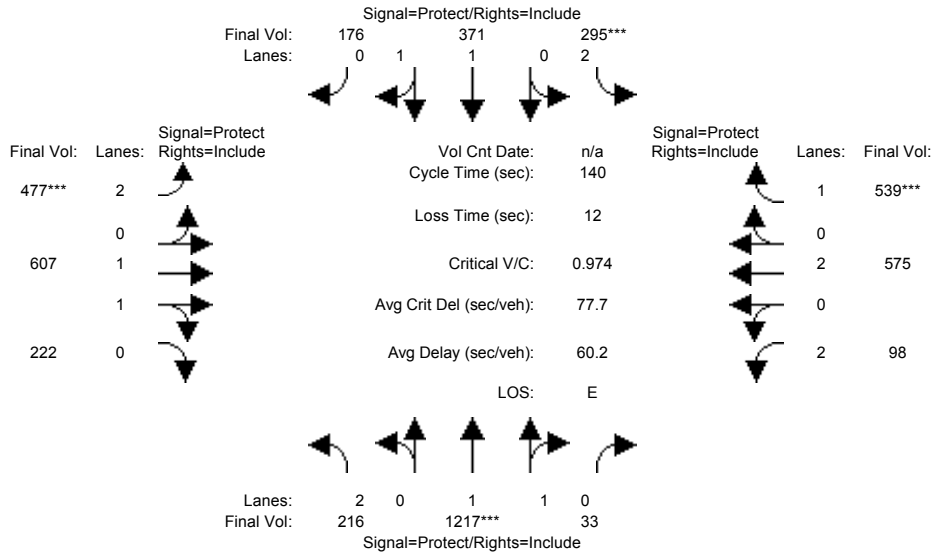

| Approach:                 | North Bound |      |      | South Bound |      |      | East Bound |      |      | West Bound |      |      |
|---------------------------|-------------|------|------|-------------|------|------|------------|------|------|------------|------|------|
| Movement:                 | L           | T    | R    | L           | T    | R    | L          | T    | R    | L          | T    | R    |
| Min. Green:               | 7           | 10   | 10   | 7           | 10   | 10   | 7          | 10   | 10   | 7          | 10   | 10   |
| Y+R:                      | 4.0         | 4.0  | 4.0  | 4.0         | 4.0  | 4.0  | 4.0        | 4.0  | 4.0  | 4.0        | 4.0  | 4.0  |
| Volume Module:            |             |      |      |             |      |      |            |      |      |            |      |      |
| Base Vol:                 | 216         | 1217 | 33   | 295         | 371  | 176  | 477        | 607  | 222  | 98         | 575  | 539  |
| Growth Adj:               | 1.00        | 1.00 | 1.00 | 1.00        | 1.00 | 1.00 | 1.00       | 1.00 | 1.00 | 1.00       | 1.00 | 1.00 |
| Initial Bse:              | 216         | 1217 | 33   | 295         | 371  | 176  | 477        | 607  | 222  | 98         | 575  | 539  |
| Added Vol:                | 0           | 0    | 0    | 0           | 0    | 0    | 0          | 0    | 0    | 0          | 0    | 0    |
| PasserByVol:              | 0           | 0    | 0    | 0           | 0    | 0    | 0          | 0    | 0    | 0          | 0    | 0    |
| Initial Fut:              | 216         | 1217 | 33   | 295         | 371  | 176  | 477        | 607  | 222  | 98         | 575  | 539  |
| User Adj:                 | 1.00        | 1.00 | 1.00 | 1.00        | 1.00 | 1.00 | 1.00       | 1.00 | 1.00 | 1.00       | 1.00 | 1.00 |
| PHF Adj:                  | 1.00        | 1.00 | 1.00 | 1.00        | 1.00 | 1.00 | 1.00       | 1.00 | 1.00 | 1.00       | 1.00 | 1.00 |
| PHF Volume:               | 216         | 1217 | 33   | 295         | 371  | 176  | 477        | 607  | 222  | 98         | 575  | 539  |
| Reduct Vol:               | 0           | 0    | 0    | 0           | 0    | 0    | 0          | 0    | 0    | 0          | 0    | 0    |
| Reduced Vol:              | 216         | 1217 | 33   | 295         | 371  | 176  | 477        | 607  | 222  | 98         | 575  | 539  |
| PCE Adj:                  | 1.00        | 1.00 | 1.00 | 1.00        | 1.00 | 1.00 | 1.00       | 1.00 | 1.00 | 1.00       | 1.00 | 1.00 |
| MLF Adj:                  | 1.00        | 1.00 | 1.00 | 1.00        | 1.00 | 1.00 | 1.00       | 1.00 | 1.00 | 1.00       | 1.00 | 1.00 |
| FinalVolume:              | 216         | 1217 | 33   | 295         | 371  | 176  | 477        | 607  | 222  | 98         | 575  | 539  |
| Saturation Flow Module:   |             |      |      |             |      |      |            |      |      |            |      |      |
| Sat/Lane:                 | 1900        | 1900 | 1900 | 1900        | 1900 | 1900 | 1900       | 1900 | 1900 | 1900       | 1900 | 1900 |
| Adjustment:               | 0.83        | 0.97 | 0.95 | 0.83        | 0.99 | 0.95 | 0.83       | 0.98 | 0.95 | 0.83       | 1.00 | 0.92 |
| Lanes:                    | 2.00        | 1.95 | 0.05 | 2.00        | 1.34 | 0.66 | 2.00       | 1.45 | 0.55 | 2.00       | 2.00 | 1.00 |
| Final Sat.:               | 3150        | 3602 | 98   | 3150        | 2509 | 1190 | 3150       | 2708 | 991  | 3150       | 3800 | 1750 |
| Capacity Analysis Module: |             |      |      |             |      |      |            |      |      |            |      |      |
| Vol/Sat:                  | 0.07        | 0.34 | 0.34 | 0.09        | 0.15 | 0.15 | 0.15       | 0.22 | 0.22 | 0.03       | 0.15 | 0.31 |
| Crit Moves:               | ****        | **** | **** | ****        | **** | **** | ****       | **** | **** | ****       | **** | **** |
| Green Time:               | 19.6        | 48.5 | 48.5 | 13.5        | 42.4 | 42.4 | 21.8       | 54.0 | 54.0 | 12.0       | 44.3 | 44.3 |
| Volume/Cap:               | 0.49        | 0.97 | 0.97 | 0.97        | 0.49 | 0.49 | 0.97       | 0.58 | 0.58 | 0.36       | 0.48 | 0.97 |
| Delay/Veh:                | 56.4        | 64.3 | 64.3 | 107.7       | 40.3 | 40.3 | 92.8       | 34.7 | 34.7 | 61.2       | 38.9 | 79.0 |
| User DelAdj:              | 1.00        | 1.00 | 1.00 | 1.00        | 1.00 | 1.00 | 1.00       | 1.00 | 1.00 | 1.00       | 1.00 | 1.00 |
| AdjDel/Veh:               | 56.4        | 64.3 | 64.3 | 107.7       | 40.3 | 40.3 | 92.8       | 34.7 | 34.7 | 61.2       | 38.9 | 79.0 |
| LOS by Move:              | E           | E    | E    | F           | D    | D    | F          | C    | C    | E          | D    | E    |
| HCM2k95thQ:               | 11          | 52   | 52   | 17          | 18   | 18   | 25         | 25   | 25   | 5          | 18   | 45   |

Note: Queue reported is the number of cars per lane.

BART

Level Of Service Computation Report  
 2000 HCM Operations (Future Volume Alternative)  
 PM - Bkgrd + Proj Conditions

Intersection #3417: Coleman/Taylor [Study Int 39]

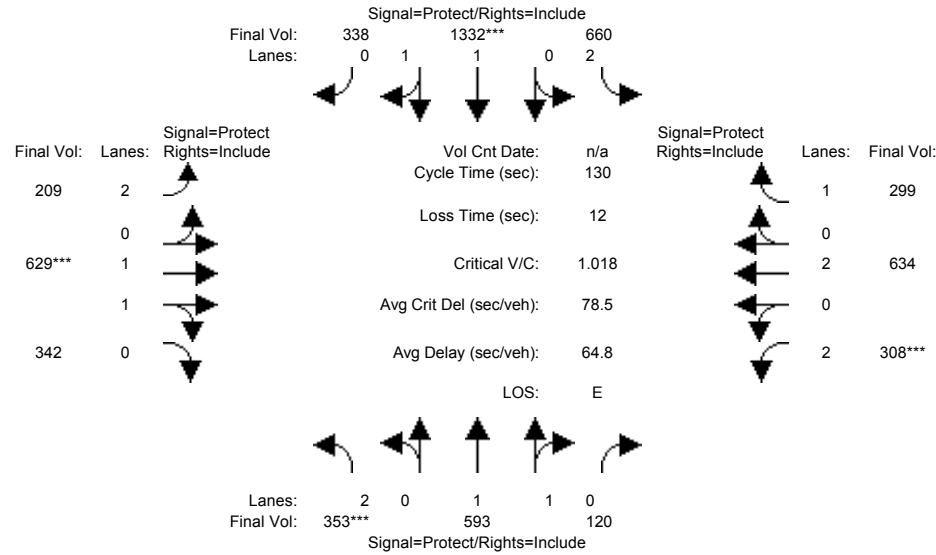

| Approach:                 | North Bound |      |      | South Bound |      |      | East Bound |      |      | West Bound |      |      |
|---------------------------|-------------|------|------|-------------|------|------|------------|------|------|------------|------|------|
| Movement:                 | L           | T    | R    | L           | T    | R    | L          | T    | R    | L          | T    | R    |
| Min. Green:               | 7           | 10   | 10   | 7           | 10   | 10   | 7          | 10   | 10   | 7          | 10   | 10   |
| Y+R:                      | 4.0         | 4.0  | 4.0  | 4.0         | 4.0  | 4.0  | 4.0        | 4.0  | 4.0  | 4.0        | 4.0  | 4.0  |
| Volume Module:            |             |      |      |             |      |      |            |      |      |            |      |      |
| Base Vol:                 | 353         | 593  | 120  | 660         | 1332 | 338  | 209        | 629  | 342  | 308        | 634  | 299  |
| Growth Adj:               | 1.00        | 1.00 | 1.00 | 1.00        | 1.00 | 1.00 | 1.00       | 1.00 | 1.00 | 1.00       | 1.00 | 1.00 |
| Initial Bse:              | 353         | 593  | 120  | 660         | 1332 | 338  | 209        | 629  | 342  | 308        | 634  | 299  |
| Added Vol:                | 0           | 0    | 0    | 0           | 0    | 0    | 0          | 0    | 0    | 0          | 0    | 0    |
| PasserByVol:              | 0           | 0    | 0    | 0           | 0    | 0    | 0          | 0    | 0    | 0          | 0    | 0    |
| Initial Fut:              | 353         | 593  | 120  | 660         | 1332 | 338  | 209        | 629  | 342  | 308        | 634  | 299  |
| User Adj:                 | 1.00        | 1.00 | 1.00 | 1.00        | 1.00 | 1.00 | 1.00       | 1.00 | 1.00 | 1.00       | 1.00 | 1.00 |
| PHF Adj:                  | 1.00        | 1.00 | 1.00 | 1.00        | 1.00 | 1.00 | 1.00       | 1.00 | 1.00 | 1.00       | 1.00 | 1.00 |
| PHF Volume:               | 353         | 593  | 120  | 660         | 1332 | 338  | 209        | 629  | 342  | 308        | 634  | 299  |
| Reduct Vol:               | 0           | 0    | 0    | 0           | 0    | 0    | 0          | 0    | 0    | 0          | 0    | 0    |
| Reduced Vol:              | 353         | 593  | 120  | 660         | 1332 | 338  | 209        | 629  | 342  | 308        | 634  | 299  |
| PCE Adj:                  | 1.00        | 1.00 | 1.00 | 1.00        | 1.00 | 1.00 | 1.00       | 1.00 | 1.00 | 1.00       | 1.00 | 1.00 |
| MLF Adj:                  | 1.00        | 1.00 | 1.00 | 1.00        | 1.00 | 1.00 | 1.00       | 1.00 | 1.00 | 1.00       | 1.00 | 1.00 |
| Final Volume:             | 353         | 593  | 120  | 660         | 1332 | 338  | 209        | 629  | 342  | 308        | 634  | 299  |
| Saturation Flow Module:   |             |      |      |             |      |      |            |      |      |            |      |      |
| Sat/Lane:                 | 1900        | 1900 | 1900 | 1900        | 1900 | 1900 | 1900       | 1900 | 1900 | 1900       | 1900 | 1900 |
| Adjustment:               | 0.83        | 0.98 | 0.95 | 0.83        | 0.98 | 0.95 | 0.83       | 0.99 | 0.95 | 0.83       | 1.00 | 0.92 |
| Lanes:                    | 2.00        | 1.65 | 0.35 | 2.00        | 1.58 | 0.42 | 2.00       | 1.28 | 0.72 | 2.00       | 2.00 | 1.00 |
| Final Sat.:               | 3150        | 3077 | 623  | 3150        | 2951 | 749  | 3150       | 2396 | 1303 | 3150       | 3800 | 1750 |
| Capacity Analysis Module: |             |      |      |             |      |      |            |      |      |            |      |      |
| Vol/Sat:                  | 0.11        | 0.19 | 0.19 | 0.21        | 0.45 | 0.45 | 0.07       | 0.26 | 0.26 | 0.10       | 0.17 | 0.17 |
| Crit Moves:               | ****        |      |      | ****        |      |      | ****       |      |      | ****       |      |      |
| Green Time:               | 14.3        | 34.5 | 34.5 | 37.5        | 57.7 | 57.7 | 12.9       | 33.5 | 33.5 | 12.5       | 33.2 | 33.2 |
| Volume/Cap:               | 1.02        | 0.73 | 0.73 | 0.73        | 1.02 | 1.02 | 0.67       | 1.02 | 1.02 | 1.02       | 0.65 | 0.67 |
| Delay/Veh:                | 110.8       | 46.2 | 46.2 | 44.6        | 62.9 | 62.9 | 62.1       | 81.9 | 81.9 | 115.1      | 44.9 | 47.4 |
| User DelAdj:              | 1.00        | 1.00 | 1.00 | 1.00        | 1.00 | 1.00 | 1.00       | 1.00 | 1.00 | 1.00       | 1.00 | 1.00 |
| AdjDel/Veh:               | 110.8       | 46.2 | 46.2 | 44.6        | 62.9 | 62.9 | 62.1       | 81.9 | 81.9 | 115.1      | 44.9 | 47.4 |
| LOS by Move:              | F           | D    | D    | D           | E    | E    | E          | F    | F    | F          | D    | D    |
| HCM2k95thQ:               | 23          | 25   | 25   | 25          | 61   | 61   | 9          | 39   | 39   | 18         | 20   | 21   |

Note: Queue reported is the number of cars per lane.

BART

Level Of Service Computation Report  
 2000 HCM Operations (Future Volume Alternative)  
 AM - Bkgrd + Proj Conditions

Intersection #3596: JACKSON/McKEE [Study Int 8]

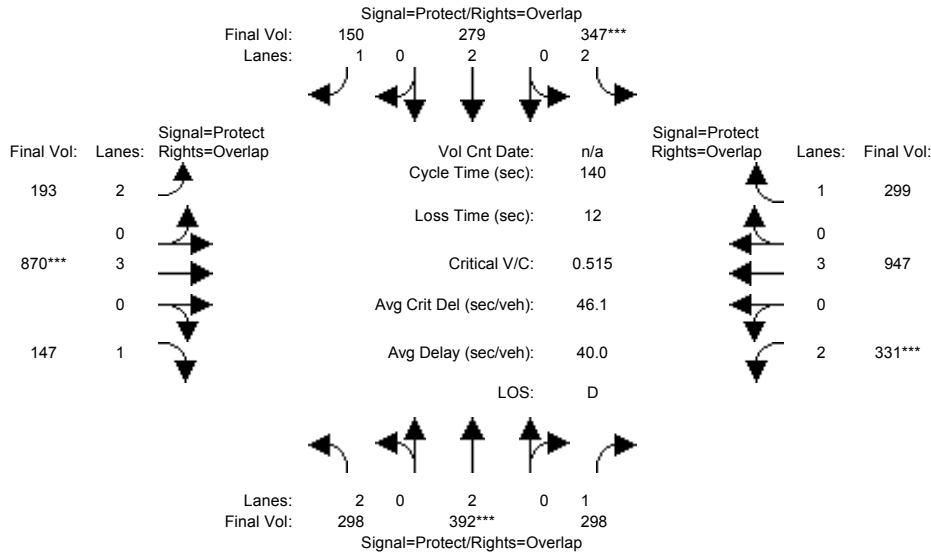

| Approach:                 | North Bound |      |      | South Bound |      |      | East Bound |      |      | West Bound |      |      |
|---------------------------|-------------|------|------|-------------|------|------|------------|------|------|------------|------|------|
| Movement:                 | L           | T    | R    | L           | T    | R    | L          | T    | R    | L          | T    | R    |
| Min. Green:               | 7           | 10   | 10   | 7           | 10   | 10   | 7          | 10   | 10   | 7          | 10   | 10   |
| Y+R:                      | 4.0         | 4.0  | 4.0  | 4.0         | 4.0  | 4.0  | 4.0        | 4.0  | 4.0  | 4.0        | 4.0  | 4.0  |
| Volume Module:            |             |      |      |             |      |      |            |      |      |            |      |      |
| Base Vol:                 | 298         | 392  | 298  | 347         | 279  | 150  | 193        | 870  | 147  | 331        | 947  | 299  |
| Growth Adj:               | 1.00        | 1.00 | 1.00 | 1.00        | 1.00 | 1.00 | 1.00       | 1.00 | 1.00 | 1.00       | 1.00 | 1.00 |
| Initial Bse:              | 298         | 392  | 298  | 347         | 279  | 150  | 193        | 870  | 147  | 331        | 947  | 299  |
| Added Vol:                | 0           | 0    | 0    | 0           | 0    | 0    | 0          | 0    | 0    | 0          | 0    | 0    |
| PasserByVol:              | 0           | 0    | 0    | 0           | 0    | 0    | 0          | 0    | 0    | 0          | 0    | 0    |
| Initial Fut:              | 298         | 392  | 298  | 347         | 279  | 150  | 193        | 870  | 147  | 331        | 947  | 299  |
| User Adj:                 | 1.00        | 1.00 | 1.00 | 1.00        | 1.00 | 1.00 | 1.00       | 1.00 | 1.00 | 1.00       | 1.00 | 1.00 |
| PHF Adj:                  | 1.00        | 1.00 | 1.00 | 1.00        | 1.00 | 1.00 | 1.00       | 1.00 | 1.00 | 1.00       | 1.00 | 1.00 |
| PHF Volume:               | 298         | 392  | 298  | 347         | 279  | 150  | 193        | 870  | 147  | 331        | 947  | 299  |
| Reduct Vol:               | 0           | 0    | 0    | 0           | 0    | 0    | 0          | 0    | 0    | 0          | 0    | 0    |
| Reduced Vol:              | 298         | 392  | 298  | 347         | 279  | 150  | 193        | 870  | 147  | 331        | 947  | 299  |
| PCE Adj:                  | 1.00        | 1.00 | 1.00 | 1.00        | 1.00 | 1.00 | 1.00       | 1.00 | 1.00 | 1.00       | 1.00 | 1.00 |
| MLF Adj:                  | 1.00        | 1.00 | 1.00 | 1.00        | 1.00 | 1.00 | 1.00       | 1.00 | 1.00 | 1.00       | 1.00 | 1.00 |
| Final Volume:             | 298         | 392  | 298  | 347         | 279  | 150  | 193        | 870  | 147  | 331        | 947  | 299  |
| Saturation Flow Module:   |             |      |      |             |      |      |            |      |      |            |      |      |
| Sat/Lane:                 | 1900        | 1900 | 1900 | 1900        | 1900 | 1900 | 1900       | 1900 | 1900 | 1900       | 1900 | 1900 |
| Adjustment:               | 0.83        | 1.00 | 0.92 | 0.83        | 1.00 | 0.92 | 0.83       | 1.00 | 0.92 | 0.83       | 1.00 | 0.92 |
| Lanes:                    | 2.00        | 2.00 | 1.00 | 2.00        | 2.00 | 1.00 | 2.00       | 3.00 | 1.00 | 2.00       | 3.00 | 1.00 |
| Final Sat.:               | 3150        | 3800 | 1750 | 3150        | 3800 | 1750 | 3150       | 5700 | 1750 | 3150       | 5700 | 1750 |
| Capacity Analysis Module: |             |      |      |             |      |      |            |      |      |            |      |      |
| Vol/Sat:                  | 0.09        | 0.10 | 0.17 | 0.11        | 0.07 | 0.09 | 0.06       | 0.15 | 0.08 | 0.11       | 0.17 | 0.17 |
| Crit Moves:               | ****        | **** | **** | ****        | **** | **** | ****       | **** | **** | ****       | **** | **** |
| Green Time:               | 32.6        | 28.0 | 56.6 | 29.9        | 25.3 | 44.2 | 18.9       | 41.5 | 74.1 | 28.6       | 51.2 | 81.1 |
| Volume/Cap:               | 0.41        | 0.52 | 0.42 | 0.52        | 0.41 | 0.27 | 0.45       | 0.52 | 0.16 | 0.52       | 0.45 | 0.29 |
| Delay/Veh:                | 45.8        | 50.5 | 30.4 | 49.3        | 51.1 | 36.1 | 56.6       | 41.2 | 17.0 | 50.3       | 34.0 | 15.1 |
| User DelAdj:              | 1.00        | 1.00 | 1.00 | 1.00        | 1.00 | 1.00 | 1.00       | 1.00 | 1.00 | 1.00       | 1.00 | 1.00 |
| AdjDel/Veh:               | 45.8        | 50.5 | 30.4 | 49.3        | 51.1 | 36.1 | 56.6       | 41.2 | 17.0 | 50.3       | 34.0 | 15.1 |
| LOS by Move:              | D           | D    | C    | D           | D    | D    | E          | D    | B    | D          | C    | B    |
| HCM2k95thQ:               | 13          | 15   | 18   | 15          | 10   | 10   | 9          | 18   | 7    | 15         | 19   | 13   |

Note: Queue reported is the number of cars per lane.

BART

Level Of Service Computation Report  
 2000 HCM Operations (Future Volume Alternative)  
 PM - Bkgrd + Proj Conditions

Intersection #3596: JACKSON/McKEE [Study Int 8]

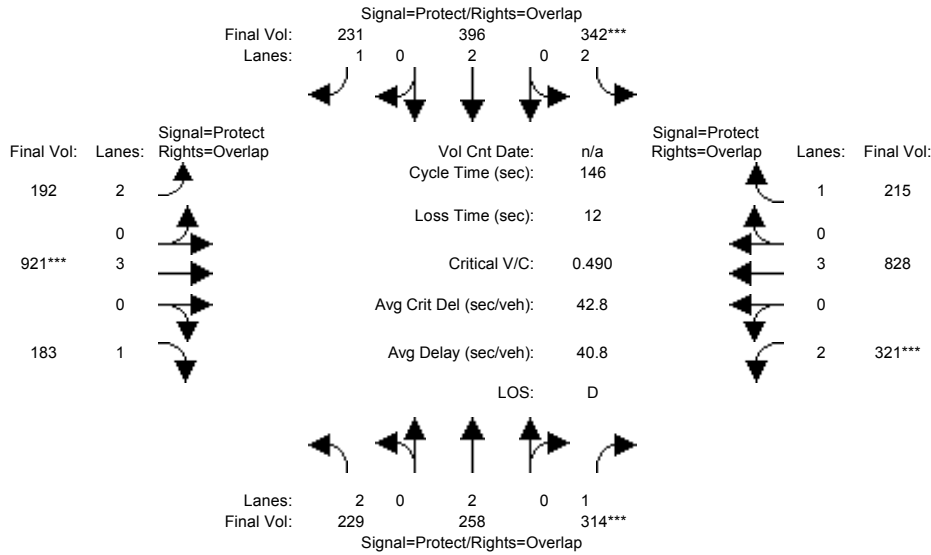

| Approach:                 | North Bound |      |      | South Bound |      |      | East Bound |      |      | West Bound |      |      |
|---------------------------|-------------|------|------|-------------|------|------|------------|------|------|------------|------|------|
| Movement:                 | L           | T    | R    | L           | T    | R    | L          | T    | R    | L          | T    | R    |
| Min. Green:               | 7           | 10   | 10   | 7           | 10   | 10   | 7          | 10   | 10   | 7          | 10   | 10   |
| Y+R:                      | 4.0         | 4.0  | 4.0  | 4.0         | 4.0  | 4.0  | 4.0        | 4.0  | 4.0  | 4.0        | 4.0  | 4.0  |
| Volume Module:            |             |      |      |             |      |      |            |      |      |            |      |      |
| Base Vol:                 | 229         | 258  | 314  | 342         | 396  | 231  | 192        | 921  | 183  | 321        | 828  | 215  |
| Growth Adj:               | 1.00        | 1.00 | 1.00 | 1.00        | 1.00 | 1.00 | 1.00       | 1.00 | 1.00 | 1.00       | 1.00 | 1.00 |
| Initial Bse:              | 229         | 258  | 314  | 342         | 396  | 231  | 192        | 921  | 183  | 321        | 828  | 215  |
| Added Vol:                | 0           | 0    | 0    | 0           | 0    | 0    | 0          | 0    | 0    | 0          | 0    | 0    |
| PasserByVol:              | 0           | 0    | 0    | 0           | 0    | 0    | 0          | 0    | 0    | 0          | 0    | 0    |
| Initial Fut:              | 229         | 258  | 314  | 342         | 396  | 231  | 192        | 921  | 183  | 321        | 828  | 215  |
| User Adj:                 | 1.00        | 1.00 | 1.00 | 1.00        | 1.00 | 1.00 | 1.00       | 1.00 | 1.00 | 1.00       | 1.00 | 1.00 |
| PHF Adj:                  | 1.00        | 1.00 | 1.00 | 1.00        | 1.00 | 1.00 | 1.00       | 1.00 | 1.00 | 1.00       | 1.00 | 1.00 |
| PHF Volume:               | 229         | 258  | 314  | 342         | 396  | 231  | 192        | 921  | 183  | 321        | 828  | 215  |
| Reduct Vol:               | 0           | 0    | 0    | 0           | 0    | 0    | 0          | 0    | 0    | 0          | 0    | 0    |
| Reduced Vol:              | 229         | 258  | 314  | 342         | 396  | 231  | 192        | 921  | 183  | 321        | 828  | 215  |
| PCE Adj:                  | 1.00        | 1.00 | 1.00 | 1.00        | 1.00 | 1.00 | 1.00       | 1.00 | 1.00 | 1.00       | 1.00 | 1.00 |
| MLF Adj:                  | 1.00        | 1.00 | 1.00 | 1.00        | 1.00 | 1.00 | 1.00       | 1.00 | 1.00 | 1.00       | 1.00 | 1.00 |
| FinalVolume:              | 229         | 258  | 314  | 342         | 396  | 231  | 192        | 921  | 183  | 321        | 828  | 215  |
| Saturation Flow Module:   |             |      |      |             |      |      |            |      |      |            |      |      |
| Sat/Lane:                 | 1900        | 1900 | 1900 | 1900        | 1900 | 1900 | 1900       | 1900 | 1900 | 1900       | 1900 | 1900 |
| Adjustment:               | 0.83        | 1.00 | 0.92 | 0.83        | 1.00 | 0.92 | 0.83       | 1.00 | 0.92 | 0.83       | 1.00 | 0.92 |
| Lanes:                    | 2.00        | 2.00 | 1.00 | 2.00        | 2.00 | 1.00 | 2.00       | 3.00 | 1.00 | 2.00       | 3.00 | 1.00 |
| Final Sat.:               | 3150        | 3800 | 1750 | 3150        | 3800 | 1750 | 3150       | 5700 | 1750 | 3150       | 5700 | 1750 |
| Capacity Analysis Module: |             |      |      |             |      |      |            |      |      |            |      |      |
| Vol/Sat:                  | 0.07        | 0.07 | 0.18 | 0.11        | 0.10 | 0.13 | 0.06       | 0.16 | 0.10 | 0.10       | 0.15 | 0.12 |
| Crit Moves:               | ****        | **** | **** | ****        | **** | **** | ****       | **** | **** | ****       | **** | **** |
| Green Time:               | 22.8        | 23.1 | 53.5 | 32.4        | 32.7 | 55.9 | 23.2       | 48.2 | 71.0 | 30.4       | 55.3 | 87.7 |
| Volume/Cap:               | 0.47        | 0.43 | 0.49 | 0.49        | 0.47 | 0.34 | 0.38       | 0.49 | 0.22 | 0.49       | 0.38 | 0.20 |
| Delay/Veh:                | 56.8        | 56.0 | 36.3 | 50.2        | 49.5 | 32.4 | 55.5       | 39.3 | 21.7 | 51.6       | 33.1 | 13.4 |
| User DelAdj:              | 1.00        | 1.00 | 1.00 | 1.00        | 1.00 | 1.00 | 1.00       | 1.00 | 1.00 | 1.00       | 1.00 | 1.00 |
| AdjDel/Veh:               | 56.8        | 56.0 | 36.3 | 50.2        | 49.5 | 32.4 | 55.5       | 39.3 | 21.7 | 51.6       | 33.1 | 13.4 |
| LOS by Move:              | E           | E    | D    | D           | D    | C    | E          | D    | C    | D          | C    | B    |
| HCM2k95thQ:               | 11          | 11   | 21   | 15          | 14   | 14   | 9          | 19   | 10   | 15         | 16   | 9    |

Note: Queue reported is the number of cars per lane.

BART

Level Of Service Computation Report  
 2000 HCM Operations (Future Volume Alternative)  
 AM - Bkgrd + Proj Conditions

Intersection #3612: JULIAN/21ST [Study Int 1]

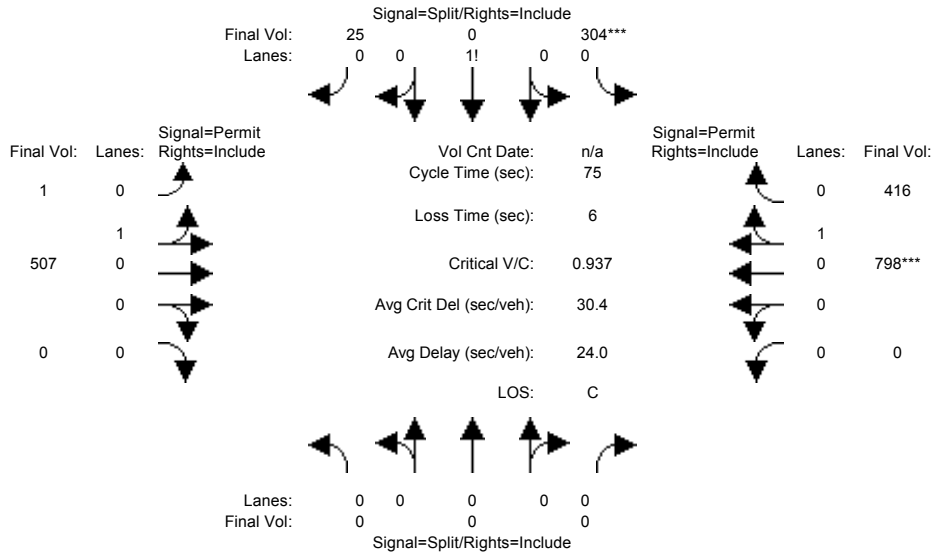

| Approach:                 | North Bound |      |      | South Bound |      |      | East Bound |      |      | West Bound |      |      |
|---------------------------|-------------|------|------|-------------|------|------|------------|------|------|------------|------|------|
| Movement:                 | L           | T    | R    | L           | T    | R    | L          | T    | R    | L          | T    | R    |
| Min. Green:               | 0           | 0    | 0    | 10          | 0    | 10   | 10         | 10   | 0    | 0          | 10   | 10   |
| Y+R:                      | 4.0         | 4.0  | 4.0  | 4.0         | 4.0  | 4.0  | 4.0        | 4.0  | 4.0  | 4.0        | 4.0  | 4.0  |
| Volume Module:            |             |      |      |             |      |      |            |      |      |            |      |      |
| Base Vol:                 | 0           | 0    | 0    | 304         | 0    | 25   | 1          | 507  | 0    | 0          | 798  | 416  |
| Growth Adj:               | 1.00        | 1.00 | 1.00 | 1.00        | 1.00 | 1.00 | 1.00       | 1.00 | 1.00 | 1.00       | 1.00 | 1.00 |
| Initial Bse:              | 0           | 0    | 0    | 304         | 0    | 25   | 1          | 507  | 0    | 0          | 798  | 416  |
| Added Vol:                | 0           | 0    | 0    | 0           | 0    | 0    | 0          | 0    | 0    | 0          | 0    | 0    |
| PasserByVol:              | 0           | 0    | 0    | 0           | 0    | 0    | 0          | 0    | 0    | 0          | 0    | 0    |
| Initial Fut:              | 0           | 0    | 0    | 304         | 0    | 25   | 1          | 507  | 0    | 0          | 798  | 416  |
| User Adj:                 | 1.00        | 1.00 | 1.00 | 1.00        | 1.00 | 1.00 | 1.00       | 1.00 | 1.00 | 1.00       | 1.00 | 1.00 |
| PHF Adj:                  | 1.00        | 1.00 | 1.00 | 1.00        | 1.00 | 1.00 | 1.00       | 1.00 | 1.00 | 1.00       | 1.00 | 1.00 |
| PHF Volume:               | 0           | 0    | 0    | 304         | 0    | 25   | 1          | 507  | 0    | 0          | 798  | 416  |
| Reduct Vol:               | 0           | 0    | 0    | 0           | 0    | 0    | 0          | 0    | 0    | 0          | 0    | 0    |
| Reduced Vol:              | 0           | 0    | 0    | 304         | 0    | 25   | 1          | 507  | 0    | 0          | 798  | 416  |
| PCE Adj:                  | 1.00        | 1.00 | 1.00 | 1.00        | 1.00 | 1.00 | 1.00       | 1.00 | 1.00 | 1.00       | 1.00 | 1.00 |
| MLF Adj:                  | 1.00        | 1.00 | 1.00 | 1.00        | 1.00 | 1.00 | 1.00       | 1.00 | 1.00 | 1.00       | 1.00 | 1.00 |
| FinalVolume:              | 0           | 0    | 0    | 304         | 0    | 25   | 1          | 507  | 0    | 0          | 798  | 416  |
| Saturation Flow Module:   |             |      |      |             |      |      |            |      |      |            |      |      |
| Sat/Lane:                 | 1900        | 1900 | 1900 | 1900        | 1900 | 1900 | 1900       | 1900 | 1900 | 1900       | 1900 | 1900 |
| Adjustment:               | 0.92        | 1.00 | 0.92 | 0.92        | 0.92 | 0.92 | 0.95       | 0.95 | 0.92 | 0.92       | 0.95 | 0.95 |
| Lanes:                    | 0.00        | 0.00 | 0.00 | 0.92        | 0.00 | 0.08 | 0.01       | 0.99 | 0.00 | 0.00       | 0.66 | 0.34 |
| Final Sat.:               | 0           | 0    | 0    | 1617        | 0    | 133  | 4          | 1796 | 0    | 0          | 1183 | 617  |
| Capacity Analysis Module: |             |      |      |             |      |      |            |      |      |            |      |      |
| Vol/Sat:                  | 0.00        | 0.00 | 0.00 | 0.19        | 0.00 | 0.19 | 0.28       | 0.28 | 0.00 | 0.00       | 0.67 | 0.67 |
| Crit Moves:               |             |      |      | ****        |      |      |            |      |      | ****       |      |      |
| Green Time:               | 0.0         | 0.0  | 0.0  | 15.0        | 0.0  | 15.0 | 54.0       | 54.0 | 0.0  | 0.0        | 54.0 | 54.0 |
| Volume/Cap:               | 0.00        | 0.00 | 0.00 | 0.94        | 0.00 | 0.94 | 0.39       | 0.39 | 0.00 | 0.00       | 0.94 | 0.94 |
| Delay/Veh:                | 0.0         | 0.0  | 0.0  | 61.8        | 0.0  | 61.8 | 4.3        | 4.3  | 0.0  | 0.0        | 21.9 | 21.9 |
| User DelAdj:              | 1.00        | 1.00 | 1.00 | 1.00        | 1.00 | 1.00 | 1.00       | 1.00 | 1.00 | 1.00       | 1.00 | 1.00 |
| AdjDel/Veh:               | 0.0         | 0.0  | 0.0  | 61.8        | 0.0  | 61.8 | 4.3        | 4.3  | 0.0  | 0.0        | 21.9 | 21.9 |
| LOS by Move:              | A           | A    | A    | E           | A    | E    | A          | A    | A    | A          | C    | C    |
| HCM2k95thQ:               | 0           | 0    | 0    | 23          | 0    | 23   | 9          | 9    | 0    | 0          | 48   | 48   |

Note: Queue reported is the number of cars per lane.

BART

Level Of Service Computation Report  
 2000 HCM Operations (Future Volume Alternative)  
 PM - Bkgrd + Proj Conditions

Intersection #3612: JULIAN/21ST [Study Int 1]

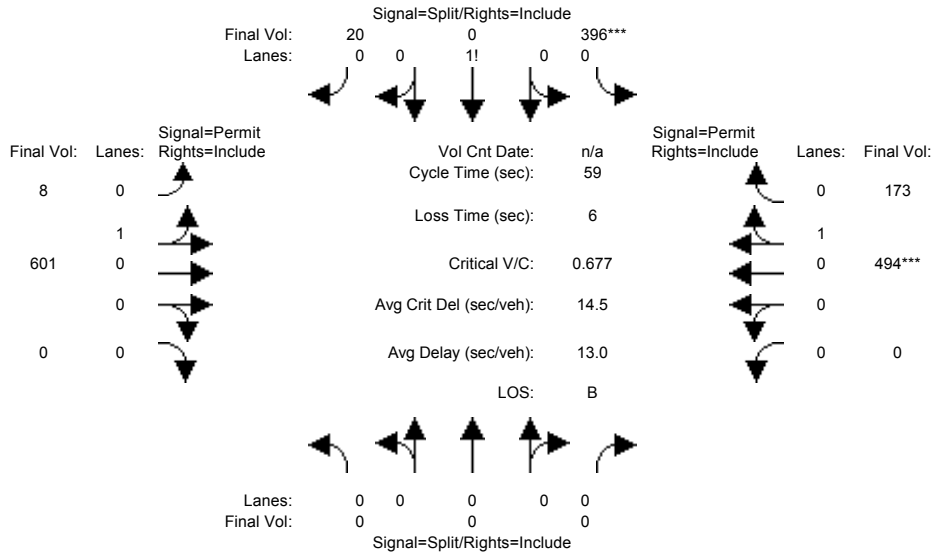

| Approach:                 | North Bound |      |      | South Bound |      |      | East Bound |      |      | West Bound |      |      |
|---------------------------|-------------|------|------|-------------|------|------|------------|------|------|------------|------|------|
| Movement:                 | L           | T    | R    | L           | T    | R    | L          | T    | R    | L          | T    | R    |
| Min. Green:               | 0           | 0    | 0    | 10          | 0    | 10   | 10         | 10   | 0    | 0          | 10   | 10   |
| Y+R:                      | 4.0         | 4.0  | 4.0  | 4.0         | 4.0  | 4.0  | 4.0        | 4.0  | 4.0  | 4.0        | 4.0  | 4.0  |
| Volume Module:            |             |      |      |             |      |      |            |      |      |            |      |      |
| Base Vol:                 | 0           | 0    | 0    | 396         | 0    | 20   | 8          | 601  | 0    | 0          | 494  | 173  |
| Growth Adj:               | 1.00        | 1.00 | 1.00 | 1.00        | 1.00 | 1.00 | 1.00       | 1.00 | 1.00 | 1.00       | 1.00 | 1.00 |
| Initial Bse:              | 0           | 0    | 0    | 396         | 0    | 20   | 8          | 601  | 0    | 0          | 494  | 173  |
| Added Vol:                | 0           | 0    | 0    | 0           | 0    | 0    | 0          | 0    | 0    | 0          | 0    | 0    |
| PasserByVol:              | 0           | 0    | 0    | 0           | 0    | 0    | 0          | 0    | 0    | 0          | 0    | 0    |
| Initial Fut:              | 0           | 0    | 0    | 396         | 0    | 20   | 8          | 601  | 0    | 0          | 494  | 173  |
| User Adj:                 | 1.00        | 1.00 | 1.00 | 1.00        | 1.00 | 1.00 | 1.00       | 1.00 | 1.00 | 1.00       | 1.00 | 1.00 |
| PHF Adj:                  | 1.00        | 1.00 | 1.00 | 1.00        | 1.00 | 1.00 | 1.00       | 1.00 | 1.00 | 1.00       | 1.00 | 1.00 |
| PHF Volume:               | 0           | 0    | 0    | 396         | 0    | 20   | 8          | 601  | 0    | 0          | 494  | 173  |
| Reduct Vol:               | 0           | 0    | 0    | 0           | 0    | 0    | 0          | 0    | 0    | 0          | 0    | 0    |
| Reduced Vol:              | 0           | 0    | 0    | 396         | 0    | 20   | 8          | 601  | 0    | 0          | 494  | 173  |
| PCE Adj:                  | 1.00        | 1.00 | 1.00 | 1.00        | 1.00 | 1.00 | 1.00       | 1.00 | 1.00 | 1.00       | 1.00 | 1.00 |
| MLF Adj:                  | 1.00        | 1.00 | 1.00 | 1.00        | 1.00 | 1.00 | 1.00       | 1.00 | 1.00 | 1.00       | 1.00 | 1.00 |
| Final Volume:             | 0           | 0    | 0    | 396         | 0    | 20   | 8          | 601  | 0    | 0          | 494  | 173  |
| Saturation Flow Module:   |             |      |      |             |      |      |            |      |      |            |      |      |
| Sat/Lane:                 | 1900        | 1900 | 1900 | 1900        | 1900 | 1900 | 1900       | 1900 | 1900 | 1900       | 1900 | 1900 |
| Adjustment:               | 0.92        | 1.00 | 0.92 | 0.92        | 0.92 | 0.92 | 0.95       | 0.95 | 0.92 | 0.92       | 0.95 | 0.95 |
| Lanes:                    | 0.00        | 0.00 | 0.00 | 0.95        | 0.00 | 0.05 | 0.01       | 0.99 | 0.00 | 0.00       | 0.74 | 0.26 |
| Final Sat.:               | 0           | 0    | 0    | 1666        | 0    | 84   | 24         | 1776 | 0    | 0          | 1333 | 467  |
| Capacity Analysis Module: |             |      |      |             |      |      |            |      |      |            |      |      |
| Vol/Sat:                  | 0.00        | 0.00 | 0.00 | 0.24        | 0.00 | 0.24 | 0.34       | 0.34 | 0.00 | 0.00       | 0.37 | 0.37 |
| Crit Moves:               | ****        |      |      |             |      |      |            |      |      |            |      |      |
| Green Time:               | 0.0         | 0.0  | 0.0  | 20.7        | 0.0  | 20.7 | 32.3       | 32.3 | 0.0  | 0.0        | 32.3 | 32.3 |
| Volume/Cap:               | 0.00        | 0.00 | 0.00 | 0.68        | 0.00 | 0.68 | 0.62       | 0.62 | 0.00 | 0.00       | 0.68 | 0.68 |
| Delay/Veh:                | 0.0         | 0.0  | 0.0  | 19.3        | 0.0  | 19.3 | 10.3       | 10.3 | 0.0  | 0.0        | 11.5 | 11.5 |
| User DelAdj:              | 1.00        | 1.00 | 1.00 | 1.00        | 1.00 | 1.00 | 1.00       | 1.00 | 1.00 | 1.00       | 1.00 | 1.00 |
| AdjDel/Veh:               | 0.0         | 0.0  | 0.0  | 19.3        | 0.0  | 19.3 | 10.3       | 10.3 | 0.0  | 0.0        | 11.5 | 11.5 |
| LOS by Move:              | A           | A    | A    | B           | A    | B    | B          | B    | A    | A          | B    | B    |
| HCM2k95thQ:               | 0           | 0    | 0    | 16          | 0    | 16   | 15         | 15   | 0    | 0          | 17   | 17   |

Note: Queue reported is the number of cars per lane.

BART

Level Of Service Computation Report  
 2000 HCM Operations (Future Volume Alternative)  
 AM - Bkgrd + Proj Conditions

Intersection #3613: JULIAN/24TH [Study Int 2]

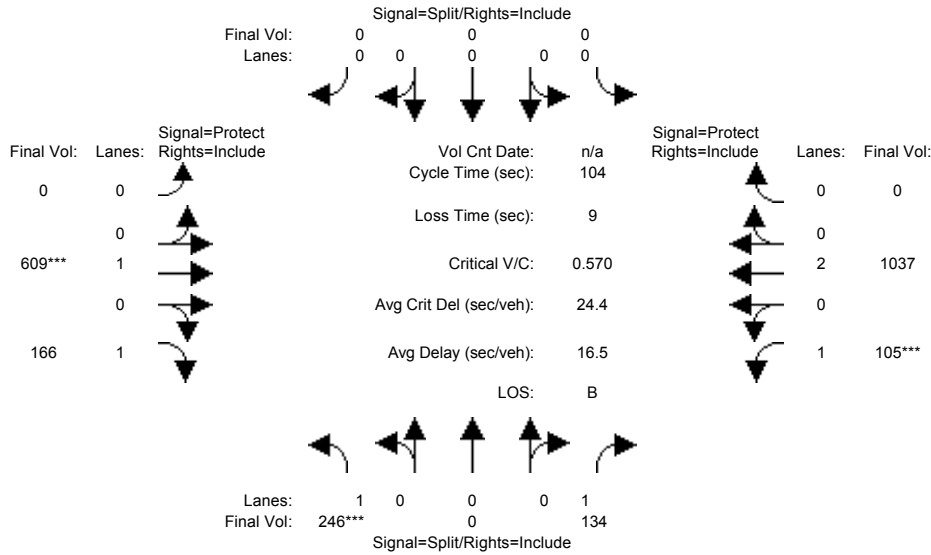

| Approach:                 | North Bound |      |      | South Bound |      |      | East Bound |      |      | West Bound |      |      |
|---------------------------|-------------|------|------|-------------|------|------|------------|------|------|------------|------|------|
| Movement:                 | L           | T    | R    | L           | T    | R    | L          | T    | R    | L          | T    | R    |
| Min. Green:               | 10          | 0    | 10   | 0           | 0    | 0    | 0          | 10   | 10   | 7          | 10   | 0    |
| Y+R:                      | 4.0         | 4.0  | 4.0  | 4.0         | 4.0  | 4.0  | 4.0        | 4.0  | 4.0  | 4.0        | 4.0  | 0    |
| Volume Module:            |             |      |      |             |      |      |            |      |      |            |      |      |
| Base Vol:                 | 246         | 0    | 134  | 0           | 0    | 0    | 0          | 609  | 166  | 105        | 1037 | 0    |
| Growth Adj:               | 1.00        | 1.00 | 1.00 | 1.00        | 1.00 | 1.00 | 1.00       | 1.00 | 1.00 | 1.00       | 1.00 | 1.00 |
| Initial Bse:              | 246         | 0    | 134  | 0           | 0    | 0    | 0          | 609  | 166  | 105        | 1037 | 0    |
| Added Vol:                | 0           | 0    | 0    | 0           | 0    | 0    | 0          | 0    | 0    | 0          | 0    | 0    |
| PasserByVol:              | 0           | 0    | 0    | 0           | 0    | 0    | 0          | 0    | 0    | 0          | 0    | 0    |
| Initial Fut:              | 246         | 0    | 134  | 0           | 0    | 0    | 0          | 609  | 166  | 105        | 1037 | 0    |
| User Adj:                 | 1.00        | 1.00 | 1.00 | 1.00        | 1.00 | 1.00 | 1.00       | 1.00 | 1.00 | 1.00       | 1.00 | 1.00 |
| PHF Adj:                  | 1.00        | 1.00 | 1.00 | 1.00        | 1.00 | 1.00 | 1.00       | 1.00 | 1.00 | 1.00       | 1.00 | 1.00 |
| PHF Volume:               | 246         | 0    | 134  | 0           | 0    | 0    | 0          | 609  | 166  | 105        | 1037 | 0    |
| Reduct Vol:               | 0           | 0    | 0    | 0           | 0    | 0    | 0          | 0    | 0    | 0          | 0    | 0    |
| Reduced Vol:              | 246         | 0    | 134  | 0           | 0    | 0    | 0          | 609  | 166  | 105        | 1037 | 0    |
| PCE Adj:                  | 1.00        | 1.00 | 1.00 | 1.00        | 1.00 | 1.00 | 1.00       | 1.00 | 1.00 | 1.00       | 1.00 | 1.00 |
| MLF Adj:                  | 1.00        | 1.00 | 1.00 | 1.00        | 1.00 | 1.00 | 1.00       | 1.00 | 1.00 | 1.00       | 1.00 | 1.00 |
| FinalVolume:              | 246         | 0    | 134  | 0           | 0    | 0    | 0          | 609  | 166  | 105        | 1037 | 0    |
| Saturation Flow Module:   |             |      |      |             |      |      |            |      |      |            |      |      |
| Sat/Lane:                 | 1900        | 1900 | 1900 | 1900        | 1900 | 1900 | 1900       | 1900 | 1900 | 1900       | 1900 | 1900 |
| Adjustment:               | 0.92        | 1.00 | 0.92 | 0.92        | 1.00 | 0.92 | 0.92       | 1.00 | 0.92 | 0.92       | 1.00 | 0.92 |
| Lanes:                    | 1.00        | 0.00 | 1.00 | 0.00        | 0.00 | 0.00 | 0.00       | 1.00 | 1.00 | 1.00       | 2.00 | 0.00 |
| Final Sat.:               | 1750        | 0    | 1750 | 0           | 0    | 0    | 0          | 1900 | 1750 | 1750       | 3800 | 0    |
| Capacity Analysis Module: |             |      |      |             |      |      |            |      |      |            |      |      |
| Vol/Sat:                  | 0.14        | 0.00 | 0.08 | 0.00        | 0.00 | 0.00 | 0.00       | 0.32 | 0.09 | 0.06       | 0.27 | 0.00 |
| Crit Moves:               | ****        |      |      |             |      |      |            | **** |      | ****       |      |      |
| Green Time:               | 25.6        | 0.0  | 25.6 | 0.0         | 0.0  | 0.0  | 0.0        | 58.4 | 58.4 | 10.9       | 69.4 | 0.0  |
| Volume/Cap:               | 0.57        | 0.00 | 0.31 | 0.00        | 0.00 | 0.00 | 0.00       | 0.57 | 0.17 | 0.57       | 0.41 | 0.00 |
| Delay/Veh:                | 36.2        | 0.0  | 32.4 | 0.0         | 0.0  | 0.0  | 0.0        | 15.4 | 11.1 | 48.5       | 8.0  | 0.0  |
| User DelAdj:              | 1.00        | 1.00 | 1.00 | 1.00        | 1.00 | 1.00 | 1.00       | 1.00 | 1.00 | 1.00       | 1.00 | 1.00 |
| AdjDel/Veh:               | 36.2        | 0.0  | 32.4 | 0.0         | 0.0  | 0.0  | 0.0        | 15.4 | 11.1 | 48.5       | 8.0  | 0.0  |
| LOS by Move:              | D           | A    | C    | A           | A    | A    | A          | B    | B    | D          | A    | A    |
| HCM2k95thQ:               | 15          | 0    | 8    | 0           | 0    | 0    | 0          | 22   | 5    | 9          | 14   | 0    |

Note: Queue reported is the number of cars per lane.



BART

Level Of Service Computation Report  
 2000 HCM Operations (Future Volume Alternative)  
 PM - Bkgrd + Proj Conditions

Intersection #3613: JULIAN/24TH [Study Int 2]

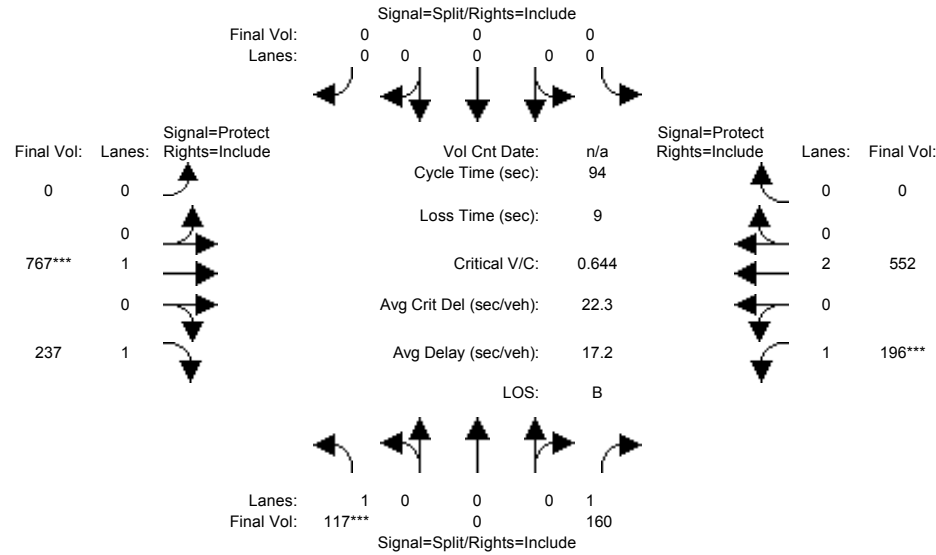

| Approach:                 | North Bound |      |      | South Bound |      |      | East Bound |      |      | West Bound |      |      |
|---------------------------|-------------|------|------|-------------|------|------|------------|------|------|------------|------|------|
| Movement:                 | L           | T    | R    | L           | T    | R    | L          | T    | R    | L          | T    | R    |
| Min. Green:               | 10          | 0    | 10   | 0           | 0    | 0    | 0          | 10   | 10   | 7          | 10   | 0    |
| Y+R:                      | 4.0         | 4.0  | 4.0  | 4.0         | 4.0  | 4.0  | 4.0        | 4.0  | 4.0  | 4.0        | 4.0  | 0    |
| Volume Module:            |             |      |      |             |      |      |            |      |      |            |      |      |
| Base Vol:                 | 117         | 0    | 160  | 0           | 0    | 0    | 0          | 767  | 237  | 196        | 552  | 0    |
| Growth Adj:               | 1.00        | 1.00 | 1.00 | 1.00        | 1.00 | 1.00 | 1.00       | 1.00 | 1.00 | 1.00       | 1.00 | 1.00 |
| Initial Bse:              | 117         | 0    | 160  | 0           | 0    | 0    | 0          | 767  | 237  | 196        | 552  | 0    |
| Added Vol:                | 0           | 0    | 0    | 0           | 0    | 0    | 0          | 0    | 0    | 0          | 0    | 0    |
| PasserByVol:              | 0           | 0    | 0    | 0           | 0    | 0    | 0          | 0    | 0    | 0          | 0    | 0    |
| Initial Fut:              | 117         | 0    | 160  | 0           | 0    | 0    | 0          | 767  | 237  | 196        | 552  | 0    |
| User Adj:                 | 1.00        | 1.00 | 1.00 | 1.00        | 1.00 | 1.00 | 1.00       | 1.00 | 1.00 | 1.00       | 1.00 | 1.00 |
| PHF Adj:                  | 1.00        | 1.00 | 1.00 | 1.00        | 1.00 | 1.00 | 1.00       | 1.00 | 1.00 | 1.00       | 1.00 | 1.00 |
| PHF Volume:               | 117         | 0    | 160  | 0           | 0    | 0    | 0          | 767  | 237  | 196        | 552  | 0    |
| Reduct Vol:               | 0           | 0    | 0    | 0           | 0    | 0    | 0          | 0    | 0    | 0          | 0    | 0    |
| Reduced Vol:              | 117         | 0    | 160  | 0           | 0    | 0    | 0          | 767  | 237  | 196        | 552  | 0    |
| PCE Adj:                  | 1.00        | 1.00 | 1.00 | 1.00        | 1.00 | 1.00 | 1.00       | 1.00 | 1.00 | 1.00       | 1.00 | 1.00 |
| MLF Adj:                  | 1.00        | 1.00 | 1.00 | 1.00        | 1.00 | 1.00 | 1.00       | 1.00 | 1.00 | 1.00       | 1.00 | 1.00 |
| FinalVolume:              | 117         | 0    | 160  | 0           | 0    | 0    | 0          | 767  | 237  | 196        | 552  | 0    |
| Saturation Flow Module:   |             |      |      |             |      |      |            |      |      |            |      |      |
| Sat/Lane:                 | 1900        | 1900 | 1900 | 1900        | 1900 | 1900 | 1900       | 1900 | 1900 | 1900       | 1900 | 1900 |
| Adjustment:               | 0.92        | 1.00 | 0.92 | 0.92        | 1.00 | 0.92 | 0.92       | 1.00 | 0.92 | 0.92       | 1.00 | 0.92 |
| Lanes:                    | 1.00        | 0.00 | 1.00 | 0.00        | 0.00 | 0.00 | 0.00       | 1.00 | 1.00 | 1.00       | 2.00 | 0.00 |
| Final Sat.:               | 1750        | 0    | 1750 | 0           | 0    | 0    | 0          | 1900 | 1750 | 1750       | 3800 | 0    |
| Capacity Analysis Module: |             |      |      |             |      |      |            |      |      |            |      |      |
| Vol/Sat:                  | 0.07        | 0.00 | 0.09 | 0.00        | 0.00 | 0.00 | 0.00       | 0.40 | 0.14 | 0.11       | 0.15 | 0.00 |
| Crit Moves:               | ****        |      |      |             |      |      |            | **** |      | ****       |      |      |
| Green Time:               | 13.3        | 0.0  | 13.3 | 0.0         | 0.0  | 0.0  | 0.0        | 56.1 | 56.1 | 15.6       | 71.7 | 0.0  |
| Volume/Cap:               | 0.47        | 0.00 | 0.64 | 0.00        | 0.00 | 0.00 | 0.00       | 0.68 | 0.23 | 0.68       | 0.19 | 0.00 |
| Delay/Veh:                | 38.5        | 0.0  | 43.8 | 0.0         | 0.0  | 0.0  | 0.0        | 14.5 | 9.0  | 43.1       | 3.1  | 0.0  |
| User DelAdj:              | 1.00        | 1.00 | 1.00 | 1.00        | 1.00 | 1.00 | 1.00       | 1.00 | 1.00 | 1.00       | 1.00 | 1.00 |
| AdjDel/Veh:               | 38.5        | 0.0  | 43.8 | 0.0         | 0.0  | 0.0  | 0.0        | 14.5 | 9.0  | 43.1       | 3.1  | 0.0  |
| LOS by Move:              | D           | A    | D    | A           | A    | A    | A          | B    | A    | D          | A    | A    |
| HCM2k95thQ:               | 8           | 0    | 11   | 0           | 0    | 0    | 0          | 26   | 7    | 13         | 5    | 0    |

Note: Queue reported is the number of cars per lane.

BART

Level Of Service Computation Report  
 2000 HCM Operations (Future Volume Alternative)  
 AM - Bkgrd + Proj Conditions

Intersection #3623: KING/MABURY [Study Int 27]

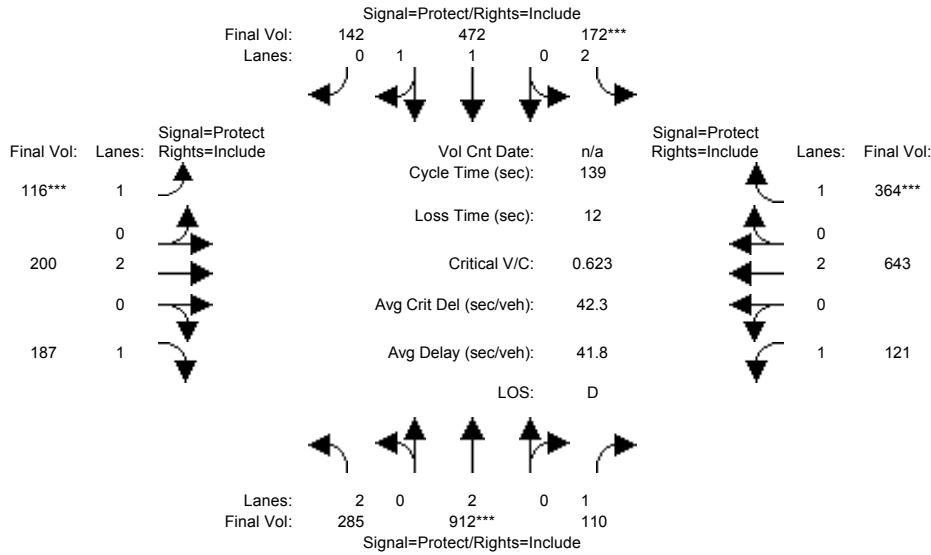

| Approach:                 | North Bound |      |      | South Bound |      |      | East Bound |      |      | West Bound |      |      |
|---------------------------|-------------|------|------|-------------|------|------|------------|------|------|------------|------|------|
| Movement:                 | L           | T    | R    | L           | T    | R    | L          | T    | R    | L          | T    | R    |
| Min. Green:               | 7           | 10   | 10   | 7           | 10   | 10   | 7          | 10   | 10   | 7          | 10   | 10   |
| Y+R:                      | 4.0         | 4.0  | 4.0  | 4.0         | 4.0  | 4.0  | 4.0        | 4.0  | 4.0  | 4.0        | 4.0  | 4.0  |
| Volume Module:            |             |      |      |             |      |      |            |      |      |            |      |      |
| Base Vol:                 | 285         | 912  | 110  | 172         | 472  | 142  | 116        | 200  | 187  | 121        | 643  | 364  |
| Growth Adj:               | 1.00        | 1.00 | 1.00 | 1.00        | 1.00 | 1.00 | 1.00       | 1.00 | 1.00 | 1.00       | 1.00 | 1.00 |
| Initial Bse:              | 285         | 912  | 110  | 172         | 472  | 142  | 116        | 200  | 187  | 121        | 643  | 364  |
| Added Vol:                | 0           | 0    | 0    | 0           | 0    | 0    | 0          | 0    | 0    | 0          | 0    | 0    |
| PasserByVol:              | 0           | 0    | 0    | 0           | 0    | 0    | 0          | 0    | 0    | 0          | 0    | 0    |
| Initial Fut:              | 285         | 912  | 110  | 172         | 472  | 142  | 116        | 200  | 187  | 121        | 643  | 364  |
| User Adj:                 | 1.00        | 1.00 | 1.00 | 1.00        | 1.00 | 1.00 | 1.00       | 1.00 | 1.00 | 1.00       | 1.00 | 1.00 |
| PHF Adj:                  | 1.00        | 1.00 | 1.00 | 1.00        | 1.00 | 1.00 | 1.00       | 1.00 | 1.00 | 1.00       | 1.00 | 1.00 |
| PHF Volume:               | 285         | 912  | 110  | 172         | 472  | 142  | 116        | 200  | 187  | 121        | 643  | 364  |
| Reduct Vol:               | 0           | 0    | 0    | 0           | 0    | 0    | 0          | 0    | 0    | 0          | 0    | 0    |
| Reduced Vol:              | 285         | 912  | 110  | 172         | 472  | 142  | 116        | 200  | 187  | 121        | 643  | 364  |
| PCE Adj:                  | 1.00        | 1.00 | 1.00 | 1.00        | 1.00 | 1.00 | 1.00       | 1.00 | 1.00 | 1.00       | 1.00 | 1.00 |
| MLF Adj:                  | 1.00        | 1.00 | 1.00 | 1.00        | 1.00 | 1.00 | 1.00       | 1.00 | 1.00 | 1.00       | 1.00 | 1.00 |
| FinalVolume:              | 285         | 912  | 110  | 172         | 472  | 142  | 116        | 200  | 187  | 121        | 643  | 364  |
| Saturation Flow Module:   |             |      |      |             |      |      |            |      |      |            |      |      |
| Sat/Lane:                 | 1900        | 1900 | 1900 | 1900        | 1900 | 1900 | 1900       | 1900 | 1900 | 1900       | 1900 | 1900 |
| Adjustment:               | 0.83        | 1.00 | 0.92 | 0.83        | 0.98 | 0.95 | 0.92       | 1.00 | 0.92 | 0.92       | 1.00 | 0.92 |
| Lanes:                    | 2.00        | 2.00 | 1.00 | 2.00        | 1.52 | 0.48 | 1.00       | 2.00 | 1.00 | 1.00       | 2.00 | 1.00 |
| Final Sat.:               | 3150        | 3800 | 1750 | 3150        | 2844 | 856  | 1750       | 3800 | 1750 | 1750       | 3800 | 1750 |
| Capacity Analysis Module: |             |      |      |             |      |      |            |      |      |            |      |      |
| Vol/Sat:                  | 0.09        | 0.24 | 0.06 | 0.05        | 0.17 | 0.17 | 0.07       | 0.05 | 0.11 | 0.07       | 0.17 | 0.21 |
| Crit Moves:               | ****        | **** | **** | ****        | **** | **** | ****       | **** | **** | ****       | **** | **** |
| Green Time:               | 23.2        | 53.6 | 53.6 | 12.2        | 42.6 | 42.6 | 14.8       | 37.2 | 37.2 | 24.1       | 46.4 | 46.4 |
| Volume/Cap:               | 0.54        | 0.62 | 0.16 | 0.62        | 0.54 | 0.54 | 0.62       | 0.20 | 0.40 | 0.40       | 0.51 | 0.62 |
| Delay/Veh:                | 54.2        | 35.4 | 28.1 | 65.5        | 40.6 | 40.6 | 65.8       | 39.5 | 42.3 | 51.9       | 37.4 | 41.0 |
| User DelAdj:              | 1.00        | 1.00 | 1.00 | 1.00        | 1.00 | 1.00 | 1.00       | 1.00 | 1.00 | 1.00       | 1.00 | 1.00 |
| AdjDel/Veh:               | 54.2        | 35.4 | 28.1 | 65.5        | 40.6 | 40.6 | 65.8       | 39.5 | 42.3 | 51.9       | 37.4 | 41.0 |
| LOS by Move:              | D           | D    | C    | E           | D    | D    | E          | D    | D    | D          | D    | D    |
| HCM2k95thQ:               | 13          | 27   | 6    | 9           | 20   | 20   | 10         | 6    | 13   | 9          | 19   | 25   |

Note: Queue reported is the number of cars per lane.

BART

Level Of Service Computation Report  
 2000 HCM Operations (Future Volume Alternative)  
 PM - Bkgrd + Proj Conditions

Intersection #3623: KING/MABURY [Study Int 27]

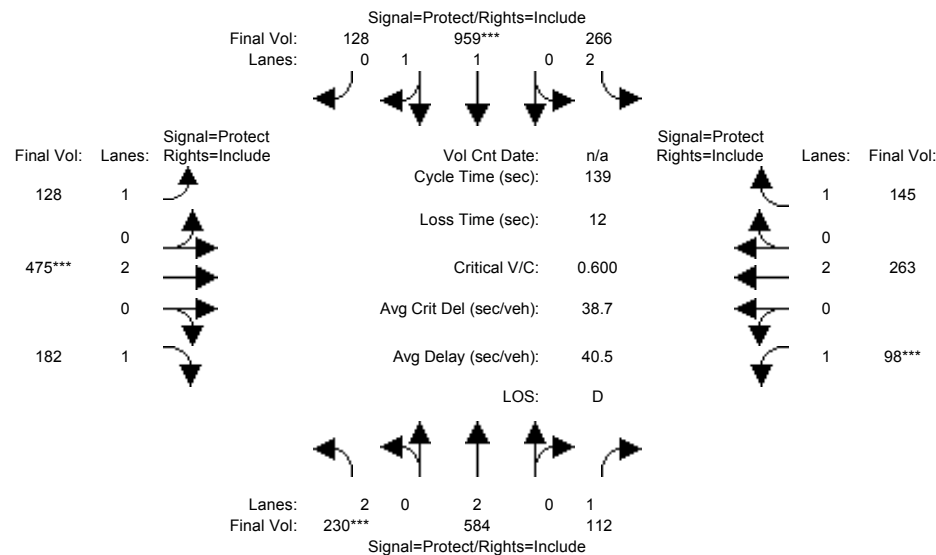

| Approach:                 | North Bound |      |      | South Bound |      |      | East Bound |      |      | West Bound |      |      |
|---------------------------|-------------|------|------|-------------|------|------|------------|------|------|------------|------|------|
| Movement:                 | L           | T    | R    | L           | T    | R    | L          | T    | R    | L          | T    | R    |
| Min. Green:               | 7           | 10   | 10   | 7           | 10   | 10   | 7          | 10   | 10   | 7          | 10   | 10   |
| Y+R:                      | 4.0         | 4.0  | 4.0  | 4.0         | 4.0  | 4.0  | 4.0        | 4.0  | 4.0  | 4.0        | 4.0  | 4.0  |
| Volume Module:            |             |      |      |             |      |      |            |      |      |            |      |      |
| Base Vol:                 | 230         | 584  | 112  | 266         | 959  | 128  | 128        | 475  | 182  | 98         | 263  | 145  |
| Growth Adj:               | 1.00        | 1.00 | 1.00 | 1.00        | 1.00 | 1.00 | 1.00       | 1.00 | 1.00 | 1.00       | 1.00 | 1.00 |
| Initial Bse:              | 230         | 584  | 112  | 266         | 959  | 128  | 128        | 475  | 182  | 98         | 263  | 145  |
| Added Vol:                | 0           | 0    | 0    | 0           | 0    | 0    | 0          | 0    | 0    | 0          | 0    | 0    |
| PasserByVol:              | 0           | 0    | 0    | 0           | 0    | 0    | 0          | 0    | 0    | 0          | 0    | 0    |
| Initial Fut:              | 230         | 584  | 112  | 266         | 959  | 128  | 128        | 475  | 182  | 98         | 263  | 145  |
| User Adj:                 | 1.00        | 1.00 | 1.00 | 1.00        | 1.00 | 1.00 | 1.00       | 1.00 | 1.00 | 1.00       | 1.00 | 1.00 |
| PHF Adj:                  | 1.00        | 1.00 | 1.00 | 1.00        | 1.00 | 1.00 | 1.00       | 1.00 | 1.00 | 1.00       | 1.00 | 1.00 |
| PHF Volume:               | 230         | 584  | 112  | 266         | 959  | 128  | 128        | 475  | 182  | 98         | 263  | 145  |
| Reduct Vol:               | 0           | 0    | 0    | 0           | 0    | 0    | 0          | 0    | 0    | 0          | 0    | 0    |
| Reduced Vol:              | 230         | 584  | 112  | 266         | 959  | 128  | 128        | 475  | 182  | 98         | 263  | 145  |
| PCE Adj:                  | 1.00        | 1.00 | 1.00 | 1.00        | 1.00 | 1.00 | 1.00       | 1.00 | 1.00 | 1.00       | 1.00 | 1.00 |
| MLF Adj:                  | 1.00        | 1.00 | 1.00 | 1.00        | 1.00 | 1.00 | 1.00       | 1.00 | 1.00 | 1.00       | 1.00 | 1.00 |
| Final Volume:             | 230         | 584  | 112  | 266         | 959  | 128  | 128        | 475  | 182  | 98         | 263  | 145  |
| Saturation Flow Module:   |             |      |      |             |      |      |            |      |      |            |      |      |
| Sat/Lane:                 | 1900        | 1900 | 1900 | 1900        | 1900 | 1900 | 1900       | 1900 | 1900 | 1900       | 1900 | 1900 |
| Adjustment:               | 0.83        | 1.00 | 0.92 | 0.83        | 0.98 | 0.95 | 0.92       | 1.00 | 0.92 | 0.92       | 1.00 | 0.92 |
| Lanes:                    | 2.00        | 2.00 | 1.00 | 2.00        | 1.76 | 0.24 | 1.00       | 2.00 | 1.00 | 1.00       | 2.00 | 1.00 |
| Final Sat.:               | 3150        | 3800 | 1750 | 3150        | 3264 | 436  | 1750       | 3800 | 1750 | 1750       | 3800 | 1750 |
| Capacity Analysis Module: |             |      |      |             |      |      |            |      |      |            |      |      |
| Vol/Sat:                  | 0.07        | 0.15 | 0.06 | 0.08        | 0.29 | 0.29 | 0.07       | 0.13 | 0.10 | 0.06       | 0.07 | 0.08 |
| Crit Moves:               | ****        |      |      | ****        |      |      | ****       |      |      | ****       |      |      |
| Green Time:               | 16.9        | 54.9 | 54.9 | 30.2        | 68.1 | 68.1 | 19.7       | 29.0 | 29.0 | 13.0       | 22.3 | 22.3 |
| Volume/Cap:               | 0.60        | 0.39 | 0.16 | 0.39        | 0.60 | 0.60 | 0.52       | 0.60 | 0.50 | 0.60       | 0.43 | 0.52 |
| Delay/Veh:                | 60.5        | 30.2 | 27.3 | 46.9        | 26.2 | 26.2 | 57.2       | 51.0 | 49.7 | 66.6       | 53.1 | 55.1 |
| User DelAdj:              | 1.00        | 1.00 | 1.00 | 1.00        | 1.00 | 1.00 | 1.00       | 1.00 | 1.00 | 1.00       | 1.00 | 1.00 |
| AdjDel/Veh:               | 60.5        | 30.2 | 27.3 | 46.9        | 26.2 | 26.2 | 57.2       | 51.0 | 49.7 | 66.6       | 53.1 | 55.1 |
| LOS by Move:              | E           | C    | C    | D           | C    | C    | E          | D    | D    | E          | D    | E    |
| HCM2k95thQ:               | 11          | 16   | 6    | 11          | 29   | 29   | 10         | 17   | 14   | 9          | 10   | 12   |

Note: Queue reported is the number of cars per lane.

BART

Level Of Service Computation Report  
 2000 HCM Operations (Future Volume Alternative)  
 AM - Bkgrd + Proj Conditions

Intersection #3625: KING/McKEE [Study Int 7]

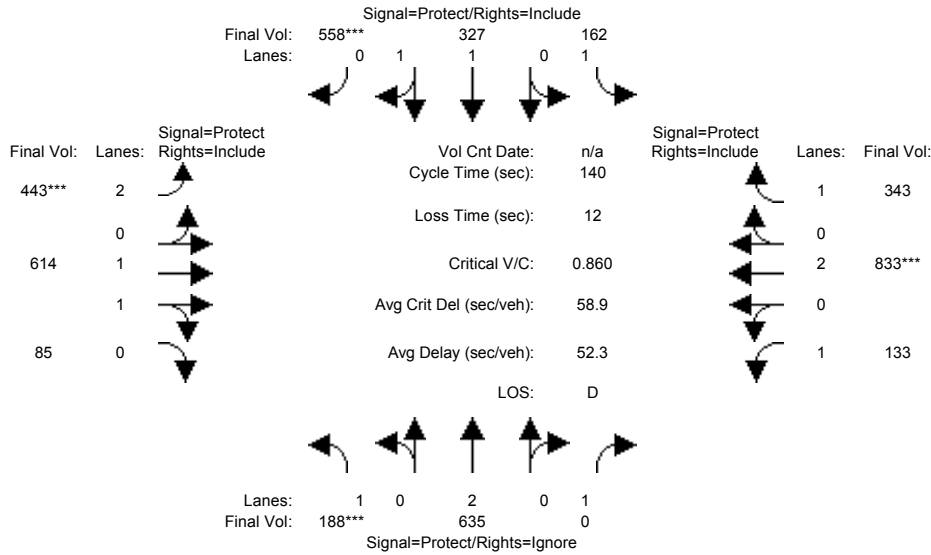

| Approach:                 | North Bound |      |      | South Bound |      |      | East Bound |      |      | West Bound |      |      |
|---------------------------|-------------|------|------|-------------|------|------|------------|------|------|------------|------|------|
| Movement:                 | L           | T    | R    | L           | T    | R    | L          | T    | R    | L          | T    | R    |
| Min. Green:               | 7           | 10   | 10   | 7           | 10   | 10   | 7          | 10   | 10   | 7          | 10   | 10   |
| Y+R:                      | 4.0         | 4.0  | 4.0  | 4.0         | 4.0  | 4.0  | 4.0        | 4.0  | 4.0  | 4.0        | 4.0  | 4.0  |
| Volume Module:            |             |      |      |             |      |      |            |      |      |            |      |      |
| Base Vol:                 | 188         | 635  | 164  | 162         | 327  | 558  | 443        | 614  | 85   | 133        | 833  | 343  |
| Growth Adj:               | 1.00        | 1.00 | 1.00 | 1.00        | 1.00 | 1.00 | 1.00       | 1.00 | 1.00 | 1.00       | 1.00 | 1.00 |
| Initial Bse:              | 188         | 635  | 164  | 162         | 327  | 558  | 443        | 614  | 85   | 133        | 833  | 343  |
| Added Vol:                | 0           | 0    | 0    | 0           | 0    | 0    | 0          | 0    | 0    | 0          | 0    | 0    |
| PasserByVol:              | 0           | 0    | 0    | 0           | 0    | 0    | 0          | 0    | 0    | 0          | 0    | 0    |
| Initial Fut:              | 188         | 635  | 164  | 162         | 327  | 558  | 443        | 614  | 85   | 133        | 833  | 343  |
| User Adj:                 | 1.00        | 1.00 | 0.00 | 1.00        | 1.00 | 1.00 | 1.00       | 1.00 | 1.00 | 1.00       | 1.00 | 1.00 |
| PHF Adj:                  | 1.00        | 1.00 | 0.00 | 1.00        | 1.00 | 1.00 | 1.00       | 1.00 | 1.00 | 1.00       | 1.00 | 1.00 |
| PHF Volume:               | 188         | 635  | 0    | 162         | 327  | 558  | 443        | 614  | 85   | 133        | 833  | 343  |
| Reduct Vol:               | 0           | 0    | 0    | 0           | 0    | 0    | 0          | 0    | 0    | 0          | 0    | 0    |
| Reduced Vol:              | 188         | 635  | 0    | 162         | 327  | 558  | 443        | 614  | 85   | 133        | 833  | 343  |
| PCE Adj:                  | 1.00        | 1.00 | 0.00 | 1.00        | 1.00 | 1.00 | 1.00       | 1.00 | 1.00 | 1.00       | 1.00 | 1.00 |
| MLF Adj:                  | 1.00        | 1.00 | 0.00 | 1.00        | 1.00 | 1.00 | 1.00       | 1.00 | 1.00 | 1.00       | 1.00 | 1.00 |
| Final Volume:             | 188         | 635  | 0    | 162         | 327  | 558  | 443        | 614  | 85   | 133        | 833  | 343  |
| Saturation Flow Module:   |             |      |      |             |      |      |            |      |      |            |      |      |
| Sat/Lane:                 | 1900        | 1900 | 1900 | 1900        | 1900 | 1900 | 1900       | 1900 | 1900 | 1900       | 1900 | 1900 |
| Adjustment:               | 0.92        | 1.00 | 0.92 | 0.92        | 1.00 | 0.92 | 0.83       | 0.98 | 0.95 | 0.92       | 1.00 | 0.92 |
| Lanes:                    | 1.00        | 2.00 | 1.00 | 1.00        | 1.00 | 1.00 | 2.00       | 1.75 | 0.25 | 1.00       | 2.00 | 1.00 |
| Final Sat.:               | 1750        | 3800 | 1750 | 1750        | 1900 | 1750 | 3150       | 3250 | 450  | 1750       | 3800 | 1750 |
| Capacity Analysis Module: |             |      |      |             |      |      |            |      |      |            |      |      |
| Vol/Sat:                  | 0.11        | 0.17 | 0.00 | 0.09        | 0.17 | 0.32 | 0.14       | 0.19 | 0.19 | 0.08       | 0.22 | 0.20 |
| Crit Moves:               | ****        |      |      | ****        | **** | **** | ****       | **** | **** | ****       | **** | **** |
| Green Time:               | 17.5        | 44.7 | 0.0  | 24.7        | 51.9 | 51.9 | 22.9       | 41.8 | 41.8 | 16.8       | 35.7 | 35.7 |
| Volume/Cap:               | 0.86        | 0.52 | 0.00 | 0.52        | 0.46 | 0.86 | 0.86       | 0.63 | 0.63 | 0.63       | 0.86 | 0.77 |
| Delay/Veh:                | 87.4        | 39.4 | 0.0  | 53.9        | 33.6 | 48.1 | 70.7       | 43.7 | 43.7 | 64.8       | 57.6 | 56.3 |
| User DelAdj:              | 1.00        | 1.00 | 1.00 | 1.00        | 1.00 | 1.00 | 1.00       | 1.00 | 1.00 | 1.00       | 1.00 | 1.00 |
| AdjDel/Veh:               | 87.4        | 39.4 | 0.0  | 53.9        | 33.6 | 48.1 | 70.7       | 43.7 | 43.7 | 64.8       | 57.6 | 56.3 |
| LOS by Move:              | F           | D    | A    | D           | C    | D    | E          | D    | D    | E          | E    | E    |
| HCM2k95thQ:               | 18          | 20   | 0    | 13          | 19   | 42   | 21         | 23   | 23   | 11         | 31   | 27   |

Note: Queue reported is the number of cars per lane.

BART

Level Of Service Computation Report  
 2000 HCM Operations (Future Volume Alternative)  
 PM - Bkgrd + Proj Conditions

Intersection #3625: KING/McKEE [Study Int 7]

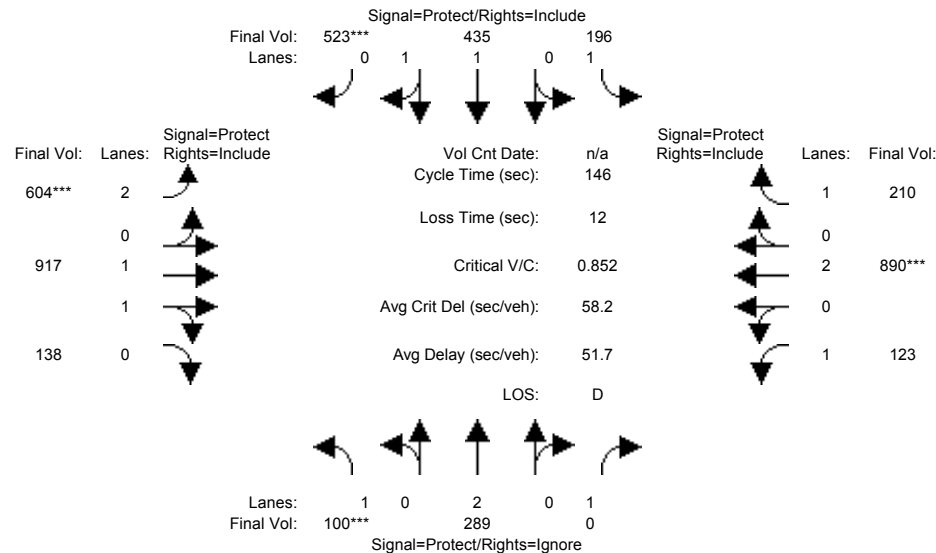

| Approach:                 | North Bound |      |      | South Bound |      |      | East Bound |      |      | West Bound |      |      |
|---------------------------|-------------|------|------|-------------|------|------|------------|------|------|------------|------|------|
| Movement:                 | L           | T    | R    | L           | T    | R    | L          | T    | R    | L          | T    | R    |
| Min. Green:               | 7           | 10   | 10   | 7           | 10   | 10   | 7          | 10   | 10   | 7          | 10   | 10   |
| Y+R:                      | 4.0         | 4.0  | 4.0  | 4.0         | 4.0  | 4.0  | 4.0        | 4.0  | 4.0  | 4.0        | 4.0  | 4.0  |
| Volume Module:            |             |      |      |             |      |      |            |      |      |            |      |      |
| Base Vol:                 | 100         | 289  | 110  | 196         | 435  | 523  | 604        | 917  | 138  | 123        | 890  | 210  |
| Growth Adj:               | 1.00        | 1.00 | 1.00 | 1.00        | 1.00 | 1.00 | 1.00       | 1.00 | 1.00 | 1.00       | 1.00 | 1.00 |
| Initial Bse:              | 100         | 289  | 110  | 196         | 435  | 523  | 604        | 917  | 138  | 123        | 890  | 210  |
| Added Vol:                | 0           | 0    | 0    | 0           | 0    | 0    | 0          | 0    | 0    | 0          | 0    | 0    |
| PasserByVol:              | 0           | 0    | 0    | 0           | 0    | 0    | 0          | 0    | 0    | 0          | 0    | 0    |
| Initial Fut:              | 100         | 289  | 110  | 196         | 435  | 523  | 604        | 917  | 138  | 123        | 890  | 210  |
| User Adj:                 | 1.00        | 1.00 | 0.00 | 1.00        | 1.00 | 1.00 | 1.00       | 1.00 | 1.00 | 1.00       | 1.00 | 1.00 |
| PHF Adj:                  | 1.00        | 1.00 | 0.00 | 1.00        | 1.00 | 1.00 | 1.00       | 1.00 | 1.00 | 1.00       | 1.00 | 1.00 |
| PHF Volume:               | 100         | 289  | 0    | 196         | 435  | 523  | 604        | 917  | 138  | 123        | 890  | 210  |
| Reduct Vol:               | 0           | 0    | 0    | 0           | 0    | 0    | 0          | 0    | 0    | 0          | 0    | 0    |
| Reduced Vol:              | 100         | 289  | 0    | 196         | 435  | 523  | 604        | 917  | 138  | 123        | 890  | 210  |
| PCE Adj:                  | 1.00        | 1.00 | 0.00 | 1.00        | 1.00 | 1.00 | 1.00       | 1.00 | 1.00 | 1.00       | 1.00 | 1.00 |
| MLF Adj:                  | 1.00        | 1.00 | 0.00 | 1.00        | 1.00 | 1.00 | 1.00       | 1.00 | 1.00 | 1.00       | 1.00 | 1.00 |
| FinalVolume:              | 100         | 289  | 0    | 196         | 435  | 523  | 604        | 917  | 138  | 123        | 890  | 210  |
| Saturation Flow Module:   |             |      |      |             |      |      |            |      |      |            |      |      |
| Sat/Lane:                 | 1900        | 1900 | 1900 | 1900        | 1900 | 1900 | 1900       | 1900 | 1900 | 1900       | 1900 | 1900 |
| Adjustment:               | 0.92        | 1.00 | 0.92 | 0.92        | 1.00 | 0.92 | 0.83       | 0.98 | 0.95 | 0.92       | 1.00 | 0.92 |
| Lanes:                    | 1.00        | 2.00 | 1.00 | 1.00        | 1.00 | 1.00 | 2.00       | 1.73 | 0.27 | 1.00       | 2.00 | 1.00 |
| Final Sat.:               | 1750        | 3800 | 1750 | 1750        | 1900 | 1750 | 3150       | 3216 | 484  | 1750       | 3800 | 1750 |
| Capacity Analysis Module: |             |      |      |             |      |      |            |      |      |            |      |      |
| Vol/Sat:                  | 0.06        | 0.08 | 0.00 | 0.11        | 0.23 | 0.30 | 0.19       | 0.29 | 0.29 | 0.07       | 0.23 | 0.12 |
| Crit Moves:               | ****        |      |      | ****        | **** | **** | ****       | **** | **** | ****       | **** | **** |
| Green Time:               | 9.8         | 24.7 | 0.0  | 36.3        | 51.2 | 51.2 | 32.9       | 58.6 | 58.6 | 14.4       | 40.1 | 40.1 |
| Volume/Cap:               | 0.85        | 0.45 | 0.00 | 0.45        | 0.65 | 0.85 | 0.85       | 0.71 | 0.71 | 0.71       | 0.85 | 0.44 |
| Delay/Veh:                | 108.9       | 55.1 | 0.0  | 47.1        | 41.0 | 50.3 | 64.0       | 38.3 | 38.3 | 76.7       | 57.0 | 44.3 |
| User DelAdj:              | 1.00        | 1.00 | 1.00 | 1.00        | 1.00 | 1.00 | 1.00       | 1.00 | 1.00 | 1.00       | 1.00 | 1.00 |
| AdjDel/Veh:               | 108.9       | 55.1 | 0.0  | 47.1        | 41.0 | 50.3 | 64.0       | 38.3 | 38.3 | 76.7       | 57.0 | 44.3 |
| LOS by Move:              | F           | E    | A    | D           | D    | D    | E          | D    | D    | E          | E    | D    |
| HCM2k95thQ:               | 11          | 11   | 0    | 15          | 28   | 41   | 28         | 34   | 34   | 12         | 34   | 15   |

Note: Queue reported is the number of cars per lane.

BART

Level Of Service Computation Report  
 2000 HCM Operations (Future Volume Alternative)  
 AM - Bkgrd + Proj Conditions

Intersection #3627: KING/SAN ANTONIO [Study Int 22]

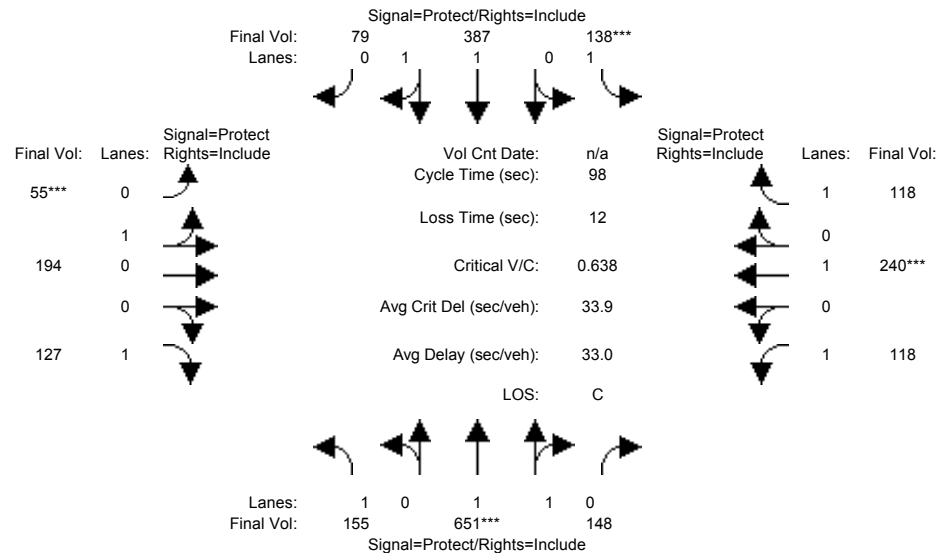

| Approach:                 | North Bound |      |      | South Bound |      |      | East Bound |      |      | West Bound |      |      |
|---------------------------|-------------|------|------|-------------|------|------|------------|------|------|------------|------|------|
| Movement:                 | L           | T    | R    | L           | T    | R    | L          | T    | R    | L          | T    | R    |
| Min. Green:               | 7           | 10   | 10   | 7           | 10   | 10   | 10         | 10   | 10   | 10         | 10   | 10   |
| Y+R:                      | 4.0         | 4.0  | 4.0  | 4.0         | 4.0  | 4.0  | 4.0        | 4.0  | 4.0  | 4.0        | 4.0  | 4.0  |
| Volume Module:            |             |      |      |             |      |      |            |      |      |            |      |      |
| Base Vol:                 | 155         | 651  | 148  | 138         | 387  | 79   | 55         | 194  | 127  | 118        | 240  | 118  |
| Growth Adj:               | 1.00        | 1.00 | 1.00 | 1.00        | 1.00 | 1.00 | 1.00       | 1.00 | 1.00 | 1.00       | 1.00 | 1.00 |
| Initial Bse:              | 155         | 651  | 148  | 138         | 387  | 79   | 55         | 194  | 127  | 118        | 240  | 118  |
| Added Vol:                | 0           | 0    | 0    | 0           | 0    | 0    | 0          | 0    | 0    | 0          | 0    | 0    |
| PasserByVol:              | 0           | 0    | 0    | 0           | 0    | 0    | 0          | 0    | 0    | 0          | 0    | 0    |
| Initial Fut:              | 155         | 651  | 148  | 138         | 387  | 79   | 55         | 194  | 127  | 118        | 240  | 118  |
| User Adj:                 | 1.00        | 1.00 | 1.00 | 1.00        | 1.00 | 1.00 | 1.00       | 1.00 | 1.00 | 1.00       | 1.00 | 1.00 |
| PHF Adj:                  | 1.00        | 1.00 | 1.00 | 1.00        | 1.00 | 1.00 | 1.00       | 1.00 | 1.00 | 1.00       | 1.00 | 1.00 |
| PHF Volume:               | 155         | 651  | 148  | 138         | 387  | 79   | 55         | 194  | 127  | 118        | 240  | 118  |
| Reduct Vol:               | 0           | 0    | 0    | 0           | 0    | 0    | 0          | 0    | 0    | 0          | 0    | 0    |
| Reduced Vol:              | 155         | 651  | 148  | 138         | 387  | 79   | 55         | 194  | 127  | 118        | 240  | 118  |
| PCE Adj:                  | 1.00        | 1.00 | 1.00 | 1.00        | 1.00 | 1.00 | 1.00       | 1.00 | 1.00 | 1.00       | 1.00 | 1.00 |
| MLF Adj:                  | 1.00        | 1.00 | 1.00 | 1.00        | 1.00 | 1.00 | 1.00       | 1.00 | 1.00 | 1.00       | 1.00 | 1.00 |
| Final Volume:             | 155         | 651  | 148  | 138         | 387  | 79   | 55         | 194  | 127  | 118        | 240  | 118  |
| Saturation Flow Module:   |             |      |      |             |      |      |            |      |      |            |      |      |
| Sat/Lane:                 | 1900        | 1900 | 1900 | 1900        | 1900 | 1900 | 1900       | 1900 | 1900 | 1900       | 1900 | 1900 |
| Adjustment:               | 0.92        | 0.98 | 0.95 | 0.92        | 0.98 | 0.95 | 0.95       | 0.95 | 0.92 | 0.92       | 1.00 | 0.92 |
| Lanes:                    | 1.00        | 1.62 | 0.38 | 1.00        | 1.65 | 0.35 | 0.22       | 0.78 | 1.00 | 1.00       | 1.00 | 1.00 |
| Final Sat.:               | 1750        | 3014 | 685  | 1750        | 3072 | 627  | 398        | 1402 | 1750 | 1750       | 1900 | 1750 |
| Capacity Analysis Module: |             |      |      |             |      |      |            |      |      |            |      |      |
| Vol/Sat:                  | 0.09        | 0.22 | 0.22 | 0.08        | 0.13 | 0.13 | 0.14       | 0.14 | 0.07 | 0.07       | 0.13 | 0.07 |
| Crit Moves:               | ****        | **** | **** | ****        | **** | **** | ****       | **** | **** | ****       | **** | **** |
| Green Time:               | 18.7        | 33.2 | 33.2 | 12.1        | 26.6 | 26.6 | 21.3       | 23.4 | 23.4 | 17.3       | 19.4 | 19.4 |
| Volume/Cap:               | 0.46        | 0.64 | 0.64 | 0.64        | 0.46 | 0.46 | 0.64       | 0.58 | 0.30 | 0.38       | 0.64 | 0.34 |
| Delay/Veh:                | 36.2        | 28.4 | 28.4 | 47.1        | 30.1 | 30.1 | 38.4       | 34.9 | 31.0 | 36.5       | 39.7 | 34.4 |
| User DelAdj:              | 1.00        | 1.00 | 1.00 | 1.00        | 1.00 | 1.00 | 1.00       | 1.00 | 1.00 | 1.00       | 1.00 | 1.00 |
| AdjDel/Veh:               | 36.2        | 28.4 | 28.4 | 47.1        | 30.1 | 30.1 | 38.4       | 34.9 | 31.0 | 36.5       | 39.7 | 34.4 |
| LOS by Move:              | D           | C    | C    | D           | C    | C    | D          | C    | C    | D          | D    | C    |
| HCM2k95thQ:               | 9           | 19   | 19   | 9           | 11   | 11   | 15         | 14   | 7    | 7          | 14   | 7    |

Note: Queue reported is the number of cars per lane.

BART

Level Of Service Computation Report  
 2000 HCM Operations (Future Volume Alternative)  
 PM - Bkgrd + Proj Conditions

Intersection #3627: KING/SAN ANTONIO [Study Int 22]

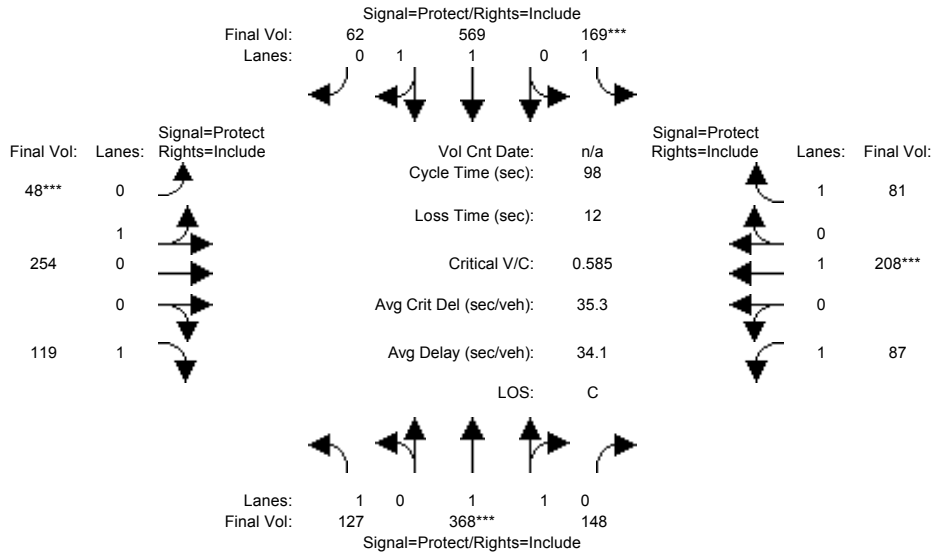

| Approach:                 | North Bound |      |      | South Bound |      |      | East Bound |      |      | West Bound |      |      |
|---------------------------|-------------|------|------|-------------|------|------|------------|------|------|------------|------|------|
| Movement:                 | L           | T    | R    | L           | T    | R    | L          | T    | R    | L          | T    | R    |
| Min. Green:               | 7           | 10   | 10   | 7           | 10   | 10   | 10         | 10   | 10   | 10         | 10   | 10   |
| Y+R:                      | 4.0         | 4.0  | 4.0  | 4.0         | 4.0  | 4.0  | 4.0        | 4.0  | 4.0  | 4.0        | 4.0  | 4.0  |
| Volume Module:            |             |      |      |             |      |      |            |      |      |            |      |      |
| Base Vol:                 | 127         | 368  | 148  | 169         | 569  | 62   | 48         | 254  | 119  | 87         | 208  | 81   |
| Growth Adj:               | 1.00        | 1.00 | 1.00 | 1.00        | 1.00 | 1.00 | 1.00       | 1.00 | 1.00 | 1.00       | 1.00 | 1.00 |
| Initial Bse:              | 127         | 368  | 148  | 169         | 569  | 62   | 48         | 254  | 119  | 87         | 208  | 81   |
| Added Vol:                | 0           | 0    | 0    | 0           | 0    | 0    | 0          | 0    | 0    | 0          | 0    | 0    |
| PasserByVol:              | 0           | 0    | 0    | 0           | 0    | 0    | 0          | 0    | 0    | 0          | 0    | 0    |
| Initial Fut:              | 127         | 368  | 148  | 169         | 569  | 62   | 48         | 254  | 119  | 87         | 208  | 81   |
| User Adj:                 | 1.00        | 1.00 | 1.00 | 1.00        | 1.00 | 1.00 | 1.00       | 1.00 | 1.00 | 1.00       | 1.00 | 1.00 |
| PHF Adj:                  | 1.00        | 1.00 | 1.00 | 1.00        | 1.00 | 1.00 | 1.00       | 1.00 | 1.00 | 1.00       | 1.00 | 1.00 |
| PHF Volume:               | 127         | 368  | 148  | 169         | 569  | 62   | 48         | 254  | 119  | 87         | 208  | 81   |
| Reduct Vol:               | 0           | 0    | 0    | 0           | 0    | 0    | 0          | 0    | 0    | 0          | 0    | 0    |
| Reduced Vol:              | 127         | 368  | 148  | 169         | 569  | 62   | 48         | 254  | 119  | 87         | 208  | 81   |
| PCE Adj:                  | 1.00        | 1.00 | 1.00 | 1.00        | 1.00 | 1.00 | 1.00       | 1.00 | 1.00 | 1.00       | 1.00 | 1.00 |
| MLF Adj:                  | 1.00        | 1.00 | 1.00 | 1.00        | 1.00 | 1.00 | 1.00       | 1.00 | 1.00 | 1.00       | 1.00 | 1.00 |
| FinalVolume:              | 127         | 368  | 148  | 169         | 569  | 62   | 48         | 254  | 119  | 87         | 208  | 81   |
| Saturation Flow Module:   |             |      |      |             |      |      |            |      |      |            |      |      |
| Sat/Lane:                 | 1900        | 1900 | 1900 | 1900        | 1900 | 1900 | 1900       | 1900 | 1900 | 1900       | 1900 | 1900 |
| Adjustment:               | 0.92        | 0.98 | 0.95 | 0.92        | 0.98 | 0.95 | 0.95       | 0.95 | 0.92 | 0.92       | 1.00 | 0.92 |
| Lanes:                    | 1.00        | 1.41 | 0.59 | 1.00        | 1.80 | 0.20 | 0.16       | 0.84 | 1.00 | 1.00       | 1.00 | 1.00 |
| Final Sat.:               | 1750        | 2638 | 1061 | 1750        | 3336 | 364  | 286        | 1514 | 1750 | 1750       | 1900 | 1750 |
| Capacity Analysis Module: |             |      |      |             |      |      |            |      |      |            |      |      |
| Vol/Sat:                  | 0.07        | 0.14 | 0.14 | 0.10        | 0.17 | 0.17 | 0.17       | 0.17 | 0.07 | 0.05       | 0.11 | 0.05 |
| Crit Moves:               | ****        | **** | **** | ****        | **** | **** | ****       | **** | **** | ****       | **** | **** |
| Green Time:               | 11.8        | 23.4 | 23.4 | 16.2        | 27.7 | 27.7 | 28.1       | 28.9 | 28.9 | 17.6       | 18.3 | 18.3 |
| Volume/Cap:               | 0.60        | 0.58 | 0.58 | 0.58        | 0.60 | 0.60 | 0.58       | 0.57 | 0.23 | 0.28       | 0.58 | 0.25 |
| Delay/Veh:                | 45.7        | 34.0 | 34.0 | 40.9        | 31.4 | 31.4 | 31.7       | 30.8 | 26.4 | 35.2       | 38.9 | 34.3 |
| User DelAdj:              | 1.00        | 1.00 | 1.00 | 1.00        | 1.00 | 1.00 | 1.00       | 1.00 | 1.00 | 1.00       | 1.00 | 1.00 |
| AdjDel/Veh:               | 45.7        | 34.0 | 34.0 | 40.9        | 31.4 | 31.4 | 31.7       | 30.8 | 26.4 | 35.2       | 38.9 | 34.3 |
| LOS by Move:              | D           | C    | C    | D           | C    | C    | C          | C    | C    | D          | D    | C    |
| HCM2k95thQ:               | 8           | 13   | 13   | 10          | 16   | 16   | 16         | 16   | 6    | 5          | 12   | 5    |

Note: Queue reported is the number of cars per lane.

BART

Level Of Service Computation Report  
 2000 HCM Operations (Future Volume Alternative)  
 AM - Bkgrd + Proj Conditions

Intersection #3678: MCKEE/33RD [Study Int 6]

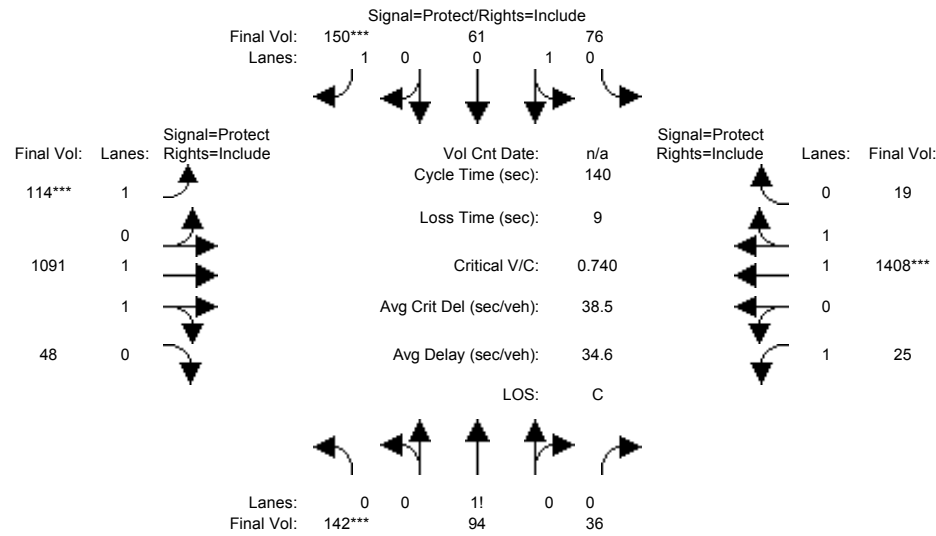

| Approach:                 | North Bound |      |      | South Bound |      |      | East Bound |      |      | West Bound |      |      |
|---------------------------|-------------|------|------|-------------|------|------|------------|------|------|------------|------|------|
| Movement:                 | L           | T    | R    | L           | T    | R    | L          | T    | R    | L          | T    | R    |
| Min. Green:               | 10          | 10   | 10   | 10          | 10   | 10   | 7          | 10   | 10   | 7          | 10   | 10   |
| Y+R:                      | 4.0         | 4.0  | 4.0  | 4.0         | 4.0  | 4.0  | 4.0        | 4.0  | 4.0  | 4.0        | 4.0  | 4.0  |
| Volume Module:            |             |      |      |             |      |      |            |      |      |            |      |      |
| Base Vol:                 | 142         | 94   | 36   | 76          | 61   | 150  | 114        | 1091 | 48   | 25         | 1408 | 19   |
| Growth Adj:               | 1.00        | 1.00 | 1.00 | 1.00        | 1.00 | 1.00 | 1.00       | 1.00 | 1.00 | 1.00       | 1.00 | 1.00 |
| Initial Bse:              | 142         | 94   | 36   | 76          | 61   | 150  | 114        | 1091 | 48   | 25         | 1408 | 19   |
| Added Vol:                | 0           | 0    | 0    | 0           | 0    | 0    | 0          | 0    | 0    | 0          | 0    | 0    |
| PasserByVol:              | 0           | 0    | 0    | 0           | 0    | 0    | 0          | 0    | 0    | 0          | 0    | 0    |
| Initial Fut:              | 142         | 94   | 36   | 76          | 61   | 150  | 114        | 1091 | 48   | 25         | 1408 | 19   |
| User Adj:                 | 1.00        | 1.00 | 1.00 | 1.00        | 1.00 | 1.00 | 1.00       | 1.00 | 1.00 | 1.00       | 1.00 | 1.00 |
| PHF Adj:                  | 1.00        | 1.00 | 1.00 | 1.00        | 1.00 | 1.00 | 1.00       | 1.00 | 1.00 | 1.00       | 1.00 | 1.00 |
| PHF Volume:               | 142         | 94   | 36   | 76          | 61   | 150  | 114        | 1091 | 48   | 25         | 1408 | 19   |
| Reduct Vol:               | 0           | 0    | 0    | 0           | 0    | 0    | 0          | 0    | 0    | 0          | 0    | 0    |
| Reduced Vol:              | 142         | 94   | 36   | 76          | 61   | 150  | 114        | 1091 | 48   | 25         | 1408 | 19   |
| PCE Adj:                  | 1.00        | 1.00 | 1.00 | 1.00        | 1.00 | 1.00 | 1.00       | 1.00 | 1.00 | 1.00       | 1.00 | 1.00 |
| MLF Adj:                  | 1.00        | 1.00 | 1.00 | 1.00        | 1.00 | 1.00 | 1.00       | 1.00 | 1.00 | 1.00       | 1.00 | 1.00 |
| Final Volume:             | 142         | 94   | 36   | 76          | 61   | 150  | 114        | 1091 | 48   | 25         | 1408 | 19   |
| Saturation Flow Module:   |             |      |      |             |      |      |            |      |      |            |      |      |
| Sat/Lane:                 | 1900        | 1900 | 1900 | 1900        | 1900 | 1900 | 1900       | 1900 | 1900 | 1900       | 1900 | 1900 |
| Adjustment:               | 0.92        | 0.92 | 0.92 | 0.95        | 0.95 | 0.92 | 0.92       | 0.97 | 0.95 | 0.92       | 0.97 | 0.95 |
| Lanes:                    | 0.52        | 0.35 | 0.13 | 0.55        | 0.45 | 1.00 | 1.00       | 1.91 | 0.09 | 1.00       | 1.97 | 0.03 |
| Final Sat.:               | 914         | 605  | 232  | 999         | 801  | 1750 | 1750       | 3544 | 156  | 1750       | 3651 | 49   |
| Capacity Analysis Module: |             |      |      |             |      |      |            |      |      |            |      |      |
| Vol/Sat:                  | 0.16        | 0.16 | 0.16 | 0.08        | 0.08 | 0.09 | 0.07       | 0.31 | 0.31 | 0.01       | 0.39 | 0.39 |
| Crit Moves:               | ****        |      |      | ****        |      | **** | ****       |      | **** | ****       |      | **** |
| Green Time:               | 29.4        | 30.6 | 30.6 | 15.0        | 16.2 | 16.2 | 12.3       | 73.4 | 73.4 | 11.9       | 73.0 | 73.0 |
| Volume/Cap:               | 0.74        | 0.71 | 0.71 | 0.71        | 0.66 | 0.74 | 0.74       | 0.59 | 0.59 | 0.17       | 0.74 | 0.74 |
| Delay/Veh:                | 59.5        | 56.7 | 56.7 | 72.0        | 66.6 | 73.3 | 79.5       | 23.3 | 23.3 | 60.0       | 27.6 | 27.6 |
| User DelAdj:              | 1.00        | 1.00 | 1.00 | 1.00        | 1.00 | 1.00 | 1.00       | 1.00 | 1.00 | 1.00       | 1.00 | 1.00 |
| AdjDel/Veh:               | 59.5        | 56.7 | 56.7 | 72.0        | 66.6 | 73.3 | 79.5       | 23.3 | 23.3 | 60.0       | 27.6 | 27.6 |
| LOS by Move:              | E           | E    | E    | E           | E    | E    | E          | C    | C    | E          | C    | C    |
| HCM2k95thQ:               | 22          | 21   | 21   | 14          | 13   | 16   | 11         | 29   | 29   | 2          | 39   | 39   |

Note: Queue reported is the number of cars per lane.



BART

Level Of Service Computation Report  
 2000 HCM Operations (Future Volume Alternative)  
 PM - Bkgrd + Proj Conditions

Intersection #3678: MCKEE/33RD [Study Int 6]

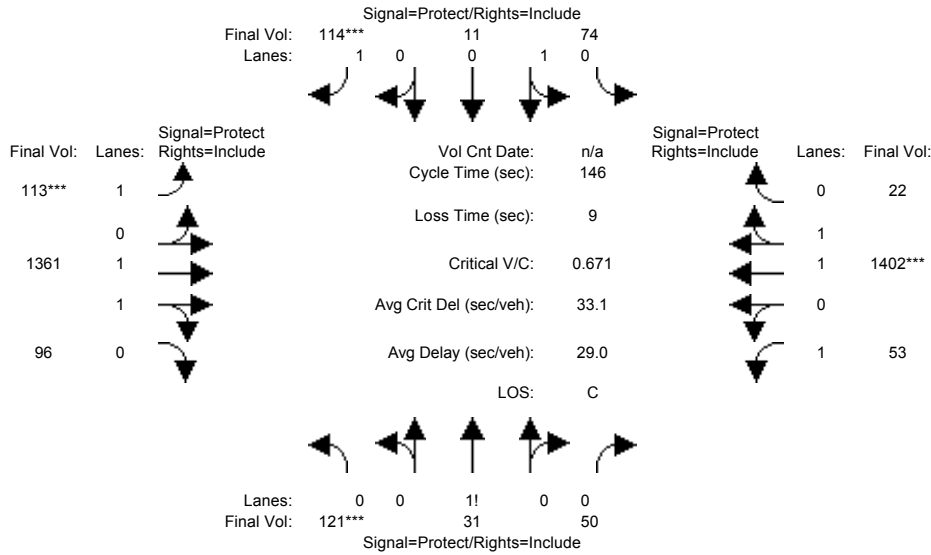

| Approach:                 | North Bound |      |      | South Bound |      |      | East Bound |      |      | West Bound |      |      |
|---------------------------|-------------|------|------|-------------|------|------|------------|------|------|------------|------|------|
| Movement:                 | L           | T    | R    | L           | T    | R    | L          | T    | R    | L          | T    | R    |
| Min. Green:               | 10          | 10   | 10   | 10          | 10   | 10   | 7          | 10   | 10   | 7          | 10   | 10   |
| Y+R:                      | 4.0         | 4.0  | 4.0  | 4.0         | 4.0  | 4.0  | 4.0        | 4.0  | 4.0  | 4.0        | 4.0  | 4.0  |
| Volume Module:            |             |      |      |             |      |      |            |      |      |            |      |      |
| Base Vol:                 | 121         | 31   | 50   | 74          | 11   | 114  | 113        | 1361 | 96   | 53         | 1402 | 22   |
| Growth Adj:               | 1.00        | 1.00 | 1.00 | 1.00        | 1.00 | 1.00 | 1.00       | 1.00 | 1.00 | 1.00       | 1.00 | 1.00 |
| Initial Bse:              | 121         | 31   | 50   | 74          | 11   | 114  | 113        | 1361 | 96   | 53         | 1402 | 22   |
| Added Vol:                | 0           | 0    | 0    | 0           | 0    | 0    | 0          | 0    | 0    | 0          | 0    | 0    |
| PasserByVol:              | 0           | 0    | 0    | 0           | 0    | 0    | 0          | 0    | 0    | 0          | 0    | 0    |
| Initial Fut:              | 121         | 31   | 50   | 74          | 11   | 114  | 113        | 1361 | 96   | 53         | 1402 | 22   |
| User Adj:                 | 1.00        | 1.00 | 1.00 | 1.00        | 1.00 | 1.00 | 1.00       | 1.00 | 1.00 | 1.00       | 1.00 | 1.00 |
| PHF Adj:                  | 1.00        | 1.00 | 1.00 | 1.00        | 1.00 | 1.00 | 1.00       | 1.00 | 1.00 | 1.00       | 1.00 | 1.00 |
| PHF Volume:               | 121         | 31   | 50   | 74          | 11   | 114  | 113        | 1361 | 96   | 53         | 1402 | 22   |
| Reduct Vol:               | 0           | 0    | 0    | 0           | 0    | 0    | 0          | 0    | 0    | 0          | 0    | 0    |
| Reduced Vol:              | 121         | 31   | 50   | 74          | 11   | 114  | 113        | 1361 | 96   | 53         | 1402 | 22   |
| PCE Adj:                  | 1.00        | 1.00 | 1.00 | 1.00        | 1.00 | 1.00 | 1.00       | 1.00 | 1.00 | 1.00       | 1.00 | 1.00 |
| MLF Adj:                  | 1.00        | 1.00 | 1.00 | 1.00        | 1.00 | 1.00 | 1.00       | 1.00 | 1.00 | 1.00       | 1.00 | 1.00 |
| Final Volume:             | 121         | 31   | 50   | 74          | 11   | 114  | 113        | 1361 | 96   | 53         | 1402 | 22   |
| Saturation Flow Module:   |             |      |      |             |      |      |            |      |      |            |      |      |
| Sat/Lane:                 | 1900        | 1900 | 1900 | 1900        | 1900 | 1900 | 1900       | 1900 | 1900 | 1900       | 1900 | 1900 |
| Adjustment:               | 0.92        | 0.92 | 0.92 | 0.95        | 0.95 | 0.92 | 0.92       | 0.98 | 0.95 | 0.92       | 0.97 | 0.95 |
| Lanes:                    | 0.60        | 0.15 | 0.25 | 0.87        | 0.13 | 1.00 | 1.00       | 1.86 | 0.14 | 1.00       | 1.97 | 0.03 |
| Final Sat.:               | 1048        | 269  | 433  | 1567        | 233  | 1750 | 1750       | 3456 | 244  | 1750       | 3643 | 57   |
| Capacity Analysis Module: |             |      |      |             |      |      |            |      |      |            |      |      |
| Vol/Sat:                  | 0.12        | 0.12 | 0.12 | 0.05        | 0.05 | 0.07 | 0.06       | 0.39 | 0.39 | 0.03       | 0.38 | 0.38 |
| Crit Moves:               | ****        |      |      |             |      | **** | ****       |      |      | ****       |      |      |
| Green Time:               | 25.1        | 24.6 | 24.6 | 14.6        | 14.2 | 14.2 | 14.0       | 87.1 | 87.1 | 10.6       | 83.7 | 83.7 |
| Volume/Cap:               | 0.67        | 0.68 | 0.68 | 0.47        | 0.49 | 0.67 | 0.67       | 0.66 | 0.66 | 0.42       | 0.67 | 0.67 |
| Delay/Veh:                | 62.4        | 63.5 | 63.5 | 64.0        | 64.6 | 73.7 | 73.9       | 20.3 | 20.3 | 66.9       | 22.5 | 22.5 |
| User DelAdj:              | 1.00        | 1.00 | 1.00 | 1.00        | 1.00 | 1.00 | 1.00       | 1.00 | 1.00 | 1.00       | 1.00 | 1.00 |
| AdjDel/Veh:               | 62.4        | 63.5 | 63.5 | 64.0        | 64.6 | 73.7 | 73.9       | 20.3 | 20.3 | 66.9       | 22.5 | 22.5 |
| LOS by Move:              | E           | E    | E    | E           | E    | E    | E          | C    | C    | E          | C    | C    |
| HCM2k95thQ:               | 17          | 17   | 17   | 8           | 9    | 13   | 10         | 37   | 37   | 5          | 36   | 36   |

Note: Queue reported is the number of cars per lane.

BART

Level Of Service Computation Report  
 2000 HCM Operations (Future Volume Alternative)  
 AM - Bkgrd + Proj Conditions

Intersection #3683: McLAUGHLIN/STORY [Study Int 26]

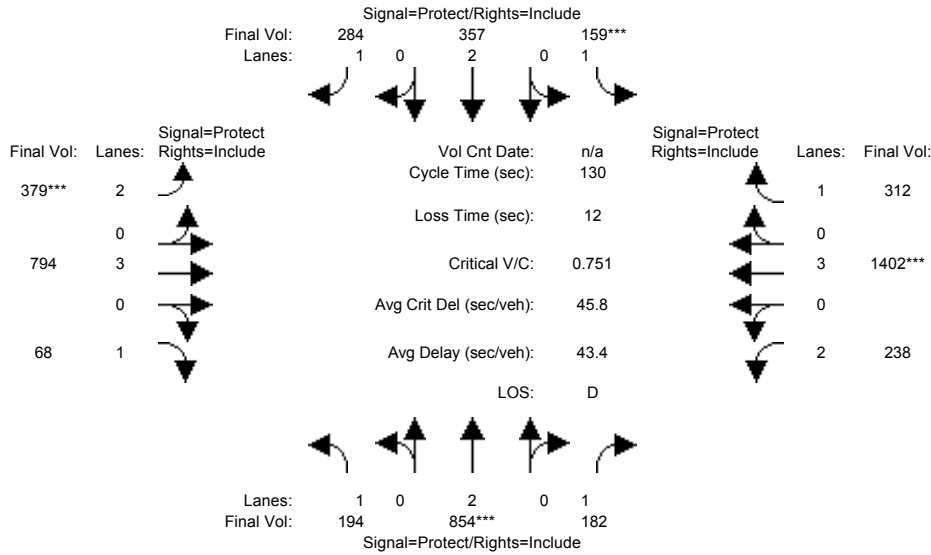

| Approach:                 | North Bound |      |      | South Bound |      |      | East Bound |      |      | West Bound |      |      |
|---------------------------|-------------|------|------|-------------|------|------|------------|------|------|------------|------|------|
| Movement:                 | L           | T    | R    | L           | T    | R    | L          | T    | R    | L          | T    | R    |
| Min. Green:               | 7           | 10   | 10   | 7           | 10   | 10   | 7          | 10   | 10   | 7          | 10   | 10   |
| Y+R:                      | 4.0         | 4.0  | 4.0  | 4.0         | 4.0  | 4.0  | 4.0        | 4.0  | 4.0  | 4.0        | 4.0  | 4.0  |
| Volume Module:            |             |      |      |             |      |      |            |      |      |            |      |      |
| Base Vol:                 | 194         | 854  | 182  | 159         | 357  | 284  | 379        | 794  | 68   | 238        | 1402 | 312  |
| Growth Adj:               | 1.00        | 1.00 | 1.00 | 1.00        | 1.00 | 1.00 | 1.00       | 1.00 | 1.00 | 1.00       | 1.00 | 1.00 |
| Initial Bse:              | 194         | 854  | 182  | 159         | 357  | 284  | 379        | 794  | 68   | 238        | 1402 | 312  |
| Added Vol:                | 0           | 0    | 0    | 0           | 0    | 0    | 0          | 0    | 0    | 0          | 0    | 0    |
| PasserByVol:              | 0           | 0    | 0    | 0           | 0    | 0    | 0          | 0    | 0    | 0          | 0    | 0    |
| Initial Fut:              | 194         | 854  | 182  | 159         | 357  | 284  | 379        | 794  | 68   | 238        | 1402 | 312  |
| User Adj:                 | 1.00        | 1.00 | 1.00 | 1.00        | 1.00 | 1.00 | 1.00       | 1.00 | 1.00 | 1.00       | 1.00 | 1.00 |
| PHF Adj:                  | 1.00        | 1.00 | 1.00 | 1.00        | 1.00 | 1.00 | 1.00       | 1.00 | 1.00 | 1.00       | 1.00 | 1.00 |
| PHF Volume:               | 194         | 854  | 182  | 159         | 357  | 284  | 379        | 794  | 68   | 238        | 1402 | 312  |
| Reduct Vol:               | 0           | 0    | 0    | 0           | 0    | 0    | 0          | 0    | 0    | 0          | 0    | 0    |
| Reduced Vol:              | 194         | 854  | 182  | 159         | 357  | 284  | 379        | 794  | 68   | 238        | 1402 | 312  |
| PCE Adj:                  | 1.00        | 1.00 | 1.00 | 1.00        | 1.00 | 1.00 | 1.00       | 1.00 | 1.00 | 1.00       | 1.00 | 1.00 |
| MLF Adj:                  | 1.00        | 1.00 | 1.00 | 1.00        | 1.00 | 1.00 | 1.00       | 1.00 | 1.00 | 1.00       | 1.00 | 1.00 |
| Final Volume:             | 194         | 854  | 182  | 159         | 357  | 284  | 379        | 794  | 68   | 238        | 1402 | 312  |
| Saturation Flow Module:   |             |      |      |             |      |      |            |      |      |            |      |      |
| Sat/Lane:                 | 1900        | 1900 | 1900 | 1900        | 1900 | 1900 | 1900       | 1900 | 1900 | 1900       | 1900 | 1900 |
| Adjustment:               | 0.92        | 1.00 | 0.92 | 0.92        | 1.00 | 0.92 | 0.83       | 1.00 | 0.92 | 0.83       | 1.00 | 0.92 |
| Lanes:                    | 1.00        | 2.00 | 1.00 | 1.00        | 2.00 | 1.00 | 2.00       | 3.00 | 1.00 | 2.00       | 3.00 | 1.00 |
| Final Sat.:               | 1750        | 3800 | 1750 | 1750        | 3800 | 1750 | 3150       | 5700 | 1750 | 3150       | 5700 | 1750 |
| Capacity Analysis Module: |             |      |      |             |      |      |            |      |      |            |      |      |
| Vol/Sat:                  | 0.11        | 0.22 | 0.10 | 0.09        | 0.09 | 0.16 | 0.12       | 0.14 | 0.04 | 0.08       | 0.25 | 0.18 |
| Crit Moves:               | ****        | **** | **** | ****        | **** | **** | ****       | **** | **** | ****       | **** | **** |
| Green Time:               | 22.2        | 38.9 | 38.9 | 15.7        | 32.4 | 32.4 | 20.8       | 41.1 | 41.1 | 22.3       | 42.6 | 42.6 |
| Volume/Cap:               | 0.65        | 0.75 | 0.35 | 0.75        | 0.38 | 0.65 | 0.75       | 0.44 | 0.12 | 0.44       | 0.75 | 0.54 |
| Delay/Veh:                | 55.3        | 44.0 | 36.0 | 69.2        | 40.6 | 47.1 | 58.4       | 35.5 | 31.7 | 48.8       | 40.7 | 36.9 |
| User DelAdj:              | 1.00        | 1.00 | 1.00 | 1.00        | 1.00 | 1.00 | 1.00       | 1.00 | 1.00 | 1.00       | 1.00 | 1.00 |
| AdjDel/Veh:               | 55.3        | 44.0 | 36.0 | 69.2        | 40.6 | 47.1 | 58.4       | 35.5 | 31.7 | 48.8       | 40.7 | 36.9 |
| LOS by Move:              | E           | D    | D    | E           | D    | D    | E          | D    | C    | D          | D    | D    |
| HCM2k95thQ:               | 16          | 29   | 12   | 13          | 11   | 20   | 19         | 16   | 4    | 10         | 29   | 20   |

Note: Queue reported is the number of cars per lane.

BART

Level Of Service Computation Report  
 2000 HCM Operations (Future Volume Alternative)  
 PM - Bkgrd + Proj Conditions

Intersection #3683: McLAUGHLIN/STORY [Study Int 26]

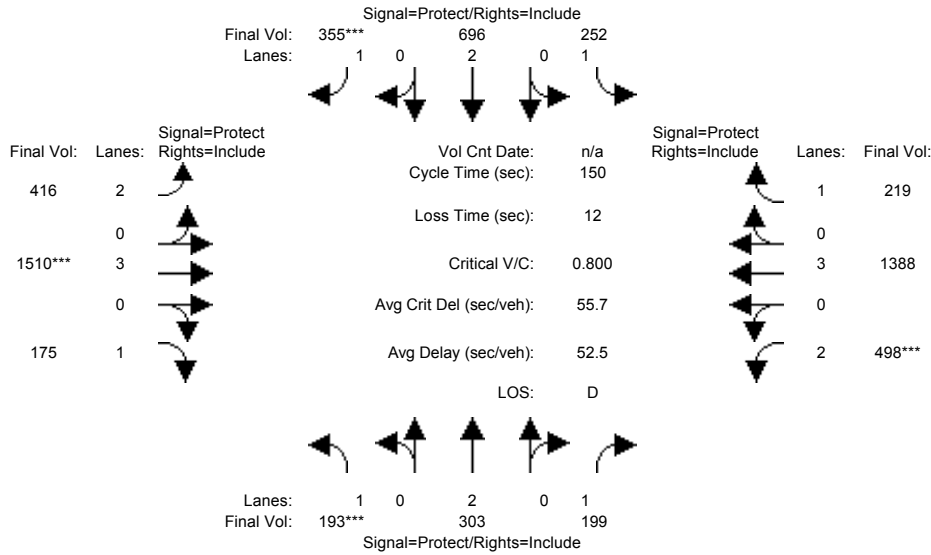

| Approach:                 | North Bound |      |      | South Bound |      |      | East Bound |      |      | West Bound |      |      |
|---------------------------|-------------|------|------|-------------|------|------|------------|------|------|------------|------|------|
| Movement:                 | L           | T    | R    | L           | T    | R    | L          | T    | R    | L          | T    | R    |
| Min. Green:               | 7           | 10   | 10   | 7           | 10   | 10   | 7          | 10   | 10   | 7          | 10   | 10   |
| Y+R:                      | 4.0         | 4.0  | 4.0  | 4.0         | 4.0  | 4.0  | 4.0        | 4.0  | 4.0  | 4.0        | 4.0  | 4.0  |
| Volume Module:            |             |      |      |             |      |      |            |      |      |            |      |      |
| Base Vol:                 | 193         | 303  | 199  | 252         | 696  | 355  | 416        | 1510 | 175  | 498        | 1388 | 219  |
| Growth Adj:               | 1.00        | 1.00 | 1.00 | 1.00        | 1.00 | 1.00 | 1.00       | 1.00 | 1.00 | 1.00       | 1.00 | 1.00 |
| Initial Bse:              | 193         | 303  | 199  | 252         | 696  | 355  | 416        | 1510 | 175  | 498        | 1388 | 219  |
| Added Vol:                | 0           | 0    | 0    | 0           | 0    | 0    | 0          | 0    | 0    | 0          | 0    | 0    |
| PasserByVol:              | 0           | 0    | 0    | 0           | 0    | 0    | 0          | 0    | 0    | 0          | 0    | 0    |
| Initial Fut:              | 193         | 303  | 199  | 252         | 696  | 355  | 416        | 1510 | 175  | 498        | 1388 | 219  |
| User Adj:                 | 1.00        | 1.00 | 1.00 | 1.00        | 1.00 | 1.00 | 1.00       | 1.00 | 1.00 | 1.00       | 1.00 | 1.00 |
| PHF Adj:                  | 1.00        | 1.00 | 1.00 | 1.00        | 1.00 | 1.00 | 1.00       | 1.00 | 1.00 | 1.00       | 1.00 | 1.00 |
| PHF Volume:               | 193         | 303  | 199  | 252         | 696  | 355  | 416        | 1510 | 175  | 498        | 1388 | 219  |
| Reduct Vol:               | 0           | 0    | 0    | 0           | 0    | 0    | 0          | 0    | 0    | 0          | 0    | 0    |
| Reduced Vol:              | 193         | 303  | 199  | 252         | 696  | 355  | 416        | 1510 | 175  | 498        | 1388 | 219  |
| PCE Adj:                  | 1.00        | 1.00 | 1.00 | 1.00        | 1.00 | 1.00 | 1.00       | 1.00 | 1.00 | 1.00       | 1.00 | 1.00 |
| MLF Adj:                  | 1.00        | 1.00 | 1.00 | 1.00        | 1.00 | 1.00 | 1.00       | 1.00 | 1.00 | 1.00       | 1.00 | 1.00 |
| Final Volume:             | 193         | 303  | 199  | 252         | 696  | 355  | 416        | 1510 | 175  | 498        | 1388 | 219  |
| Saturation Flow Module:   |             |      |      |             |      |      |            |      |      |            |      |      |
| Sat/Lane:                 | 1900        | 1900 | 1900 | 1900        | 1900 | 1900 | 1900       | 1900 | 1900 | 1900       | 1900 | 1900 |
| Adjustment:               | 0.92        | 1.00 | 0.92 | 0.92        | 1.00 | 0.92 | 0.83       | 1.00 | 0.92 | 0.83       | 1.00 | 0.92 |
| Lanes:                    | 1.00        | 2.00 | 1.00 | 1.00        | 2.00 | 1.00 | 2.00       | 3.00 | 1.00 | 2.00       | 3.00 | 1.00 |
| Final Sat.:               | 1750        | 3800 | 1750 | 1750        | 3800 | 1750 | 3150       | 5700 | 1750 | 3150       | 5700 | 1750 |
| Capacity Analysis Module: |             |      |      |             |      |      |            |      |      |            |      |      |
| Vol/Sat:                  | 0.11        | 0.08 | 0.11 | 0.14        | 0.18 | 0.20 | 0.13       | 0.26 | 0.10 | 0.16       | 0.24 | 0.13 |
| Crit Moves:               | ****        |      |      |             |      | **** | ****       |      |      | ****       |      |      |
| Green Time:               | 20.7        | 25.9 | 25.9 | 32.8        | 38.0 | 38.0 | 27.9       | 49.7 | 49.7 | 29.6       | 51.4 | 51.4 |
| Volume/Cap:               | 0.80        | 0.46 | 0.66 | 0.66        | 0.72 | 0.80 | 0.71       | 0.80 | 0.30 | 0.80       | 0.71 | 0.37 |
| Delay/Veh:                | 79.7        | 56.3 | 63.2 | 57.7        | 53.9 | 62.4 | 61.3       | 48.2 | 37.6 | 64.6       | 44.1 | 37.4 |
| User DelAdj:              | 1.00        | 1.00 | 1.00 | 1.00        | 1.00 | 1.00 | 1.00       | 1.00 | 1.00 | 1.00       | 1.00 | 1.00 |
| AdjDel/Veh:               | 79.7        | 56.3 | 63.2 | 57.7        | 53.9 | 62.4 | 61.3       | 48.2 | 37.6 | 64.6       | 44.1 | 37.4 |
| LOS by Move:              | E           | E    | E    | E           | D    | E    | E          | D    | D    | E          | D    | D    |
| HCM2k95thQ:               | 21          | 12   | 19   | 21          | 26   | 30   | 22         | 37   | 12   | 24         | 32   | 15   |

Note: Queue reported is the number of cars per lane.

BART

Level Of Service Computation Report  
 2000 HCM Operations (Future Volume Alternative)  
 AM - Bkgrd + Proj Conditions

Intersection #3762: SAN ANTONIO/24TH [Study Int 21]

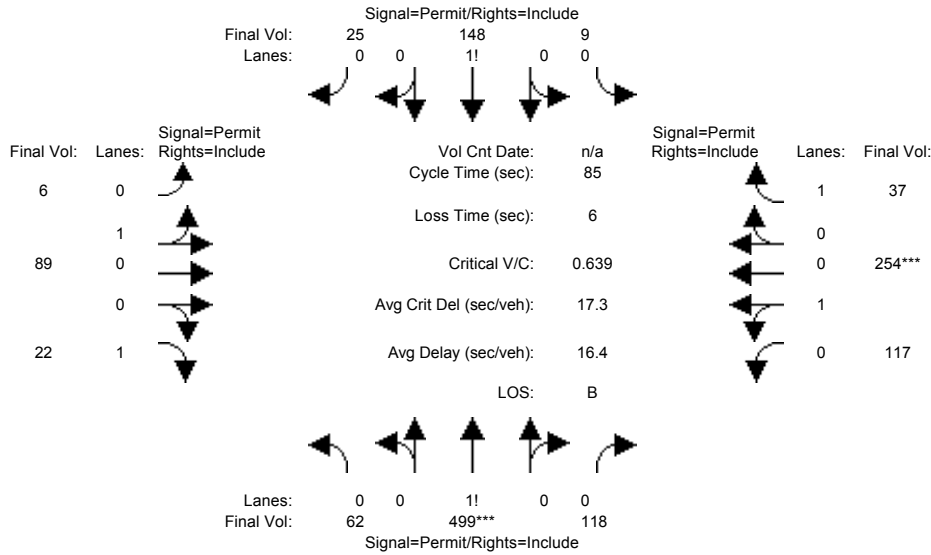

| Approach:                 | North Bound |      |      | South Bound |      |      | East Bound |      |      | West Bound |      |      |
|---------------------------|-------------|------|------|-------------|------|------|------------|------|------|------------|------|------|
| Movement:                 | L           | T    | R    | L           | T    | R    | L          | T    | R    | L          | T    | R    |
| Min. Green:               | 10          | 10   | 10   | 10          | 10   | 10   | 10         | 10   | 10   | 10         | 10   | 10   |
| Y+R:                      | 4.0         | 4.0  | 4.0  | 4.0         | 4.0  | 4.0  | 4.0        | 4.0  | 4.0  | 4.0        | 4.0  | 4.0  |
| Volume Module:            |             |      |      |             |      |      |            |      |      |            |      |      |
| Base Vol:                 | 62          | 499  | 118  | 9           | 148  | 25   | 6          | 89   | 22   | 117        | 254  | 37   |
| Growth Adj:               | 1.00        | 1.00 | 1.00 | 1.00        | 1.00 | 1.00 | 1.00       | 1.00 | 1.00 | 1.00       | 1.00 | 1.00 |
| Initial Bse:              | 62          | 499  | 118  | 9           | 148  | 25   | 6          | 89   | 22   | 117        | 254  | 37   |
| Added Vol:                | 0           | 0    | 0    | 0           | 0    | 0    | 0          | 0    | 0    | 0          | 0    | 0    |
| PasserByVol:              | 0           | 0    | 0    | 0           | 0    | 0    | 0          | 0    | 0    | 0          | 0    | 0    |
| Initial Fut:              | 62          | 499  | 118  | 9           | 148  | 25   | 6          | 89   | 22   | 117        | 254  | 37   |
| User Adj:                 | 1.00        | 1.00 | 1.00 | 1.00        | 1.00 | 1.00 | 1.00       | 1.00 | 1.00 | 1.00       | 1.00 | 1.00 |
| PHF Adj:                  | 1.00        | 1.00 | 1.00 | 1.00        | 1.00 | 1.00 | 1.00       | 1.00 | 1.00 | 1.00       | 1.00 | 1.00 |
| PHF Volume:               | 62          | 499  | 118  | 9           | 148  | 25   | 6          | 89   | 22   | 117        | 254  | 37   |
| Reduct Vol:               | 0           | 0    | 0    | 0           | 0    | 0    | 0          | 0    | 0    | 0          | 0    | 0    |
| Reduced Vol:              | 62          | 499  | 118  | 9           | 148  | 25   | 6          | 89   | 22   | 117        | 254  | 37   |
| PCE Adj:                  | 1.00        | 1.00 | 1.00 | 1.00        | 1.00 | 1.00 | 1.00       | 1.00 | 1.00 | 1.00       | 1.00 | 1.00 |
| MLF Adj:                  | 1.00        | 1.00 | 1.00 | 1.00        | 1.00 | 1.00 | 1.00       | 1.00 | 1.00 | 1.00       | 1.00 | 1.00 |
| FinalVolume:              | 62          | 499  | 118  | 9           | 148  | 25   | 6          | 89   | 22   | 117        | 254  | 37   |
| Saturation Flow Module:   |             |      |      |             |      |      |            |      |      |            |      |      |
| Sat/Lane:                 | 1900        | 1900 | 1900 | 1900        | 1900 | 1900 | 1900       | 1900 | 1900 | 1900       | 1900 | 1900 |
| Adjustment:               | 0.92        | 0.92 | 0.92 | 0.92        | 0.92 | 0.92 | 0.95       | 0.95 | 0.92 | 0.95       | 0.95 | 0.92 |
| Lanes:                    | 0.09        | 0.74 | 0.17 | 0.05        | 0.81 | 0.14 | 0.06       | 0.94 | 1.00 | 0.32       | 0.68 | 1.00 |
| Final Sat.:               | 160         | 1286 | 304  | 87          | 1423 | 240  | 114        | 1686 | 1750 | 568        | 1232 | 1750 |
| Capacity Analysis Module: |             |      |      |             |      |      |            |      |      |            |      |      |
| Vol/Sat:                  | 0.39        | 0.39 | 0.39 | 0.10        | 0.10 | 0.10 | 0.05       | 0.05 | 0.01 | 0.21       | 0.21 | 0.02 |
| Crit Moves:               | ****        |      |      |             |      |      |            |      |      | ****       |      |      |
| Green Time:               | 51.6        | 51.6 | 51.6 | 51.6        | 51.6 | 51.6 | 27.4       | 27.4 | 27.4 | 27.4       | 27.4 | 27.4 |
| Volume/Cap:               | 0.64        | 0.64 | 0.64 | 0.17        | 0.17 | 0.17 | 0.16       | 0.16 | 0.04 | 0.64       | 0.64 | 0.07 |
| Delay/Veh:                | 12.0        | 12.0 | 12.0 | 7.4         | 7.4  | 7.4  | 20.7       | 20.7 | 19.8 | 27.0       | 27.0 | 20.0 |
| User DelAdj:              | 1.00        | 1.00 | 1.00 | 1.00        | 1.00 | 1.00 | 1.00       | 1.00 | 1.00 | 1.00       | 1.00 | 1.00 |
| AdjDel/Veh:               | 12.0        | 12.0 | 12.0 | 7.4         | 7.4  | 7.4  | 20.7       | 20.7 | 19.8 | 27.0       | 27.0 | 20.0 |
| LOS by Move:              | B           | B    | B    | A           | A    | A    | C          | C    | B    | C          | C    | B    |
| HCM2k95thQ:               | 22          | 22   | 22   | 5           | 5    | 5    | 4          | 4    | 1    | 16         | 16   | 1    |

Note: Queue reported is the number of cars per lane.

BART

Level Of Service Computation Report  
 2000 HCM Operations (Future Volume Alternative)  
 PM - Bkgrd + Proj Conditions

Intersection #3762: SAN ANTONIO/24TH [Study Int 21]

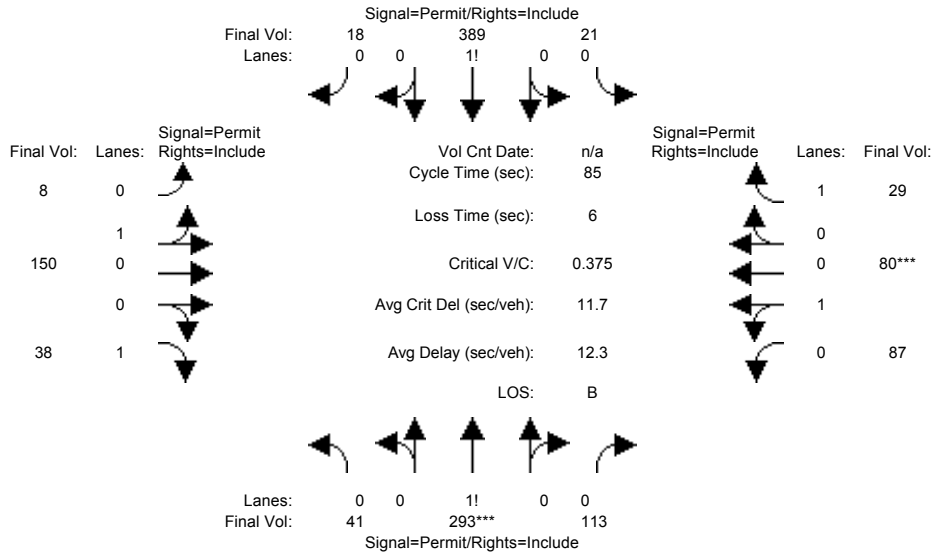

| Approach:                 | North Bound |      |      | South Bound |      |      | East Bound |      |      | West Bound |      |      |
|---------------------------|-------------|------|------|-------------|------|------|------------|------|------|------------|------|------|
| Movement:                 | L           | T    | R    | L           | T    | R    | L          | T    | R    | L          | T    | R    |
| Min. Green:               | 10          | 10   | 10   | 10          | 10   | 10   | 10         | 10   | 10   | 10         | 10   | 10   |
| Y+R:                      | 4.0         | 4.0  | 4.0  | 4.0         | 4.0  | 4.0  | 4.0        | 4.0  | 4.0  | 4.0        | 4.0  | 4.0  |
| Volume Module:            |             |      |      |             |      |      |            |      |      |            |      |      |
| Base Vol:                 | 41          | 293  | 113  | 21          | 389  | 18   | 8          | 150  | 38   | 87         | 80   | 29   |
| Growth Adj:               | 1.00        | 1.00 | 1.00 | 1.00        | 1.00 | 1.00 | 1.00       | 1.00 | 1.00 | 1.00       | 1.00 | 1.00 |
| Initial Bse:              | 41          | 293  | 113  | 21          | 389  | 18   | 8          | 150  | 38   | 87         | 80   | 29   |
| Added Vol:                | 0           | 0    | 0    | 0           | 0    | 0    | 0          | 0    | 0    | 0          | 0    | 0    |
| PasserByVol:              | 0           | 0    | 0    | 0           | 0    | 0    | 0          | 0    | 0    | 0          | 0    | 0    |
| Initial Fut:              | 41          | 293  | 113  | 21          | 389  | 18   | 8          | 150  | 38   | 87         | 80   | 29   |
| User Adj:                 | 1.00        | 1.00 | 1.00 | 1.00        | 1.00 | 1.00 | 1.00       | 1.00 | 1.00 | 1.00       | 1.00 | 1.00 |
| PHF Adj:                  | 1.00        | 1.00 | 1.00 | 1.00        | 1.00 | 1.00 | 1.00       | 1.00 | 1.00 | 1.00       | 1.00 | 1.00 |
| PHF Volume:               | 41          | 293  | 113  | 21          | 389  | 18   | 8          | 150  | 38   | 87         | 80   | 29   |
| Reduct Vol:               | 0           | 0    | 0    | 0           | 0    | 0    | 0          | 0    | 0    | 0          | 0    | 0    |
| Reduced Vol:              | 41          | 293  | 113  | 21          | 389  | 18   | 8          | 150  | 38   | 87         | 80   | 29   |
| PCE Adj:                  | 1.00        | 1.00 | 1.00 | 1.00        | 1.00 | 1.00 | 1.00       | 1.00 | 1.00 | 1.00       | 1.00 | 1.00 |
| MLF Adj:                  | 1.00        | 1.00 | 1.00 | 1.00        | 1.00 | 1.00 | 1.00       | 1.00 | 1.00 | 1.00       | 1.00 | 1.00 |
| Final Volume:             | 41          | 293  | 113  | 21          | 389  | 18   | 8          | 150  | 38   | 87         | 80   | 29   |
| Saturation Flow Module:   |             |      |      |             |      |      |            |      |      |            |      |      |
| Sat/Lane:                 | 1900        | 1900 | 1900 | 1900        | 1900 | 1900 | 1900       | 1900 | 1900 | 1900       | 1900 | 1900 |
| Adjustment:               | 0.92        | 0.92 | 0.92 | 0.92        | 0.92 | 0.92 | 0.95       | 0.95 | 0.92 | 0.95       | 0.95 | 0.92 |
| Lanes:                    | 0.09        | 0.66 | 0.25 | 0.05        | 0.91 | 0.04 | 0.05       | 0.95 | 1.00 | 0.52       | 0.48 | 1.00 |
| Final Sat.:               | 161         | 1147 | 442  | 86          | 1591 | 74   | 91         | 1709 | 1750 | 938        | 862  | 1750 |
| Capacity Analysis Module: |             |      |      |             |      |      |            |      |      |            |      |      |
| Vol/Sat:                  | 0.26        | 0.26 | 0.26 | 0.24        | 0.24 | 0.24 | 0.09       | 0.09 | 0.02 | 0.09       | 0.09 | 0.02 |
| Crit Moves:               | ****        |      |      |             |      |      |            |      |      | ****       |      |      |
| Green Time:               | 58.0        | 58.0 | 58.0 | 58.0        | 58.0 | 58.0 | 21.0       | 21.0 | 21.0 | 21.0       | 21.0 | 21.0 |
| Volume/Cap:               | 0.37        | 0.37 | 0.37 | 0.36        | 0.36 | 0.36 | 0.35       | 0.35 | 0.09 | 0.37       | 0.37 | 0.07 |
| Delay/Veh:                | 6.0         | 6.0  | 6.0  | 5.9         | 5.9  | 5.9  | 26.9       | 26.9 | 24.7 | 27.0       | 27.0 | 24.5 |
| User DelAdj:              | 1.00        | 1.00 | 1.00 | 1.00        | 1.00 | 1.00 | 1.00       | 1.00 | 1.00 | 1.00       | 1.00 | 1.00 |
| AdjDel/Veh:               | 6.0         | 6.0  | 6.0  | 5.9         | 5.9  | 5.9  | 26.9       | 26.9 | 24.7 | 27.0       | 27.0 | 24.5 |
| LOS by Move:              | A           | A    | A    | A           | A    | A    | C          | C    | C    | C          | C    | C    |
| HCM2k95thQ:               | 10          | 10   | 10   | 10          | 10   | 10   | 8          | 8    | 2    | 7          | 7    | 1    |

Note: Queue reported is the number of cars per lane.

BART

Level Of Service Computation Report  
2000 HCM Operations (Future Volume Alternative)  
AM - Bkgrd + Proj Conditions

Intersection #3783: SANTA CLARA/17TH [Study Int 9]

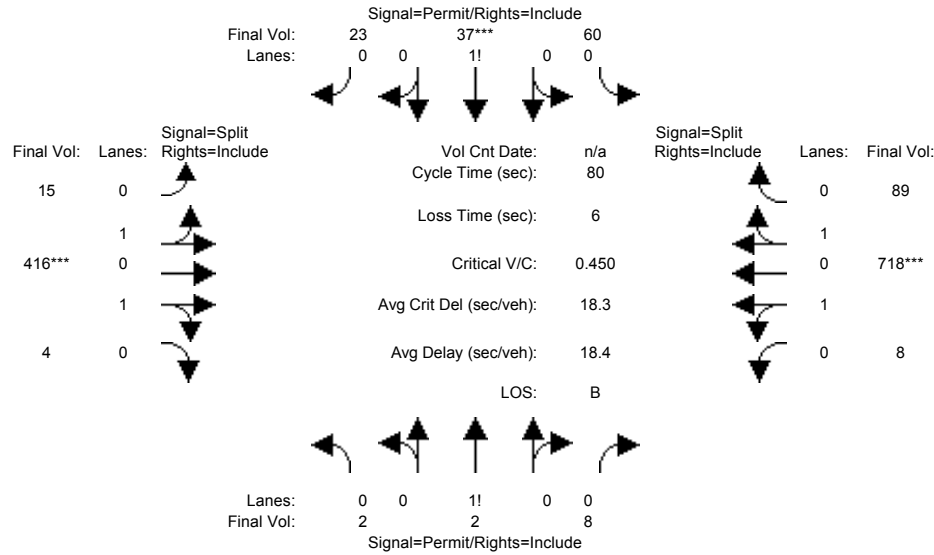

| Approach:                 | North Bound |      |      | South Bound |      |      | East Bound |      |      | West Bound |      |      |
|---------------------------|-------------|------|------|-------------|------|------|------------|------|------|------------|------|------|
| Movement:                 | L           | T    | R    | L           | T    | R    | L          | T    | R    | L          | T    | R    |
| Min. Green:               | 10          | 10   | 10   | 10          | 10   | 10   | 10         | 10   | 10   | 10         | 10   | 10   |
| Y+R:                      | 4.0         | 4.0  | 4.0  | 4.0         | 4.0  | 4.0  | 4.0        | 4.0  | 4.0  | 4.0        | 4.0  | 4.0  |
| Volume Module:            |             |      |      |             |      |      |            |      |      |            |      |      |
| Base Vol:                 | 2           | 2    | 8    | 60          | 37   | 23   | 15         | 416  | 4    | 8          | 718  | 89   |
| Growth Adj:               | 1.00        | 1.00 | 1.00 | 1.00        | 1.00 | 1.00 | 1.00       | 1.00 | 1.00 | 1.00       | 1.00 | 1.00 |
| Initial Bse:              | 2           | 2    | 8    | 60          | 37   | 23   | 15         | 416  | 4    | 8          | 718  | 89   |
| Added Vol:                | 0           | 0    | 0    | 0           | 0    | 0    | 0          | 0    | 0    | 0          | 0    | 0    |
| PasserByVol:              | 0           | 0    | 0    | 0           | 0    | 0    | 0          | 0    | 0    | 0          | 0    | 0    |
| Initial Fut:              | 2           | 2    | 8    | 60          | 37   | 23   | 15         | 416  | 4    | 8          | 718  | 89   |
| User Adj:                 | 1.00        | 1.00 | 1.00 | 1.00        | 1.00 | 1.00 | 1.00       | 1.00 | 1.00 | 1.00       | 1.00 | 1.00 |
| PHF Adj:                  | 1.00        | 1.00 | 1.00 | 1.00        | 1.00 | 1.00 | 1.00       | 1.00 | 1.00 | 1.00       | 1.00 | 1.00 |
| PHF Volume:               | 2           | 2    | 8    | 60          | 37   | 23   | 15         | 416  | 4    | 8          | 718  | 89   |
| Reduct Vol:               | 0           | 0    | 0    | 0           | 0    | 0    | 0          | 0    | 0    | 0          | 0    | 0    |
| Reduced Vol:              | 2           | 2    | 8    | 60          | 37   | 23   | 15         | 416  | 4    | 8          | 718  | 89   |
| PCE Adj:                  | 1.00        | 1.00 | 1.00 | 1.00        | 1.00 | 1.00 | 1.00       | 1.00 | 1.00 | 1.00       | 1.00 | 1.00 |
| MLF Adj:                  | 1.00        | 1.00 | 1.00 | 1.00        | 1.00 | 1.00 | 1.00       | 1.00 | 1.00 | 1.00       | 1.00 | 1.00 |
| Final Volume:             | 2           | 2    | 8    | 60          | 37   | 23   | 15         | 416  | 4    | 8          | 718  | 89   |
| Saturation Flow Module:   |             |      |      |             |      |      |            |      |      |            |      |      |
| Sat/Lane:                 | 1900        | 1900 | 1900 | 1900        | 1900 | 1900 | 1900       | 1900 | 1900 | 1900       | 1900 | 1900 |
| Adjustment:               | 0.92        | 0.92 | 0.92 | 0.92        | 0.92 | 0.92 | 0.95       | 0.95 | 0.95 | 0.95       | 0.95 | 0.95 |
| Lanes:                    | 0.16        | 0.17 | 0.67 | 0.50        | 0.31 | 0.19 | 0.07       | 1.91 | 0.02 | 0.02       | 1.76 | 0.22 |
| Final Sat.:               | 292         | 292  | 1167 | 875         | 540  | 335  | 124        | 3443 | 33   | 35         | 3172 | 393  |
| Capacity Analysis Module: |             |      |      |             |      |      |            |      |      |            |      |      |
| Vol/Sat:                  | 0.01        | 0.01 | 0.01 | 0.07        | 0.07 | 0.07 | 0.12       | 0.12 | 0.12 | 0.23       | 0.23 | 0.23 |
| Crit Moves:               |             |      |      | ****        |      |      | ****       |      |      | ****       |      |      |
| Green Time:               | 12.2        | 12.2 | 12.2 | 12.2        | 12.2 | 12.2 | 21.5       | 21.5 | 21.5 | 40.3       | 40.3 | 40.3 |
| Volume/Cap:               | 0.04        | 0.04 | 0.04 | 0.45        | 0.45 | 0.45 | 0.45       | 0.45 | 0.45 | 0.45       | 0.45 | 0.45 |
| Delay/Veh:                | 29.0        | 29.0 | 29.0 | 32.0        | 32.0 | 32.0 | 24.7       | 24.7 | 24.7 | 12.9       | 12.9 | 12.9 |
| User DelAdj:              | 1.00        | 1.00 | 1.00 | 1.00        | 1.00 | 1.00 | 1.00       | 1.00 | 1.00 | 1.00       | 1.00 | 1.00 |
| AdjDel/Veh:               | 29.0        | 29.0 | 29.0 | 32.0        | 32.0 | 32.0 | 24.7       | 24.7 | 24.7 | 12.9       | 12.9 | 12.9 |
| LOS by Move:              | C           | C    | C    | C           | C    | C    | C          | C    | C    | B          | B    | B    |
| HCM2k95thQ:               | 1           | 1    | 1    | 7           | 7    | 7    | 10         | 10   | 10   | 13         | 13   | 13   |

Note: Queue reported is the number of cars per lane.

BART

Level Of Service Computation Report  
 2000 HCM Operations (Future Volume Alternative)  
 PM - Bkgrd + Proj Conditions

Intersection #3783: SANTA CLARA/17TH [Study Int 9]

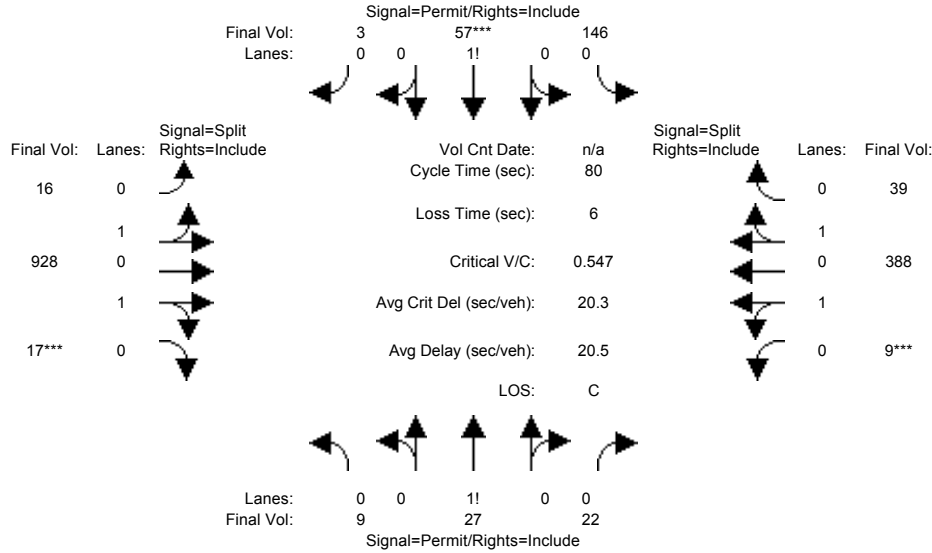

| Approach:                 | North Bound |      |      | South Bound |      |      | East Bound |      |      | West Bound |      |      |
|---------------------------|-------------|------|------|-------------|------|------|------------|------|------|------------|------|------|
| Movement:                 | L           | T    | R    | L           | T    | R    | L          | T    | R    | L          | T    | R    |
| Min. Green:               | 10          | 10   | 10   | 10          | 10   | 10   | 10         | 10   | 10   | 10         | 10   | 10   |
| Y+R:                      | 4.0         | 4.0  | 4.0  | 4.0         | 4.0  | 4.0  | 4.0        | 4.0  | 4.0  | 4.0        | 4.0  | 4.0  |
| Volume Module:            |             |      |      |             |      |      |            |      |      |            |      |      |
| Base Vol:                 | 9           | 27   | 22   | 146         | 57   | 3    | 16         | 928  | 17   | 9          | 388  | 39   |
| Growth Adj:               | 1.00        | 1.00 | 1.00 | 1.00        | 1.00 | 1.00 | 1.00       | 1.00 | 1.00 | 1.00       | 1.00 | 1.00 |
| Initial Bse:              | 9           | 27   | 22   | 146         | 57   | 3    | 16         | 928  | 17   | 9          | 388  | 39   |
| Added Vol:                | 0           | 0    | 0    | 0           | 0    | 0    | 0          | 0    | 0    | 0          | 0    | 0    |
| PasserByVol:              | 0           | 0    | 0    | 0           | 0    | 0    | 0          | 0    | 0    | 0          | 0    | 0    |
| Initial Fut:              | 9           | 27   | 22   | 146         | 57   | 3    | 16         | 928  | 17   | 9          | 388  | 39   |
| User Adj:                 | 1.00        | 1.00 | 1.00 | 1.00        | 1.00 | 1.00 | 1.00       | 1.00 | 1.00 | 1.00       | 1.00 | 1.00 |
| PHF Adj:                  | 1.00        | 1.00 | 1.00 | 1.00        | 1.00 | 1.00 | 1.00       | 1.00 | 1.00 | 1.00       | 1.00 | 1.00 |
| PHF Volume:               | 9           | 27   | 22   | 146         | 57   | 3    | 16         | 928  | 17   | 9          | 388  | 39   |
| Reduct Vol:               | 0           | 0    | 0    | 0           | 0    | 0    | 0          | 0    | 0    | 0          | 0    | 0    |
| Reduced Vol:              | 9           | 27   | 22   | 146         | 57   | 3    | 16         | 928  | 17   | 9          | 388  | 39   |
| PCE Adj:                  | 1.00        | 1.00 | 1.00 | 1.00        | 1.00 | 1.00 | 1.00       | 1.00 | 1.00 | 1.00       | 1.00 | 1.00 |
| MLF Adj:                  | 1.00        | 1.00 | 1.00 | 1.00        | 1.00 | 1.00 | 1.00       | 1.00 | 1.00 | 1.00       | 1.00 | 1.00 |
| FinalVolume:              | 9           | 27   | 22   | 146         | 57   | 3    | 16         | 928  | 17   | 9          | 388  | 39   |
| Saturation Flow Module:   |             |      |      |             |      |      |            |      |      |            |      |      |
| Sat/Lane:                 | 1900        | 1900 | 1900 | 1900        | 1900 | 1900 | 1900       | 1900 | 1900 | 1900       | 1900 | 1900 |
| Adjustment:               | 0.92        | 0.92 | 0.92 | 0.92        | 0.92 | 0.92 | 0.95       | 0.95 | 0.95 | 0.95       | 0.95 | 0.95 |
| Lanes:                    | 0.15        | 0.47 | 0.38 | 0.71        | 0.28 | 0.01 | 0.03       | 1.93 | 0.04 | 0.04       | 1.78 | 0.18 |
| Final Sat.:               | 272         | 815  | 664  | 1240        | 484  | 25   | 60         | 3476 | 64   | 74         | 3204 | 322  |
| Capacity Analysis Module: |             |      |      |             |      |      |            |      |      |            |      |      |
| Vol/Sat:                  | 0.03        | 0.03 | 0.03 | 0.12        | 0.12 | 0.12 | 0.27       | 0.27 | 0.27 | 0.12       | 0.12 | 0.12 |
| Crit Moves:               |             |      |      | ****        |      |      | ****       |      | **** | ****       |      |      |
| Green Time:               | 17.2        | 17.2 | 17.2 | 17.2        | 17.2 | 17.2 | 39.1       | 39.1 | 39.1 | 17.7       | 17.7 | 17.7 |
| Volume/Cap:               | 0.15        | 0.15 | 0.15 | 0.55        | 0.55 | 0.55 | 0.55       | 0.55 | 0.55 | 0.55       | 0.55 | 0.55 |
| Delay/Veh:                | 25.7        | 25.7 | 25.7 | 29.6        | 29.6 | 29.6 | 14.7       | 14.7 | 14.7 | 28.4       | 28.4 | 28.4 |
| User DelAdj:              | 1.00        | 1.00 | 1.00 | 1.00        | 1.00 | 1.00 | 1.00       | 1.00 | 1.00 | 1.00       | 1.00 | 1.00 |
| AdjDel/Veh:               | 25.7        | 25.7 | 25.7 | 29.6        | 29.6 | 29.6 | 14.7       | 14.7 | 14.7 | 28.4       | 28.4 | 28.4 |
| LOS by Move:              | C           | C    | C    | C           | C    | C    | B          | B    | B    | C          | C    | C    |
| HCM2k95thQ:               | 3           | 3    | 3    | 11          | 11   | 11   | 17         | 17   | 17   | 10         | 10   | 10   |

Note: Queue reported is the number of cars per lane.

BART

Level Of Service Computation Report  
 2000 HCM Operations (Future Volume Alternative)  
 AM - Bkgrd + Proj Conditions

Intersection #3788: SANTA CLARA/28TH [Study Int 13]

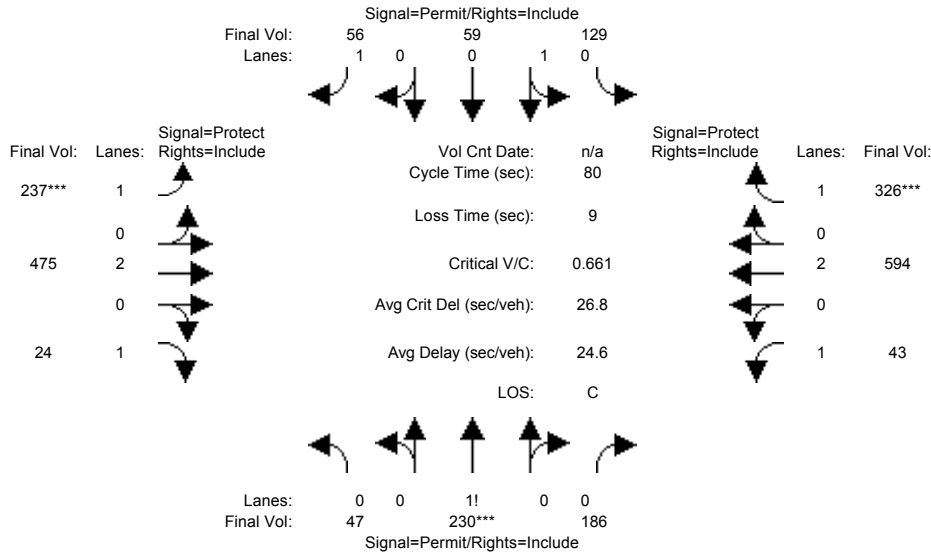

| Approach:                 | North Bound |      |      | South Bound |      |      | East Bound |      |      | West Bound |      |      |
|---------------------------|-------------|------|------|-------------|------|------|------------|------|------|------------|------|------|
| Movement:                 | L           | T    | R    | L           | T    | R    | L          | T    | R    | L          | T    | R    |
| Min. Green:               | 10          | 10   | 10   | 10          | 10   | 10   | 7          | 10   | 10   | 7          | 10   | 10   |
| Y+R:                      | 4.0         | 4.0  | 4.0  | 4.0         | 4.0  | 4.0  | 4.0        | 4.0  | 4.0  | 4.0        | 4.0  | 4.0  |
| Volume Module:            |             |      |      |             |      |      |            |      |      |            |      |      |
| Base Vol:                 | 47          | 230  | 186  | 129         | 59   | 56   | 237        | 475  | 24   | 43         | 594  | 326  |
| Growth Adj:               | 1.00        | 1.00 | 1.00 | 1.00        | 1.00 | 1.00 | 1.00       | 1.00 | 1.00 | 1.00       | 1.00 | 1.00 |
| Initial Bse:              | 47          | 230  | 186  | 129         | 59   | 56   | 237        | 475  | 24   | 43         | 594  | 326  |
| Added Vol:                | 0           | 0    | 0    | 0           | 0    | 0    | 0          | 0    | 0    | 0          | 0    | 0    |
| PasserByVol:              | 0           | 0    | 0    | 0           | 0    | 0    | 0          | 0    | 0    | 0          | 0    | 0    |
| Initial Fut:              | 47          | 230  | 186  | 129         | 59   | 56   | 237        | 475  | 24   | 43         | 594  | 326  |
| User Adj:                 | 1.00        | 1.00 | 1.00 | 1.00        | 1.00 | 1.00 | 1.00       | 1.00 | 1.00 | 1.00       | 1.00 | 1.00 |
| PHF Adj:                  | 1.00        | 1.00 | 1.00 | 1.00        | 1.00 | 1.00 | 1.00       | 1.00 | 1.00 | 1.00       | 1.00 | 1.00 |
| PHF Volume:               | 47          | 230  | 186  | 129         | 59   | 56   | 237        | 475  | 24   | 43         | 594  | 326  |
| Reduct Vol:               | 0           | 0    | 0    | 0           | 0    | 0    | 0          | 0    | 0    | 0          | 0    | 0    |
| Reduced Vol:              | 47          | 230  | 186  | 129         | 59   | 56   | 237        | 475  | 24   | 43         | 594  | 326  |
| PCE Adj:                  | 1.00        | 1.00 | 1.00 | 1.00        | 1.00 | 1.00 | 1.00       | 1.00 | 1.00 | 1.00       | 1.00 | 1.00 |
| MLF Adj:                  | 1.00        | 1.00 | 1.00 | 1.00        | 1.00 | 1.00 | 1.00       | 1.00 | 1.00 | 1.00       | 1.00 | 1.00 |
| Final Volume:             | 47          | 230  | 186  | 129         | 59   | 56   | 237        | 475  | 24   | 43         | 594  | 326  |
| Saturation Flow Module:   |             |      |      |             |      |      |            |      |      |            |      |      |
| Sat/Lane:                 | 1900        | 1900 | 1900 | 1900        | 1900 | 1900 | 1900       | 1900 | 1900 | 1900       | 1900 | 1900 |
| Adjustment:               | 0.92        | 0.92 | 0.92 | 0.95        | 0.95 | 0.92 | 0.92       | 1.00 | 0.92 | 0.92       | 1.00 | 0.92 |
| Lanes:                    | 0.10        | 0.50 | 0.40 | 0.69        | 0.31 | 1.00 | 1.00       | 2.00 | 1.00 | 1.00       | 2.00 | 1.00 |
| Final Sat.:               | 178         | 869  | 703  | 1235        | 565  | 1750 | 1750       | 3800 | 1750 | 1750       | 3800 | 1750 |
| Capacity Analysis Module: |             |      |      |             |      |      |            |      |      |            |      |      |
| Vol/Sat:                  | 0.26        | 0.26 | 0.26 | 0.10        | 0.10 | 0.03 | 0.14       | 0.13 | 0.01 | 0.02       | 0.16 | 0.19 |
| Crit Moves:               | ****        |      |      |             |      |      | ****       |      |      | ****       |      |      |
| Green Time:               | 32.0        | 32.0 | 32.0 | 32.0        | 32.0 | 32.0 | 16.4       | 22.9 | 22.9 | 16.0       | 22.6 | 22.6 |
| Volume/Cap:               | 0.66        | 0.66 | 0.66 | 0.26        | 0.26 | 0.08 | 0.66       | 0.44 | 0.05 | 0.12       | 0.55 | 0.66 |
| Delay/Veh:                | 21.9        | 21.9 | 21.9 | 16.2        | 16.2 | 14.9 | 33.8       | 23.6 | 20.7 | 26.4       | 25.1 | 28.7 |
| User DelAdj:              | 1.00        | 1.00 | 1.00 | 1.00        | 1.00 | 1.00 | 1.00       | 1.00 | 1.00 | 1.00       | 1.00 | 1.00 |
| AdjDel/Veh:               | 21.9        | 21.9 | 21.9 | 16.2        | 16.2 | 14.9 | 33.8       | 23.6 | 20.7 | 26.4       | 25.1 | 28.7 |
| LOS by Move:              | C           | C    | C    | B           | B    | B    | C          | C    | C    | C          | C    | C    |
| HCM2k95thQ:               | 19          | 19   | 19   | 6           | 6    | 2    | 11         | 9    | 1    | 2          | 12   | 15   |

Note: Queue reported is the number of cars per lane.



BART

Level Of Service Computation Report  
 2000 HCM Operations (Future Volume Alternative)  
 PM - Bkgrd + Proj Conditions

Intersection #3788: SANTA CLARA/28TH [Study Int 13]

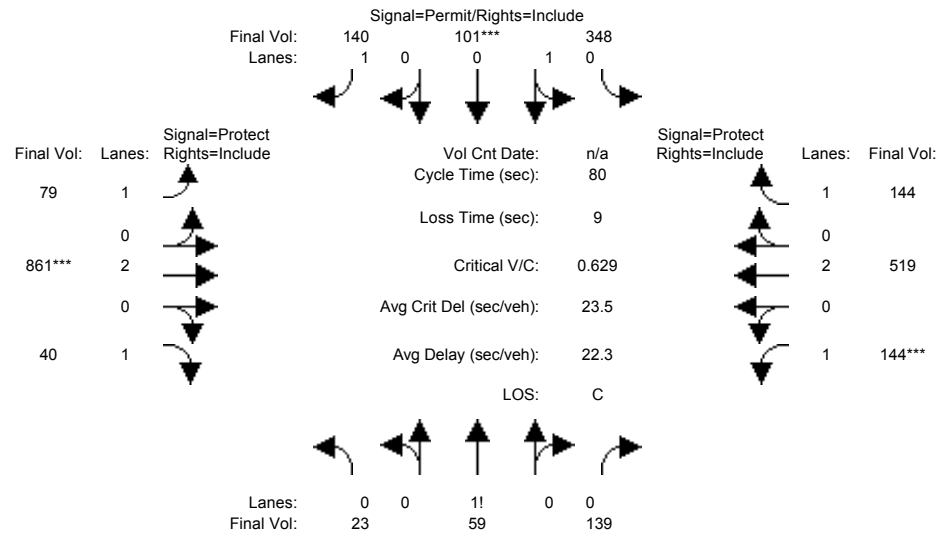

| Approach:                 | North Bound |      |      | South Bound |      |      | East Bound |      |      | West Bound |      |      |
|---------------------------|-------------|------|------|-------------|------|------|------------|------|------|------------|------|------|
| Movement:                 | L           | T    | R    | L           | T    | R    | L          | T    | R    | L          | T    | R    |
| Min. Green:               | 10          | 10   | 10   | 10          | 10   | 10   | 7          | 10   | 10   | 7          | 10   | 10   |
| Y+R:                      | 4.0         | 4.0  | 4.0  | 4.0         | 4.0  | 4.0  | 4.0        | 4.0  | 4.0  | 4.0        | 4.0  | 4.0  |
| Volume Module:            |             |      |      |             |      |      |            |      |      |            |      |      |
| Base Vol:                 | 23          | 59   | 139  | 348         | 101  | 140  | 79         | 861  | 40   | 144        | 519  | 144  |
| Growth Adj:               | 1.00        | 1.00 | 1.00 | 1.00        | 1.00 | 1.00 | 1.00       | 1.00 | 1.00 | 1.00       | 1.00 | 1.00 |
| Initial Bse:              | 23          | 59   | 139  | 348         | 101  | 140  | 79         | 861  | 40   | 144        | 519  | 144  |
| Added Vol:                | 0           | 0    | 0    | 0           | 0    | 0    | 0          | 0    | 0    | 0          | 0    | 0    |
| PasserByVol:              | 0           | 0    | 0    | 0           | 0    | 0    | 0          | 0    | 0    | 0          | 0    | 0    |
| Initial Fut:              | 23          | 59   | 139  | 348         | 101  | 140  | 79         | 861  | 40   | 144        | 519  | 144  |
| User Adj:                 | 1.00        | 1.00 | 1.00 | 1.00        | 1.00 | 1.00 | 1.00       | 1.00 | 1.00 | 1.00       | 1.00 | 1.00 |
| PHF Adj:                  | 1.00        | 1.00 | 1.00 | 1.00        | 1.00 | 1.00 | 1.00       | 1.00 | 1.00 | 1.00       | 1.00 | 1.00 |
| PHF Volume:               | 23          | 59   | 139  | 348         | 101  | 140  | 79         | 861  | 40   | 144        | 519  | 144  |
| Reduct Vol:               | 0           | 0    | 0    | 0           | 0    | 0    | 0          | 0    | 0    | 0          | 0    | 0    |
| Reduced Vol:              | 23          | 59   | 139  | 348         | 101  | 140  | 79         | 861  | 40   | 144        | 519  | 144  |
| PCE Adj:                  | 1.00        | 1.00 | 1.00 | 1.00        | 1.00 | 1.00 | 1.00       | 1.00 | 1.00 | 1.00       | 1.00 | 1.00 |
| MLF Adj:                  | 1.00        | 1.00 | 1.00 | 1.00        | 1.00 | 1.00 | 1.00       | 1.00 | 1.00 | 1.00       | 1.00 | 1.00 |
| Final Volume:             | 23          | 59   | 139  | 348         | 101  | 140  | 79         | 861  | 40   | 144        | 519  | 144  |
| Saturation Flow Module:   |             |      |      |             |      |      |            |      |      |            |      |      |
| Sat/Lane:                 | 1900        | 1900 | 1900 | 1900        | 1900 | 1900 | 1900       | 1900 | 1900 | 1900       | 1900 | 1900 |
| Adjustment:               | 0.92        | 0.92 | 0.92 | 0.95        | 0.95 | 0.92 | 0.92       | 1.00 | 0.92 | 0.92       | 1.00 | 0.92 |
| Lanes:                    | 0.10        | 0.27 | 0.63 | 0.78        | 0.22 | 1.00 | 1.00       | 2.00 | 1.00 | 1.00       | 2.00 | 1.00 |
| Final Sat.:               | 182         | 467  | 1101 | 1395        | 405  | 1750 | 1750       | 3800 | 1750 | 1750       | 3800 | 1750 |
| Capacity Analysis Module: |             |      |      |             |      |      |            |      |      |            |      |      |
| Vol/Sat:                  | 0.13        | 0.13 | 0.13 | 0.25        | 0.25 | 0.08 | 0.05       | 0.23 | 0.02 | 0.08       | 0.14 | 0.08 |
| Crit Moves:               |             |      |      | ****        |      |      | ****       |      |      | ****       |      |      |
| Green Time:               | 31.7        | 31.7 | 31.7 | 31.7        | 31.7 | 31.7 | 15.3       | 28.8 | 28.8 | 10.5       | 23.9 | 23.9 |
| Volume/Cap:               | 0.32        | 0.32 | 0.32 | 0.63        | 0.63 | 0.20 | 0.24       | 0.63 | 0.06 | 0.63       | 0.46 | 0.27 |
| Delay/Veh:                | 16.9        | 16.9 | 16.9 | 21.2        | 21.2 | 16.0 | 27.7       | 22.1 | 16.8 | 38.4       | 23.0 | 21.7 |
| User DelAdj:              | 1.00        | 1.00 | 1.00 | 1.00        | 1.00 | 1.00 | 1.00       | 1.00 | 1.00 | 1.00       | 1.00 | 1.00 |
| AdjDel/Veh:               | 16.9        | 16.9 | 16.9 | 21.2        | 21.2 | 16.0 | 27.7       | 22.1 | 16.8 | 38.4       | 23.0 | 21.7 |
| LOS by Move:              | B           | B    | B    | C           | C    | B    | C          | C    | B    | D          | C    | C    |
| HCM2k95thQ:               | 8           | 8    | 8    | 17          | 17   | 5    | 4          | 16   | 1    | 7          | 10   | 6    |

Note: Queue reported is the number of cars per lane.

BART

Level Of Service Computation Report  
 2000 HCM Operations (Future Volume Alternative)  
 AM - Bkgrd + Proj Conditions

Intersection #3789: SANTA CLARA/21ST [Study Int 10]

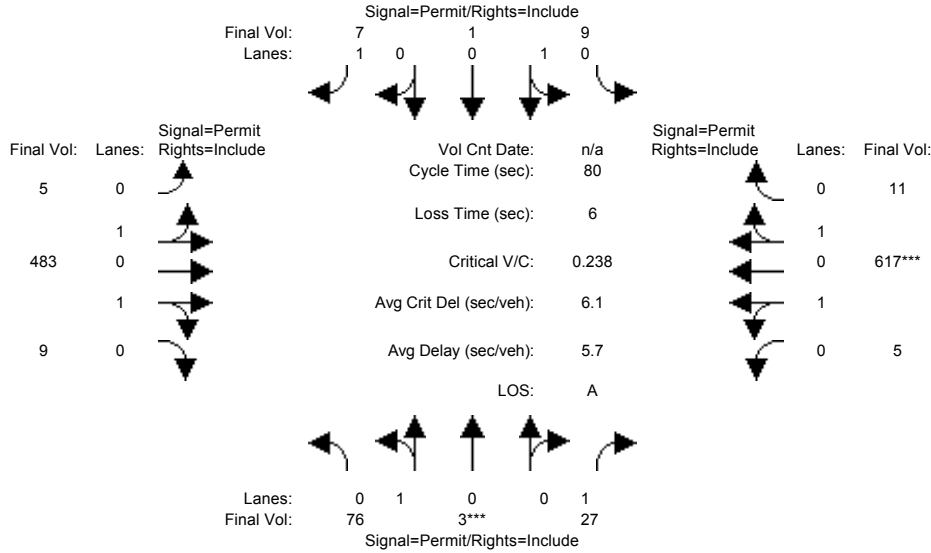

| Approach:                 | North Bound |      |      | South Bound |      |      | East Bound |      |      | West Bound |      |      |
|---------------------------|-------------|------|------|-------------|------|------|------------|------|------|------------|------|------|
| Movement:                 | L           | T    | R    | L           | T    | R    | L          | T    | R    | L          | T    | R    |
| Min. Green:               | 10          | 10   | 10   | 10          | 10   | 10   | 10         | 10   | 10   | 10         | 10   | 10   |
| Y+R:                      | 4.0         | 4.0  | 4.0  | 4.0         | 4.0  | 4.0  | 4.0        | 4.0  | 4.0  | 4.0        | 4.0  | 4.0  |
| Volume Module:            |             |      |      |             |      |      |            |      |      |            |      |      |
| Base Vol:                 | 76          | 3    | 27   | 9           | 1    | 7    | 5          | 483  | 9    | 5          | 617  | 11   |
| Growth Adj:               | 1.00        | 1.00 | 1.00 | 1.00        | 1.00 | 1.00 | 1.00       | 1.00 | 1.00 | 1.00       | 1.00 | 1.00 |
| Initial Bse:              | 76          | 3    | 27   | 9           | 1    | 7    | 5          | 483  | 9    | 5          | 617  | 11   |
| Added Vol:                | 0           | 0    | 0    | 0           | 0    | 0    | 0          | 0    | 0    | 0          | 0    | 0    |
| PasserByVol:              | 0           | 0    | 0    | 0           | 0    | 0    | 0          | 0    | 0    | 0          | 0    | 0    |
| Initial Fut:              | 76          | 3    | 27   | 9           | 1    | 7    | 5          | 483  | 9    | 5          | 617  | 11   |
| User Adj:                 | 1.00        | 1.00 | 1.00 | 1.00        | 1.00 | 1.00 | 1.00       | 1.00 | 1.00 | 1.00       | 1.00 | 1.00 |
| PHF Adj:                  | 1.00        | 1.00 | 1.00 | 1.00        | 1.00 | 1.00 | 1.00       | 1.00 | 1.00 | 1.00       | 1.00 | 1.00 |
| PHF Volume:               | 76          | 3    | 27   | 9           | 1    | 7    | 5          | 483  | 9    | 5          | 617  | 11   |
| Reduct Vol:               | 0           | 0    | 0    | 0           | 0    | 0    | 0          | 0    | 0    | 0          | 0    | 0    |
| Reduced Vol:              | 76          | 3    | 27   | 9           | 1    | 7    | 5          | 483  | 9    | 5          | 617  | 11   |
| PCE Adj:                  | 1.00        | 1.00 | 1.00 | 1.00        | 1.00 | 1.00 | 1.00       | 1.00 | 1.00 | 1.00       | 1.00 | 1.00 |
| MLF Adj:                  | 1.00        | 1.00 | 1.00 | 1.00        | 1.00 | 1.00 | 1.00       | 1.00 | 1.00 | 1.00       | 1.00 | 1.00 |
| FinalVolume:              | 76          | 3    | 27   | 9           | 1    | 7    | 5          | 483  | 9    | 5          | 617  | 11   |
| Saturation Flow Module:   |             |      |      |             |      |      |            |      |      |            |      |      |
| Sat/Lane:                 | 1900        | 1900 | 1900 | 1900        | 1900 | 1900 | 1900       | 1900 | 1900 | 1900       | 1900 | 1900 |
| Adjustment:               | 0.95        | 0.95 | 0.92 | 0.95        | 0.95 | 0.92 | 0.95       | 0.95 | 0.95 | 0.95       | 0.95 | 0.95 |
| Lanes:                    | 0.96        | 0.04 | 1.00 | 0.90        | 0.10 | 1.00 | 0.02       | 1.94 | 0.04 | 0.02       | 1.95 | 0.03 |
| Final Sat.:               | 1732        | 68   | 1750 | 1620        | 180  | 1750 | 36         | 3499 | 65   | 28         | 3509 | 63   |
| Capacity Analysis Module: |             |      |      |             |      |      |            |      |      |            |      |      |
| Vol/Sat:                  | 0.04        | 0.04 | 0.02 | 0.01        | 0.01 | 0.00 | 0.14       | 0.14 | 0.14 | 0.18       | 0.18 | 0.18 |
| Crit Moves:               | ****        |      |      | ****        |      |      | ****       |      |      | ****       |      |      |
| Green Time:               | 14.8        | 14.8 | 14.8 | 14.8        | 14.8 | 14.8 | 59.2       | 59.2 | 59.2 | 59.2       | 59.2 | 59.2 |
| Volume/Cap:               | 0.24        | 0.24 | 0.08 | 0.03        | 0.03 | 0.02 | 0.19       | 0.19 | 0.19 | 0.24       | 0.24 | 0.24 |
| Delay/Veh:                | 28.2        | 28.2 | 27.1 | 26.8        | 26.8 | 26.7 | 3.2        | 3.2  | 3.2  | 3.3        | 3.3  | 3.3  |
| User DelAdj:              | 1.00        | 1.00 | 1.00 | 1.00        | 1.00 | 1.00 | 1.00       | 1.00 | 1.00 | 1.00       | 1.00 | 1.00 |
| AdjDel/Veh:               | 28.2        | 28.2 | 27.1 | 26.8        | 26.8 | 26.7 | 3.2        | 3.2  | 3.2  | 3.3        | 3.3  | 3.3  |
| LOS by Move:              | C           | C    | C    | C           | C    | C    | A          | A    | A    | A          | A    | A    |
| HCM2k95thQ:               | 4           | 4    | 1    | 0           | 0    | 0    | 4          | 4    | 4    | 5          | 5    | 5    |

Note: Queue reported is the number of cars per lane.

BART

Level Of Service Computation Report  
 2000 HCM Operations (Future Volume Alternative)  
 PM - Bkgrd + Proj Conditions

Intersection #3789: SANTA CLARA/21ST [Study Int 10]

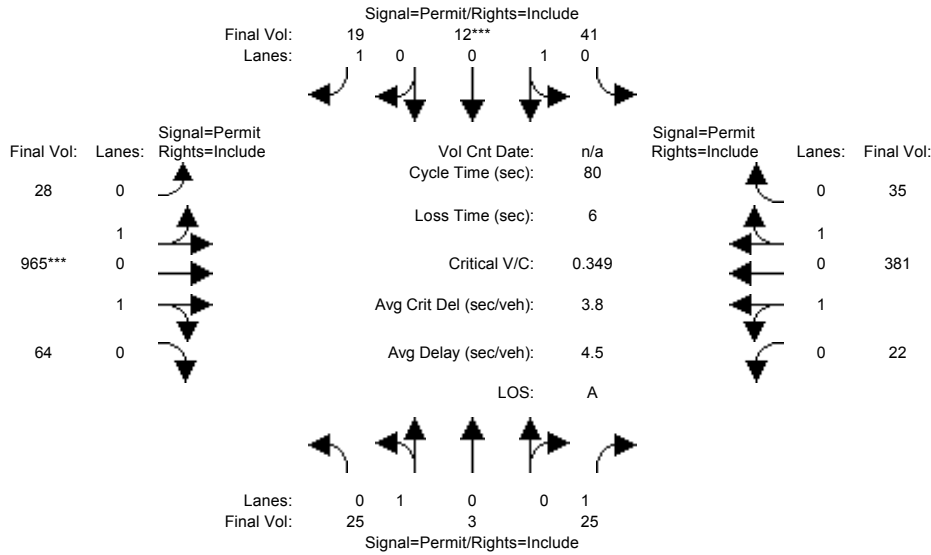

| Approach:                 | North Bound |      |      | South Bound |      |      | East Bound |      |      | West Bound |      |      |
|---------------------------|-------------|------|------|-------------|------|------|------------|------|------|------------|------|------|
| Movement:                 | L           | T    | R    | L           | T    | R    | L          | T    | R    | L          | T    | R    |
| Min. Green:               | 10          | 10   | 10   | 10          | 10   | 10   | 10         | 10   | 10   | 10         | 10   | 10   |
| Y+R:                      | 4.0         | 4.0  | 4.0  | 4.0         | 4.0  | 4.0  | 4.0        | 4.0  | 4.0  | 4.0        | 4.0  | 4.0  |
| Volume Module:            |             |      |      |             |      |      |            |      |      |            |      |      |
| Base Vol:                 | 25          | 3    | 25   | 41          | 12   | 19   | 28         | 965  | 64   | 22         | 381  | 35   |
| Growth Adj:               | 1.00        | 1.00 | 1.00 | 1.00        | 1.00 | 1.00 | 1.00       | 1.00 | 1.00 | 1.00       | 1.00 | 1.00 |
| Initial Bse:              | 25          | 3    | 25   | 41          | 12   | 19   | 28         | 965  | 64   | 22         | 381  | 35   |
| Added Vol:                | 0           | 0    | 0    | 0           | 0    | 0    | 0          | 0    | 0    | 0          | 0    | 0    |
| PasserByVol:              | 0           | 0    | 0    | 0           | 0    | 0    | 0          | 0    | 0    | 0          | 0    | 0    |
| Initial Fut:              | 25          | 3    | 25   | 41          | 12   | 19   | 28         | 965  | 64   | 22         | 381  | 35   |
| User Adj:                 | 1.00        | 1.00 | 1.00 | 1.00        | 1.00 | 1.00 | 1.00       | 1.00 | 1.00 | 1.00       | 1.00 | 1.00 |
| PHF Adj:                  | 1.00        | 1.00 | 1.00 | 1.00        | 1.00 | 1.00 | 1.00       | 1.00 | 1.00 | 1.00       | 1.00 | 1.00 |
| PHF Volume:               | 25          | 3    | 25   | 41          | 12   | 19   | 28         | 965  | 64   | 22         | 381  | 35   |
| Reduct Vol:               | 0           | 0    | 0    | 0           | 0    | 0    | 0          | 0    | 0    | 0          | 0    | 0    |
| Reduced Vol:              | 25          | 3    | 25   | 41          | 12   | 19   | 28         | 965  | 64   | 22         | 381  | 35   |
| PCE Adj:                  | 1.00        | 1.00 | 1.00 | 1.00        | 1.00 | 1.00 | 1.00       | 1.00 | 1.00 | 1.00       | 1.00 | 1.00 |
| MLF Adj:                  | 1.00        | 1.00 | 1.00 | 1.00        | 1.00 | 1.00 | 1.00       | 1.00 | 1.00 | 1.00       | 1.00 | 1.00 |
| Final Volume:             | 25          | 3    | 25   | 41          | 12   | 19   | 28         | 965  | 64   | 22         | 381  | 35   |
| Saturation Flow Module:   |             |      |      |             |      |      |            |      |      |            |      |      |
| Sat/Lane:                 | 1900        | 1900 | 1900 | 1900        | 1900 | 1900 | 1900       | 1900 | 1900 | 1900       | 1900 | 1900 |
| Adjustment:               | 0.95        | 0.95 | 0.92 | 0.95        | 0.95 | 0.92 | 0.95       | 0.95 | 0.95 | 0.95       | 0.95 | 0.95 |
| Lanes:                    | 0.89        | 0.11 | 1.00 | 0.77        | 0.23 | 1.00 | 0.05       | 1.83 | 0.12 | 0.10       | 1.74 | 0.16 |
| Final Sat.:               | 1607        | 193  | 1750 | 1392        | 408  | 1750 | 95         | 3287 | 218  | 181        | 3132 | 288  |
| Capacity Analysis Module: |             |      |      |             |      |      |            |      |      |            |      |      |
| Vol/Sat:                  | 0.02        | 0.02 | 0.01 | 0.03        | 0.03 | 0.01 | 0.29       | 0.29 | 0.29 | 0.12       | 0.12 | 0.12 |
| Crit Moves:               |             |      |      | ****        |      |      | ****       |      |      |            |      |      |
| Green Time:               | 10.0        | 10.0 | 10.0 | 10.0        | 10.0 | 10.0 | 64.0       | 64.0 | 64.0 | 64.0       | 64.0 | 64.0 |
| Volume/Cap:               | 0.12        | 0.12 | 0.11 | 0.24        | 0.24 | 0.09 | 0.37       | 0.37 | 0.37 | 0.15       | 0.15 | 0.15 |
| Delay/Veh:                | 31.4        | 31.4 | 31.3 | 32.1        | 32.1 | 31.1 | 2.3        | 2.3  | 2.3  | 1.8        | 1.8  | 1.8  |
| User DelAdj:              | 1.00        | 1.00 | 1.00 | 1.00        | 1.00 | 1.00 | 1.00       | 1.00 | 1.00 | 1.00       | 1.00 | 1.00 |
| AdjDel/Veh:               | 31.4        | 31.4 | 31.3 | 32.1        | 32.1 | 31.1 | 2.3        | 2.3  | 2.3  | 1.8        | 1.8  | 1.8  |
| LOS by Move:              | C           | C    | C    | C           | C    | C    | A          | A    | A    | A          | A    | A    |
| HCM2k95thQ:               | 2           | 2    | 1    | 3           | 3    | 1    | 8          | 8    | 8    | 3          | 3    | 3    |

Note: Queue reported is the number of cars per lane.

BART

Level Of Service Computation Report  
 2000 HCM Operations (Future Volume Alternative)  
 AM - Bkgrd + Proj Conditions

Intersection #3790: SANTA CLARA/24TH [Study Int 11]

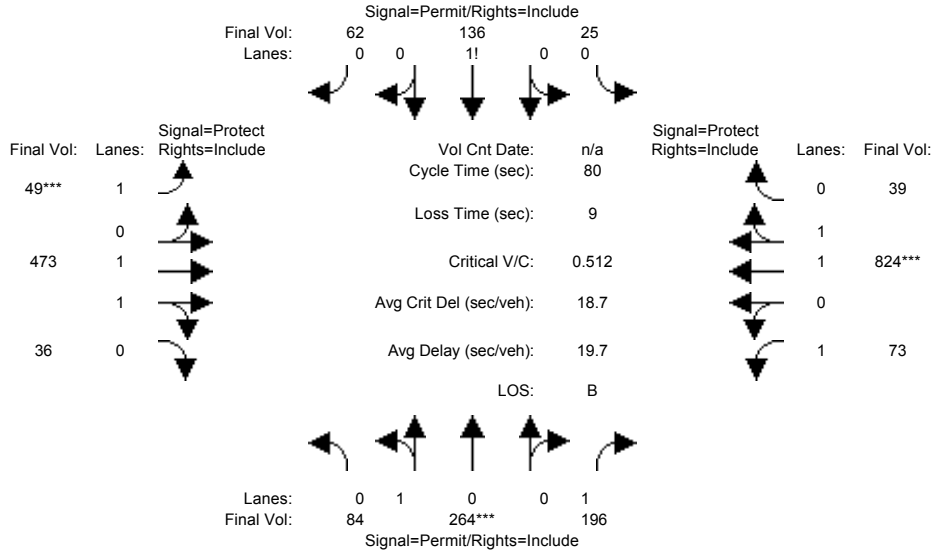

| Approach:                 | North Bound |      |      | South Bound |      |      | East Bound |      |      | West Bound |      |      |
|---------------------------|-------------|------|------|-------------|------|------|------------|------|------|------------|------|------|
| Movement:                 | L           | T    | R    | L           | T    | R    | L          | T    | R    | L          | T    | R    |
| Min. Green:               | 10          | 10   | 10   | 10          | 10   | 10   | 7          | 10   | 10   | 7          | 10   | 10   |
| Y+R:                      | 4.0         | 4.0  | 4.0  | 4.0         | 4.0  | 4.0  | 4.0        | 4.0  | 4.0  | 4.0        | 4.0  | 4.0  |
| Volume Module:            |             |      |      |             |      |      |            |      |      |            |      |      |
| Base Vol:                 | 84          | 264  | 196  | 25          | 136  | 62   | 49         | 473  | 36   | 73         | 824  | 39   |
| Growth Adj:               | 1.00        | 1.00 | 1.00 | 1.00        | 1.00 | 1.00 | 1.00       | 1.00 | 1.00 | 1.00       | 1.00 | 1.00 |
| Initial Bse:              | 84          | 264  | 196  | 25          | 136  | 62   | 49         | 473  | 36   | 73         | 824  | 39   |
| Added Vol:                | 0           | 0    | 0    | 0           | 0    | 0    | 0          | 0    | 0    | 0          | 0    | 0    |
| PasserByVol:              | 0           | 0    | 0    | 0           | 0    | 0    | 0          | 0    | 0    | 0          | 0    | 0    |
| Initial Fut:              | 84          | 264  | 196  | 25          | 136  | 62   | 49         | 473  | 36   | 73         | 824  | 39   |
| User Adj:                 | 1.00        | 1.00 | 1.00 | 1.00        | 1.00 | 1.00 | 1.00       | 1.00 | 1.00 | 1.00       | 1.00 | 1.00 |
| PHF Adj:                  | 1.00        | 1.00 | 1.00 | 1.00        | 1.00 | 1.00 | 1.00       | 1.00 | 1.00 | 1.00       | 1.00 | 1.00 |
| PHF Volume:               | 84          | 264  | 196  | 25          | 136  | 62   | 49         | 473  | 36   | 73         | 824  | 39   |
| Reduct Vol:               | 0           | 0    | 0    | 0           | 0    | 0    | 0          | 0    | 0    | 0          | 0    | 0    |
| Reduced Vol:              | 84          | 264  | 196  | 25          | 136  | 62   | 49         | 473  | 36   | 73         | 824  | 39   |
| PCE Adj:                  | 1.00        | 1.00 | 1.00 | 1.00        | 1.00 | 1.00 | 1.00       | 1.00 | 1.00 | 1.00       | 1.00 | 1.00 |
| MLF Adj:                  | 1.00        | 1.00 | 1.00 | 1.00        | 1.00 | 1.00 | 1.00       | 1.00 | 1.00 | 1.00       | 1.00 | 1.00 |
| Final Volume:             | 84          | 264  | 196  | 25          | 136  | 62   | 49         | 473  | 36   | 73         | 824  | 39   |
| Saturation Flow Module:   |             |      |      |             |      |      |            |      |      |            |      |      |
| Sat/Lane:                 | 1900        | 1900 | 1900 | 1900        | 1900 | 1900 | 1900       | 1900 | 1900 | 1900       | 1900 | 1900 |
| Adjustment:               | 0.95        | 0.95 | 0.92 | 0.92        | 0.92 | 0.92 | 0.92       | 0.98 | 0.95 | 0.92       | 0.97 | 0.95 |
| Lanes:                    | 0.24        | 0.76 | 1.00 | 0.11        | 0.61 | 0.28 | 1.00       | 1.85 | 0.15 | 1.00       | 1.91 | 0.09 |
| Final Sat.:               | 434         | 1366 | 1750 | 196         | 1067 | 487  | 1750       | 3438 | 262  | 1750       | 3533 | 167  |
| Capacity Analysis Module: |             |      |      |             |      |      |            |      |      |            |      |      |
| Vol/Sat:                  | 0.19        | 0.19 | 0.11 | 0.13        | 0.13 | 0.13 | 0.03       | 0.14 | 0.14 | 0.04       | 0.23 | 0.23 |
| Crit Moves:               | ****        |      |      | ****        |      |      | ****       |      |      | ****       |      |      |
| Green Time:               | 29.0        | 29.0 | 29.0 | 29.0        | 29.0 | 29.0 | 7.0        | 25.7 | 25.7 | 16.3       | 35.0 | 35.0 |
| Volume/Cap:               | 0.53        | 0.53 | 0.31 | 0.35        | 0.35 | 0.35 | 0.32       | 0.43 | 0.43 | 0.20       | 0.53 | 0.53 |
| Delay/Veh:                | 21.0        | 21.0 | 18.6 | 19.0        | 19.0 | 19.0 | 35.5       | 21.6 | 21.6 | 26.7       | 16.9 | 16.9 |
| User DelAdj:              | 1.00        | 1.00 | 1.00 | 1.00        | 1.00 | 1.00 | 1.00       | 1.00 | 1.00 | 1.00       | 1.00 | 1.00 |
| AdjDel/Veh:               | 21.0        | 21.0 | 18.6 | 19.0        | 19.0 | 19.0 | 35.5       | 21.6 | 21.6 | 26.7       | 16.9 | 16.9 |
| LOS by Move:              | C           | C    | B    | B           | B    | B    | D          | C    | C    | C          | B    | B    |
| HCM2k95thQ:               | 13          | 13   | 7    | 9           | 9    | 9    | 2          | 10   | 10   | 3          | 15   | 15   |

Note: Queue reported is the number of cars per lane.

BART

Level Of Service Computation Report  
 2000 HCM Operations (Future Volume Alternative)  
 PM - Bkgrd + Proj Conditions

Intersection #3790: SANTA CLARA/24TH [Study Int 11]

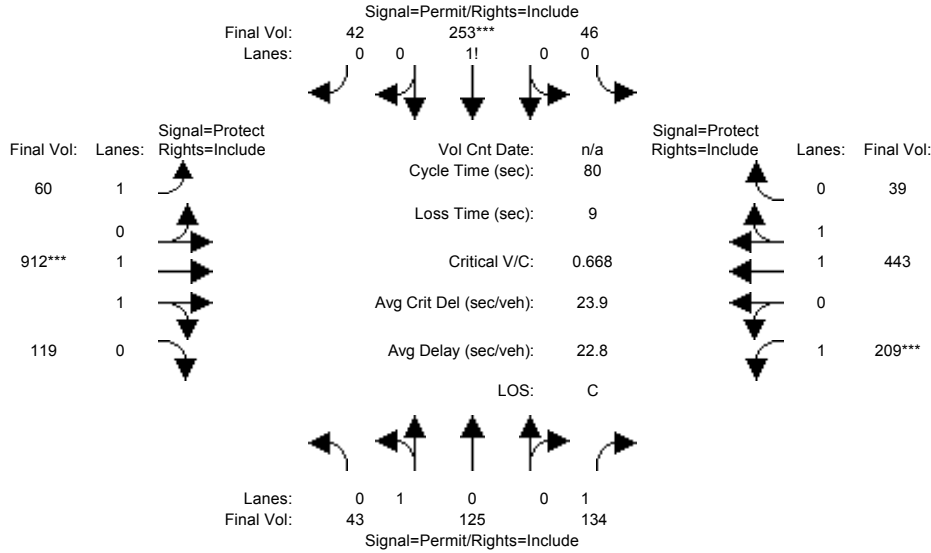

| Approach:                 | North Bound |      |      | South Bound |      |      | East Bound |      |      | West Bound |      |      |
|---------------------------|-------------|------|------|-------------|------|------|------------|------|------|------------|------|------|
| Movement:                 | L           | T    | R    | L           | T    | R    | L          | T    | R    | L          | T    | R    |
| Min. Green:               | 10          | 10   | 10   | 10          | 10   | 10   | 7          | 10   | 10   | 7          | 10   | 10   |
| Y+R:                      | 4.0         | 4.0  | 4.0  | 4.0         | 4.0  | 4.0  | 4.0        | 4.0  | 4.0  | 4.0        | 4.0  | 4.0  |
| Volume Module:            |             |      |      |             |      |      |            |      |      |            |      |      |
| Base Vol:                 | 43          | 125  | 134  | 46          | 253  | 42   | 60         | 912  | 119  | 209        | 443  | 39   |
| Growth Adj:               | 1.00        | 1.00 | 1.00 | 1.00        | 1.00 | 1.00 | 1.00       | 1.00 | 1.00 | 1.00       | 1.00 | 1.00 |
| Initial Bse:              | 43          | 125  | 134  | 46          | 253  | 42   | 60         | 912  | 119  | 209        | 443  | 39   |
| Added Vol:                | 0           | 0    | 0    | 0           | 0    | 0    | 0          | 0    | 0    | 0          | 0    | 0    |
| PasserByVol:              | 0           | 0    | 0    | 0           | 0    | 0    | 0          | 0    | 0    | 0          | 0    | 0    |
| Initial Fut:              | 43          | 125  | 134  | 46          | 253  | 42   | 60         | 912  | 119  | 209        | 443  | 39   |
| User Adj:                 | 1.00        | 1.00 | 1.00 | 1.00        | 1.00 | 1.00 | 1.00       | 1.00 | 1.00 | 1.00       | 1.00 | 1.00 |
| PHF Adj:                  | 1.00        | 1.00 | 1.00 | 1.00        | 1.00 | 1.00 | 1.00       | 1.00 | 1.00 | 1.00       | 1.00 | 1.00 |
| PHF Volume:               | 43          | 125  | 134  | 46          | 253  | 42   | 60         | 912  | 119  | 209        | 443  | 39   |
| Reduct Vol:               | 0           | 0    | 0    | 0           | 0    | 0    | 0          | 0    | 0    | 0          | 0    | 0    |
| Reduced Vol:              | 43          | 125  | 134  | 46          | 253  | 42   | 60         | 912  | 119  | 209        | 443  | 39   |
| PCE Adj:                  | 1.00        | 1.00 | 1.00 | 1.00        | 1.00 | 1.00 | 1.00       | 1.00 | 1.00 | 1.00       | 1.00 | 1.00 |
| MLF Adj:                  | 1.00        | 1.00 | 1.00 | 1.00        | 1.00 | 1.00 | 1.00       | 1.00 | 1.00 | 1.00       | 1.00 | 1.00 |
| Final Volume:             | 43          | 125  | 134  | 46          | 253  | 42   | 60         | 912  | 119  | 209        | 443  | 39   |
| Saturation Flow Module:   |             |      |      |             |      |      |            |      |      |            |      |      |
| Sat/Lane:                 | 1900        | 1900 | 1900 | 1900        | 1900 | 1900 | 1900       | 1900 | 1900 | 1900       | 1900 | 1900 |
| Adjustment:               | 0.95        | 0.95 | 0.92 | 0.92        | 0.92 | 0.92 | 0.92       | 0.98 | 0.95 | 0.92       | 0.98 | 0.95 |
| Lanes:                    | 0.26        | 0.74 | 1.00 | 0.13        | 0.75 | 0.12 | 1.00       | 1.76 | 0.24 | 1.00       | 1.83 | 0.17 |
| Final Sat.:               | 461         | 1339 | 1750 | 236         | 1298 | 216  | 1750       | 3273 | 427  | 1750       | 3400 | 299  |
| Capacity Analysis Module: |             |      |      |             |      |      |            |      |      |            |      |      |
| Vol/Sat:                  | 0.09        | 0.09 | 0.08 | 0.19        | 0.19 | 0.19 | 0.03       | 0.28 | 0.28 | 0.12       | 0.13 | 0.13 |
| Crit Moves:               |             |      |      | ****        |      |      | ****       |      |      | ****       |      |      |
| Green Time:               | 23.3        | 23.3 | 23.3 | 23.3        | 23.3 | 23.3 | 19.2       | 33.4 | 33.4 | 14.3       | 28.5 | 28.5 |
| Volume/Cap:               | 0.32        | 0.32 | 0.26 | 0.67        | 0.67 | 0.67 | 0.14       | 0.67 | 0.67 | 0.67       | 0.37 | 0.37 |
| Delay/Veh:                | 22.5        | 22.5 | 22.0 | 28.3        | 28.3 | 28.3 | 24.1       | 20.0 | 20.0 | 36.1       | 19.2 | 19.2 |
| User DelAdj:              | 1.00        | 1.00 | 1.00 | 1.00        | 1.00 | 1.00 | 1.00       | 1.00 | 1.00 | 1.00       | 1.00 | 1.00 |
| AdjDel/Veh:               | 22.5        | 22.5 | 22.0 | 28.3        | 28.3 | 28.3 | 24.1       | 20.0 | 20.0 | 36.1       | 19.2 | 19.2 |
| LOS by Move:              | C           | C    | C    | C           | C    | C    | C          | B    | B    | D          | B    | B    |
| HCM2k95thQ:               | 7           | 7    | 5    | 17          | 17   | 17   | 2          | 19   | 19   | 10         | 9    | 9    |

Note: Queue reported is the number of cars per lane.

BART

Level Of Service Computation Report  
 2000 HCM Operations (Future Volume Alternative)  
 AM - Bkgrd + Proj Conditions

Intersection #3832: 24TH/WILLIAM [Study Int 24]

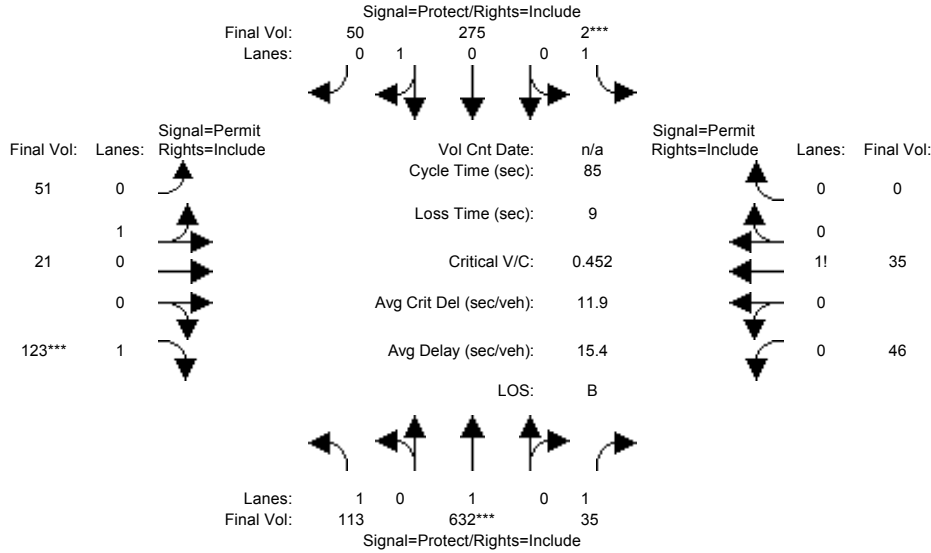

| Approach:                 | North Bound |      |      | South Bound |      |      | East Bound |      |      | West Bound |      |      |
|---------------------------|-------------|------|------|-------------|------|------|------------|------|------|------------|------|------|
| Movement:                 | L           | T    | R    | L           | T    | R    | L          | T    | R    | L          | T    | R    |
| Min. Green:               | 7           | 10   | 10   | 7           | 10   | 10   | 10         | 10   | 10   | 10         | 10   | 10   |
| Y+R:                      | 4.0         | 4.0  | 4.0  | 4.0         | 4.0  | 4.0  | 4.0        | 4.0  | 4.0  | 4.0        | 4.0  | 4.0  |
| Volume Module:            |             |      |      |             |      |      |            |      |      |            |      |      |
| Base Vol:                 | 113         | 632  | 35   | 2           | 275  | 50   | 51         | 21   | 123  | 46         | 35   | 0    |
| Growth Adj:               | 1.00        | 1.00 | 1.00 | 1.00        | 1.00 | 1.00 | 1.00       | 1.00 | 1.00 | 1.00       | 1.00 | 1.00 |
| Initial Bse:              | 113         | 632  | 35   | 2           | 275  | 50   | 51         | 21   | 123  | 46         | 35   | 0    |
| Added Vol:                | 0           | 0    | 0    | 0           | 0    | 0    | 0          | 0    | 0    | 0          | 0    | 0    |
| PasserByVol:              | 0           | 0    | 0    | 0           | 0    | 0    | 0          | 0    | 0    | 0          | 0    | 0    |
| Initial Fut:              | 113         | 632  | 35   | 2           | 275  | 50   | 51         | 21   | 123  | 46         | 35   | 0    |
| User Adj:                 | 1.00        | 1.00 | 1.00 | 1.00        | 1.00 | 1.00 | 1.00       | 1.00 | 1.00 | 1.00       | 1.00 | 1.00 |
| PHF Adj:                  | 1.00        | 1.00 | 1.00 | 1.00        | 1.00 | 1.00 | 1.00       | 1.00 | 1.00 | 1.00       | 1.00 | 1.00 |
| PHF Volume:               | 113         | 632  | 35   | 2           | 275  | 50   | 51         | 21   | 123  | 46         | 35   | 0    |
| Reduct Vol:               | 0           | 0    | 0    | 0           | 0    | 0    | 0          | 0    | 0    | 0          | 0    | 0    |
| Reduced Vol:              | 113         | 632  | 35   | 2           | 275  | 50   | 51         | 21   | 123  | 46         | 35   | 0    |
| PCE Adj:                  | 1.00        | 1.00 | 1.00 | 1.00        | 1.00 | 1.00 | 1.00       | 1.00 | 1.00 | 1.00       | 1.00 | 1.00 |
| MLF Adj:                  | 1.00        | 1.00 | 1.00 | 1.00        | 1.00 | 1.00 | 1.00       | 1.00 | 1.00 | 1.00       | 1.00 | 1.00 |
| Final Volume:             | 113         | 632  | 35   | 2           | 275  | 50   | 51         | 21   | 123  | 46         | 35   | 0    |
| Saturation Flow Module:   |             |      |      |             |      |      |            |      |      |            |      |      |
| Sat/Lane:                 | 1900        | 1900 | 1900 | 1900        | 1900 | 1900 | 1900       | 1900 | 1900 | 1900       | 1900 | 1900 |
| Adjustment:               | 0.92        | 1.00 | 0.92 | 0.92        | 0.95 | 0.95 | 0.95       | 0.95 | 0.92 | 0.95       | 0.95 | 0.92 |
| Lanes:                    | 1.00        | 1.00 | 1.00 | 1.00        | 0.85 | 0.15 | 0.71       | 0.29 | 1.00 | 0.57       | 0.43 | 0.00 |
| Final Sat.:               | 1750        | 1900 | 1750 | 1750        | 1523 | 277  | 1275       | 525  | 1750 | 1022       | 778  | 0    |
| Capacity Analysis Module: |             |      |      |             |      |      |            |      |      |            |      |      |
| Vol/Sat:                  | 0.06        | 0.33 | 0.02 | 0.00        | 0.18 | 0.18 | 0.04       | 0.04 | 0.07 | 0.05       | 0.05 | 0.00 |
| Crit Moves:               | ****        | **** | **** | ****        | **** | **** | ****       | **** | **** | ****       | **** | **** |
| Green Time:               | 20.0        | 57.0 | 57.0 | 7.0         | 43.9 | 43.9 | 12.0       | 12.0 | 12.0 | 12.0       | 12.0 | 0.0  |
| Volume/Cap:               | 0.27        | 0.50 | 0.03 | 0.01        | 0.35 | 0.35 | 0.28       | 0.28 | 0.50 | 0.32       | 0.32 | 0.00 |
| Delay/Veh:                | 26.9        | 7.2  | 4.7  | 35.9        | 12.3 | 12.3 | 33.2       | 33.2 | 35.2 | 33.5       | 33.5 | 0.0  |
| User DelAdj:              | 1.00        | 1.00 | 1.00 | 1.00        | 1.00 | 1.00 | 1.00       | 1.00 | 1.00 | 1.00       | 1.00 | 1.00 |
| AdjDel/Veh:               | 26.9        | 7.2  | 4.7  | 35.9        | 12.3 | 12.3 | 33.2       | 33.2 | 35.2 | 33.5       | 33.5 | 0.0  |
| LOS by Move:              | C           | A    | A    | D           | B    | B    | C          | C    | D    | C          | C    | A    |
| HCM2k95thQ:               | 5           | 15   | 1    | 0           | 10   | 10   | 4          | 4    | 8    | 5          | 5    | 0    |

Note: Queue reported is the number of cars per lane.

BART

Level Of Service Computation Report  
 2000 HCM Operations (Future Volume Alternative)  
 PM - Bkgrd + Proj Conditions

Intersection #3832: 24TH/WILLIAM [Study Int 24]

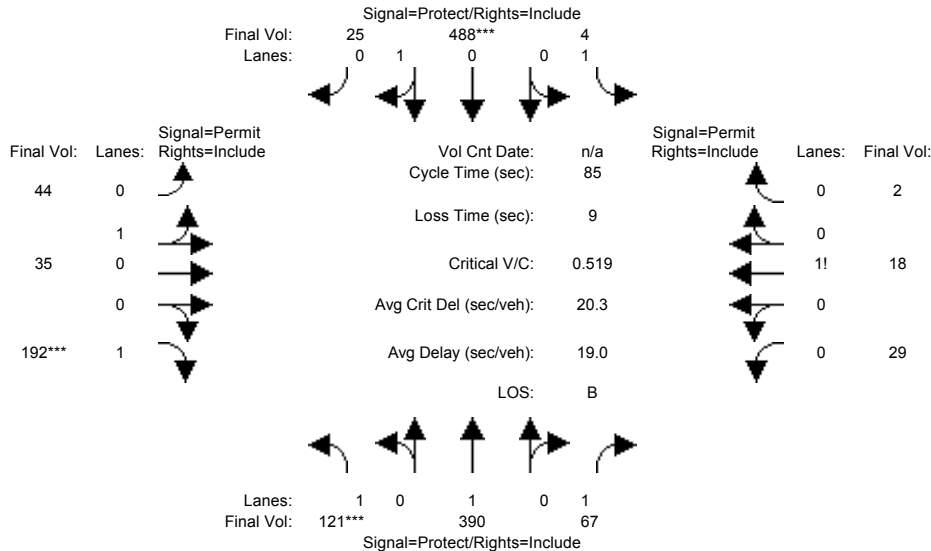

| Approach:                 | North Bound |      |      | South Bound |      |      | East Bound |      |      | West Bound |      |      |
|---------------------------|-------------|------|------|-------------|------|------|------------|------|------|------------|------|------|
| Movement:                 | L           | T    | R    | L           | T    | R    | L          | T    | R    | L          | T    | R    |
| Min. Green:               | 7           | 10   | 10   | 7           | 10   | 10   | 10         | 10   | 10   | 10         | 10   | 10   |
| Y+R:                      | 4.0         | 4.0  | 4.0  | 4.0         | 4.0  | 4.0  | 4.0        | 4.0  | 4.0  | 4.0        | 4.0  | 4.0  |
| Volume Module:            |             |      |      |             |      |      |            |      |      |            |      |      |
| Base Vol:                 | 121         | 390  | 67   | 4           | 488  | 25   | 44         | 35   | 192  | 29         | 18   | 2    |
| Growth Adj:               | 1.00        | 1.00 | 1.00 | 1.00        | 1.00 | 1.00 | 1.00       | 1.00 | 1.00 | 1.00       | 1.00 | 1.00 |
| Initial Bse:              | 121         | 390  | 67   | 4           | 488  | 25   | 44         | 35   | 192  | 29         | 18   | 2    |
| Added Vol:                | 0           | 0    | 0    | 0           | 0    | 0    | 0          | 0    | 0    | 0          | 0    | 0    |
| PasserByVol:              | 0           | 0    | 0    | 0           | 0    | 0    | 0          | 0    | 0    | 0          | 0    | 0    |
| Initial Fut:              | 121         | 390  | 67   | 4           | 488  | 25   | 44         | 35   | 192  | 29         | 18   | 2    |
| User Adj:                 | 1.00        | 1.00 | 1.00 | 1.00        | 1.00 | 1.00 | 1.00       | 1.00 | 1.00 | 1.00       | 1.00 | 1.00 |
| PHF Adj:                  | 1.00        | 1.00 | 1.00 | 1.00        | 1.00 | 1.00 | 1.00       | 1.00 | 1.00 | 1.00       | 1.00 | 1.00 |
| PHF Volume:               | 121         | 390  | 67   | 4           | 488  | 25   | 44         | 35   | 192  | 29         | 18   | 2    |
| Reduct Vol:               | 0           | 0    | 0    | 0           | 0    | 0    | 0          | 0    | 0    | 0          | 0    | 0    |
| Reduced Vol:              | 121         | 390  | 67   | 4           | 488  | 25   | 44         | 35   | 192  | 29         | 18   | 2    |
| PCE Adj:                  | 1.00        | 1.00 | 1.00 | 1.00        | 1.00 | 1.00 | 1.00       | 1.00 | 1.00 | 1.00       | 1.00 | 1.00 |
| MLF Adj:                  | 1.00        | 1.00 | 1.00 | 1.00        | 1.00 | 1.00 | 1.00       | 1.00 | 1.00 | 1.00       | 1.00 | 1.00 |
| Final Volume:             | 121         | 390  | 67   | 4           | 488  | 25   | 44         | 35   | 192  | 29         | 18   | 2    |
| Saturation Flow Module:   |             |      |      |             |      |      |            |      |      |            |      |      |
| Sat/Lane:                 | 1900        | 1900 | 1900 | 1900        | 1900 | 1900 | 1900       | 1900 | 1900 | 1900       | 1900 | 1900 |
| Adjustment:               | 0.92        | 1.00 | 0.92 | 0.92        | 0.95 | 0.95 | 0.95       | 0.95 | 0.92 | 0.92       | 0.92 | 0.92 |
| Lanes:                    | 1.00        | 1.00 | 1.00 | 1.00        | 0.95 | 0.05 | 0.56       | 0.44 | 1.00 | 0.59       | 0.37 | 0.04 |
| Final Sat.:               | 1750        | 1900 | 1750 | 1750        | 1712 | 88   | 1003       | 797  | 1750 | 1036       | 643  | 71   |
| Capacity Analysis Module: |             |      |      |             |      |      |            |      |      |            |      |      |
| Vol/Sat:                  | 0.07        | 0.21 | 0.04 | 0.00        | 0.29 | 0.29 | 0.04       | 0.04 | 0.11 | 0.03       | 0.03 | 0.03 |
| Crit Moves:               | ****        |      |      | ****        |      |      |            |      | **** |            |      |      |
| Green Time:               | 11.3        | 41.4 | 41.4 | 16.6        | 46.7 | 46.7 | 18.0       | 18.0 | 18.0 | 18.0       | 18.0 | 18.0 |
| Volume/Cap:               | 0.52        | 0.42 | 0.08 | 0.01        | 0.52 | 0.52 | 0.21       | 0.21 | 0.52 | 0.13       | 0.13 | 0.13 |
| Delay/Veh:                | 36.4        | 14.4 | 11.7 | 27.6        | 12.6 | 12.6 | 27.9       | 27.9 | 31.0 | 27.3       | 27.3 | 27.3 |
| User DelAdj:              | 1.00        | 1.00 | 1.00 | 1.00        | 1.00 | 1.00 | 1.00       | 1.00 | 1.00 | 1.00       | 1.00 | 1.00 |
| AdjDel/Veh:               | 36.4        | 14.4 | 11.7 | 27.6        | 12.6 | 12.6 | 27.9       | 27.9 | 31.0 | 27.3       | 27.3 | 27.3 |
| LOS by Move:              | D           | B    | B    | C           | B    | B    | C          | C    | C    | C          | C    | C    |
| HCM2k95thQ:               | 6           | 12   | 2    | 0           | 16   | 16   | 4          | 4    | 10   | 2          | 2    | 2    |

Note: Queue reported is the number of cars per lane.

BART

Level Of Service Computation Report  
 2000 HCM Operations (Future Volume Alternative)  
 AM - Bkgrd + Proj Conditions

Intersection #4005: JULIAN/28TH [Study Int 3]

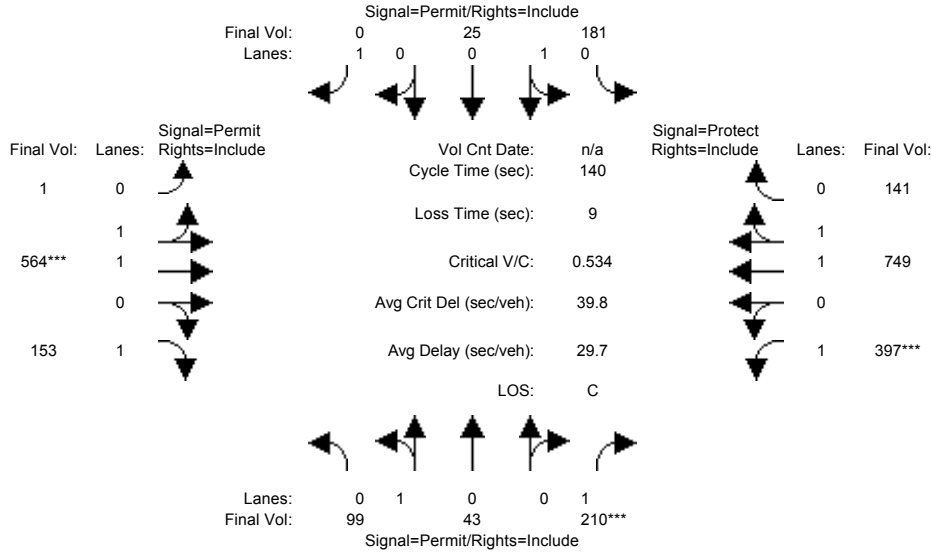

| Approach:                 | North Bound |      |      | South Bound |      |      | East Bound |      |      | West Bound |      |      |
|---------------------------|-------------|------|------|-------------|------|------|------------|------|------|------------|------|------|
| Movement:                 | L           | T    | R    | L           | T    | R    | L          | T    | R    | L          | T    | R    |
| Min. Green:               | 10          | 10   | 10   | 10          | 10   | 10   | 10         | 10   | 10   | 7          | 10   | 10   |
| Y+R:                      | 4.0         | 4.0  | 4.0  | 4.0         | 4.0  | 4.0  | 4.0        | 4.0  | 4.0  | 4.0        | 4.0  | 4.0  |
| Volume Module:            |             |      |      |             |      |      |            |      |      |            |      |      |
| Base Vol:                 | 99          | 43   | 210  | 181         | 25   | 0    | 1          | 564  | 153  | 397        | 749  | 141  |
| Growth Adj:               | 1.00        | 1.00 | 1.00 | 1.00        | 1.00 | 1.00 | 1.00       | 1.00 | 1.00 | 1.00       | 1.00 | 1.00 |
| Initial Bse:              | 99          | 43   | 210  | 181         | 25   | 0    | 1          | 564  | 153  | 397        | 749  | 141  |
| Added Vol:                | 0           | 0    | 0    | 0           | 0    | 0    | 0          | 0    | 0    | 0          | 0    | 0    |
| PasserByVol:              | 0           | 0    | 0    | 0           | 0    | 0    | 0          | 0    | 0    | 0          | 0    | 0    |
| Initial Fut:              | 99          | 43   | 210  | 181         | 25   | 0    | 1          | 564  | 153  | 397        | 749  | 141  |
| User Adj:                 | 1.00        | 1.00 | 1.00 | 1.00        | 1.00 | 1.00 | 1.00       | 1.00 | 1.00 | 1.00       | 1.00 | 1.00 |
| PHF Adj:                  | 1.00        | 1.00 | 1.00 | 1.00        | 1.00 | 1.00 | 1.00       | 1.00 | 1.00 | 1.00       | 1.00 | 1.00 |
| PHF Volume:               | 99          | 43   | 210  | 181         | 25   | 0    | 1          | 564  | 153  | 397        | 749  | 141  |
| Reduct Vol:               | 0           | 0    | 0    | 0           | 0    | 0    | 0          | 0    | 0    | 0          | 0    | 0    |
| Reduced Vol:              | 99          | 43   | 210  | 181         | 25   | 0    | 1          | 564  | 153  | 397        | 749  | 141  |
| PCE Adj:                  | 1.00        | 1.00 | 1.00 | 1.00        | 1.00 | 1.00 | 1.00       | 1.00 | 1.00 | 1.00       | 1.00 | 1.00 |
| MLF Adj:                  | 1.00        | 1.00 | 1.00 | 1.00        | 1.00 | 1.00 | 1.00       | 1.00 | 1.00 | 1.00       | 1.00 | 1.00 |
| FinalVolume:              | 99          | 43   | 210  | 181         | 25   | 0    | 1          | 564  | 153  | 397        | 749  | 141  |
| Saturation Flow Module:   |             |      |      |             |      |      |            |      |      |            |      |      |
| Sat/Lane:                 | 1900        | 1900 | 1900 | 1900        | 1900 | 1900 | 1900       | 1900 | 1900 | 1900       | 1900 | 1900 |
| Adjustment:               | 0.95        | 0.95 | 0.92 | 0.95        | 0.95 | 0.92 | 0.95       | 0.97 | 0.92 | 0.92       | 0.98 | 0.95 |
| Lanes:                    | 0.70        | 0.30 | 1.00 | 0.88        | 0.12 | 1.00 | 0.01       | 1.99 | 1.00 | 1.00       | 1.67 | 0.33 |
| Final Sat.:               | 1255        | 545  | 1750 | 1582        | 218  | 1750 | 7          | 3693 | 1750 | 1750       | 3113 | 586  |
| Capacity Analysis Module: |             |      |      |             |      |      |            |      |      |            |      |      |
| Vol/Sat:                  | 0.08        | 0.08 | 0.12 | 0.11        | 0.11 | 0.00 | 0.15       | 0.15 | 0.09 | 0.23       | 0.24 | 0.24 |
| Crit Moves:               | ****        |      |      | ****        |      |      | ****       |      |      | ****       |      |      |
| Green Time:               | 31.5        | 31.5 | 31.5 | 31.5        | 31.5 | 0.0  | 40.0       | 40.0 | 40.0 | 59.5       | 99.5 | 99.5 |
| Volume/Cap:               | 0.35        | 0.35 | 0.53 | 0.51        | 0.51 | 0.00 | 0.53       | 0.53 | 0.31 | 0.53       | 0.34 | 0.34 |
| Delay/Veh:                | 46.2        | 46.2 | 49.2 | 48.6        | 48.6 | 0.0  | 42.6       | 42.6 | 39.4 | 30.7       | 7.8  | 7.8  |
| User DelAdj:              | 1.00        | 1.00 | 1.00 | 1.00        | 1.00 | 1.00 | 1.00       | 1.00 | 1.00 | 1.00       | 1.00 | 1.00 |
| AdjDel/Veh:               | 46.2        | 46.2 | 49.2 | 48.6        | 48.6 | 0.0  | 42.6       | 42.6 | 39.4 | 30.7       | 7.8  | 7.8  |
| LOS by Move:              | D           | D    | D    | D           | D    | A    | D          | D    | D    | C          | A    | A    |
| HCM2k95thQ:               | 10          | 10   | 16   | 16          | 16   | 0    | 19         | 19   | 10   | 24         | 14   | 14   |

Note: Queue reported is the number of cars per lane.



BART

Level Of Service Computation Report  
 2000 HCM Operations (Future Volume Alternative)  
 PM - Bkgrd + Proj Conditions

Intersection #4005: JULIAN/28TH [Study Int 3]

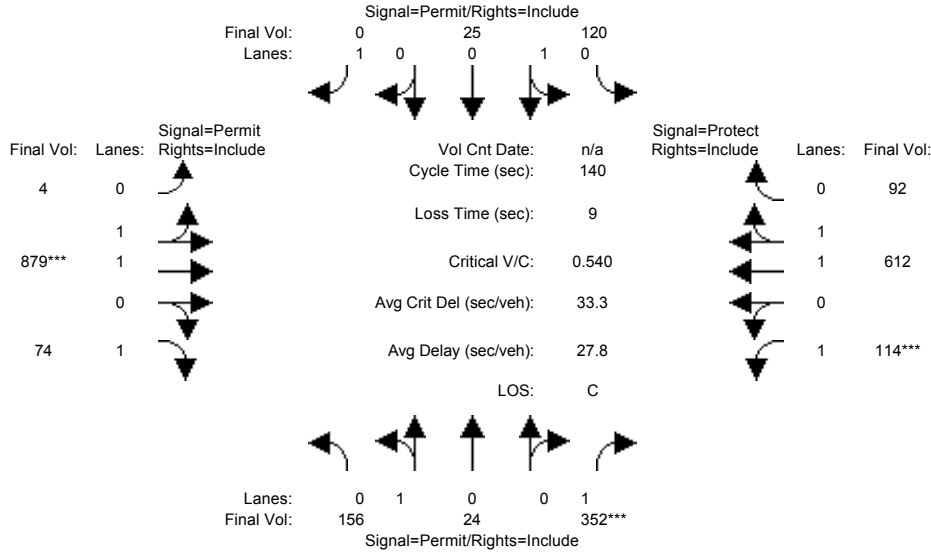

| Approach:                 | North Bound |      |      | South Bound |      |      | East Bound |      |      | West Bound |      |      |
|---------------------------|-------------|------|------|-------------|------|------|------------|------|------|------------|------|------|
| Movement:                 | L           | T    | R    | L           | T    | R    | L          | T    | R    | L          | T    | R    |
| Min. Green:               | 10          | 10   | 10   | 10          | 10   | 10   | 10         | 10   | 10   | 7          | 10   | 10   |
| Y+R:                      | 4.0         | 4.0  | 4.0  | 4.0         | 4.0  | 4.0  | 4.0        | 4.0  | 4.0  | 4.0        | 4.0  | 4.0  |
| Volume Module:            |             |      |      |             |      |      |            |      |      |            |      |      |
| Base Vol:                 | 156         | 24   | 352  | 120         | 25   | -1   | 4          | 879  | 74   | 114        | 612  | 92   |
| Growth Adj:               | 1.00        | 1.00 | 1.00 | 1.00        | 1.00 | 1.00 | 1.00       | 1.00 | 1.00 | 1.00       | 1.00 | 1.00 |
| Initial Bse:              | 156         | 24   | 352  | 120         | 25   | -1   | 4          | 879  | 74   | 114        | 612  | 92   |
| Added Vol:                | 0           | 0    | 0    | 0           | 0    | 0    | 0          | 0    | 0    | 0          | 0    | 0    |
| PasserByVol:              | 0           | 0    | 0    | 0           | 0    | 0    | 0          | 0    | 0    | 0          | 0    | 0    |
| Initial Fut:              | 156         | 24   | 352  | 120         | 25   | -1   | 4          | 879  | 74   | 114        | 612  | 92   |
| User Adj:                 | 1.00        | 1.00 | 1.00 | 1.00        | 1.00 | 0.00 | 1.00       | 1.00 | 1.00 | 1.00       | 1.00 | 1.00 |
| PHF Adj:                  | 1.00        | 1.00 | 1.00 | 1.00        | 1.00 | 0.00 | 1.00       | 1.00 | 1.00 | 1.00       | 1.00 | 1.00 |
| PHF Volume:               | 156         | 24   | 352  | 120         | 25   | 0    | 4          | 879  | 74   | 114        | 612  | 92   |
| Reduct Vol:               | 0           | 0    | 0    | 0           | 0    | 0    | 0          | 0    | 0    | 0          | 0    | 0    |
| Reduced Vol:              | 156         | 24   | 352  | 120         | 25   | 0    | 4          | 879  | 74   | 114        | 612  | 92   |
| PCE Adj:                  | 1.00        | 1.00 | 1.00 | 1.00        | 1.00 | 0.00 | 1.00       | 1.00 | 1.00 | 1.00       | 1.00 | 1.00 |
| MLF Adj:                  | 1.00        | 1.00 | 1.00 | 1.00        | 1.00 | 0.00 | 1.00       | 1.00 | 1.00 | 1.00       | 1.00 | 1.00 |
| FinalVolume:              | 156         | 24   | 352  | 120         | 25   | 0    | 4          | 879  | 74   | 114        | 612  | 92   |
| Saturation Flow Module:   |             |      |      |             |      |      |            |      |      |            |      |      |
| Sat/Lane:                 | 1900        | 1900 | 1900 | 1900        | 1900 | 1900 | 1900       | 1900 | 1900 | 1900       | 1900 | 1900 |
| Adjustment:               | 0.95        | 0.95 | 0.92 | 0.95        | 0.95 | 0.92 | 0.95       | 0.97 | 0.92 | 0.92       | 0.98 | 0.95 |
| Lanes:                    | 0.87        | 0.13 | 1.00 | 0.83        | 0.17 | 1.00 | 0.01       | 1.99 | 1.00 | 1.00       | 1.73 | 0.27 |
| Final Sat.:               | 1560        | 240  | 1750 | 1490        | 310  | 1750 | 17         | 3683 | 1750 | 1750       | 3216 | 483  |
| Capacity Analysis Module: |             |      |      |             |      |      |            |      |      |            |      |      |
| Vol/Sat:                  | 0.10        | 0.10 | 0.20 | 0.08        | 0.08 | 0.00 | 0.24       | 0.24 | 0.04 | 0.07       | 0.19 | 0.19 |
| Crit Moves:               | ****        |      |      | ****        |      |      | ****       |      |      | ****       |      |      |
| Green Time:               | 52.2        | 52.2 | 52.2 | 52.2        | 52.2 | 0.0  | 61.9       | 61.9 | 61.9 | 16.9       | 78.8 | 78.8 |
| Volume/Cap:               | 0.27        | 0.27 | 0.54 | 0.22        | 0.22 | 0.00 | 0.54       | 0.54 | 0.10 | 0.54       | 0.34 | 0.34 |
| Delay/Veh:                | 30.8        | 30.8 | 35.4 | 30.1        | 30.1 | 0.0  | 29.0       | 29.0 | 22.8 | 60.7       | 16.6 | 16.6 |
| User DelAdj:              | 1.00        | 1.00 | 1.00 | 1.00        | 1.00 | 1.00 | 1.00       | 1.00 | 1.00 | 1.00       | 1.00 | 1.00 |
| AdjDel/Veh:               | 30.8        | 30.8 | 35.4 | 30.1        | 30.1 | 0.0  | 29.0       | 29.0 | 22.8 | 60.7       | 16.6 | 16.6 |
| LOS by Move:              | C           | C    | D    | C           | C    | A    | C          | C    | C    | E          | B    | B    |
| HCM2k95thQ:               | 10          | 10   | 22   | 9           | 9    | 0    | 25         | 25   | 4    | 10         | 15   | 15   |

Note: Queue reported is the number of cars per lane.

BART

Level Of Service Computation Report  
 2000 HCM Operations (Future Volume Alternative)  
 AM - Bkgrd + Proj Conditions

Intersection #4022: SANTA CLARA/26TH [Study Int 12]

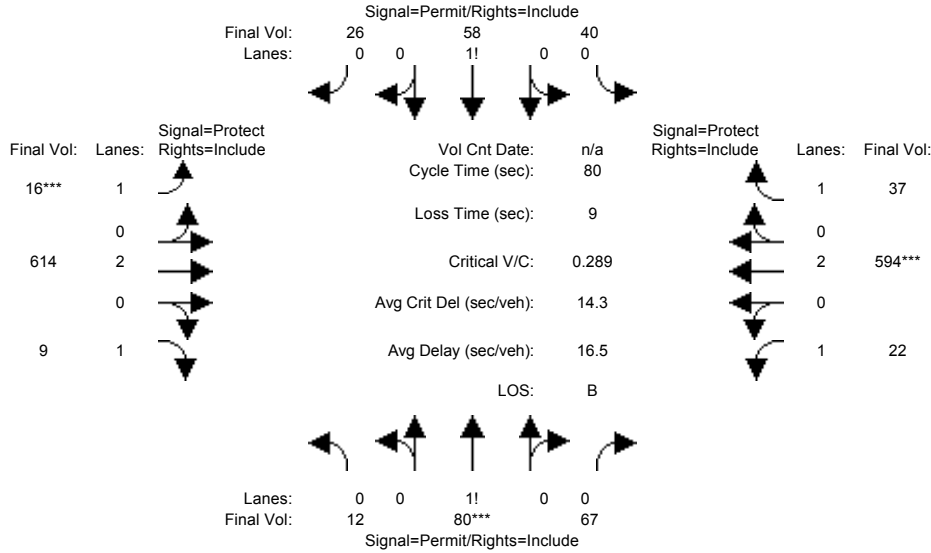

| Approach:                 | North Bound |      |      | South Bound |      |      | East Bound |      |      | West Bound |      |      |
|---------------------------|-------------|------|------|-------------|------|------|------------|------|------|------------|------|------|
| Movement:                 | L           | T    | R    | L           | T    | R    | L          | T    | R    | L          | T    | R    |
| Min. Green:               | 10          | 10   | 10   | 10          | 10   | 10   | 7          | 10   | 10   | 7          | 10   | 10   |
| Y+R:                      | 4.0         | 4.0  | 4.0  | 4.0         | 4.0  | 4.0  | 4.0        | 4.0  | 4.0  | 4.0        | 4.0  | 4.0  |
| Volume Module:            |             |      |      |             |      |      |            |      |      |            |      |      |
| Base Vol:                 | 12          | 80   | 67   | 40          | 58   | 26   | 16         | 614  | 9    | 22         | 594  | 37   |
| Growth Adj:               | 1.00        | 1.00 | 1.00 | 1.00        | 1.00 | 1.00 | 1.00       | 1.00 | 1.00 | 1.00       | 1.00 | 1.00 |
| Initial Bse:              | 12          | 80   | 67   | 40          | 58   | 26   | 16         | 614  | 9    | 22         | 594  | 37   |
| Added Vol:                | 0           | 0    | 0    | 0           | 0    | 0    | 0          | 0    | 0    | 0          | 0    | 0    |
| PasserByVol:              | 0           | 0    | 0    | 0           | 0    | 0    | 0          | 0    | 0    | 0          | 0    | 0    |
| Initial Fut:              | 12          | 80   | 67   | 40          | 58   | 26   | 16         | 614  | 9    | 22         | 594  | 37   |
| User Adj:                 | 1.00        | 1.00 | 1.00 | 1.00        | 1.00 | 1.00 | 1.00       | 1.00 | 1.00 | 1.00       | 1.00 | 1.00 |
| PHF Adj:                  | 1.00        | 1.00 | 1.00 | 1.00        | 1.00 | 1.00 | 1.00       | 1.00 | 1.00 | 1.00       | 1.00 | 1.00 |
| PHF Volume:               | 12          | 80   | 67   | 40          | 58   | 26   | 16         | 614  | 9    | 22         | 594  | 37   |
| Reduct Vol:               | 0           | 0    | 0    | 0           | 0    | 0    | 0          | 0    | 0    | 0          | 0    | 0    |
| Reduced Vol:              | 12          | 80   | 67   | 40          | 58   | 26   | 16         | 614  | 9    | 22         | 594  | 37   |
| PCE Adj:                  | 1.00        | 1.00 | 1.00 | 1.00        | 1.00 | 1.00 | 1.00       | 1.00 | 1.00 | 1.00       | 1.00 | 1.00 |
| MLF Adj:                  | 1.00        | 1.00 | 1.00 | 1.00        | 1.00 | 1.00 | 1.00       | 1.00 | 1.00 | 1.00       | 1.00 | 1.00 |
| Final Volume:             | 12          | 80   | 67   | 40          | 58   | 26   | 16         | 614  | 9    | 22         | 594  | 37   |
| Saturation Flow Module:   |             |      |      |             |      |      |            |      |      |            |      |      |
| Sat/Lane:                 | 1900        | 1900 | 1900 | 1900        | 1900 | 1900 | 1900       | 1900 | 1900 | 1900       | 1900 | 1900 |
| Adjustment:               | 0.92        | 0.92 | 0.92 | 0.92        | 0.92 | 0.92 | 0.92       | 1.00 | 0.92 | 0.92       | 1.00 | 0.92 |
| Lanes:                    | 0.08        | 0.50 | 0.42 | 0.32        | 0.47 | 0.21 | 1.00       | 2.00 | 1.00 | 1.00       | 2.00 | 1.00 |
| Final Sat.:               | 132         | 881  | 737  | 565         | 819  | 367  | 1750       | 3800 | 1750 | 1750       | 3800 | 1750 |
| Capacity Analysis Module: |             |      |      |             |      |      |            |      |      |            |      |      |
| Vol/Sat:                  | 0.09        | 0.09 | 0.09 | 0.07        | 0.07 | 0.07 | 0.01       | 0.16 | 0.01 | 0.01       | 0.16 | 0.02 |
| Crit Moves:               | ****        |      |      |             |      |      | ****       |      |      | ****       |      |      |
| Green Time:               | 23.5        | 23.5 | 23.5 | 23.5        | 23.5 | 23.5 | 7.0        | 30.8 | 30.8 | 16.7       | 40.5 | 40.5 |
| Volume/Cap:               | 0.31        | 0.31 | 0.31 | 0.24        | 0.24 | 0.24 | 0.10       | 0.42 | 0.01 | 0.06       | 0.31 | 0.04 |
| Delay/Veh:                | 22.3        | 22.3 | 22.3 | 21.7        | 21.7 | 21.7 | 33.9       | 18.2 | 15.2 | 25.4       | 11.7 | 10.0 |
| User DelAdj:              | 1.00        | 1.00 | 1.00 | 1.00        | 1.00 | 1.00 | 1.00       | 1.00 | 1.00 | 1.00       | 1.00 | 1.00 |
| AdjDel/Veh:               | 22.3        | 22.3 | 22.3 | 21.7        | 21.7 | 21.7 | 33.9       | 18.2 | 15.2 | 25.4       | 11.7 | 10.0 |
| LOS by Move:              | C           | C    | C    | C           | C    | C    | C          | B    | B    | C          | B    | A    |
| HCM2k95thQ:               | 7           | 7    | 7    | 5           | 5    | 5    | 1          | 10   | 0    | 1          | 8    | 1    |

Note: Queue reported is the number of cars per lane.

BART

Level Of Service Computation Report  
2000 HCM Operations (Future Volume Alternative)  
PM - Bkgrd + Proj Conditions

Intersection #4022: SANTA CLARA/26TH [Study Int 12]

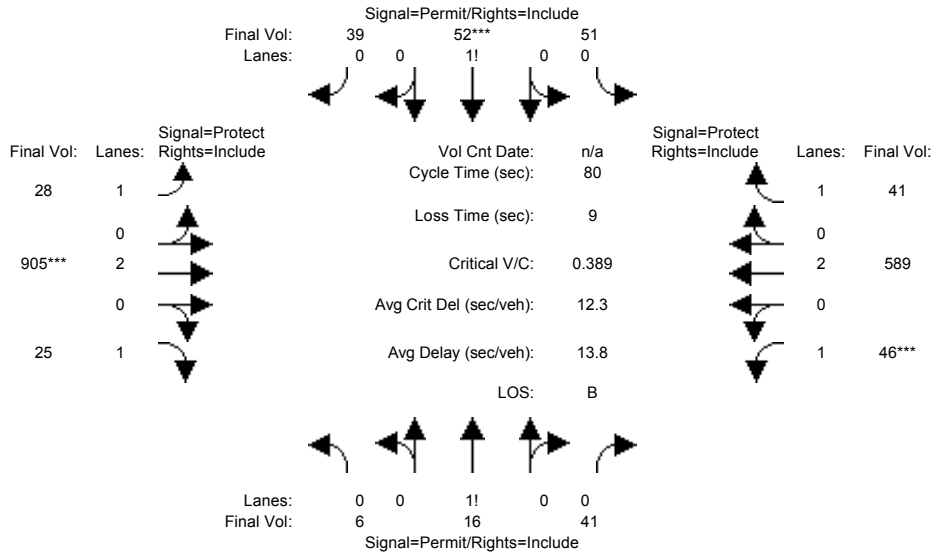

| Approach:                 | North Bound |      |      | South Bound |      |      | East Bound |      |      | West Bound |      |      |
|---------------------------|-------------|------|------|-------------|------|------|------------|------|------|------------|------|------|
| Movement:                 | L           | T    | R    | L           | T    | R    | L          | T    | R    | L          | T    | R    |
| Min. Green:               | 10          | 10   | 10   | 10          | 10   | 10   | 7          | 10   | 10   | 7          | 10   | 10   |
| Y+R:                      | 4.0         | 4.0  | 4.0  | 4.0         | 4.0  | 4.0  | 4.0        | 4.0  | 4.0  | 4.0        | 4.0  | 4.0  |
| Volume Module:            |             |      |      |             |      |      |            |      |      |            |      |      |
| Base Vol:                 | 6           | 16   | 41   | 51          | 52   | 39   | 28         | 905  | 25   | 46         | 589  | 41   |
| Growth Adj:               | 1.00        | 1.00 | 1.00 | 1.00        | 1.00 | 1.00 | 1.00       | 1.00 | 1.00 | 1.00       | 1.00 | 1.00 |
| Initial Bse:              | 6           | 16   | 41   | 51          | 52   | 39   | 28         | 905  | 25   | 46         | 589  | 41   |
| Added Vol:                | 0           | 0    | 0    | 0           | 0    | 0    | 0          | 0    | 0    | 0          | 0    | 0    |
| PasserByVol:              | 0           | 0    | 0    | 0           | 0    | 0    | 0          | 0    | 0    | 0          | 0    | 0    |
| Initial Fut:              | 6           | 16   | 41   | 51          | 52   | 39   | 28         | 905  | 25   | 46         | 589  | 41   |
| User Adj:                 | 1.00        | 1.00 | 1.00 | 1.00        | 1.00 | 1.00 | 1.00       | 1.00 | 1.00 | 1.00       | 1.00 | 1.00 |
| PHF Adj:                  | 1.00        | 1.00 | 1.00 | 1.00        | 1.00 | 1.00 | 1.00       | 1.00 | 1.00 | 1.00       | 1.00 | 1.00 |
| PHF Volume:               | 6           | 16   | 41   | 51          | 52   | 39   | 28         | 905  | 25   | 46         | 589  | 41   |
| Reduct Vol:               | 0           | 0    | 0    | 0           | 0    | 0    | 0          | 0    | 0    | 0          | 0    | 0    |
| Reduced Vol:              | 6           | 16   | 41   | 51          | 52   | 39   | 28         | 905  | 25   | 46         | 589  | 41   |
| PCE Adj:                  | 1.00        | 1.00 | 1.00 | 1.00        | 1.00 | 1.00 | 1.00       | 1.00 | 1.00 | 1.00       | 1.00 | 1.00 |
| MLF Adj:                  | 1.00        | 1.00 | 1.00 | 1.00        | 1.00 | 1.00 | 1.00       | 1.00 | 1.00 | 1.00       | 1.00 | 1.00 |
| FinalVolume:              | 6           | 16   | 41   | 51          | 52   | 39   | 28         | 905  | 25   | 46         | 589  | 41   |
| Saturation Flow Module:   |             |      |      |             |      |      |            |      |      |            |      |      |
| Sat/Lane:                 | 1900        | 1900 | 1900 | 1900        | 1900 | 1900 | 1900       | 1900 | 1900 | 1900       | 1900 | 1900 |
| Adjustment:               | 0.92        | 0.92 | 0.92 | 0.92        | 0.92 | 0.92 | 0.92       | 1.00 | 0.92 | 0.92       | 1.00 | 0.92 |
| Lanes:                    | 0.10        | 0.25 | 0.65 | 0.36        | 0.37 | 0.27 | 1.00       | 2.00 | 1.00 | 1.00       | 2.00 | 1.00 |
| Final Sat.:               | 167         | 444  | 1139 | 629         | 641  | 481  | 1750       | 3800 | 1750 | 1750       | 3800 | 1750 |
| Capacity Analysis Module: |             |      |      |             |      |      |            |      |      |            |      |      |
| Vol/Sat:                  | 0.04        | 0.04 | 0.04 | 0.08        | 0.08 | 0.08 | 0.02       | 0.24 | 0.01 | 0.03       | 0.16 | 0.02 |
| Crit Moves:               |             |      |      | ****        |      |      | ****       |      |      | ****       |      |      |
| Green Time:               | 16.3        | 16.3 | 16.3 | 16.3        | 16.3 | 16.3 | 19.8       | 47.7 | 47.7 | 7.0        | 35.0 | 35.0 |
| Volume/Cap:               | 0.18        | 0.18 | 0.18 | 0.40        | 0.40 | 0.40 | 0.06       | 0.40 | 0.02 | 0.30       | 0.35 | 0.05 |
| Delay/Veh:                | 26.6        | 26.6 | 26.6 | 28.4        | 28.4 | 28.4 | 23.1       | 8.7  | 6.6  | 35.3       | 15.1 | 13.0 |
| User DelAdj:              | 1.00        | 1.00 | 1.00 | 1.00        | 1.00 | 1.00 | 1.00       | 1.00 | 1.00 | 1.00       | 1.00 | 1.00 |
| AdjDel/Veh:               | 26.6        | 26.6 | 26.6 | 28.4        | 28.4 | 28.4 | 23.1       | 8.7  | 6.6  | 35.3       | 15.1 | 13.0 |
| LOS by Move:              | C           | C    | C    | C           | C    | C    | C          | A    | A    | D          | B    | B    |
| HCM2k95thQ:               | 3           | 3    | 3    | 7           | 7    | 7    | 1          | 11   | 1    | 2          | 9    | 1    |

Note: Queue reported is the number of cars per lane.

BART

Level Of Service Computation Report  
 2000 HCM Operations (Future Volume Alternative)  
 AM - Bkgrd + Proj Conditions

Intersection #4038: 87/Taylor [Study Int 40]

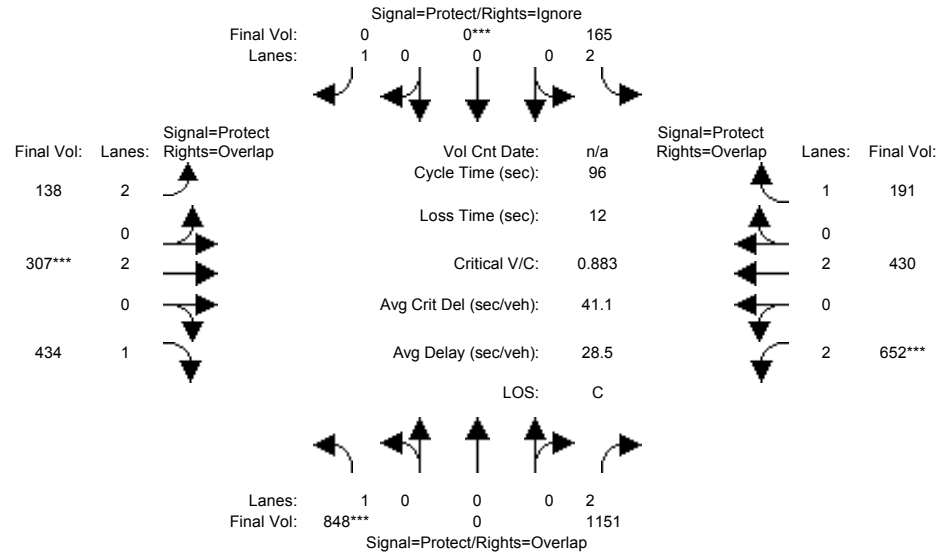

| Approach:                 | North Bound |      |      | South Bound |      |      | East Bound |      |      | West Bound |      |      |
|---------------------------|-------------|------|------|-------------|------|------|------------|------|------|------------|------|------|
| Movement:                 | L           | T    | R    | L           | T    | R    | L          | T    | R    | L          | T    | R    |
| Min. Green:               | 7           | 0    | 10   | 7           | 0    | 10   | 7          | 10   | 10   | 7          | 10   | 10   |
| Y+R:                      | 4.0         | 4.0  | 4.0  | 4.0         | 4.0  | 4.0  | 4.0        | 4.0  | 4.0  | 4.0        | 4.0  | 4.0  |
| Volume Module:            |             |      |      |             |      |      |            |      |      |            |      |      |
| Base Vol:                 | 848         | 0    | 1151 | 165         | 0    | 143  | 138        | 307  | 434  | 652        | 430  | 191  |
| Growth Adj:               | 1.00        | 1.00 | 1.00 | 1.00        | 1.00 | 1.00 | 1.00       | 1.00 | 1.00 | 1.00       | 1.00 | 1.00 |
| Initial Bse:              | 848         | 0    | 1151 | 165         | 0    | 143  | 138        | 307  | 434  | 652        | 430  | 191  |
| Added Vol:                | 0           | 0    | 0    | 0           | 0    | 0    | 0          | 0    | 0    | 0          | 0    | 0    |
| PasserByVol:              | 0           | 0    | 0    | 0           | 0    | 0    | 0          | 0    | 0    | 0          | 0    | 0    |
| Initial Fut:              | 848         | 0    | 1151 | 165         | 0    | 143  | 138        | 307  | 434  | 652        | 430  | 191  |
| User Adj:                 | 1.00        | 1.00 | 1.00 | 1.00        | 1.00 | 0.00 | 1.00       | 1.00 | 1.00 | 1.00       | 1.00 | 1.00 |
| PHF Adj:                  | 1.00        | 1.00 | 1.00 | 1.00        | 1.00 | 0.00 | 1.00       | 1.00 | 1.00 | 1.00       | 1.00 | 1.00 |
| PHF Volume:               | 848         | 0    | 1151 | 165         | 0    | 0    | 138        | 307  | 434  | 652        | 430  | 191  |
| Reduct Vol:               | 0           | 0    | 0    | 0           | 0    | 0    | 0          | 0    | 0    | 0          | 0    | 0    |
| Reduced Vol:              | 848         | 0    | 1151 | 165         | 0    | 0    | 138        | 307  | 434  | 652        | 430  | 191  |
| PCE Adj:                  | 1.00        | 1.00 | 1.00 | 1.00        | 1.00 | 0.00 | 1.00       | 1.00 | 1.00 | 1.00       | 1.00 | 1.00 |
| MLF Adj:                  | 1.00        | 1.00 | 1.00 | 1.00        | 1.00 | 0.00 | 1.00       | 1.00 | 1.00 | 1.00       | 1.00 | 1.00 |
| Final Volume:             | 848         | 0    | 1151 | 165         | 0    | 0    | 138        | 307  | 434  | 652        | 430  | 191  |
| Saturation Flow Module:   |             |      |      |             |      |      |            |      |      |            |      |      |
| Sat/Lane:                 | 1900        | 1900 | 1900 | 1900        | 1900 | 1900 | 1900       | 1900 | 1900 | 1900       | 1900 | 1900 |
| Adjustment:               | 0.92        | 1.00 | 0.83 | 0.83        | 1.00 | 0.92 | 0.83       | 1.00 | 0.92 | 0.83       | 1.00 | 0.92 |
| Lanes:                    | 1.00        | 0.00 | 2.00 | 2.00        | 0.00 | 1.00 | 2.00       | 2.00 | 1.00 | 2.00       | 2.00 | 1.00 |
| Final Sat.:               | 1750        | 0    | 3150 | 3150        | 0    | 1750 | 3150       | 3800 | 1750 | 3150       | 3800 | 1750 |
| Capacity Analysis Module: |             |      |      |             |      |      |            |      |      |            |      |      |
| Vol/Sat:                  | 0.48        | 0.00 | 0.37 | 0.05        | 0.00 | 0.00 | 0.04       | 0.08 | 0.25 | 0.21       | 0.11 | 0.11 |
| Crit Moves:               | ****        |      |      | ****        |      |      | ****       |      | **** | ****       |      |      |
| Green Time:               | 51.9        | 0.0  | 57.7 | 16.3        | 0.0  | 0.0  | 12.6       | 10.0 | 61.9 | 22.1       | 19.6 | 35.9 |
| Volume/Cap:               | 0.90        | 0.00 | 0.61 | 0.31        | 0.00 | 0.00 | 0.33       | 0.78 | 0.38 | 0.90       | 0.56 | 0.29 |
| Delay/Veh:                | 30.9        | 0.0  | 12.6 | 35.2        | 0.0  | 0.0  | 38.4       | 51.2 | 8.3  | 49.7       | 35.2 | 21.4 |
| User DelAdj:              | 1.00        | 1.00 | 1.00 | 1.00        | 1.00 | 1.00 | 1.00       | 1.00 | 1.00 | 1.00       | 1.00 | 1.00 |
| AdjDel/Veh:               | 30.9        | 0.0  | 12.6 | 35.2        | 0.0  | 0.0  | 38.4       | 51.2 | 8.3  | 49.7       | 35.2 | 21.4 |
| LOS by Move:              | C           | A    | B    | D           | A    | A    | D          | D    | A    | D          | D    | C    |
| HCM2k95thQ:               | 45          | 0    | 24   | 6           | 0    | 0    | 4          | 9    | 12   | 26         | 12   | 8    |

Note: Queue reported is the number of cars per lane.

BART

Level Of Service Computation Report  
 2000 HCM Operations (Future Volume Alternative)  
 PM - Bkgrd + Proj Conditions

Intersection #4038: 87/Taylor [Study Int 40]

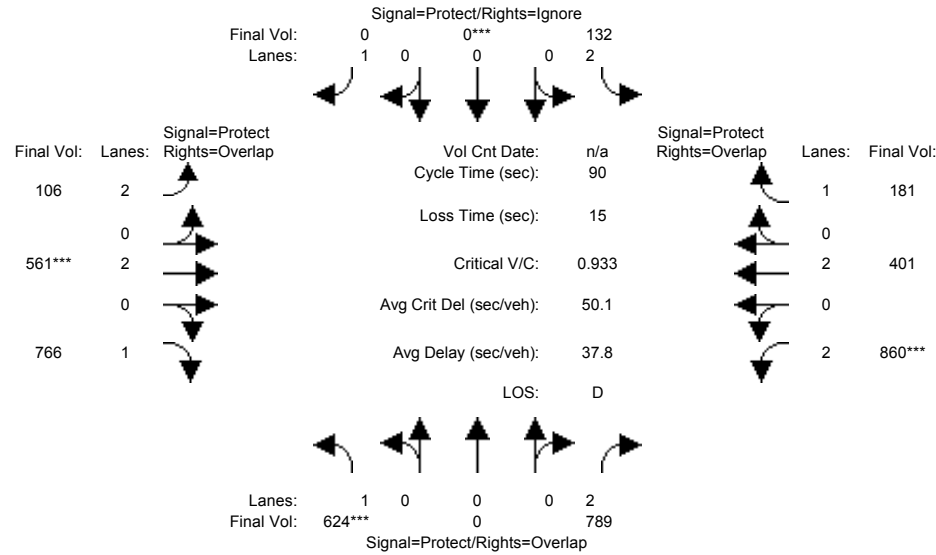

| Approach:                 | North Bound |      |      | South Bound |      |      | East Bound |      |      | West Bound |      |      |
|---------------------------|-------------|------|------|-------------|------|------|------------|------|------|------------|------|------|
| Movement:                 | L           | T    | R    | L           | T    | R    | L          | T    | R    | L          | T    | R    |
| Min. Green:               | 7           | 0    | 10   | 7           | 0    | 10   | 7          | 10   | 10   | 7          | 10   | 10   |
| Y+R:                      | 4.0         | 4.0  | 4.0  | 4.0         | 4.0  | 4.0  | 4.0        | 4.0  | 4.0  | 4.0        | 4.0  | 4.0  |
| Volume Module:            |             |      |      |             |      |      |            |      |      |            |      |      |
| Base Vol:                 | 624         | 0    | 789  | 132         | 0    | 151  | 106        | 561  | 766  | 860        | 401  | 181  |
| Growth Adj:               | 1.00        | 1.00 | 1.00 | 1.00        | 1.00 | 1.00 | 1.00       | 1.00 | 1.00 | 1.00       | 1.00 | 1.00 |
| Initial Bse:              | 624         | 0    | 789  | 132         | 0    | 151  | 106        | 561  | 766  | 860        | 401  | 181  |
| Added Vol:                | 0           | 0    | 0    | 0           | 0    | 0    | 0          | 0    | 0    | 0          | 0    | 0    |
| PasserByVol:              | 0           | 0    | 0    | 0           | 0    | 0    | 0          | 0    | 0    | 0          | 0    | 0    |
| Initial Fut:              | 624         | 0    | 789  | 132         | 0    | 151  | 106        | 561  | 766  | 860        | 401  | 181  |
| User Adj:                 | 1.00        | 1.00 | 1.00 | 1.00        | 1.00 | 0.00 | 1.00       | 1.00 | 1.00 | 1.00       | 1.00 | 1.00 |
| PHF Adj:                  | 1.00        | 1.00 | 1.00 | 1.00        | 1.00 | 0.00 | 1.00       | 1.00 | 1.00 | 1.00       | 1.00 | 1.00 |
| PHF Volume:               | 624         | 0    | 789  | 132         | 0    | 0    | 106        | 561  | 766  | 860        | 401  | 181  |
| Reduct Vol:               | 0           | 0    | 0    | 0           | 0    | 0    | 0          | 0    | 0    | 0          | 0    | 0    |
| Reduced Vol:              | 624         | 0    | 789  | 132         | 0    | 0    | 106        | 561  | 766  | 860        | 401  | 181  |
| PCE Adj:                  | 1.00        | 1.00 | 1.00 | 1.00        | 1.00 | 0.00 | 1.00       | 1.00 | 1.00 | 1.00       | 1.00 | 1.00 |
| MLF Adj:                  | 1.00        | 1.00 | 1.00 | 1.00        | 1.00 | 0.00 | 1.00       | 1.00 | 1.00 | 1.00       | 1.00 | 1.00 |
| FinalVolume:              | 624         | 0    | 789  | 132         | 0    | 0    | 106        | 561  | 766  | 860        | 401  | 181  |
| Saturation Flow Module:   |             |      |      |             |      |      |            |      |      |            |      |      |
| Sat/Lane:                 | 1900        | 1900 | 1900 | 1900        | 1900 | 1900 | 1900       | 1900 | 1900 | 1900       | 1900 | 1900 |
| Adjustment:               | 0.92        | 1.00 | 0.83 | 0.83        | 1.00 | 0.92 | 0.83       | 1.00 | 0.92 | 0.83       | 1.00 | 0.92 |
| Lanes:                    | 1.00        | 0.00 | 2.00 | 2.00        | 0.00 | 1.00 | 2.00       | 2.00 | 1.00 | 2.00       | 2.00 | 1.00 |
| Final Sat.:               | 1750        | 0    | 3150 | 3150        | 0    | 1750 | 3150       | 3800 | 1750 | 3150       | 3800 | 1750 |
| Capacity Analysis Module: |             |      |      |             |      |      |            |      |      |            |      |      |
| Vol/Sat:                  | 0.36        | 0.00 | 0.25 | 0.04        | 0.00 | 0.00 | 0.03       | 0.15 | 0.44 | 0.27       | 0.11 | 0.10 |
| Crit Moves:               | ****        |      |      | ****        |      |      | ****       |      |      | ****       |      |      |
| Green Time:               | 34.4        | 0.0  | 26.3 | 34.4        | 0.0  | 0.0  | 16.7       | 14.2 | 48.7 | 26.3       | 23.9 | 58.3 |
| Volume/Cap:               | 0.93        | 0.00 | 0.86 | 0.11        | 0.00 | 0.00 | 0.18       | 0.93 | 0.81 | 0.93       | 0.40 | 0.16 |
| Delay/Veh:                | 46.7        | 0.0  | 38.0 | 18.0        | 0.0  | 0.0  | 31.0       | 59.0 | 22.2 | 46.8       | 27.4 | 6.3  |
| User DelAdj:              | 1.00        | 1.00 | 1.00 | 1.00        | 1.00 | 1.00 | 1.00       | 1.00 | 1.00 | 1.00       | 1.00 | 1.00 |
| AdjDel/Veh:               | 46.7        | 0.0  | 38.0 | 18.0        | 0.0  | 0.0  | 31.0       | 59.0 | 22.2 | 46.8       | 27.4 | 6.3  |
| LOS by Move:              | D           | A    | D    | B           | A    | A    | C          | E    | C    | D          | C    | A    |
| HCM2k95thQ:               | 38          | 0    | 27   | 3           | 0    | 0    | 3          | 14   | 30   | 32         | 9    | 4    |

Note: Queue reported is the number of cars per lane.

BART

Level Of Service Computation Report  
 2000 HCM Operations (Future Volume Alternative)  
 AM - Bkgrd + Proj Conditions

Intersection #4047: COLEMAN/NEWHALL [Study Int 35]

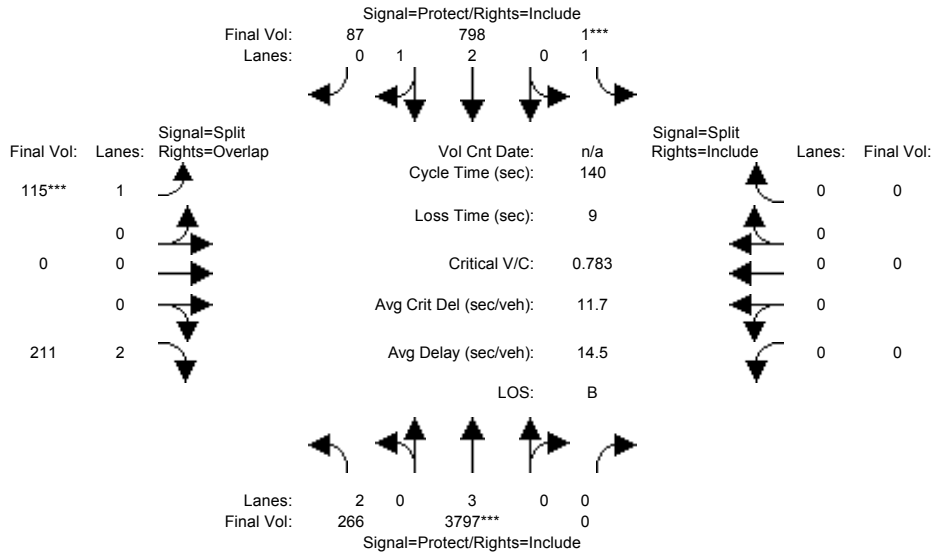

| Approach:                 | North Bound |      |      | South Bound |      |      | East Bound |      |      | West Bound |      |      |
|---------------------------|-------------|------|------|-------------|------|------|------------|------|------|------------|------|------|
| Movement:                 | L           | T    | R    | L           | T    | R    | L          | T    | R    | L          | T    | R    |
| Min. Green:               | 7           | 10   | 0    | 7           | 10   | 10   | 10         | 0    | 10   | 0          | 0    | 0    |
| Y+R:                      | 4.0         | 4.0  | 4.0  | 4.0         | 4.0  | 4.0  | 4.0        | 4.0  | 4.0  | 4.0        | 4.0  | 4.0  |
| Volume Module:            |             |      |      |             |      |      |            |      |      |            |      |      |
| Base Vol:                 | 266         | 3797 | 0    | 1           | 798  | 87   | 115        | 0    | 211  | 0          | 0    | 0    |
| Growth Adj:               | 1.00        | 1.00 | 1.00 | 1.00        | 1.00 | 1.00 | 1.00       | 1.00 | 1.00 | 1.00       | 1.00 | 1.00 |
| Initial Bse:              | 266         | 3797 | 0    | 1           | 798  | 87   | 115        | 0    | 211  | 0          | 0    | 0    |
| Added Vol:                | 0           | 0    | 0    | 0           | 0    | 0    | 0          | 0    | 0    | 0          | 0    | 0    |
| PasserByVol:              | 0           | 0    | 0    | 0           | 0    | 0    | 0          | 0    | 0    | 0          | 0    | 0    |
| Initial Fut:              | 266         | 3797 | 0    | 1           | 798  | 87   | 115        | 0    | 211  | 0          | 0    | 0    |
| User Adj:                 | 1.00        | 1.00 | 1.00 | 1.00        | 1.00 | 1.00 | 1.00       | 1.00 | 1.00 | 1.00       | 1.00 | 1.00 |
| PHF Adj:                  | 1.00        | 1.00 | 1.00 | 1.00        | 1.00 | 1.00 | 1.00       | 1.00 | 1.00 | 1.00       | 1.00 | 1.00 |
| PHF Volume:               | 266         | 3797 | 0    | 1           | 798  | 87   | 115        | 0    | 211  | 0          | 0    | 0    |
| Reduct Vol:               | 0           | 0    | 0    | 0           | 0    | 0    | 0          | 0    | 0    | 0          | 0    | 0    |
| Reduced Vol:              | 266         | 3797 | 0    | 1           | 798  | 87   | 115        | 0    | 211  | 0          | 0    | 0    |
| PCE Adj:                  | 1.00        | 1.00 | 1.00 | 1.00        | 1.00 | 1.00 | 1.00       | 1.00 | 1.00 | 1.00       | 1.00 | 1.00 |
| MLF Adj:                  | 1.00        | 1.00 | 1.00 | 1.00        | 1.00 | 1.00 | 1.00       | 1.00 | 1.00 | 1.00       | 1.00 | 1.00 |
| Final Volume:             | 266         | 3797 | 0    | 1           | 798  | 87   | 115        | 0    | 211  | 0          | 0    | 0    |
| Saturation Flow Module:   |             |      |      |             |      |      |            |      |      |            |      |      |
| Sat/Lane:                 | 1900        | 1900 | 1900 | 1900        | 1900 | 1900 | 1900       | 1900 | 1900 | 1900       | 1900 | 1900 |
| Adjustment:               | 0.83        | 1.00 | 0.92 | 0.92        | 0.99 | 0.95 | 0.92       | 1.00 | 0.83 | 0.92       | 1.00 | 0.92 |
| Lanes:                    | 2.00        | 3.00 | 0.00 | 1.00        | 2.69 | 0.31 | 1.00       | 0.00 | 2.00 | 0.00       | 0.00 | 0.00 |
| Final Sat.:               | 3150        | 5700 | 0    | 1750        | 5049 | 550  | 1750       | 0    | 3150 | 0          | 0    | 0    |
| Capacity Analysis Module: |             |      |      |             |      |      |            |      |      |            |      |      |
| Vol/Sat:                  | 0.08        | 0.67 | 0.00 | 0.00        | 0.16 | 0.16 | 0.07       | 0.00 | 0.07 | 0.00       | 0.00 | 0.00 |
| Crit Moves:               | ****        | **** | **** | ****        | **** | **** | ****       | **** | **** | ****       | **** | **** |
| Green Time:               | 41.7        | 113  | 0.0  | 7.0         | 78.1 | 78.1 | 11.1       | 0.0  | 52.9 | 0.0        | 0.0  | 0.0  |
| Volume/Cap:               | 0.28        | 0.83 | 0.00 | 0.01        | 0.28 | 0.28 | 0.83       | 0.00 | 0.18 | 0.00       | 0.00 | 0.00 |
| Delay/Veh:                | 37.8        | 9.2  | 0.0  | 63.3        | 16.3 | 16.3 | 95.1       | 0.0  | 29.1 | 0.0        | 0.0  | 0.0  |
| User DelAdj:              | 1.00        | 1.00 | 1.00 | 1.00        | 1.00 | 1.00 | 1.00       | 1.00 | 1.00 | 1.00       | 1.00 | 1.00 |
| AdjDel/Veh:               | 37.8        | 9.2  | 0.0  | 63.3        | 16.3 | 16.3 | 95.1       | 0.0  | 29.1 | 0.0        | 0.0  | 0.0  |
| LOS by Move:              | D           | A    | A    | E           | B    | B    | F          | A    | C    | A          | A    | A    |
| HCM2k95thQ:               | 10          | 52   | 0    | 0           | 12   | 12   | 14         | 0    | 7    | 0          | 0    | 0    |

Note: Queue reported is the number of cars per lane.

BART

Level Of Service Computation Report  
 2000 HCM Operations (Future Volume Alternative)  
 PM - Bkgrd + Proj Conditions

Intersection #4047: COLEMAN/NEWHALL [Study Int 35]

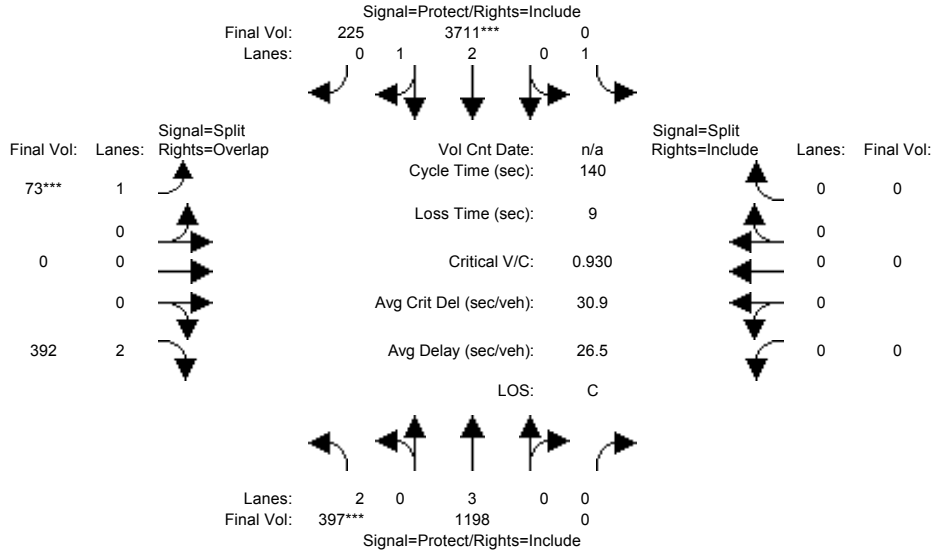

| Approach:                 | North Bound |      |      | South Bound |      |       | East Bound |      |      | West Bound |      |      |
|---------------------------|-------------|------|------|-------------|------|-------|------------|------|------|------------|------|------|
| Movement:                 | L           | T    | R    | L           | T    | R     | L          | T    | R    | L          | T    | R    |
| Min. Green:               | 7           | 10   | 0    | 7           | 10   | 10    | 10         | 0    | 10   | 0          | 0    | 0    |
| Y+R:                      | 4.0         | 4.0  | 4.0  | 4.0         | 4.0  | 4.0   | 4.0        | 4.0  | 4.0  | 4.0        | 4.0  | 4.0  |
| Volume Module:            |             |      |      |             |      |       |            |      |      |            |      |      |
| Base Vol:                 | 397         | 1198 | 0    | 0           | 3711 | 225   | 73         | 0    | 392  | 0          | 0    | 0    |
| Growth Adj:               | 1.00        | 1.00 | 1.00 | 1.00        | 1.00 | 1.00  | 1.00       | 1.00 | 1.00 | 1.00       | 1.00 | 1.00 |
| Initial Bse:              | 397         | 1198 | 0    | 0           | 3711 | 225   | 73         | 0    | 392  | 0          | 0    | 0    |
| Added Vol:                | 0           | 0    | 0    | 0           | 0    | 0     | 0          | 0    | 0    | 0          | 0    | 0    |
| PasserByVol:              | 0           | 0    | 0    | 0           | 0    | 0     | 0          | 0    | 0    | 0          | 0    | 0    |
| Initial Fut:              | 397         | 1198 | 0    | 0           | 3711 | 225   | 73         | 0    | 392  | 0          | 0    | 0    |
| User Adj:                 | 1.00        | 1.00 | 1.00 | 1.00        | 1.00 | 1.00  | 1.00       | 1.00 | 1.00 | 1.00       | 1.00 | 1.00 |
| PHF Adj:                  | 1.00        | 1.00 | 1.00 | 1.00        | 1.00 | 1.00  | 1.00       | 1.00 | 1.00 | 1.00       | 1.00 | 1.00 |
| PHF Volume:               | 397         | 1198 | 0    | 0           | 3711 | 225   | 73         | 0    | 392  | 0          | 0    | 0    |
| Reduct Vol:               | 0           | 0    | 0    | 0           | 0    | 0     | 0          | 0    | 0    | 0          | 0    | 0    |
| Reduced Vol:              | 397         | 1198 | 0    | 0           | 3711 | 225   | 73         | 0    | 392  | 0          | 0    | 0    |
| PCE Adj:                  | 1.00        | 1.00 | 1.00 | 1.00        | 1.00 | 1.00  | 1.00       | 1.00 | 1.00 | 1.00       | 1.00 | 1.00 |
| MLF Adj:                  | 1.00        | 1.00 | 1.00 | 1.00        | 1.00 | 1.00  | 1.00       | 1.00 | 1.00 | 1.00       | 1.00 | 1.00 |
| Final Volume:             | 397         | 1198 | 0    | 0           | 3711 | 225   | 73         | 0    | 392  | 0          | 0    | 0    |
| Saturation Flow Module:   |             |      |      |             |      |       |            |      |      |            |      |      |
| Sat/Lane:                 | 1900        | 1900 | 1900 | 1900        | 1900 | 1900  | 1900       | 1900 | 1900 | 1900       | 1900 | 1900 |
| Adjustment:               | 0.83        | 1.00 | 0.92 | 0.92        | 0.98 | 0.95  | 0.92       | 1.00 | 0.83 | 0.92       | 1.00 | 0.92 |
| Lanes:                    | 2.00        | 3.00 | 0.00 | 1.00        | 2.82 | 0.18  | 1.00       | 0.00 | 2.00 | 0.00       | 0.00 | 0.00 |
| Final Sat.:               | 3150        | 5700 | 0    | 1750        | 5279 | 320   | 1750       | 0    | 3150 | 0          | 0    | 0    |
| Capacity Analysis Module: |             |      |      |             |      |       |            |      |      |            |      |      |
| Vol/Sat:                  | 0.13        | 0.21 | 0.00 | 0.00        | 0.70 | 0.70  | 0.04       | 0.00 | 0.12 | 0.00       | 0.00 | 0.00 |
| Crit Moves:               | ****        |      |      | ****        |      |       | ****       |      |      |            |      |      |
| Green Time:               | 18.4        | 121  | 0.0  | 0.0         | 103  | 102.6 | 10.0       | 0.0  | 28.4 | 0.0        | 0.0  | 0.0  |
| Volume/Cap:               | 0.96        | 0.24 | 0.00 | 0.00        | 0.96 | 0.96  | 0.58       | 0.00 | 0.61 | 0.00       | 0.00 | 0.00 |
| Delay/Veh:                | 94.1        | 1.7  | 0.0  | 0.0         | 23.8 | 23.8  | 69.9       | 0.0  | 52.6 | 0.0        | 0.0  | 0.0  |
| User DelAdj:              | 1.00        | 1.00 | 1.00 | 1.00        | 1.00 | 1.00  | 1.00       | 1.00 | 1.00 | 1.00       | 1.00 | 1.00 |
| AdjDel/Veh:               | 94.1        | 1.7  | 0.0  | 0.0         | 23.8 | 23.8  | 69.9       | 0.0  | 52.6 | 0.0        | 0.0  | 0.0  |
| LOS by Move:              | F           | A    | A    | A           | C    | C     | E          | A    | D    | A          | A    | A    |
| HCM2k95thQ:               | 25          | 6    | 0    | 0           | 81   | 81    | 8          | 0    | 18   | 0          | 0    | 0    |

Note: Queue reported is the number of cars per lane.

BART

Level Of Service Computation Report  
 2000 HCM Operations (Future Volume Alternative)  
 AM - Bkgrd + Proj Conditions

Intersection #4069: 101/Trimble [Study Int 62]

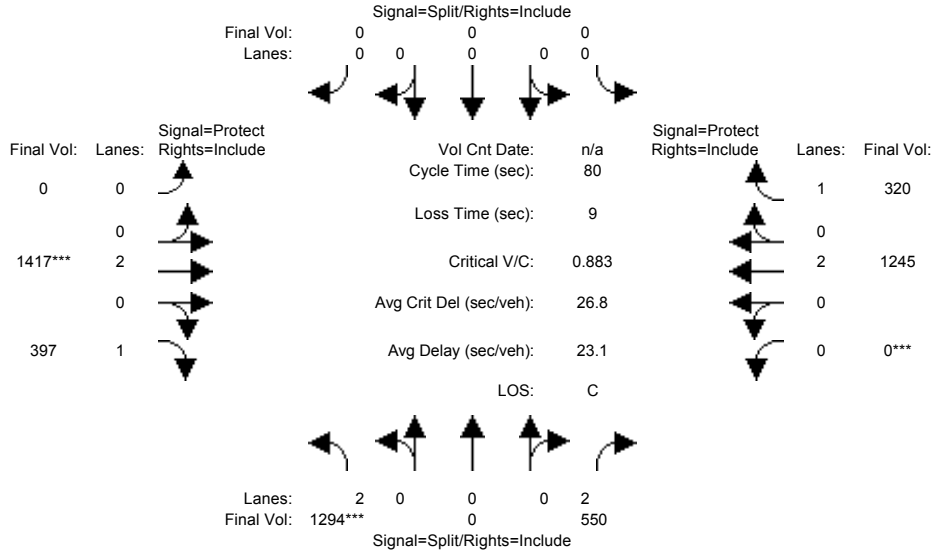

| Approach:                 | North Bound |      |      | South Bound |      |      | East Bound |      |      | West Bound |      |      |
|---------------------------|-------------|------|------|-------------|------|------|------------|------|------|------------|------|------|
| Movement:                 | L           | T    | R    | L           | T    | R    | L          | T    | R    | L          | T    | R    |
| Min. Green:               | 10          | 0    | 10   | 0           | 0    | 0    | 0          | 10   | 10   | 0          | 10   | 10   |
| Y+R:                      | 4.0         | 4.0  | 4.0  | 4.0         | 4.0  | 4.0  | 4.0        | 4.0  | 4.0  | 4.0        | 4.0  | 4.0  |
| Volume Module:            |             |      |      |             |      |      |            |      |      |            |      |      |
| Base Vol:                 | 1294        | 0    | 550  | 0           | 0    | 0    | 0          | 1417 | 397  | 0          | 1245 | 320  |
| Growth Adj:               | 1.00        | 1.00 | 1.00 | 1.00        | 1.00 | 1.00 | 1.00       | 1.00 | 1.00 | 1.00       | 1.00 | 1.00 |
| Initial Bse:              | 1294        | 0    | 550  | 0           | 0    | 0    | 0          | 1417 | 397  | 0          | 1245 | 320  |
| Added Vol:                | 0           | 0    | 0    | 0           | 0    | 0    | 0          | 0    | 0    | 0          | 0    | 0    |
| PasserByVol:              | 0           | 0    | 0    | 0           | 0    | 0    | 0          | 0    | 0    | 0          | 0    | 0    |
| Initial Fut:              | 1294        | 0    | 550  | 0           | 0    | 0    | 0          | 1417 | 397  | 0          | 1245 | 320  |
| User Adj:                 | 1.00        | 1.00 | 1.00 | 1.00        | 1.00 | 1.00 | 1.00       | 1.00 | 1.00 | 1.00       | 1.00 | 1.00 |
| PHF Adj:                  | 1.00        | 1.00 | 1.00 | 1.00        | 1.00 | 1.00 | 1.00       | 1.00 | 1.00 | 1.00       | 1.00 | 1.00 |
| PHF Volume:               | 1294        | 0    | 550  | 0           | 0    | 0    | 0          | 1417 | 397  | 0          | 1245 | 320  |
| Reduct Vol:               | 0           | 0    | 0    | 0           | 0    | 0    | 0          | 0    | 0    | 0          | 0    | 0    |
| Reduced Vol:              | 1294        | 0    | 550  | 0           | 0    | 0    | 0          | 1417 | 397  | 0          | 1245 | 320  |
| PCE Adj:                  | 1.00        | 1.00 | 1.00 | 1.00        | 1.00 | 1.00 | 1.00       | 1.00 | 1.00 | 1.00       | 1.00 | 1.00 |
| MLF Adj:                  | 1.00        | 1.00 | 1.00 | 1.00        | 1.00 | 1.00 | 1.00       | 1.00 | 1.00 | 1.00       | 1.00 | 1.00 |
| FinalVolume:              | 1294        | 0    | 550  | 0           | 0    | 0    | 0          | 1417 | 397  | 0          | 1245 | 320  |
| Saturation Flow Module:   |             |      |      |             |      |      |            |      |      |            |      |      |
| Sat/Lane:                 | 1900        | 1900 | 1900 | 1900        | 1900 | 1900 | 1900       | 1900 | 1900 | 1900       | 1900 | 1900 |
| Adjustment:               | 0.83        | 1.00 | 0.83 | 0.92        | 1.00 | 0.92 | 0.92       | 1.00 | 0.92 | 0.92       | 1.00 | 0.92 |
| Lanes:                    | 2.00        | 0.00 | 2.00 | 0.00        | 0.00 | 0.00 | 0.00       | 2.00 | 1.00 | 0.00       | 2.00 | 1.00 |
| Final Sat.:               | 3150        | 0    | 3150 | 0           | 0    | 0    | 0          | 3800 | 1750 | 0          | 3800 | 1750 |
| Capacity Analysis Module: |             |      |      |             |      |      |            |      |      |            |      |      |
| Vol/Sat:                  | 0.41        | 0.00 | 0.17 | 0.00        | 0.00 | 0.00 | 0.00       | 0.37 | 0.23 | 0.00       | 0.33 | 0.18 |
| Crit Moves:               | ****        |      |      |             |      |      |            | **** |      |            | **** |      |
| Green Time:               | 37.2        | 0.0  | 37.2 | 0.0         | 0.0  | 0.0  | 0.0        | 33.8 | 33.8 | 0.0        | 33.8 | 33.8 |
| Volume/Cap:               | 0.88        | 0.00 | 0.38 | 0.00        | 0.00 | 0.00 | 0.00       | 0.88 | 0.54 | 0.00       | 0.78 | 0.43 |
| Delay/Veh:                | 26.1        | 0.0  | 14.0 | 0.0         | 0.0  | 0.0  | 0.0        | 27.4 | 18.1 | 0.0        | 22.3 | 16.7 |
| User DelAdj:              | 1.00        | 1.00 | 1.00 | 1.00        | 1.00 | 1.00 | 1.00       | 1.00 | 1.00 | 1.00       | 1.00 | 1.00 |
| AdjDel/Veh:               | 26.1        | 0.0  | 14.0 | 0.0         | 0.0  | 0.0  | 0.0        | 27.4 | 18.1 | 0.0        | 22.3 | 16.7 |
| LOS by Move:              | C           | A    | B    | A           | A    | A    | A          | C    | B    | A          | C    | B    |
| HCM2k95thQ:               | 36          | 0    | 10   | 0           | 0    | 0    | 0          | 31   | 15   | 0          | 26   | 12   |

Note: Queue reported is the number of cars per lane.



BART

Level Of Service Computation Report  
 2000 HCM Operations (Future Volume Alternative)  
 PM - Bkgrd + Proj Conditions

Intersection #4069: 101/Trimble [Study Int 62]

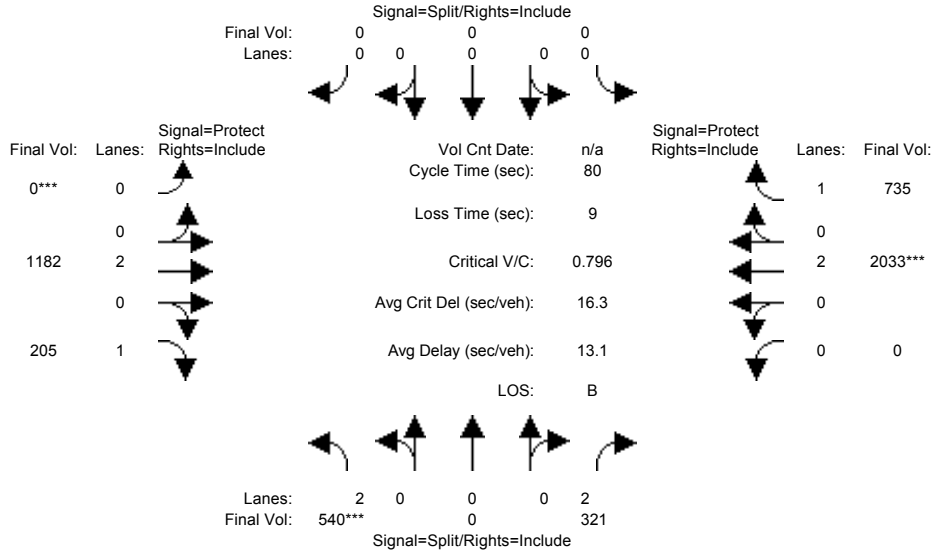

| Approach:                 | North Bound |      |      | South Bound |      |      | East Bound |      |      | West Bound |      |      |
|---------------------------|-------------|------|------|-------------|------|------|------------|------|------|------------|------|------|
| Movement:                 | L           | T    | R    | L           | T    | R    | L          | T    | R    | L          | T    | R    |
| Min. Green:               | 10          | 0    | 10   | 0           | 0    | 0    | 0          | 10   | 10   | 0          | 10   | 10   |
| Y+R:                      | 4.0         | 4.0  | 4.0  | 4.0         | 4.0  | 4.0  | 4.0        | 4.0  | 4.0  | 4.0        | 4.0  | 4.0  |
| Volume Module:            |             |      |      |             |      |      |            |      |      |            |      |      |
| Base Vol:                 | 540         | 0    | 321  | 0           | 0    | 0    | 0          | 1182 | 205  | 0          | 2033 | 735  |
| Growth Adj:               | 1.00        | 1.00 | 1.00 | 1.00        | 1.00 | 1.00 | 1.00       | 1.00 | 1.00 | 1.00       | 1.00 | 1.00 |
| Initial Bse:              | 540         | 0    | 321  | 0           | 0    | 0    | 0          | 1182 | 205  | 0          | 2033 | 735  |
| Added Vol:                | 0           | 0    | 0    | 0           | 0    | 0    | 0          | 0    | 0    | 0          | 0    | 0    |
| PasserByVol:              | 0           | 0    | 0    | 0           | 0    | 0    | 0          | 0    | 0    | 0          | 0    | 0    |
| Initial Fut:              | 540         | 0    | 321  | 0           | 0    | 0    | 0          | 1182 | 205  | 0          | 2033 | 735  |
| User Adj:                 | 1.00        | 1.00 | 1.00 | 1.00        | 1.00 | 1.00 | 1.00       | 1.00 | 1.00 | 1.00       | 1.00 | 1.00 |
| PHF Adj:                  | 1.00        | 1.00 | 1.00 | 1.00        | 1.00 | 1.00 | 1.00       | 1.00 | 1.00 | 1.00       | 1.00 | 1.00 |
| PHF Volume:               | 540         | 0    | 321  | 0           | 0    | 0    | 0          | 1182 | 205  | 0          | 2033 | 735  |
| Reduct Vol:               | 0           | 0    | 0    | 0           | 0    | 0    | 0          | 0    | 0    | 0          | 0    | 0    |
| Reduced Vol:              | 540         | 0    | 321  | 0           | 0    | 0    | 0          | 1182 | 205  | 0          | 2033 | 735  |
| PCE Adj:                  | 1.00        | 1.00 | 1.00 | 1.00        | 1.00 | 1.00 | 1.00       | 1.00 | 1.00 | 1.00       | 1.00 | 1.00 |
| MLF Adj:                  | 1.00        | 1.00 | 1.00 | 1.00        | 1.00 | 1.00 | 1.00       | 1.00 | 1.00 | 1.00       | 1.00 | 1.00 |
| FinalVolume:              | 540         | 0    | 321  | 0           | 0    | 0    | 0          | 1182 | 205  | 0          | 2033 | 735  |
| Saturation Flow Module:   |             |      |      |             |      |      |            |      |      |            |      |      |
| Sat/Lane:                 | 1900        | 1900 | 1900 | 1900        | 1900 | 1900 | 1900       | 1900 | 1900 | 1900       | 1900 | 1900 |
| Adjustment:               | 0.83        | 1.00 | 0.83 | 0.92        | 1.00 | 0.92 | 0.92       | 1.00 | 0.92 | 0.92       | 1.00 | 0.92 |
| Lanes:                    | 2.00        | 0.00 | 2.00 | 0.00        | 0.00 | 0.00 | 0.00       | 2.00 | 1.00 | 0.00       | 2.00 | 1.00 |
| Final Sat.:               | 3150        | 0    | 3150 | 0           | 0    | 0    | 0          | 3800 | 1750 | 0          | 3800 | 1750 |
| Capacity Analysis Module: |             |      |      |             |      |      |            |      |      |            |      |      |
| Vol/Sat:                  | 0.17        | 0.00 | 0.10 | 0.00        | 0.00 | 0.00 | 0.00       | 0.31 | 0.12 | 0.00       | 0.54 | 0.42 |
| Crit Moves:               | ****        |      |      |             |      |      | ****       |      |      | ****       |      |      |
| Green Time:               | 17.2        | 0.0  | 17.2 | 0.0         | 0.0  | 0.0  | 0.0        | 53.8 | 53.8 | 0.0        | 53.8 | 53.8 |
| Volume/Cap:               | 0.80        | 0.00 | 0.47 | 0.00        | 0.00 | 0.00 | 0.00       | 0.46 | 0.17 | 0.00       | 0.80 | 0.62 |
| Delay/Veh:                | 36.2        | 0.0  | 27.9 | 0.0         | 0.0  | 0.0  | 0.0        | 6.4  | 4.9  | 0.0        | 11.1 | 8.5  |
| User DelAdj:              | 1.00        | 1.00 | 1.00 | 1.00        | 1.00 | 1.00 | 1.00       | 1.00 | 1.00 | 1.00       | 1.00 | 1.00 |
| AdjDel/Veh:               | 36.2        | 0.0  | 27.9 | 0.0         | 0.0  | 0.0  | 0.0        | 6.4  | 4.9  | 0.0        | 11.1 | 8.5  |
| LOS by Move:              | D           | A    | C    | A           | A    | A    | A          | A    | A    | A          | B    | A    |
| HCM2k95thQ:               | 18          | 0    | 9    | 0           | 0    | 0    | 0          | 13   | 4    | 0          | 33   | 21   |

Note: Queue reported is the number of cars per lane.

BART

Level Of Service Computation Report  
 2000 HCM Operations (Future Volume Alternative)  
 AM - Bkgrd + Proj Conditions

Intersection #5332: CENTRAL EXPWY/SCOTT BLVD [Study Int 28]

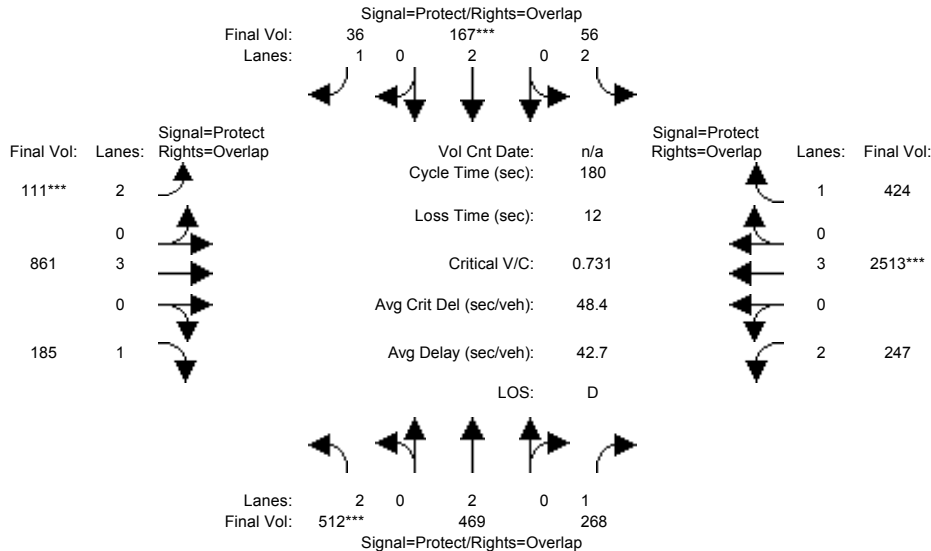

| Approach:                 | North Bound |      |      | South Bound |      |      | East Bound |      |       | West Bound |      |       |
|---------------------------|-------------|------|------|-------------|------|------|------------|------|-------|------------|------|-------|
| Movement:                 | L           | T    | R    | L           | T    | R    | L          | T    | R     | L          | T    | R     |
| Min. Green:               | 14          | 10   | 10   | 14          | 10   | 10   | 14         | 10   | 10    | 14         | 90   | 10    |
| Y+R:                      | 4.0         | 4.0  | 4.0  | 4.0         | 4.0  | 4.0  | 4.0        | 4.0  | 4.0   | 4.0        | 4.0  | 4.0   |
| Volume Module:            |             |      |      |             |      |      |            |      |       |            |      |       |
| Base Vol:                 | 512         | 469  | 268  | 56          | 167  | 36   | 111        | 861  | 185   | 247        | 2513 | 424   |
| Growth Adj:               | 1.00        | 1.00 | 1.00 | 1.00        | 1.00 | 1.00 | 1.00       | 1.00 | 1.00  | 1.00       | 1.00 | 1.00  |
| Initial Bse:              | 512         | 469  | 268  | 56          | 167  | 36   | 111        | 861  | 185   | 247        | 2513 | 424   |
| Added Vol:                | 0           | 0    | 0    | 0           | 0    | 0    | 0          | 0    | 0     | 0          | 0    | 0     |
| PasserByVol:              | 0           | 0    | 0    | 0           | 0    | 0    | 0          | 0    | 0     | 0          | 0    | 0     |
| Initial Fut:              | 512         | 469  | 268  | 56          | 167  | 36   | 111        | 861  | 185   | 247        | 2513 | 424   |
| User Adj:                 | 1.00        | 1.00 | 1.00 | 1.00        | 1.00 | 1.00 | 1.00       | 1.00 | 1.00  | 1.00       | 1.00 | 1.00  |
| PHF Adj:                  | 1.00        | 1.00 | 1.00 | 1.00        | 1.00 | 1.00 | 1.00       | 1.00 | 1.00  | 1.00       | 1.00 | 1.00  |
| PHF Volume:               | 512         | 469  | 268  | 56          | 167  | 36   | 111        | 861  | 185   | 247        | 2513 | 424   |
| Reduct Vol:               | 0           | 0    | 0    | 0           | 0    | 0    | 0          | 0    | 0     | 0          | 0    | 0     |
| Reduced Vol:              | 512         | 469  | 268  | 56          | 167  | 36   | 111        | 861  | 185   | 247        | 2513 | 424   |
| PCE Adj:                  | 1.00        | 1.00 | 1.00 | 1.00        | 1.00 | 1.00 | 1.00       | 1.00 | 1.00  | 1.00       | 1.00 | 1.00  |
| MLF Adj:                  | 1.00        | 1.00 | 1.00 | 1.00        | 1.00 | 1.00 | 1.00       | 1.00 | 1.00  | 1.00       | 1.00 | 1.00  |
| Final Volume:             | 512         | 469  | 268  | 56          | 167  | 36   | 111        | 861  | 185   | 247        | 2513 | 424   |
| Saturation Flow Module:   |             |      |      |             |      |      |            |      |       |            |      |       |
| Sat/Lane:                 | 1900        | 1900 | 1900 | 1900        | 1900 | 1900 | 1900       | 1900 | 1900  | 1900       | 1900 | 1900  |
| Adjustment:               | 0.83        | 1.00 | 0.92 | 0.83        | 1.00 | 0.92 | 0.83       | 1.00 | 0.92  | 0.83       | 1.00 | 0.92  |
| Lanes:                    | 2.00        | 2.00 | 1.00 | 2.00        | 2.00 | 1.00 | 2.00       | 3.00 | 1.00  | 2.00       | 3.00 | 1.00  |
| Final Sat.:               | 3150        | 3800 | 1750 | 3150        | 3800 | 1750 | 3150       | 5700 | 1750  | 3150       | 5700 | 1750  |
| Capacity Analysis Module: |             |      |      |             |      |      |            |      |       |            |      |       |
| Vol/Sat:                  | 0.16        | 0.12 | 0.15 | 0.02        | 0.04 | 0.02 | 0.04       | 0.15 | 0.11  | 0.08       | 0.44 | 0.24  |
| Crit Moves:               | ****        |      |      | ****        |      |      | ****       |      |       | ****       |      |       |
| Green Time:               | 38.7        | 30.1 | 70.8 | 19.0        | 10.5 | 24.5 | 14.0       | 78.3 | 116.9 | 40.6       | 105  | 123.9 |
| Volume/Cap:               | 0.76        | 0.74 | 0.39 | 0.17        | 0.76 | 0.15 | 0.45       | 0.35 | 0.16  | 0.35       | 0.76 | 0.35  |
| Delay/Veh:                | 71.2        | 75.7 | 39.5 | 73.6        | 97.5 | 68.9 | 76.2       | 16.6 | 0.1   | 60.0       | 39.2 | 18.8  |
| User DelAdj:              | 1.00        | 1.00 | 1.00 | 1.00        | 1.00 | 1.00 | 1.00       | 1.00 | 1.00  | 1.00       | 1.00 | 1.00  |
| AdjDel/Veh:               | 71.2        | 75.7 | 39.5 | 73.6        | 97.5 | 68.9 | 76.2       | 16.6 | 0.1   | 60.0       | 39.2 | 18.8  |
| LOS by Move:              | E           | E    | D    | E           | F    | E    | E          | B    | A     | E          | D    | B     |
| HCM2k95thQ:               | 29          | 23   | 23   | 3           | 9    | 4    | 8          | 11   | 0     | 13         | 60   | 27    |

Note: Queue reported is the number of cars per lane.

BART

Level Of Service Computation Report  
 2000 HCM Operations (Future Volume Alternative)  
 PM - Bkgrd + Proj Conditions

Intersection #5332: CENTRAL EXPWY/SCOTT BLVD [Study Int 28]

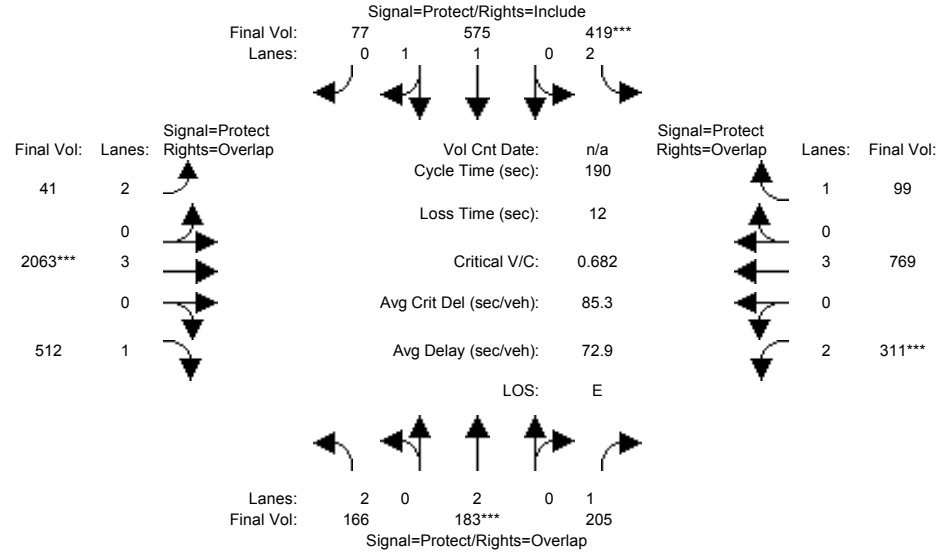

| Approach:                 | North Bound |      |      | South Bound |      |       | East Bound |      |       | West Bound |      |       |
|---------------------------|-------------|------|------|-------------|------|-------|------------|------|-------|------------|------|-------|
| Movement:                 | L           | T    | R    | L           | T    | R     | L          | T    | R     | L          | T    | R     |
| Min. Green:               | 28          | 42   | 42   | 20          | 34   | 34    | 19         | 105  | 105   | 23         | 109  | 109   |
| Y+R:                      | 4.0         | 4.0  | 4.0  | 4.0         | 4.0  | 4.0   | 4.0        | 4.0  | 4.0   | 4.0        | 4.0  | 4.0   |
| Volume Module:            |             |      |      |             |      |       |            |      |       |            |      |       |
| Base Vol:                 | 166         | 183  | 205  | 419         | 575  | 77    | 41         | 2063 | 512   | 311        | 769  | 99    |
| Growth Adj:               | 1.00        | 1.00 | 1.00 | 1.00        | 1.00 | 1.00  | 1.00       | 1.00 | 1.00  | 1.00       | 1.00 | 1.00  |
| Initial Bse:              | 166         | 183  | 205  | 419         | 575  | 77    | 41         | 2063 | 512   | 311        | 769  | 99    |
| Added Vol:                | 0           | 0    | 0    | 0           | 0    | 0     | 0          | 0    | 0     | 0          | 0    | 0     |
| PasserByVol:              | 0           | 0    | 0    | 0           | 0    | 0     | 0          | 0    | 0     | 0          | 0    | 0     |
| Initial Fut:              | 166         | 183  | 205  | 419         | 575  | 77    | 41         | 2063 | 512   | 311        | 769  | 99    |
| User Adj:                 | 1.00        | 1.00 | 1.00 | 1.00        | 1.00 | 1.00  | 1.00       | 1.00 | 1.00  | 1.00       | 1.00 | 1.00  |
| PHF Adj:                  | 1.00        | 1.00 | 1.00 | 1.00        | 1.00 | 1.00  | 1.00       | 1.00 | 1.00  | 1.00       | 1.00 | 1.00  |
| PHF Volume:               | 166         | 183  | 205  | 419         | 575  | 77    | 41         | 2063 | 512   | 311        | 769  | 99    |
| Reduct Vol:               | 0           | 0    | 0    | 0           | 0    | 0     | 0          | 0    | 0     | 0          | 0    | 0     |
| Reduced Vol:              | 166         | 183  | 205  | 419         | 575  | 77    | 41         | 2063 | 512   | 311        | 769  | 99    |
| PCE Adj:                  | 1.00        | 1.00 | 1.00 | 1.00        | 1.00 | 1.00  | 1.00       | 1.00 | 1.00  | 1.00       | 1.00 | 1.00  |
| MLF Adj:                  | 1.00        | 1.00 | 1.00 | 1.00        | 1.00 | 1.00  | 1.00       | 1.00 | 1.00  | 1.00       | 1.00 | 1.00  |
| Final Volume:             | 166         | 183  | 205  | 419         | 575  | 77    | 41         | 2063 | 512   | 311        | 769  | 99    |
| Saturation Flow Module:   |             |      |      |             |      |       |            |      |       |            |      |       |
| Sat/Lane:                 | 1900        | 1900 | 1900 | 1900        | 1900 | 1900  | 1900       | 1900 | 1900  | 1900       | 1900 | 1900  |
| Adjustment:               | 0.83        | 1.00 | 0.92 | 0.83        | 0.98 | 0.95  | 0.83       | 1.00 | 0.92  | 0.83       | 1.00 | 0.92  |
| Lanes:                    | 2.00        | 2.00 | 1.00 | 2.00        | 1.76 | 0.24  | 2.00       | 3.00 | 1.00  | 2.00       | 3.00 | 1.00  |
| Final Sat.:               | 3150        | 3800 | 1750 | 3150        | 3263 | 437   | 3150       | 5700 | 1750  | 3150       | 5700 | 1750  |
| Capacity Analysis Module: |             |      |      |             |      |       |            |      |       |            |      |       |
| Vol/Sat:                  | 0.05        | 0.05 | 0.12 | 0.13        | 0.18 | 0.18  | 0.01       | 0.36 | 0.29  | 0.10       | 0.13 | 0.06  |
| Crit Moves:               | ****        | **** | **** | ****        | **** | ****  | ****       | **** | ****  | ****       | **** | ****  |
| Green Time:               | 26.3        | 39.5 | 61.1 | 18.8        | 32.0 | 32.0  | 17.9       | 98.8 | 125.1 | 21.6       | 103  | 121.3 |
| Volume/Cap:               | 0.38        | 0.23 | 0.36 | 1.34        | 1.05 | 1.05  | 0.14       | 0.70 | 0.44  | 0.87       | 0.25 | 0.09  |
| Delay/Veh:                | 79.7        | 66.7 | 53.0 | 265.5       | 133  | 133.0 | 84.2       | 46.9 | 25.7  | 107.5      | 17.4 | 6.6   |
| User DelAdj:              | 1.00        | 1.00 | 1.00 | 1.00        | 1.00 | 1.00  | 1.00       | 1.00 | 1.00  | 1.00       | 1.00 | 1.00  |
| AdjDel/Veh:               | 79.7        | 66.7 | 53.0 | 265.5       | 133  | 133.0 | 84.2       | 46.9 | 25.7  | 107.5      | 17.4 | 6.6   |
| LOS by Move:              | E           | E    | D    | F           | F    | F     | F          | D    | C     | F          | B    | A     |
| HCM2k95thQ:               | 11          | 9    | 19   | 39          | 41   | 41    | 3          | 56   | 38    | 22         | 10   | 2     |

Note: Queue reported is the number of cars per lane.

BART

Level Of Service Computation Report  
2000 HCM Operations (Future Volume Alternative)  
AM - Bkgrd + Proj Conditions

Intersection #5334: CENTRAL EXPWY/LAFAYETTE ST [Study Int 29]

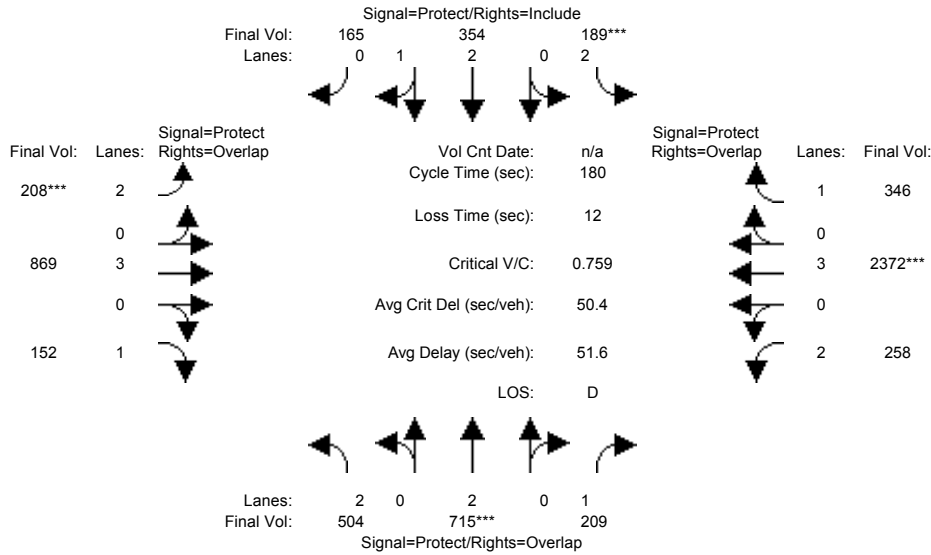

| Approach:                 | North Bound |      |      | South Bound |      |      | East Bound |      |       | West Bound |      |       |
|---------------------------|-------------|------|------|-------------|------|------|------------|------|-------|------------|------|-------|
| Movement:                 | L           | T    | R    | L           | T    | R    | L          | T    | R     | L          | T    | R     |
| Min. Green:               | 14          | 10   | 10   | 14          | 10   | 10   | 14         | 10   | 10    | 14         | 90   | 10    |
| Y+R:                      | 4.0         | 4.0  | 4.0  | 4.0         | 4.0  | 4.0  | 4.0        | 4.0  | 4.0   | 4.0        | 4.0  | 4.0   |
| Volume Module:            |             |      |      |             |      |      |            |      |       |            |      |       |
| Base Vol:                 | 504         | 715  | 209  | 189         | 354  | 165  | 208        | 869  | 152   | 258        | 2372 | 346   |
| Growth Adj:               | 1.00        | 1.00 | 1.00 | 1.00        | 1.00 | 1.00 | 1.00       | 1.00 | 1.00  | 1.00       | 1.00 | 1.00  |
| Initial Bse:              | 504         | 715  | 209  | 189         | 354  | 165  | 208        | 869  | 152   | 258        | 2372 | 346   |
| Added Vol:                | 0           | 0    | 0    | 0           | 0    | 0    | 0          | 0    | 0     | 0          | 0    | 0     |
| PasserByVol:              | 0           | 0    | 0    | 0           | 0    | 0    | 0          | 0    | 0     | 0          | 0    | 0     |
| Initial Fut:              | 504         | 715  | 209  | 189         | 354  | 165  | 208        | 869  | 152   | 258        | 2372 | 346   |
| User Adj:                 | 1.00        | 1.00 | 1.00 | 1.00        | 1.00 | 1.00 | 1.00       | 1.00 | 1.00  | 1.00       | 1.00 | 1.00  |
| PHF Adj:                  | 1.00        | 1.00 | 1.00 | 1.00        | 1.00 | 1.00 | 1.00       | 1.00 | 1.00  | 1.00       | 1.00 | 1.00  |
| PHF Volume:               | 504         | 715  | 209  | 189         | 354  | 165  | 208        | 869  | 152   | 258        | 2372 | 346   |
| Reduct Vol:               | 0           | 0    | 0    | 0           | 0    | 0    | 0          | 0    | 0     | 0          | 0    | 0     |
| Reduced Vol:              | 504         | 715  | 209  | 189         | 354  | 165  | 208        | 869  | 152   | 258        | 2372 | 346   |
| PCE Adj:                  | 1.00        | 1.00 | 1.00 | 1.00        | 1.00 | 1.00 | 1.00       | 1.00 | 1.00  | 1.00       | 1.00 | 1.00  |
| MLF Adj:                  | 1.00        | 1.00 | 1.00 | 1.00        | 1.00 | 1.00 | 1.00       | 1.00 | 1.00  | 1.00       | 1.00 | 1.00  |
| Final Volume:             | 504         | 715  | 209  | 189         | 354  | 165  | 208        | 869  | 152   | 258        | 2372 | 346   |
| Saturation Flow Module:   |             |      |      |             |      |      |            |      |       |            |      |       |
| Sat/Lane:                 | 1900        | 1900 | 1900 | 1900        | 1900 | 1900 | 1900       | 1900 | 1900  | 1900       | 1900 | 1900  |
| Adjustment:               | 1.00        | 1.00 | 1.00 | 1.00        | 1.00 | 1.00 | 1.00       | 0.85 | 1.00  | 1.00       | 1.00 | 1.00  |
| Lanes:                    | 2.00        | 2.00 | 1.00 | 2.00        | 2.05 | 0.95 | 2.00       | 3.00 | 1.00  | 2.00       | 3.00 | 1.00  |
| Final Sat.:               | 3800        | 3800 | 1900 | 3800        | 3888 | 1812 | 3800       | 4845 | 1900  | 3800       | 5700 | 1900  |
| Capacity Analysis Module: |             |      |      |             |      |      |            |      |       |            |      |       |
| Vol/Sat:                  | 0.13        | 0.19 | 0.11 | 0.05        | 0.09 | 0.09 | 0.05       | 0.18 | 0.08  | 0.07       | 0.42 | 0.18  |
| Crit Moves:               | ****        | **** | **** | ****        | **** | **** | ****       | **** | ****  | ****       | **** | ****  |
| Green Time:               | 34.1        | 43.6 | 77.0 | 14.0        | 23.4 | 23.4 | 14.0       | 77.0 | 111.2 | 33.4       | 96.4 | 110.4 |
| Volume/Cap:               | 0.70        | 0.78 | 0.26 | 0.64        | 0.70 | 0.70 | 0.70       | 0.42 | 0.13  | 0.37       | 0.78 | 0.30  |
| Delay/Veh:                | 81.8        | 81.5 | 49.8 | 89.7        | 85.4 | 85.4 | 88.4       | 36.0 | 14.4  | 64.4       | 34.6 | 16.6  |
| User DelAdj:              | 1.00        | 1.00 | 1.00 | 1.00        | 1.00 | 1.00 | 1.00       | 1.00 | 1.00  | 1.00       | 1.00 | 1.00  |
| AdjDel/Veh:               | 81.8        | 81.5 | 49.8 | 89.7        | 85.4 | 85.4 | 88.4       | 36.0 | 14.4  | 64.4       | 34.6 | 16.6  |
| LOS by Move:              | F           | F    | D    | F           | F    | F    | F          | D    | B     | E          | C    | B     |
| HCM2k95thQ:               | 24          | 33   | 18   | 10          | 18   | 18   | 11         | 20   | 7     | 12         | 60   | 22    |

Note: Queue reported is the number of cars per lane.

BART

Level Of Service Computation Report  
 2000 HCM Operations (Future Volume Alternative)  
 PM - Bkgrd + Proj Conditions

Intersection #5334: CENTRAL EXPWY/LAFAYETTE ST [Study Int 29]

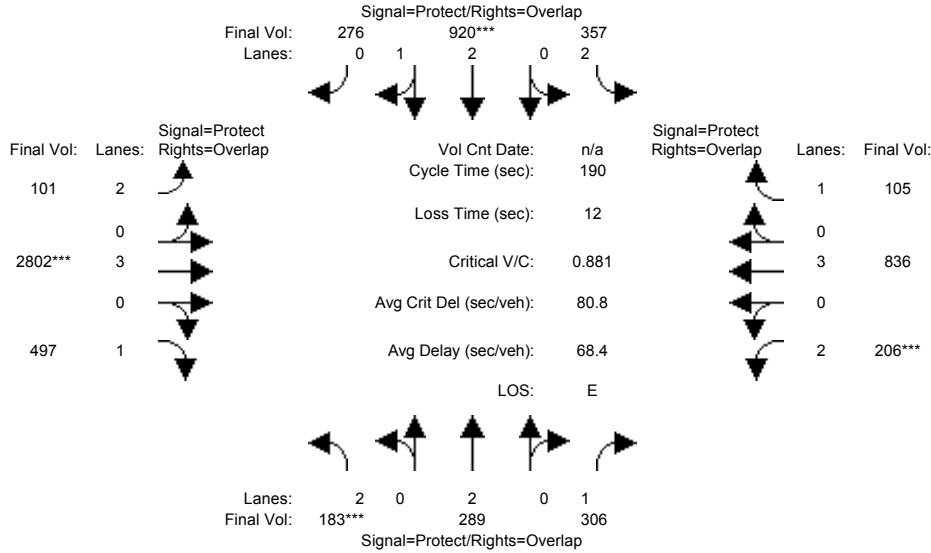

| Approach:                 | North Bound |      |      | South Bound |      |      | East Bound |      |       | West Bound |      |       |
|---------------------------|-------------|------|------|-------------|------|------|------------|------|-------|------------|------|-------|
| Movement:                 | L           | T    | R    | L           | T    | R    | L          | T    | R     | L          | T    | R     |
| Min. Green:               | 18          | 35   | 35   | 23          | 39   | 39   | 19         | 112  | 112   | 21         | 113  | 113   |
| Y+R:                      | 4.0         | 4.0  | 4.0  | 4.0         | 4.0  | 4.0  | 4.0        | 4.0  | 4.0   | 4.0        | 4.0  | 4.0   |
| Volume Module:            |             |      |      |             |      |      |            |      |       |            |      |       |
| Base Vol:                 | 183         | 289  | 306  | 357         | 920  | 276  | 101        | 2802 | 497   | 206        | 836  | 105   |
| Growth Adj:               | 1.00        | 1.00 | 1.00 | 1.00        | 1.00 | 1.00 | 1.00       | 1.00 | 1.00  | 1.00       | 1.00 | 1.00  |
| Initial Bse:              | 183         | 289  | 306  | 357         | 920  | 276  | 101        | 2802 | 497   | 206        | 836  | 105   |
| Added Vol:                | 0           | 0    | 0    | 0           | 0    | 0    | 0          | 0    | 0     | 0          | 0    | 0     |
| PasserByVol:              | 0           | 0    | 0    | 0           | 0    | 0    | 0          | 0    | 0     | 0          | 0    | 0     |
| Initial Fut:              | 183         | 289  | 306  | 357         | 920  | 276  | 101        | 2802 | 497   | 206        | 836  | 105   |
| User Adj:                 | 1.00        | 1.00 | 1.00 | 1.00        | 1.00 | 1.00 | 1.00       | 1.00 | 1.00  | 1.00       | 1.00 | 1.00  |
| PHF Adj:                  | 1.00        | 1.00 | 1.00 | 1.00        | 1.00 | 1.00 | 1.00       | 1.00 | 1.00  | 1.00       | 1.00 | 1.00  |
| PHF Volume:               | 183         | 289  | 306  | 357         | 920  | 276  | 101        | 2802 | 497   | 206        | 836  | 105   |
| Reduct Vol:               | 0           | 0    | 0    | 0           | 0    | 0    | 0          | 0    | 0     | 0          | 0    | 0     |
| Reduced Vol:              | 183         | 289  | 306  | 357         | 920  | 276  | 101        | 2802 | 497   | 206        | 836  | 105   |
| PCE Adj:                  | 1.00        | 1.00 | 1.00 | 1.00        | 1.00 | 1.00 | 1.00       | 1.00 | 1.00  | 1.00       | 1.00 | 1.00  |
| MLF Adj:                  | 1.00        | 1.00 | 1.00 | 1.00        | 1.00 | 1.00 | 1.00       | 1.00 | 1.00  | 1.00       | 1.00 | 1.00  |
| Final Volume:             | 183         | 289  | 306  | 357         | 920  | 276  | 101        | 2802 | 497   | 206        | 836  | 105   |
| Saturation Flow Module:   |             |      |      |             |      |      |            |      |       |            |      |       |
| Sat/Lane:                 | 1900        | 1900 | 1900 | 1900        | 1900 | 1900 | 1900       | 1900 | 1900  | 1900       | 1900 | 1900  |
| Adjustment:               | 0.83        | 1.00 | 0.92 | 0.83        | 0.99 | 0.95 | 0.83       | 1.00 | 0.92  | 0.83       | 1.00 | 0.92  |
| Lanes:                    | 2.00        | 2.00 | 1.00 | 2.00        | 2.28 | 0.72 | 2.00       | 3.00 | 1.00  | 2.00       | 3.00 | 1.00  |
| Final Sat.:               | 3150        | 3800 | 1750 | 3150        | 4306 | 1292 | 3150       | 5700 | 1750  | 3150       | 5700 | 1750  |
| Capacity Analysis Module: |             |      |      |             |      |      |            |      |       |            |      |       |
| Vol/Sat:                  | 0.06        | 0.08 | 0.17 | 0.11        | 0.21 | 0.21 | 0.03       | 0.49 | 0.28  | 0.07       | 0.15 | 0.06  |
| Crit Moves:               | ****        |      |      | ****        |      |      | ****       |      |       | ****       |      |       |
| Green Time:               | 16.8        | 32.8 | 52.4 | 21.5        | 37.4 | 55.4 | 17.9       | 105  | 121.7 | 19.7       | 107  | 128.1 |
| Volume/Cap:               | 0.66        | 0.44 | 0.63 | 1.00        | 1.08 | 0.73 | 0.34       | 0.89 | 0.44  | 0.63       | 0.26 | 0.09  |
| Delay/Veh:                | 95.0        | 75.7 | 67.3 | 137.7       | 134  | 66.6 | 86.7       | 56.2 | 27.5  | 91.3       | 23.0 | 11.5  |
| User DelAdj:              | 1.00        | 1.00 | 1.00 | 1.00        | 1.00 | 1.00 | 1.00       | 1.00 | 1.00  | 1.00       | 1.00 | 1.00  |
| AdjDel/Veh:               | 95.0        | 75.7 | 67.3 | 137.7       | 134  | 66.6 | 86.7       | 56.2 | 27.5  | 91.3       | 23.0 | 11.5  |
| LOS by Move:              | F           | E    | E    | F           | F    | E    | F          | E    | C     | F          | C    | B     |
| HCM2k95thQ:               | 13          | 15   | 31   | 27          | 50   | 38   | 7          | 83   | 37    | 14         | 16   | 5     |

Note: Queue reported is the number of cars per lane.

BART

Level Of Service Computation Report  
 2000 HCM Operations (Future Volume Alternative)  
 AM - Bkgrd + Proj Conditions

Intersection #5335: CENTRAL EXPWY/DE LA CRUZ BLVD [Study Int 30]

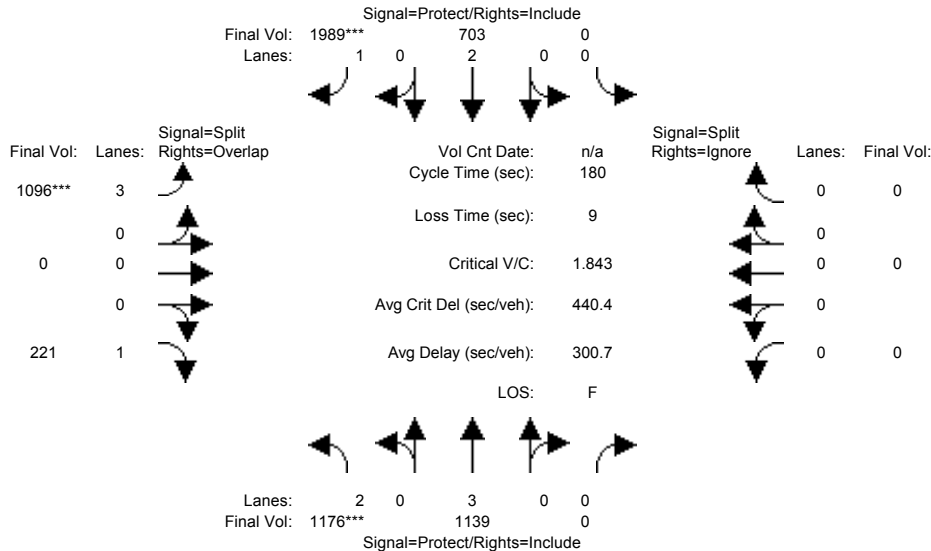

| Approach:                 | North Bound |      |      | South Bound |      |       | East Bound |      |      | West Bound |      |      |
|---------------------------|-------------|------|------|-------------|------|-------|------------|------|------|------------|------|------|
| Movement:                 | L           | T    | R    | L           | T    | R     | L          | T    | R    | L          | T    | R    |
| Min. Green:               | 7           | 10   | 0    | 0           | 10   | 10    | 10         | 0    | 10   | 0          | 0    | 0    |
| Y+R:                      | 4.0         | 4.0  | 4.0  | 4.0         | 4.0  | 4.0   | 4.0        | 4.0  | 4.0  | 4.0        | 4.0  | 4.0  |
| Volume Module:            |             |      |      |             |      |       |            |      |      |            |      |      |
| Base Vol:                 | 1176        | 1139 | 0    | 0           | 703  | 1989  | 1096       | 0    | 221  | 0          | 0    | 0    |
| Growth Adj:               | 1.00        | 1.00 | 1.00 | 1.00        | 1.00 | 1.00  | 1.00       | 1.00 | 1.00 | 1.00       | 1.00 | 1.00 |
| Initial Bse:              | 1176        | 1139 | 0    | 0           | 703  | 1989  | 1096       | 0    | 221  | 0          | 0    | 0    |
| Added Vol:                | 0           | 0    | 0    | 0           | 0    | 0     | 0          | 0    | 0    | 0          | 0    | 0    |
| PasserByVol:              | 0           | 0    | 0    | 0           | 0    | 0     | 0          | 0    | 0    | 0          | 0    | 0    |
| Initial Fut:              | 1176        | 1139 | 0    | 0           | 703  | 1989  | 1096       | 0    | 221  | 0          | 0    | 0    |
| User Adj:                 | 1.00        | 1.00 | 1.00 | 1.00        | 1.00 | 1.00  | 1.00       | 1.00 | 1.00 | 1.00       | 1.00 | 0.00 |
| PHF Adj:                  | 1.00        | 1.00 | 1.00 | 1.00        | 1.00 | 1.00  | 1.00       | 1.00 | 1.00 | 1.00       | 1.00 | 0.00 |
| PHF Volume:               | 1176        | 1139 | 0    | 0           | 703  | 1989  | 1096       | 0    | 221  | 0          | 0    | 0    |
| Reduct Vol:               | 0           | 0    | 0    | 0           | 0    | 0     | 0          | 0    | 0    | 0          | 0    | 0    |
| Reduced Vol:              | 1176        | 1139 | 0    | 0           | 703  | 1989  | 1096       | 0    | 221  | 0          | 0    | 0    |
| PCE Adj:                  | 1.00        | 1.00 | 1.00 | 1.00        | 1.00 | 1.00  | 1.00       | 1.00 | 1.00 | 1.00       | 1.00 | 0.00 |
| MLF Adj:                  | 1.00        | 1.00 | 1.00 | 1.00        | 1.00 | 1.00  | 1.00       | 1.00 | 1.00 | 1.00       | 1.00 | 0.00 |
| Final Volume:             | 1176        | 1139 | 0    | 0           | 703  | 1989  | 1096       | 0    | 221  | 0          | 0    | 0    |
| Saturation Flow Module:   |             |      |      |             |      |       |            |      |      |            |      |      |
| Sat/Lane:                 | 1900        | 1900 | 1900 | 1900        | 1900 | 1900  | 1900       | 1900 | 1900 | 1900       | 1900 | 1900 |
| Adjustment:               | 0.83        | 1.00 | 0.92 | 0.92        | 1.00 | 0.92  | 0.80       | 1.00 | 0.92 | 0.92       | 1.00 | 0.92 |
| Lanes:                    | 2.00        | 3.00 | 0.00 | 0.00        | 2.00 | 1.00  | 3.00       | 0.00 | 1.00 | 0.00       | 0.00 | 0.00 |
| Final Sat.:               | 3150        | 5700 | 0    | 0           | 3800 | 1750  | 4551       | 0    | 1750 | 0          | 0    | 0    |
| Capacity Analysis Module: |             |      |      |             |      |       |            |      |      |            |      |      |
| Vol/Sat:                  | 0.37        | 0.20 | 0.00 | 0.00        | 0.19 | 1.14  | 0.24       | 0.00 | 0.13 | 0.00       | 0.00 | 0.00 |
| Crit Moves:               | ****        |      |      |             | **** | ****  |            |      |      |            |      |      |
| Green Time:               | 36.5        | 147  | 0.0  | 0.0         | 111  | 111.0 | 23.5       | 0.0  | 60.0 | 0.0        | 0.0  | 0.0  |
| Volume/Cap:               | 1.84        | 0.24 | 0.00 | 0.00        | 0.30 | 1.84  | 1.84       | 0.00 | 0.38 | 0.00       | 0.00 | 0.00 |
| Delay/Veh:                | 457.1       | 3.7  | 0.0  | 0.0         | 16.3 | 417.4 | 464.0      | 0.0  | 44.3 | 0.0        | 0.0  | 0.0  |
| User DelAdj:              | 1.00        | 1.00 | 1.00 | 1.00        | 1.00 | 1.00  | 1.00       | 1.00 | 1.00 | 1.00       | 1.00 | 1.00 |
| AdjDel/Veh:               | 457.1       | 3.7  | 0.0  | 0.0         | 16.3 | 417.4 | 464.0      | 0.0  | 44.3 | 0.0        | 0.0  | 0.0  |
| LOS by Move:              | F           | A    | A    | A           | B    | F     | F          | A    | D    | A          | A    | A    |
| HCM2k95thQ:               | 117         | 9    | 0    | 0           | 16   | 351   | 77         | 0    | 16   | 0          | 0    | 0    |

Note: Queue reported is the number of cars per lane.

BART

Level Of Service Computation Report  
 2000 HCM Operations (Future Volume Alternative)  
 PM - Bkgrd + Proj Conditions

Intersection #5335: CENTRAL EXPWY/DE LA CRUZ BLVD [Study Int 30]

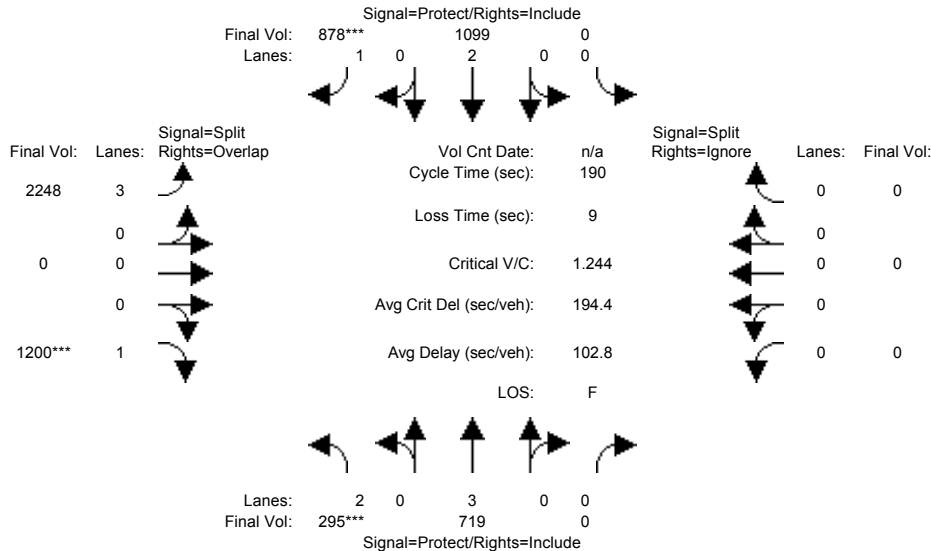

| Approach:                 | North Bound |      |      | South Bound |      |       | East Bound |      |       | West Bound |      |      |
|---------------------------|-------------|------|------|-------------|------|-------|------------|------|-------|------------|------|------|
| Movement:                 | L           | T    | R    | L           | T    | R     | L          | T    | R     | L          | T    | R    |
| Min. Green:               | 19          | 76   | 0    | 0           | 57   | 57    | 114        | 0    | 114   | 0          | 0    | 0    |
| Y+R:                      | 4.0         | 4.0  | 4.0  | 4.0         | 4.0  | 4.0   | 4.0        | 4.0  | 4.0   | 4.0        | 4.0  | 4.0  |
| Volume Module:            |             |      |      |             |      |       |            |      |       |            |      |      |
| Base Vol:                 | 295         | 719  | 0    | 0           | 1099 | 878   | 2248       | 0    | 1200  | 0          | 0    | 0    |
| Growth Adj:               | 1.00        | 1.00 | 1.00 | 1.00        | 1.00 | 1.00  | 1.00       | 1.00 | 1.00  | 1.00       | 1.00 | 1.00 |
| Initial Bse:              | 295         | 719  | 0    | 0           | 1099 | 878   | 2248       | 0    | 1200  | 0          | 0    | 0    |
| Added Vol:                | 0           | 0    | 0    | 0           | 0    | 0     | 0          | 0    | 0     | 0          | 0    | 0    |
| PasserByVol:              | 0           | 0    | 0    | 0           | 0    | 0     | 0          | 0    | 0     | 0          | 0    | 0    |
| Initial Fut:              | 295         | 719  | 0    | 0           | 1099 | 878   | 2248       | 0    | 1200  | 0          | 0    | 0    |
| User Adj:                 | 1.00        | 1.00 | 1.00 | 1.00        | 1.00 | 1.00  | 1.00       | 1.00 | 1.00  | 1.00       | 1.00 | 0.00 |
| PHF Adj:                  | 1.00        | 1.00 | 1.00 | 1.00        | 1.00 | 1.00  | 1.00       | 1.00 | 1.00  | 1.00       | 1.00 | 0.00 |
| PHF Volume:               | 295         | 719  | 0    | 0           | 1099 | 878   | 2248       | 0    | 1200  | 0          | 0    | 0    |
| Reduct Vol:               | 0           | 0    | 0    | 0           | 0    | 0     | 0          | 0    | 0     | 0          | 0    | 0    |
| Reduced Vol:              | 295         | 719  | 0    | 0           | 1099 | 878   | 2248       | 0    | 1200  | 0          | 0    | 0    |
| PCE Adj:                  | 1.00        | 1.00 | 1.00 | 1.00        | 1.00 | 1.00  | 1.00       | 1.00 | 1.00  | 1.00       | 1.00 | 0.00 |
| MLF Adj:                  | 1.00        | 1.00 | 1.00 | 1.00        | 1.00 | 1.00  | 1.00       | 1.00 | 1.00  | 1.00       | 1.00 | 0.00 |
| Final Volume:             | 295         | 719  | 0    | 0           | 1099 | 878   | 2248       | 0    | 1200  | 0          | 0    | 0    |
| Saturation Flow Module:   |             |      |      |             |      |       |            |      |       |            |      |      |
| Sat/Lane:                 | 1900        | 1900 | 1900 | 1900        | 1900 | 1900  | 1900       | 1900 | 1900  | 1900       | 1900 | 1900 |
| Adjustment:               | 0.83        | 1.00 | 0.92 | 0.92        | 1.00 | 0.92  | 0.80       | 1.00 | 0.92  | 0.92       | 1.00 | 0.92 |
| Lanes:                    | 2.00        | 3.00 | 0.00 | 0.00        | 2.00 | 1.00  | 3.00       | 0.00 | 1.00  | 0.00       | 0.00 | 0.00 |
| Final Sat.:               | 3150        | 5700 | 0    | 0           | 3800 | 1750  | 4551       | 0    | 1750  | 0          | 0    | 0    |
| Capacity Analysis Module: |             |      |      |             |      |       |            |      |       |            |      |      |
| Vol/Sat:                  | 0.09        | 0.13 | 0.00 | 0.00        | 0.29 | 0.50  | 0.49       | 0.00 | 0.69  | 0.00       | 0.00 | 0.00 |
| Crit Moves:               | ****        |      |      |             | **** | ****  | ****       |      | ****  |            |      |      |
| Green Time:               | 18.1        | 72.6 | 0.0  | 0.0         | 54.4 | 54.4  | 108.8      | 0.0  | 127.0 | 0.0        | 0.0  | 0.0  |
| Volume/Cap:               | 0.98        | 0.33 | 0.00 | 0.00        | 1.01 | 1.75  | 0.86       | 0.00 | 1.03  | 0.00       | 0.00 | 0.00 |
| Delay/Veh:                | 136.3       | 43.6 | 0.0  | 0.0         | 101  | 417.4 | 26.0       | 0.0  | 45.6  | 0.0        | 0.0  | 0.0  |
| User DelAdj:              | 1.00        | 1.00 | 1.00 | 1.00        | 1.00 | 1.00  | 1.00       | 1.00 | 1.00  | 1.00       | 1.00 | 1.00 |
| AdjDel/Veh:               | 136.3       | 43.6 | 0.0  | 0.0         | 101  | 417.4 | 26.0       | 0.0  | 45.6  | 0.0        | 0.0  | 0.0  |
| LOS by Move:              | F           | D    | A    | A           | F    | F     | C          | A    | D     | A          | A    | A    |
| HCM2k95thQ:               | 23          | 18   | 0    | 0           | 60   | 159   | 60         | 0    | 124   | 0          | 0    | 0    |

Note: Queue reported is the number of cars per lane.

BART

Level Of Service Computation Report  
 2000 HCM Operations (Future Volume Alternative)  
 AM - Bkgrd + Proj Conditions

Intersection #5416: SAN TOMAS EXPWY/EL CAMINO REAL [Study Int 41]

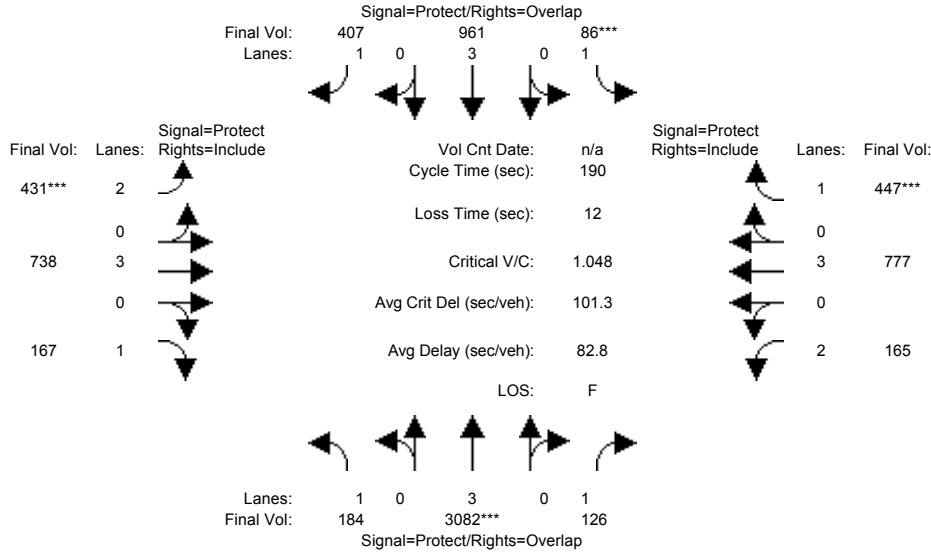

| Approach:                 | North Bound |      |       | South Bound |      |      | East Bound |      |      | West Bound |      |       |
|---------------------------|-------------|------|-------|-------------|------|------|------------|------|------|------------|------|-------|
| Movement:                 | L           | T    | R     | L           | T    | R    | L          | T    | R    | L          | T    | R     |
| Min. Green:               | 7           | 10   | 10    | 7           | 10   | 10   | 7          | 10   | 10   | 7          | 10   | 10    |
| Y+R:                      | 4.0         | 4.0  | 4.0   | 4.0         | 4.0  | 4.0  | 4.0        | 4.0  | 4.0  | 4.0        | 4.0  | 4.0   |
| Volume Module:            |             |      |       |             |      |      |            |      |      |            |      |       |
| Base Vol:                 | 184         | 3669 | 126   | 86          | 1144 | 407  | 431        | 738  | 167  | 165        | 777  | 447   |
| Growth Adj:               | 1.00        | 1.00 | 1.00  | 1.00        | 1.00 | 1.00 | 1.00       | 1.00 | 1.00 | 1.00       | 1.00 | 1.00  |
| Initial Bse:              | 184         | 3669 | 126   | 86          | 1144 | 407  | 431        | 738  | 167  | 165        | 777  | 447   |
| Added Vol:                | 0           | 0    | 0     | 0           | 0    | 0    | 0          | 0    | 0    | 0          | 0    | 0     |
| PasserByVol:              | 0           | 0    | 0     | 0           | 0    | 0    | 0          | 0    | 0    | 0          | 0    | 0     |
| Initial Fut:              | 184         | 3669 | 126   | 86          | 1144 | 407  | 431        | 738  | 167  | 165        | 777  | 447   |
| User Adj:                 | 1.00        | 0.84 | 1.00  | 1.00        | 0.84 | 1.00 | 1.00       | 1.00 | 1.00 | 1.00       | 1.00 | 1.00  |
| PHF Adj:                  | 1.00        | 1.00 | 1.00  | 1.00        | 1.00 | 1.00 | 1.00       | 1.00 | 1.00 | 1.00       | 1.00 | 1.00  |
| PHF Volume:               | 184         | 3082 | 126   | 86          | 961  | 407  | 431        | 738  | 167  | 165        | 777  | 447   |
| Reduct Vol:               | 0           | 0    | 0     | 0           | 0    | 0    | 0          | 0    | 0    | 0          | 0    | 0     |
| Reduced Vol:              | 184         | 3082 | 126   | 86          | 961  | 407  | 431        | 738  | 167  | 165        | 777  | 447   |
| PCE Adj:                  | 1.00        | 1.00 | 1.00  | 1.00        | 1.00 | 1.00 | 1.00       | 1.00 | 1.00 | 1.00       | 1.00 | 1.00  |
| MLF Adj:                  | 1.00        | 1.00 | 1.00  | 1.00        | 1.00 | 1.00 | 1.00       | 1.00 | 1.00 | 1.00       | 1.00 | 1.00  |
| Final Volume:             | 184         | 3082 | 126   | 86          | 961  | 407  | 431        | 738  | 167  | 165        | 777  | 447   |
| Saturation Flow Module:   |             |      |       |             |      |      |            |      |      |            |      |       |
| Sat/Lane:                 | 1900        | 1900 | 1900  | 1900        | 1900 | 1900 | 1900       | 1900 | 1900 | 1900       | 1900 | 1900  |
| Adjustment:               | 0.92        | 1.00 | 0.92  | 0.92        | 1.00 | 0.92 | 0.83       | 1.00 | 0.92 | 0.83       | 1.00 | 0.92  |
| Lanes:                    | 1.00        | 3.00 | 1.00  | 1.00        | 3.00 | 1.00 | 2.00       | 3.00 | 1.00 | 2.00       | 3.00 | 1.00  |
| Final Sat.:               | 1750        | 5700 | 1750  | 1750        | 5700 | 1750 | 3150       | 5700 | 1750 | 3150       | 5700 | 1750  |
| Capacity Analysis Module: |             |      |       |             |      |      |            |      |      |            |      |       |
| Vol/Sat:                  | 0.11        | 0.54 | 0.07  | 0.05        | 0.17 | 0.23 | 0.14       | 0.13 | 0.10 | 0.05       | 0.14 | 0.26  |
| Crit Moves:               | ****        | **** | ****  | ****        | **** | **** | ****       | **** | **** | ****       | **** | ****  |
| Green Time:               | 41.1        | 98.0 | 118.5 | 8.9         | 65.8 | 90.6 | 24.8       | 50.6 | 50.6 | 20.5       | 46.3 | 46.3  |
| Volume/Cap:               | 0.49        | 1.05 | 0.12  | 1.05        | 0.49 | 0.49 | 1.05       | 0.49 | 0.36 | 0.49       | 0.56 | 1.05  |
| Delay/Veh:                | 67.2        | 89.0 | 21.0  | 206.7       | 66.2 | 54.9 | 140.2      | 59.0 | 57.0 | 80.9       | 63.4 | 128.6 |
| User DelAdj:              | 1.00        | 1.00 | 1.00  | 1.00        | 1.00 | 1.00 | 1.00       | 1.00 | 1.00 | 1.00       | 1.00 | 1.00  |
| AdjDel/Veh:               | 67.2        | 89.0 | 21.0  | 206.7       | 66.2 | 54.9 | 140.2      | 59.0 | 57.0 | 80.9       | 63.4 | 128.6 |
| LOS by Move:              | E           | F    | C     | F           | E    | D    | F          | E    | E    | F          | E    | F     |
| HCM2k95thQ:               | 19          | 105  | 9     | 13          | 29   | 37   | 34         | 21   | 16   | 10         | 23   | 53    |

Note: Queue reported is the number of cars per lane.



BART

Level Of Service Computation Report  
 2000 HCM Operations (Future Volume Alternative)  
 PM - Bkgrd + Proj Conditions

Intersection #5416: SAN TOMAS EXPWY/EL CAMINO REAL [Study Int 41]

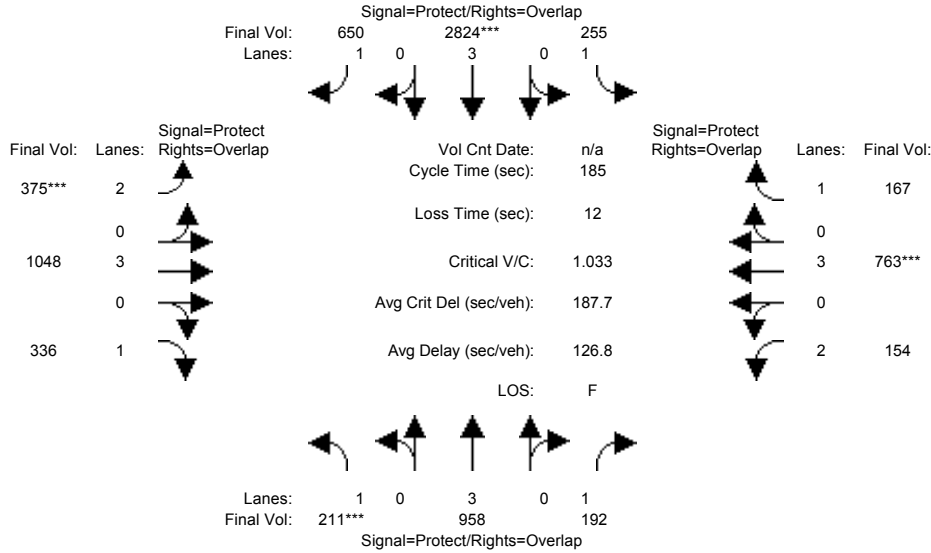

| Approach:                 | North Bound |      |      | South Bound |      |       | East Bound |      |      | West Bound |      |      |
|---------------------------|-------------|------|------|-------------|------|-------|------------|------|------|------------|------|------|
| Movement:                 | L           | T    | R    | L           | T    | R     | L          | T    | R    | L          | T    | R    |
| Min. Green:               | 12          | 72   | 72   | 33          | 93   | 93    | 39         | 50   | 50   | 29         | 41   | 41   |
| Y+R:                      | 4.0         | 4.0  | 4.0  | 4.0         | 4.0  | 4.0   | 4.0        | 4.0  | 4.0  | 4.0        | 4.0  | 4.0  |
| Volume Module:            |             |      |      |             |      |       |            |      |      |            |      |      |
| Base Vol:                 | 211         | 1261 | 192  | 255         | 3668 | 650   | 375        | 1048 | 336  | 154        | 763  | 167  |
| Growth Adj:               | 1.00        | 1.00 | 1.00 | 1.00        | 1.00 | 1.00  | 1.00       | 1.00 | 1.00 | 1.00       | 1.00 | 1.00 |
| Initial Bse:              | 211         | 1261 | 192  | 255         | 3668 | 650   | 375        | 1048 | 336  | 154        | 763  | 167  |
| Added Vol:                | 0           | 0    | 0    | 0           | 0    | 0     | 0          | 0    | 0    | 0          | 0    | 0    |
| PasserByVol:              | 0           | 0    | 0    | 0           | 0    | 0     | 0          | 0    | 0    | 0          | 0    | 0    |
| Initial Fut:              | 211         | 1261 | 192  | 255         | 3668 | 650   | 375        | 1048 | 336  | 154        | 763  | 167  |
| User Adj:                 | 1.00        | 0.76 | 1.00 | 1.00        | 0.77 | 1.00  | 1.00       | 1.00 | 1.00 | 1.00       | 1.00 | 1.00 |
| PHF Adj:                  | 1.00        | 1.00 | 1.00 | 1.00        | 1.00 | 1.00  | 1.00       | 1.00 | 1.00 | 1.00       | 1.00 | 1.00 |
| PHF Volume:               | 211         | 958  | 192  | 255         | 2824 | 650   | 375        | 1048 | 336  | 154        | 763  | 167  |
| Reduct Vol:               | 0           | 0    | 0    | 0           | 0    | 0     | 0          | 0    | 0    | 0          | 0    | 0    |
| Reduced Vol:              | 211         | 958  | 192  | 255         | 2824 | 650   | 375        | 1048 | 336  | 154        | 763  | 167  |
| PCE Adj:                  | 1.00        | 1.00 | 1.00 | 1.00        | 1.00 | 1.00  | 1.00       | 1.00 | 1.00 | 1.00       | 1.00 | 1.00 |
| MLF Adj:                  | 1.00        | 1.00 | 1.00 | 1.00        | 1.00 | 1.00  | 1.00       | 1.00 | 1.00 | 1.00       | 1.00 | 1.00 |
| Final Volume:             | 211         | 958  | 192  | 255         | 2824 | 650   | 375        | 1048 | 336  | 154        | 763  | 167  |
| Saturation Flow Module:   |             |      |      |             |      |       |            |      |      |            |      |      |
| Sat/Lane:                 | 1900        | 1900 | 1900 | 1900        | 1900 | 1900  | 1900       | 1900 | 1900 | 1900       | 1900 | 1900 |
| Adjustment:               | 0.92        | 1.00 | 0.92 | 0.92        | 0.83 | 0.92  | 0.83       | 1.00 | 0.92 | 0.83       | 1.00 | 0.92 |
| Lanes:                    | 1.00        | 3.00 | 1.00 | 1.00        | 3.00 | 1.00  | 2.00       | 3.00 | 1.00 | 2.00       | 3.00 | 1.00 |
| Final Sat.:               | 1750        | 5700 | 1750 | 1750        | 4731 | 1750  | 3150       | 5700 | 1750 | 3150       | 5700 | 1750 |
| Capacity Analysis Module: |             |      |      |             |      |       |            |      |      |            |      |      |
| Vol/Sat:                  | 0.12        | 0.17 | 0.11 | 0.15        | 0.60 | 0.37  | 0.12       | 0.18 | 0.19 | 0.05       | 0.13 | 0.10 |
| Crit Moves:               | ****        |      |      | ****        |      |       | ****       |      |      | ****       |      |      |
| Green Time:               | 11.3        | 67.6 | 95.2 | 31.0        | 87.3 | 124.0 | 36.6       | 47.5 | 58.8 | 27.6       | 38.5 | 69.5 |
| Volume/Cap:               | 1.98        | 0.46 | 0.21 | 0.87        | 1.26 | 0.55  | 0.60       | 0.72 | 0.60 | 0.33       | 0.64 | 0.25 |
| Delay/Veh:                | 565.0       | 53.0 | 32.9 | 113.9       | 206  | 40.7  | 73.6       | 68.3 | 58.6 | 75.4       | 72.5 | 42.7 |
| User DelAdj:              | 1.00        | 1.00 | 1.00 | 1.00        | 1.00 | 1.00  | 1.00       | 1.00 | 1.00 | 1.00       | 1.00 | 1.00 |
| AdjDel/Veh:               | 565.0       | 53.0 | 32.9 | 113.9       | 206  | 40.7  | 73.6       | 68.3 | 58.6 | 75.4       | 72.5 | 42.7 |
| LOS by Move:              | F           | D    | C    | F           | F    | D     | E          | E    | E    | E          | E    | D    |
| HCM2k95thQ:               | 45          | 27   | 16   | 30          | 121  | 57    | 23         | 33   | 31   | 9          | 25   | 14   |

Note: Queue reported is the number of cars per lane.

BART

Level Of Service Computation Report  
 2000 HCM Operations (Future Volume Alternative)  
 AM - Bkgrd + Proj Conditions

Intersection #5444: Lafayette/Lewis [Study Int 47]

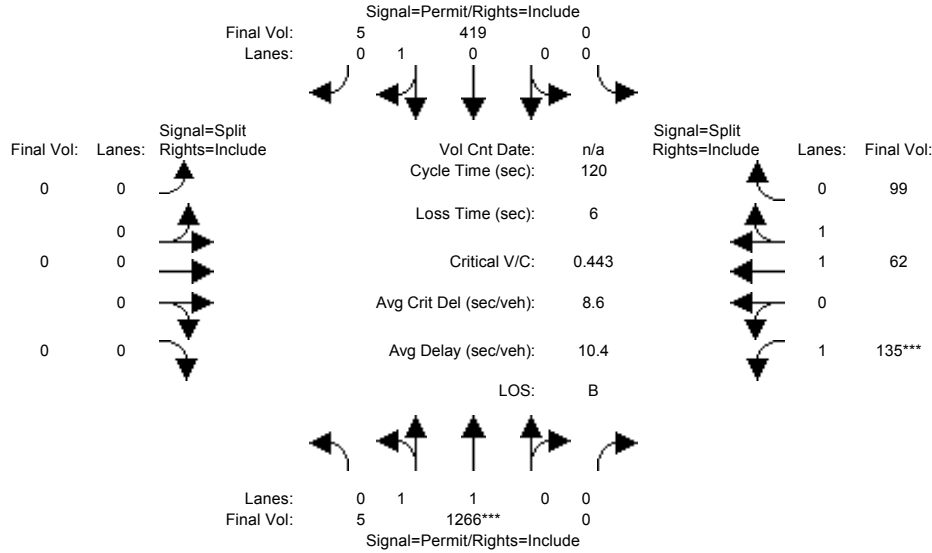

| Approach:                 | North Bound |      |      | South Bound |      |      | East Bound |      |      | West Bound |      |      |
|---------------------------|-------------|------|------|-------------|------|------|------------|------|------|------------|------|------|
| Movement:                 | L           | T    | R    | L           | T    | R    | L          | T    | R    | L          | T    | R    |
| Min. Green:               | 10          | 10   | 0    | 0           | 10   | 10   | 0          | 0    | 0    | 10         | 10   | 10   |
| Y+R:                      | 4.0         | 4.0  | 4.0  | 4.0         | 4.0  | 4.0  | 4.0        | 4.0  | 4.0  | 4.0        | 4.0  | 4.0  |
| Volume Module:            |             |      |      |             |      |      |            |      |      |            |      |      |
| Base Vol:                 | 5           | 1266 | 0    | 0           | 0    | 419  | 5          | 0    | 0    | 0          | 135  | 62   |
| Growth Adj:               | 1.00        | 1.00 | 1.00 | 1.00        | 1.00 | 1.00 | 1.00       | 1.00 | 1.00 | 1.00       | 1.00 | 1.00 |
| Initial Bse:              | 5           | 1266 | 0    | 0           | 0    | 419  | 5          | 0    | 0    | 0          | 135  | 62   |
| Added Vol:                | 0           | 0    | 0    | 0           | 0    | 0    | 0          | 0    | 0    | 0          | 0    | 0    |
| PasserByVol:              | 0           | 0    | 0    | 0           | 0    | 0    | 0          | 0    | 0    | 0          | 0    | 0    |
| Initial Fut:              | 5           | 1266 | 0    | 0           | 0    | 419  | 5          | 0    | 0    | 0          | 135  | 62   |
| User Adj:                 | 1.00        | 1.00 | 1.00 | 1.00        | 1.00 | 1.00 | 1.00       | 1.00 | 1.00 | 1.00       | 1.00 | 1.00 |
| PHF Adj:                  | 1.00        | 1.00 | 1.00 | 1.00        | 1.00 | 1.00 | 1.00       | 1.00 | 1.00 | 1.00       | 1.00 | 1.00 |
| PHF Volume:               | 5           | 1266 | 0    | 0           | 0    | 419  | 5          | 0    | 0    | 0          | 135  | 62   |
| Reduct Vol:               | 0           | 0    | 0    | 0           | 0    | 0    | 0          | 0    | 0    | 0          | 0    | 0    |
| Reduced Vol:              | 5           | 1266 | 0    | 0           | 0    | 419  | 5          | 0    | 0    | 0          | 135  | 62   |
| PCE Adj:                  | 1.00        | 1.00 | 1.00 | 1.00        | 1.00 | 1.00 | 1.00       | 1.00 | 1.00 | 1.00       | 1.00 | 1.00 |
| MLF Adj:                  | 1.00        | 1.00 | 1.00 | 1.00        | 1.00 | 1.00 | 1.00       | 1.00 | 1.00 | 1.00       | 1.00 | 1.00 |
| FinalVolume:              | 5           | 1266 | 0    | 0           | 0    | 419  | 5          | 0    | 0    | 0          | 135  | 62   |
| Saturation Flow Module:   |             |      |      |             |      |      |            |      |      |            |      |      |
| Sat/Lane:                 | 1900        | 1900 | 1900 | 1900        | 1900 | 1900 | 1900       | 1900 | 1900 | 1900       | 1900 | 1900 |
| Adjustment:               | 0.95        | 0.97 | 0.92 | 0.92        | 0.95 | 0.95 | 0.92       | 1.00 | 0.92 | 0.92       | 1.00 | 0.92 |
| Lanes:                    | 0.01        | 1.99 | 0.00 | 0.00        | 0.99 | 0.01 | 0.00       | 0.00 | 0.00 | 1.00       | 1.00 | 1.00 |
| Final Sat.:               | 15          | 3685 | 0    | 0           | 1779 | 21   | 0          | 0    | 0    | 1750       | 1900 | 1750 |
| Capacity Analysis Module: |             |      |      |             |      |      |            |      |      |            |      |      |
| Vol/Sat:                  | 0.34        | 0.34 | 0.00 | 0.00        | 0.24 | 0.24 | 0.00       | 0.00 | 0.00 | 0.08       | 0.03 | 0.06 |
| Crit Moves:               | ****        |      |      | ****        |      |      | ****       |      |      | ****       |      |      |
| Green Time:               | 93.1        | 93.1 | 0.0  | 0.0         | 93.1 | 93.1 | 0.0        | 0.0  | 0.0  | 20.9       | 20.9 | 20.9 |
| Volume/Cap:               | 0.44        | 0.44 | 0.00 | 0.00        | 0.30 | 0.30 | 0.00       | 0.00 | 0.00 | 0.44       | 0.19 | 0.32 |
| Delay/Veh:                | 4.7         | 4.7  | 0.0  | 0.0         | 4.1  | 4.1  | 0.0        | 0.0  | 0.0  | 45.4       | 42.4 | 43.8 |
| User DelAdj:              | 1.00        | 1.00 | 1.00 | 1.00        | 1.00 | 1.00 | 1.00       | 1.00 | 1.00 | 1.00       | 1.00 | 1.00 |
| AdjDel/Veh:               | 4.7         | 4.7  | 0.0  | 0.0         | 4.1  | 4.1  | 0.0        | 0.0  | 0.0  | 45.4       | 42.4 | 43.8 |
| LOS by Move:              | A           | A    | A    | A           | A    | A    | A          | A    | A    | D          | D    | D    |
| HCM2k95thQ:               | 15          | 15   | 0    | 0           | 9    | 9    | 0          | 0    | 0    | 10         | 4    | 7    |

Note: Queue reported is the number of cars per lane.

BART

Level Of Service Computation Report  
 2000 HCM Operations (Future Volume Alternative)  
 PM - Bkgrd + Proj Conditions

Intersection #5444: Lafayette/Lewis [Study Int 47]

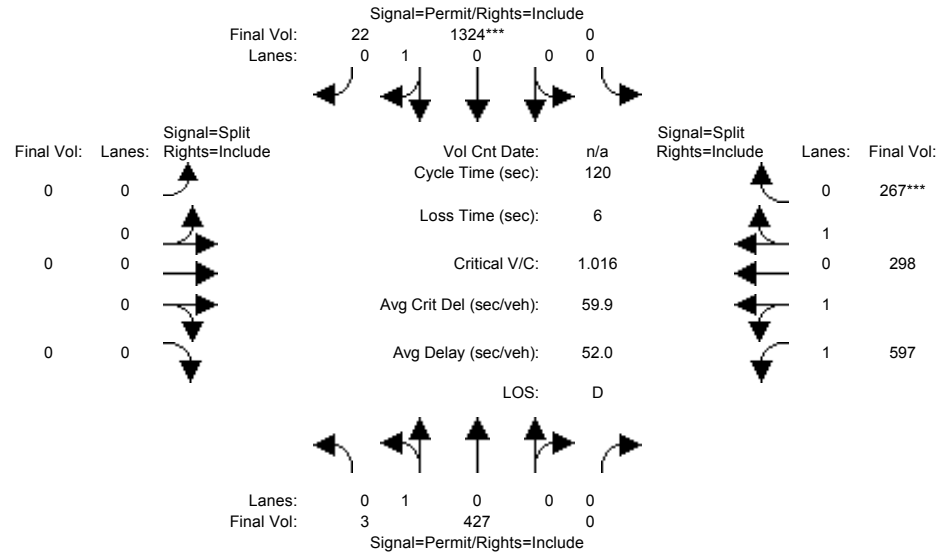

| Approach:                 | North Bound |      |      | South Bound |      |      | East Bound |      |      | West Bound |      |      |
|---------------------------|-------------|------|------|-------------|------|------|------------|------|------|------------|------|------|
| Movement:                 | L           | T    | R    | L           | T    | R    | L          | T    | R    | L          | T    | R    |
| Min. Green:               | 10          | 10   | 0    | 0           | 10   | 10   | 0          | 0    | 0    | 10         | 10   | 10   |
| Y+R:                      | 4.0         | 4.0  | 4.0  | 4.0         | 4.0  | 4.0  | 4.0        | 4.0  | 4.0  | 4.0        | 4.0  | 4.0  |
| Volume Module:            |             |      |      |             |      |      |            |      |      |            |      |      |
| Base Vol:                 | 3           | 427  | 0    | 0           | 1324 | 22   | 0          | 0    | 0    | 597        | 298  | 267  |
| Growth Adj:               | 1.00        | 1.00 | 1.00 | 1.00        | 1.00 | 1.00 | 1.00       | 1.00 | 1.00 | 1.00       | 1.00 | 1.00 |
| Initial Bse:              | 3           | 427  | 0    | 0           | 1324 | 22   | 0          | 0    | 0    | 597        | 298  | 267  |
| Added Vol:                | 0           | 0    | 0    | 0           | 0    | 0    | 0          | 0    | 0    | 0          | 0    | 0    |
| PasserByVol:              | 0           | 0    | 0    | 0           | 0    | 0    | 0          | 0    | 0    | 0          | 0    | 0    |
| Initial Fut:              | 3           | 427  | 0    | 0           | 1324 | 22   | 0          | 0    | 0    | 597        | 298  | 267  |
| User Adj:                 | 1.00        | 1.00 | 1.00 | 1.00        | 1.00 | 1.00 | 1.00       | 1.00 | 1.00 | 1.00       | 1.00 | 1.00 |
| PHF Adj:                  | 1.00        | 1.00 | 1.00 | 1.00        | 1.00 | 1.00 | 1.00       | 1.00 | 1.00 | 1.00       | 1.00 | 1.00 |
| PHF Volume:               | 3           | 427  | 0    | 0           | 1324 | 22   | 0          | 0    | 0    | 597        | 298  | 267  |
| Reduct Vol:               | 0           | 0    | 0    | 0           | 0    | 0    | 0          | 0    | 0    | 0          | 0    | 0    |
| Reduced Vol:              | 3           | 427  | 0    | 0           | 1324 | 22   | 0          | 0    | 0    | 597        | 298  | 267  |
| PCE Adj:                  | 1.00        | 1.00 | 1.00 | 1.00        | 1.00 | 1.00 | 1.00       | 1.00 | 1.00 | 1.00       | 1.00 | 1.00 |
| MLF Adj:                  | 1.00        | 1.00 | 1.00 | 1.00        | 1.00 | 1.00 | 1.00       | 1.00 | 1.00 | 1.00       | 1.00 | 1.00 |
| Final Volume:             | 3           | 427  | 0    | 0           | 1324 | 22   | 0          | 0    | 0    | 597        | 298  | 267  |
| Saturation Flow Module:   |             |      |      |             |      |      |            |      |      |            |      |      |
| Sat/Lane:                 | 1900        | 1900 | 1900 | 1900        | 1900 | 1900 | 1900       | 1900 | 1900 | 1900       | 1900 | 1900 |
| Adjustment:               | 0.95        | 0.95 | 0.92 | 0.92        | 0.95 | 0.95 | 0.92       | 1.00 | 0.92 | 0.93       | 0.95 | 0.95 |
| Lanes:                    | 0.01        | 0.99 | 0.00 | 0.00        | 0.98 | 0.02 | 0.00       | 0.00 | 0.00 | 1.56       | 0.76 | 0.68 |
| Final Sat.:               | 13          | 1787 | 0    | 0           | 1771 | 29   | 0          | 0    | 0    | 2748       | 1372 | 1229 |
| Capacity Analysis Module: |             |      |      |             |      |      |            |      |      |            |      |      |
| Vol/Sat:                  | 0.24        | 0.24 | 0.00 | 0.00        | 0.75 | 0.75 | 0.00       | 0.00 | 0.00 | 0.22       | 0.22 | 0.22 |
| Crit Moves:               | ****        |      |      |             |      |      |            |      |      |            |      |      |
| Green Time:               | 88.3        | 88.3 | 0.0  | 0.0         | 88.3 | 88.3 | 0.0        | 0.0  | 0.0  | 25.7       | 25.7 | 25.7 |
| Volume/Cap:               | 0.32        | 0.32 | 0.00 | 0.00        | 1.02 | 1.02 | 0.00       | 0.00 | 0.00 | 1.02       | 1.02 | 1.02 |
| Delay/Veh:                | 5.6         | 5.6  | 0.0  | 0.0         | 44.6 | 44.6 | 0.0        | 0.0  | 0.0  | 77.8       | 77.8 | 77.8 |
| User DelAdj:              | 1.00        | 1.00 | 1.00 | 1.00        | 1.00 | 1.00 | 1.00       | 1.00 | 1.00 | 1.00       | 1.00 | 1.00 |
| AdjDel/Veh:               | 5.6         | 5.6  | 0.0  | 0.0         | 44.6 | 44.6 | 0.0        | 0.0  | 0.0  | 77.8       | 77.8 | 77.8 |
| LOS by Move:              | A           | A    | A    | A           | D    | D    | A          | A    | A    | E          | E    | E    |
| HCM2k95thQ:               | 11          | 11   | 0    | 0           | 89   | 89   | 0          | 0    | 0    | 36         | 36   | 36   |

Note: Queue reported is the number of cars per lane.

BART

Level Of Service Computation Report  
 2000 HCM Operations (Future Volume Alternative)  
 AM - Cumulative No Project

Intersection #6: DE LA CRUZ/MARTIN [Study Int 31]

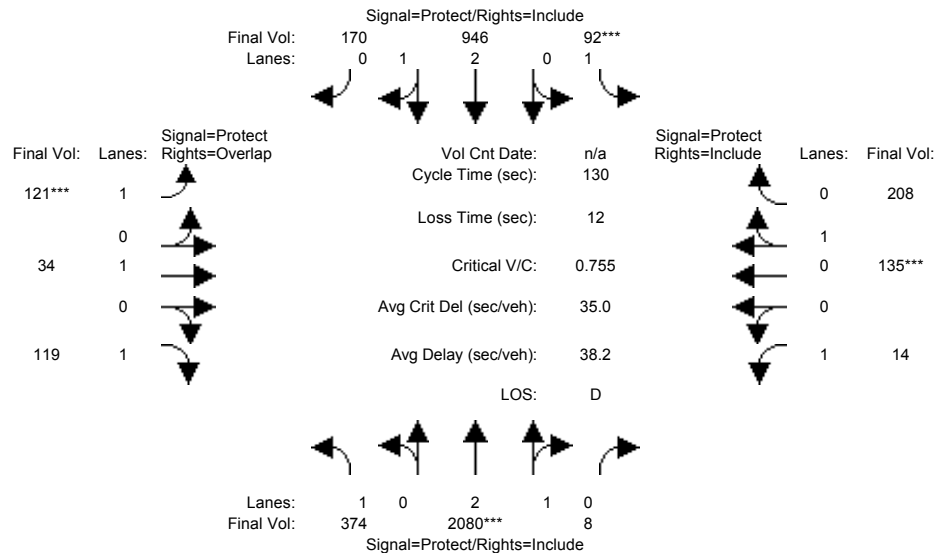

| Approach:                 | North Bound |      |      | South Bound |      |      | East Bound |      |      | West Bound |      |      |
|---------------------------|-------------|------|------|-------------|------|------|------------|------|------|------------|------|------|
|                           | L           | T    | R    | L           | T    | R    | L          | T    | R    | L          | T    | R    |
| Min. Green:               | 7           | 10   | 10   | 7           | 10   | 10   | 7          | 10   | 10   | 7          | 10   | 10   |
| Y+R:                      | 4.0         | 4.0  | 4.0  | 4.0         | 4.0  | 4.0  | 4.0        | 4.0  | 4.0  | 4.0        | 4.0  | 4.0  |
| Volume Module:            |             |      |      |             |      |      |            |      |      |            |      |      |
| Base Vol:                 | 374         | 2080 | 8    | 92          | 946  | 170  | 121        | 34   | 119  | 14         | 135  | 208  |
| Growth Adj:               | 1.00        | 1.00 | 1.00 | 1.00        | 1.00 | 1.00 | 1.00       | 1.00 | 1.00 | 1.00       | 1.00 | 1.00 |
| Initial Bse:              | 374         | 2080 | 8    | 92          | 946  | 170  | 121        | 34   | 119  | 14         | 135  | 208  |
| Added Vol:                | 0           | 0    | 0    | 0           | 0    | 0    | 0          | 0    | 0    | 0          | 0    | 0    |
| PasserByVol:              | 0           | 0    | 0    | 0           | 0    | 0    | 0          | 0    | 0    | 0          | 0    | 0    |
| Initial Fut:              | 374         | 2080 | 8    | 92          | 946  | 170  | 121        | 34   | 119  | 14         | 135  | 208  |
| User Adj:                 | 1.00        | 1.00 | 1.00 | 1.00        | 1.00 | 1.00 | 1.00       | 1.00 | 1.00 | 1.00       | 1.00 | 1.00 |
| PHF Adj:                  | 1.00        | 1.00 | 1.00 | 1.00        | 1.00 | 1.00 | 1.00       | 1.00 | 1.00 | 1.00       | 1.00 | 1.00 |
| PHF Volume:               | 374         | 2080 | 8    | 92          | 946  | 170  | 121        | 34   | 119  | 14         | 135  | 208  |
| Reduct Vol:               | 0           | 0    | 0    | 0           | 0    | 0    | 0          | 0    | 0    | 0          | 0    | 0    |
| Reduced Vol:              | 374         | 2080 | 8    | 92          | 946  | 170  | 121        | 34   | 119  | 14         | 135  | 208  |
| PCE Adj:                  | 1.00        | 1.00 | 1.00 | 1.00        | 1.00 | 1.00 | 1.00       | 1.00 | 1.00 | 1.00       | 1.00 | 1.00 |
| MLF Adj:                  | 1.00        | 1.00 | 1.00 | 1.00        | 1.00 | 1.00 | 1.00       | 1.00 | 1.00 | 1.00       | 1.00 | 1.00 |
| FinalVolume:              | 374         | 2080 | 8    | 92          | 946  | 170  | 121        | 34   | 119  | 14         | 135  | 208  |
| Saturation Flow Module:   |             |      |      |             |      |      |            |      |      |            |      |      |
| Sat/Lane:                 | 1900        | 1900 | 1900 | 1900        | 1900 | 1900 | 1900       | 1900 | 1900 | 1900       | 1900 | 1900 |
| Adjustment:               | 0.92        | 0.98 | 0.95 | 0.92        | 0.99 | 0.95 | 0.92       | 1.00 | 0.92 | 0.92       | 0.95 | 0.95 |
| Lanes:                    | 1.00        | 2.99 | 0.01 | 1.00        | 2.53 | 0.47 | 1.00       | 1.00 | 1.00 | 1.00       | 0.39 | 0.61 |
| Final Sat.:               | 1750        | 5579 | 21   | 1750        | 4746 | 853  | 1750       | 1900 | 1750 | 1750       | 708  | 1092 |
| Capacity Analysis Module: |             |      |      |             |      |      |            |      |      |            |      |      |
| Vol/Sat:                  | 0.21        | 0.37 | 0.37 | 0.05        | 0.20 | 0.20 | 0.07       | 0.02 | 0.07 | 0.01       | 0.19 | 0.19 |
| Crit Moves:               | ****        | **** | **** | ****        | **** | **** | ****       | **** | **** | ****       | **** | **** |
| Green Time:               | 37.9        | 64.2 | 64.2 | 9.1         | 35.4 | 35.4 | 11.9       | 26.3 | 64.2 | 18.4       | 32.8 | 32.8 |
| Volume/Cap:               | 0.73        | 0.75 | 0.75 | 0.75        | 0.73 | 0.73 | 0.75       | 0.09 | 0.14 | 0.06       | 0.75 | 0.75 |
| Delay/Veh:                | 46.9        | 27.8 | 27.8 | 82.6        | 44.9 | 44.9 | 75.9       | 42.2 | 17.9 | 48.4       | 51.9 | 51.9 |
| User DelAdj:              | 1.00        | 1.00 | 1.00 | 1.00        | 1.00 | 1.00 | 1.00       | 1.00 | 1.00 | 1.00       | 1.00 | 1.00 |
| AdjDel/Veh:               | 46.9        | 27.8 | 27.8 | 82.6        | 44.9 | 44.9 | 75.9       | 42.2 | 17.9 | 48.4       | 51.9 | 51.9 |
| LOS by Move:              | D           | C    | C    | F           | D    | D    | E          | D    | E    | D          | D    | D    |
| HCM2k95thQ:               | 26          | 38   | 38   | 8           | 25   | 25   | 11         | 2    | 5    | 1          | 26   | 26   |

Note: Queue reported is the number of cars per lane.

BART

Level Of Service Computation Report  
 2000 HCM Operations (Future Volume Alternative)  
 PM - Cumulative No Project

Intersection #6: DE LA CRUZ/MARTIN [Study Int 31]

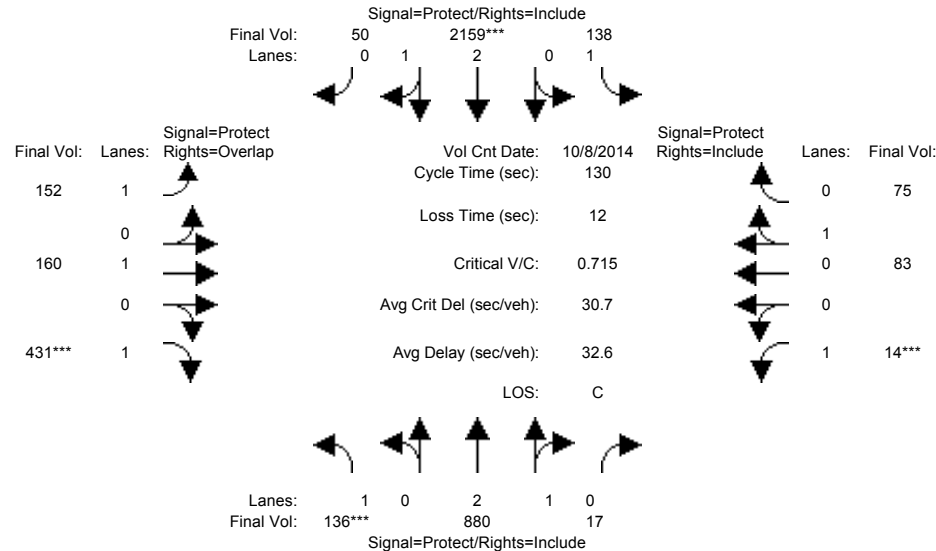

| Approach:                                   | North Bound |      |      | South Bound |      |      | East Bound |      |      | West Bound |      |      |
|---|-------------|------|------|-------------|------|------|------------|------|------|------------|------|------|
| Movement:                                   | L           | T    | R    | L           | T    | R    | L          | T    | R    | L          | T    | R    |
| Min. Green:                                 | 7           | 10   | 10   | 7           | 10   | 10   | 7          | 10   | 10   | 7          | 10   | 10   |
| Y+R:  | 4.0         | 4.0  | 4.0  | 4.0         | 4.0  | 4.0  | 4.0        | 4.0  | 4.0  | 4.0        | 4.0  | 4.0  |
| Volume Module: >> Count Date: 8 Oct 2014 << |             |      |      |             |      |      |            |      |      |            |      |      |
| Base Vol:                                   | 136         | 880  | 17   | 138         | 2159 | 50   | 152        | 160  | 431  | 14         | 83   | 75   |
| Growth Adj:                                 | 1.00        | 1.00 | 1.00 | 1.00        | 1.00 | 1.00 | 1.00       | 1.00 | 1.00 | 1.00       | 1.00 | 1.00 |
| Initial Bse:                                | 136         | 880  | 17   | 138         | 2159 | 50   | 152        | 160  | 431  | 14         | 83   | 75   |
| Added Vol:                                  | 0           | 0    | 0    | 0           | 0    | 0    | 0          | 0    | 0    | 0          | 0    | 0    |
| PasserByVol:                                | 0           | 0    | 0    | 0           | 0    | 0    | 0          | 0    | 0    | 0          | 0    | 0    |
| Initial Fut:                                | 136         | 880  | 17   | 138         | 2159 | 50   | 152        | 160  | 431  | 14         | 83   | 75   |
| User Adj:                                   | 1.00        | 1.00 | 1.00 | 1.00        | 1.00 | 1.00 | 1.00       | 1.00 | 1.00 | 1.00       | 1.00 | 1.00 |
| PHF Adj:                                    | 1.00        | 1.00 | 1.00 | 1.00        | 1.00 | 1.00 | 1.00       | 1.00 | 1.00 | 1.00       | 1.00 | 1.00 |
| PHF Volume:                                 | 136         | 880  | 17   | 138         | 2159 | 50   | 152        | 160  | 431  | 14         | 83   | 75   |
| Reduct Vol:                                 | 0           | 0    | 0    | 0           | 0    | 0    | 0          | 0    | 0    | 0          | 0    | 0    |
| Reduced Vol:                                | 136         | 880  | 17   | 138         | 2159 | 50   | 152        | 160  | 431  | 14         | 83   | 75   |
| PCE Adj:                                    | 1.00        | 1.00 | 1.00 | 1.00        | 1.00 | 1.00 | 1.00       | 1.00 | 1.00 | 1.00       | 1.00 | 1.00 |
| MLF Adj:                                    | 1.00        | 1.00 | 1.00 | 1.00        | 1.00 | 1.00 | 1.00       | 1.00 | 1.00 | 1.00       | 1.00 | 1.00 |
| Final Volume:                               | 136         | 880  | 17   | 138         | 2159 | 50   | 152        | 160  | 431  | 14         | 83   | 75   |
| Saturation Flow Module:                     |             |      |      |             |      |      |            |      |      |            |      |      |
| Sat/Lane:                                   | 1900        | 1900 | 1900 | 1900        | 1900 | 1900 | 1900       | 1900 | 1900 | 1900       | 1900 | 1900 |
| Adjustment:                                 | 0.92        | 0.98 | 0.95 | 0.92        | 0.98 | 0.95 | 0.92       | 1.00 | 0.92 | 0.92       | 0.95 | 0.95 |
| Lanes:                                      | 1.00        | 2.94 | 0.06 | 1.00        | 2.93 | 0.07 | 1.00       | 1.00 | 1.00 | 1.00       | 0.53 | 0.47 |
| Final Sat.:                                 | 1750        | 5494 | 106  | 1750        | 5473 | 127  | 1750       | 1900 | 1750 | 1750       | 946  | 854  |
| Capacity Analysis Module:                   |             |      |      |             |      |      |            |      |      |            |      |      |
| Vol/Sat:                                    | 0.08        | 0.16 | 0.16 | 0.08        | 0.39 | 0.39 | 0.09       | 0.08 | 0.25 | 0.01       | 0.09 | 0.09 |
| Crit Moves:                                 | ****        |      |      | ****        |      |      | ****       |      | **** | ****       |      |      |
| Green Time:                                 | 13.5        | 54.8 | 54.8 | 27.0        | 68.3 | 68.3 | 18.0       | 29.2 | 42.7 | 7.0        | 18.2 | 18.2 |
| Volume/Cap:                                 | 0.75        | 0.38 | 0.38 | 0.38        | 0.75 | 0.75 | 0.63       | 0.37 | 0.75 | 0.15       | 0.63 | 0.63 |
| Delay/Veh:                                  | 72.6        | 26.0 | 26.0 | 45.0        | 25.3 | 25.3 | 58.0       | 43.2 | 44.4 | 59.4       | 57.6 | 57.6 |
| User DelAdj:                                | 1.00        | 1.00 | 1.00 | 1.00        | 1.00 | 1.00 | 1.00       | 1.00 | 1.00 | 1.00       | 1.00 | 1.00 |
| AdjDel/Veh:                                 | 72.6        | 26.0 | 26.0 | 45.0        | 25.3 | 25.3 | 58.0       | 43.2 | 44.4 | 59.4       | 57.6 | 57.6 |
| LOS by Move:                                | E           | C    | C    | D           | C    | C    | E          | D    | D    | E          | E    | E    |
| HCM2k95thQ:                                 | 12          | 15   | 15   | 10          | 39   | 39   | 12         | 10   | 29   | 1          | 14   | 14   |

Note: Queue reported is the number of cars per lane.

BART

Level Of Service Computation Report  
 2000 HCM Operations (Future Volume Alternative)  
 AM - Cumulative With Project

Intersection #6: DE LA CRUZ/MARTIN [Study Int 31]

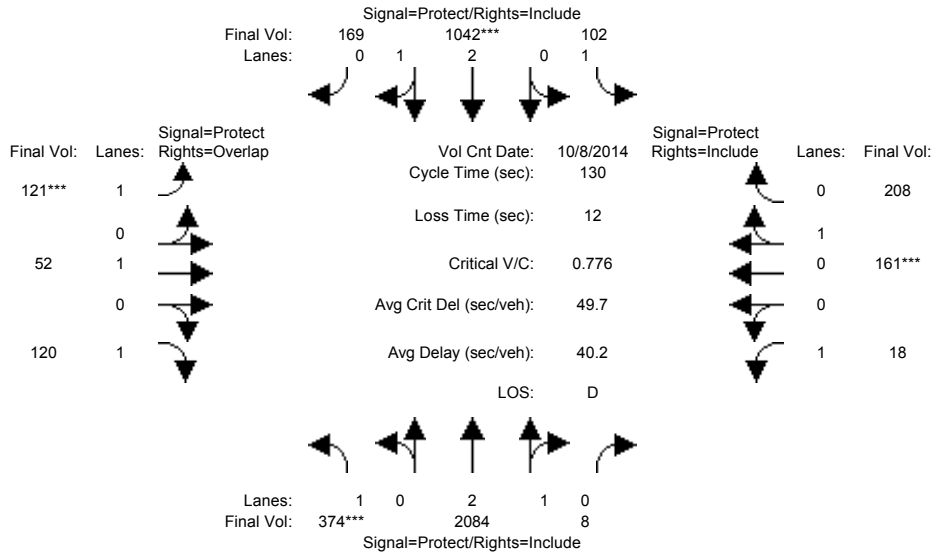

| Approach:                                   | North Bound |      |      | South Bound |      |      | East Bound |      |      | West Bound |      |      |
|---|-------------|------|------|-------------|------|------|------------|------|------|------------|------|------|
| Movement:                                   | L           | T    | R    | L           | T    | R    | L          | T    | R    | L          | T    | R    |
| Min. Green:                                 | 7           | 10   | 10   | 7           | 10   | 10   | 7          | 10   | 10   | 7          | 10   | 10   |
| Y+R:  | 4.0         | 4.0  | 4.0  | 4.0         | 4.0  | 4.0  | 4.0        | 4.0  | 4.0  | 4.0        | 4.0  | 4.0  |
| Volume Module: >> Count Date: 8 Oct 2014 << |             |      |      |             |      |      |            |      |      |            |      |      |
| Base Vol:                                   | 374         | 2084 | 8    | 102         | 1042 | 169  | 121        | 52   | 120  | 18         | 161  | 208  |
| Growth Adj:                                 | 1.00        | 1.00 | 1.00 | 1.00        | 1.00 | 1.00 | 1.00       | 1.00 | 1.00 | 1.00       | 1.00 | 1.00 |
| Initial Bse:                                | 374         | 2084 | 8    | 102         | 1042 | 169  | 121        | 52   | 120  | 18         | 161  | 208  |
| Added Vol:                                  | 0           | 0    | 0    | 0           | 0    | 0    | 0          | 0    | 0    | 0          | 0    | 0    |
| PasserByVol:                                | 0           | 0    | 0    | 0           | 0    | 0    | 0          | 0    | 0    | 0          | 0    | 0    |
| Initial Fut:                                | 374         | 2084 | 8    | 102         | 1042 | 169  | 121        | 52   | 120  | 18         | 161  | 208  |
| User Adj:                                   | 1.00        | 1.00 | 1.00 | 1.00        | 1.00 | 1.00 | 1.00       | 1.00 | 1.00 | 1.00       | 1.00 | 1.00 |
| PHF Adj:                                    | 1.00        | 1.00 | 1.00 | 1.00        | 1.00 | 1.00 | 1.00       | 1.00 | 1.00 | 1.00       | 1.00 | 1.00 |
| PHF Volume:                                 | 374         | 2084 | 8    | 102         | 1042 | 169  | 121        | 52   | 120  | 18         | 161  | 208  |
| Reduct Vol:                                 | 0           | 0    | 0    | 0           | 0    | 0    | 0          | 0    | 0    | 0          | 0    | 0    |
| Reduced Vol:                                | 374         | 2084 | 8    | 102         | 1042 | 169  | 121        | 52   | 120  | 18         | 161  | 208  |
| PCE Adj:                                    | 1.00        | 1.00 | 1.00 | 1.00        | 1.00 | 1.00 | 1.00       | 1.00 | 1.00 | 1.00       | 1.00 | 1.00 |
| MLF Adj:                                    | 1.00        | 1.00 | 1.00 | 1.00        | 1.00 | 1.00 | 1.00       | 1.00 | 1.00 | 1.00       | 1.00 | 1.00 |
| Final Volume:                               | 374         | 2084 | 8    | 102         | 1042 | 169  | 121        | 52   | 120  | 18         | 161  | 208  |
| Saturation Flow Module:                     |             |      |      |             |      |      |            |      |      |            |      |      |
| Sat/Lane:                                   | 1900        | 1900 | 1900 | 1900        | 1900 | 1900 | 1900       | 1900 | 1900 | 1900       | 1900 | 1900 |
| Adjustment:                                 | 0.92        | 0.98 | 0.95 | 0.92        | 0.99 | 0.95 | 0.92       | 1.00 | 0.92 | 0.92       | 0.95 | 0.95 |
| Lanes:                                      | 1.00        | 2.99 | 0.01 | 1.00        | 2.57 | 0.43 | 1.00       | 1.00 | 1.00 | 1.00       | 0.44 | 0.56 |
| Final Sat.:                                 | 1750        | 5579 | 21   | 1750        | 4817 | 781  | 1750       | 1900 | 1750 | 1750       | 785  | 1015 |
| Capacity Analysis Module:                   |             |      |      |             |      |      |            |      |      |            |      |      |
| Vol/Sat:                                    | 0.21        | 0.37 | 0.37 | 0.06        | 0.22 | 0.22 | 0.07       | 0.03 | 0.07 | 0.01       | 0.21 | 0.21 |
| Crit Moves:                                 | ****        |      |      | ****        |      |      | ****       |      |      | ****       |      |      |
| Green Time:                                 | 35.8        | 62.3 | 62.3 | 9.7         | 36.2 | 36.2 | 11.6       | 27.0 | 62.8 | 18.9       | 34.4 | 34.4 |
| Volume/Cap:                                 | 0.78        | 0.78 | 0.78 | 0.78        | 0.78 | 0.78 | 0.78       | 0.13 | 0.14 | 0.07       | 0.78 | 0.78 |
| Delay/Veh:                                  | 51.1        | 29.6 | 29.6 | 84.3        | 45.7 | 45.7 | 79.2       | 42.1 | 18.7 | 48.1       | 52.1 | 52.1 |
| User DelAdj:                                | 1.00        | 1.00 | 1.00 | 1.00        | 1.00 | 1.00 | 1.00       | 1.00 | 1.00 | 1.00       | 1.00 | 1.00 |
| AdjDel/Veh:                                 | 51.1        | 29.6 | 29.6 | 84.3        | 45.7 | 45.7 | 79.2       | 42.1 | 18.7 | 48.1       | 52.1 | 52.1 |
| LOS by Move:                                | D           | C    | C    | F           | D    | D    | E          | D    | B    | D          | D    | D    |
| HCM2k95thQ:                                 | 27          | 40   | 40   | 9           | 27   | 27   | 11         | 3    | 6    | 1          | 28   | 28   |

Note: Queue reported is the number of cars per lane.

BART

Level Of Service Computation Report  
2000 HCM Operations (Future Volume Alternative)  
PM - Cumulative With Project

Intersection #6: DE LA CRUZ/MARTIN [Study Int 31]

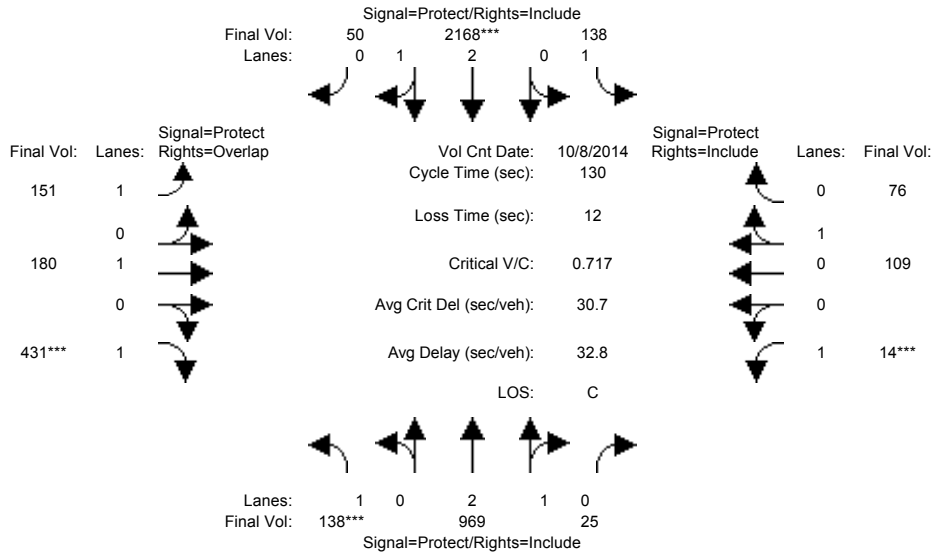

| Approach:                                   | North Bound |      |      | South Bound |      |      | East Bound |      |      | West Bound |      |      |
|---|-------------|------|------|-------------|------|------|------------|------|------|------------|------|------|
| Movement:                                   | L           | T    | R    | L           | T    | R    | L          | T    | R    | L          | T    | R    |
| Min. Green:                                 | 7           | 10   | 10   | 7           | 10   | 10   | 7          | 10   | 10   | 7          | 10   | 10   |
| Y+R:  | 4.0         | 4.0  | 4.0  | 4.0         | 4.0  | 4.0  | 4.0        | 4.0  | 4.0  | 4.0        | 4.0  | 4.0  |
| Volume Module: >> Count Date: 8 Oct 2014 << |             |      |      |             |      |      |            |      |      |            |      |      |
| Base Vol:                                   | 138         | 969  | 25   | 138         | 2168 | 50   | 151        | 180  | 431  | 14         | 109  | 76   |
| Growth Adj:                                 | 1.00        | 1.00 | 1.00 | 1.00        | 1.00 | 1.00 | 1.00       | 1.00 | 1.00 | 1.00       | 1.00 | 1.00 |
| Initial Bse:                                | 138         | 969  | 25   | 138         | 2168 | 50   | 151        | 180  | 431  | 14         | 109  | 76   |
| Added Vol:                                  | 0           | 0    | 0    | 0           | 0    | 0    | 0          | 0    | 0    | 0          | 0    | 0    |
| PasserByVol:                                | 0           | 0    | 0    | 0           | 0    | 0    | 0          | 0    | 0    | 0          | 0    | 0    |
| Initial Fut:                                | 138         | 969  | 25   | 138         | 2168 | 50   | 151        | 180  | 431  | 14         | 109  | 76   |
| User Adj:                                   | 1.00        | 1.00 | 1.00 | 1.00        | 1.00 | 1.00 | 1.00       | 1.00 | 1.00 | 1.00       | 1.00 | 1.00 |
| PHF Adj:                                    | 1.00        | 1.00 | 1.00 | 1.00        | 1.00 | 1.00 | 1.00       | 1.00 | 1.00 | 1.00       | 1.00 | 1.00 |
| PHF Volume:                                 | 138         | 969  | 25   | 138         | 2168 | 50   | 151        | 180  | 431  | 14         | 109  | 76   |
| Reduct Vol:                                 | 0           | 0    | 0    | 0           | 0    | 0    | 0          | 0    | 0    | 0          | 0    | 0    |
| Reduced Vol:                                | 138         | 969  | 25   | 138         | 2168 | 50   | 151        | 180  | 431  | 14         | 109  | 76   |
| PCE Adj:                                    | 1.00        | 1.00 | 1.00 | 1.00        | 1.00 | 1.00 | 1.00       | 1.00 | 1.00 | 1.00       | 1.00 | 1.00 |
| MLF Adj:                                    | 1.00        | 1.00 | 1.00 | 1.00        | 1.00 | 1.00 | 1.00       | 1.00 | 1.00 | 1.00       | 1.00 | 1.00 |
| Final Volume:                               | 138         | 969  | 25   | 138         | 2168 | 50   | 151        | 180  | 431  | 14         | 109  | 76   |
| Saturation Flow Module:                     |             |      |      |             |      |      |            |      |      |            |      |      |
| Sat/Lane:                                   | 1900        | 1900 | 1900 | 1900        | 1900 | 1900 | 1900       | 1900 | 1900 | 1900       | 1900 | 1900 |
| Adjustment:                                 | 0.92        | 0.98 | 0.95 | 0.92        | 0.98 | 0.95 | 0.92       | 1.00 | 0.92 | 0.92       | 0.95 | 0.95 |
| Lanes:                                      | 1.00        | 2.92 | 0.08 | 1.00        | 2.93 | 0.07 | 1.00       | 1.00 | 1.00 | 1.00       | 0.59 | 0.41 |
| Final Sat.:                                 | 1750        | 5459 | 141  | 1750        | 5474 | 126  | 1750       | 1900 | 1750 | 1750       | 1061 | 739  |
| Capacity Analysis Module:                   |             |      |      |             |      |      |            |      |      |            |      |      |
| Vol/Sat:                                    | 0.08        | 0.18 | 0.18 | 0.08        | 0.40 | 0.40 | 0.09       | 0.09 | 0.25 | 0.01       | 0.10 | 0.10 |
| Crit Moves:                                 | ****        |      |      | ****        |      |      | ****       |      | **** | ****       |      |      |
| Green Time:                                 | 13.6        | 56.8 | 56.8 | 25.2        | 68.4 | 68.4 | 16.4       | 28.9 | 42.6 | 7.0        | 19.5 | 19.5 |
| Volume/Cap:                                 | 0.75        | 0.41 | 0.41 | 0.41        | 0.75 | 0.75 | 0.68       | 0.43 | 0.75 | 0.15       | 0.68 | 0.68 |
| Delay/Veh:                                  | 72.5        | 25.2 | 25.2 | 46.6        | 25.3 | 25.3 | 62.9       | 44.1 | 44.6 | 59.4       | 59.4 | 59.4 |
| User DelAdj:                                | 1.00        | 1.00 | 1.00 | 1.00        | 1.00 | 1.00 | 1.00       | 1.00 | 1.00 | 1.00       | 1.00 | 1.00 |
| AdjDel/Veh:                                 | 72.5        | 25.2 | 25.2 | 46.6        | 25.3 | 25.3 | 62.9       | 44.1 | 44.6 | 59.4       | 59.4 | 59.4 |
| LOS by Move:                                | E           | C    | C    | D           | C    | C    | E          | D    | D    | E          | E    | E    |
| HCM2k95thQ:                                 | 12          | 17   | 17   | 10          | 39   | 39   | 12         | 12   | 29   | 1          | 16   | 16   |

Note: Queue reported is the number of cars per lane.

BART

Level Of Service Computation Report  
 2000 HCM Operations (Future Volume Alternative)  
 AM - Cumulative No Project

Intersection #7: LAFAYETTE/REED [Study Int 45]

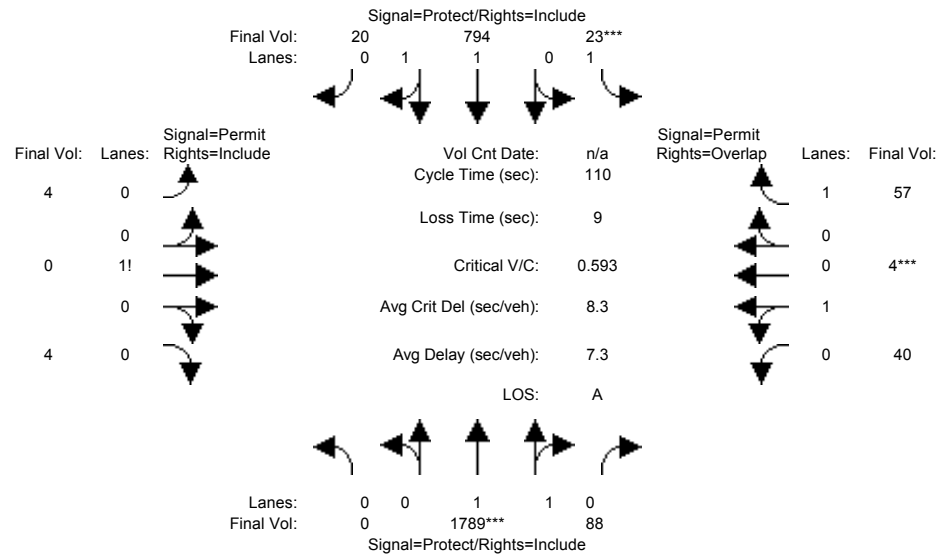

| Approach:                 | North Bound |      |      | South Bound |      |      | East Bound |      |      | West Bound |      |      |
|---------------------------|-------------|------|------|-------------|------|------|------------|------|------|------------|------|------|
| Movement:                 | L           | T    | R    | L           | T    | R    | L          | T    | R    | L          | T    | R    |
| Min. Green:               | 7           | 10   | 10   | 7           | 10   | 10   | 10         | 10   | 10   | 10         | 10   | 10   |
| Y+R:                      | 4.0         | 4.0  | 4.0  | 4.0         | 4.0  | 4.0  | 4.0        | 4.0  | 4.0  | 4.0        | 4.0  | 4.0  |
| Volume Module:            |             |      |      |             |      |      |            |      |      |            |      |      |
| Base Vol:                 | 0           | 1789 | 88   | 23          | 794  | 20   | 4          | 0    | 4    | 40         | 4    | 57   |
| Growth Adj:               | 1.00        | 1.00 | 1.00 | 1.00        | 1.00 | 1.00 | 1.00       | 1.00 | 1.00 | 1.00       | 1.00 | 1.00 |
| Initial Bse:              | 0           | 1789 | 88   | 23          | 794  | 20   | 4          | 0    | 4    | 40         | 4    | 57   |
| Added Vol:                | 0           | 0    | 0    | 0           | 0    | 0    | 0          | 0    | 0    | 0          | 0    | 0    |
| PasserByVol:              | 0           | 0    | 0    | 0           | 0    | 0    | 0          | 0    | 0    | 0          | 0    | 0    |
| Initial Fut:              | 0           | 1789 | 88   | 23          | 794  | 20   | 4          | 0    | 4    | 40         | 4    | 57   |
| User Adj:                 | 1.00        | 1.00 | 1.00 | 1.00        | 1.00 | 1.00 | 1.00       | 1.00 | 1.00 | 1.00       | 1.00 | 1.00 |
| PHF Adj:                  | 1.00        | 1.00 | 1.00 | 1.00        | 1.00 | 1.00 | 1.00       | 1.00 | 1.00 | 1.00       | 1.00 | 1.00 |
| PHF Volume:               | 0           | 1789 | 88   | 23          | 794  | 20   | 4          | 0    | 4    | 40         | 4    | 57   |
| Reduct Vol:               | 0           | 0    | 0    | 0           | 0    | 0    | 0          | 0    | 0    | 0          | 0    | 0    |
| Reduced Vol:              | 0           | 1789 | 88   | 23          | 794  | 20   | 4          | 0    | 4    | 40         | 4    | 57   |
| PCE Adj:                  | 1.00        | 1.00 | 1.00 | 1.00        | 1.00 | 1.00 | 1.00       | 1.00 | 1.00 | 1.00       | 1.00 | 1.00 |
| MLF Adj:                  | 1.00        | 1.00 | 1.00 | 1.00        | 1.00 | 1.00 | 1.00       | 1.00 | 1.00 | 1.00       | 1.00 | 1.00 |
| Final Volume:             | 0           | 1789 | 88   | 23          | 794  | 20   | 4          | 0    | 4    | 40         | 4    | 57   |
| Saturation Flow Module:   |             |      |      |             |      |      |            |      |      |            |      |      |
| Sat/Lane:                 | 1900        | 1900 | 1900 | 1900        | 1900 | 1900 | 1900       | 1900 | 1900 | 1900       | 1900 | 1900 |
| Adjustment:               | 0.92        | 0.97 | 0.95 | 0.92        | 0.97 | 0.95 | 0.92       | 0.92 | 0.92 | 0.95       | 0.95 | 0.92 |
| Lanes:                    | 0.00        | 1.90 | 0.10 | 1.00        | 1.95 | 0.05 | 0.50       | 0.00 | 0.50 | 0.91       | 0.09 | 1.00 |
| Final Sat.:               | 0           | 3526 | 173  | 1750        | 3609 | 91   | 875        | 0    | 875  | 1636       | 164  | 1750 |
| Capacity Analysis Module: |             |      |      |             |      |      |            |      |      |            |      |      |
| Vol/Sat:                  | 0.00        | 0.51 | 0.51 | 0.01        | 0.22 | 0.22 | 0.00       | 0.00 | 0.00 | 0.02       | 0.02 | 0.03 |
| Crit Moves:               | ****        | **** | **** | ****        | **** | **** | ****       | **** | **** | ****       | **** | **** |
| Green Time:               | 0.0         | 84.0 | 84.0 | 7.0         | 91.0 | 91.0 | 10.0       | 0.0  | 10.0 | 10.0       | 10.0 | 17.0 |
| Volume/Cap:               | 0.00        | 0.66 | 0.66 | 0.21        | 0.27 | 0.27 | 0.05       | 0.00 | 0.05 | 0.27       | 0.27 | 0.21 |
| Delay/Veh:                | 0.0         | 6.8  | 6.8  | 49.8        | 2.2  | 2.2  | 45.8       | 0.0  | 45.8 | 47.5       | 47.5 | 41.0 |
| User DelAdj:              | 1.00        | 1.00 | 1.00 | 1.00        | 1.00 | 1.00 | 1.00       | 1.00 | 1.00 | 1.00       | 1.00 | 1.00 |
| AdjDel/Veh:               | 0.0         | 6.8  | 6.8  | 49.8        | 2.2  | 2.2  | 45.8       | 0.0  | 45.8 | 47.5       | 47.5 | 41.0 |
| LOS by Move:              | A           | A    | A    | D           | A    | A    | D          | A    | D    | D          | D    | D    |
| HCM2k95thQ:               | 0           | 28   | 28   | 2           | 6    | 6    | 1          | 0    | 1    | 3          | 3    | 4    |

Note: Queue reported is the number of cars per lane.



BART

Level Of Service Computation Report  
 2000 HCM Operations (Future Volume Alternative)  
 PM - Cumulative No Project

Intersection #7: LAFAYETTE/REED [Study Int 45]

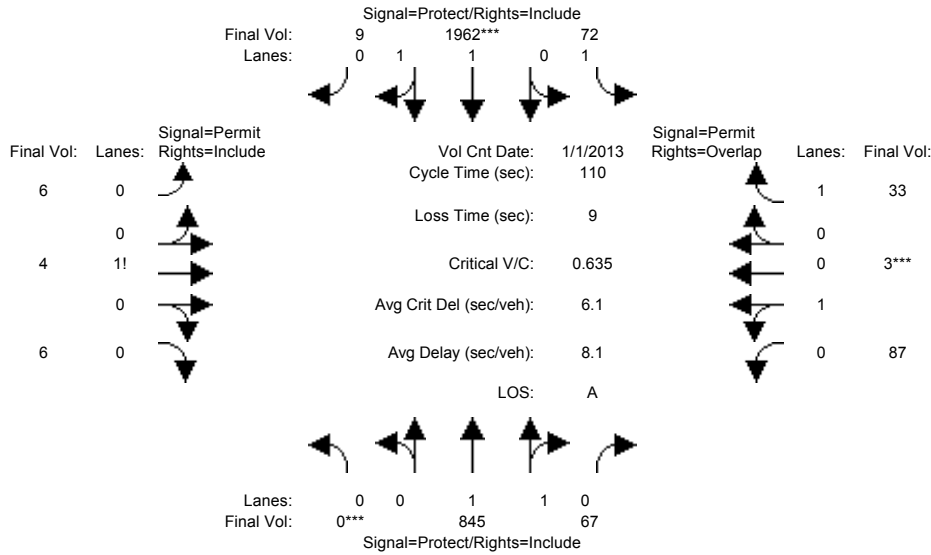

| Approach:                                   | North Bound |      |      | South Bound |      |      | East Bound |      |      | West Bound |      |      |
|---|-------------|------|------|-------------|------|------|------------|------|------|------------|------|------|
| Movement:                                   | L           | T    | R    | L           | T    | R    | L          | T    | R    | L          | T    | R    |
| Min. Green:                                 | 7           | 10   | 10   | 7           | 10   | 10   | 10         | 10   | 10   | 10         | 10   | 10   |
| Y+R:  | 4.0         | 4.0  | 4.0  | 4.0         | 4.0  | 4.0  | 4.0        | 4.0  | 4.0  | 4.0        | 4.0  | 4.0  |
| -----                                       |             |      |      |             |      |      |            |      |      |            |      |      |
| Volume Module: >> Count Date: 1 Jan 2013 << |             |      |      |             |      |      |            |      |      |            |      |      |
| Base Vol:                                   | 0           | 845  | 67   | 72          | 1962 | 9    | 6          | 4    | 6    | 87         | 3    | 33   |
| Growth Adj:                                 | 1.00        | 1.00 | 1.00 | 1.00        | 1.00 | 1.00 | 1.00       | 1.00 | 1.00 | 1.00       | 1.00 | 1.00 |
| Initial Bse:                                | 0           | 845  | 67   | 72          | 1962 | 9    | 6          | 4    | 6    | 87         | 3    | 33   |
| Added Vol:                                  | 0           | 0    | 0    | 0           | 0    | 0    | 0          | 0    | 0    | 0          | 0    | 0    |
| PasserByVol:                                | 0           | 0    | 0    | 0           | 0    | 0    | 0          | 0    | 0    | 0          | 0    | 0    |
| Initial Fut:                                | 0           | 845  | 67   | 72          | 1962 | 9    | 6          | 4    | 6    | 87         | 3    | 33   |
| User Adj:                                   | 1.00        | 1.00 | 1.00 | 1.00        | 1.00 | 1.00 | 1.00       | 1.00 | 1.00 | 1.00       | 1.00 | 1.00 |
| PHF Adj:                                    | 1.00        | 1.00 | 1.00 | 1.00        | 1.00 | 1.00 | 1.00       | 1.00 | 1.00 | 1.00       | 1.00 | 1.00 |
| PHF Volume:                                 | 0           | 845  | 67   | 72          | 1962 | 9    | 6          | 4    | 6    | 87         | 3    | 33   |
| Reduct Vol:                                 | 0           | 0    | 0    | 0           | 0    | 0    | 0          | 0    | 0    | 0          | 0    | 0    |
| Reduced Vol:                                | 0           | 845  | 67   | 72          | 1962 | 9    | 6          | 4    | 6    | 87         | 3    | 33   |
| PCE Adj:                                    | 1.00        | 1.00 | 1.00 | 1.00        | 1.00 | 1.00 | 1.00       | 1.00 | 1.00 | 1.00       | 1.00 | 1.00 |
| MLF Adj:                                    | 1.00        | 1.00 | 1.00 | 1.00        | 1.00 | 1.00 | 1.00       | 1.00 | 1.00 | 1.00       | 1.00 | 1.00 |
| FinalVolume:                                | 0           | 845  | 67   | 72          | 1962 | 9    | 6          | 4    | 6    | 87         | 3    | 33   |
| -----                                       |             |      |      |             |      |      |            |      |      |            |      |      |
| Saturation Flow Module:                     |             |      |      |             |      |      |            |      |      |            |      |      |
| Sat/Lane:                                   | 1900        | 1900 | 1900 | 1900        | 1900 | 1900 | 1900       | 1900 | 1900 | 1900       | 1900 | 1900 |
| Adjustment:                                 | 0.92        | 0.98 | 0.95 | 0.92        | 0.97 | 0.95 | 0.92       | 0.92 | 0.92 | 0.95       | 0.95 | 0.92 |
| Lanes:                                      | 0.00        | 1.85 | 0.15 | 1.00        | 1.99 | 0.01 | 0.37       | 0.25 | 0.38 | 0.97       | 0.03 | 1.00 |
| Final Sat.:                                 | 0           | 3428 | 272  | 1750        | 3683 | 17   | 656        | 438  | 656  | 1740       | 60   | 1750 |
| -----                                       |             |      |      |             |      |      |            |      |      |            |      |      |
| Capacity Analysis Module:                   |             |      |      |             |      |      |            |      |      |            |      |      |
| Vol/Sat:                                    | 0.00        | 0.25 | 0.25 | 0.04        | 0.53 | 0.53 | 0.01       | 0.01 | 0.01 | 0.05       | 0.05 | 0.02 |
| Crit Moves:                                 | ****        |      |      | ****        |      |      |            |      |      | ****       |      |      |
| Green Time:                                 | 0.0         | 72.3 | 72.3 | 18.7        | 91.0 | 91.0 | 10.0       | 10.0 | 10.0 | 10.0       | 10.0 | 28.7 |
| Volume/Cap:                                 | 0.00        | 0.37 | 0.37 | 0.24        | 0.64 | 0.64 | 0.10       | 0.10 | 0.10 | 0.55       | 0.55 | 0.07 |
| Delay/Veh:                                  | 0.0         | 8.7  | 8.7  | 40.0        | 4.0  | 4.0  | 46.2       | 46.2 | 46.2 | 51.8       | 51.8 | 30.7 |
| User DelAdj:                                | 1.00        | 1.00 | 1.00 | 1.00        | 1.00 | 1.00 | 1.00       | 1.00 | 1.00 | 1.00       | 1.00 | 1.00 |
| AdjDel/Veh:                                 | 0.0         | 8.7  | 8.7  | 40.0        | 4.0  | 4.0  | 46.2       | 46.2 | 46.2 | 51.8       | 51.8 | 30.7 |
| LOS by Move:                                | A           | A    | A    | D           | A    | A    | D          | D    | D    | D          | D    | C    |
| HCM2k95thQ:                                 | 0           | 13   | 13   | 4           | 24   | 24   | 1          | 1    | 1    | 6          | 6    | 2    |

Note: Queue reported is the number of cars per lane.

BART

Level Of Service Computation Report  
 2000 HCM Operations (Future Volume Alternative)  
 AM - Cumulative With Project

Intersection #7: LAFAYETTE/REED [Study Int 45]

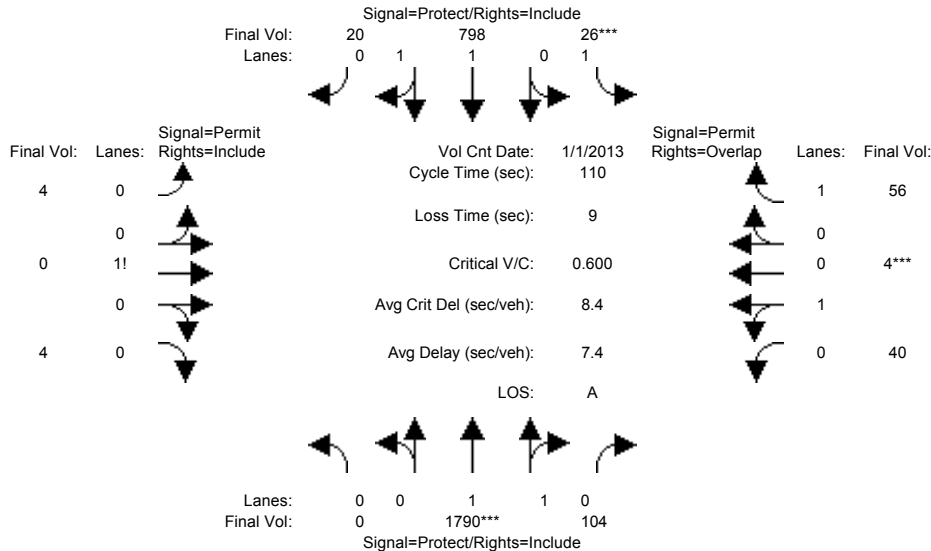

| Approach:                                   | North Bound |      |      | South Bound |      |      | East Bound |      |      | West Bound |      |      |
|---|-------------|------|------|-------------|------|------|------------|------|------|------------|------|------|
| Movement:                                   | L           | T    | R    | L           | T    | R    | L          | T    | R    | L          | T    | R    |
| Min. Green:                                 | 7           | 10   | 10   | 7           | 10   | 10   | 10         | 10   | 10   | 10         | 10   | 10   |
| Y+R:  | 4.0         | 4.0  | 4.0  | 4.0         | 4.0  | 4.0  | 4.0        | 4.0  | 4.0  | 4.0        | 4.0  | 4.0  |
| -----                                       |             |      |      |             |      |      |            |      |      |            |      |      |
| Volume Module: >> Count Date: 1 Jan 2013 << |             |      |      |             |      |      |            |      |      |            |      |      |
| Base Vol:                                   | 0           | 1790 | 104  | 26          | 798  | 20   | 4          | 0    | 4    | 40         | 4    | 56   |
| Growth Adj:                                 | 1.00        | 1.00 | 1.00 | 1.00        | 1.00 | 1.00 | 1.00       | 1.00 | 1.00 | 1.00       | 1.00 | 1.00 |
| Initial Bse:                                | 0           | 1790 | 104  | 26          | 798  | 20   | 4          | 0    | 4    | 40         | 4    | 56   |
| Added Vol:                                  | 0           | 0    | 0    | 0           | 0    | 0    | 0          | 0    | 0    | 0          | 0    | 0    |
| PasserByVol:                                | 0           | 0    | 0    | 0           | 0    | 0    | 0          | 0    | 0    | 0          | 0    | 0    |
| Initial Fut:                                | 0           | 1790 | 104  | 26          | 798  | 20   | 4          | 0    | 4    | 40         | 4    | 56   |
| User Adj:                                   | 1.00        | 1.00 | 1.00 | 1.00        | 1.00 | 1.00 | 1.00       | 1.00 | 1.00 | 1.00       | 1.00 | 1.00 |
| PHF Adj:                                    | 1.00        | 1.00 | 1.00 | 1.00        | 1.00 | 1.00 | 1.00       | 1.00 | 1.00 | 1.00       | 1.00 | 1.00 |
| PHF Volume:                                 | 0           | 1790 | 104  | 26          | 798  | 20   | 4          | 0    | 4    | 40         | 4    | 56   |
| Reduct Vol:                                 | 0           | 0    | 0    | 0           | 0    | 0    | 0          | 0    | 0    | 0          | 0    | 0    |
| Reduced Vol:                                | 0           | 1790 | 104  | 26          | 798  | 20   | 4          | 0    | 4    | 40         | 4    | 56   |
| PCE Adj:                                    | 1.00        | 1.00 | 1.00 | 1.00        | 1.00 | 1.00 | 1.00       | 1.00 | 1.00 | 1.00       | 1.00 | 1.00 |
| MLF Adj:                                    | 1.00        | 1.00 | 1.00 | 1.00        | 1.00 | 1.00 | 1.00       | 1.00 | 1.00 | 1.00       | 1.00 | 1.00 |
| Final Volume:                               | 0           | 1790 | 104  | 26          | 798  | 20   | 4          | 0    | 4    | 40         | 4    | 56   |
| -----                                       |             |      |      |             |      |      |            |      |      |            |      |      |
| Saturation Flow Module:                     |             |      |      |             |      |      |            |      |      |            |      |      |
| Sat/Lane:                                   | 1900        | 1900 | 1900 | 1900        | 1900 | 1900 | 1900       | 1900 | 1900 | 1900       | 1900 | 1900 |
| Adjustment:                                 | 0.92        | 0.98 | 0.95 | 0.92        | 0.97 | 0.95 | 0.92       | 0.92 | 0.92 | 0.95       | 0.95 | 0.92 |
| Lanes:                                      | 0.00        | 1.89 | 0.11 | 1.00        | 1.95 | 0.05 | 0.50       | 0.00 | 0.50 | 0.91       | 0.09 | 1.00 |
| Final Sat.:                                 | 0           | 3497 | 203  | 1750        | 3609 | 90   | 875        | 0    | 875  | 1636       | 164  | 1750 |
| -----                                       |             |      |      |             |      |      |            |      |      |            |      |      |
| Capacity Analysis Module:                   |             |      |      |             |      |      |            |      |      |            |      |      |
| Vol/Sat:                                    | 0.00        | 0.51 | 0.51 | 0.01        | 0.22 | 0.22 | 0.00       | 0.00 | 0.00 | 0.02       | 0.02 | 0.03 |
| Crit Moves:                                 | ****        | **** | **** | ****        | **** | **** | ****       | **** | **** | ****       | **** | **** |
| Green Time:                                 | 0.0         | 84.0 | 84.0 | 7.0         | 91.0 | 91.0 | 10.0       | 0.0  | 10.0 | 10.0       | 10.0 | 17.0 |
| Volume/Cap:                                 | 0.00        | 0.67 | 0.67 | 0.23        | 0.27 | 0.27 | 0.05       | 0.00 | 0.05 | 0.27       | 0.27 | 0.21 |
| Delay/Veh:                                  | 0.0         | 6.9  | 6.9  | 50.0        | 2.2  | 2.2  | 45.8       | 0.0  | 45.8 | 47.5       | 47.5 | 41.0 |
| User DelAdj:                                | 1.00        | 1.00 | 1.00 | 1.00        | 1.00 | 1.00 | 1.00       | 1.00 | 1.00 | 1.00       | 1.00 | 1.00 |
| AdjDel/Veh:                                 | 0.0         | 6.9  | 6.9  | 50.0        | 2.2  | 2.2  | 45.8       | 0.0  | 45.8 | 47.5       | 47.5 | 41.0 |
| LOS by Move:                                | A           | A    | A    | D           | A    | A    | D          | A    | D    | D          | D    | D    |
| HCM2k95thQ:                                 | 0           | 28   | 28   | 2           | 6    | 6    | 1          | 0    | 1    | 3          | 3    | 4    |

Note: Queue reported is the number of cars per lane.

BART

Level Of Service Computation Report  
 2000 HCM Operations (Future Volume Alternative)  
 PM - Cumulative With Project

Intersection #7: LAFAYETTE/REED [Study Int 45]

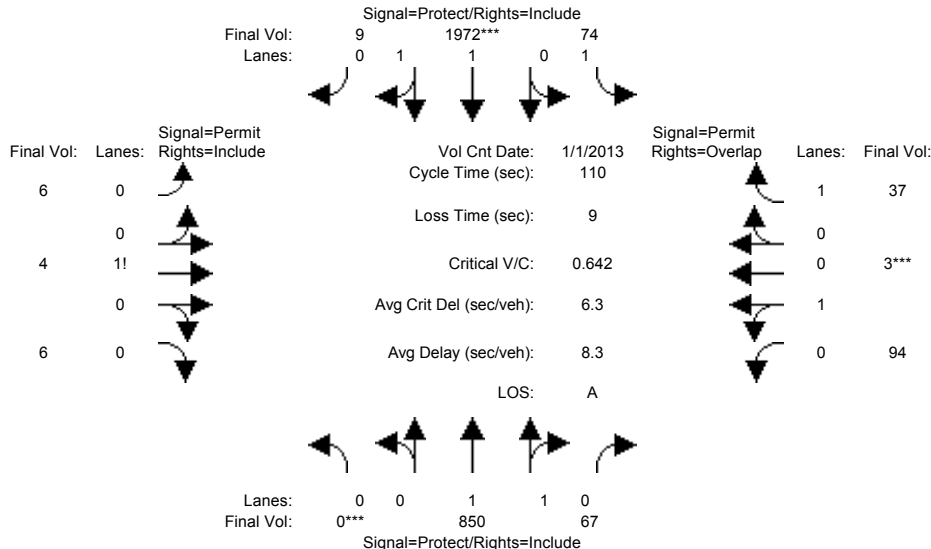

| Approach:                                   | North Bound |      |      | South Bound |      |      | East Bound |      |      | West Bound |      |      |
|---|-------------|------|------|-------------|------|------|------------|------|------|------------|------|------|
| Movement:                                   | L           | T    | R    | L           | T    | R    | L          | T    | R    | L          | T    | R    |
| Min. Green:                                 | 7           | 10   | 10   | 7           | 10   | 10   | 10         | 10   | 10   | 10         | 10   | 10   |
| Y+R:  | 4.0         | 4.0  | 4.0  | 4.0         | 4.0  | 4.0  | 4.0        | 4.0  | 4.0  | 4.0        | 4.0  | 4.0  |
| -----                                       |             |      |      |             |      |      |            |      |      |            |      |      |
| Volume Module: >> Count Date: 1 Jan 2013 << |             |      |      |             |      |      |            |      |      |            |      |      |
| Base Vol:                                   | 0           | 850  | 67   | 74          | 1972 | 9    | 6          | 4    | 6    | 94         | 3    | 37   |
| Growth Adj:                                 | 1.00        | 1.00 | 1.00 | 1.00        | 1.00 | 1.00 | 1.00       | 1.00 | 1.00 | 1.00       | 1.00 | 1.00 |
| Initial Bse:                                | 0           | 850  | 67   | 74          | 1972 | 9    | 6          | 4    | 6    | 94         | 3    | 37   |
| Added Vol:                                  | 0           | 0    | 0    | 0           | 0    | 0    | 0          | 0    | 0    | 0          | 0    | 0    |
| PasserByVol:                                | 0           | 0    | 0    | 0           | 0    | 0    | 0          | 0    | 0    | 0          | 0    | 0    |
| Initial Fut:                                | 0           | 850  | 67   | 74          | 1972 | 9    | 6          | 4    | 6    | 94         | 3    | 37   |
| User Adj:                                   | 1.00        | 1.00 | 1.00 | 1.00        | 1.00 | 1.00 | 1.00       | 1.00 | 1.00 | 1.00       | 1.00 | 1.00 |
| PHF Adj:                                    | 1.00        | 1.00 | 1.00 | 1.00        | 1.00 | 1.00 | 1.00       | 1.00 | 1.00 | 1.00       | 1.00 | 1.00 |
| PHF Volume:                                 | 0           | 850  | 67   | 74          | 1972 | 9    | 6          | 4    | 6    | 94         | 3    | 37   |
| Reduct Vol:                                 | 0           | 0    | 0    | 0           | 0    | 0    | 0          | 0    | 0    | 0          | 0    | 0    |
| Reduced Vol:                                | 0           | 850  | 67   | 74          | 1972 | 9    | 6          | 4    | 6    | 94         | 3    | 37   |
| PCE Adj:                                    | 1.00        | 1.00 | 1.00 | 1.00        | 1.00 | 1.00 | 1.00       | 1.00 | 1.00 | 1.00       | 1.00 | 1.00 |
| MLF Adj:                                    | 1.00        | 1.00 | 1.00 | 1.00        | 1.00 | 1.00 | 1.00       | 1.00 | 1.00 | 1.00       | 1.00 | 1.00 |
| Final Volume:                               | 0           | 850  | 67   | 74          | 1972 | 9    | 6          | 4    | 6    | 94         | 3    | 37   |
| -----                                       |             |      |      |             |      |      |            |      |      |            |      |      |
| Saturation Flow Module:                     |             |      |      |             |      |      |            |      |      |            |      |      |
| Sat/Lane:                                   | 1900        | 1900 | 1900 | 1900        | 1900 | 1900 | 1900       | 1900 | 1900 | 1900       | 1900 | 1900 |
| Adjustment:                                 | 0.92        | 0.98 | 0.95 | 0.92        | 0.97 | 0.95 | 0.92       | 0.92 | 0.92 | 0.95       | 0.95 | 0.92 |
| Lanes:                                      | 0.00        | 1.85 | 0.15 | 1.00        | 1.99 | 0.01 | 0.37       | 0.25 | 0.38 | 0.97       | 0.03 | 1.00 |
| Final Sat.:                                 | 0           | 3429 | 270  | 1750        | 3683 | 17   | 656        | 438  | 656  | 1744       | 56   | 1750 |
| -----                                       |             |      |      |             |      |      |            |      |      |            |      |      |
| Capacity Analysis Module:                   |             |      |      |             |      |      |            |      |      |            |      |      |
| Vol/Sat:                                    | 0.00        | 0.25 | 0.25 | 0.04        | 0.54 | 0.54 | 0.01       | 0.01 | 0.01 | 0.05       | 0.05 | 0.02 |
| Crit Moves:                                 | ****        |      |      | ****        |      |      |            |      |      | ****       |      |      |
| Green Time:                                 | 0.0         | 72.4 | 72.4 | 18.6        | 91.0 | 91.0 | 10.0       | 10.0 | 10.0 | 10.0       | 10.0 | 28.6 |
| Volume/Cap:                                 | 0.00        | 0.38 | 0.38 | 0.25        | 0.65 | 0.65 | 0.10       | 0.10 | 0.10 | 0.59       | 0.59 | 0.08 |
| Delay/Veh:                                  | 0.0         | 8.6  | 8.6  | 40.1        | 4.0  | 4.0  | 46.2       | 46.2 | 46.2 | 53.8       | 53.8 | 30.9 |
| User DelAdj:                                | 1.00        | 1.00 | 1.00 | 1.00        | 1.00 | 1.00 | 1.00       | 1.00 | 1.00 | 1.00       | 1.00 | 1.00 |
| AdjDel/Veh:                                 | 0.0         | 8.6  | 8.6  | 40.1        | 4.0  | 4.0  | 46.2       | 46.2 | 46.2 | 53.8       | 53.8 | 30.9 |
| LOS by Move:                                | A           | A    | A    | D           | A    | A    | D          | D    | D    | D          | D    | C    |
| HCM2k95thQ:                                 | 0           | 13   | 13   | 5           | 24   | 24   | 1          | 1    | 1    | 7          | 7    | 2    |

Note: Queue reported is the number of cars per lane.

BART

Level Of Service Computation Report  
 2000 HCM Operations (Future Volume Alternative)  
 AM - Cumulative No Project

Intersection #9: Coleman/Brokaw [Study Int 33]

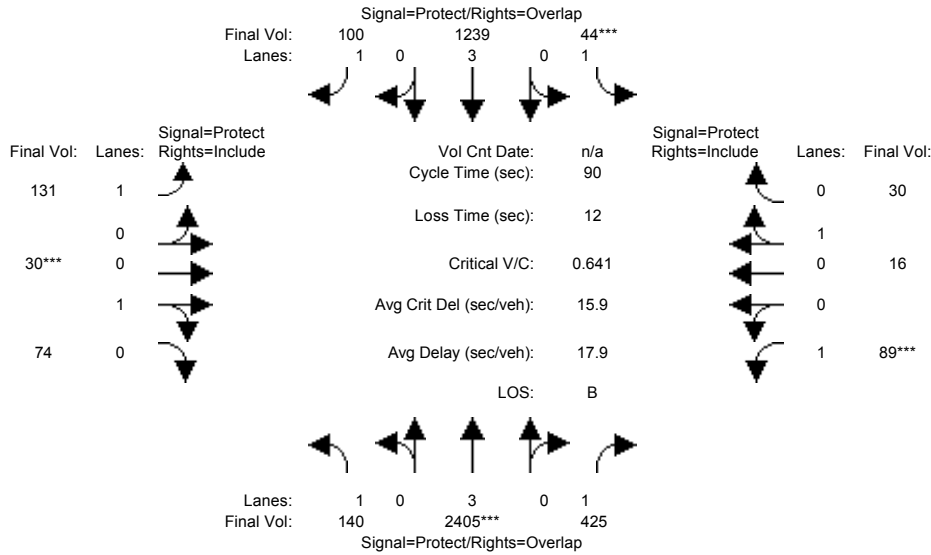

| Approach:                 | North Bound |      |      | South Bound |      |      | East Bound |      |      | West Bound |      |      |
|---------------------------|-------------|------|------|-------------|------|------|------------|------|------|------------|------|------|
| Movement:                 | L           | T    | R    | L           | T    | R    | L          | T    | R    | L          | T    | R    |
| Min. Green:               | 7           | 10   | 10   | 7           | 10   | 10   | 7          | 10   | 10   | 7          | 10   | 10   |
| Y+R:                      | 4.0         | 4.0  | 4.0  | 4.0         | 4.0  | 4.0  | 4.0        | 4.0  | 4.0  | 4.0        | 4.0  | 4.0  |
| Volume Module:            |             |      |      |             |      |      |            |      |      |            |      |      |
| Base Vol:                 | 140         | 2405 | 425  | 44          | 1239 | 100  | 131        | 30   | 74   | 89         | 16   | 30   |
| Growth Adj:               | 1.00        | 1.00 | 1.00 | 1.00        | 1.00 | 1.00 | 1.00       | 1.00 | 1.00 | 1.00       | 1.00 | 1.00 |
| Initial Bse:              | 140         | 2405 | 425  | 44          | 1239 | 100  | 131        | 30   | 74   | 89         | 16   | 30   |
| Added Vol:                | 0           | 0    | 0    | 0           | 0    | 0    | 0          | 0    | 0    | 0          | 0    | 0    |
| PasserByVol:              | 0           | 0    | 0    | 0           | 0    | 0    | 0          | 0    | 0    | 0          | 0    | 0    |
| Initial Fut:              | 140         | 2405 | 425  | 44          | 1239 | 100  | 131        | 30   | 74   | 89         | 16   | 30   |
| User Adj:                 | 1.00        | 1.00 | 1.00 | 1.00        | 1.00 | 1.00 | 1.00       | 1.00 | 1.00 | 1.00       | 1.00 | 1.00 |
| PHF Adj:                  | 1.00        | 1.00 | 1.00 | 1.00        | 1.00 | 1.00 | 1.00       | 1.00 | 1.00 | 1.00       | 1.00 | 1.00 |
| PHF Volume:               | 140         | 2405 | 425  | 44          | 1239 | 100  | 131        | 30   | 74   | 89         | 16   | 30   |
| Reduct Vol:               | 0           | 0    | 0    | 0           | 0    | 0    | 0          | 0    | 0    | 0          | 0    | 0    |
| Reduced Vol:              | 140         | 2405 | 425  | 44          | 1239 | 100  | 131        | 30   | 74   | 89         | 16   | 30   |
| PCE Adj:                  | 1.00        | 1.00 | 1.00 | 1.00        | 1.00 | 1.00 | 1.00       | 1.00 | 1.00 | 1.00       | 1.00 | 1.00 |
| MLF Adj:                  | 1.00        | 1.00 | 1.00 | 1.00        | 1.00 | 1.00 | 1.00       | 1.00 | 1.00 | 1.00       | 1.00 | 1.00 |
| Final Volume:             | 140         | 2405 | 425  | 44          | 1239 | 100  | 131        | 30   | 74   | 89         | 16   | 30   |
| Saturation Flow Module:   |             |      |      |             |      |      |            |      |      |            |      |      |
| Sat/Lane:                 | 1900        | 1900 | 1900 | 1900        | 1900 | 1900 | 1900       | 1900 | 1900 | 1900       | 1900 | 1900 |
| Adjustment:               | 0.92        | 1.00 | 0.92 | 0.92        | 1.00 | 0.92 | 0.92       | 0.95 | 0.95 | 0.92       | 0.95 | 0.95 |
| Lanes:                    | 1.00        | 3.00 | 1.00 | 1.00        | 3.00 | 1.00 | 1.00       | 0.29 | 0.71 | 1.00       | 0.35 | 0.65 |
| Final Sat.:               | 1750        | 5700 | 1750 | 1750        | 5700 | 1750 | 1750       | 519  | 1281 | 1750       | 626  | 1174 |
| Capacity Analysis Module: |             |      |      |             |      |      |            |      |      |            |      |      |
| Vol/Sat:                  | 0.08        | 0.42 | 0.24 | 0.03        | 0.22 | 0.06 | 0.07       | 0.06 | 0.06 | 0.05       | 0.03 | 0.03 |
| Crit Moves:               | ****        |      |      | ****        |      |      | ****       |      | **** |            |      |      |
| Green Time:               | 16.4        | 54.0 | 61.0 | 7.0         | 44.6 | 51.6 | 7.0        | 10.0 | 10.0 | 7.0        | 10.0 | 10.0 |
| Volume/Cap:               | 0.44        | 0.70 | 0.36 | 0.32        | 0.44 | 0.10 | 0.96       | 0.52 | 0.52 | 0.65       | 0.23 | 0.23 |
| Delay/Veh:                | 33.7        | 13.1 | 6.4  | 40.6        | 14.7 | 8.7  | 106.8      | 40.2 | 40.2 | 51.2       | 37.1 | 37.1 |
| User DelAdj:              | 1.00        | 1.00 | 1.00 | 1.00        | 1.00 | 1.00 | 1.00       | 1.00 | 1.00 | 1.00       | 1.00 | 1.00 |
| AdjDel/Veh:               | 33.7        | 13.1 | 6.4  | 40.6        | 14.7 | 8.7  | 106.8      | 40.2 | 40.2 | 51.2       | 37.1 | 37.1 |
| LOS by Move:              | C           | B    | A    | D           | B    | A    | F          | D    | D    | D          | D    | D    |
| HCM2k95thQ:               | 7           | 25   | 10   | 3           | 14   | 3    | 14         | 7    | 7    | 6          | 2    | 2    |

Note: Queue reported is the number of cars per lane.

BART

Level Of Service Computation Report  
 2000 HCM Operations (Future Volume Alternative)  
 PM - Cumulative No Project

Intersection #9: Coleman/Brokaw [Study Int 33]

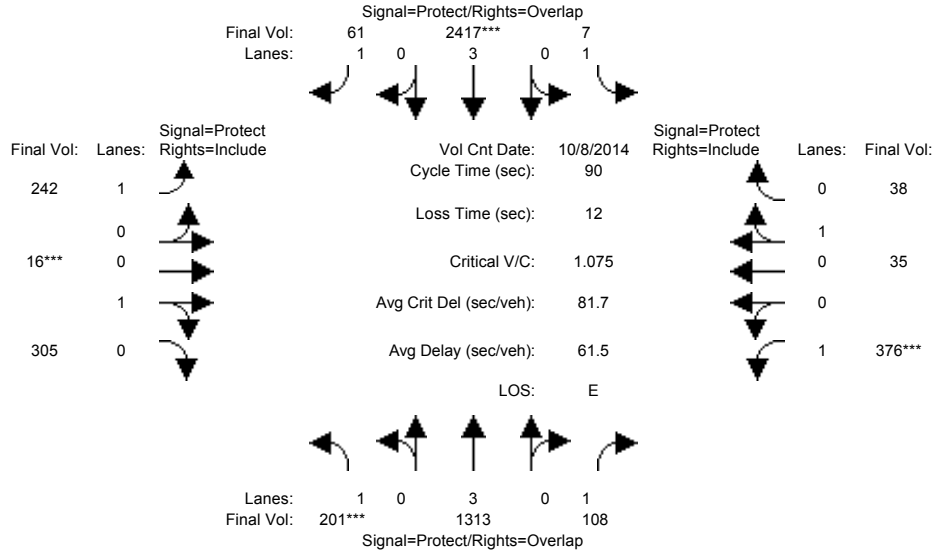

| Approach:                                   | North Bound |      |      | South Bound |      |      | East Bound |      |       | West Bound |      |      |
|---|-------------|------|------|-------------|------|------|------------|------|-------|------------|------|------|
| Movement:                                   | L           | T    | R    | L           | T    | R    | L          | T    | R     | L          | T    | R    |
| Min. Green:                                 | 7           | 10   | 10   | 7           | 10   | 10   | 7          | 10   | 10    | 7          | 10   | 10   |
| Y+R:  | 4.0         | 4.0  | 4.0  | 4.0         | 4.0  | 4.0  | 4.0        | 4.0  | 4.0   | 4.0        | 4.0  | 4.0  |
| Volume Module: >> Count Date: 8 Oct 2014 << |             |      |      |             |      |      |            |      |       |            |      |      |
| Base Vol:                                   | 201         | 1313 | 108  | 7           | 2417 | 61   | 242        | 16   | 305   | 376        | 35   | 38   |
| Growth Adj:                                 | 1.00        | 1.00 | 1.00 | 1.00        | 1.00 | 1.00 | 1.00       | 1.00 | 1.00  | 1.00       | 1.00 | 1.00 |
| Initial Bse:                                | 201         | 1313 | 108  | 7           | 2417 | 61   | 242        | 16   | 305   | 376        | 35   | 38   |
| Added Vol:                                  | 0           | 0    | 0    | 0           | 0    | 0    | 0          | 0    | 0     | 0          | 0    | 0    |
| PasserByVol:                                | 0           | 0    | 0    | 0           | 0    | 0    | 0          | 0    | 0     | 0          | 0    | 0    |
| Initial Fut:                                | 201         | 1313 | 108  | 7           | 2417 | 61   | 242        | 16   | 305   | 376        | 35   | 38   |
| User Adj:                                   | 1.00        | 1.00 | 1.00 | 1.00        | 1.00 | 1.00 | 1.00       | 1.00 | 1.00  | 1.00       | 1.00 | 1.00 |
| PHF Adj:                                    | 1.00        | 1.00 | 1.00 | 1.00        | 1.00 | 1.00 | 1.00       | 1.00 | 1.00  | 1.00       | 1.00 | 1.00 |
| PHF Volume:                                 | 201         | 1313 | 108  | 7           | 2417 | 61   | 242        | 16   | 305   | 376        | 35   | 38   |
| Reduct Vol:                                 | 0           | 0    | 0    | 0           | 0    | 0    | 0          | 0    | 0     | 0          | 0    | 0    |
| Reduced Vol:                                | 201         | 1313 | 108  | 7           | 2417 | 61   | 242        | 16   | 305   | 376        | 35   | 38   |
| PCE Adj:                                    | 1.00        | 1.00 | 1.00 | 1.00        | 1.00 | 1.00 | 1.00       | 1.00 | 1.00  | 1.00       | 1.00 | 1.00 |
| MLF Adj:                                    | 1.00        | 1.00 | 1.00 | 1.00        | 1.00 | 1.00 | 1.00       | 1.00 | 1.00  | 1.00       | 1.00 | 1.00 |
| Final Volume:                               | 201         | 1313 | 108  | 7           | 2417 | 61   | 242        | 16   | 305   | 376        | 35   | 38   |
| Saturation Flow Module:                     |             |      |      |             |      |      |            |      |       |            |      |      |
| Sat/Lane:                                   | 1900        | 1900 | 1900 | 1900        | 1900 | 1900 | 1900       | 1900 | 1900  | 1900       | 1900 | 1900 |
| Adjustment:                                 | 0.92        | 1.00 | 0.92 | 0.92        | 1.00 | 0.92 | 0.92       | 0.95 | 0.95  | 0.92       | 0.95 | 0.95 |
| Lanes:                                      | 1.00        | 3.00 | 1.00 | 1.00        | 3.00 | 1.00 | 1.00       | 0.05 | 0.95  | 1.00       | 0.48 | 0.52 |
| Final Sat.:                                 | 1750        | 5700 | 1750 | 1750        | 5700 | 1750 | 1750       | 90   | 1710  | 1750       | 863  | 937  |
| Capacity Analysis Module:                   |             |      |      |             |      |      |            |      |       |            |      |      |
| Vol/Sat:                                    | 0.11        | 0.23 | 0.06 | 0.00        | 0.42 | 0.03 | 0.14       | 0.18 | 0.18  | 0.21       | 0.04 | 0.04 |
| Crit Moves:                                 | ****        |      |      | ****        |      |      | ****       |      |       | ****       |      |      |
| Green Time:                                 | 9.6         | 33.7 | 51.7 | 11.4        | 35.5 | 53.7 | 18.2       | 14.9 | 14.9  | 18.0       | 14.7 | 14.7 |
| Volume/Cap:                                 | 1.08        | 0.61 | 0.11 | 0.03        | 1.08 | 0.06 | 0.68       | 1.08 | 1.08  | 1.08       | 0.25 | 0.25 |
| Delay/Veh:                                  | 127.5       | 23.4 | 8.7  | 34.5        | 70.2 | 7.6  | 38.6       | 111  | 111.2 | 105.7      | 33.3 | 33.3 |
| User DelAdj:                                | 1.00        | 1.00 | 1.00 | 1.00        | 1.00 | 1.00 | 1.00       | 1.00 | 1.00  | 1.00       | 1.00 | 1.00 |
| AdjDel/Veh:                                 | 127.5       | 23.4 | 8.7  | 34.5        | 70.2 | 7.6  | 38.6       | 111  | 111.2 | 105.7      | 33.3 | 33.3 |
| LOS by Move:                                | F           | C    | A    | C           | E    | A    | D          | F    | F     | F          | C    | C    |
| HCM2k95thQ:                                 | 17          | 18   | 3    | 0           | 51   | 2    | 15         | 29   | 29    | 29         | 4    | 4    |

Note: Queue reported is the number of cars per lane.

BART

Level Of Service Computation Report  
 2000 HCM Operations (Future Volume Alternative)  
 AM - Cumulative With Project

Intersection #9: Coleman/Brokaw [Study Int 33]

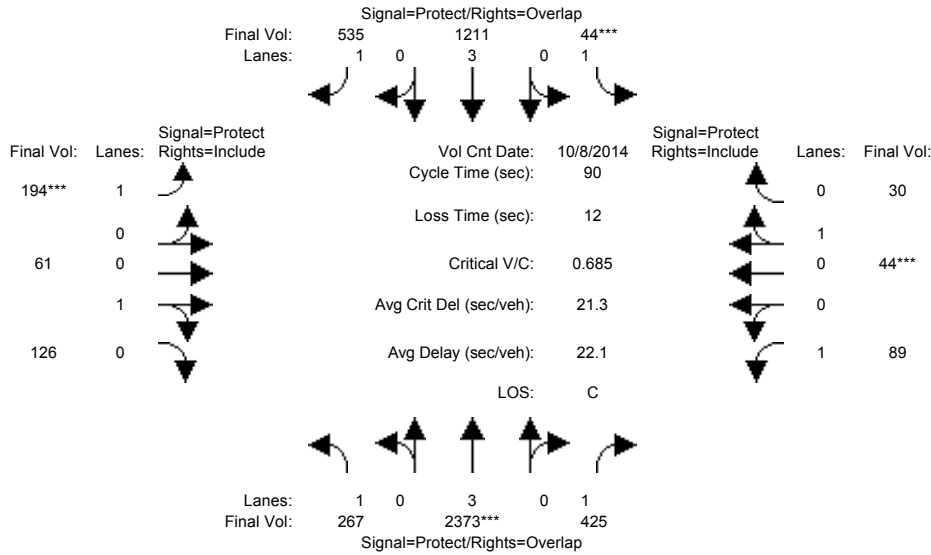

| Approach:                                   | North Bound |      |      | South Bound |      |      | East Bound |      |      | West Bound |      |      |
|---|-------------|------|------|-------------|------|------|------------|------|------|------------|------|------|
| Movement:                                   | L           | T    | R    | L           | T    | R    | L          | T    | R    | L          | T    | R    |
| Min. Green:                                 | 7           | 10   | 10   | 7           | 10   | 10   | 7          | 10   | 10   | 7          | 10   | 10   |
| Y+R:  | 4.0         | 4.0  | 4.0  | 4.0         | 4.0  | 4.0  | 4.0        | 4.0  | 4.0  | 4.0        | 4.0  | 4.0  |
| Volume Module: >> Count Date: 8 Oct 2014 << |             |      |      |             |      |      |            |      |      |            |      |      |
| Base Vol:                                   | 267         | 2373 | 425  | 44          | 1211 | 535  | 194        | 61   | 126  | 89         | 44   | 30   |
| Growth Adj:                                 | 1.00        | 1.00 | 1.00 | 1.00        | 1.00 | 1.00 | 1.00       | 1.00 | 1.00 | 1.00       | 1.00 | 1.00 |
| Initial Bse:                                | 267         | 2373 | 425  | 44          | 1211 | 535  | 194        | 61   | 126  | 89         | 44   | 30   |
| Added Vol:                                  | 0           | 0    | 0    | 0           | 0    | 0    | 0          | 0    | 0    | 0          | 0    | 0    |
| PasserByVol:                                | 0           | 0    | 0    | 0           | 0    | 0    | 0          | 0    | 0    | 0          | 0    | 0    |
| Initial Fut:                                | 267         | 2373 | 425  | 44          | 1211 | 535  | 194        | 61   | 126  | 89         | 44   | 30   |
| User Adj:                                   | 1.00        | 1.00 | 1.00 | 1.00        | 1.00 | 1.00 | 1.00       | 1.00 | 1.00 | 1.00       | 1.00 | 1.00 |
| PHF Adj:                                    | 1.00        | 1.00 | 1.00 | 1.00        | 1.00 | 1.00 | 1.00       | 1.00 | 1.00 | 1.00       | 1.00 | 1.00 |
| PHF Volume:                                 | 267         | 2373 | 425  | 44          | 1211 | 535  | 194        | 61   | 126  | 89         | 44   | 30   |
| Reduct Vol:                                 | 0           | 0    | 0    | 0           | 0    | 0    | 0          | 0    | 0    | 0          | 0    | 0    |
| Reduced Vol:                                | 267         | 2373 | 425  | 44          | 1211 | 535  | 194        | 61   | 126  | 89         | 44   | 30   |
| PCE Adj:                                    | 1.00        | 1.00 | 1.00 | 1.00        | 1.00 | 1.00 | 1.00       | 1.00 | 1.00 | 1.00       | 1.00 | 1.00 |
| MLF Adj:                                    | 1.00        | 1.00 | 1.00 | 1.00        | 1.00 | 1.00 | 1.00       | 1.00 | 1.00 | 1.00       | 1.00 | 1.00 |
| Final Volume:                               | 267         | 2373 | 425  | 44          | 1211 | 535  | 194        | 61   | 126  | 89         | 44   | 30   |
| Saturation Flow Module:                     |             |      |      |             |      |      |            |      |      |            |      |      |
| Sat/Lane:                                   | 1900        | 1900 | 1900 | 1900        | 1900 | 1900 | 1900       | 1900 | 1900 | 1900       | 1900 | 1900 |
| Adjustment:                                 | 0.92        | 1.00 | 0.92 | 0.92        | 1.00 | 0.92 | 0.92       | 0.95 | 0.95 | 0.92       | 0.95 | 0.95 |
| Lanes:                                      | 1.00        | 3.00 | 1.00 | 1.00        | 3.00 | 1.00 | 1.00       | 0.33 | 0.67 | 1.00       | 0.59 | 0.41 |
| Final Sat.:                                 | 1750        | 5700 | 1750 | 1750        | 5700 | 1750 | 1750       | 587  | 1213 | 1750       | 1070 | 730  |
| Capacity Analysis Module:                   |             |      |      |             |      |      |            |      |      |            |      |      |
| Vol/Sat:                                    | 0.15        | 0.42 | 0.24 | 0.03        | 0.21 | 0.31 | 0.11       | 0.10 | 0.10 | 0.05       | 0.04 | 0.04 |
| Crit Moves:                                 | ****        | **** | **** | ****        | **** | **** | ****       | **** | **** | ****       | **** | **** |
| Green Time:                                 | 23.1        | 48.2 | 57.6 | 7.0         | 32.1 | 44.9 | 12.8       | 13.4 | 13.4 | 9.4        | 10.0 | 10.0 |
| Volume/Cap:                                 | 0.60        | 0.78 | 0.38 | 0.32        | 0.60 | 0.61 | 0.78       | 0.70 | 0.70 | 0.49       | 0.37 | 0.37 |
| Delay/Veh:                                  | 31.6        | 18.0 | 7.9  | 40.6        | 24.1 | 17.5 | 51.5       | 44.1 | 44.1 | 40.1       | 38.2 | 38.2 |
| User DelAdj:                                | 1.00        | 1.00 | 1.00 | 1.00        | 1.00 | 1.00 | 1.00       | 1.00 | 1.00 | 1.00       | 1.00 | 1.00 |
| AdjDel/Veh:                                 | 31.6        | 18.0 | 7.9  | 40.6        | 24.1 | 17.5 | 51.5       | 44.1 | 44.1 | 40.1       | 38.2 | 38.2 |
| LOS by Move:                                | C           | B    | A    | D           | C    | B    | D          | D    | D    | D          | D    | D    |
| HCM2k95thQ:                                 | 12          | 28   | 11   | 3           | 17   | 21   | 15         | 13   | 13   | 5          | 4    | 4    |

Note: Queue reported is the number of cars per lane.

BART

Level Of Service Computation Report  
2000 HCM Operations (Future Volume Alternative)  
PM - Cumulative With Project

Intersection #9: Coleman/Brokaw [Study Int 33]

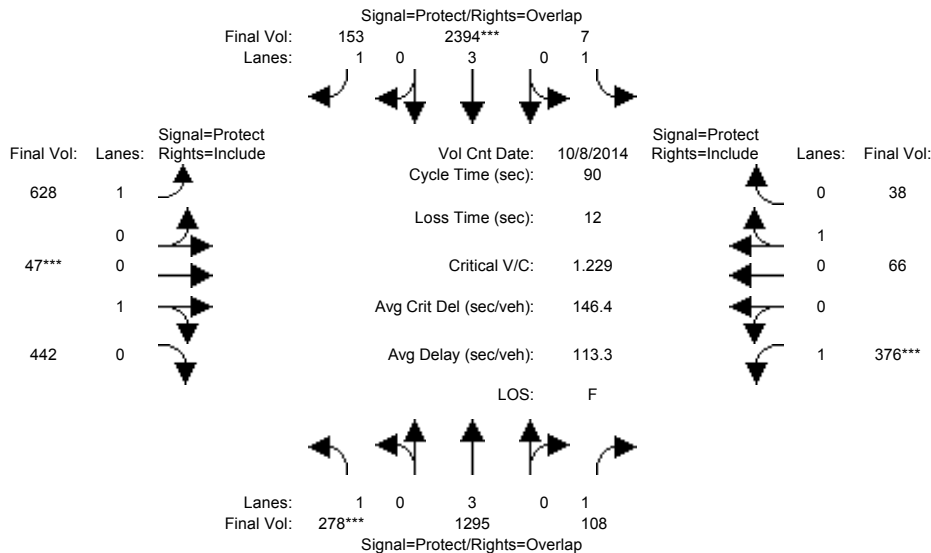

| Approach:                                   | North Bound |      |      | South Bound |      |      | East Bound |      |       | West Bound |      |      |
|---|-------------|------|------|-------------|------|------|------------|------|-------|------------|------|------|
| Movement:                                   | L           | T    | R    | L           | T    | R    | L          | T    | R     | L          | T    | R    |
| Min. Green:                                 | 7           | 10   | 10   | 7           | 10   | 10   | 7          | 10   | 10    | 7          | 10   | 10   |
| Y+R:  | 4.0         | 4.0  | 4.0  | 4.0         | 4.0  | 4.0  | 4.0        | 4.0  | 4.0   | 4.0        | 4.0  | 4.0  |
| Volume Module: >> Count Date: 8 Oct 2014 << |             |      |      |             |      |      |            |      |       |            |      |      |
| Base Vol:                                   | 278         | 1295 | 108  | 7           | 2394 | 153  | 628        | 47   | 442   | 376        | 66   | 38   |
| Growth Adj:                                 | 1.00        | 1.00 | 1.00 | 1.00        | 1.00 | 1.00 | 1.00       | 1.00 | 1.00  | 1.00       | 1.00 | 1.00 |
| Initial Bse:                                | 278         | 1295 | 108  | 7           | 2394 | 153  | 628        | 47   | 442   | 376        | 66   | 38   |
| Added Vol:                                  | 0           | 0    | 0    | 0           | 0    | 0    | 0          | 0    | 0     | 0          | 0    | 0    |
| PasserByVol:                                | 0           | 0    | 0    | 0           | 0    | 0    | 0          | 0    | 0     | 0          | 0    | 0    |
| Initial Fut:                                | 278         | 1295 | 108  | 7           | 2394 | 153  | 628        | 47   | 442   | 376        | 66   | 38   |
| User Adj:                                   | 1.00        | 1.00 | 1.00 | 1.00        | 1.00 | 1.00 | 1.00       | 1.00 | 1.00  | 1.00       | 1.00 | 1.00 |
| PHF Adj:                                    | 1.00        | 1.00 | 1.00 | 1.00        | 1.00 | 1.00 | 1.00       | 1.00 | 1.00  | 1.00       | 1.00 | 1.00 |
| PHF Volume:                                 | 278         | 1295 | 108  | 7           | 2394 | 153  | 628        | 47   | 442   | 376        | 66   | 38   |
| Reduct Vol:                                 | 0           | 0    | 0    | 0           | 0    | 0    | 0          | 0    | 0     | 0          | 0    | 0    |
| Reduced Vol:                                | 278         | 1295 | 108  | 7           | 2394 | 153  | 628        | 47   | 442   | 376        | 66   | 38   |
| PCE Adj:                                    | 1.00        | 1.00 | 1.00 | 1.00        | 1.00 | 1.00 | 1.00       | 1.00 | 1.00  | 1.00       | 1.00 | 1.00 |
| MLF Adj:                                    | 1.00        | 1.00 | 1.00 | 1.00        | 1.00 | 1.00 | 1.00       | 1.00 | 1.00  | 1.00       | 1.00 | 1.00 |
| Final Volume:                               | 278         | 1295 | 108  | 7           | 2394 | 153  | 628        | 47   | 442   | 376        | 66   | 38   |
| Saturation Flow Module:                     |             |      |      |             |      |      |            |      |       |            |      |      |
| Sat/Lane:                                   | 1900        | 1900 | 1900 | 1900        | 1900 | 1900 | 1900       | 1900 | 1900  | 1900       | 1900 | 1900 |
| Adjustment:                                 | 0.92        | 1.00 | 0.92 | 0.92        | 1.00 | 0.92 | 0.92       | 0.95 | 0.95  | 0.92       | 0.95 | 0.95 |
| Lanes:                                      | 1.00        | 3.00 | 1.00 | 1.00        | 3.00 | 1.00 | 1.00       | 0.10 | 0.90  | 1.00       | 0.63 | 0.37 |
| Final Sat.:                                 | 1750        | 5700 | 1750 | 1750        | 5700 | 1750 | 1750       | 173  | 1627  | 1750       | 1142 | 658  |
| Capacity Analysis Module:                   |             |      |      |             |      |      |            |      |       |            |      |      |
| Vol/Sat:                                    | 0.16        | 0.23 | 0.06 | 0.00        | 0.42 | 0.09 | 0.36       | 0.27 | 0.27  | 0.21       | 0.06 | 0.06 |
| Crit Moves:                                 | ****        |      |      | ****        |      |      | ****       |      |       | ****       |      |      |
| Green Time:                                 | 11.6        | 31.6 | 47.3 | 10.8        | 30.7 | 56.4 | 25.6       | 19.9 | 19.9  | 15.7       | 10.0 | 10.0 |
| Volume/Cap:                                 | 1.23        | 0.65 | 0.12 | 0.03        | 1.23 | 0.14 | 1.26       | 1.23 | 1.23  | 1.23       | 0.52 | 0.52 |
| Delay/Veh:                                  | 174.8       | 25.3 | 10.9 | 35.0        | 138  | 6.9  | 164.9      | 159  | 158.5 | 165.6      | 40.2 |      |
| User DelAdj:                                | 1.00        | 1.00 | 1.00 | 1.00        | 1.00 | 1.00 | 1.00       | 1.00 | 1.00  | 1.00       | 1.00 | 1.00 |
| AdjDel/Veh:                                 | 174.8       | 25.3 | 10.9 | 35.0        | 138  | 6.9  | 164.9      | 159  | 158.5 | 165.6      | 40.2 |      |
| LOS by Move:                                | F           | C    | B    | D           | F    | A    | F          | F    | F     | F          | D    | D    |
| HCM2k95thQ:                                 | 27          | 18   | 3    | 0           | 64   | 4    | 61         | 47   | 47    | 36         | 6    | 6    |

Note: Queue reported is the number of cars per lane.

BART

Level Of Service Computation Report  
 2000 HCM Operations (Future Volume Alternative)  
 AM - Cumulative No Project

Intersection #106: Benton/E/ Camino Real [Study Int 52]

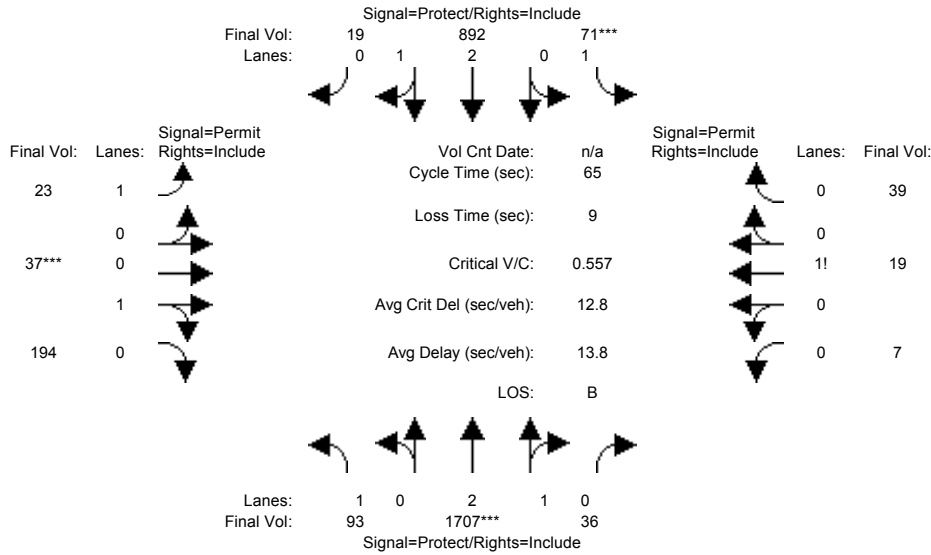

| Approach:                 | North Bound |      |      | South Bound |      |      | East Bound |      |      | West Bound |      |      |
|---------------------------|-------------|------|------|-------------|------|------|------------|------|------|------------|------|------|
| Movement:                 | L           | T    | R    | L           | T    | R    | L          | T    | R    | L          | T    | R    |
| Min. Green:               | 7           | 10   | 10   | 7           | 10   | 10   | 10         | 10   | 10   | 10         | 10   | 10   |
| Y+R:                      | 4.0         | 4.0  | 4.0  | 4.0         | 4.0  | 4.0  | 4.0        | 4.0  | 4.0  | 4.0        | 4.0  | 4.0  |
| Volume Module:            |             |      |      |             |      |      |            |      |      |            |      |      |
| Base Vol:                 | 93          | 1707 | 36   | 71          | 892  | 19   | 23         | 37   | 194  | 7          | 19   | 39   |
| Growth Adj:               | 1.00        | 1.00 | 1.00 | 1.00        | 1.00 | 1.00 | 1.00       | 1.00 | 1.00 | 1.00       | 1.00 | 1.00 |
| Initial Bse:              | 93          | 1707 | 36   | 71          | 892  | 19   | 23         | 37   | 194  | 7          | 19   | 39   |
| Added Vol:                | 0           | 0    | 0    | 0           | 0    | 0    | 0          | 0    | 0    | 0          | 0    | 0    |
| PasserByVol:              | 0           | 0    | 0    | 0           | 0    | 0    | 0          | 0    | 0    | 0          | 0    | 0    |
| Initial Fut:              | 93          | 1707 | 36   | 71          | 892  | 19   | 23         | 37   | 194  | 7          | 19   | 39   |
| User Adj:                 | 1.00        | 1.00 | 1.00 | 1.00        | 1.00 | 1.00 | 1.00       | 1.00 | 1.00 | 1.00       | 1.00 | 1.00 |
| PHF Adj:                  | 1.00        | 1.00 | 1.00 | 1.00        | 1.00 | 1.00 | 1.00       | 1.00 | 1.00 | 1.00       | 1.00 | 1.00 |
| PHF Volume:               | 93          | 1707 | 36   | 71          | 892  | 19   | 23         | 37   | 194  | 7          | 19   | 39   |
| Reduct Vol:               | 0           | 0    | 0    | 0           | 0    | 0    | 0          | 0    | 0    | 0          | 0    | 0    |
| Reduced Vol:              | 93          | 1707 | 36   | 71          | 892  | 19   | 23         | 37   | 194  | 7          | 19   | 39   |
| PCE Adj:                  | 1.00        | 1.00 | 1.00 | 1.00        | 1.00 | 1.00 | 1.00       | 1.00 | 1.00 | 1.00       | 1.00 | 1.00 |
| MLF Adj:                  | 1.00        | 1.00 | 1.00 | 1.00        | 1.00 | 1.00 | 1.00       | 1.00 | 1.00 | 1.00       | 1.00 | 1.00 |
| FinalVolume:              | 93          | 1707 | 36   | 71          | 892  | 19   | 23         | 37   | 194  | 7          | 19   | 39   |
| Saturation Flow Module:   |             |      |      |             |      |      |            |      |      |            |      |      |
| Sat/Lane:                 | 1900        | 1900 | 1900 | 1900        | 1900 | 1900 | 1900       | 1900 | 1900 | 1900       | 1900 | 1900 |
| Adjustment:               | 0.92        | 0.98 | 0.95 | 0.92        | 0.98 | 0.95 | 0.92       | 0.95 | 0.95 | 0.92       | 0.92 | 0.92 |
| Lanes:                    | 1.00        | 2.94 | 0.06 | 1.00        | 2.94 | 0.06 | 1.00       | 0.16 | 0.84 | 0.11       | 0.29 | 0.60 |
| Final Sat.:               | 1750        | 5484 | 116  | 1750        | 5483 | 117  | 1750       | 288  | 1512 | 188        | 512  | 1050 |
| Capacity Analysis Module: |             |      |      |             |      |      |            |      |      |            |      |      |
| Vol/Sat:                  | 0.05        | 0.31 | 0.31 | 0.04        | 0.16 | 0.16 | 0.01       | 0.13 | 0.13 | 0.04       | 0.04 | 0.04 |
| Crit Moves:               | ****        | **** | **** | ****        | **** | **** | ****       | **** | **** | ****       | **** | **** |
| Green Time:               | 16.6        | 34.7 | 34.7 | 7.0         | 25.1 | 25.1 | 14.3       | 14.3 | 14.3 | 14.3       | 14.3 | 14.3 |
| Volume/Cap:               | 0.21        | 0.58 | 0.58 | 0.38        | 0.42 | 0.42 | 0.06       | 0.58 | 0.58 | 0.17       | 0.17 | 0.17 |
| Delay/Veh:                | 19.3        | 10.6 | 10.6 | 28.2        | 14.8 | 14.8 | 20.1       | 24.9 | 24.9 | 20.7       | 20.7 | 20.7 |
| User DelAdj:              | 1.00        | 1.00 | 1.00 | 1.00        | 1.00 | 1.00 | 1.00       | 1.00 | 1.00 | 1.00       | 1.00 | 1.00 |
| AdjDel/Veh:               | 19.3        | 10.6 | 10.6 | 28.2        | 14.8 | 14.8 | 20.1       | 24.9 | 24.9 | 20.7       | 20.7 | 20.7 |
| LOS by Move:              | B           | B    | B    | C           | B    | B    | C          | C    | C    | C          | C    | C    |
| HCM2k95thQ:               | 3           | 15   | 15   | 3           | 9    | 9    | 1          | 9    | 9    | 3          | 3    | 3    |

Note: Queue reported is the number of cars per lane.



BART

Level Of Service Computation Report  
2000 HCM Operations (Future Volume Alternative)  
PM - Cumulative No Project

Intersection #106: Benton/E/ Camino Real [Study Int 52]

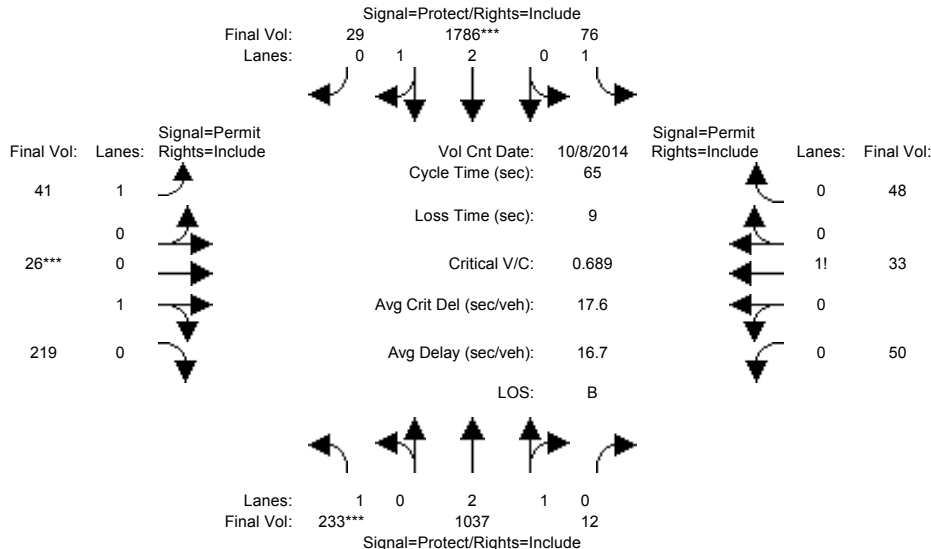

| Approach:                                   | North Bound |      |      | South Bound |      |      | East Bound |      |      | West Bound |      |      |
|---|-------------|------|------|-------------|------|------|------------|------|------|------------|------|------|
| Movement:                                   | L           | T    | R    | L           | T    | R    | L          | T    | R    | L          | T    | R    |
| Min. Green:                                 | 7           | 10   | 10   | 7           | 10   | 10   | 10         | 10   | 10   | 10         | 10   | 10   |
| Y+R:  | 4.0         | 4.0  | 4.0  | 4.0         | 4.0  | 4.0  | 4.0        | 4.0  | 4.0  | 4.0        | 4.0  | 4.0  |
| Volume Module: >> Count Date: 8 Oct 2014 << |             |      |      |             |      |      |            |      |      |            |      |      |
| Base Vol:                                   | 233         | 1037 | 12   | 76          | 1786 | 29   | 41         | 26   | 219  | 50         | 33   | 48   |
| Growth Adj:                                 | 1.00        | 1.00 | 1.00 | 1.00        | 1.00 | 1.00 | 1.00       | 1.00 | 1.00 | 1.00       | 1.00 | 1.00 |
| Initial Bse:                                | 233         | 1037 | 12   | 76          | 1786 | 29   | 41         | 26   | 219  | 50         | 33   | 48   |
| Added Vol:                                  | 0           | 0    | 0    | 0           | 0    | 0    | 0          | 0    | 0    | 0          | 0    | 0    |
| PasserByVol:                                | 0           | 0    | 0    | 0           | 0    | 0    | 0          | 0    | 0    | 0          | 0    | 0    |
| Initial Fut:                                | 233         | 1037 | 12   | 76          | 1786 | 29   | 41         | 26   | 219  | 50         | 33   | 48   |
| User Adj:                                   | 1.00        | 1.00 | 1.00 | 1.00        | 1.00 | 1.00 | 1.00       | 1.00 | 1.00 | 1.00       | 1.00 | 1.00 |
| PHF Adj:                                    | 1.00        | 1.00 | 1.00 | 1.00        | 1.00 | 1.00 | 1.00       | 1.00 | 1.00 | 1.00       | 1.00 | 1.00 |
| PHF Volume:                                 | 233         | 1037 | 12   | 76          | 1786 | 29   | 41         | 26   | 219  | 50         | 33   | 48   |
| Reduct Vol:                                 | 0           | 0    | 0    | 0           | 0    | 0    | 0          | 0    | 0    | 0          | 0    | 0    |
| Reduced Vol:                                | 233         | 1037 | 12   | 76          | 1786 | 29   | 41         | 26   | 219  | 50         | 33   | 48   |
| PCE Adj:                                    | 1.00        | 1.00 | 1.00 | 1.00        | 1.00 | 1.00 | 1.00       | 1.00 | 1.00 | 1.00       | 1.00 | 1.00 |
| MLF Adj:                                    | 1.00        | 1.00 | 1.00 | 1.00        | 1.00 | 1.00 | 1.00       | 1.00 | 1.00 | 1.00       | 1.00 | 1.00 |
| Final Volume:                               | 233         | 1037 | 12   | 76          | 1786 | 29   | 41         | 26   | 219  | 50         | 33   | 48   |
| Saturation Flow Module:                     |             |      |      |             |      |      |            |      |      |            |      |      |
| Sat/Lane:                                   | 1900        | 1900 | 1900 | 1900        | 1900 | 1900 | 1900       | 1900 | 1900 | 1900       | 1900 | 1900 |
| Adjustment:                                 | 0.92        | 0.98 | 0.95 | 0.92        | 0.98 | 0.95 | 0.92       | 0.95 | 0.95 | 0.92       | 0.92 | 0.92 |
| Lanes:                                      | 1.00        | 2.96 | 0.04 | 1.00        | 2.95 | 0.05 | 1.00       | 0.11 | 0.89 | 0.38       | 0.25 | 0.37 |
| Final Sat.:                                 | 1750        | 5536 | 64   | 1750        | 5510 | 89   | 1750       | 191  | 1609 | 668        | 441  | 641  |
| Capacity Analysis Module:                   |             |      |      |             |      |      |            |      |      |            |      |      |
| Vol/Sat:                                    | 0.13        | 0.19 | 0.19 | 0.04        | 0.32 | 0.32 | 0.02       | 0.14 | 0.14 | 0.07       | 0.07 | 0.07 |
| Crit Moves:                                 | ****        |      |      | ****        |      |      | ****       |      |      |            |      |      |
| Green Time:                                 | 12.6        | 27.4 | 27.4 | 15.8        | 30.6 | 30.6 | 12.8       | 12.8 | 12.8 | 12.8       | 12.8 | 12.8 |
| Volume/Cap:                                 | 0.69        | 0.44 | 0.44 | 0.18        | 0.69 | 0.69 | 0.12       | 0.69 | 0.69 | 0.38       | 0.38 | 0.38 |
| Delay/Veh:                                  | 30.3        | 13.5 | 13.5 | 19.7        | 14.3 | 14.3 | 21.6       | 29.8 | 29.8 | 23.3       | 23.3 | 23.3 |
| User DelAdj:                                | 1.00        | 1.00 | 1.00 | 1.00        | 1.00 | 1.00 | 1.00       | 1.00 | 1.00 | 1.00       | 1.00 | 1.00 |
| AdjDel/Veh:                                 | 30.3        | 13.5 | 13.5 | 19.7        | 14.3 | 14.3 | 21.6       | 29.8 | 29.8 | 23.3       | 23.3 | 23.3 |
| LOS by Move:                                | C           | B    | B    | B           | B    | B    | C          | C    | C    | C          | C    | C    |
| HCM2k95thQ:                                 | 9           | 10   | 10   | 3           | 18   | 18   | 1          | 10   | 10   | 6          | 6    | 6    |

Note: Queue reported is the number of cars per lane.

BART

Level Of Service Computation Report  
 2000 HCM Operations (Future Volume Alternative)  
 AM - Cumulative With Project

Intersection #106: Benton/E/ Camino Real [Study Int 52]

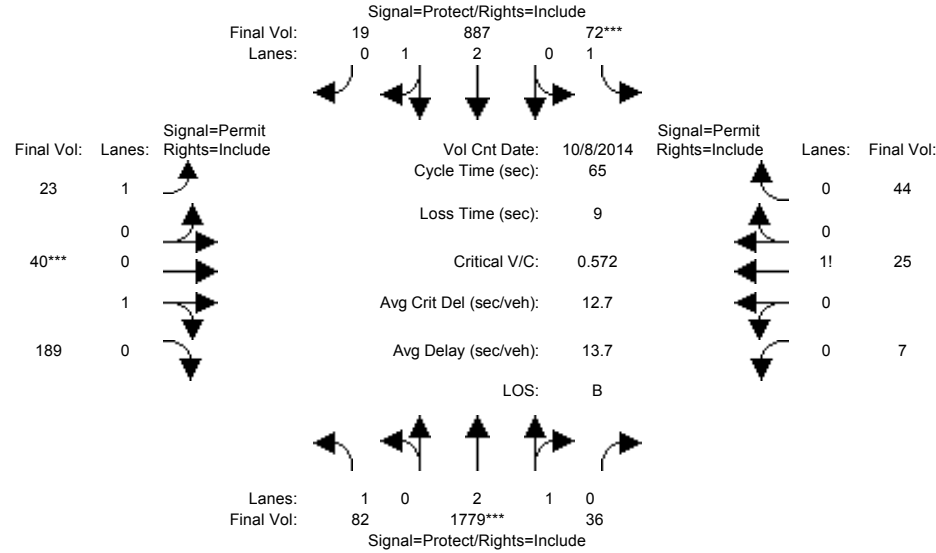

| Approach:                                   | North Bound |      |      | South Bound |      |      | East Bound |      |      | West Bound |      |      |
|---|-------------|------|------|-------------|------|------|------------|------|------|------------|------|------|
| Movement:                                   | L           | T    | R    | L           | T    | R    | L          | T    | R    | L          | T    | R    |
| Min. Green:                                 | 7           | 10   | 10   | 7           | 10   | 10   | 10         | 10   | 10   | 10         | 10   | 10   |
| Y+R:  | 4.0         | 4.0  | 4.0  | 4.0         | 4.0  | 4.0  | 4.0        | 4.0  | 4.0  | 4.0        | 4.0  | 4.0  |
| -----                                       |             |      |      |             |      |      |            |      |      |            |      |      |
| Volume Module: >> Count Date: 8 Oct 2014 << |             |      |      |             |      |      |            |      |      |            |      |      |
| Base Vol:                                   | 82          | 1779 | 36   | 72          | 887  | 19   | 23         | 40   | 189  | 7          | 25   | 44   |
| Growth Adj:                                 | 1.00        | 1.00 | 1.00 | 1.00        | 1.00 | 1.00 | 1.00       | 1.00 | 1.00 | 1.00       | 1.00 | 1.00 |
| Initial Bse:                                | 82          | 1779 | 36   | 72          | 887  | 19   | 23         | 40   | 189  | 7          | 25   | 44   |
| Added Vol:                                  | 0           | 0    | 0    | 0           | 0    | 0    | 0          | 0    | 0    | 0          | 0    | 0    |
| PasserByVol:                                | 0           | 0    | 0    | 0           | 0    | 0    | 0          | 0    | 0    | 0          | 0    | 0    |
| Initial Fut:                                | 82          | 1779 | 36   | 72          | 887  | 19   | 23         | 40   | 189  | 7          | 25   | 44   |
| User Adj:                                   | 1.00        | 1.00 | 1.00 | 1.00        | 1.00 | 1.00 | 1.00       | 1.00 | 1.00 | 1.00       | 1.00 | 1.00 |
| PHF Adj:                                    | 1.00        | 1.00 | 1.00 | 1.00        | 1.00 | 1.00 | 1.00       | 1.00 | 1.00 | 1.00       | 1.00 | 1.00 |
| PHF Volume:                                 | 82          | 1779 | 36   | 72          | 887  | 19   | 23         | 40   | 189  | 7          | 25   | 44   |
| Reduct Vol:                                 | 0           | 0    | 0    | 0           | 0    | 0    | 0          | 0    | 0    | 0          | 0    | 0    |
| Reduced Vol:                                | 82          | 1779 | 36   | 72          | 887  | 19   | 23         | 40   | 189  | 7          | 25   | 44   |
| PCE Adj:                                    | 1.00        | 1.00 | 1.00 | 1.00        | 1.00 | 1.00 | 1.00       | 1.00 | 1.00 | 1.00       | 1.00 | 1.00 |
| MLF Adj:                                    | 1.00        | 1.00 | 1.00 | 1.00        | 1.00 | 1.00 | 1.00       | 1.00 | 1.00 | 1.00       | 1.00 | 1.00 |
| Final Volume:                               | 82          | 1779 | 36   | 72          | 887  | 19   | 23         | 40   | 189  | 7          | 25   | 44   |
| -----                                       |             |      |      |             |      |      |            |      |      |            |      |      |
| Saturation Flow Module:                     |             |      |      |             |      |      |            |      |      |            |      |      |
| Sat/Lane:                                   | 1900        | 1900 | 1900 | 1900        | 1900 | 1900 | 1900       | 1900 | 1900 | 1900       | 1900 | 1900 |
| Adjustment:                                 | 0.92        | 0.98 | 0.95 | 0.92        | 0.98 | 0.95 | 0.92       | 0.95 | 0.95 | 0.92       | 0.92 | 0.92 |
| Lanes:                                      | 1.00        | 2.94 | 0.06 | 1.00        | 2.93 | 0.07 | 1.00       | 0.17 | 0.83 | 0.09       | 0.33 | 0.58 |
| Final Sat.:                                 | 1750        | 5489 | 111  | 1750        | 5482 | 117  | 1750       | 314  | 1486 | 161        | 576  | 1013 |
| -----                                       |             |      |      |             |      |      |            |      |      |            |      |      |
| Capacity Analysis Module:                   |             |      |      |             |      |      |            |      |      |            |      |      |
| Vol/Sat:                                    | 0.05        | 0.32 | 0.32 | 0.04        | 0.16 | 0.16 | 0.01       | 0.13 | 0.13 | 0.04       | 0.04 | 0.04 |
| Crit Moves:                                 | ****        | **** | **** | ****        | **** | **** | ****       | **** | **** | ****       | **** | **** |
| Green Time:                                 | 16.9        | 35.2 | 35.2 | 7.0         | 25.3 | 25.3 | 13.8       | 13.8 | 13.8 | 13.8       | 13.8 | 13.8 |
| Volume/Cap:                                 | 0.18        | 0.60 | 0.60 | 0.38        | 0.42 | 0.42 | 0.06       | 0.60 | 0.60 | 0.20       | 0.20 | 0.20 |
| Delay/Veh:                                  | 18.9        | 10.4 | 10.4 | 28.3        | 14.6 | 14.6 | 20.5       | 25.7 | 25.7 | 21.3       | 21.3 | 21.3 |
| User DelAdj:                                | 1.00        | 1.00 | 1.00 | 1.00        | 1.00 | 1.00 | 1.00       | 1.00 | 1.00 | 1.00       | 1.00 | 1.00 |
| AdjDel/Veh:                                 | 18.9        | 10.4 | 10.4 | 28.3        | 14.6 | 14.6 | 20.5       | 25.7 | 25.7 | 21.3       | 21.3 | 21.3 |
| LOS by Move:                                | B           | B    | B    | C           | B    | B    | C          | C    | C    | C          | C    | C    |
| HCM2k95thQ:                                 | 3           | 15   | 15   | 3           | 9    | 9    | 1          | 9    | 9    | 3          | 3    | 3    |

Note: Queue reported is the number of cars per lane.

BART

Level Of Service Computation Report  
2000 HCM Operations (Future Volume Alternative)  
PM - Cumulative With Project

Intersection #106: Benton/E/ Camino Real [Study Int 52]

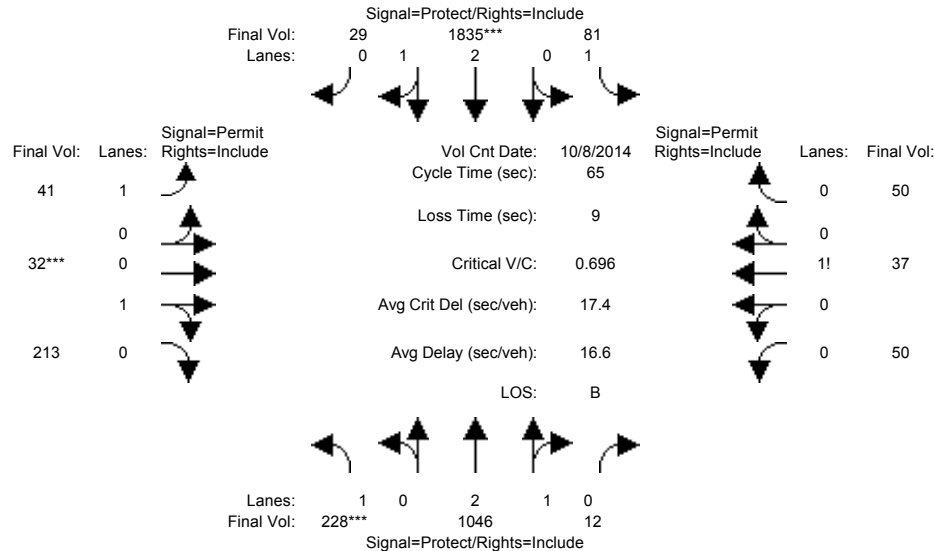

| Approach:                                   | North Bound |      |      | South Bound |      |      | East Bound |      |      | West Bound |      |      |
|---|-------------|------|------|-------------|------|------|------------|------|------|------------|------|------|
| Movement:                                   | L           | T    | R    | L           | T    | R    | L          | T    | R    | L          | T    | R    |
| Min. Green:                                 | 7           | 10   | 10   | 7           | 10   | 10   | 10         | 10   | 10   | 10         | 10   | 10   |
| Y+R:  | 4.0         | 4.0  | 4.0  | 4.0         | 4.0  | 4.0  | 4.0        | 4.0  | 4.0  | 4.0        | 4.0  | 4.0  |
| Volume Module: >> Count Date: 8 Oct 2014 << |             |      |      |             |      |      |            |      |      |            |      |      |
| Base Vol:                                   | 228         | 1046 | 12   | 81          | 1835 | 29   | 41         | 32   | 213  | 50         | 37   | 50   |
| Growth Adj:                                 | 1.00        | 1.00 | 1.00 | 1.00        | 1.00 | 1.00 | 1.00       | 1.00 | 1.00 | 1.00       | 1.00 | 1.00 |
| Initial Bse:                                | 228         | 1046 | 12   | 81          | 1835 | 29   | 41         | 32   | 213  | 50         | 37   | 50   |
| Added Vol:                                  | 0           | 0    | 0    | 0           | 0    | 0    | 0          | 0    | 0    | 0          | 0    | 0    |
| PasserByVol:                                | 0           | 0    | 0    | 0           | 0    | 0    | 0          | 0    | 0    | 0          | 0    | 0    |
| Initial Fut:                                | 228         | 1046 | 12   | 81          | 1835 | 29   | 41         | 32   | 213  | 50         | 37   | 50   |
| User Adj:                                   | 1.00        | 1.00 | 1.00 | 1.00        | 1.00 | 1.00 | 1.00       | 1.00 | 1.00 | 1.00       | 1.00 | 1.00 |
| PHF Adj:                                    | 1.00        | 1.00 | 1.00 | 1.00        | 1.00 | 1.00 | 1.00       | 1.00 | 1.00 | 1.00       | 1.00 | 1.00 |
| PHF Volume:                                 | 228         | 1046 | 12   | 81          | 1835 | 29   | 41         | 32   | 213  | 50         | 37   | 50   |
| Reduct Vol:                                 | 0           | 0    | 0    | 0           | 0    | 0    | 0          | 0    | 0    | 0          | 0    | 0    |
| Reduced Vol:                                | 228         | 1046 | 12   | 81          | 1835 | 29   | 41         | 32   | 213  | 50         | 37   | 50   |
| PCE Adj:                                    | 1.00        | 1.00 | 1.00 | 1.00        | 1.00 | 1.00 | 1.00       | 1.00 | 1.00 | 1.00       | 1.00 | 1.00 |
| MLF Adj:                                    | 1.00        | 1.00 | 1.00 | 1.00        | 1.00 | 1.00 | 1.00       | 1.00 | 1.00 | 1.00       | 1.00 | 1.00 |
| FinalVolume:                                | 228         | 1046 | 12   | 81          | 1835 | 29   | 41         | 32   | 213  | 50         | 37   | 50   |
| Saturation Flow Module:                     |             |      |      |             |      |      |            |      |      |            |      |      |
| Sat/Lane:                                   | 1900        | 1900 | 1900 | 1900        | 1900 | 1900 | 1900       | 1900 | 1900 | 1900       | 1900 | 1900 |
| Adjustment:                                 | 0.92        | 0.98 | 0.95 | 0.92        | 0.98 | 0.95 | 0.92       | 0.95 | 0.95 | 0.92       | 0.92 | 0.92 |
| Lanes:                                      | 1.00        | 2.96 | 0.04 | 1.00        | 2.95 | 0.05 | 1.00       | 0.13 | 0.87 | 0.37       | 0.27 | 0.36 |
| Final Sat.:                                 | 1750        | 5536 | 64   | 1750        | 5513 | 87   | 1750       | 235  | 1565 | 639        | 473  | 639  |
| Capacity Analysis Module:                   |             |      |      |             |      |      |            |      |      |            |      |      |
| Vol/Sat:                                    | 0.13        | 0.19 | 0.19 | 0.05        | 0.33 | 0.33 | 0.02       | 0.14 | 0.14 | 0.08       | 0.08 | 0.08 |
| Crit Moves:                                 | ****        |      |      | ****        |      |      | ****       |      |      |            |      |      |
| Green Time:                                 | 12.2        | 27.6 | 27.6 | 15.7        | 31.1 | 31.1 | 12.7       | 12.7 | 12.7 | 12.7       | 12.7 | 12.7 |
| Volume/Cap:                                 | 0.70        | 0.45 | 0.45 | 0.19        | 0.70 | 0.70 | 0.12       | 0.70 | 0.70 | 0.40       | 0.40 | 0.40 |
| Delay/Veh:                                  | 31.1        | 13.4 | 13.4 | 19.8        | 14.1 | 14.1 | 21.7       | 30.3 | 30.3 | 23.6       | 23.6 | 23.6 |
| User DelAdj:                                | 1.00        | 1.00 | 1.00 | 1.00        | 1.00 | 1.00 | 1.00       | 1.00 | 1.00 | 1.00       | 1.00 | 1.00 |
| AdjDel/Veh:                                 | 31.1        | 13.4 | 13.4 | 19.8        | 14.1 | 14.1 | 21.7       | 30.3 | 30.3 | 23.6       | 23.6 | 23.6 |
| LOS by Move:                                | C           | B    | B    | B           | B    | B    | C          | C    | C    | C          | C    | C    |
| HCM2k95thQ:                                 | 9           | 10   | 10   | 3           | 19   | 19   | 1          | 10   | 10   | 6          | 6    | 6    |

Note: Queue reported is the number of cars per lane.

BART

Level Of Service Computation Report  
2000 HCM Operations (Future Volume Alternative)  
AM - Cumulative No Project

Intersection #107: Lafayette/Benton [Study Int 49]

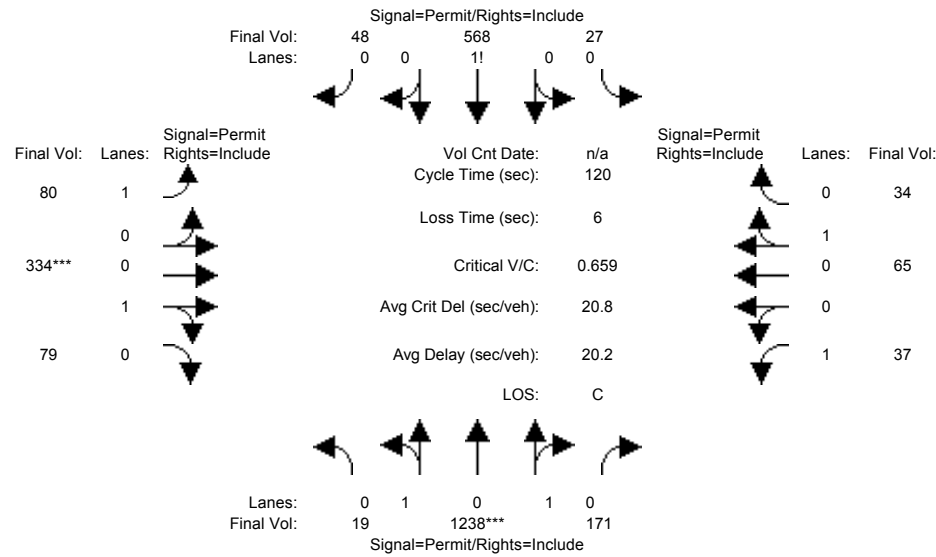

| Approach:                 | North Bound |      |      | South Bound |      |      | East Bound |      |      | West Bound |      |      |
|---------------------------|-------------|------|------|-------------|------|------|------------|------|------|------------|------|------|
| Movement:                 | L           | T    | R    | L           | T    | R    | L          | T    | R    | L          | T    | R    |
| Min. Green:               | 10          | 10   | 10   | 10          | 10   | 10   | 10         | 10   | 10   | 10         | 10   | 10   |
| Y+R:                      | 4.0         | 4.0  | 4.0  | 4.0         | 4.0  | 4.0  | 4.0        | 4.0  | 4.0  | 4.0        | 4.0  | 4.0  |
| Volume Module:            |             |      |      |             |      |      |            |      |      |            |      |      |
| Base Vol:                 | 19          | 1238 | 171  | 27          | 568  | 48   | 80         | 334  | 79   | 37         | 65   | 34   |
| Growth Adj:               | 1.00        | 1.00 | 1.00 | 1.00        | 1.00 | 1.00 | 1.00       | 1.00 | 1.00 | 1.00       | 1.00 | 1.00 |
| Initial Bse:              | 19          | 1238 | 171  | 27          | 568  | 48   | 80         | 334  | 79   | 37         | 65   | 34   |
| Added Vol:                | 0           | 0    | 0    | 0           | 0    | 0    | 0          | 0    | 0    | 0          | 0    | 0    |
| PasserByVol:              | 0           | 0    | 0    | 0           | 0    | 0    | 0          | 0    | 0    | 0          | 0    | 0    |
| Initial Fut:              | 19          | 1238 | 171  | 27          | 568  | 48   | 80         | 334  | 79   | 37         | 65   | 34   |
| User Adj:                 | 1.00        | 1.00 | 1.00 | 1.00        | 1.00 | 1.00 | 1.00       | 1.00 | 1.00 | 1.00       | 1.00 | 1.00 |
| PHF Adj:                  | 1.00        | 1.00 | 1.00 | 1.00        | 1.00 | 1.00 | 1.00       | 1.00 | 1.00 | 1.00       | 1.00 | 1.00 |
| PHF Volume:               | 19          | 1238 | 171  | 27          | 568  | 48   | 80         | 334  | 79   | 37         | 65   | 34   |
| Reduct Vol:               | 0           | 0    | 0    | 0           | 0    | 0    | 0          | 0    | 0    | 0          | 0    | 0    |
| Reduced Vol:              | 19          | 1238 | 171  | 27          | 568  | 48   | 80         | 334  | 79   | 37         | 65   | 34   |
| PCE Adj:                  | 1.00        | 1.00 | 1.00 | 1.00        | 1.00 | 1.00 | 1.00       | 1.00 | 1.00 | 1.00       | 1.00 | 1.00 |
| MLF Adj:                  | 1.00        | 1.00 | 1.00 | 1.00        | 1.00 | 1.00 | 1.00       | 1.00 | 1.00 | 1.00       | 1.00 | 1.00 |
| Final Volume:             | 19          | 1238 | 171  | 27          | 568  | 48   | 80         | 334  | 79   | 37         | 65   | 34   |
| Saturation Flow Module:   |             |      |      |             |      |      |            |      |      |            |      |      |
| Sat/Lane:                 | 1900        | 1900 | 1900 | 1900        | 1900 | 1900 | 1900       | 1900 | 1900 | 1900       | 1900 | 1900 |
| Adjustment:               | 0.95        | 0.95 | 0.95 | 0.92        | 0.92 | 0.92 | 0.92       | 0.95 | 0.95 | 0.92       | 0.95 | 0.95 |
| Lanes:                    | 0.03        | 1.73 | 0.24 | 0.04        | 0.89 | 0.07 | 1.00       | 0.81 | 0.19 | 1.00       | 0.66 | 0.34 |
| Final Sat.:               | 48          | 3121 | 431  | 73          | 1546 | 131  | 1750       | 1456 | 344  | 1750       | 1182 | 618  |
| Capacity Analysis Module: |             |      |      |             |      |      |            |      |      |            |      |      |
| Vol/Sat:                  | 0.40        | 0.40 | 0.40 | 0.37        | 0.37 | 0.37 | 0.05       | 0.23 | 0.23 | 0.02       | 0.06 | 0.06 |
| Crit Moves:               | ****        |      |      | ****        |      |      | ****       |      |      | ****       |      |      |
| Green Time:               | 72.2        | 72.2 | 72.2 | 72.2        | 72.2 | 72.2 | 41.8       | 41.8 | 41.8 | 41.8       | 41.8 | 41.8 |
| Volume/Cap:               | 0.66        | 0.66 | 0.66 | 0.61        | 0.61 | 0.61 | 0.13       | 0.66 | 0.66 | 0.06       | 0.16 | 0.16 |
| Delay/Veh:                | 16.5        | 16.5 | 16.5 | 16.1        | 16.1 | 16.1 | 26.8       | 35.7 | 35.7 | 26.1       | 27.1 | 27.1 |
| User DelAdj:              | 1.00        | 1.00 | 1.00 | 1.00        | 1.00 | 1.00 | 1.00       | 1.00 | 1.00 | 1.00       | 1.00 | 1.00 |
| AdjDel/Veh:               | 16.5        | 16.5 | 16.5 | 16.1        | 16.1 | 16.1 | 26.8       | 35.7 | 35.7 | 26.1       | 27.1 | 27.1 |
| LOS by Move:              | B           | B    | B    | B           | B    | B    | C          | D    | D    | C          | C    | C    |
| HCM2k95thQ:               | 29          | 29   | 29   | 28          | 28   | 28   | 4          | 24   | 24   | 2          | 5    | 5    |

Note: Queue reported is the number of cars per lane.

BART

Level Of Service Computation Report  
 2000 HCM Operations (Future Volume Alternative)  
 PM - Cumulative No Project

Intersection #107: Lafayette/Benton [Study Int 49]

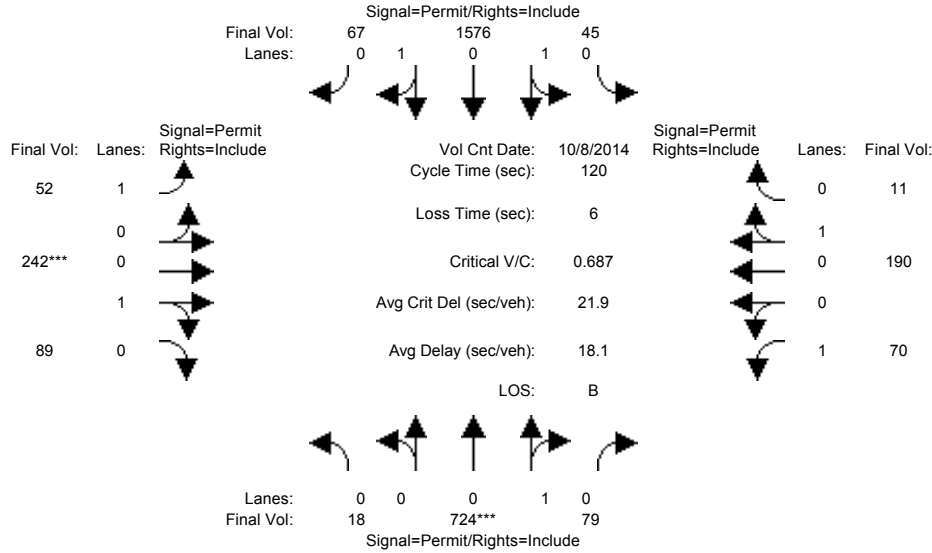

| Approach:                                   | North Bound |      |      | South Bound |      |      | East Bound |      |      | West Bound |      |      |
|---|-------------|------|------|-------------|------|------|------------|------|------|------------|------|------|
| Movement:                                   | L           | T    | R    | L           | T    | R    | L          | T    | R    | L          | T    | R    |
| Min. Green:                                 | 10          | 10   | 10   | 10          | 10   | 10   | 10         | 10   | 10   | 10         | 10   | 10   |
| Y+R:  | 4.0         | 4.0  | 4.0  | 4.0         | 4.0  | 4.0  | 4.0        | 4.0  | 4.0  | 4.0        | 4.0  | 4.0  |
| Volume Module: >> Count Date: 8 Oct 2014 << |             |      |      |             |      |      |            |      |      |            |      |      |
| Base Vol:                                   | 18          | 724  | 79   | 45          | 1576 | 67   | 52         | 242  | 89   | 70         | 190  | 11   |
| Growth Adj:                                 | 1.00        | 1.00 | 1.00 | 1.00        | 1.00 | 1.00 | 1.00       | 1.00 | 1.00 | 1.00       | 1.00 | 1.00 |
| Initial Bse:                                | 18          | 724  | 79   | 45          | 1576 | 67   | 52         | 242  | 89   | 70         | 190  | 11   |
| Added Vol:                                  | 0           | 0    | 0    | 0           | 0    | 0    | 0          | 0    | 0    | 0          | 0    | 0    |
| PasserByVol:                                | 0           | 0    | 0    | 0           | 0    | 0    | 0          | 0    | 0    | 0          | 0    | 0    |
| Initial Fut:                                | 18          | 724  | 79   | 45          | 1576 | 67   | 52         | 242  | 89   | 70         | 190  | 11   |
| User Adj:                                   | 1.00        | 1.00 | 1.00 | 1.00        | 1.00 | 1.00 | 1.00       | 1.00 | 1.00 | 1.00       | 1.00 | 1.00 |
| PHF Adj:                                    | 1.00        | 1.00 | 1.00 | 1.00        | 1.00 | 1.00 | 1.00       | 1.00 | 1.00 | 1.00       | 1.00 | 1.00 |
| PHF Volume:                                 | 18          | 724  | 79   | 45          | 1576 | 67   | 52         | 242  | 89   | 70         | 190  | 11   |
| Reduct Vol:                                 | 0           | 0    | 0    | 0           | 0    | 0    | 0          | 0    | 0    | 0          | 0    | 0    |
| Reduced Vol:                                | 18          | 724  | 79   | 45          | 1576 | 67   | 52         | 242  | 89   | 70         | 190  | 11   |
| PCE Adj:                                    | 1.00        | 1.00 | 1.00 | 1.00        | 1.00 | 1.00 | 1.00       | 1.00 | 1.00 | 1.00       | 1.00 | 1.00 |
| MLF Adj:                                    | 1.00        | 1.00 | 1.00 | 1.00        | 1.00 | 1.00 | 1.00       | 1.00 | 1.00 | 1.00       | 1.00 | 1.00 |
| Final Volume:                               | 18          | 724  | 79   | 45          | 1576 | 67   | 52         | 242  | 89   | 70         | 190  | 11   |
| Saturation Flow Module:                     |             |      |      |             |      |      |            |      |      |            |      |      |
| Sat/Lane:                                   | 1900        | 1900 | 1900 | 1900        | 1900 | 1900 | 1900       | 1900 | 1900 | 1900       | 1900 | 1900 |
| Adjustment:                                 | 0.92        | 0.92 | 0.92 | 0.95        | 0.95 | 0.95 | 0.92       | 0.95 | 0.95 | 0.92       | 0.95 | 0.95 |
| Lanes:                                      | 0.02        | 0.88 | 0.10 | 0.05        | 1.87 | 0.08 | 1.00       | 0.73 | 0.27 | 1.00       | 0.95 | 0.05 |
| Final Sat.:                                 | 38          | 1543 | 168  | 96          | 3361 | 143  | 1750       | 1316 | 484  | 1750       | 1701 | 99   |
| Capacity Analysis Module:                   |             |      |      |             |      |      |            |      |      |            |      |      |
| Vol/Sat:                                    | 0.47        | 0.47 | 0.47 | 0.47        | 0.47 | 0.47 | 0.03       | 0.18 | 0.18 | 0.04       | 0.11 | 0.11 |
| Crit Moves:                                 | ****        |      |      | ****        |      |      | ****       |      |      | ****       |      |      |
| Green Time:                                 | 81.9        | 81.9 | 81.9 | 81.9        | 81.9 | 81.9 | 32.1       | 32.1 | 32.1 | 32.1       | 32.1 | 32.1 |
| Volume/Cap:                                 | 0.69        | 0.69 | 0.69 | 0.69        | 0.69 | 0.69 | 0.11       | 0.69 | 0.69 | 0.15       | 0.42 | 0.42 |
| Delay/Veh:                                  | 13.1        | 13.1 | 13.1 | 12.2        | 12.2 | 12.2 | 33.3       | 43.6 | 43.6 | 33.7       | 36.8 | 36.8 |
| User DelAdj:                                | 1.00        | 1.00 | 1.00 | 1.00        | 1.00 | 1.00 | 1.00       | 1.00 | 1.00 | 1.00       | 1.00 | 1.00 |
| AdjDel/Veh:                                 | 13.1        | 13.1 | 13.1 | 12.2        | 12.2 | 12.2 | 33.3       | 43.6 | 43.6 | 33.7       | 36.8 | 36.8 |
| LOS by Move:                                | B           | B    | B    | B           | B    | B    | C          | D    | D    | C          | D    | D    |
| HCM2k95thQ:                                 | 33          | 33   | 33   | 31          | 31   | 31   | 3          | 21   | 21   | 4          | 13   | 13   |

Note: Queue reported is the number of cars per lane.

BART

Level Of Service Computation Report  
2000 HCM Operations (Future Volume Alternative)  
AM - Cumulative With Project

Intersection #107: Lafayette/Benton [Study Int 49]

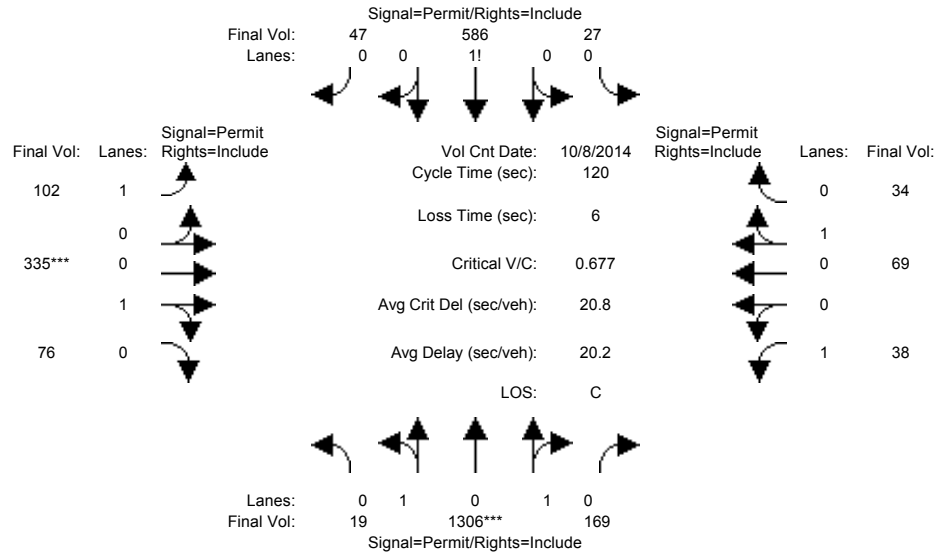

| Approach:                                   | North Bound |      |      | South Bound |      |      | East Bound |      |      | West Bound |      |      |
|---|-------------|------|------|-------------|------|------|------------|------|------|------------|------|------|
| Movement:                                   | L           | T    | R    | L           | T    | R    | L          | T    | R    | L          | T    | R    |
| Min. Green:                                 | 10          | 10   | 10   | 10          | 10   | 10   | 10         | 10   | 10   | 10         | 10   | 10   |
| Y+R:  | 4.0         | 4.0  | 4.0  | 4.0         | 4.0  | 4.0  | 4.0        | 4.0  | 4.0  | 4.0        | 4.0  | 4.0  |
| Volume Module: >> Count Date: 8 Oct 2014 << |             |      |      |             |      |      |            |      |      |            |      |      |
| Base Vol:                                   | 19          | 1306 | 169  | 27          | 586  | 47   | 102        | 335  | 76   | 38         | 69   | 34   |
| Growth Adj:                                 | 1.00        | 1.00 | 1.00 | 1.00        | 1.00 | 1.00 | 1.00       | 1.00 | 1.00 | 1.00       | 1.00 | 1.00 |
| Initial Bse:                                | 19          | 1306 | 169  | 27          | 586  | 47   | 102        | 335  | 76   | 38         | 69   | 34   |
| Added Vol:                                  | 0           | 0    | 0    | 0           | 0    | 0    | 0          | 0    | 0    | 0          | 0    | 0    |
| PasserByVol:                                | 0           | 0    | 0    | 0           | 0    | 0    | 0          | 0    | 0    | 0          | 0    | 0    |
| Initial Fut:                                | 19          | 1306 | 169  | 27          | 586  | 47   | 102        | 335  | 76   | 38         | 69   | 34   |
| User Adj:                                   | 1.00        | 1.00 | 1.00 | 1.00        | 1.00 | 1.00 | 1.00       | 1.00 | 1.00 | 1.00       | 1.00 | 1.00 |
| PHF Adj:                                    | 1.00        | 1.00 | 1.00 | 1.00        | 1.00 | 1.00 | 1.00       | 1.00 | 1.00 | 1.00       | 1.00 | 1.00 |
| PHF Volume:                                 | 19          | 1306 | 169  | 27          | 586  | 47   | 102        | 335  | 76   | 38         | 69   | 34   |
| Reduct Vol:                                 | 0           | 0    | 0    | 0           | 0    | 0    | 0          | 0    | 0    | 0          | 0    | 0    |
| Reduced Vol:                                | 19          | 1306 | 169  | 27          | 586  | 47   | 102        | 335  | 76   | 38         | 69   | 34   |
| PCE Adj:                                    | 1.00        | 1.00 | 1.00 | 1.00        | 1.00 | 1.00 | 1.00       | 1.00 | 1.00 | 1.00       | 1.00 | 1.00 |
| MLF Adj:                                    | 1.00        | 1.00 | 1.00 | 1.00        | 1.00 | 1.00 | 1.00       | 1.00 | 1.00 | 1.00       | 1.00 | 1.00 |
| FinalVolume:                                | 19          | 1306 | 169  | 27          | 586  | 47   | 102        | 335  | 76   | 38         | 69   | 34   |
| Saturation Flow Module:                     |             |      |      |             |      |      |            |      |      |            |      |      |
| Sat/Lane:                                   | 1900        | 1900 | 1900 | 1900        | 1900 | 1900 | 1900       | 1900 | 1900 | 1900       | 1900 | 1900 |
| Adjustment:                                 | 0.95        | 0.95 | 0.95 | 0.92        | 0.92 | 0.92 | 0.92       | 0.95 | 0.95 | 0.92       | 0.95 | 0.95 |
| Lanes:                                      | 0.02        | 1.75 | 0.23 | 0.04        | 0.89 | 0.07 | 1.00       | 0.82 | 0.18 | 1.00       | 0.67 | 0.33 |
| Final Sat.:                                 | 46          | 3147 | 407  | 72          | 1554 | 125  | 1750       | 1467 | 333  | 1750       | 1206 | 594  |
| Capacity Analysis Module:                   |             |      |      |             |      |      |            |      |      |            |      |      |
| Vol/Sat:                                    | 0.42        | 0.42 | 0.42 | 0.38        | 0.38 | 0.38 | 0.06       | 0.23 | 0.23 | 0.02       | 0.06 | 0.06 |
| Crit Moves:                                 | ****        |      |      | ****        |      |      | ****       |      |      | ****       |      |      |
| Green Time:                                 | 73.5        | 73.5 | 73.5 | 73.5        | 73.5 | 73.5 | 40.5       | 40.5 | 40.5 | 40.5       | 40.5 | 40.5 |
| Volume/Cap:                                 | 0.68        | 0.68 | 0.68 | 0.62        | 0.62 | 0.62 | 0.17       | 0.68 | 0.68 | 0.06       | 0.17 | 0.17 |
| Delay/Veh:                                  | 16.2        | 16.2 | 16.2 | 15.5        | 15.5 | 15.5 | 28.1       | 37.2 | 37.2 | 27.0       | 28.1 | 28.1 |
| User DelAdj:                                | 1.00        | 1.00 | 1.00 | 1.00        | 1.00 | 1.00 | 1.00       | 1.00 | 1.00 | 1.00       | 1.00 | 1.00 |
| AdjDel/Veh:                                 | 16.2        | 16.2 | 16.2 | 15.5        | 15.5 | 15.5 | 28.1       | 37.2 | 37.2 | 27.0       | 28.1 | 28.1 |
| LOS by Move:                                | B           | B    | B    | B           | B    | B    | C          | D    | D    | C          | C    | C    |
| HCM2k95thQ:                                 | 30          | 30   | 30   | 28          | 28   | 28   | 6          | 24   | 24   | 2          | 6    | 6    |

Note: Queue reported is the number of cars per lane.

BART

Level Of Service Computation Report  
 2000 HCM Operations (Future Volume Alternative)  
 PM - Cumulative With Project

Intersection #107: Lafayette/Benton [Study Int 49]

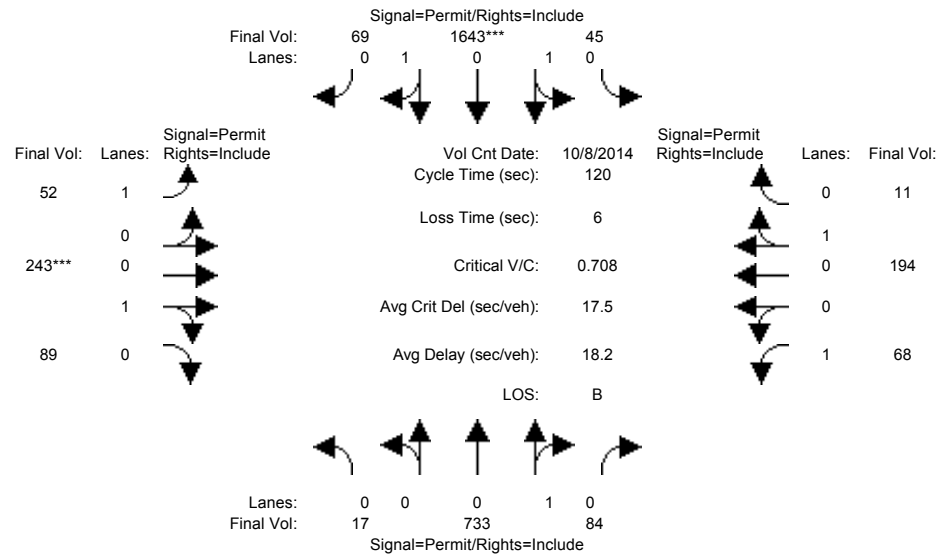

| Approach:                                   | North Bound |      |      | South Bound |      |      | East Bound |      |      | West Bound |      |      |
|---|-------------|------|------|-------------|------|------|------------|------|------|------------|------|------|
| Movement:                                   | L           | T    | R    | L           | T    | R    | L          | T    | R    | L          | T    | R    |
| Min. Green:                                 | 10          | 10   | 10   | 10          | 10   | 10   | 10         | 10   | 10   | 10         | 10   | 10   |
| Y+R:  | 4.0         | 4.0  | 4.0  | 4.0         | 4.0  | 4.0  | 4.0        | 4.0  | 4.0  | 4.0        | 4.0  | 4.0  |
| Volume Module: >> Count Date: 8 Oct 2014 << |             |      |      |             |      |      |            |      |      |            |      |      |
| Base Vol:                                   | 17          | 733  | 84   | 45          | 1643 | 69   | 52         | 243  | 89   | 68         | 194  | 11   |
| Growth Adj:                                 | 1.00        | 1.00 | 1.00 | 1.00        | 1.00 | 1.00 | 1.00       | 1.00 | 1.00 | 1.00       | 1.00 | 1.00 |
| Initial Bse:                                | 17          | 733  | 84   | 45          | 1643 | 69   | 52         | 243  | 89   | 68         | 194  | 11   |
| Added Vol:                                  | 0           | 0    | 0    | 0           | 0    | 0    | 0          | 0    | 0    | 0          | 0    | 0    |
| PasserByVol:                                | 0           | 0    | 0    | 0           | 0    | 0    | 0          | 0    | 0    | 0          | 0    | 0    |
| Initial Fut:                                | 17          | 733  | 84   | 45          | 1643 | 69   | 52         | 243  | 89   | 68         | 194  | 11   |
| User Adj:                                   | 1.00        | 1.00 | 1.00 | 1.00        | 1.00 | 1.00 | 1.00       | 1.00 | 1.00 | 1.00       | 1.00 | 1.00 |
| PHF Adj:                                    | 1.00        | 1.00 | 1.00 | 1.00        | 1.00 | 1.00 | 1.00       | 1.00 | 1.00 | 1.00       | 1.00 | 1.00 |
| PHF Volume:                                 | 17          | 733  | 84   | 45          | 1643 | 69   | 52         | 243  | 89   | 68         | 194  | 11   |
| Reduct Vol:                                 | 0           | 0    | 0    | 0           | 0    | 0    | 0          | 0    | 0    | 0          | 0    | 0    |
| Reduced Vol:                                | 17          | 733  | 84   | 45          | 1643 | 69   | 52         | 243  | 89   | 68         | 194  | 11   |
| PCE Adj:                                    | 1.00        | 1.00 | 1.00 | 1.00        | 1.00 | 1.00 | 1.00       | 1.00 | 1.00 | 1.00       | 1.00 | 1.00 |
| MLF Adj:                                    | 1.00        | 1.00 | 1.00 | 1.00        | 1.00 | 1.00 | 1.00       | 1.00 | 1.00 | 1.00       | 1.00 | 1.00 |
| Final Volume:                               | 17          | 733  | 84   | 45          | 1643 | 69   | 52         | 243  | 89   | 68         | 194  | 11   |
| Saturation Flow Module:                     |             |      |      |             |      |      |            |      |      |            |      |      |
| Sat/Lane:                                   | 1900        | 1900 | 1900 | 1900        | 1900 | 1900 | 1900       | 1900 | 1900 | 1900       | 1900 | 1900 |
| Adjustment:                                 | 0.92        | 0.92 | 0.92 | 0.95        | 0.95 | 0.95 | 0.92       | 0.95 | 0.95 | 0.92       | 0.95 | 0.95 |
| Lanes:                                      | 0.02        | 0.88 | 0.10 | 0.05        | 1.87 | 0.08 | 1.00       | 0.73 | 0.27 | 1.00       | 0.95 | 0.05 |
| Final Sat.:                                 | 36          | 1538 | 176  | 92          | 3366 | 141  | 1750       | 1317 | 483  | 1750       | 1703 | 97   |
| Capacity Analysis Module:                   |             |      |      |             |      |      |            |      |      |            |      |      |
| Vol/Sat:                                    | 0.48        | 0.48 | 0.48 | 0.49        | 0.49 | 0.49 | 0.03       | 0.18 | 0.18 | 0.04       | 0.11 | 0.11 |
| Crit Moves:                                 | *****       |      |      |             |      |      |            |      |      |            |      |      |
| Green Time:                                 | 82.7        | 82.7 | 82.7 | 82.7        | 82.7 | 82.7 | 31.3       | 31.3 | 31.3 | 31.3       | 31.3 | 31.3 |
| Volume/Cap:                                 | 0.69        | 0.69 | 0.69 | 0.71        | 0.71 | 0.71 | 0.11       | 0.71 | 0.71 | 0.15       | 0.44 | 0.44 |
| Delay/Veh:                                  | 12.8        | 12.8 | 12.8 | 12.3        | 12.3 | 12.3 | 33.9       | 45.2 | 45.2 | 34.3       | 37.7 | 37.7 |
| User DelAdj:                                | 1.00        | 1.00 | 1.00 | 1.00        | 1.00 | 1.00 | 1.00       | 1.00 | 1.00 | 1.00       | 1.00 | 1.00 |
| AdjDel/Veh:                                 | 12.8        | 12.8 | 12.8 | 12.3        | 12.3 | 12.3 | 33.9       | 45.2 | 45.2 | 34.3       | 37.7 | 37.7 |
| LOS by Move:                                | B           | B    | B    | B           | B    | B    | C          | D    | D    | C          | D    | D    |
| HCM2k95thQ:                                 | 33          | 33   | 33   | 32          | 32   | 32   | 3          | 21   | 21   | 4          | 13   | 13   |

Note: Queue reported is the number of cars per lane.

BART

Level Of Service Computation Report  
2000 HCM Operations (Future Volume Alternative)  
AM - Cumulative No Project

Intersection #121: Market/Lafayette [Study Int 51]

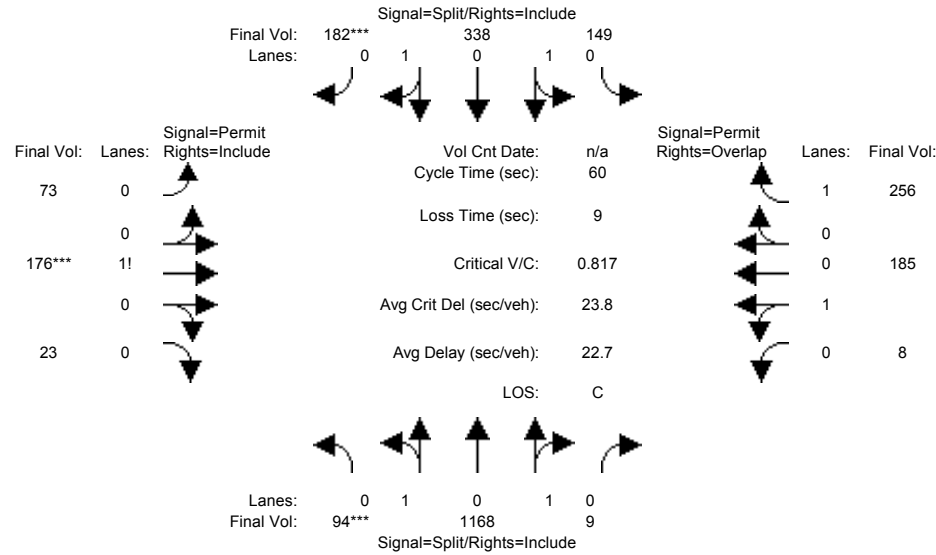

| Approach:                 | North Bound |      |      | South Bound |      |      | East Bound |      |      | West Bound |      |      |
|---------------------------|-------------|------|------|-------------|------|------|------------|------|------|------------|------|------|
| Movement:                 | L           | T    | R    | L           | T    | R    | L          | T    | R    | L          | T    | R    |
| Min. Green:               | 10          | 10   | 10   | 10          | 10   | 10   | 10         | 10   | 10   | 10         | 10   | 10   |
| Y+R:                      | 4.0         | 4.0  | 4.0  | 4.0         | 4.0  | 4.0  | 4.0        | 4.0  | 4.0  | 4.0        | 4.0  | 4.0  |
| Volume Module:            |             |      |      |             |      |      |            |      |      |            |      |      |
| Base Vol:                 | 94          | 1168 | 9    | 149         | 338  | 182  | 73         | 176  | 23   | 8          | 185  | 256  |
| Growth Adj:               | 1.00        | 1.00 | 1.00 | 1.00        | 1.00 | 1.00 | 1.00       | 1.00 | 1.00 | 1.00       | 1.00 | 1.00 |
| Initial Bse:              | 94          | 1168 | 9    | 149         | 338  | 182  | 73         | 176  | 23   | 8          | 185  | 256  |
| Added Vol:                | 0           | 0    | 0    | 0           | 0    | 0    | 0          | 0    | 0    | 0          | 0    | 0    |
| PasserByVol:              | 0           | 0    | 0    | 0           | 0    | 0    | 0          | 0    | 0    | 0          | 0    | 0    |
| Initial Fut:              | 94          | 1168 | 9    | 149         | 338  | 182  | 73         | 176  | 23   | 8          | 185  | 256  |
| User Adj:                 | 1.00        | 1.00 | 1.00 | 1.00        | 1.00 | 1.00 | 1.00       | 1.00 | 1.00 | 1.00       | 1.00 | 1.00 |
| PHF Adj:                  | 1.00        | 1.00 | 1.00 | 1.00        | 1.00 | 1.00 | 1.00       | 1.00 | 1.00 | 1.00       | 1.00 | 1.00 |
| PHF Volume:               | 94          | 1168 | 9    | 149         | 338  | 182  | 73         | 176  | 23   | 8          | 185  | 256  |
| Reduct Vol:               | 0           | 0    | 0    | 0           | 0    | 0    | 0          | 0    | 0    | 0          | 0    | 0    |
| Reduced Vol:              | 94          | 1168 | 9    | 149         | 338  | 182  | 73         | 176  | 23   | 8          | 185  | 256  |
| PCE Adj:                  | 1.00        | 1.00 | 1.00 | 1.00        | 1.00 | 1.00 | 1.00       | 1.00 | 1.00 | 1.00       | 1.00 | 1.00 |
| MLF Adj:                  | 1.00        | 1.00 | 1.00 | 1.00        | 1.00 | 1.00 | 1.00       | 1.00 | 1.00 | 1.00       | 1.00 | 1.00 |
| FinalVolume:              | 94          | 1168 | 9    | 149         | 338  | 182  | 73         | 176  | 23   | 8          | 185  | 256  |
| Saturation Flow Module:   |             |      |      |             |      |      |            |      |      |            |      |      |
| Sat/Lane:                 | 1900        | 1900 | 1900 | 1900        | 1900 | 1900 | 1900       | 1900 | 1900 | 1900       | 1900 | 1900 |
| Adjustment:               | 0.95        | 0.95 | 0.95 | 0.95        | 0.95 | 0.95 | 0.92       | 0.92 | 0.92 | 0.95       | 0.95 | 0.92 |
| Lanes:                    | 0.15        | 1.84 | 0.01 | 0.45        | 1.01 | 0.54 | 0.27       | 0.65 | 0.08 | 0.04       | 0.96 | 1.00 |
| Final Sat.:               | 266         | 3308 | 25   | 802         | 1819 | 979  | 470        | 1132 | 148  | 75         | 1725 | 1750 |
| Capacity Analysis Module: |             |      |      |             |      |      |            |      |      |            |      |      |
| Vol/Sat:                  | 0.35        | 0.35 | 0.35 | 0.19        | 0.19 | 0.19 | 0.16       | 0.16 | 0.16 | 0.11       | 0.11 | 0.15 |
| Crit Moves:               | ****        |      |      |             |      | **** | ****       |      |      |            |      |      |
| Green Time:               | 25.9        | 25.9 | 25.9 | 13.7        | 13.7 | 13.7 | 11.4       | 11.4 | 11.4 | 11.4       | 11.4 | 25.1 |
| Volume/Cap:               | 0.82        | 0.82 | 0.82 | 0.82        | 0.82 | 0.82 | 0.82       | 0.82 | 0.82 | 0.56       | 0.56 | 0.35 |
| Delay/Veh:                | 18.4        | 18.4 | 18.4 | 28.4        | 28.4 | 28.4 | 37.8       | 37.8 | 37.8 | 24.2       | 24.2 | 12.2 |
| User DelAdj:              | 1.00        | 1.00 | 1.00 | 1.00        | 1.00 | 1.00 | 1.00       | 1.00 | 1.00 | 1.00       | 1.00 | 1.00 |
| AdjDel/Veh:               | 18.4        | 18.4 | 18.4 | 28.4        | 28.4 | 28.4 | 37.8       | 37.8 | 37.8 | 24.2       | 24.2 | 12.2 |
| LOS by Move:              | B           | B    | B    | C           | C    | C    | D          | D    | D    | C          | C    | B    |
| HCM2k95thQ:               | 21          | 21   | 21   | 13          | 13   | 13   | 11         | 11   | 11   | 8          | 8    | 7    |

Note: Queue reported is the number of cars per lane.



BART

Level Of Service Computation Report  
 2000 HCM Operations (Future Volume Alternative)  
 PM - Cumulative No Project

Intersection #121: Market/Lafayette [Study Int 51]

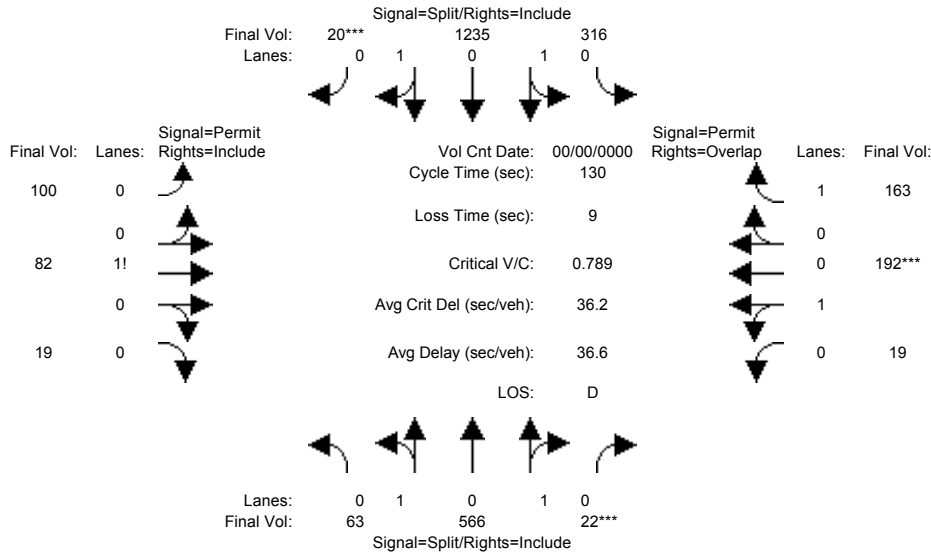

| Approach:                            | North Bound |      |      | South Bound |      |      | East Bound |      |      | West Bound |      |      |
|--------------------------------------|-------------|------|------|-------------|------|------|------------|------|------|------------|------|------|
| Movement:                            | L           | T    | R    | L           | T    | R    | L          | T    | R    | L          | T    | R    |
| Min. Green:                          | 10          | 10   | 10   | 10          | 10   | 10   | 10         | 10   | 10   | 10         | 10   | 10   |
| Y+R:                                 | 4.0         | 4.0  | 4.0  | 4.0         | 4.0  | 4.0  | 4.0        | 4.0  | 4.0  | 4.0        | 4.0  | 4.0  |
| Volume Module: >> Count Date: 0 0 << |             |      |      |             |      |      |            |      |      |            |      |      |
| Base Vol:                            | 63          | 566  | 22   | 316         | 1235 | 20   | 100        | 82   | 19   | 19         | 192  | 163  |
| Growth Adj:                          | 1.00        | 1.00 | 1.00 | 1.00        | 1.00 | 1.00 | 1.00       | 1.00 | 1.00 | 1.00       | 1.00 | 1.00 |
| Initial Bse:                         | 63          | 566  | 22   | 316         | 1235 | 20   | 100        | 82   | 19   | 19         | 192  | 163  |
| Added Vol:                           | 0           | 0    | 0    | 0           | 0    | 0    | 0          | 0    | 0    | 0          | 0    | 0    |
| PasserByVol:                         | 0           | 0    | 0    | 0           | 0    | 0    | 0          | 0    | 0    | 0          | 0    | 0    |
| Initial Fut:                         | 63          | 566  | 22   | 316         | 1235 | 20   | 100        | 82   | 19   | 19         | 192  | 163  |
| User Adj:                            | 1.00        | 1.00 | 1.00 | 1.00        | 1.00 | 1.00 | 1.00       | 1.00 | 1.00 | 1.00       | 1.00 | 1.00 |
| PHF Adj:                             | 1.00        | 1.00 | 1.00 | 1.00        | 1.00 | 1.00 | 1.00       | 1.00 | 1.00 | 1.00       | 1.00 | 1.00 |
| PHF Volume:                          | 63          | 566  | 22   | 316         | 1235 | 20   | 100        | 82   | 19   | 19         | 192  | 163  |
| Reduct Vol:                          | 0           | 0    | 0    | 0           | 0    | 0    | 0          | 0    | 0    | 0          | 0    | 0    |
| Reduced Vol:                         | 63          | 566  | 22   | 316         | 1235 | 20   | 100        | 82   | 19   | 19         | 192  | 163  |
| PCE Adj:                             | 1.00        | 1.00 | 1.00 | 1.00        | 1.00 | 1.00 | 1.00       | 1.00 | 1.00 | 1.00       | 1.00 | 1.00 |
| MLF Adj:                             | 1.00        | 1.00 | 1.00 | 1.00        | 1.00 | 1.00 | 1.00       | 1.00 | 1.00 | 1.00       | 1.00 | 1.00 |
| FinalVolume:                         | 63          | 566  | 22   | 316         | 1235 | 20   | 100        | 82   | 19   | 19         | 192  | 163  |
| Saturation Flow Module:              |             |      |      |             |      |      |            |      |      |            |      |      |
| Sat/Lane:                            | 1900        | 1900 | 1900 | 1900        | 1900 | 1900 | 1900       | 1900 | 1900 | 1900       | 1900 | 1900 |
| Adjustment:                          | 0.95        | 0.95 | 0.95 | 0.95        | 0.95 | 0.95 | 0.92       | 0.92 | 0.92 | 0.95       | 0.95 | 0.92 |
| Lanes:                               | 0.19        | 1.74 | 0.07 | 0.40        | 1.57 | 0.03 | 0.50       | 0.41 | 0.09 | 0.09       | 0.91 | 1.00 |
| Final Sat.:                          | 348         | 3130 | 122  | 724         | 2830 | 46   | 871        | 714  | 165  | 162        | 1638 | 1750 |
| Capacity Analysis Module:            |             |      |      |             |      |      |            |      |      |            |      |      |
| Vol/Sat:                             | 0.18        | 0.18 | 0.18 | 0.44        | 0.44 | 0.44 | 0.11       | 0.11 | 0.11 | 0.12       | 0.12 | 0.09 |
| Crit Moves:                          | ****        |      |      | ****        |      |      | ****       |      |      | ****       |      |      |
| Green Time:                          | 29.8        | 29.8 | 29.8 | 71.9        | 71.9 | 71.9 | 19.3       | 19.3 | 19.3 | 19.3       | 19.3 | 91.2 |
| Volume/Cap:                          | 0.79        | 0.79 | 0.79 | 0.79        | 0.79 | 0.79 | 0.77       | 0.77 | 0.77 | 0.79       | 0.79 | 0.13 |
| Delay/Veh:                           | 52.3        | 52.3 | 52.3 | 25.2        | 25.2 | 25.2 | 66.6       | 66.6 | 66.6 | 67.9       | 67.9 | 6.4  |
| User DelAdj:                         | 1.00        | 1.00 | 1.00 | 1.00        | 1.00 | 1.00 | 1.00       | 1.00 | 1.00 | 1.00       | 1.00 | 1.00 |
| AdjDel/Veh:                          | 52.3        | 52.3 | 52.3 | 25.2        | 25.2 | 25.2 | 66.6       | 66.6 | 66.6 | 67.9       | 67.9 | 6.4  |
| LOS by Move:                         | D           | D    | D    | C           | C    | C    | E          | E    | E    | E          | E    | A    |
| HCM2k95thQ:                          | 24          | 24   | 24   | 44          | 44   | 44   | 16         | 16   | 16   | 19         | 19   | 5    |

Note: Queue reported is the number of cars per lane.

BART

Level Of Service Computation Report  
 2000 HCM Operations (Future Volume Alternative)  
 AM - Cumulative With Project

Intersection #121: Market/Lafayette [Study Int 51]

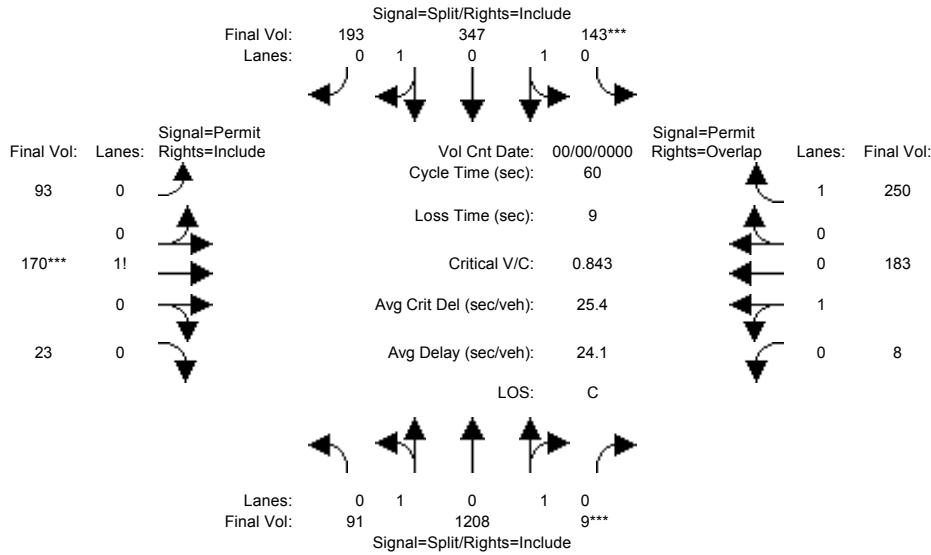

| Approach:                            | North Bound |      |      | South Bound |      |      | East Bound |      |      | West Bound |      |      |
|--------------------------------------|-------------|------|------|-------------|------|------|------------|------|------|------------|------|------|
| Movement:                            | L           | T    | R    | L           | T    | R    | L          | T    | R    | L          | T    | R    |
| Min. Green:                          | 10          | 10   | 10   | 10          | 10   | 10   | 10         | 10   | 10   | 10         | 10   | 10   |
| Y+R:                                 | 4.0         | 4.0  | 4.0  | 4.0         | 4.0  | 4.0  | 4.0        | 4.0  | 4.0  | 4.0        | 4.0  | 4.0  |
| Volume Module: >> Count Date: 0 0 << |             |      |      |             |      |      |            |      |      |            |      |      |
| Base Vol:                            | 91          | 1208 | 9    | 143         | 347  | 193  | 93         | 170  | 23   | 8          | 183  | 250  |
| Growth Adj:                          | 1.00        | 1.00 | 1.00 | 1.00        | 1.00 | 1.00 | 1.00       | 1.00 | 1.00 | 1.00       | 1.00 | 1.00 |
| Initial Bse:                         | 91          | 1208 | 9    | 143         | 347  | 193  | 93         | 170  | 23   | 8          | 183  | 250  |
| Added Vol:                           | 0           | 0    | 0    | 0           | 0    | 0    | 0          | 0    | 0    | 0          | 0    | 0    |
| PasserByVol:                         | 0           | 0    | 0    | 0           | 0    | 0    | 0          | 0    | 0    | 0          | 0    | 0    |
| Initial Fut:                         | 91          | 1208 | 9    | 143         | 347  | 193  | 93         | 170  | 23   | 8          | 183  | 250  |
| User Adj:                            | 1.00        | 1.00 | 1.00 | 1.00        | 1.00 | 1.00 | 1.00       | 1.00 | 1.00 | 1.00       | 1.00 | 1.00 |
| PHF Adj:                             | 1.00        | 1.00 | 1.00 | 1.00        | 1.00 | 1.00 | 1.00       | 1.00 | 1.00 | 1.00       | 1.00 | 1.00 |
| PHF Volume:                          | 91          | 1208 | 9    | 143         | 347  | 193  | 93         | 170  | 23   | 8          | 183  | 250  |
| Reduct Vol:                          | 0           | 0    | 0    | 0           | 0    | 0    | 0          | 0    | 0    | 0          | 0    | 0    |
| Reduced Vol:                         | 91          | 1208 | 9    | 143         | 347  | 193  | 93         | 170  | 23   | 8          | 183  | 250  |
| PCE Adj:                             | 1.00        | 1.00 | 1.00 | 1.00        | 1.00 | 1.00 | 1.00       | 1.00 | 1.00 | 1.00       | 1.00 | 1.00 |
| MLF Adj:                             | 1.00        | 1.00 | 1.00 | 1.00        | 1.00 | 1.00 | 1.00       | 1.00 | 1.00 | 1.00       | 1.00 | 1.00 |
| Final Volume:                        | 91          | 1208 | 9    | 143         | 347  | 193  | 93         | 170  | 23   | 8          | 183  | 250  |
| Saturation Flow Module:              |             |      |      |             |      |      |            |      |      |            |      |      |
| Sat/Lane:                            | 1900        | 1900 | 1900 | 1900        | 1900 | 1900 | 1900       | 1900 | 1900 | 1900       | 1900 | 1900 |
| Adjustment:                          | 0.95        | 0.95 | 0.95 | 0.95        | 0.95 | 0.95 | 0.92       | 0.92 | 0.92 | 0.95       | 0.95 | 0.92 |
| Lanes:                               | 0.14        | 1.85 | 0.01 | 0.42        | 1.02 | 0.56 | 0.33       | 0.59 | 0.08 | 0.04       | 0.96 | 1.00 |
| Final Sat.:                          | 250         | 3325 | 25   | 754         | 1829 | 1017 | 569        | 1040 | 141  | 75         | 1725 | 1750 |
| Capacity Analysis Module:            |             |      |      |             |      |      |            |      |      |            |      |      |
| Vol/Sat:                             | 0.36        | 0.36 | 0.36 | 0.19        | 0.19 | 0.19 | 0.16       | 0.16 | 0.16 | 0.11       | 0.11 | 0.14 |
| Crit Moves:                          | ****        | **** | **** | ****        | **** | **** | ****       | **** | **** | ****       | **** | **** |
| Green Time:                          | 25.9        | 25.9 | 25.9 | 13.5        | 13.5 | 13.5 | 11.6       | 11.6 | 11.6 | 11.6       | 11.6 | 25.1 |
| Volume/Cap:                          | 0.84        | 0.84 | 0.84 | 0.84        | 0.84 | 0.84 | 0.84       | 0.84 | 0.84 | 0.55       | 0.55 | 0.34 |
| Delay/Veh:                           | 19.6        | 19.6 | 19.6 | 30.2        | 30.2 | 30.2 | 40.5       | 40.5 | 40.5 | 23.6       | 23.6 | 12.1 |
| User DelAdj:                         | 1.00        | 1.00 | 1.00 | 1.00        | 1.00 | 1.00 | 1.00       | 1.00 | 1.00 | 1.00       | 1.00 | 1.00 |
| AdjDel/Veh:                          | 19.6        | 19.6 | 19.6 | 30.2        | 30.2 | 30.2 | 40.5       | 40.5 | 40.5 | 23.6       | 23.6 | 12.1 |
| LOS by Move:                         | B           | B    | B    | C           | C    | C    | D          | D    | D    | C          | C    | B    |
| HCM2k95thQ:                          | 23          | 23   | 23   | 14          | 14   | 14   | 12         | 12   | 12   | 8          | 8    | 7    |

Note: Queue reported is the number of cars per lane.

BART

Level Of Service Computation Report  
 2000 HCM Operations (Future Volume Alternative)  
 PM - Cumulative With Project

Intersection #121: Market/Lafayette [Study Int 51]

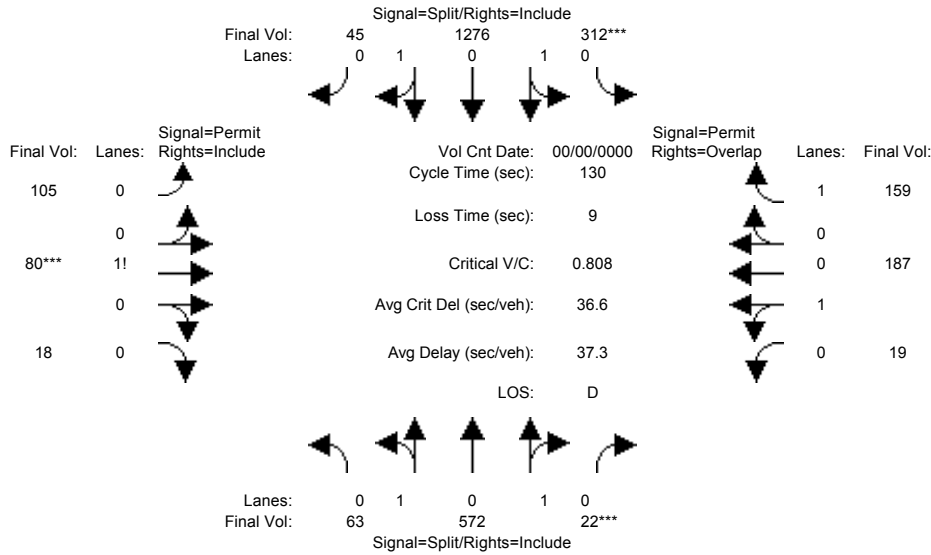

| Approach:                            | North Bound |      |      | South Bound |      |      | East Bound |      |      | West Bound |      |      |
|--------------------------------------|-------------|------|------|-------------|------|------|------------|------|------|------------|------|------|
| Movement:                            | L           | T    | R    | L           | T    | R    | L          | T    | R    | L          | T    | R    |
| Min. Green:                          | 10          | 10   | 10   | 10          | 10   | 10   | 10         | 10   | 10   | 10         | 10   | 10   |
| Y+R:                                 | 4.0         | 4.0  | 4.0  | 4.0         | 4.0  | 4.0  | 4.0        | 4.0  | 4.0  | 4.0        | 4.0  | 4.0  |
| Volume Module: >> Count Date: 0 0 << |             |      |      |             |      |      |            |      |      |            |      |      |
| Base Vol:                            | 63          | 572  | 22   | 312         | 1276 | 45   | 105        | 80   | 18   | 19         | 187  | 159  |
| Growth Adj:                          | 1.00        | 1.00 | 1.00 | 1.00        | 1.00 | 1.00 | 1.00       | 1.00 | 1.00 | 1.00       | 1.00 | 1.00 |
| Initial Bse:                         | 63          | 572  | 22   | 312         | 1276 | 45   | 105        | 80   | 18   | 19         | 187  | 159  |
| Added Vol:                           | 0           | 0    | 0    | 0           | 0    | 0    | 0          | 0    | 0    | 0          | 0    | 0    |
| PasserByVol:                         | 0           | 0    | 0    | 0           | 0    | 0    | 0          | 0    | 0    | 0          | 0    | 0    |
| Initial Fut:                         | 63          | 572  | 22   | 312         | 1276 | 45   | 105        | 80   | 18   | 19         | 187  | 159  |
| User Adj:                            | 1.00        | 1.00 | 1.00 | 1.00        | 1.00 | 1.00 | 1.00       | 1.00 | 1.00 | 1.00       | 1.00 | 1.00 |
| PHF Adj:                             | 1.00        | 1.00 | 1.00 | 1.00        | 1.00 | 1.00 | 1.00       | 1.00 | 1.00 | 1.00       | 1.00 | 1.00 |
| PHF Volume:                          | 63          | 572  | 22   | 312         | 1276 | 45   | 105        | 80   | 18   | 19         | 187  | 159  |
| Reduct Vol:                          | 0           | 0    | 0    | 0           | 0    | 0    | 0          | 0    | 0    | 0          | 0    | 0    |
| Reduced Vol:                         | 63          | 572  | 22   | 312         | 1276 | 45   | 105        | 80   | 18   | 19         | 187  | 159  |
| PCE Adj:                             | 1.00        | 1.00 | 1.00 | 1.00        | 1.00 | 1.00 | 1.00       | 1.00 | 1.00 | 1.00       | 1.00 | 1.00 |
| MLF Adj:                             | 1.00        | 1.00 | 1.00 | 1.00        | 1.00 | 1.00 | 1.00       | 1.00 | 1.00 | 1.00       | 1.00 | 1.00 |
| Final Volume:                        | 63          | 572  | 22   | 312         | 1276 | 45   | 105        | 80   | 18   | 19         | 187  | 159  |
| Saturation Flow Module:              |             |      |      |             |      |      |            |      |      |            |      |      |
| Sat/Lane:                            | 1900        | 1900 | 1900 | 1900        | 1900 | 1900 | 1900       | 1900 | 1900 | 1900       | 1900 | 1900 |
| Adjustment:                          | 0.95        | 0.95 | 0.95 | 0.95        | 0.95 | 0.95 | 0.92       | 0.92 | 0.92 | 0.95       | 0.95 | 0.92 |
| Lanes:                               | 0.19        | 1.74 | 0.07 | 0.38        | 1.56 | 0.06 | 0.52       | 0.39 | 0.09 | 0.09       | 0.91 | 1.00 |
| Final Sat.:                          | 345         | 3134 | 121  | 688         | 2813 | 99   | 905        | 690  | 155  | 166        | 1634 | 1750 |
| Capacity Analysis Module:            |             |      |      |             |      |      |            |      |      |            |      |      |
| Vol/Sat:                             | 0.18        | 0.18 | 0.18 | 0.45        | 0.45 | 0.45 | 0.12       | 0.12 | 0.12 | 0.11       | 0.11 | 0.09 |
| Crit Moves:                          | ****        |      |      | ****        |      |      | ****       |      |      | ****       |      |      |
| Green Time:                          | 29.4        | 29.4 | 29.4 | 73.0        | 73.0 | 73.0 | 18.7       | 18.7 | 18.7 | 18.7       | 18.7 | 91.6 |
| Volume/Cap:                          | 0.81        | 0.81 | 0.81 | 0.81        | 0.81 | 0.81 | 0.81       | 0.81 | 0.81 | 0.80       | 0.80 | 0.13 |
| Delay/Veh:                           | 53.7        | 53.7 | 53.7 | 25.4        | 25.4 | 25.4 | 71.3       | 71.3 | 71.3 | 69.6       | 69.6 | 6.3  |
| User DelAdj:                         | 1.00        | 1.00 | 1.00 | 1.00        | 1.00 | 1.00 | 1.00       | 1.00 | 1.00 | 1.00       | 1.00 | 1.00 |
| AdjDel/Veh:                          | 53.7        | 53.7 | 53.7 | 25.4        | 25.4 | 25.4 | 71.3       | 71.3 | 71.3 | 69.6       | 69.6 | 6.3  |
| LOS by Move:                         | D           | D    | D    | C           | C    | C    | E          | E    | E    | E          | E    | A    |
| HCM2k95thQ:                          | 24          | 24   | 24   | 46          | 46   | 46   | 17         | 17   | 17   | 19         | 19   | 4    |

Note: Queue reported is the number of cars per lane.

BART

Level Of Service Computation Report  
 2000 HCM Operations (Future Volume Alternative)  
 AM - Cumulative No Project

Intersection #123: Homestead/Monroe [Study Int 61]

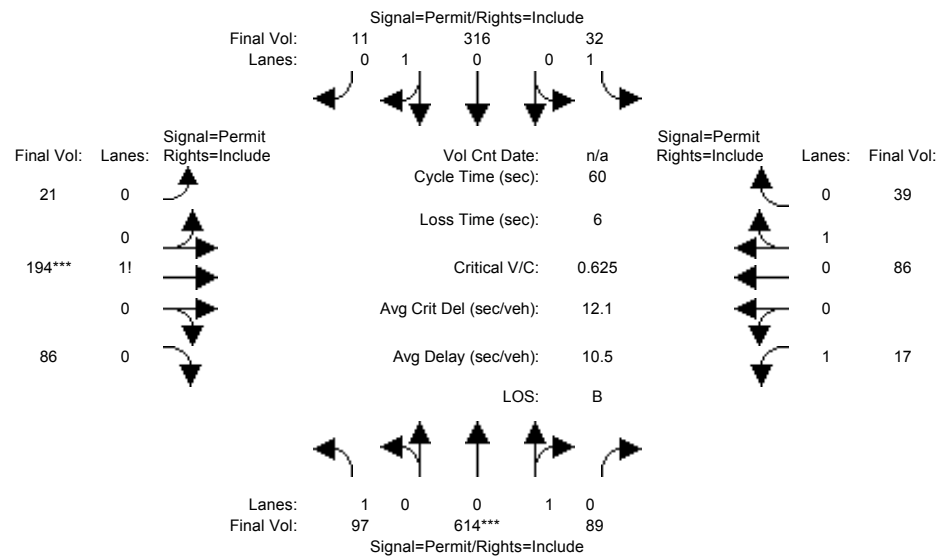

| Approach:                 | North Bound |      |      | South Bound |      |      | East Bound |      |      | West Bound |      |      |
|---------------------------|-------------|------|------|-------------|------|------|------------|------|------|------------|------|------|
| Movement:                 | L           | T    | R    | L           | T    | R    | L          | T    | R    | L          | T    | R    |
| Min. Green:               | 10          | 10   | 10   | 10          | 10   | 10   | 10         | 10   | 10   | 10         | 10   | 10   |
| Y+R:                      | 4.0         | 4.0  | 4.0  | 4.0         | 4.0  | 4.0  | 4.0        | 4.0  | 4.0  | 4.0        | 4.0  | 4.0  |
| Volume Module:            |             |      |      |             |      |      |            |      |      |            |      |      |
| Base Vol:                 | 97          | 614  | 89   | 32          | 316  | 11   | 21         | 194  | 86   | 17         | 86   | 39   |
| Growth Adj:               | 1.00        | 1.00 | 1.00 | 1.00        | 1.00 | 1.00 | 1.00       | 1.00 | 1.00 | 1.00       | 1.00 | 1.00 |
| Initial Bse:              | 97          | 614  | 89   | 32          | 316  | 11   | 21         | 194  | 86   | 17         | 86   | 39   |
| Added Vol:                | 0           | 0    | 0    | 0           | 0    | 0    | 0          | 0    | 0    | 0          | 0    | 0    |
| PasserByVol:              | 0           | 0    | 0    | 0           | 0    | 0    | 0          | 0    | 0    | 0          | 0    | 0    |
| Initial Fut:              | 97          | 614  | 89   | 32          | 316  | 11   | 21         | 194  | 86   | 17         | 86   | 39   |
| User Adj:                 | 1.00        | 1.00 | 1.00 | 1.00        | 1.00 | 1.00 | 1.00       | 1.00 | 1.00 | 1.00       | 1.00 | 1.00 |
| PHF Adj:                  | 1.00        | 1.00 | 1.00 | 1.00        | 1.00 | 1.00 | 1.00       | 1.00 | 1.00 | 1.00       | 1.00 | 1.00 |
| PHF Volume:               | 97          | 614  | 89   | 32          | 316  | 11   | 21         | 194  | 86   | 17         | 86   | 39   |
| Reduct Vol:               | 0           | 0    | 0    | 0           | 0    | 0    | 0          | 0    | 0    | 0          | 0    | 0    |
| Reduced Vol:              | 97          | 614  | 89   | 32          | 316  | 11   | 21         | 194  | 86   | 17         | 86   | 39   |
| PCE Adj:                  | 1.00        | 1.00 | 1.00 | 1.00        | 1.00 | 1.00 | 1.00       | 1.00 | 1.00 | 1.00       | 1.00 | 1.00 |
| MLF Adj:                  | 1.00        | 1.00 | 1.00 | 1.00        | 1.00 | 1.00 | 1.00       | 1.00 | 1.00 | 1.00       | 1.00 | 1.00 |
| FinalVolume:              | 97          | 614  | 89   | 32          | 316  | 11   | 21         | 194  | 86   | 17         | 86   | 39   |
| Saturation Flow Module:   |             |      |      |             |      |      |            |      |      |            |      |      |
| Sat/Lane:                 | 1900        | 1900 | 1900 | 1900        | 1900 | 1900 | 1900       | 1900 | 1900 | 1900       | 1900 | 1900 |
| Adjustment:               | 0.92        | 0.95 | 0.95 | 0.92        | 0.95 | 0.95 | 0.92       | 0.92 | 0.92 | 0.92       | 0.95 | 0.95 |
| Lanes:                    | 1.00        | 0.87 | 0.13 | 1.00        | 0.97 | 0.03 | 0.07       | 0.64 | 0.29 | 1.00       | 0.69 | 0.31 |
| Final Sat.:               | 1750        | 1572 | 228  | 1750        | 1739 | 61   | 122        | 1128 | 500  | 1750       | 1238 | 562  |
| Capacity Analysis Module: |             |      |      |             |      |      |            |      |      |            |      |      |
| Vol/Sat:                  | 0.06        | 0.39 | 0.39 | 0.02        | 0.18 | 0.18 | 0.17       | 0.17 | 0.17 | 0.01       | 0.07 | 0.07 |
| Crit Moves:               | ****        |      |      |             |      |      | ****       |      |      |            |      |      |
| Green Time:               | 37.5        | 37.5 | 37.5 | 37.5        | 37.5 | 37.5 | 16.5       | 16.5 | 16.5 | 16.5       | 16.5 | 16.5 |
| Volume/Cap:               | 0.09        | 0.63 | 0.63 | 0.03        | 0.29 | 0.29 | 0.63       | 0.63 | 0.63 | 0.04       | 0.25 | 0.25 |
| Delay/Veh:                | 4.5         | 8.0  | 8.0  | 4.3         | 5.3  | 5.3  | 21.6       | 21.6 | 21.6 | 15.9       | 17.2 | 17.2 |
| User DelAdj:              | 1.00        | 1.00 | 1.00 | 1.00        | 1.00 | 1.00 | 1.00       | 1.00 | 1.00 | 1.00       | 1.00 | 1.00 |
| AdjDel/Veh:               | 4.5         | 8.0  | 8.0  | 4.3         | 5.3  | 5.3  | 21.6       | 21.6 | 21.6 | 15.9       | 17.2 | 17.2 |
| LOS by Move:              | A           | A    | A    | A           | A    | A    | C          | C    | C    | B          | B    | B    |
| HCM2k95thQ:               | 2           | 16   | 16   | 1           | 6    | 6    | 10         | 10   | 10   | 0          | 4    | 4    |

Note: Queue reported is the number of cars per lane.

BART

Level Of Service Computation Report  
 2000 HCM Operations (Future Volume Alternative)  
 PM - Cumulative No Project

Intersection #123: Homestead/Monroe [Study Int 61]

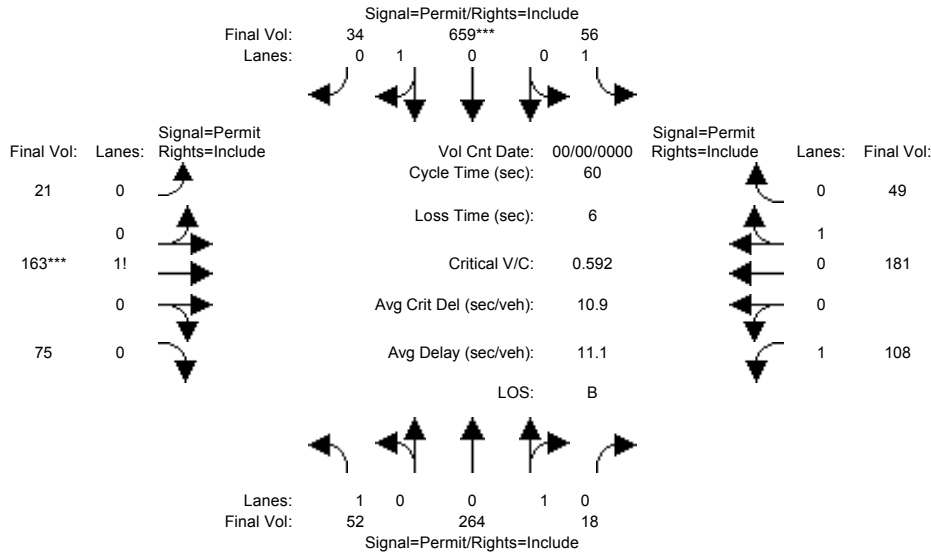

| Approach:                            | North Bound |      |      | South Bound |      |      | East Bound |      |      | West Bound |      |      |
|--------------------------------------|-------------|------|------|-------------|------|------|------------|------|------|------------|------|------|
| Movement:                            | L           | T    | R    | L           | T    | R    | L          | T    | R    | L          | T    | R    |
| Min. Green:                          | 10          | 10   | 10   | 10          | 10   | 10   | 10         | 10   | 10   | 10         | 10   | 10   |
| Y+R:                                 | 4.0         | 4.0  | 4.0  | 4.0         | 4.0  | 4.0  | 4.0        | 4.0  | 4.0  | 4.0        | 4.0  | 4.0  |
| Volume Module: >> Count Date: 0 0 << |             |      |      |             |      |      |            |      |      |            |      |      |
| Base Vol:                            | 52          | 264  | 18   | 56          | 659  | 34   | 21         | 163  | 75   | 108        | 181  | 49   |
| Growth Adj:                          | 1.00        | 1.00 | 1.00 | 1.00        | 1.00 | 1.00 | 1.00       | 1.00 | 1.00 | 1.00       | 1.00 | 1.00 |
| Initial Bse:                         | 52          | 264  | 18   | 56          | 659  | 34   | 21         | 163  | 75   | 108        | 181  | 49   |
| Added Vol:                           | 0           | 0    | 0    | 0           | 0    | 0    | 0          | 0    | 0    | 0          | 0    | 0    |
| PasserByVol:                         | 0           | 0    | 0    | 0           | 0    | 0    | 0          | 0    | 0    | 0          | 0    | 0    |
| Initial Fut:                         | 52          | 264  | 18   | 56          | 659  | 34   | 21         | 163  | 75   | 108        | 181  | 49   |
| User Adj:                            | 1.00        | 1.00 | 1.00 | 1.00        | 1.00 | 1.00 | 1.00       | 1.00 | 1.00 | 1.00       | 1.00 | 1.00 |
| PHF Adj:                             | 1.00        | 1.00 | 1.00 | 1.00        | 1.00 | 1.00 | 1.00       | 1.00 | 1.00 | 1.00       | 1.00 | 1.00 |
| PHF Volume:                          | 52          | 264  | 18   | 56          | 659  | 34   | 21         | 163  | 75   | 108        | 181  | 49   |
| Reduct Vol:                          | 0           | 0    | 0    | 0           | 0    | 0    | 0          | 0    | 0    | 0          | 0    | 0    |
| Reduced Vol:                         | 52          | 264  | 18   | 56          | 659  | 34   | 21         | 163  | 75   | 108        | 181  | 49   |
| PCE Adj:                             | 1.00        | 1.00 | 1.00 | 1.00        | 1.00 | 1.00 | 1.00       | 1.00 | 1.00 | 1.00       | 1.00 | 1.00 |
| MLF Adj:                             | 1.00        | 1.00 | 1.00 | 1.00        | 1.00 | 1.00 | 1.00       | 1.00 | 1.00 | 1.00       | 1.00 | 1.00 |
| FinalVolume:                         | 52          | 264  | 18   | 56          | 659  | 34   | 21         | 163  | 75   | 108        | 181  | 49   |
| Saturation Flow Module:              |             |      |      |             |      |      |            |      |      |            |      |      |
| Sat/Lane:                            | 1900        | 1900 | 1900 | 1900        | 1900 | 1900 | 1900       | 1900 | 1900 | 1900       | 1900 | 1900 |
| Adjustment:                          | 0.92        | 0.95 | 0.95 | 0.92        | 0.95 | 0.95 | 0.92       | 0.92 | 0.92 | 0.92       | 0.95 | 0.95 |
| Lanes:                               | 1.00        | 0.94 | 0.06 | 1.00        | 0.95 | 0.05 | 0.08       | 0.63 | 0.29 | 1.00       | 0.79 | 0.21 |
| Final Sat.:                          | 1750        | 1685 | 115  | 1750        | 1712 | 88   | 142        | 1101 | 507  | 1750       | 1417 | 383  |
| Capacity Analysis Module:            |             |      |      |             |      |      |            |      |      |            |      |      |
| Vol/Sat:                             | 0.03        | 0.16 | 0.16 | 0.03        | 0.39 | 0.39 | 0.15       | 0.15 | 0.15 | 0.06       | 0.13 | 0.13 |
| Crit Moves:                          | *****       |      |      |             |      |      |            |      |      |            |      |      |
| Green Time:                          | 39.0        | 39.0 | 39.0 | 39.0        | 39.0 | 39.0 | 15.0       | 15.0 | 15.0 | 15.0       | 15.0 | 15.0 |
| Volume/Cap:                          | 0.05        | 0.24 | 0.24 | 0.05        | 0.59 | 0.59 | 0.59       | 0.59 | 0.59 | 0.25       | 0.51 | 0.51 |
| Delay/Veh:                           | 3.8         | 4.5  | 4.5  | 3.8         | 6.8  | 6.8  | 22.0       | 22.0 | 22.0 | 18.3       | 20.3 | 20.3 |
| User DelAdj:                         | 1.00        | 1.00 | 1.00 | 1.00        | 1.00 | 1.00 | 1.00       | 1.00 | 1.00 | 1.00       | 1.00 | 1.00 |
| AdjDel/Veh:                          | 3.8         | 4.5  | 4.5  | 3.8         | 6.8  | 6.8  | 22.0       | 22.0 | 22.0 | 18.3       | 20.3 | 20.3 |
| LOS by Move:                         | A           | A    | A    | A           | A    | A    | C          | C    | C    | B          | C    | C    |
| HCM2k95thQ:                          | 1           | 5    | 5    | 1           | 15   | 15   | 9          | 9    | 9    | 3          | 8    | 8    |

Note: Queue reported is the number of cars per lane.

BART

Level Of Service Computation Report  
 2000 HCM Operations (Future Volume Alternative)  
 AM - Cumulative With Project

Intersection #123: Homestead/Monroe [Study Int 61]

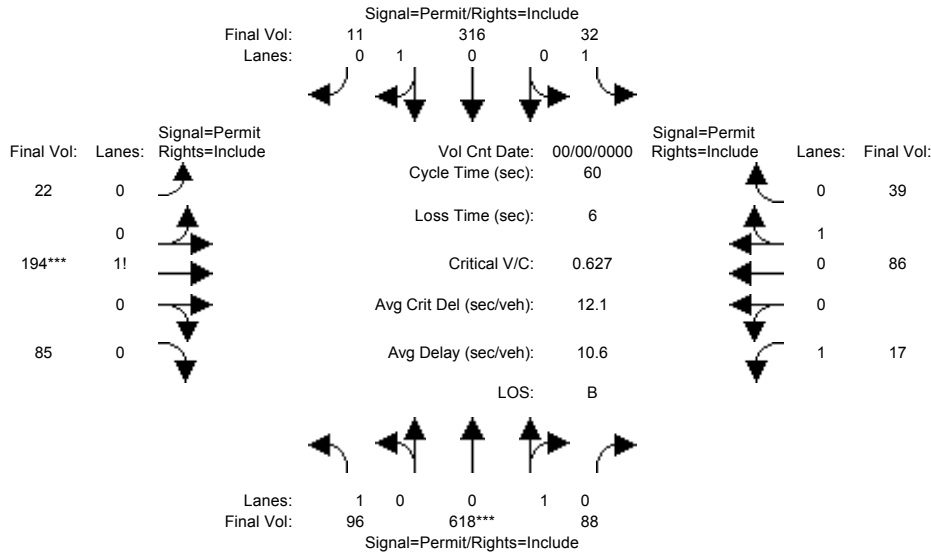

| Approach:                            | North Bound |      |      | South Bound |      |      | East Bound |      |      | West Bound |      |      |
|--------------------------------------|-------------|------|------|-------------|------|------|------------|------|------|------------|------|------|
| Movement:                            | L           | T    | R    | L           | T    | R    | L          | T    | R    | L          | T    | R    |
| Min. Green:                          | 10          | 10   | 10   | 10          | 10   | 10   | 10         | 10   | 10   | 10         | 10   | 10   |
| Y+R:                                 | 4.0         | 4.0  | 4.0  | 4.0         | 4.0  | 4.0  | 4.0        | 4.0  | 4.0  | 4.0        | 4.0  | 4.0  |
| Volume Module: >> Count Date: 0 0 << |             |      |      |             |      |      |            |      |      |            |      |      |
| Base Vol:                            | 96          | 618  | 88   | 32          | 316  | 11   | 22         | 194  | 85   | 17         | 86   | 39   |
| Growth Adj:                          | 1.00        | 1.00 | 1.00 | 1.00        | 1.00 | 1.00 | 1.00       | 1.00 | 1.00 | 1.00       | 1.00 | 1.00 |
| Initial Bse:                         | 96          | 618  | 88   | 32          | 316  | 11   | 22         | 194  | 85   | 17         | 86   | 39   |
| Added Vol:                           | 0           | 0    | 0    | 0           | 0    | 0    | 0          | 0    | 0    | 0          | 0    | 0    |
| PasserByVol:                         | 0           | 0    | 0    | 0           | 0    | 0    | 0          | 0    | 0    | 0          | 0    | 0    |
| Initial Fut:                         | 96          | 618  | 88   | 32          | 316  | 11   | 22         | 194  | 85   | 17         | 86   | 39   |
| User Adj:                            | 1.00        | 1.00 | 1.00 | 1.00        | 1.00 | 1.00 | 1.00       | 1.00 | 1.00 | 1.00       | 1.00 | 1.00 |
| PHF Adj:                             | 1.00        | 1.00 | 1.00 | 1.00        | 1.00 | 1.00 | 1.00       | 1.00 | 1.00 | 1.00       | 1.00 | 1.00 |
| PHF Volume:                          | 96          | 618  | 88   | 32          | 316  | 11   | 22         | 194  | 85   | 17         | 86   | 39   |
| Reduct Vol:                          | 0           | 0    | 0    | 0           | 0    | 0    | 0          | 0    | 0    | 0          | 0    | 0    |
| Reduced Vol:                         | 96          | 618  | 88   | 32          | 316  | 11   | 22         | 194  | 85   | 17         | 86   | 39   |
| PCE Adj:                             | 1.00        | 1.00 | 1.00 | 1.00        | 1.00 | 1.00 | 1.00       | 1.00 | 1.00 | 1.00       | 1.00 | 1.00 |
| MLF Adj:                             | 1.00        | 1.00 | 1.00 | 1.00        | 1.00 | 1.00 | 1.00       | 1.00 | 1.00 | 1.00       | 1.00 | 1.00 |
| FinalVolume:                         | 96          | 618  | 88   | 32          | 316  | 11   | 22         | 194  | 85   | 17         | 86   | 39   |
| Saturation Flow Module:              |             |      |      |             |      |      |            |      |      |            |      |      |
| Sat/Lane:                            | 1900        | 1900 | 1900 | 1900        | 1900 | 1900 | 1900       | 1900 | 1900 | 1900       | 1900 | 1900 |
| Adjustment:                          | 0.92        | 0.95 | 0.95 | 0.92        | 0.95 | 0.95 | 0.92       | 0.92 | 0.92 | 0.92       | 0.95 | 0.95 |
| Lanes:                               | 1.00        | 0.88 | 0.12 | 1.00        | 0.97 | 0.03 | 0.07       | 0.65 | 0.28 | 1.00       | 0.69 | 0.31 |
| Final Sat.:                          | 1750        | 1576 | 224  | 1750        | 1739 | 61   | 128        | 1128 | 494  | 1750       | 1238 | 562  |
| Capacity Analysis Module:            |             |      |      |             |      |      |            |      |      |            |      |      |
| Vol/Sat:                             | 0.05        | 0.39 | 0.39 | 0.02        | 0.18 | 0.18 | 0.17       | 0.17 | 0.17 | 0.01       | 0.07 | 0.07 |
| Crit Moves:                          | ****        |      |      |             |      |      | ****       |      |      |            |      |      |
| Green Time:                          | 37.5        | 37.5 | 37.5 | 37.5        | 37.5 | 37.5 | 16.5       | 16.5 | 16.5 | 16.5       | 16.5 | 16.5 |
| Volume/Cap:                          | 0.09        | 0.63 | 0.63 | 0.03        | 0.29 | 0.29 | 0.63       | 0.63 | 0.63 | 0.04       | 0.25 | 0.25 |
| Delay/Veh:                           | 4.5         | 8.0  | 8.0  | 4.3         | 5.3  | 5.3  | 21.7       | 21.7 | 21.7 | 16.0       | 17.2 | 17.2 |
| User DelAdj:                         | 1.00        | 1.00 | 1.00 | 1.00        | 1.00 | 1.00 | 1.00       | 1.00 | 1.00 | 1.00       | 1.00 | 1.00 |
| AdjDel/Veh:                          | 4.5         | 8.0  | 8.0  | 4.3         | 5.3  | 5.3  | 21.7       | 21.7 | 21.7 | 16.0       | 17.2 | 17.2 |
| LOS by Move:                         | A           | A    | A    | A           | A    | A    | C          | C    | C    | B          | B    | B    |
| HCM2k95thQ:                          | 2           | 16   | 16   | 0           | 6    | 6    | 10         | 10   | 10   | 0          | 4    | 4    |

Note: Queue reported is the number of cars per lane.

BART

Level Of Service Computation Report  
 2000 HCM Operations (Future Volume Alternative)  
 PM - Cumulative With Project

Intersection #123: Homestead/Monroe [Study Int 61]

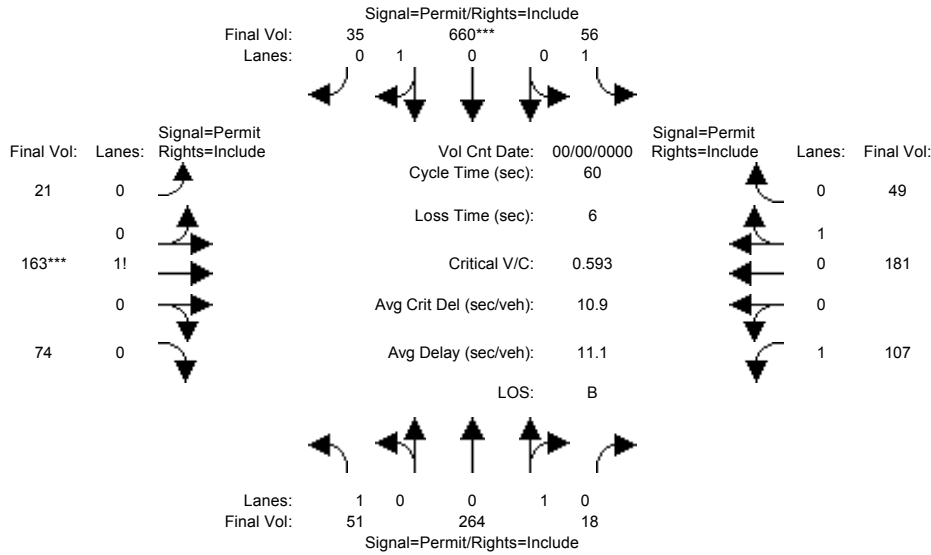

| Approach:                            | North Bound |      |      | South Bound |      |      | East Bound |      |      | West Bound |      |      |
|--------------------------------------|-------------|------|------|-------------|------|------|------------|------|------|------------|------|------|
| Movement:                            | L           | T    | R    | L           | T    | R    | L          | T    | R    | L          | T    | R    |
| Min. Green:                          | 10          | 10   | 10   | 10          | 10   | 10   | 10         | 10   | 10   | 10         | 10   | 10   |
| Y+R:                                 | 4.0         | 4.0  | 4.0  | 4.0         | 4.0  | 4.0  | 4.0        | 4.0  | 4.0  | 4.0        | 4.0  | 4.0  |
| Volume Module: >> Count Date: 0 0 << |             |      |      |             |      |      |            |      |      |            |      |      |
| Base Vol:                            | 51          | 264  | 18   | 56          | 660  | 35   | 21         | 163  | 74   | 107        | 181  | 49   |
| Growth Adj:                          | 1.00        | 1.00 | 1.00 | 1.00        | 1.00 | 1.00 | 1.00       | 1.00 | 1.00 | 1.00       | 1.00 | 1.00 |
| Initial Bse:                         | 51          | 264  | 18   | 56          | 660  | 35   | 21         | 163  | 74   | 107        | 181  | 49   |
| Added Vol:                           | 0           | 0    | 0    | 0           | 0    | 0    | 0          | 0    | 0    | 0          | 0    | 0    |
| PasserByVol:                         | 0           | 0    | 0    | 0           | 0    | 0    | 0          | 0    | 0    | 0          | 0    | 0    |
| Initial Fut:                         | 51          | 264  | 18   | 56          | 660  | 35   | 21         | 163  | 74   | 107        | 181  | 49   |
| User Adj:                            | 1.00        | 1.00 | 1.00 | 1.00        | 1.00 | 1.00 | 1.00       | 1.00 | 1.00 | 1.00       | 1.00 | 1.00 |
| PHF Adj:                             | 1.00        | 1.00 | 1.00 | 1.00        | 1.00 | 1.00 | 1.00       | 1.00 | 1.00 | 1.00       | 1.00 | 1.00 |
| PHF Volume:                          | 51          | 264  | 18   | 56          | 660  | 35   | 21         | 163  | 74   | 107        | 181  | 49   |
| Reduct Vol:                          | 0           | 0    | 0    | 0           | 0    | 0    | 0          | 0    | 0    | 0          | 0    | 0    |
| Reduced Vol:                         | 51          | 264  | 18   | 56          | 660  | 35   | 21         | 163  | 74   | 107        | 181  | 49   |
| PCE Adj:                             | 1.00        | 1.00 | 1.00 | 1.00        | 1.00 | 1.00 | 1.00       | 1.00 | 1.00 | 1.00       | 1.00 | 1.00 |
| MLF Adj:                             | 1.00        | 1.00 | 1.00 | 1.00        | 1.00 | 1.00 | 1.00       | 1.00 | 1.00 | 1.00       | 1.00 | 1.00 |
| Final Volume:                        | 51          | 264  | 18   | 56          | 660  | 35   | 21         | 163  | 74   | 107        | 181  | 49   |
| Saturation Flow Module:              |             |      |      |             |      |      |            |      |      |            |      |      |
| Sat/Lane:                            | 1900        | 1900 | 1900 | 1900        | 1900 | 1900 | 1900       | 1900 | 1900 | 1900       | 1900 | 1900 |
| Adjustment:                          | 0.92        | 0.95 | 0.95 | 0.92        | 0.95 | 0.95 | 0.92       | 0.92 | 0.92 | 0.92       | 0.95 | 0.95 |
| Lanes:                               | 1.00        | 0.94 | 0.06 | 1.00        | 0.95 | 0.05 | 0.08       | 0.63 | 0.29 | 1.00       | 0.79 | 0.21 |
| Final Sat.:                          | 1750        | 1685 | 115  | 1750        | 1709 | 91   | 142        | 1106 | 502  | 1750       | 1417 | 383  |
| Capacity Analysis Module:            |             |      |      |             |      |      |            |      |      |            |      |      |
| Vol/Sat:                             | 0.03        | 0.16 | 0.16 | 0.03        | 0.39 | 0.39 | 0.15       | 0.15 | 0.15 | 0.06       | 0.13 | 0.13 |
| Crit Moves:                          | *****       |      |      |             |      |      |            |      |      |            |      |      |
| Green Time:                          | 39.1        | 39.1 | 39.1 | 39.1        | 39.1 | 39.1 | 14.9       | 14.9 | 14.9 | 14.9       | 14.9 | 14.9 |
| Volume/Cap:                          | 0.04        | 0.24 | 0.24 | 0.05        | 0.59 | 0.59 | 0.59       | 0.59 | 0.59 | 0.25       | 0.51 | 0.51 |
| Delay/Veh:                           | 3.8         | 4.4  | 4.4  | 3.8         | 6.8  | 6.8  | 22.1       | 22.1 | 22.1 | 18.3       | 20.4 | 20.4 |
| User DelAdj:                         | 1.00        | 1.00 | 1.00 | 1.00        | 1.00 | 1.00 | 1.00       | 1.00 | 1.00 | 1.00       | 1.00 | 1.00 |
| AdjDel/Veh:                          | 3.8         | 4.4  | 4.4  | 3.8         | 6.8  | 6.8  | 22.1       | 22.1 | 22.1 | 18.3       | 20.4 | 20.4 |
| LOS by Move:                         | A           | A    | A    | A           | A    | A    | C          | C    | C    | B          | C    | C    |
| HCM2k95thQ:                          | 1           | 5    | 5    | 1           | 15   | 15   | 9          | 9    | 9    | 3          | 8    | 8    |

Note: Queue reported is the number of cars per lane.

BART

Level Of Service Computation Report  
 2000 HCM Operations (Future Volume Alternative)  
 AM - Cumulative No Project

Intersection #127: Lincoln/Homestead [Study Int 60]

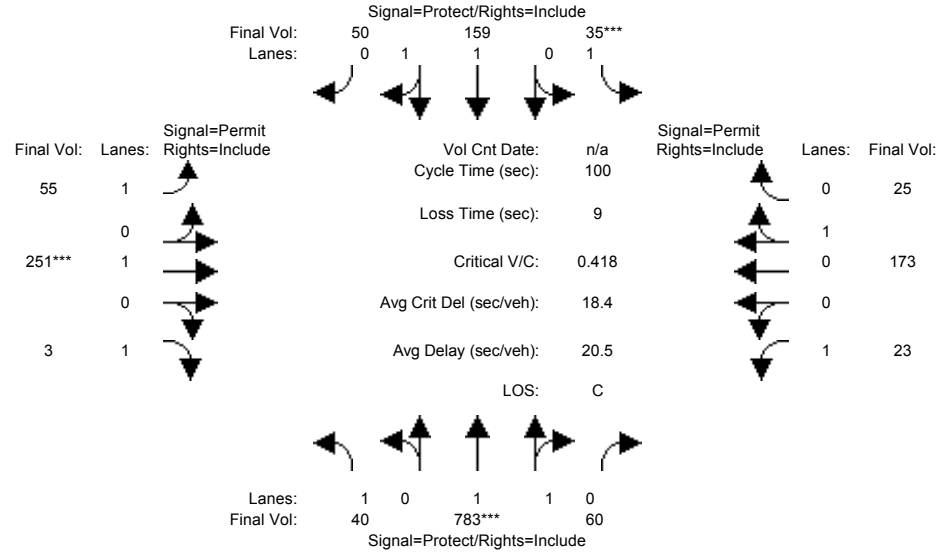

| Approach:                 | North Bound |      |      | South Bound |      |      | East Bound |      |      | West Bound |      |      |
|---------------------------|-------------|------|------|-------------|------|------|------------|------|------|------------|------|------|
| Movement:                 | L           | T    | R    | L           | T    | R    | L          | T    | R    | L          | T    | R    |
| Min. Green:               | 7           | 10   | 10   | 7           | 10   | 10   | 7          | 10   | 10   | 7          | 10   | 10   |
| Y+R:                      | 4.0         | 4.0  | 4.0  | 4.0         | 4.0  | 4.0  | 4.0        | 4.0  | 4.0  | 4.0        | 4.0  | 4.0  |
| Volume Module:            |             |      |      |             |      |      |            |      |      |            |      |      |
| Base Vol:                 | 40          | 783  | 60   | 35          | 159  | 50   | 55         | 251  | 3    | 23         | 173  | 25   |
| Growth Adj:               | 1.00        | 1.00 | 1.00 | 1.00        | 1.00 | 1.00 | 1.00       | 1.00 | 1.00 | 1.00       | 1.00 | 1.00 |
| Initial Bse:              | 40          | 783  | 60   | 35          | 159  | 50   | 55         | 251  | 3    | 23         | 173  | 25   |
| Added Vol:                | 0           | 0    | 0    | 0           | 0    | 0    | 0          | 0    | 0    | 0          | 0    | 0    |
| PasserByVol:              | 0           | 0    | 0    | 0           | 0    | 0    | 0          | 0    | 0    | 0          | 0    | 0    |
| Initial Fut:              | 40          | 783  | 60   | 35          | 159  | 50   | 55         | 251  | 3    | 23         | 173  | 25   |
| User Adj:                 | 1.00        | 1.00 | 1.00 | 1.00        | 1.00 | 1.00 | 1.00       | 1.00 | 1.00 | 1.00       | 1.00 | 1.00 |
| PHF Adj:                  | 1.00        | 1.00 | 1.00 | 1.00        | 1.00 | 1.00 | 1.00       | 1.00 | 1.00 | 1.00       | 1.00 | 1.00 |
| PHF Volume:               | 40          | 783  | 60   | 35          | 159  | 50   | 55         | 251  | 3    | 23         | 173  | 25   |
| Reduct Vol:               | 0           | 0    | 0    | 0           | 0    | 0    | 0          | 0    | 0    | 0          | 0    | 0    |
| Reduced Vol:              | 40          | 783  | 60   | 35          | 159  | 50   | 55         | 251  | 3    | 23         | 173  | 25   |
| PCE Adj:                  | 1.00        | 1.00 | 1.00 | 1.00        | 1.00 | 1.00 | 1.00       | 1.00 | 1.00 | 1.00       | 1.00 | 1.00 |
| MLF Adj:                  | 1.00        | 1.00 | 1.00 | 1.00        | 1.00 | 1.00 | 1.00       | 1.00 | 1.00 | 1.00       | 1.00 | 1.00 |
| Final Volume:             | 40          | 783  | 60   | 35          | 159  | 50   | 55         | 251  | 3    | 23         | 173  | 25   |
| Saturation Flow Module:   |             |      |      |             |      |      |            |      |      |            |      |      |
| Sat/Lane:                 | 1900        | 1900 | 1900 | 1900        | 1900 | 1900 | 1900       | 1900 | 1900 | 1900       | 1900 | 1900 |
| Adjustment:               | 0.92        | 0.98 | 0.95 | 0.92        | 0.98 | 0.95 | 0.92       | 1.00 | 0.92 | 0.92       | 0.95 | 0.95 |
| Lanes:                    | 1.00        | 1.85 | 0.15 | 1.00        | 1.51 | 0.49 | 1.00       | 1.00 | 1.00 | 1.00       | 0.87 | 0.13 |
| Final Sat.:               | 1750        | 3436 | 263  | 1750        | 2814 | 885  | 1750       | 1900 | 1750 | 1750       | 1573 | 227  |
| Capacity Analysis Module: |             |      |      |             |      |      |            |      |      |            |      |      |
| Vol/Sat:                  | 0.02        | 0.23 | 0.23 | 0.02        | 0.06 | 0.06 | 0.03       | 0.13 | 0.00 | 0.01       | 0.11 | 0.11 |
| Crit Moves:               | ****        | **** | **** | ****        | **** | **** | ****       | **** | **** | ****       | **** | **** |
| Green Time:               | 24.8        | 53.2 | 53.2 | 7.0         | 35.4 | 35.4 | 30.8       | 30.8 | 30.8 | 30.8       | 30.8 | 30.8 |
| Volume/Cap:               | 0.09        | 0.43 | 0.43 | 0.29        | 0.16 | 0.16 | 0.10       | 0.43 | 0.01 | 0.04       | 0.36 | 0.36 |
| Delay/Veh:                | 29.0        | 14.4 | 14.4 | 45.4        | 22.2 | 22.2 | 24.8       | 28.1 | 24.0 | 24.3       | 27.3 | 27.3 |
| User DelAdj:              | 1.00        | 1.00 | 1.00 | 1.00        | 1.00 | 1.00 | 1.00       | 1.00 | 1.00 | 1.00       | 1.00 | 1.00 |
| AdjDel/Veh:               | 29.0        | 14.4 | 14.4 | 45.4        | 22.2 | 22.2 | 24.8       | 28.1 | 24.0 | 24.3       | 27.3 | 27.3 |
| LOS by Move:              | C           | B    | B    | D           | C    | C    | C          | C    | C    | C          | C    | C    |
| HCM2k95thQ:               | 2           | 15   | 15   | 2           | 4    | 4    | 3          | 11   | 0    | 1          | 9    | 9    |

Note: Queue reported is the number of cars per lane.



BART

Level Of Service Computation Report  
 2000 HCM Operations (Future Volume Alternative)  
 PM - Cumulative No Project

Intersection #127: Lincoln/Homestead [Study Int 60]

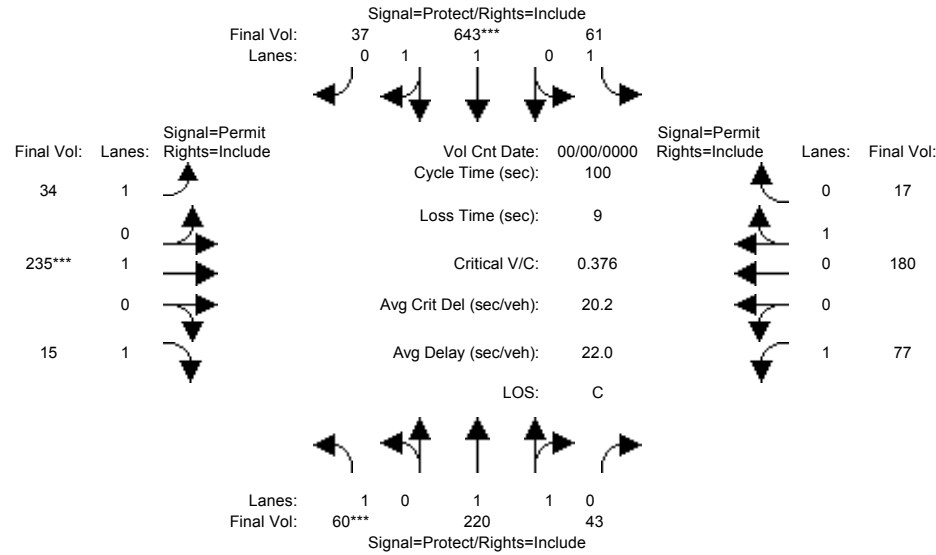

| Approach:                            | North Bound |      |      | South Bound |      |      | East Bound |      |      | West Bound |      |      |
|--------------------------------------|-------------|------|------|-------------|------|------|------------|------|------|------------|------|------|
| Movement:                            | L           | T    | R    | L           | T    | R    | L          | T    | R    | L          | T    | R    |
| Min. Green:                          | 7           | 10   | 10   | 7           | 10   | 10   | 7          | 10   | 10   | 7          | 10   | 10   |
| Y+R:                                 | 4.0         | 4.0  | 4.0  | 4.0         | 4.0  | 4.0  | 4.0        | 4.0  | 4.0  | 4.0        | 4.0  | 4.0  |
| Volume Module: >> Count Date: 0 0 << |             |      |      |             |      |      |            |      |      |            |      |      |
| Base Vol:                            | 60          | 220  | 43   | 61          | 643  | 37   | 34         | 235  | 15   | 77         | 180  | 17   |
| Growth Adj:                          | 1.00        | 1.00 | 1.00 | 1.00        | 1.00 | 1.00 | 1.00       | 1.00 | 1.00 | 1.00       | 1.00 | 1.00 |
| Initial Bse:                         | 60          | 220  | 43   | 61          | 643  | 37   | 34         | 235  | 15   | 77         | 180  | 17   |
| Added Vol:                           | 0           | 0    | 0    | 0           | 0    | 0    | 0          | 0    | 0    | 0          | 0    | 0    |
| PasserByVol:                         | 0           | 0    | 0    | 0           | 0    | 0    | 0          | 0    | 0    | 0          | 0    | 0    |
| Initial Fut:                         | 60          | 220  | 43   | 61          | 643  | 37   | 34         | 235  | 15   | 77         | 180  | 17   |
| User Adj:                            | 1.00        | 1.00 | 1.00 | 1.00        | 1.00 | 1.00 | 1.00       | 1.00 | 1.00 | 1.00       | 1.00 | 1.00 |
| PHF Adj:                             | 1.00        | 1.00 | 1.00 | 1.00        | 1.00 | 1.00 | 1.00       | 1.00 | 1.00 | 1.00       | 1.00 | 1.00 |
| PHF Volume:                          | 60          | 220  | 43   | 61          | 643  | 37   | 34         | 235  | 15   | 77         | 180  | 17   |
| Reduct Vol:                          | 0           | 0    | 0    | 0           | 0    | 0    | 0          | 0    | 0    | 0          | 0    | 0    |
| Reduced Vol:                         | 60          | 220  | 43   | 61          | 643  | 37   | 34         | 235  | 15   | 77         | 180  | 17   |
| PCE Adj:                             | 1.00        | 1.00 | 1.00 | 1.00        | 1.00 | 1.00 | 1.00       | 1.00 | 1.00 | 1.00       | 1.00 | 1.00 |
| MLF Adj:                             | 1.00        | 1.00 | 1.00 | 1.00        | 1.00 | 1.00 | 1.00       | 1.00 | 1.00 | 1.00       | 1.00 | 1.00 |
| FinalVolume:                         | 60          | 220  | 43   | 61          | 643  | 37   | 34         | 235  | 15   | 77         | 180  | 17   |
| Saturation Flow Module:              |             |      |      |             |      |      |            |      |      |            |      |      |
| Sat/Lane:                            | 1900        | 1900 | 1900 | 1900        | 1900 | 1900 | 1900       | 1900 | 1900 | 1900       | 1900 | 1900 |
| Adjustment:                          | 0.92        | 0.98 | 0.95 | 0.92        | 0.98 | 0.95 | 0.92       | 1.00 | 0.92 | 0.92       | 0.95 | 0.95 |
| Lanes:                               | 1.00        | 1.66 | 0.34 | 1.00        | 1.89 | 0.11 | 1.00       | 1.00 | 1.00 | 1.00       | 0.91 | 0.09 |
| Final Sat.:                          | 1750        | 3095 | 605  | 1750        | 3499 | 201  | 1750       | 1900 | 1750 | 1750       | 1645 | 155  |
| Capacity Analysis Module:            |             |      |      |             |      |      |            |      |      |            |      |      |
| Vol/Sat:                             | 0.03        | 0.07 | 0.07 | 0.03        | 0.18 | 0.18 | 0.02       | 0.12 | 0.01 | 0.04       | 0.11 | 0.11 |
| Crit Moves:                          | ****        |      |      | ****        |      |      | ****       |      |      | ****       |      |      |
| Green Time:                          | 9.1         | 34.2 | 34.2 | 23.9        | 48.9 | 48.9 | 32.9       | 32.9 | 32.9 | 32.9       | 32.9 | 32.9 |
| Volume/Cap:                          | 0.38        | 0.21 | 0.21 | 0.15        | 0.38 | 0.38 | 0.06       | 0.38 | 0.03 | 0.13       | 0.33 | 0.33 |
| Delay/Veh:                           | 44.2        | 23.4 | 23.4 | 30.2        | 16.1 | 16.1 | 23.0       | 26.0 | 22.7 | 23.6       | 25.6 | 25.6 |
| User DelAdj:                         | 1.00        | 1.00 | 1.00 | 1.00        | 1.00 | 1.00 | 1.00       | 1.00 | 1.00 | 1.00       | 1.00 | 1.00 |
| AdjDel/Veh:                          | 44.2        | 23.4 | 23.4 | 30.2        | 16.1 | 16.1 | 23.0       | 26.0 | 22.7 | 23.6       | 25.6 | 25.6 |
| LOS by Move:                         | D           | C    | C    | C           | B    | B    | C          | C    | C    | C          | C    | C    |
| HCM2k95thQ:                          | 4           | 6    | 6    | 3           | 12   | 12   | 2          | 10   | 1    | 3          | 9    | 9    |

Note: Queue reported is the number of cars per lane.

BART

Level Of Service Computation Report  
2000 HCM Operations (Future Volume Alternative)  
AM - Cumulative With Project

Intersection #127: Lincoln/Homestead [Study Int 60]

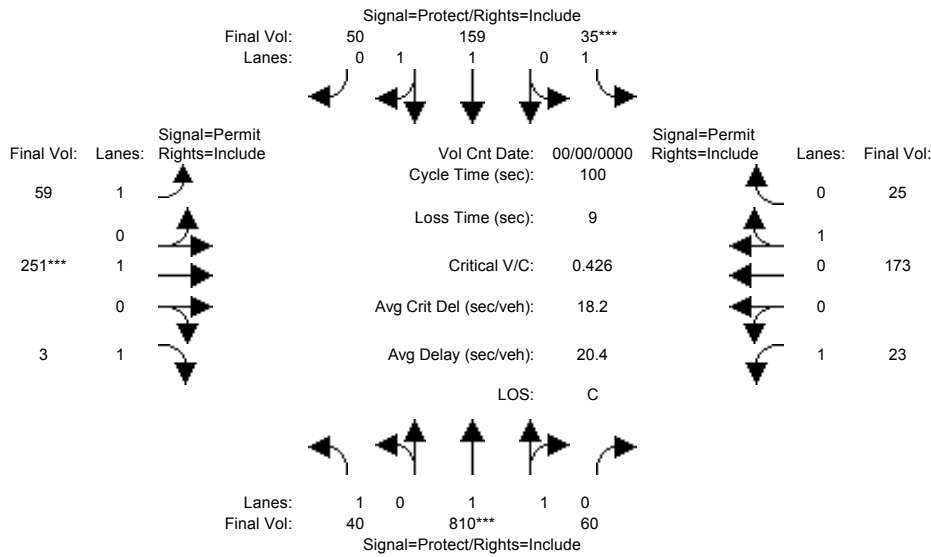

| Approach:                            | North Bound |      |      | South Bound |      |      | East Bound |      |      | West Bound |      |      |
|--------------------------------------|-------------|------|------|-------------|------|------|------------|------|------|------------|------|------|
| Movement:                            | L           | T    | R    | L           | T    | R    | L          | T    | R    | L          | T    | R    |
| Min. Green:                          | 7           | 10   | 10   | 7           | 10   | 10   | 7          | 10   | 10   | 7          | 10   | 10   |
| Y+R:                                 | 4.0         | 4.0  | 4.0  | 4.0         | 4.0  | 4.0  | 4.0        | 4.0  | 4.0  | 4.0        | 4.0  | 4.0  |
| Volume Module: >> Count Date: 0 0 << |             |      |      |             |      |      |            |      |      |            |      |      |
| Base Vol:                            | 40          | 810  | 60   | 35          | 159  | 50   | 59         | 251  | 3    | 23         | 173  | 25   |
| Growth Adj:                          | 1.00        | 1.00 | 1.00 | 1.00        | 1.00 | 1.00 | 1.00       | 1.00 | 1.00 | 1.00       | 1.00 | 1.00 |
| Initial Bse:                         | 40          | 810  | 60   | 35          | 159  | 50   | 59         | 251  | 3    | 23         | 173  | 25   |
| Added Vol:                           | 0           | 0    | 0    | 0           | 0    | 0    | 0          | 0    | 0    | 0          | 0    | 0    |
| PasserByVol:                         | 0           | 0    | 0    | 0           | 0    | 0    | 0          | 0    | 0    | 0          | 0    | 0    |
| Initial Fut:                         | 40          | 810  | 60   | 35          | 159  | 50   | 59         | 251  | 3    | 23         | 173  | 25   |
| User Adj:                            | 1.00        | 1.00 | 1.00 | 1.00        | 1.00 | 1.00 | 1.00       | 1.00 | 1.00 | 1.00       | 1.00 | 1.00 |
| PHF Adj:                             | 1.00        | 1.00 | 1.00 | 1.00        | 1.00 | 1.00 | 1.00       | 1.00 | 1.00 | 1.00       | 1.00 | 1.00 |
| PHF Volume:                          | 40          | 810  | 60   | 35          | 159  | 50   | 59         | 251  | 3    | 23         | 173  | 25   |
| Reduct Vol:                          | 0           | 0    | 0    | 0           | 0    | 0    | 0          | 0    | 0    | 0          | 0    | 0    |
| Reduced Vol:                         | 40          | 810  | 60   | 35          | 159  | 50   | 59         | 251  | 3    | 23         | 173  | 25   |
| PCE Adj:                             | 1.00        | 1.00 | 1.00 | 1.00        | 1.00 | 1.00 | 1.00       | 1.00 | 1.00 | 1.00       | 1.00 | 1.00 |
| MLF Adj:                             | 1.00        | 1.00 | 1.00 | 1.00        | 1.00 | 1.00 | 1.00       | 1.00 | 1.00 | 1.00       | 1.00 | 1.00 |
| Final Volume:                        | 40          | 810  | 60   | 35          | 159  | 50   | 59         | 251  | 3    | 23         | 173  | 25   |
| Saturation Flow Module:              |             |      |      |             |      |      |            |      |      |            |      |      |
| Sat/Lane:                            | 1900        | 1900 | 1900 | 1900        | 1900 | 1900 | 1900       | 1900 | 1900 | 1900       | 1900 | 1900 |
| Adjustment:                          | 0.92        | 0.98 | 0.95 | 0.92        | 0.98 | 0.95 | 0.92       | 1.00 | 0.92 | 0.92       | 0.95 | 0.95 |
| Lanes:                               | 1.00        | 1.86 | 0.14 | 1.00        | 1.51 | 0.49 | 1.00       | 1.00 | 1.00 | 1.00       | 0.87 | 0.13 |
| Final Sat.:                          | 1750        | 3445 | 255  | 1750        | 2814 | 885  | 1750       | 1900 | 1750 | 1750       | 1573 | 227  |
| Capacity Analysis Module:            |             |      |      |             |      |      |            |      |      |            |      |      |
| Vol/Sat:                             | 0.02        | 0.24 | 0.24 | 0.02        | 0.06 | 0.06 | 0.03       | 0.13 | 0.00 | 0.01       | 0.11 | 0.11 |
| Crit Moves:                          | ****        | **** | **** | ****        | **** | **** | ****       | **** | **** | ****       | **** | **** |
| Green Time:                          | 25.0        | 53.8 | 53.8 | 7.0         | 35.8 | 35.8 | 30.2       | 30.2 | 30.2 | 30.2       | 30.2 | 30.2 |
| Volume/Cap:                          | 0.09        | 0.44 | 0.44 | 0.29        | 0.16 | 0.16 | 0.11       | 0.44 | 0.01 | 0.04       | 0.36 | 0.36 |
| Delay/Veh:                           | 28.9        | 14.1 | 14.1 | 45.4        | 21.9 | 21.9 | 25.3       | 28.6 | 24.4 | 24.7       | 27.8 | 27.8 |
| User DelAdj:                         | 1.00        | 1.00 | 1.00 | 1.00        | 1.00 | 1.00 | 1.00       | 1.00 | 1.00 | 1.00       | 1.00 | 1.00 |
| AdjDel/Veh:                          | 28.9        | 14.1 | 14.1 | 45.4        | 21.9 | 21.9 | 25.3       | 28.6 | 24.4 | 24.7       | 27.8 | 27.8 |
| LOS by Move:                         | C           | B    | B    | D           | C    | C    | C          | C    | C    | C          | C    | C    |
| HCM2k95thQ:                          | 2           | 15   | 15   | 2           | 4    | 4    | 3          | 12   | 0    | 1          | 9    | 9    |

Note: Queue reported is the number of cars per lane.

BART

Level Of Service Computation Report  
 2000 HCM Operations (Future Volume Alternative)  
 PM - Cumulative With Project

Intersection #127: Lincoln/Homestead [Study Int 60]

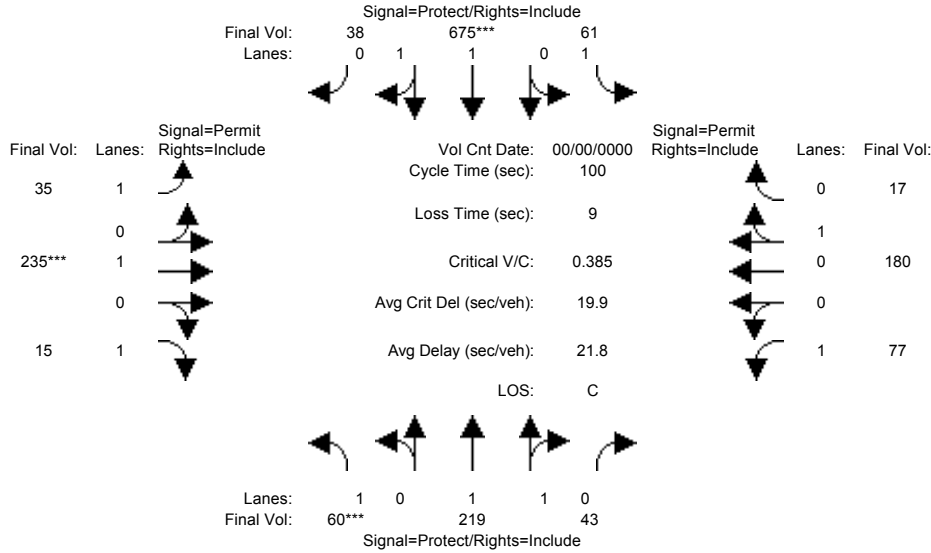

| Approach:                            | North Bound |      |      | South Bound |      |      | East Bound |      |      | West Bound |      |      |
|--------------------------------------|-------------|------|------|-------------|------|------|------------|------|------|------------|------|------|
| Movement:                            | L           | T    | R    | L           | T    | R    | L          | T    | R    | L          | T    | R    |
| Min. Green:                          | 7           | 10   | 10   | 7           | 10   | 10   | 7          | 10   | 10   | 7          | 10   | 10   |
| Y+R:                                 | 4.0         | 4.0  | 4.0  | 4.0         | 4.0  | 4.0  | 4.0        | 4.0  | 4.0  | 4.0        | 4.0  | 4.0  |
| Volume Module: >> Count Date: 0 0 << |             |      |      |             |      |      |            |      |      |            |      |      |
| Base Vol:                            | 60          | 219  | 43   | 61          | 675  | 38   | 35         | 235  | 15   | 77         | 180  | 17   |
| Growth Adj:                          | 1.00        | 1.00 | 1.00 | 1.00        | 1.00 | 1.00 | 1.00       | 1.00 | 1.00 | 1.00       | 1.00 | 1.00 |
| Initial Bse:                         | 60          | 219  | 43   | 61          | 675  | 38   | 35         | 235  | 15   | 77         | 180  | 17   |
| Added Vol:                           | 0           | 0    | 0    | 0           | 0    | 0    | 0          | 0    | 0    | 0          | 0    | 0    |
| PasserByVol:                         | 0           | 0    | 0    | 0           | 0    | 0    | 0          | 0    | 0    | 0          | 0    | 0    |
| Initial Fut:                         | 60          | 219  | 43   | 61          | 675  | 38   | 35         | 235  | 15   | 77         | 180  | 17   |
| User Adj:                            | 1.00        | 1.00 | 1.00 | 1.00        | 1.00 | 1.00 | 1.00       | 1.00 | 1.00 | 1.00       | 1.00 | 1.00 |
| PHF Adj:                             | 1.00        | 1.00 | 1.00 | 1.00        | 1.00 | 1.00 | 1.00       | 1.00 | 1.00 | 1.00       | 1.00 | 1.00 |
| PHF Volume:                          | 60          | 219  | 43   | 61          | 675  | 38   | 35         | 235  | 15   | 77         | 180  | 17   |
| Reduct Vol:                          | 0           | 0    | 0    | 0           | 0    | 0    | 0          | 0    | 0    | 0          | 0    | 0    |
| Reduced Vol:                         | 60          | 219  | 43   | 61          | 675  | 38   | 35         | 235  | 15   | 77         | 180  | 17   |
| PCE Adj:                             | 1.00        | 1.00 | 1.00 | 1.00        | 1.00 | 1.00 | 1.00       | 1.00 | 1.00 | 1.00       | 1.00 | 1.00 |
| MLF Adj:                             | 1.00        | 1.00 | 1.00 | 1.00        | 1.00 | 1.00 | 1.00       | 1.00 | 1.00 | 1.00       | 1.00 | 1.00 |
| Final Volume:                        | 60          | 219  | 43   | 61          | 675  | 38   | 35         | 235  | 15   | 77         | 180  | 17   |
| Saturation Flow Module:              |             |      |      |             |      |      |            |      |      |            |      |      |
| Sat/Lane:                            | 1900        | 1900 | 1900 | 1900        | 1900 | 1900 | 1900       | 1900 | 1900 | 1900       | 1900 | 1900 |
| Adjustment:                          | 0.92        | 0.98 | 0.95 | 0.92        | 0.98 | 0.95 | 0.92       | 1.00 | 0.92 | 0.92       | 0.95 | 0.95 |
| Lanes:                               | 1.00        | 1.66 | 0.34 | 1.00        | 1.89 | 0.11 | 1.00       | 1.00 | 1.00 | 1.00       | 0.91 | 0.09 |
| Final Sat.:                          | 1750        | 3092 | 607  | 1750        | 3503 | 197  | 1750       | 1900 | 1750 | 1750       | 1645 | 155  |
| Capacity Analysis Module:            |             |      |      |             |      |      |            |      |      |            |      |      |
| Vol/Sat:                             | 0.03        | 0.07 | 0.07 | 0.03        | 0.19 | 0.19 | 0.02       | 0.12 | 0.01 | 0.04       | 0.11 | 0.11 |
| Crit Moves:                          | ****        |      |      | ****        |      |      | ****       |      |      | ****       |      |      |
| Green Time:                          | 8.9         | 34.6 | 34.6 | 24.3        | 50.0 | 50.0 | 32.1       | 32.1 | 32.1 | 32.1       | 32.1 | 32.1 |
| Volume/Cap:                          | 0.39        | 0.20 | 0.20 | 0.14        | 0.39 | 0.39 | 0.06       | 0.39 | 0.03 | 0.14       | 0.34 | 0.34 |
| Delay/Veh:                           | 44.6        | 23.1 | 23.1 | 29.9        | 15.6 | 15.6 | 23.6       | 26.7 | 23.3 | 24.2       | 26.2 | 26.2 |
| User DelAdj:                         | 1.00        | 1.00 | 1.00 | 1.00        | 1.00 | 1.00 | 1.00       | 1.00 | 1.00 | 1.00       | 1.00 | 1.00 |
| AdjDel/Veh:                          | 44.6        | 23.1 | 23.1 | 29.9        | 15.6 | 15.6 | 23.6       | 26.7 | 23.3 | 24.2       | 26.2 | 26.2 |
| LOS by Move:                         | D           | C    | C    | C           | B    | B    | C          | C    | C    | C          | C    | C    |
| HCM2k95thQ:                          | 4           | 6    | 6    | 3           | 13   | 13   | 2          | 10   | 1    | 4          | 9    | 9    |

Note: Queue reported is the number of cars per lane.

BART

Level Of Service Computation Report  
 2000 HCM Operations (Future Volume Alternative)  
 AM - Cumulative No Project

Intersection #128: Homestead/Lafayette [Study Int 50]

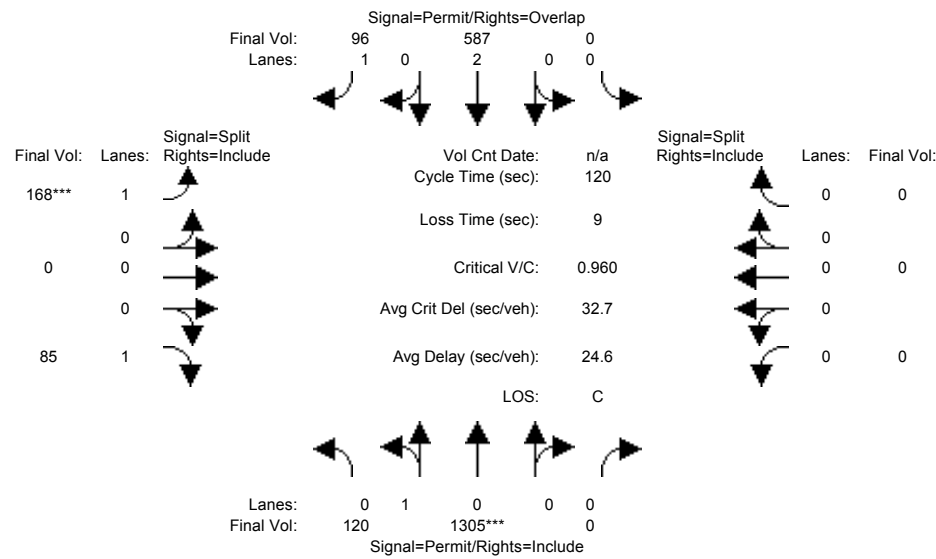

| Approach:                 | North Bound |      |      | South Bound |      |       | East Bound |      |      | West Bound |      |      |
|---------------------------|-------------|------|------|-------------|------|-------|------------|------|------|------------|------|------|
| Movement:                 | L           | T    | R    | L           | T    | R     | L          | T    | R    | L          | T    | R    |
| Min. Green:               | 10          | 10   | 10   | 10          | 10   | 10    | 10         | 10   | 10   | 10         | 10   | 10   |
| Y+R:                      | 4.0         | 4.0  | 4.0  | 4.0         | 4.0  | 4.0   | 4.0        | 4.0  | 4.0  | 4.0        | 4.0  | 4.0  |
| Volume Module:            |             |      |      |             |      |       |            |      |      |            |      |      |
| Base Vol:                 | 120         | 1305 | 0    | 0           | 0    | 587   | 96         | 168  | 0    | 85         | 0    | 0    |
| Growth Adj:               | 1.00        | 1.00 | 1.00 | 1.00        | 1.00 | 1.00  | 1.00       | 1.00 | 1.00 | 1.00       | 1.00 | 1.00 |
| Initial Bse:              | 120         | 1305 | 0    | 0           | 0    | 587   | 96         | 168  | 0    | 85         | 0    | 0    |
| Added Vol:                | 0           | 0    | 0    | 0           | 0    | 0     | 0          | 0    | 0    | 0          | 0    | 0    |
| PasserByVol:              | 0           | 0    | 0    | 0           | 0    | 0     | 0          | 0    | 0    | 0          | 0    | 0    |
| Initial Fut:              | 120         | 1305 | 0    | 0           | 0    | 587   | 96         | 168  | 0    | 85         | 0    | 0    |
| User Adj:                 | 1.00        | 1.00 | 1.00 | 1.00        | 1.00 | 1.00  | 1.00       | 1.00 | 1.00 | 1.00       | 1.00 | 1.00 |
| PHF Adj:                  | 1.00        | 1.00 | 1.00 | 1.00        | 1.00 | 1.00  | 1.00       | 1.00 | 1.00 | 1.00       | 1.00 | 1.00 |
| PHF Volume:               | 120         | 1305 | 0    | 0           | 0    | 587   | 96         | 168  | 0    | 85         | 0    | 0    |
| Reduct Vol:               | 0           | 0    | 0    | 0           | 0    | 0     | 0          | 0    | 0    | 0          | 0    | 0    |
| Reduced Vol:              | 120         | 1305 | 0    | 0           | 0    | 587   | 96         | 168  | 0    | 85         | 0    | 0    |
| PCE Adj:                  | 1.00        | 1.00 | 1.00 | 1.00        | 1.00 | 1.00  | 1.00       | 1.00 | 1.00 | 1.00       | 1.00 | 1.00 |
| MLF Adj:                  | 1.00        | 1.00 | 1.00 | 1.00        | 1.00 | 1.00  | 1.00       | 1.00 | 1.00 | 1.00       | 1.00 | 1.00 |
| Final Volume:             | 120         | 1305 | 0    | 0           | 0    | 587   | 96         | 168  | 0    | 85         | 0    | 0    |
| Saturation Flow Module:   |             |      |      |             |      |       |            |      |      |            |      |      |
| Sat/Lane:                 | 1900        | 1900 | 1900 | 1900        | 1900 | 1900  | 1900       | 1900 | 1900 | 1900       | 1900 | 1900 |
| Adjustment:               | 0.95        | 0.95 | 0.92 | 0.92        | 1.00 | 0.92  | 0.92       | 1.00 | 0.92 | 0.92       | 1.00 | 0.92 |
| Lanes:                    | 0.08        | 0.92 | 0.00 | 0.00        | 2.00 | 1.00  | 1.00       | 0.00 | 1.00 | 0.00       | 0.00 | 0.00 |
| Final Sat.:               | 152         | 1648 | 0    | 0           | 3800 | 1750  | 1750       | 0    | 1750 | 0          | 0    | 0    |
| Capacity Analysis Module: |             |      |      |             |      |       |            |      |      |            |      |      |
| Vol/Sat:                  | 0.79        | 0.79 | 0.00 | 0.00        | 0.15 | 0.05  | 0.10       | 0.00 | 0.05 | 0.00       | 0.00 | 0.00 |
| Crit Moves:               | ****        |      |      | ****        |      |       | ****       |      |      | ****       |      |      |
| Green Time:               | 99.0        | 99.0 | 0.0  | 0.0         | 99.0 | 111.0 | 12.0       | 0.0  | 12.0 | 0.0        | 0.0  | 0.0  |
| Volume/Cap:               | 0.96        | 0.96 | 0.00 | 0.00        | 0.19 | 0.06  | 0.96       | 0.00 | 0.49 | 0.00       | 0.00 | 0.00 |
| Delay/Veh:                | 23.7        | 23.7 | 0.0  | 0.0         | 2.2  | 0.4   | 109.8      | 0.0  | 53.2 | 0.0        | 0.0  | 0.0  |
| User DelAdj:              | 1.00        | 1.00 | 1.00 | 1.00        | 1.00 | 1.00  | 1.00       | 1.00 | 1.00 | 1.00       | 1.00 | 1.00 |
| AdjDel/Veh:               | 23.7        | 23.7 | 0.0  | 0.0         | 2.2  | 0.4   | 109.8      | 0.0  | 53.2 | 0.0        | 0.0  | 0.0  |
| LOS by Move:              | C           | C    | A    | A           | A    | A     | F          | A    | D    | A          | A    | A    |
| HCM2k95thQ:               | 81          | 81   | 0    | 0           | 4    | 1     | 15         | 0    | 6    | 0          | 0    | 0    |

Note: Queue reported is the number of cars per lane.

BART

Level Of Service Computation Report  
 2000 HCM Operations (Future Volume Alternative)  
 PM - Cumulative No Project

Intersection #128: Homestead/Lafayette [Study Int 50]

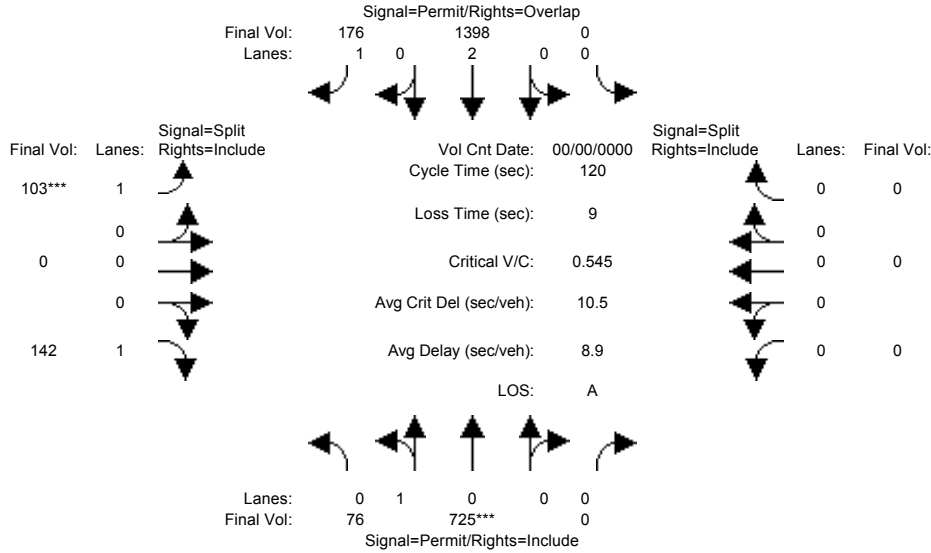

| Approach:                            | North Bound |      |      | South Bound |      |       | East Bound |      |      | West Bound |      |      |
|--------------------------------------|-------------|------|------|-------------|------|-------|------------|------|------|------------|------|------|
| Movement:                            | L           | T    | R    | L           | T    | R     | L          | T    | R    | L          | T    | R    |
| Min. Green:                          | 10          | 10   | 10   | 10          | 10   | 10    | 10         | 10   | 10   | 10         | 10   | 10   |
| Y+R:                                 | 4.0         | 4.0  | 4.0  | 4.0         | 4.0  | 4.0   | 4.0        | 4.0  | 4.0  | 4.0        | 4.0  | 4.0  |
| Volume Module: >> Count Date: 0 0 << |             |      |      |             |      |       |            |      |      |            |      |      |
| Base Vol:                            | 76          | 725  | 0    | 0           | 1398 | 176   | 103        | 0    | 142  | 0          | 0    | 0    |
| Growth Adj:                          | 1.00        | 1.00 | 1.00 | 1.00        | 1.00 | 1.00  | 1.00       | 1.00 | 1.00 | 1.00       | 1.00 | 1.00 |
| Initial Bse:                         | 76          | 725  | 0    | 0           | 1398 | 176   | 103        | 0    | 142  | 0          | 0    | 0    |
| Added Vol:                           | 0           | 0    | 0    | 0           | 0    | 0     | 0          | 0    | 0    | 0          | 0    | 0    |
| PasserByVol:                         | 0           | 0    | 0    | 0           | 0    | 0     | 0          | 0    | 0    | 0          | 0    | 0    |
| Initial Fut:                         | 76          | 725  | 0    | 0           | 1398 | 176   | 103        | 0    | 142  | 0          | 0    | 0    |
| User Adj:                            | 1.00        | 1.00 | 1.00 | 1.00        | 1.00 | 1.00  | 1.00       | 1.00 | 1.00 | 1.00       | 1.00 | 1.00 |
| PHF Adj:                             | 1.00        | 1.00 | 1.00 | 1.00        | 1.00 | 1.00  | 1.00       | 1.00 | 1.00 | 1.00       | 1.00 | 1.00 |
| PHF Volume:                          | 76          | 725  | 0    | 0           | 1398 | 176   | 103        | 0    | 142  | 0          | 0    | 0    |
| Reduct Vol:                          | 0           | 0    | 0    | 0           | 0    | 0     | 0          | 0    | 0    | 0          | 0    | 0    |
| Reduced Vol:                         | 76          | 725  | 0    | 0           | 1398 | 176   | 103        | 0    | 142  | 0          | 0    | 0    |
| PCE Adj:                             | 1.00        | 1.00 | 1.00 | 1.00        | 1.00 | 1.00  | 1.00       | 1.00 | 1.00 | 1.00       | 1.00 | 1.00 |
| MLF Adj:                             | 1.00        | 1.00 | 1.00 | 1.00        | 1.00 | 1.00  | 1.00       | 1.00 | 1.00 | 1.00       | 1.00 | 1.00 |
| FinalVolume:                         | 76          | 725  | 0    | 0           | 1398 | 176   | 103        | 0    | 142  | 0          | 0    | 0    |
| Saturation Flow Module:              |             |      |      |             |      |       |            |      |      |            |      |      |
| Sat/Lane:                            | 1900        | 1900 | 1900 | 1900        | 1900 | 1900  | 1900       | 1900 | 1900 | 1900       | 1900 | 1900 |
| Adjustment:                          | 0.95        | 0.95 | 0.92 | 0.92        | 1.00 | 0.92  | 0.92       | 1.00 | 0.92 | 0.92       | 1.00 | 0.92 |
| Lanes:                               | 0.09        | 0.91 | 0.00 | 0.00        | 2.00 | 1.00  | 1.00       | 0.00 | 1.00 | 0.00       | 0.00 | 0.00 |
| Final Sat.:                          | 171         | 1629 | 0    | 0           | 3800 | 1750  | 1750       | 0    | 1750 | 0          | 0    | 0    |
| Capacity Analysis Module:            |             |      |      |             |      |       |            |      |      |            |      |      |
| Vol/Sat:                             | 0.45        | 0.45 | 0.00 | 0.00        | 0.37 | 0.10  | 0.06       | 0.00 | 0.08 | 0.00       | 0.00 | 0.00 |
| Crit Moves:                          | *****       |      |      |             |      |       |            |      |      |            |      |      |
| Green Time:                          | 93.9        | 93.9 | 0.0  | 0.0         | 93.9 | 111.0 | 17.1       | 0.0  | 17.1 | 0.0        | 0.0  | 0.0  |
| Volume/Cap:                          | 0.57        | 0.57 | 0.00 | 0.00        | 0.47 | 0.11  | 0.41       | 0.00 | 0.57 | 0.00       | 0.00 | 0.00 |
| Delay/Veh:                           | 5.7         | 5.7  | 0.0  | 0.0         | 4.6  | 0.4   | 48.0       | 0.0  | 51.1 | 0.0        | 0.0  | 0.0  |
| User DelAdj:                         | 1.00        | 1.00 | 1.00 | 1.00        | 1.00 | 1.00  | 1.00       | 1.00 | 1.00 | 1.00       | 1.00 | 1.00 |
| AdjDel/Veh:                          | 5.7         | 5.7  | 0.0  | 0.0         | 4.6  | 0.4   | 48.0       | 0.0  | 51.1 | 0.0        | 0.0  | 0.0  |
| LOS by Move:                         | A           | A    | A    | A           | A    | A     | D          | A    | D    | A          | A    | A    |
| HCM2k95thQ:                          | 22          | 22   | 0    | 0           | 16   | 1     | 7          | 0    | 10   | 0          | 0    | 0    |

Note: Queue reported is the number of cars per lane.

BART

Level Of Service Computation Report  
2000 HCM Operations (Future Volume Alternative)  
AM - Cumulative With Project

Intersection #128: Homestead/Lafayette [Study Int 50]

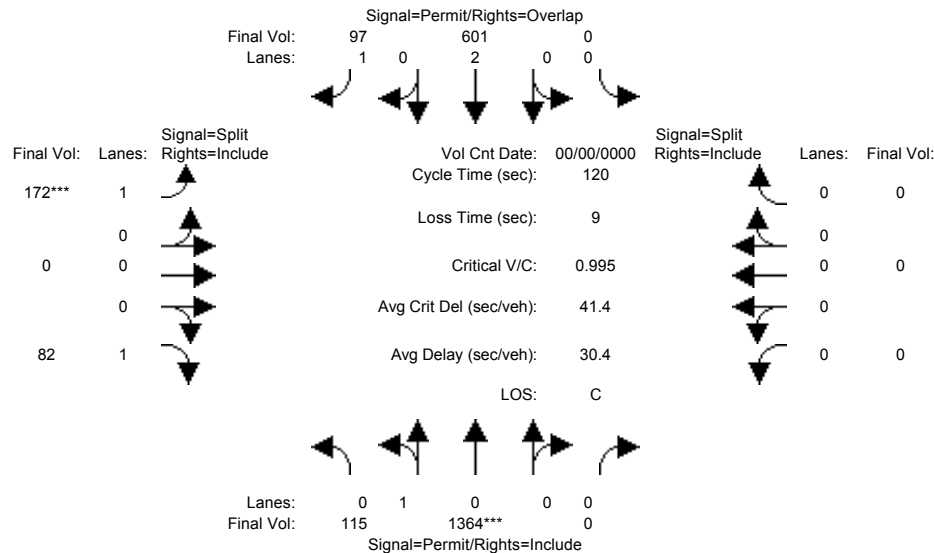

| Approach:                            | North Bound |      |      | South Bound |      |       | East Bound |      |      | West Bound |      |      |
|--------------------------------------|-------------|------|------|-------------|------|-------|------------|------|------|------------|------|------|
| Movement:                            | L           | T    | R    | L           | T    | R     | L          | T    | R    | L          | T    | R    |
| Min. Green:                          | 10          | 10   | 10   | 10          | 10   | 10    | 10         | 10   | 10   | 10         | 10   | 10   |
| Y+R:                                 | 4.0         | 4.0  | 4.0  | 4.0         | 4.0  | 4.0   | 4.0        | 4.0  | 4.0  | 4.0        | 4.0  | 4.0  |
| Volume Module: >> Count Date: 0 0 << |             |      |      |             |      |       |            |      |      |            |      |      |
| Base Vol:                            | 115         | 1364 | 0    | 0           | 0    | 601   | 97         | 172  | 0    | 82         | 0    | 0    |
| Growth Adj:                          | 1.00        | 1.00 | 1.00 | 1.00        | 1.00 | 1.00  | 1.00       | 1.00 | 1.00 | 1.00       | 1.00 | 1.00 |
| Initial Bse:                         | 115         | 1364 | 0    | 0           | 0    | 601   | 97         | 172  | 0    | 82         | 0    | 0    |
| Added Vol:                           | 0           | 0    | 0    | 0           | 0    | 0     | 0          | 0    | 0    | 0          | 0    | 0    |
| PasserByVol:                         | 0           | 0    | 0    | 0           | 0    | 0     | 0          | 0    | 0    | 0          | 0    | 0    |
| Initial Fut:                         | 115         | 1364 | 0    | 0           | 0    | 601   | 97         | 172  | 0    | 82         | 0    | 0    |
| User Adj:                            | 1.00        | 1.00 | 1.00 | 1.00        | 1.00 | 1.00  | 1.00       | 1.00 | 1.00 | 1.00       | 1.00 | 1.00 |
| PHF Adj:                             | 1.00        | 1.00 | 1.00 | 1.00        | 1.00 | 1.00  | 1.00       | 1.00 | 1.00 | 1.00       | 1.00 | 1.00 |
| PHF Volume:                          | 115         | 1364 | 0    | 0           | 0    | 601   | 97         | 172  | 0    | 82         | 0    | 0    |
| Reduct Vol:                          | 0           | 0    | 0    | 0           | 0    | 0     | 0          | 0    | 0    | 0          | 0    | 0    |
| Reduced Vol:                         | 115         | 1364 | 0    | 0           | 0    | 601   | 97         | 172  | 0    | 82         | 0    | 0    |
| PCE Adj:                             | 1.00        | 1.00 | 1.00 | 1.00        | 1.00 | 1.00  | 1.00       | 1.00 | 1.00 | 1.00       | 1.00 | 1.00 |
| MLF Adj:                             | 1.00        | 1.00 | 1.00 | 1.00        | 1.00 | 1.00  | 1.00       | 1.00 | 1.00 | 1.00       | 1.00 | 1.00 |
| Final Volume:                        | 115         | 1364 | 0    | 0           | 0    | 601   | 97         | 172  | 0    | 82         | 0    | 0    |
| Saturation Flow Module:              |             |      |      |             |      |       |            |      |      |            |      |      |
| Sat/Lane:                            | 1900        | 1900 | 1900 | 1900        | 1900 | 1900  | 1900       | 1900 | 1900 | 1900       | 1900 | 1900 |
| Adjustment:                          | 0.95        | 0.95 | 0.92 | 0.92        | 1.00 | 0.92  | 0.92       | 1.00 | 0.92 | 0.92       | 1.00 | 0.92 |
| Lanes:                               | 0.08        | 0.92 | 0.00 | 0.00        | 2.00 | 1.00  | 1.00       | 0.00 | 1.00 | 0.00       | 0.00 | 0.00 |
| Final Sat.:                          | 140         | 1660 | 0    | 0           | 3800 | 1750  | 1750       | 0    | 1750 | 0          | 0    | 0    |
| Capacity Analysis Module:            |             |      |      |             |      |       |            |      |      |            |      |      |
| Vol/Sat:                             | 0.82        | 0.82 | 0.00 | 0.00        | 0.16 | 0.06  | 0.10       | 0.00 | 0.05 | 0.00       | 0.00 | 0.00 |
| Crit Moves:                          | *****       |      |      |             |      |       |            |      |      |            |      |      |
| Green Time:                          | 99.1        | 99.1 | 0.0  | 0.0         | 99.1 | 111.0 | 11.9       | 0.0  | 11.9 | 0.0        | 0.0  | 0.0  |
| Volume/Cap:                          | 0.99        | 0.99 | 0.00 | 0.00        | 0.19 | 0.06  | 0.99       | 0.00 | 0.47 | 0.00       | 0.00 | 0.00 |
| Delay/Veh:                           | 32.1        | 32.1 | 0.0  | 0.0         | 2.2  | 0.4   | 120.8      | 0.0  | 53.2 | 0.0        | 0.0  | 0.0  |
| User DelAdj:                         | 1.00        | 1.00 | 1.00 | 1.00        | 1.00 | 1.00  | 1.00       | 1.00 | 1.00 | 1.00       | 1.00 | 1.00 |
| AdjDel/Veh:                          | 32.1        | 32.1 | 0.0  | 0.0         | 2.2  | 0.4   | 120.8      | 0.0  | 53.2 | 0.0        | 0.0  | 0.0  |
| LOS by Move:                         | C           | C    | A    | A           | A    | A     | F          | A    | D    | A          | A    | A    |
| HCM2k95thQ:                          | 98          | 98   | 0    | 0           | 5    | 1     | 16         | 0    | 6    | 0          | 0    | 0    |

Note: Queue reported is the number of cars per lane.

BART

Level Of Service Computation Report  
 2000 HCM Operations (Future Volume Alternative)  
 PM - Cumulative With Project

Intersection #128: Homestead/Lafayette [Study Int 50]

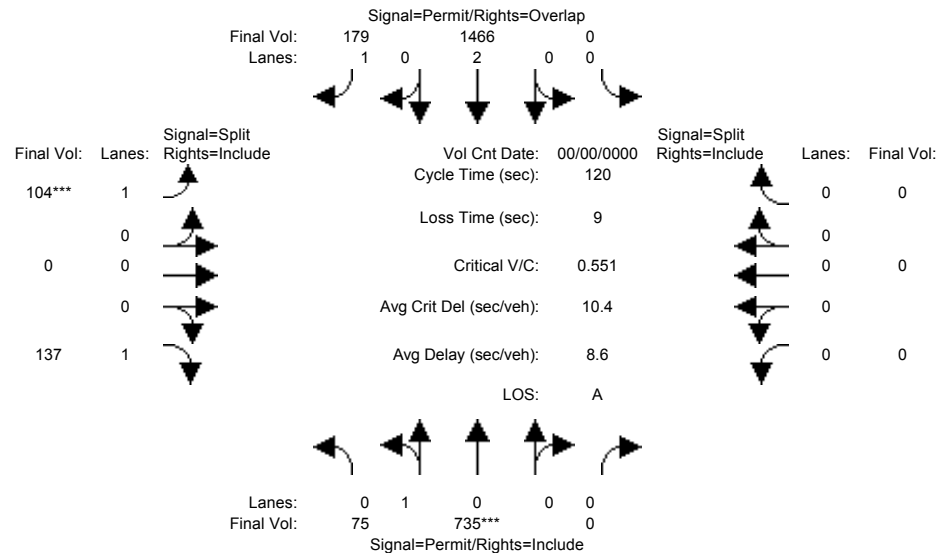

| Approach:                 | North Bound           |      |      | South Bound |      |       | East Bound |      |      | West Bound |      |      |
|---------------------------|-----------------------|------|------|-------------|------|-------|------------|------|------|------------|------|------|
| Movement:                 | L                     | T    | R    | L           | T    | R     | L          | T    | R    | L          | T    | R    |
| Min. Green:               | 10                    | 10   | 10   | 10          | 10   | 10    | 10         | 10   | 10   | 10         | 10   | 10   |
| Y+R:                      | 4.0                   | 4.0  | 4.0  | 4.0         | 4.0  | 4.0   | 4.0        | 4.0  | 4.0  | 4.0        | 4.0  | 4.0  |
| Volume Module:            | >> Count Date: 0 0 << |      |      |             |      |       |            |      |      |            |      |      |
| Base Vol:                 | 75                    | 735  | 0    | 0           | 1466 | 179   | 104        | 0    | 137  | 0          | 0    | 0    |
| Growth Adj:               | 1.00                  | 1.00 | 1.00 | 1.00        | 1.00 | 1.00  | 1.00       | 1.00 | 1.00 | 1.00       | 1.00 | 1.00 |
| Initial Bse:              | 75                    | 735  | 0    | 0           | 1466 | 179   | 104        | 0    | 137  | 0          | 0    | 0    |
| Added Vol:                | 0                     | 0    | 0    | 0           | 0    | 0     | 0          | 0    | 0    | 0          | 0    | 0    |
| PasserByVol:              | 0                     | 0    | 0    | 0           | 0    | 0     | 0          | 0    | 0    | 0          | 0    | 0    |
| Initial Fut:              | 75                    | 735  | 0    | 0           | 1466 | 179   | 104        | 0    | 137  | 0          | 0    | 0    |
| User Adj:                 | 1.00                  | 1.00 | 1.00 | 1.00        | 1.00 | 1.00  | 1.00       | 1.00 | 1.00 | 1.00       | 1.00 | 1.00 |
| PHF Adj:                  | 1.00                  | 1.00 | 1.00 | 1.00        | 1.00 | 1.00  | 1.00       | 1.00 | 1.00 | 1.00       | 1.00 | 1.00 |
| PHF Volume:               | 75                    | 735  | 0    | 0           | 1466 | 179   | 104        | 0    | 137  | 0          | 0    | 0    |
| Reduct Vol:               | 0                     | 0    | 0    | 0           | 0    | 0     | 0          | 0    | 0    | 0          | 0    | 0    |
| Reduced Vol:              | 75                    | 735  | 0    | 0           | 1466 | 179   | 104        | 0    | 137  | 0          | 0    | 0    |
| PCE Adj:                  | 1.00                  | 1.00 | 1.00 | 1.00        | 1.00 | 1.00  | 1.00       | 1.00 | 1.00 | 1.00       | 1.00 | 1.00 |
| MLF Adj:                  | 1.00                  | 1.00 | 1.00 | 1.00        | 1.00 | 1.00  | 1.00       | 1.00 | 1.00 | 1.00       | 1.00 | 1.00 |
| Final Volume:             | 75                    | 735  | 0    | 0           | 1466 | 179   | 104        | 0    | 137  | 0          | 0    | 0    |
| Saturation Flow Module:   |                       |      |      |             |      |       |            |      |      |            |      |      |
| Sat/Lane:                 | 1900                  | 1900 | 1900 | 1900        | 1900 | 1900  | 1900       | 1900 | 1900 | 1900       | 1900 | 1900 |
| Adjustment:               | 0.95                  | 0.95 | 0.92 | 0.92        | 1.00 | 0.92  | 0.92       | 1.00 | 0.92 | 0.92       | 1.00 | 0.92 |
| Lanes:                    | 0.09                  | 0.91 | 0.00 | 0.00        | 2.00 | 1.00  | 1.00       | 0.00 | 1.00 | 0.00       | 0.00 | 0.00 |
| Final Sat.:               | 167                   | 1633 | 0    | 0           | 3800 | 1750  | 1750       | 0    | 1750 | 0          | 0    | 0    |
| Capacity Analysis Module: |                       |      |      |             |      |       |            |      |      |            |      |      |
| Vol/Sat:                  | 0.45                  | 0.45 | 0.00 | 0.00        | 0.39 | 0.10  | 0.06       | 0.00 | 0.08 | 0.00       | 0.00 | 0.00 |
| Crit Moves:               | ****                  |      |      |             |      |       |            |      |      |            |      |      |
| Green Time:               | 94.6                  | 94.6 | 0.0  | 0.0         | 94.6 | 111.0 | 16.4       | 0.0  | 16.4 | 0.0        | 0.0  | 0.0  |
| Volume/Cap:               | 0.57                  | 0.57 | 0.00 | 0.00        | 0.49 | 0.11  | 0.43       | 0.00 | 0.57 | 0.00       | 0.00 | 0.00 |
| Delay/Veh:                | 5.5                   | 5.5  | 0.0  | 0.0         | 4.5  | 0.4   | 48.8       | 0.0  | 51.8 | 0.0        | 0.0  | 0.0  |
| User DelAdj:              | 1.00                  | 1.00 | 1.00 | 1.00        | 1.00 | 1.00  | 1.00       | 1.00 | 1.00 | 1.00       | 1.00 | 1.00 |
| AdjDel/Veh:               | 5.5                   | 5.5  | 0.0  | 0.0         | 4.5  | 0.4   | 48.8       | 0.0  | 51.8 | 0.0        | 0.0  | 0.0  |
| LOS by Move:              | A                     | A    | A    | A           | A    | A     | D          | A    | D    | A          | A    | A    |
| HCM2k95thQ:               | 22                    | 22   | 0    | 0           | 17   | 1     | 7          | 0    | 10   | 0          | 0    | 0    |

Note: Queue reported is the number of cars per lane.

BART

Level Of Service Computation Report  
 2000 HCM Operations (Future Volume Alternative)  
 AM - Cumulative No Project

Intersection #175: Reed/De La Cruz [Study Int 32]

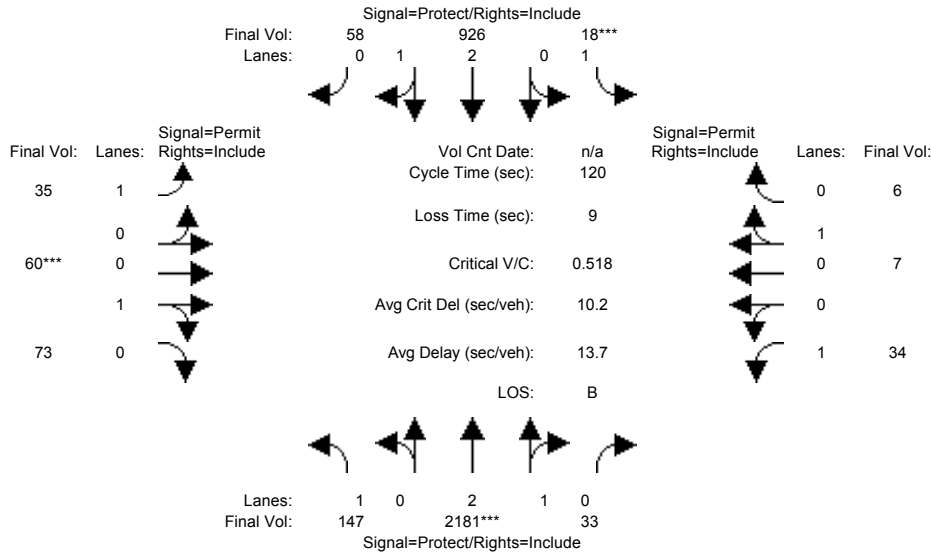

| Approach:                 | North Bound |      |      | South Bound |      |      | East Bound |      |      | West Bound |      |      |
|---------------------------|-------------|------|------|-------------|------|------|------------|------|------|------------|------|------|
| Movement:                 | L           | T    | R    | L           | T    | R    | L          | T    | R    | L          | T    | R    |
| Min. Green:               | 7           | 10   | 10   | 7           | 10   | 10   | 10         | 10   | 10   | 10         | 10   | 10   |
| Y+R:                      | 4.0         | 4.0  | 4.0  | 4.0         | 4.0  | 4.0  | 4.0        | 4.0  | 4.0  | 4.0        | 4.0  | 4.0  |
| Volume Module:            |             |      |      |             |      |      |            |      |      |            |      |      |
| Base Vol:                 | 147         | 2181 | 33   | 18          | 926  | 58   | 35         | 60   | 73   | 34         | 7    | 6    |
| Growth Adj:               | 1.00        | 1.00 | 1.00 | 1.00        | 1.00 | 1.00 | 1.00       | 1.00 | 1.00 | 1.00       | 1.00 | 1.00 |
| Initial Bse:              | 147         | 2181 | 33   | 18          | 926  | 58   | 35         | 60   | 73   | 34         | 7    | 6    |
| Added Vol:                | 0           | 0    | 0    | 0           | 0    | 0    | 0          | 0    | 0    | 0          | 0    | 0    |
| PasserByVol:              | 0           | 0    | 0    | 0           | 0    | 0    | 0          | 0    | 0    | 0          | 0    | 0    |
| Initial Fut:              | 147         | 2181 | 33   | 18          | 926  | 58   | 35         | 60   | 73   | 34         | 7    | 6    |
| User Adj:                 | 1.00        | 1.00 | 1.00 | 1.00        | 1.00 | 1.00 | 1.00       | 1.00 | 1.00 | 1.00       | 1.00 | 1.00 |
| PHF Adj:                  | 1.00        | 1.00 | 1.00 | 1.00        | 1.00 | 1.00 | 1.00       | 1.00 | 1.00 | 1.00       | 1.00 | 1.00 |
| PHF Volume:               | 147         | 2181 | 33   | 18          | 926  | 58   | 35         | 60   | 73   | 34         | 7    | 6    |
| Reduct Vol:               | 0           | 0    | 0    | 0           | 0    | 0    | 0          | 0    | 0    | 0          | 0    | 0    |
| Reduced Vol:              | 147         | 2181 | 33   | 18          | 926  | 58   | 35         | 60   | 73   | 34         | 7    | 6    |
| PCE Adj:                  | 1.00        | 1.00 | 1.00 | 1.00        | 1.00 | 1.00 | 1.00       | 1.00 | 1.00 | 1.00       | 1.00 | 1.00 |
| MLF Adj:                  | 1.00        | 1.00 | 1.00 | 1.00        | 1.00 | 1.00 | 1.00       | 1.00 | 1.00 | 1.00       | 1.00 | 1.00 |
| FinalVolume:              | 147         | 2181 | 33   | 18          | 926  | 58   | 35         | 60   | 73   | 34         | 7    | 6    |
| Saturation Flow Module:   |             |      |      |             |      |      |            |      |      |            |      |      |
| Sat/Lane:                 | 1900        | 1900 | 1900 | 1900        | 1900 | 1900 | 1900       | 1900 | 1900 | 1900       | 1900 | 1900 |
| Adjustment:               | 0.92        | 0.98 | 0.95 | 0.92        | 0.98 | 0.95 | 0.92       | 0.95 | 0.95 | 0.92       | 0.95 | 0.95 |
| Lanes:                    | 1.00        | 2.95 | 0.05 | 1.00        | 2.82 | 0.18 | 1.00       | 0.45 | 0.55 | 1.00       | 0.54 | 0.46 |
| Final Sat.:               | 1750        | 5516 | 83   | 1750        | 5269 | 330  | 1750       | 812  | 988  | 1750       | 969  | 831  |
| Capacity Analysis Module: |             |      |      |             |      |      |            |      |      |            |      |      |
| Vol/Sat:                  | 0.08        | 0.40 | 0.40 | 0.01        | 0.18 | 0.18 | 0.02       | 0.07 | 0.07 | 0.02       | 0.01 | 0.01 |
| Crit Moves:               | ****        |      |      | ****        |      |      | ****       |      |      | ****       |      |      |
| Green Time:               | 30.6        | 87.6 | 87.6 | 7.0         | 64.0 | 64.0 | 16.4       | 16.4 | 16.4 | 16.4       | 16.4 | 16.4 |
| Volume/Cap:               | 0.33        | 0.54 | 0.54 | 0.18        | 0.33 | 0.33 | 0.15       | 0.54 | 0.54 | 0.14       | 0.05 | 0.05 |
| Delay/Veh:                | 36.8        | 7.4  | 7.4  | 54.6        | 15.9 | 15.9 | 45.9       | 50.8 | 50.8 | 45.9       | 45.2 | 45.2 |
| User DelAdj:              | 1.00        | 1.00 | 1.00 | 1.00        | 1.00 | 1.00 | 1.00       | 1.00 | 1.00 | 1.00       | 1.00 | 1.00 |
| AdjDel/Veh:               | 36.8        | 7.4  | 7.4  | 54.6        | 15.9 | 15.9 | 45.9       | 50.8 | 50.8 | 45.9       | 45.2 | 45.2 |
| LOS by Move:              | D           | A    | A    | D           | B    | B    | D          | D    | D    | D          | D    | D    |
| HCM2k95thQ:               | 9           | 22   | 22   | 1           | 13   | 13   | 2          | 9    | 9    | 3          | 1    | 1    |

Note: Queue reported is the number of cars per lane.



BART

Level Of Service Computation Report  
 2000 HCM Operations (Future Volume Alternative)  
 PM - Cumulative No Project

Intersection #175: Reed/De La Cruz [Study Int 32]

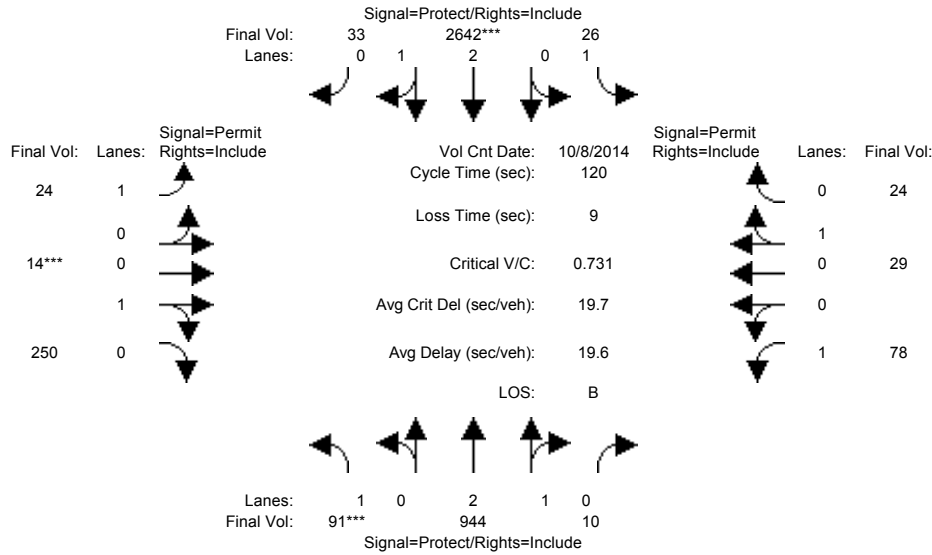

| Approach:                                   | North Bound |      |      | South Bound |      |      | East Bound |      |      | West Bound |      |      |
|---|-------------|------|------|-------------|------|------|------------|------|------|------------|------|------|
| Movement:                                   | L           | T    | R    | L           | T    | R    | L          | T    | R    | L          | T    | R    |
| Min. Green:                                 | 7           | 10   | 10   | 7           | 10   | 10   | 10         | 10   | 10   | 10         | 10   | 10   |
| Y+R:  | 4.0         | 4.0  | 4.0  | 4.0         | 4.0  | 4.0  | 4.0        | 4.0  | 4.0  | 4.0        | 4.0  | 4.0  |
| Volume Module: >> Count Date: 8 Oct 2014 << |             |      |      |             |      |      |            |      |      |            |      |      |
| Base Vol:                                   | 91          | 944  | 10   | 26          | 2642 | 33   | 24         | 14   | 250  | 78         | 29   | 24   |
| Growth Adj:                                 | 1.00        | 1.00 | 1.00 | 1.00        | 1.00 | 1.00 | 1.00       | 1.00 | 1.00 | 1.00       | 1.00 | 1.00 |
| Initial Bse:                                | 91          | 944  | 10   | 26          | 2642 | 33   | 24         | 14   | 250  | 78         | 29   | 24   |
| Added Vol:                                  | 0           | 0    | 0    | 0           | 0    | 0    | 0          | 0    | 0    | 0          | 0    | 0    |
| PasserByVol:                                | 0           | 0    | 0    | 0           | 0    | 0    | 0          | 0    | 0    | 0          | 0    | 0    |
| Initial Fut:                                | 91          | 944  | 10   | 26          | 2642 | 33   | 24         | 14   | 250  | 78         | 29   | 24   |
| User Adj:                                   | 1.00        | 1.00 | 1.00 | 1.00        | 1.00 | 1.00 | 1.00       | 1.00 | 1.00 | 1.00       | 1.00 | 1.00 |
| PHF Adj:                                    | 1.00        | 1.00 | 1.00 | 1.00        | 1.00 | 1.00 | 1.00       | 1.00 | 1.00 | 1.00       | 1.00 | 1.00 |
| PHF Volume:                                 | 91          | 944  | 10   | 26          | 2642 | 33   | 24         | 14   | 250  | 78         | 29   | 24   |
| Reduct Vol:                                 | 0           | 0    | 0    | 0           | 0    | 0    | 0          | 0    | 0    | 0          | 0    | 0    |
| Reduced Vol:                                | 91          | 944  | 10   | 26          | 2642 | 33   | 24         | 14   | 250  | 78         | 29   | 24   |
| PCE Adj:                                    | 1.00        | 1.00 | 1.00 | 1.00        | 1.00 | 1.00 | 1.00       | 1.00 | 1.00 | 1.00       | 1.00 | 1.00 |
| MLF Adj:                                    | 1.00        | 1.00 | 1.00 | 1.00        | 1.00 | 1.00 | 1.00       | 1.00 | 1.00 | 1.00       | 1.00 | 1.00 |
| FinalVolume:                                | 91          | 944  | 10   | 26          | 2642 | 33   | 24         | 14   | 250  | 78         | 29   | 24   |
| Saturation Flow Module:                     |             |      |      |             |      |      |            |      |      |            |      |      |
| Sat/Lane:                                   | 1900        | 1900 | 1900 | 1900        | 1900 | 1900 | 1900       | 1900 | 1900 | 1900       | 1900 | 1900 |
| Adjustment:                                 | 0.92        | 0.98 | 0.95 | 0.92        | 0.98 | 0.95 | 0.92       | 0.95 | 0.95 | 0.92       | 0.95 | 0.95 |
| Lanes:                                      | 1.00        | 2.97 | 0.03 | 1.00        | 2.96 | 0.04 | 1.00       | 0.05 | 0.95 | 1.00       | 0.55 | 0.45 |
| Final Sat.:                                 | 1750        | 5541 | 59   | 1750        | 5531 | 69   | 1750       | 95   | 1705 | 1750       | 985  | 815  |
| Capacity Analysis Module:                   |             |      |      |             |      |      |            |      |      |            |      |      |
| Vol/Sat:                                    | 0.05        | 0.17 | 0.17 | 0.01        | 0.48 | 0.48 | 0.01       | 0.15 | 0.15 | 0.04       | 0.03 | 0.03 |
| Crit Moves:                                 | ****        |      |      | ****        |      |      | ****       |      |      |            |      |      |
| Green Time:                                 | 8.5         | 64.8 | 64.8 | 22.2        | 78.4 | 78.4 | 24.1       | 24.1 | 24.1 | 24.1       | 24.1 | 24.1 |
| Volume/Cap:                                 | 0.73        | 0.32 | 0.32 | 0.08        | 0.73 | 0.73 | 0.07       | 0.73 | 0.73 | 0.22       | 0.15 | 0.15 |
| Delay/Veh:                                  | 74.4        | 15.4 | 15.4 | 40.6        | 14.6 | 14.6 | 39.0       | 52.4 | 52.4 | 40.5       | 39.7 | 39.7 |
| User DelAdj:                                | 1.00        | 1.00 | 1.00 | 1.00        | 1.00 | 1.00 | 1.00       | 1.00 | 1.00 | 1.00       | 1.00 | 1.00 |
| AdjDel/Veh:                                 | 74.4        | 15.4 | 15.4 | 40.6        | 14.6 | 14.6 | 39.0       | 52.4 | 52.4 | 40.5       | 39.7 | 39.7 |
| LOS by Move:                                | E           | B    | B    | D           | B    | B    | D          | D    | D    | D          | D    | D    |
| HCM2k95thQ:                                 | 10          | 12   | 12   | 2           | 38   | 38   | 2          | 18   | 18   | 5          | 3    | 3    |

Note: Queue reported is the number of cars per lane.

BART

Level Of Service Computation Report  
 2000 HCM Operations (Future Volume Alternative)  
 AM - Cumulative With Project

Intersection #175: Reed/De La Cruz [Study Int 32]

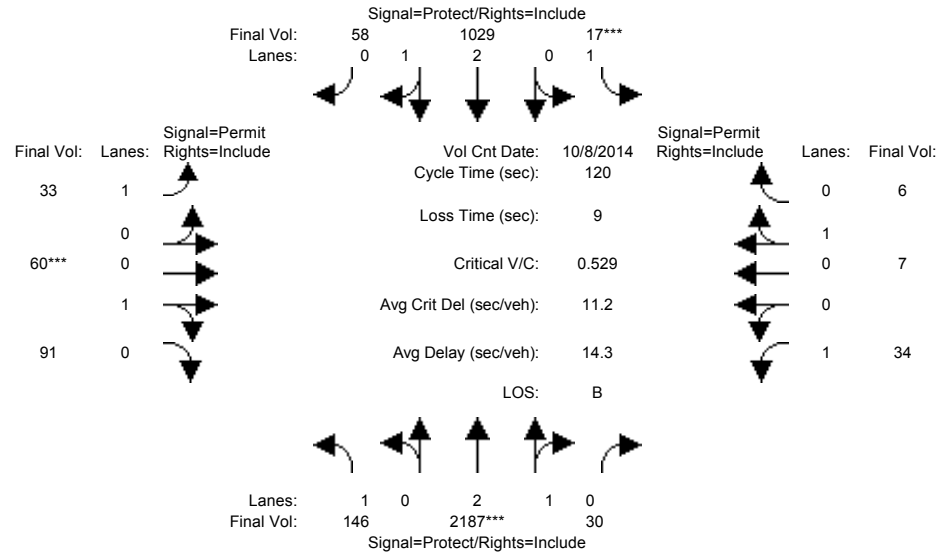

| Approach:                                   | North Bound |      |      | South Bound |      |      | East Bound |      |      | West Bound |      |      |
|---|-------------|------|------|-------------|------|------|------------|------|------|------------|------|------|
| Movement:                                   | L           | T    | R    | L           | T    | R    | L          | T    | R    | L          | T    | R    |
| Min. Green:                                 | 7           | 10   | 10   | 7           | 10   | 10   | 10         | 10   | 10   | 10         | 10   | 10   |
| Y+R:  | 4.0         | 4.0  | 4.0  | 4.0         | 4.0  | 4.0  | 4.0        | 4.0  | 4.0  | 4.0        | 4.0  | 4.0  |
| Volume Module: >> Count Date: 8 Oct 2014 << |             |      |      |             |      |      |            |      |      |            |      |      |
| Base Vol:                                   | 146         | 2187 | 30   | 17          | 1029 | 58   | 33         | 60   | 91   | 34         | 7    | 6    |
| Growth Adj:                                 | 1.00        | 1.00 | 1.00 | 1.00        | 1.00 | 1.00 | 1.00       | 1.00 | 1.00 | 1.00       | 1.00 | 1.00 |
| Initial Bse:                                | 146         | 2187 | 30   | 17          | 1029 | 58   | 33         | 60   | 91   | 34         | 7    | 6    |
| Added Vol:                                  | 0           | 0    | 0    | 0           | 0    | 0    | 0          | 0    | 0    | 0          | 0    | 0    |
| PasserByVol:                                | 0           | 0    | 0    | 0           | 0    | 0    | 0          | 0    | 0    | 0          | 0    | 0    |
| Initial Fut:                                | 146         | 2187 | 30   | 17          | 1029 | 58   | 33         | 60   | 91   | 34         | 7    | 6    |
| User Adj:                                   | 1.00        | 1.00 | 1.00 | 1.00        | 1.00 | 1.00 | 1.00       | 1.00 | 1.00 | 1.00       | 1.00 | 1.00 |
| PHF Adj:                                    | 1.00        | 1.00 | 1.00 | 1.00        | 1.00 | 1.00 | 1.00       | 1.00 | 1.00 | 1.00       | 1.00 | 1.00 |
| PHF Volume:                                 | 146         | 2187 | 30   | 17          | 1029 | 58   | 33         | 60   | 91   | 34         | 7    | 6    |
| Reduct Vol:                                 | 0           | 0    | 0    | 0           | 0    | 0    | 0          | 0    | 0    | 0          | 0    | 0    |
| Reduced Vol:                                | 146         | 2187 | 30   | 17          | 1029 | 58   | 33         | 60   | 91   | 34         | 7    | 6    |
| PCE Adj:                                    | 1.00        | 1.00 | 1.00 | 1.00        | 1.00 | 1.00 | 1.00       | 1.00 | 1.00 | 1.00       | 1.00 | 1.00 |
| MLF Adj:                                    | 1.00        | 1.00 | 1.00 | 1.00        | 1.00 | 1.00 | 1.00       | 1.00 | 1.00 | 1.00       | 1.00 | 1.00 |
| FinalVolume:                                | 146         | 2187 | 30   | 17          | 1029 | 58   | 33         | 60   | 91   | 34         | 7    | 6    |
| Saturation Flow Module:                     |             |      |      |             |      |      |            |      |      |            |      |      |
| Sat/Lane:                                   | 1900        | 1900 | 1900 | 1900        | 1900 | 1900 | 1900       | 1900 | 1900 | 1900       | 1900 | 1900 |
| Adjustment:                                 | 0.92        | 0.98 | 0.95 | 0.92        | 0.98 | 0.95 | 0.92       | 0.95 | 0.95 | 0.92       | 0.95 | 0.95 |
| Lanes:                                      | 1.00        | 2.96 | 0.04 | 1.00        | 2.83 | 0.17 | 1.00       | 0.40 | 0.60 | 1.00       | 0.54 | 0.46 |
| Final Sat.:                                 | 1750        | 5524 | 76   | 1750        | 5301 | 299  | 1750       | 715  | 1085 | 1750       | 969  | 831  |
| Capacity Analysis Module:                   |             |      |      |             |      |      |            |      |      |            |      |      |
| Vol/Sat:                                    | 0.08        | 0.40 | 0.40 | 0.01        | 0.19 | 0.19 | 0.02       | 0.08 | 0.08 | 0.02       | 0.01 | 0.01 |
| Crit Moves:                                 | ****        | **** | **** | ****        | **** | **** | ****       | **** | **** | ****       | **** | **** |
| Green Time:                                 | 27.9        | 85.8 | 85.8 | 7.0         | 64.9 | 64.9 | 18.2       | 18.2 | 18.2 | 18.2       | 18.2 | 18.2 |
| Volume/Cap:                                 | 0.36        | 0.55 | 0.55 | 0.17        | 0.36 | 0.36 | 0.12       | 0.55 | 0.55 | 0.13       | 0.05 | 0.05 |
| Delay/Veh:                                  | 39.1        | 8.2  | 8.2  | 54.5        | 15.8 | 15.8 | 44.2       | 49.6 | 49.6 | 44.3       | 43.6 | 43.6 |
| User DelAdj:                                | 1.00        | 1.00 | 1.00 | 1.00        | 1.00 | 1.00 | 1.00       | 1.00 | 1.00 | 1.00       | 1.00 | 1.00 |
| AdjDel/Veh:                                 | 39.1        | 8.2  | 8.2  | 54.5        | 15.8 | 15.8 | 44.2       | 49.6 | 49.6 | 44.3       | 43.6 | 43.6 |
| LOS by Move:                                | D           | A    | A    | D           | B    | B    | D          | D    | D    | D          | D    | D    |
| HCM2k95thQ:                                 | 10          | 23   | 23   | 1           | 14   | 14   | 2          | 10   | 10   | 2          | 1    | 1    |

Note: Queue reported is the number of cars per lane.

BART

Level Of Service Computation Report  
 2000 HCM Operations (Future Volume Alternative)  
 PM - Cumulative With Project

Intersection #175: Reed/De La Cruz [Study Int 32]

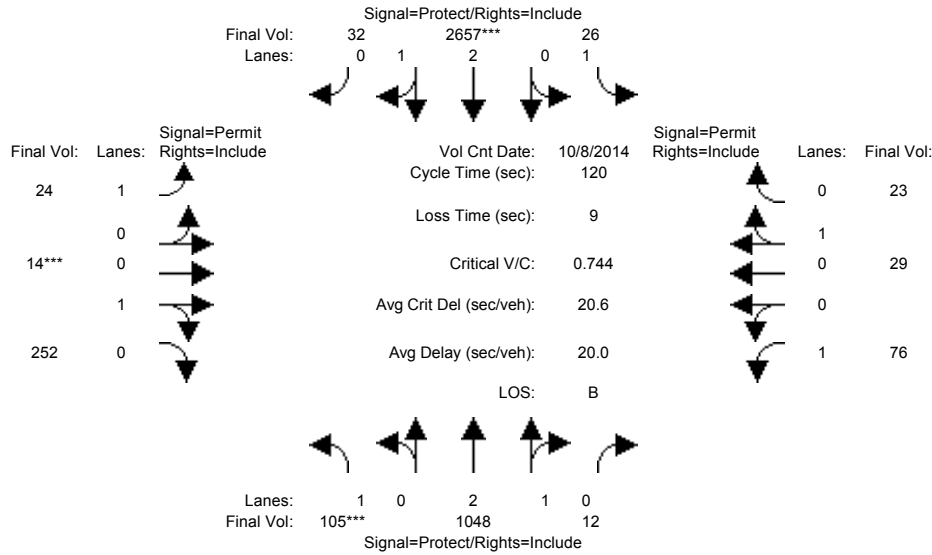

| Approach:                                   | North Bound |      |      | South Bound |      |      | East Bound |      |      | West Bound |      |      |
|---|-------------|------|------|-------------|------|------|------------|------|------|------------|------|------|
| Movement:                                   | L           | T    | R    | L           | T    | R    | L          | T    | R    | L          | T    | R    |
| Min. Green:                                 | 7           | 10   | 10   | 7           | 10   | 10   | 10         | 10   | 10   | 10         | 10   | 10   |
| Y+R:  | 4.0         | 4.0  | 4.0  | 4.0         | 4.0  | 4.0  | 4.0        | 4.0  | 4.0  | 4.0        | 4.0  | 4.0  |
| Volume Module: >> Count Date: 8 Oct 2014 << |             |      |      |             |      |      |            |      |      |            |      |      |
| Base Vol:                                   | 105         | 1048 | 12   | 26          | 2657 | 32   | 24         | 14   | 252  | 76         | 29   | 23   |
| Growth Adj:                                 | 1.00        | 1.00 | 1.00 | 1.00        | 1.00 | 1.00 | 1.00       | 1.00 | 1.00 | 1.00       | 1.00 | 1.00 |
| Initial Bse:                                | 105         | 1048 | 12   | 26          | 2657 | 32   | 24         | 14   | 252  | 76         | 29   | 23   |
| Added Vol:                                  | 0           | 0    | 0    | 0           | 0    | 0    | 0          | 0    | 0    | 0          | 0    | 0    |
| PasserByVol:                                | 0           | 0    | 0    | 0           | 0    | 0    | 0          | 0    | 0    | 0          | 0    | 0    |
| Initial Fut:                                | 105         | 1048 | 12   | 26          | 2657 | 32   | 24         | 14   | 252  | 76         | 29   | 23   |
| User Adj:                                   | 1.00        | 1.00 | 1.00 | 1.00        | 1.00 | 1.00 | 1.00       | 1.00 | 1.00 | 1.00       | 1.00 | 1.00 |
| PHF Adj:                                    | 1.00        | 1.00 | 1.00 | 1.00        | 1.00 | 1.00 | 1.00       | 1.00 | 1.00 | 1.00       | 1.00 | 1.00 |
| PHF Volume:                                 | 105         | 1048 | 12   | 26          | 2657 | 32   | 24         | 14   | 252  | 76         | 29   | 23   |
| Reduct Vol:                                 | 0           | 0    | 0    | 0           | 0    | 0    | 0          | 0    | 0    | 0          | 0    | 0    |
| Reduced Vol:                                | 105         | 1048 | 12   | 26          | 2657 | 32   | 24         | 14   | 252  | 76         | 29   | 23   |
| PCE Adj:                                    | 1.00        | 1.00 | 1.00 | 1.00        | 1.00 | 1.00 | 1.00       | 1.00 | 1.00 | 1.00       | 1.00 | 1.00 |
| MLF Adj:                                    | 1.00        | 1.00 | 1.00 | 1.00        | 1.00 | 1.00 | 1.00       | 1.00 | 1.00 | 1.00       | 1.00 | 1.00 |
| Final Volume:                               | 105         | 1048 | 12   | 26          | 2657 | 32   | 24         | 14   | 252  | 76         | 29   | 23   |
| Saturation Flow Module:                     |             |      |      |             |      |      |            |      |      |            |      |      |
| Sat/Lane:                                   | 1900        | 1900 | 1900 | 1900        | 1900 | 1900 | 1900       | 1900 | 1900 | 1900       | 1900 | 1900 |
| Adjustment:                                 | 0.92        | 0.98 | 0.95 | 0.92        | 0.98 | 0.95 | 0.92       | 0.95 | 0.95 | 0.92       | 0.95 | 0.95 |
| Lanes:                                      | 1.00        | 2.96 | 0.04 | 1.00        | 2.96 | 0.04 | 1.00       | 0.05 | 0.95 | 1.00       | 0.56 | 0.44 |
| Final Sat.:                                 | 1750        | 5537 | 63   | 1750        | 5533 | 67   | 1750       | 95   | 1705 | 1750       | 1004 | 796  |
| Capacity Analysis Module:                   |             |      |      |             |      |      |            |      |      |            |      |      |
| Vol/Sat:                                    | 0.06        | 0.19 | 0.19 | 0.01        | 0.48 | 0.48 | 0.01       | 0.15 | 0.15 | 0.04       | 0.03 | 0.03 |
| Crit Moves:                                 | ****        |      |      | ****        |      |      | ****       |      |      |            |      |      |
| Green Time:                                 | 9.7         | 66.6 | 66.6 | 20.5        | 77.5 | 77.5 | 23.8       | 23.8 | 23.8 | 23.8       | 23.8 | 23.8 |
| Volume/Cap:                                 | 0.74        | 0.34 | 0.34 | 0.09        | 0.74 | 0.74 | 0.07       | 0.74 | 0.74 | 0.22       | 0.15 | 0.15 |
| Delay/Veh:                                  | 73.0        | 14.7 | 14.7 | 42.0        | 15.4 | 15.4 | 39.1       | 53.4 | 53.4 | 40.6       | 39.9 | 39.9 |
| User DelAdj:                                | 1.00        | 1.00 | 1.00 | 1.00        | 1.00 | 1.00 | 1.00       | 1.00 | 1.00 | 1.00       | 1.00 | 1.00 |
| AdjDel/Veh:                                 | 73.0        | 14.7 | 14.7 | 42.0        | 15.4 | 15.4 | 39.1       | 53.4 | 53.4 | 40.6       | 39.9 | 39.9 |
| LOS by Move:                                | E           | B    | B    | D           | B    | B    | D          | D    | D    | D          | D    | D    |
| HCM2k95thQ:                                 | 11          | 14   | 14   | 2           | 39   | 39   | 2          | 18   | 18   | 5          | 3    | 3    |

Note: Queue reported is the number of cars per lane.

BART

Level Of Service Computation Report
2000 HCM Unsignalized (Future Volume Alternative)
AM - Cumulative No Project

Intersection #1008: Lafayette/Harrison (unsignalized) [Study Int 48]

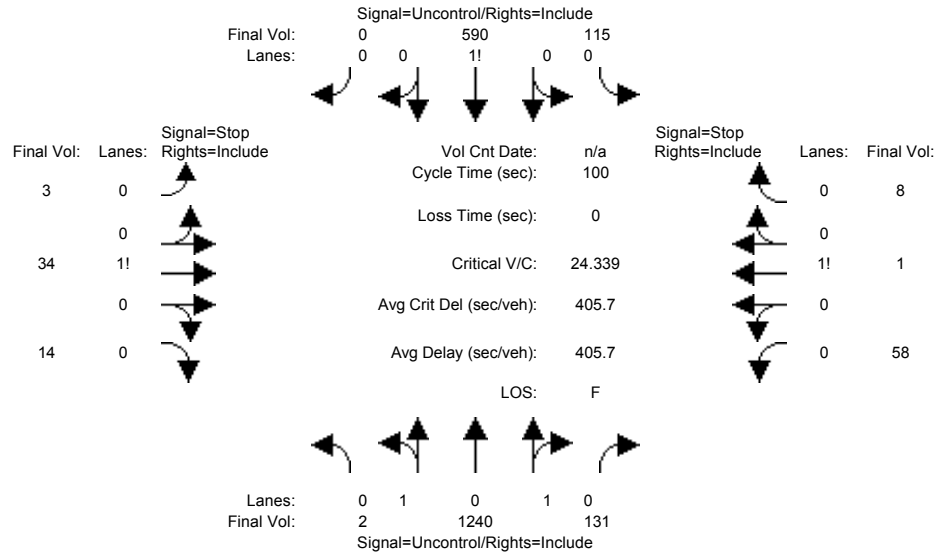

Table containing traffic engineering data: Approach (North, South, East, West Bound), Movement (L, T, R), Volume Module (Base Vol, Growth Adj, etc.), Critical Gap Module, Capacity Module, Level of Service Module, and various performance metrics like delay, queue, and saturation.

ConflictVol: 590 xxxxx xxxxx 1371 xxxxx xxxxx 1445 2195 590 2154 2130 686  
\*\*\* Computation 5: Capacity for Subject Movement During Unblocked Period  
InitPotCap: 995 xxxxx xxxxx 507 xxxxx xxxxx 111 46 511 35 50 451  
UpstreamAdj: 1.00 x.xxx x.xxx 1.00 x.xxx x.xxx 1.00 1.000 1.000 1.00 1.000 1.000  
Potent Cap.: 995 xxxxx xxxxx 507 xxxxx xxxxx 111 46 511 35 50 451

BART

Level Of Service Computation Report
2000 HCM Unsignalized (Future Volume Alternative)
PM - Cumulative No Project

Intersection #1008: Lafayette/Harrison (unsignalized) [Study Int 48]

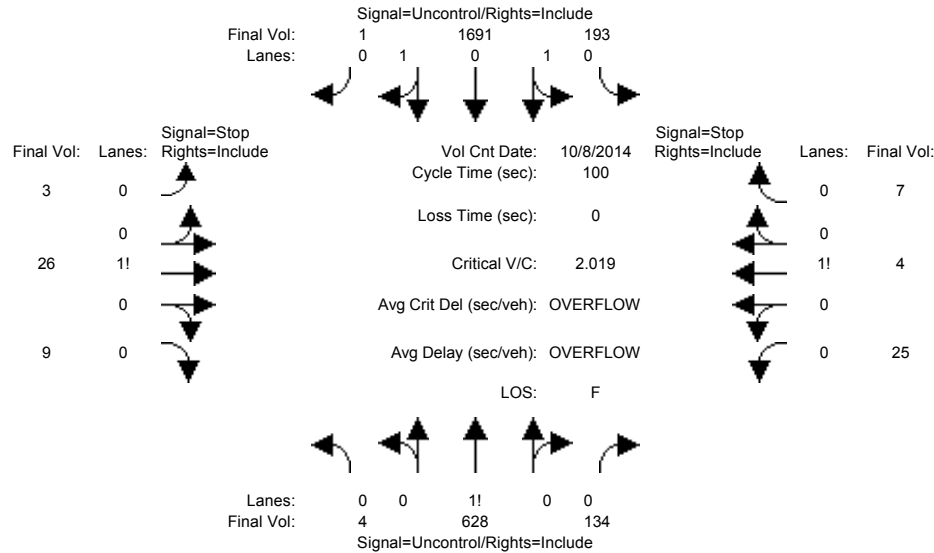

Table with columns for Approach (North, South, East, West Bound) and Movement (L, T, R). Rows include Volume Module, Critical Gap Module, Capacity Module, Level of Service Module, and various performance metrics like HevVeh, Grade, Peds/Hour, etc.

ConflictVol:1692 xxxxx xxxxx 762 xxxxx xxxxx 2786 2848 846 1948 2781 695  
\*\*\* Computation 5: Capacity for Subject Movement During Unblocked Period  
InitPotCap: 382 xxxxx xxxxx 859 xxxxx xxxxx 12 17 365 49 19 446  
UpstreamAdj:1.00 x.xxx x.xxx 1.00 x.xxx x.xxx 1.00 1.000 1.000 1.00 1.000 1.000  
Potent Cap.: 382 xxxxx xxxxx 859 xxxxx xxxxx 12 17 365 49 19 446

BART

Level Of Service Computation Report  
2000 HCM Unsignalized (Future Volume Alternative)  
AM - Cumulative With Project

Intersection #1008: Lafayette/Harrison (unsignalized) [Study Int 48]

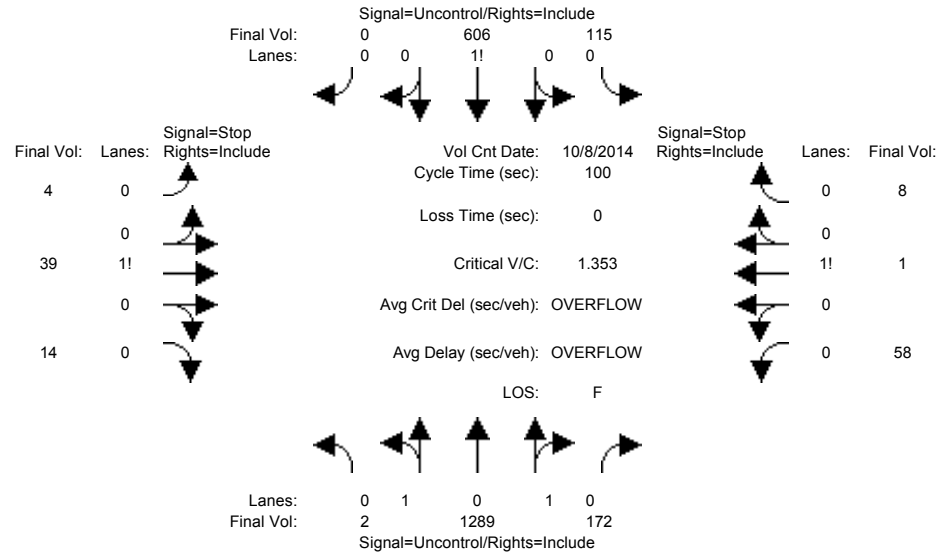

| Approach:                                   | North Bound    | South Bound    | East Bound     | West Bound     |
|---|----------------|----------------|----------------|----------------|
| Movement:                                   | L - T - R      | L - T - R      | L - T - R      | L - T - R      |
| Volume Module: >> Count Date: 8 Oct 2014 << |                |                |                |                |
| Base Vol:                                   | 2 1289 172     | 115 606 0      | 4 39 14        | 58 1 8         |
| Growth Adj:                                 | 1.00 1.00 1.00 | 1.00 1.00 1.00 | 1.00 1.00 1.00 | 1.00 1.00 1.00 |
| Initial Bse:                                | 2 1289 172     | 115 606 0      | 4 39 14        | 58 1 8         |
| Added Vol:                                  | 0 0 0          | 0 0 0          | 0 0 0          | 0 0 0          |
| PasserByVol:                                | 0 0 0          | 0 0 0          | 0 0 0          | 0 0 0          |
| Initial Fut:                                | 2 1289 172     | 115 606 0      | 4 39 14        | 58 1 8         |
| User Adj:                                   | 1.00 1.00 1.00 | 1.00 1.00 1.00 | 1.00 1.00 1.00 | 1.00 1.00 1.00 |
| PHF Adj:                                    | 1.00 1.00 1.00 | 1.00 1.00 1.00 | 1.00 1.00 1.00 | 1.00 1.00 1.00 |
| PHF Volume:                                 | 2 1289 172     | 115 606 0      | 4 39 14        | 58 1 8         |
| Reduct Vol:                                 | 0 0 0          | 0 0 0          | 0 0 0          | 0 0 0          |
| FinalVolume:                                | 2 1289 172     | 115 606 0      | 4 39 14        | 58 1 8         |

| Critical Gap Module: | North Bound      | South Bound      | East Bound  | West Bound  |
|----------------------|------------------|------------------|-------------|-------------|
| Critical Gap:        | 4.1 xxxxx xxxxxx | 4.1 xxxxx xxxxxx | 7.1 6.5 6.2 | 7.1 6.5 6.2 |
| FollowUpTim:         | 2.2 xxxxx xxxxxx | 2.2 xxxxx xxxxxx | 3.5 4.0 3.3 | 3.5 4.0 3.3 |

| Capacity Module: | North Bound      | South Bound       | East Bound     | West Bound     |
|------------------|------------------|-------------------|----------------|----------------|
| Cnflct Vol:      | 606 xxxxx xxxxxx | 1461 xxxxx xxxxxx | 1485 2301 606  | 2242 2215 731  |
| Potent Cap.:     | 982 xxxxx xxxxxx | 469 xxxxx xxxxxx  | 104 39 501     | 30 44 425      |
| Move Cap.:       | 982 xxxxx xxxxxx | 469 xxxxx xxxxxx  | 79 29 501      | 0 33 425       |
| Volume/Cap:      | 0.00 xxxxx xxxxx | 0.25 xxxxx xxxxx  | 0.05 1.35 0.03 | xxxx 0.03 0.02 |

| Level Of Service Module: | North Bound       | South Bound       | East Bound        | West Bound        |
|--------------------------|-------------------|-------------------|-------------------|-------------------|
| 2Way95thQ:               | 0.0 xxxxx xxxxxx  | 1.0 xxxxx xxxxxx  | xxxx xxxxx xxxxxx | xxxx xxxxx xxxxxx |
| Control Del:             | 8.7 xxxxx xxxxxx  | 15.2 xxxxx xxxxxx | xxxx xxxxx xxxxxx | xxxx xxxxx xxxxxx |
| LOS by Move:             | A * * * *         | C * * * *         | * * * * *         | * * * * *         |
| Movement:                | LT - LTR - RT     | LT - LTR - RT     | LT - LTR - RT     | LT - LTR - RT     |
| Shared Cap.:             | xxxx xxxxx xxxxxx | xxxx xxxxx xxxxxx | 40 xxxxx xxxxx    | 0 xxxxxx          |
| SharedQueue:             | 0.0 xxxxx xxxxxx  | 1.0 xxxxx xxxxxx  | 5.8 xxxxx xxxxx   | xxxx xxxxx        |
| Shrd ConDel:             | 8.7 xxxxx xxxxxx  | 15.2 xxxxx xxxxxx | 453 xxxxxx        | xxxx xxxxx xxxxxx |
| Shared LOS:              | A * * * *         | C * * * *         | F * * * * *       | * * * * *         |
| ApproachDel:             | xxxxxx            | xxxxxx            | 452.7             | xxxxxx            |
| ApproachLOS:             | *                 | *                 | F                 | F                 |

Note: Queue reported is the number of cars per lane.

| HevVeh:                | North Bound   | South Bound   | East Bound    | West Bound    |
|------------------------|---------------|---------------|---------------|---------------|
| Grade:                 | 0%            | 0%            | 0%            | 0%            |
| Peds/Hour:             | 0             | 0             | 0             | 0             |
| Pedestrian Walk Speed: | 4.00 feet/sec | 4.00 feet/sec | 4.00 feet/sec | 4.00 feet/sec |
| LaneWidth:             | 12 feet       | 12 feet       | 12 feet       | 12 feet       |
| Time Period:           | 0.25 hour     | 0.25 hour     | 0.25 hour     | 0.25 hour     |
| Upstream Signals:      |               |               |               |               |
| Link Index:            | #718          | #974          |               |               |
| Dist(miles):           | 0.000         | 0.000         |               |               |
| Speed (mph):           | 0.00          | 0.00          |               |               |
| SignalIndex:           | #107          | #5444         |               |               |
| Cycle Time:            | 0 secs        | 0 secs        |               |               |
| InitVolume:            | 0 0           | 0 0           |               |               |
| Saturation:            | 0 0           | 0 0           |               |               |
| ArrivalType:           | 0 0           | 0 0           |               |               |
| G/C:                   | 0.00 0.00     | 0.00 0.00     |               |               |

\*\*\* Computation 1: Time for Queue to Clear at Each Upstream Intersection

| P:   | North Bound | South Bound |
|------|-------------|-------------|
| P:   | 0.000 0.000 | 0.000 0.000 |
| gg1: | 0.00 0.00   | 0.00 0.00   |
| gg2: | 0.00 0.00   | 0.00 0.00   |
| gg:  | 0.00 0.00   | 0.00 0.00   |

\*\*\* Computation 2: Time Intersection Blocked Because of Upstream Platoons

| alpha:     | North Bound | South Bound |
|------------|-------------|-------------|
| alpha:     | 0.000       | 0.000       |
| beta:      | 0.000       | 0.000       |
| ta (secs): | 0.000       | 0.000       |
| F:         | 0.000       | 0.000       |
| f:         | 0.000 0.000 | 0.000 0.000 |
| vcmax:     | 0 0         | 0 0         |
| vcg:       | 0 0         | 0 0         |
| vcmin:     | 0 0         | 0 0         |
| tp:        | 0.0 0.0     | 0.0 0.0     |
| P:         | 0.000       | 0.000       |

\*\*\* Computation 3: Platoon Event Periods

| pdom/psubo: | North Bound               | South Bound               |
|-------------|---------------------------|---------------------------|
| pdom/psubo: | 0.000/0.000/Unconstrained | 0.000/0.000/Unconstrained |

\*\*\* Computation 4: Conflicting Flows During Each Unblocked Period

| InitCnflVol: | North Bound      | South Bound       | East Bound       | West Bound       |
|--------------|------------------|-------------------|------------------|------------------|
| InitCnflVol: | 606 xxxxx xxxxxx | 1461 xxxxx xxxxxx | 1485 2301 606    | 2242 2215 731    |
| AdjCnflVol:  | 606 xxxxx xxxxxx | 1461 xxxxx xxxxxx | 1485 2301 606    | 2242 2215 731    |
| UpstreamAdj: | 1.00 xxxxx xxxxx | 1.00 xxxxx xxxxx  | 1.00 1.000 1.000 | 1.00 1.000 1.000 |



ConflictVol: 606 xxxxx xxxxx 1461 xxxxx xxxxx 1485 2301 606 2242 2215 731  
\*\*\* Computation 5: Capacity for Subject Movement During Unblocked Period  
InitPotCap: 982 xxxxx xxxxx 469 xxxxx xxxxx 104 39 501 30 44 425  
UpstreamAdj: 1.00 x.xxx x.xxx 1.00 x.xxx x.xxx 1.00 1.000 1.000 1.00 1.000 1.000  
Potent Cap.: 982 xxxxx xxxxx 469 xxxxx xxxxx 104 39 501 30 44 425

BART

Level Of Service Computation Report
2000 HCM Unsignalized (Future Volume Alternative)
PM - Cumulative With Project

Intersection #1008: Lafayette/Harrison (unsignalized) [Study Int 48]

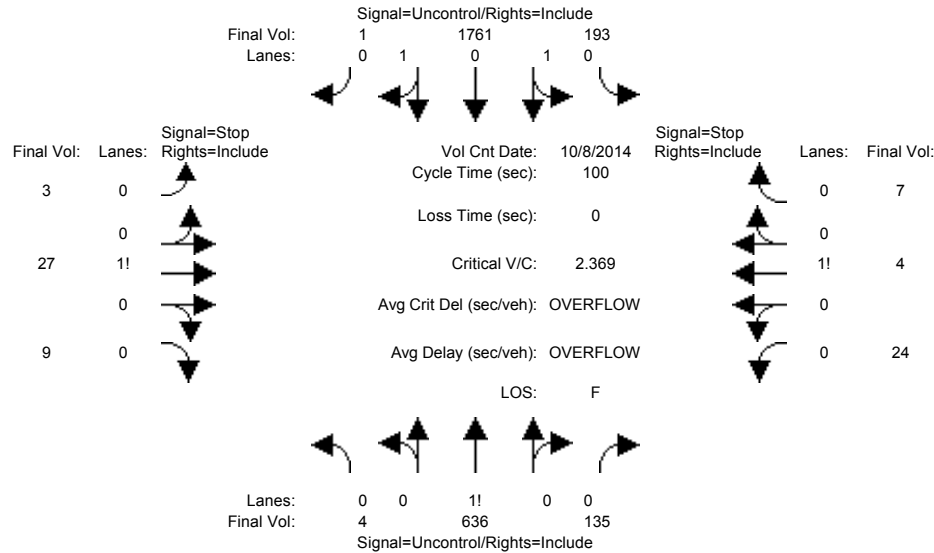

Table with columns: Approach, Movement, Volume Module, Critical Gap Module, Capacity Module, Level Of Service Module, and various performance metrics like ApproachDel, ApproachLOS, and computation results.

ConflictVol:1762 xxxxx xxxxx 771 xxxxx xxxxx 2865 2927 881 1992 2860 704  
\*\*\* Computation 5: Capacity for Subject Movement During Unblocked Period  
InitPotCap: 359 xxxxx xxxxx 853 xxxxx xxxxx 11 15 349 46 17 441  
UpstreamAdj:1.00 x.xxx x.xxx 1.00 x.xxx x.xxx 1.00 1.000 1.000 1.00 1.000 1.000  
Potent Cap.: 359 xxxxx xxxxx 853 xxxxx xxxxx 11 15 349 46 17 441

BART

Level Of Service Computation Report  
 2000 HCM Operations (Future Volume Alternative)  
 AM - Cumulative No Project

Intersection #1012: El Camino Real/Railroad Ave [Study Int 53]

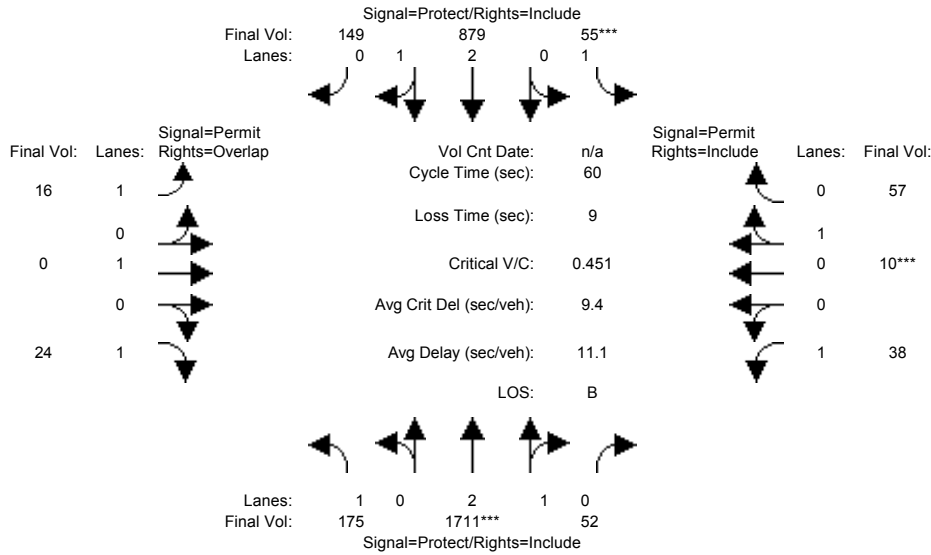

| Approach:                 | North Bound |      |      | South Bound |      |      | East Bound |      |      | West Bound |      |      |
|---------------------------|-------------|------|------|-------------|------|------|------------|------|------|------------|------|------|
| Movement:                 | L           | T    | R    | L           | T    | R    | L          | T    | R    | L          | T    | R    |
| Min. Green:               | 7           | 10   | 10   | 7           | 10   | 10   | 10         | 10   | 10   | 10         | 10   | 10   |
| Y+R:                      | 4.0         | 4.0  | 4.0  | 4.0         | 4.0  | 4.0  | 4.0        | 4.0  | 4.0  | 4.0        | 4.0  | 4.0  |
| Volume Module:            |             |      |      |             |      |      |            |      |      |            |      |      |
| Base Vol:                 | 175         | 1711 | 52   | 55          | 879  | 149  | 16         | 0    | 24   | 38         | 10   | 57   |
| Growth Adj:               | 1.00        | 1.00 | 1.00 | 1.00        | 1.00 | 1.00 | 1.00       | 1.00 | 1.00 | 1.00       | 1.00 | 1.00 |
| Initial Bse:              | 175         | 1711 | 52   | 55          | 879  | 149  | 16         | 0    | 24   | 38         | 10   | 57   |
| Added Vol:                | 0           | 0    | 0    | 0           | 0    | 0    | 0          | 0    | 0    | 0          | 0    | 0    |
| PasserByVol:              | 0           | 0    | 0    | 0           | 0    | 0    | 0          | 0    | 0    | 0          | 0    | 0    |
| Initial Fut:              | 175         | 1711 | 52   | 55          | 879  | 149  | 16         | 0    | 24   | 38         | 10   | 57   |
| User Adj:                 | 1.00        | 1.00 | 1.00 | 1.00        | 1.00 | 1.00 | 1.00       | 1.00 | 1.00 | 1.00       | 1.00 | 1.00 |
| PHF Adj:                  | 1.00        | 1.00 | 1.00 | 1.00        | 1.00 | 1.00 | 1.00       | 1.00 | 1.00 | 1.00       | 1.00 | 1.00 |
| PHF Volume:               | 175         | 1711 | 52   | 55          | 879  | 149  | 16         | 0    | 24   | 38         | 10   | 57   |
| Reduct Vol:               | 0           | 0    | 0    | 0           | 0    | 0    | 0          | 0    | 0    | 0          | 0    | 0    |
| Reduced Vol:              | 175         | 1711 | 52   | 55          | 879  | 149  | 16         | 0    | 24   | 38         | 10   | 57   |
| PCE Adj:                  | 1.00        | 1.00 | 1.00 | 1.00        | 1.00 | 1.00 | 1.00       | 1.00 | 1.00 | 1.00       | 1.00 | 1.00 |
| MLF Adj:                  | 1.00        | 1.00 | 1.00 | 1.00        | 1.00 | 1.00 | 1.00       | 1.00 | 1.00 | 1.00       | 1.00 | 1.00 |
| Final Volume:             | 175         | 1711 | 52   | 55          | 879  | 149  | 16         | 0    | 24   | 38         | 10   | 57   |
| Saturation Flow Module:   |             |      |      |             |      |      |            |      |      |            |      |      |
| Sat/Lane:                 | 1900        | 1900 | 1900 | 1900        | 1900 | 1900 | 1900       | 1900 | 1900 | 1900       | 1900 | 1900 |
| Adjustment:               | 0.92        | 0.98 | 0.95 | 0.92        | 0.99 | 0.95 | 0.92       | 1.00 | 0.92 | 0.92       | 0.95 | 0.95 |
| Lanes:                    | 1.00        | 2.91 | 0.09 | 1.00        | 2.55 | 0.45 | 1.00       | 1.00 | 1.00 | 1.00       | 0.15 | 0.85 |
| Final Sat.:               | 1750        | 5435 | 165  | 1750        | 4787 | 811  | 1750       | 1900 | 1750 | 1750       | 269  | 1531 |
| Capacity Analysis Module: |             |      |      |             |      |      |            |      |      |            |      |      |
| Vol/Sat:                  | 0.10        | 0.31 | 0.31 | 0.03        | 0.18 | 0.18 | 0.01       | 0.00 | 0.01 | 0.02       | 0.04 | 0.04 |
| Crit Moves:               | ****        | **** | **** | ****        | **** | **** | ****       | **** | **** | ****       | **** | **** |
| Green Time:               | 15.9        | 34.0 | 34.0 | 7.0         | 25.1 | 25.1 | 10.0       | 0.0  | 25.9 | 10.0       | 10.0 | 10.0 |
| Volume/Cap:               | 0.38        | 0.56 | 0.56 | 0.27        | 0.44 | 0.44 | 0.05       | 0.00 | 0.03 | 0.13       | 0.22 | 0.22 |
| Delay/Veh:                | 18.5        | 8.4  | 8.4  | 24.9        | 12.6 | 12.6 | 21.1       | 0.0  | 9.8  | 21.5       | 22.0 | 22.0 |
| User DelAdj:              | 1.00        | 1.00 | 1.00 | 1.00        | 1.00 | 1.00 | 1.00       | 1.00 | 1.00 | 1.00       | 1.00 | 1.00 |
| AdjDel/Veh:               | 18.5        | 8.4  | 8.4  | 24.9        | 12.6 | 12.6 | 21.1       | 0.0  | 9.8  | 21.5       | 22.0 | 22.0 |
| LOS by Move:              | B           | A    | A    | C           | B    | B    | C          | A    | A    | C          | C    | C    |
| HCM2k95thQ:               | 6           | 14   | 14   | 2           | 9    | 9    | 1          | 0    | 1    | 2          | 3    | 3    |

Note: Queue reported is the number of cars per lane.

BART

Level Of Service Computation Report  
2000 HCM Operations (Future Volume Alternative)  
PM - Cumulative No Project

Intersection #1012: El Camino Real/Railroad Ave [Study Int 53]

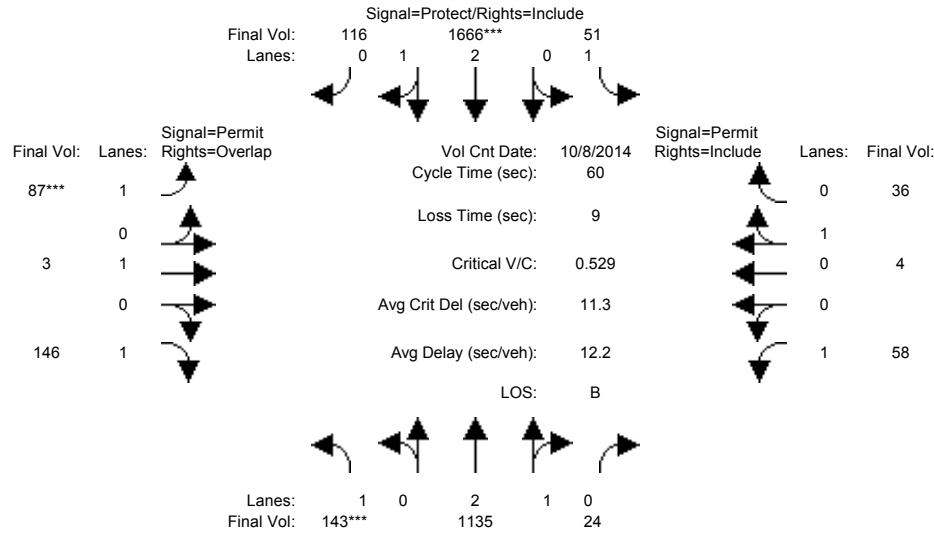

| Approach:                     | North Bound   |      |      | South Bound |      |      | East Bound |      |      | West Bound |      |      |
|-------------------------------|---------------|------|------|-------------|------|------|------------|------|------|------------|------|------|
| Movement:                     | L             | T    | R    | L           | T    | R    | L          | T    | R    | L          | T    | R    |
| Min. Green:                   | 7             | 10   | 10   | 7           | 10   | 10   | 10         | 10   | 10   | 10         | 10   | 10   |
| Y+R:                          | 4.0           | 4.0  | 4.0  | 4.0         | 4.0  | 4.0  | 4.0        | 4.0  | 4.0  | 4.0        | 4.0  | 4.0  |
| -----                         |               |      |      |             |      |      |            |      |      |            |      |      |
| Volume Module: >> Count Date: | 8 Oct 2014 << |      |      |             |      |      |            |      |      |            |      |      |
| Base Vol:                     | 143           | 1135 | 24   | 51          | 1666 | 116  | 87         | 3    | 146  | 58         | 4    | 36   |
| Growth Adj:                   | 1.00          | 1.00 | 1.00 | 1.00        | 1.00 | 1.00 | 1.00       | 1.00 | 1.00 | 1.00       | 1.00 | 1.00 |
| Initial Bse:                  | 143           | 1135 | 24   | 51          | 1666 | 116  | 87         | 3    | 146  | 58         | 4    | 36   |
| Added Vol:                    | 0             | 0    | 0    | 0           | 0    | 0    | 0          | 0    | 0    | 0          | 0    | 0    |
| PasserByVol:                  | 0             | 0    | 0    | 0           | 0    | 0    | 0          | 0    | 0    | 0          | 0    | 0    |
| Initial Fut:                  | 143           | 1135 | 24   | 51          | 1666 | 116  | 87         | 3    | 146  | 58         | 4    | 36   |
| User Adj:                     | 1.00          | 1.00 | 1.00 | 1.00        | 1.00 | 1.00 | 1.00       | 1.00 | 1.00 | 1.00       | 1.00 | 1.00 |
| PHF Adj:                      | 1.00          | 1.00 | 1.00 | 1.00        | 1.00 | 1.00 | 1.00       | 1.00 | 1.00 | 1.00       | 1.00 | 1.00 |
| PHF Volume:                   | 143           | 1135 | 24   | 51          | 1666 | 116  | 87         | 3    | 146  | 58         | 4    | 36   |
| Reduct Vol:                   | 0             | 0    | 0    | 0           | 0    | 0    | 0          | 0    | 0    | 0          | 0    | 0    |
| Reduced Vol:                  | 143           | 1135 | 24   | 51          | 1666 | 116  | 87         | 3    | 146  | 58         | 4    | 36   |
| PCE Adj:                      | 1.00          | 1.00 | 1.00 | 1.00        | 1.00 | 1.00 | 1.00       | 1.00 | 1.00 | 1.00       | 1.00 | 1.00 |
| MLF Adj:                      | 1.00          | 1.00 | 1.00 | 1.00        | 1.00 | 1.00 | 1.00       | 1.00 | 1.00 | 1.00       | 1.00 | 1.00 |
| Final Volume:                 | 143           | 1135 | 24   | 51          | 1666 | 116  | 87         | 3    | 146  | 58         | 4    | 36   |
| -----                         |               |      |      |             |      |      |            |      |      |            |      |      |
| Saturation Flow Module:       |               |      |      |             |      |      |            |      |      |            |      |      |
| Sat/Lane:                     | 1900          | 1900 | 1900 | 1900        | 1900 | 1900 | 1900       | 1900 | 1900 | 1900       | 1900 | 1900 |
| Adjustment:                   | 0.92          | 0.98 | 0.95 | 0.92        | 0.98 | 0.95 | 0.92       | 1.00 | 0.92 | 0.92       | 0.95 | 0.95 |
| Lanes:                        | 1.00          | 2.94 | 0.06 | 1.00        | 2.80 | 0.20 | 1.00       | 1.00 | 1.00 | 1.00       | 0.10 | 0.90 |
| Final Sat.:                   | 1750          | 5484 | 116  | 1750        | 5235 | 365  | 1750       | 1900 | 1750 | 1750       | 180  | 1620 |
| -----                         |               |      |      |             |      |      |            |      |      |            |      |      |
| Capacity Analysis Module:     |               |      |      |             |      |      |            |      |      |            |      |      |
| Vol/Sat:                      | 0.08          | 0.21 | 0.21 | 0.03        | 0.32 | 0.32 | 0.05       | 0.00 | 0.08 | 0.03       | 0.02 | 0.02 |
| Crit Moves:                   | ****          |      |      |             |      |      |            |      |      |            |      |      |
| Green Time:                   | 8.4           | 26.2 | 26.2 | 14.8        | 32.6 | 32.6 | 10.0       | 10.0 | 18.4 | 10.0       | 10.0 | 10.0 |
| Volume/Cap:                   | 0.59          | 0.47 | 0.47 | 0.12        | 0.59 | 0.59 | 0.30       | 0.01 | 0.27 | 0.20       | 0.13 | 0.13 |
| Delay/Veh:                    | 27.8          | 12.1 | 12.1 | 17.7        | 9.5  | 9.5  | 22.5       | 20.9 | 16.0 | 21.9       | 21.5 | 21.5 |
| User DelAdj:                  | 1.00          | 1.00 | 1.00 | 1.00        | 1.00 | 1.00 | 1.00       | 1.00 | 1.00 | 1.00       | 1.00 | 1.00 |
| AdjDel/Veh:                   | 27.8          | 12.1 | 12.1 | 17.7        | 9.5  | 9.5  | 22.5       | 20.9 | 16.0 | 21.9       | 21.5 | 21.5 |
| LOS by Move:                  | C             | B    | B    | B           | A    | A    | C          | C    | B    | C          | C    | C    |
| HCM2k95thQ:                   | 7             | 11   | 11   | 2           | 14   | 14   | 4          | 0    | 5    | 2          | 2    | 2    |

Note: Queue reported is the number of cars per lane.

BART

Level Of Service Computation Report  
 2000 HCM Operations (Future Volume Alternative)  
 AM - Cumulative With Project

Intersection #1012: El Camino Real/Railroad Ave [Study Int 53]

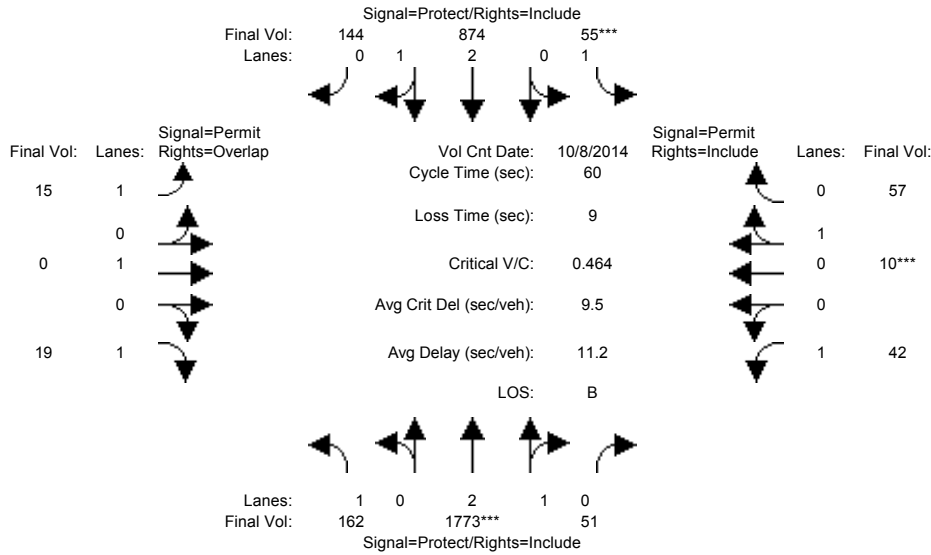

| Approach:                                   | North Bound |      |      | South Bound |      |      | East Bound |      |      | West Bound |      |      |
|---|-------------|------|------|-------------|------|------|------------|------|------|------------|------|------|
| Movement:                                   | L           | T    | R    | L           | T    | R    | L          | T    | R    | L          | T    | R    |
| Min. Green:                                 | 7           | 10   | 10   | 7           | 10   | 10   | 10         | 10   | 10   | 10         | 10   | 10   |
| Y+R:  | 4.0         | 4.0  | 4.0  | 4.0         | 4.0  | 4.0  | 4.0        | 4.0  | 4.0  | 4.0        | 4.0  | 4.0  |
| Volume Module: >> Count Date: 8 Oct 2014 << |             |      |      |             |      |      |            |      |      |            |      |      |
| Base Vol:                                   | 162         | 1773 | 51   | 55          | 874  | 144  | 15         | 0    | 19   | 42         | 10   | 57   |
| Growth Adj:                                 | 1.00        | 1.00 | 1.00 | 1.00        | 1.00 | 1.00 | 1.00       | 1.00 | 1.00 | 1.00       | 1.00 | 1.00 |
| Initial Bse:                                | 162         | 1773 | 51   | 55          | 874  | 144  | 15         | 0    | 19   | 42         | 10   | 57   |
| Added Vol:                                  | 0           | 0    | 0    | 0           | 0    | 0    | 0          | 0    | 0    | 0          | 0    | 0    |
| PasserByVol:                                | 0           | 0    | 0    | 0           | 0    | 0    | 0          | 0    | 0    | 0          | 0    | 0    |
| Initial Fut:                                | 162         | 1773 | 51   | 55          | 874  | 144  | 15         | 0    | 19   | 42         | 10   | 57   |
| User Adj:                                   | 1.00        | 1.00 | 1.00 | 1.00        | 1.00 | 1.00 | 1.00       | 1.00 | 1.00 | 1.00       | 1.00 | 1.00 |
| PHF Adj:                                    | 1.00        | 1.00 | 1.00 | 1.00        | 1.00 | 1.00 | 1.00       | 1.00 | 1.00 | 1.00       | 1.00 | 1.00 |
| PHF Volume:                                 | 162         | 1773 | 51   | 55          | 874  | 144  | 15         | 0    | 19   | 42         | 10   | 57   |
| Reduct Vol:                                 | 0           | 0    | 0    | 0           | 0    | 0    | 0          | 0    | 0    | 0          | 0    | 0    |
| Reduced Vol:                                | 162         | 1773 | 51   | 55          | 874  | 144  | 15         | 0    | 19   | 42         | 10   | 57   |
| PCE Adj:                                    | 1.00        | 1.00 | 1.00 | 1.00        | 1.00 | 1.00 | 1.00       | 1.00 | 1.00 | 1.00       | 1.00 | 1.00 |
| MLF Adj:                                    | 1.00        | 1.00 | 1.00 | 1.00        | 1.00 | 1.00 | 1.00       | 1.00 | 1.00 | 1.00       | 1.00 | 1.00 |
| Final Volume:                               | 162         | 1773 | 51   | 55          | 874  | 144  | 15         | 0    | 19   | 42         | 10   | 57   |
| Saturation Flow Module:                     |             |      |      |             |      |      |            |      |      |            |      |      |
| Sat/Lane:                                   | 1900        | 1900 | 1900 | 1900        | 1900 | 1900 | 1900       | 1900 | 1900 | 1900       | 1900 | 1900 |
| Adjustment:                                 | 0.92        | 0.98 | 0.95 | 0.92        | 0.99 | 0.95 | 0.92       | 1.00 | 0.92 | 0.92       | 0.95 | 0.95 |
| Lanes:                                      | 1.00        | 2.91 | 0.09 | 1.00        | 2.56 | 0.44 | 1.00       | 1.00 | 1.00 | 1.00       | 0.15 | 0.85 |
| Final Sat.:                                 | 1750        | 5443 | 157  | 1750        | 4807 | 792  | 1750       | 1900 | 1750 | 1750       | 269  | 1531 |
| Capacity Analysis Module:                   |             |      |      |             |      |      |            |      |      |            |      |      |
| Vol/Sat:                                    | 0.09        | 0.33 | 0.33 | 0.03        | 0.18 | 0.18 | 0.01       | 0.00 | 0.01 | 0.02       | 0.04 | 0.04 |
| Crit Moves:                                 | ****        | **** | **** | ****        | **** | **** | ****       | **** | **** | ****       | **** | **** |
| Green Time:                                 | 16.0        | 34.0 | 34.0 | 7.0         | 25.0 | 25.0 | 10.0       | 0.0  | 26.0 | 10.0       | 10.0 | 10.0 |
| Volume/Cap:                                 | 0.35        | 0.57 | 0.57 | 0.27        | 0.44 | 0.44 | 0.05       | 0.00 | 0.03 | 0.14       | 0.22 | 0.22 |
| Delay/Veh:                                  | 18.2        | 8.6  | 8.6  | 24.9        | 12.6 | 12.6 | 21.1       | 0.0  | 9.7  | 21.6       | 22.0 | 22.0 |
| User DelAdj:                                | 1.00        | 1.00 | 1.00 | 1.00        | 1.00 | 1.00 | 1.00       | 1.00 | 1.00 | 1.00       | 1.00 | 1.00 |
| AdjDel/Veh:                                 | 18.2        | 8.6  | 8.6  | 24.9        | 12.6 | 12.6 | 21.1       | 0.0  | 9.7  | 21.6       | 22.0 | 22.0 |
| LOS by Move:                                | B           | A    | A    | C           | B    | B    | C          | A    | A    | C          | C    | C    |
| HCM2k95thQ:                                 | 6           | 15   | 15   | 2           | 9    | 9    | 1          | 0    | 0    | 2          | 3    | 3    |

Note: Queue reported is the number of cars per lane.

BART

Level Of Service Computation Report  
 2000 HCM Operations (Future Volume Alternative)  
 PM - Cumulative With Project

Intersection #1012: El Camino Real/Railroad Ave [Study Int 53]

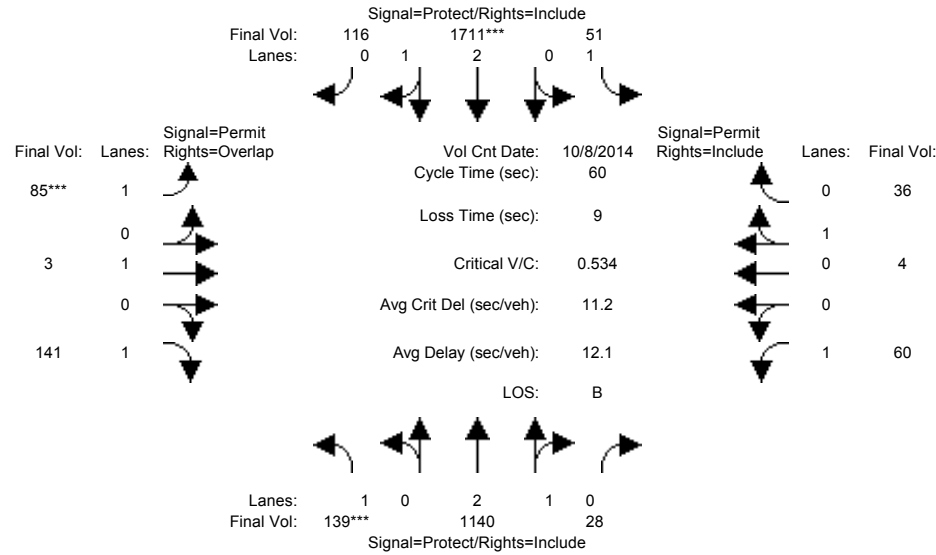

| Approach:                                   | North Bound |      |      | South Bound |      |      | East Bound |      |      | West Bound |      |      |
|---|-------------|------|------|-------------|------|------|------------|------|------|------------|------|------|
| Movement:                                   | L           | T    | R    | L           | T    | R    | L          | T    | R    | L          | T    | R    |
| Min. Green:                                 | 7           | 10   | 10   | 7           | 10   | 10   | 10         | 10   | 10   | 10         | 10   | 10   |
| Y+R:  | 4.0         | 4.0  | 4.0  | 4.0         | 4.0  | 4.0  | 4.0        | 4.0  | 4.0  | 4.0        | 4.0  | 4.0  |
| Volume Module: >> Count Date: 8 Oct 2014 << |             |      |      |             |      |      |            |      |      |            |      |      |
| Base Vol:                                   | 139         | 1140 | 28   | 51          | 1711 | 116  | 85         | 3    | 141  | 60         | 4    | 36   |
| Growth Adj:                                 | 1.00        | 1.00 | 1.00 | 1.00        | 1.00 | 1.00 | 1.00       | 1.00 | 1.00 | 1.00       | 1.00 | 1.00 |
| Initial Bse:                                | 139         | 1140 | 28   | 51          | 1711 | 116  | 85         | 3    | 141  | 60         | 4    | 36   |
| Added Vol:                                  | 0           | 0    | 0    | 0           | 0    | 0    | 0          | 0    | 0    | 0          | 0    | 0    |
| PasserByVol:                                | 0           | 0    | 0    | 0           | 0    | 0    | 0          | 0    | 0    | 0          | 0    | 0    |
| Initial Fut:                                | 139         | 1140 | 28   | 51          | 1711 | 116  | 85         | 3    | 141  | 60         | 4    | 36   |
| User Adj:                                   | 1.00        | 1.00 | 1.00 | 1.00        | 1.00 | 1.00 | 1.00       | 1.00 | 1.00 | 1.00       | 1.00 | 1.00 |
| PHF Adj:                                    | 1.00        | 1.00 | 1.00 | 1.00        | 1.00 | 1.00 | 1.00       | 1.00 | 1.00 | 1.00       | 1.00 | 1.00 |
| PHF Volume:                                 | 139         | 1140 | 28   | 51          | 1711 | 116  | 85         | 3    | 141  | 60         | 4    | 36   |
| Reduct Vol:                                 | 0           | 0    | 0    | 0           | 0    | 0    | 0          | 0    | 0    | 0          | 0    | 0    |
| Reduced Vol:                                | 139         | 1140 | 28   | 51          | 1711 | 116  | 85         | 3    | 141  | 60         | 4    | 36   |
| PCE Adj:                                    | 1.00        | 1.00 | 1.00 | 1.00        | 1.00 | 1.00 | 1.00       | 1.00 | 1.00 | 1.00       | 1.00 | 1.00 |
| MLF Adj:                                    | 1.00        | 1.00 | 1.00 | 1.00        | 1.00 | 1.00 | 1.00       | 1.00 | 1.00 | 1.00       | 1.00 | 1.00 |
| Final Volume:                               | 139         | 1140 | 28   | 51          | 1711 | 116  | 85         | 3    | 141  | 60         | 4    | 36   |
| Saturation Flow Module:                     |             |      |      |             |      |      |            |      |      |            |      |      |
| Sat/Lane:                                   | 1900        | 1900 | 1900 | 1900        | 1900 | 1900 | 1900       | 1900 | 1900 | 1900       | 1900 | 1900 |
| Adjustment:                                 | 0.92        | 0.98 | 0.95 | 0.92        | 0.98 | 0.95 | 0.92       | 1.00 | 0.92 | 0.92       | 0.95 | 0.95 |
| Lanes:                                      | 1.00        | 2.93 | 0.07 | 1.00        | 2.80 | 0.20 | 1.00       | 1.00 | 1.00 | 1.00       | 0.10 | 0.90 |
| Final Sat.:                                 | 1750        | 5466 | 134  | 1750        | 5244 | 356  | 1750       | 1900 | 1750 | 1750       | 180  | 1620 |
| Capacity Analysis Module:                   |             |      |      |             |      |      |            |      |      |            |      |      |
| Vol/Sat:                                    | 0.08        | 0.21 | 0.21 | 0.03        | 0.33 | 0.33 | 0.05       | 0.00 | 0.08 | 0.03       | 0.02 | 0.02 |
| Crit Moves:                                 | ****        |      |      | ****        |      |      | ****       |      |      |            |      |      |
| Green Time:                                 | 8.0         | 26.3 | 26.3 | 14.7        | 33.0 | 33.0 | 10.0       | 10.0 | 18.0 | 10.0       | 10.0 | 10.0 |
| Volume/Cap:                                 | 0.59        | 0.48 | 0.48 | 0.12        | 0.59 | 0.59 | 0.29       | 0.01 | 0.27 | 0.21       | 0.13 | 0.13 |
| Delay/Veh:                                  | 28.5        | 12.1 | 12.1 | 17.7        | 9.4  | 9.4  | 22.5       | 20.9 | 16.2 | 21.9       | 21.5 | 21.5 |
| User DelAdj:                                | 1.00        | 1.00 | 1.00 | 1.00        | 1.00 | 1.00 | 1.00       | 1.00 | 1.00 | 1.00       | 1.00 | 1.00 |
| AdjDel/Veh:                                 | 28.5        | 12.1 | 12.1 | 17.7        | 9.4  | 9.4  | 22.5       | 20.9 | 16.2 | 21.9       | 21.5 | 21.5 |
| LOS by Move:                                | C           | B    | B    | B           | A    | A    | C          | C    | B    | C          | C    | C    |
| HCM2k95thQ:                                 | 7           | 11   | 11   | 2           | 14   | 14   | 4          | 0    | 5    | 2          | 2    | 2    |

Note: Queue reported is the number of cars per lane.

BART

Level Of Service Computation Report  
 2000 HCM Operations (Future Volume Alternative)  
 AM - Cumulative No Project

Intersection #1202: LAFAYETTE/EL CAMINO REAL [Study Int 46]

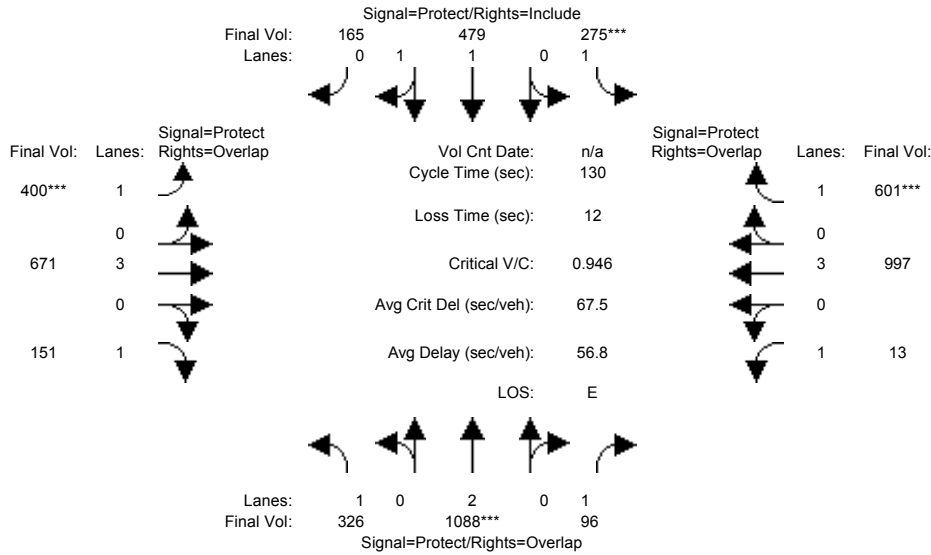

| Approach:                 | North Bound |      |      | South Bound |      |      | East Bound |      |      | West Bound |      |      |
|---------------------------|-------------|------|------|-------------|------|------|------------|------|------|------------|------|------|
| Movement:                 | L           | T    | R    | L           | T    | R    | L          | T    | R    | L          | T    | R    |
| Min. Green:               | 7           | 10   | 10   | 7           | 10   | 10   | 7          | 10   | 10   | 7          | 10   | 10   |
| Y+R:                      | 4.0         | 4.0  | 4.0  | 4.0         | 4.0  | 4.0  | 4.0        | 4.0  | 4.0  | 4.0        | 4.0  | 4.0  |
| Volume Module:            |             |      |      |             |      |      |            |      |      |            |      |      |
| Base Vol:                 | 326         | 1088 | 96   | 275         | 479  | 165  | 400        | 671  | 151  | 13         | 997  | 601  |
| Growth Adj:               | 1.00        | 1.00 | 1.00 | 1.00        | 1.00 | 1.00 | 1.00       | 1.00 | 1.00 | 1.00       | 1.00 | 1.00 |
| Initial Bse:              | 326         | 1088 | 96   | 275         | 479  | 165  | 400        | 671  | 151  | 13         | 997  | 601  |
| Added Vol:                | 0           | 0    | 0    | 0           | 0    | 0    | 0          | 0    | 0    | 0          | 0    | 0    |
| PasserByVol:              | 0           | 0    | 0    | 0           | 0    | 0    | 0          | 0    | 0    | 0          | 0    | 0    |
| Initial Fut:              | 326         | 1088 | 96   | 275         | 479  | 165  | 400        | 671  | 151  | 13         | 997  | 601  |
| User Adj:                 | 1.00        | 1.00 | 1.00 | 1.00        | 1.00 | 1.00 | 1.00       | 1.00 | 1.00 | 1.00       | 1.00 | 1.00 |
| PHF Adj:                  | 1.00        | 1.00 | 1.00 | 1.00        | 1.00 | 1.00 | 1.00       | 1.00 | 1.00 | 1.00       | 1.00 | 1.00 |
| PHF Volume:               | 326         | 1088 | 96   | 275         | 479  | 165  | 400        | 671  | 151  | 13         | 997  | 601  |
| Reduct Vol:               | 0           | 0    | 0    | 0           | 0    | 0    | 0          | 0    | 0    | 0          | 0    | 0    |
| Reduced Vol:              | 326         | 1088 | 96   | 275         | 479  | 165  | 400        | 671  | 151  | 13         | 997  | 601  |
| PCE Adj:                  | 1.00        | 1.00 | 1.00 | 1.00        | 1.00 | 1.00 | 1.00       | 1.00 | 1.00 | 1.00       | 1.00 | 1.00 |
| MLF Adj:                  | 1.00        | 1.00 | 1.00 | 1.00        | 1.00 | 1.00 | 1.00       | 1.00 | 1.00 | 1.00       | 1.00 | 1.00 |
| Final Volume:             | 326         | 1088 | 96   | 275         | 479  | 165  | 400        | 671  | 151  | 13         | 997  | 601  |
| Saturation Flow Module:   |             |      |      |             |      |      |            |      |      |            |      |      |
| Sat/Lane:                 | 1900        | 1900 | 1900 | 1900        | 1900 | 1900 | 1900       | 1900 | 1900 | 1900       | 1900 | 1900 |
| Adjustment:               | 0.92        | 1.00 | 0.92 | 0.92        | 0.98 | 0.95 | 0.92       | 1.00 | 0.92 | 0.92       | 1.00 | 0.92 |
| Lanes:                    | 1.00        | 2.00 | 1.00 | 1.00        | 1.47 | 0.53 | 1.00       | 3.00 | 1.00 | 1.00       | 3.00 | 1.00 |
| Final Sat.:               | 1750        | 3800 | 1750 | 1750        | 2751 | 948  | 1750       | 5700 | 1750 | 1750       | 5700 | 1750 |
| Capacity Analysis Module: |             |      |      |             |      |      |            |      |      |            |      |      |
| Vol/Sat:                  | 0.19        | 0.29 | 0.05 | 0.16        | 0.17 | 0.17 | 0.23       | 0.12 | 0.09 | 0.01       | 0.17 | 0.34 |
| Crit Moves:               | ****        | **** | **** | ****        | **** | **** | ****       | **** | **** | ****       | **** | **** |
| Green Time:               | 31.5        | 39.4 | 57.3 | 21.6        | 29.5 | 29.5 | 31.4       | 39.1 | 70.6 | 17.9       | 25.6 | 47.2 |
| Volume/Cap:               | 0.77        | 0.95 | 0.12 | 0.95        | 0.77 | 0.77 | 0.95       | 0.39 | 0.16 | 0.05       | 0.89 | 0.95 |
| Delay/Veh:                | 54.1        | 59.6 | 21.6 | 91.9        | 51.4 | 51.4 | 78.7       | 36.1 | 14.9 | 48.8       | 59.7 | 63.3 |
| User DelAdj:              | 1.00        | 1.00 | 1.00 | 1.00        | 1.00 | 1.00 | 1.00       | 1.00 | 1.00 | 1.00       | 1.00 | 1.00 |
| AdjDel/Veh:               | 54.1        | 59.6 | 21.6 | 91.9        | 51.4 | 51.4 | 78.7       | 36.1 | 14.9 | 48.8       | 59.7 | 63.3 |
| LOS by Move:              | D           | E    | C    | F           | D    | D    | E          | D    | B    | D          | E    | E    |
| HCM2k95thQ:               | 24          | 39   | 5    | 24          | 23   | 23   | 32         | 13   | 6    | 1          | 28   | 48   |

Note: Queue reported is the number of cars per lane.



BART

Level Of Service Computation Report  
 2000 HCM Operations (Future Volume Alternative)  
 PM - Cumulative No Project

Intersection #1202: LAFAYETTE/EL CAMINO REAL [Study Int 46]

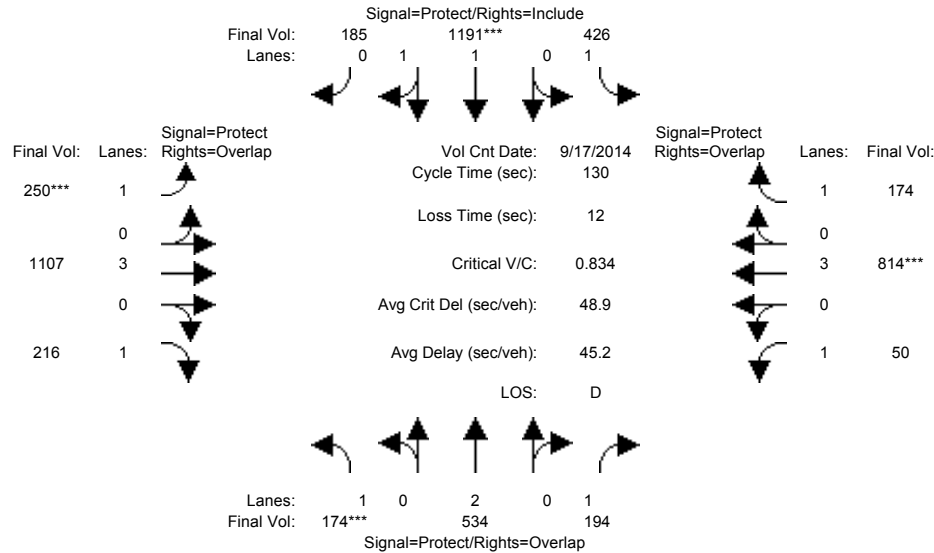

| Approach:                                    | North Bound |      |      | South Bound |      |      | East Bound |      |      | West Bound |      |      |
|--|-------------|------|------|-------------|------|------|------------|------|------|------------|------|------|
| Movement:                                    | L           | T    | R    | L           | T    | R    | L          | T    | R    | L          | T    | R    |
| Min. Green:                                  | 7           | 10   | 10   | 7           | 10   | 10   | 7          | 10   | 10   | 7          | 10   | 10   |
| Y+R:   | 4.0         | 4.0  | 4.0  | 4.0         | 4.0  | 4.0  | 4.0        | 4.0  | 4.0  | 4.0        | 4.0  | 4.0  |
| Volume Module: >> Count Date: 17 Sep 2014 << |             |      |      |             |      |      |            |      |      |            |      |      |
| Base Vol:                                    | 174         | 534  | 194  | 426         | 1191 | 185  | 250        | 1107 | 216  | 50         | 814  | 174  |
| Growth Adj:                                  | 1.00        | 1.00 | 1.00 | 1.00        | 1.00 | 1.00 | 1.00       | 1.00 | 1.00 | 1.00       | 1.00 | 1.00 |
| Initial Bse:                                 | 174         | 534  | 194  | 426         | 1191 | 185  | 250        | 1107 | 216  | 50         | 814  | 174  |
| Added Vol:                                   | 0           | 0    | 0    | 0           | 0    | 0    | 0          | 0    | 0    | 0          | 0    | 0    |
| PasserByVol:                                 | 0           | 0    | 0    | 0           | 0    | 0    | 0          | 0    | 0    | 0          | 0    | 0    |
| Initial Fut:                                 | 174         | 534  | 194  | 426         | 1191 | 185  | 250        | 1107 | 216  | 50         | 814  | 174  |
| User Adj:                                    | 1.00        | 1.00 | 1.00 | 1.00        | 1.00 | 1.00 | 1.00       | 1.00 | 1.00 | 1.00       | 1.00 | 1.00 |
| PHF Adj:                                     | 1.00        | 1.00 | 1.00 | 1.00        | 1.00 | 1.00 | 1.00       | 1.00 | 1.00 | 1.00       | 1.00 | 1.00 |
| PHF Volume:                                  | 174         | 534  | 194  | 426         | 1191 | 185  | 250        | 1107 | 216  | 50         | 814  | 174  |
| Reduct Vol:                                  | 0           | 0    | 0    | 0           | 0    | 0    | 0          | 0    | 0    | 0          | 0    | 0    |
| Reduced Vol:                                 | 174         | 534  | 194  | 426         | 1191 | 185  | 250        | 1107 | 216  | 50         | 814  | 174  |
| PCE Adj:                                     | 1.00        | 1.00 | 1.00 | 1.00        | 1.00 | 1.00 | 1.00       | 1.00 | 1.00 | 1.00       | 1.00 | 1.00 |
| MLF Adj:                                     | 1.00        | 1.00 | 1.00 | 1.00        | 1.00 | 1.00 | 1.00       | 1.00 | 1.00 | 1.00       | 1.00 | 1.00 |
| Final Volume:                                | 174         | 534  | 194  | 426         | 1191 | 185  | 250        | 1107 | 216  | 50         | 814  | 174  |
| Saturation Flow Module:                      |             |      |      |             |      |      |            |      |      |            |      |      |
| Sat/Lane:                                    | 1900        | 1900 | 1900 | 1900        | 1900 | 1900 | 1900       | 1900 | 1900 | 1900       | 1900 | 1900 |
| Adjustment:                                  | 0.92        | 1.00 | 0.92 | 0.92        | 0.98 | 0.95 | 0.92       | 1.00 | 0.92 | 0.92       | 1.00 | 0.92 |
| Lanes:                                       | 1.00        | 2.00 | 1.00 | 1.00        | 1.72 | 0.28 | 1.00       | 3.00 | 1.00 | 1.00       | 3.00 | 1.00 |
| Final Sat.:                                  | 1750        | 3800 | 1750 | 1750        | 3202 | 497  | 1750       | 5700 | 1750 | 1750       | 5700 | 1750 |
| Capacity Analysis Module:                    |             |      |      |             |      |      |            |      |      |            |      |      |
| Vol/Sat:                                     | 0.10        | 0.14 | 0.11 | 0.24        | 0.37 | 0.37 | 0.14       | 0.19 | 0.12 | 0.03       | 0.14 | 0.10 |
| Crit Moves:                                  | ****        |      |      | ****        |      |      | ****       |      |      | ****       |      |      |
| Green Time:                                  | 15.5        | 26.9 | 36.6 | 46.6        | 58.0 | 58.0 | 22.3       | 34.9 | 50.4 | 9.7        | 22.3 | 68.8 |
| Volume/Cap:                                  | 0.83        | 0.68 | 0.39 | 0.68        | 0.83 | 0.83 | 0.83       | 0.72 | 0.32 | 0.38       | 0.83 | 0.19 |
| Delay/Veh:                                   | 80.1        | 50.0 | 38.3 | 38.4        | 35.6 | 35.6 | 70.0       | 45.0 | 28.1 | 59.2       | 58.4 | 16.1 |
| User DelAdj:                                 | 1.00        | 1.00 | 1.00 | 1.00        | 1.00 | 1.00 | 1.00       | 1.00 | 1.00 | 1.00       | 1.00 | 1.00 |
| AdjDel/Veh:                                  | 80.1        | 50.0 | 38.3 | 38.4        | 35.6 | 35.6 | 70.0       | 45.0 | 28.1 | 59.2       | 58.4 | 16.1 |
| LOS by Move:                                 | F           | D    | D    | D           | D    | D    | E          | D    | C    | E          | E    | B    |
| HCM2k95thQ:                                  | 15          | 18   | 12   | 27          | 42   | 42   | 20         | 24   | 12   | 5          | 23   | 8    |

Note: Queue reported is the number of cars per lane.

BART

Level Of Service Computation Report  
 2000 HCM Operations (Future Volume Alternative)  
 AM - Cumulative With Project

Intersection #1202: LAFAYETTE/EL CAMINO REAL [Study Int 46]

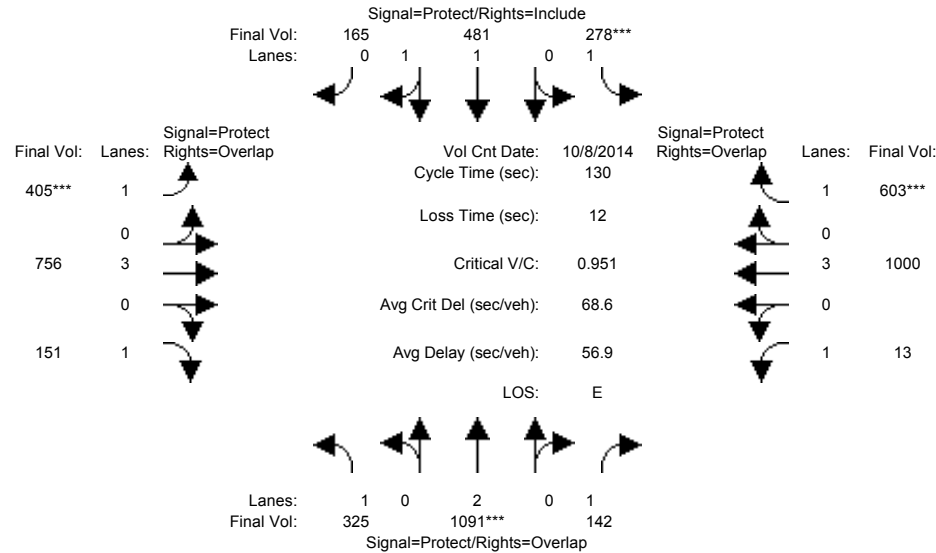

| Approach:                                   | North Bound |      |      | South Bound |      |      | East Bound |      |      | West Bound |      |      |
|---|-------------|------|------|-------------|------|------|------------|------|------|------------|------|------|
| Movement:                                   | L           | T    | R    | L           | T    | R    | L          | T    | R    | L          | T    | R    |
| Min. Green:                                 | 7           | 10   | 10   | 7           | 10   | 10   | 7          | 10   | 10   | 7          | 10   | 10   |
| Y+R:  | 4.0         | 4.0  | 4.0  | 4.0         | 4.0  | 4.0  | 4.0        | 4.0  | 4.0  | 4.0        | 4.0  | 4.0  |
| Volume Module: >> Count Date: 8 Oct 2014 << |             |      |      |             |      |      |            |      |      |            |      |      |
| Base Vol:                                   | 325         | 1091 | 142  | 278         | 481  | 165  | 405        | 756  | 151  | 13         | 1000 | 603  |
| Growth Adj:                                 | 1.00        | 1.00 | 1.00 | 1.00        | 1.00 | 1.00 | 1.00       | 1.00 | 1.00 | 1.00       | 1.00 | 1.00 |
| Initial Bse:                                | 325         | 1091 | 142  | 278         | 481  | 165  | 405        | 756  | 151  | 13         | 1000 | 603  |
| Added Vol:                                  | 0           | 0    | 0    | 0           | 0    | 0    | 0          | 0    | 0    | 0          | 0    | 0    |
| PasserByVol:                                | 0           | 0    | 0    | 0           | 0    | 0    | 0          | 0    | 0    | 0          | 0    | 0    |
| Initial Fut:                                | 325         | 1091 | 142  | 278         | 481  | 165  | 405        | 756  | 151  | 13         | 1000 | 603  |
| User Adj:                                   | 1.00        | 1.00 | 1.00 | 1.00        | 1.00 | 1.00 | 1.00       | 1.00 | 1.00 | 1.00       | 1.00 | 1.00 |
| PHF Adj:                                    | 1.00        | 1.00 | 1.00 | 1.00        | 1.00 | 1.00 | 1.00       | 1.00 | 1.00 | 1.00       | 1.00 | 1.00 |
| PHF Volume:                                 | 325         | 1091 | 142  | 278         | 481  | 165  | 405        | 756  | 151  | 13         | 1000 | 603  |
| Reduct Vol:                                 | 0           | 0    | 0    | 0           | 0    | 0    | 0          | 0    | 0    | 0          | 0    | 0    |
| Reduced Vol:                                | 325         | 1091 | 142  | 278         | 481  | 165  | 405        | 756  | 151  | 13         | 1000 | 603  |
| PCE Adj:                                    | 1.00        | 1.00 | 1.00 | 1.00        | 1.00 | 1.00 | 1.00       | 1.00 | 1.00 | 1.00       | 1.00 | 1.00 |
| MLF Adj:                                    | 1.00        | 1.00 | 1.00 | 1.00        | 1.00 | 1.00 | 1.00       | 1.00 | 1.00 | 1.00       | 1.00 | 1.00 |
| Final Volume:                               | 325         | 1091 | 142  | 278         | 481  | 165  | 405        | 756  | 151  | 13         | 1000 | 603  |
| Saturation Flow Module:                     |             |      |      |             |      |      |            |      |      |            |      |      |
| Sat/Lane:                                   | 1900        | 1900 | 1900 | 1900        | 1900 | 1900 | 1900       | 1900 | 1900 | 1900       | 1900 | 1900 |
| Adjustment:                                 | 0.92        | 1.00 | 0.92 | 0.92        | 0.98 | 0.95 | 0.92       | 1.00 | 0.92 | 0.92       | 1.00 | 0.92 |
| Lanes:                                      | 1.00        | 2.00 | 1.00 | 1.00        | 1.48 | 0.52 | 1.00       | 3.00 | 1.00 | 1.00       | 3.00 | 1.00 |
| Final Sat.:                                 | 1750        | 3800 | 1750 | 1750        | 2754 | 945  | 1750       | 5700 | 1750 | 1750       | 5700 | 1750 |
| Capacity Analysis Module:                   |             |      |      |             |      |      |            |      |      |            |      |      |
| Vol/Sat:                                    | 0.19        | 0.29 | 0.08 | 0.16        | 0.17 | 0.17 | 0.23       | 0.13 | 0.09 | 0.01       | 0.18 | 0.34 |
| Crit Moves:                                 | ****        | **** | **** | ****        | **** | **** | ****       | **** | **** | ****       | **** | **** |
| Green Time:                                 | 31.4        | 39.3 | 55.7 | 21.7        | 29.5 | 29.5 | 31.6       | 40.6 | 72.0 | 16.5       | 25.4 | 47.1 |
| Volume/Cap:                                 | 0.77        | 0.95 | 0.19 | 0.95        | 0.77 | 0.77 | 0.95       | 0.43 | 0.16 | 0.06       | 0.90 | 0.95 |
| Delay/Veh:                                  | 54.2        | 60.6 | 23.2 | 93.1        | 51.4 | 51.4 | 79.7       | 35.6 | 14.2 | 50.1       | 60.9 | 64.5 |
| User DelAdj:                                | 1.00        | 1.00 | 1.00 | 1.00        | 1.00 | 1.00 | 1.00       | 1.00 | 1.00 | 1.00       | 1.00 | 1.00 |
| AdjDel/Veh:                                 | 54.2        | 60.6 | 23.2 | 93.1        | 51.4 | 51.4 | 79.7       | 35.6 | 14.2 | 50.1       | 60.9 | 64.5 |
| LOS by Move:                                | D           | E    | C    | F           | D    | D    | E          | D    | B    | D          | E    | E    |
| HCM2k95thQ:                                 | 24          | 40   | 7    | 25          | 23   | 23   | 32         | 14   | 6    | 1          | 28   | 49   |

Note: Queue reported is the number of cars per lane.

BART

Level Of Service Computation Report  
 2000 HCM Operations (Future Volume Alternative)  
 PM - Cumulative With Project

Intersection #1202: LAFAYETTE/EL CAMINO REAL [Study Int 46]

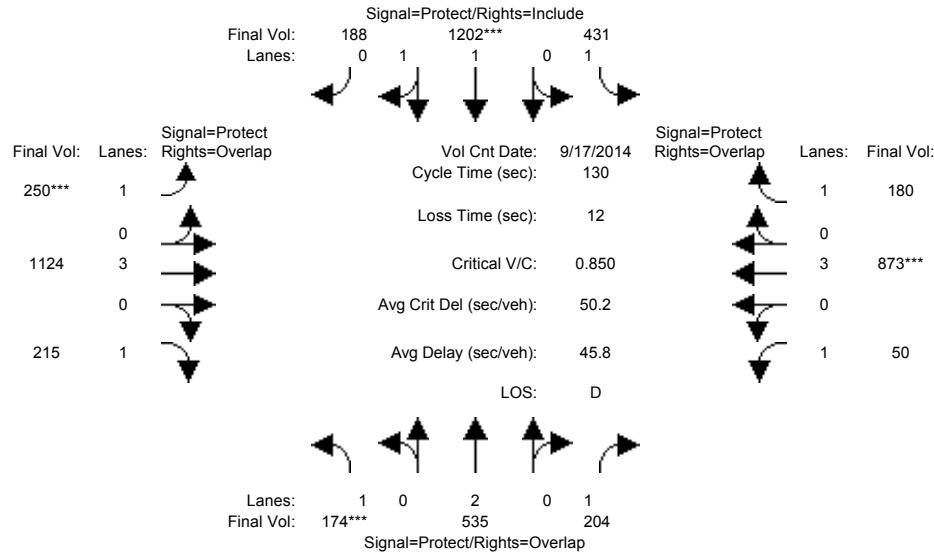

| Approach:                                    | North Bound |      |      | South Bound |      |      | East Bound |      |      | West Bound |      |      |
|--|-------------|------|------|-------------|------|------|------------|------|------|------------|------|------|
| Movement:                                    | L           | T    | R    | L           | T    | R    | L          | T    | R    | L          | T    | R    |
| Min. Green:                                  | 7           | 10   | 10   | 7           | 10   | 10   | 7          | 10   | 10   | 7          | 10   | 10   |
| Y+R:   | 4.0         | 4.0  | 4.0  | 4.0         | 4.0  | 4.0  | 4.0        | 4.0  | 4.0  | 4.0        | 4.0  | 4.0  |
| Volume Module: >> Count Date: 17 Sep 2014 << |             |      |      |             |      |      |            |      |      |            |      |      |
| Base Vol:                                    | 174         | 535  | 204  | 431         | 1202 | 188  | 250        | 1124 | 215  | 50         | 873  | 180  |
| Growth Adj:                                  | 1.00        | 1.00 | 1.00 | 1.00        | 1.00 | 1.00 | 1.00       | 1.00 | 1.00 | 1.00       | 1.00 | 1.00 |
| Initial Bse:                                 | 174         | 535  | 204  | 431         | 1202 | 188  | 250        | 1124 | 215  | 50         | 873  | 180  |
| Added Vol:                                   | 0           | 0    | 0    | 0           | 0    | 0    | 0          | 0    | 0    | 0          | 0    | 0    |
| PasserByVol:                                 | 0           | 0    | 0    | 0           | 0    | 0    | 0          | 0    | 0    | 0          | 0    | 0    |
| Initial Fut:                                 | 174         | 535  | 204  | 431         | 1202 | 188  | 250        | 1124 | 215  | 50         | 873  | 180  |
| User Adj:                                    | 1.00        | 1.00 | 1.00 | 1.00        | 1.00 | 1.00 | 1.00       | 1.00 | 1.00 | 1.00       | 1.00 | 1.00 |
| PHF Adj:                                     | 1.00        | 1.00 | 1.00 | 1.00        | 1.00 | 1.00 | 1.00       | 1.00 | 1.00 | 1.00       | 1.00 | 1.00 |
| PHF Volume:                                  | 174         | 535  | 204  | 431         | 1202 | 188  | 250        | 1124 | 215  | 50         | 873  | 180  |
| Reduct Vol:                                  | 0           | 0    | 0    | 0           | 0    | 0    | 0          | 0    | 0    | 0          | 0    | 0    |
| Reduced Vol:                                 | 174         | 535  | 204  | 431         | 1202 | 188  | 250        | 1124 | 215  | 50         | 873  | 180  |
| PCE Adj:                                     | 1.00        | 1.00 | 1.00 | 1.00        | 1.00 | 1.00 | 1.00       | 1.00 | 1.00 | 1.00       | 1.00 | 1.00 |
| MLF Adj:                                     | 1.00        | 1.00 | 1.00 | 1.00        | 1.00 | 1.00 | 1.00       | 1.00 | 1.00 | 1.00       | 1.00 | 1.00 |
| Final Volume:                                | 174         | 535  | 204  | 431         | 1202 | 188  | 250        | 1124 | 215  | 50         | 873  | 180  |
| Saturation Flow Module:                      |             |      |      |             |      |      |            |      |      |            |      |      |
| Sat/Lane:                                    | 1900        | 1900 | 1900 | 1900        | 1900 | 1900 | 1900       | 1900 | 1900 | 1900       | 1900 | 1900 |
| Adjustment:                                  | 0.92        | 1.00 | 0.92 | 0.92        | 0.98 | 0.95 | 0.92       | 1.00 | 0.92 | 0.92       | 1.00 | 0.92 |
| Lanes:                                       | 1.00        | 2.00 | 1.00 | 1.00        | 1.72 | 0.28 | 1.00       | 3.00 | 1.00 | 1.00       | 3.00 | 1.00 |
| Final Sat.:                                  | 1750        | 3800 | 1750 | 1750        | 3199 | 500  | 1750       | 5700 | 1750 | 1750       | 5700 | 1750 |
| Capacity Analysis Module:                    |             |      |      |             |      |      |            |      |      |            |      |      |
| Vol/Sat:                                     | 0.10        | 0.14 | 0.12 | 0.25        | 0.38 | 0.38 | 0.14       | 0.20 | 0.12 | 0.03       | 0.15 | 0.10 |
| Crit Moves:                                  | ****        |      |      | ****        |      |      | ****       |      |      | ****       |      |      |
| Green Time:                                  | 15.2        | 26.4 | 36.2 | 46.3        | 57.5 | 57.5 | 21.9       | 35.6 | 50.8 | 9.7        | 23.4 | 69.7 |
| Volume/Cap:                                  | 0.85        | 0.69 | 0.42 | 0.69        | 0.85 | 0.85 | 0.85       | 0.72 | 0.31 | 0.38       | 0.85 | 0.19 |
| Delay/Veh:                                   | 83.2        | 50.7 | 38.9 | 39.1        | 36.8 | 36.8 | 72.7       | 44.4 | 27.8 | 59.1       | 58.4 | 15.7 |
| User DelAdj:                                 | 1.00        | 1.00 | 1.00 | 1.00        | 1.00 | 1.00 | 1.00       | 1.00 | 1.00 | 1.00       | 1.00 | 1.00 |
| AdjDel/Veh:                                  | 83.2        | 50.7 | 38.9 | 39.1        | 36.8 | 36.8 | 72.7       | 44.4 | 27.8 | 59.1       | 58.4 | 15.7 |
| LOS by Move:                                 | F           | D    | D    | D           | D    | D    | E          | D    | C    | E          | E    | B    |
| HCM2k95thQ:                                  | 15          | 18   | 13   | 28          | 44   | 44   | 20         | 24   | 12   | 5          | 25   | 8    |

Note: Queue reported is the number of cars per lane.

BART

Level Of Service Computation Report  
 2000 HCM Operations (Future Volume Alternative)  
 AM - Cumulative No Project

Intersection #1203: ECR/Lincoln 1203 [Study Int 43]

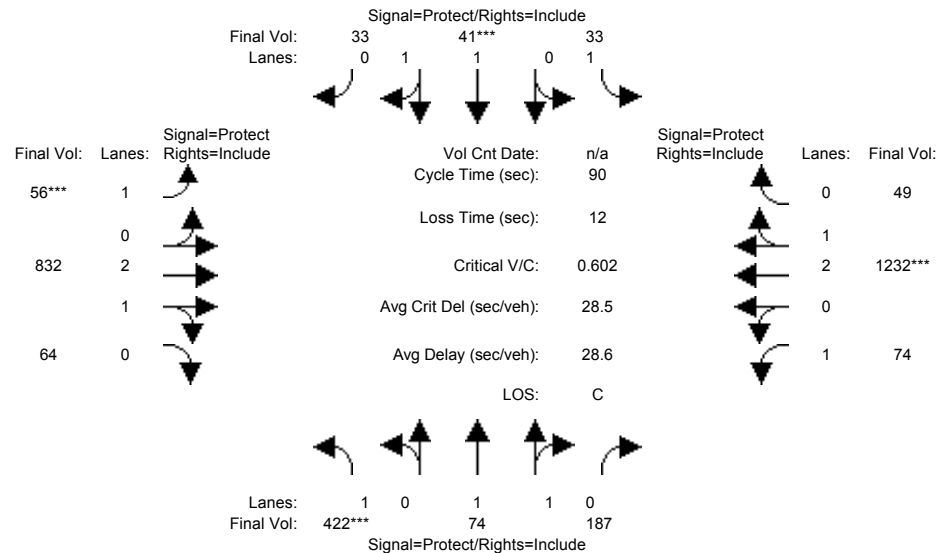

| Approach:                 | North Bound |      |      | South Bound |      |      | East Bound |      |      | West Bound |      |      |
|---------------------------|-------------|------|------|-------------|------|------|------------|------|------|------------|------|------|
| Movement:                 | L           | T    | R    | L           | T    | R    | L          | T    | R    | L          | T    | R    |
| Min. Green:               | 7           | 10   | 10   | 7           | 10   | 10   | 7          | 10   | 10   | 7          | 10   | 10   |
| Y+R:                      | 4.0         | 4.0  | 4.0  | 4.0         | 4.0  | 4.0  | 4.0        | 4.0  | 4.0  | 4.0        | 4.0  | 4.0  |
| Volume Module:            |             |      |      |             |      |      |            |      |      |            |      |      |
| Base Vol:                 | 422         | 74   | 187  | 33          | 41   | 33   | 56         | 832  | 64   | 74         | 1232 | 49   |
| Growth Adj:               | 1.00        | 1.00 | 1.00 | 1.00        | 1.00 | 1.00 | 1.00       | 1.00 | 1.00 | 1.00       | 1.00 | 1.00 |
| Initial Bse:              | 422         | 74   | 187  | 33          | 41   | 33   | 56         | 832  | 64   | 74         | 1232 | 49   |
| Added Vol:                | 0           | 0    | 0    | 0           | 0    | 0    | 0          | 0    | 0    | 0          | 0    | 0    |
| PasserByVol:              | 0           | 0    | 0    | 0           | 0    | 0    | 0          | 0    | 0    | 0          | 0    | 0    |
| Initial Fut:              | 422         | 74   | 187  | 33          | 41   | 33   | 56         | 832  | 64   | 74         | 1232 | 49   |
| User Adj:                 | 1.00        | 1.00 | 1.00 | 1.00        | 1.00 | 1.00 | 1.00       | 1.00 | 1.00 | 1.00       | 1.00 | 1.00 |
| PHF Adj:                  | 1.00        | 1.00 | 1.00 | 1.00        | 1.00 | 1.00 | 1.00       | 1.00 | 1.00 | 1.00       | 1.00 | 1.00 |
| PHF Volume:               | 422         | 74   | 187  | 33          | 41   | 33   | 56         | 832  | 64   | 74         | 1232 | 49   |
| Reduct Vol:               | 0           | 0    | 0    | 0           | 0    | 0    | 0          | 0    | 0    | 0          | 0    | 0    |
| Reduced Vol:              | 422         | 74   | 187  | 33          | 41   | 33   | 56         | 832  | 64   | 74         | 1232 | 49   |
| PCE Adj:                  | 1.00        | 1.00 | 1.00 | 1.00        | 1.00 | 1.00 | 1.00       | 1.00 | 1.00 | 1.00       | 1.00 | 1.00 |
| MLF Adj:                  | 1.00        | 1.00 | 1.00 | 1.00        | 1.00 | 1.00 | 1.00       | 1.00 | 1.00 | 1.00       | 1.00 | 1.00 |
| Final Volume:             | 422         | 74   | 187  | 33          | 41   | 33   | 56         | 832  | 64   | 74         | 1232 | 49   |
| Saturation Flow Module:   |             |      |      |             |      |      |            |      |      |            |      |      |
| Sat/Lane:                 | 1900        | 1900 | 1900 | 1900        | 1900 | 1900 | 1900       | 1900 | 1900 | 1900       | 1900 | 1900 |
| Adjustment:               | 0.92        | 1.00 | 0.92 | 0.92        | 0.99 | 0.95 | 0.92       | 0.99 | 0.95 | 0.92       | 0.98 | 0.95 |
| Lanes:                    | 1.00        | 1.00 | 1.00 | 1.00        | 1.08 | 0.92 | 1.00       | 2.78 | 0.22 | 1.00       | 2.88 | 0.12 |
| Final Sat.:               | 1750        | 1900 | 1750 | 1750        | 2049 | 1649 | 1750       | 5199 | 400  | 1750       | 5386 | 214  |
| Capacity Analysis Module: |             |      |      |             |      |      |            |      |      |            |      |      |
| Vol/Sat:                  | 0.24        | 0.04 | 0.11 | 0.02        | 0.02 | 0.02 | 0.03       | 0.16 | 0.16 | 0.04       | 0.23 | 0.23 |
| Crit Moves:               | ****        |      |      | ****        |      |      | ****       |      |      | ****       |      |      |
| Green Time:               | 31.3        | 24.3 | 24.3 | 17.0        | 10.0 | 10.0 | 7.0        | 24.7 | 24.7 | 12.0       | 29.7 | 29.7 |
| Volume/Cap:               | 0.69        | 0.14 | 0.40 | 0.10        | 0.18 | 0.18 | 0.41       | 0.58 | 0.58 | 0.32       | 0.69 | 0.69 |
| Delay/Veh:                | 28.7        | 25.0 | 27.2 | 30.3        | 36.5 | 36.5 | 41.6       | 28.8 | 28.8 | 36.1       | 27.4 | 27.4 |
| User DelAdj:              | 1.00        | 1.00 | 1.00 | 1.00        | 1.00 | 1.00 | 1.00       | 1.00 | 1.00 | 1.00       | 1.00 | 1.00 |
| AdjDel/Veh:               | 28.7        | 25.0 | 27.2 | 30.3        | 36.5 | 36.5 | 41.6       | 28.8 | 28.8 | 36.1       | 27.4 | 27.4 |
| LOS by Move:              | C           | C    | C    | C           | D    | D    | D          | C    | C    | D          | C    | C    |
| HCM2k95thQ:               | 20          | 3    | 9    | 2           | 2    | 2    | 3          | 13   | 13   | 4          | 19   | 19   |

Note: Queue reported is the number of cars per lane.

BART

Level Of Service Computation Report  
2000 HCM Operations (Future Volume Alternative)  
PM - Cumulative No Project

Intersection #1203: ECR/Lincoln 1203 [Study Int 43]

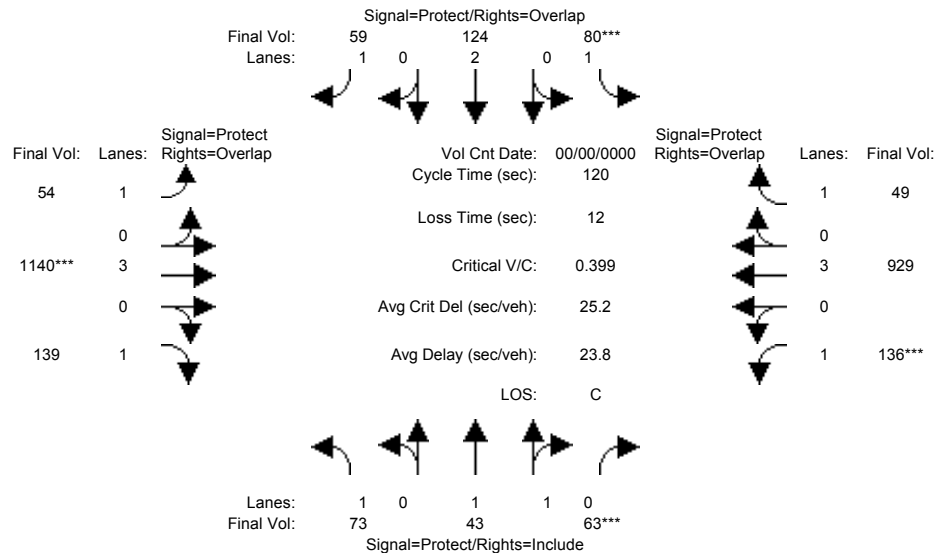

| Approach:                     | North Bound           |      |      | South Bound |      |      | East Bound |      |      | West Bound |      |      |
|-------------------------------|-----------------------|------|------|-------------|------|------|------------|------|------|------------|------|------|
| Movement:                     | L                     | T    | R    | L           | T    | R    | L          | T    | R    | L          | T    | R    |
| Min. Green:                   | 7                     | 10   | 10   | 7           | 10   | 10   | 7          | 10   | 10   | 7          | 10   | 10   |
| Y+R:                          | 4.0                   | 4.0  | 4.0  | 4.0         | 4.0  | 4.0  | 4.0        | 4.0  | 4.0  | 4.0        | 4.0  | 4.0  |
| Volume Module: >> Count Date: | 0 0 << 5:00 - 6:00 PM |      |      |             |      |      |            |      |      |            |      |      |
| Base Vol:                     | 73                    | 43   | 63   | 80          | 124  | 59   | 54         | 1140 | 139  | 136        | 929  | 49   |
| Growth Adj:                   | 1.00                  | 1.00 | 1.00 | 1.00        | 1.00 | 1.00 | 1.00       | 1.00 | 1.00 | 1.00       | 1.00 | 1.00 |
| Initial Bse:                  | 73                    | 43   | 63   | 80          | 124  | 59   | 54         | 1140 | 139  | 136        | 929  | 49   |
| Added Vol:                    | 0                     | 0    | 0    | 0           | 0    | 0    | 0          | 0    | 0    | 0          | 0    | 0    |
| PasserByVol:                  | 0                     | 0    | 0    | 0           | 0    | 0    | 0          | 0    | 0    | 0          | 0    | 0    |
| Initial Fut:                  | 73                    | 43   | 63   | 80          | 124  | 59   | 54         | 1140 | 139  | 136        | 929  | 49   |
| User Adj:                     | 1.00                  | 1.00 | 1.00 | 1.00        | 1.00 | 1.00 | 1.00       | 1.00 | 1.00 | 1.00       | 1.00 | 1.00 |
| PHF Adj:                      | 1.00                  | 1.00 | 1.00 | 1.00        | 1.00 | 1.00 | 1.00       | 1.00 | 1.00 | 1.00       | 1.00 | 1.00 |
| PHF Volume:                   | 73                    | 43   | 63   | 80          | 124  | 59   | 54         | 1140 | 139  | 136        | 929  | 49   |
| Reduct Vol:                   | 0                     | 0    | 0    | 0           | 0    | 0    | 0          | 0    | 0    | 0          | 0    | 0    |
| Reduced Vol:                  | 73                    | 43   | 63   | 80          | 124  | 59   | 54         | 1140 | 139  | 136        | 929  | 49   |
| PCE Adj:                      | 1.00                  | 1.00 | 1.00 | 1.00        | 1.00 | 1.00 | 1.00       | 1.00 | 1.00 | 1.00       | 1.00 | 1.00 |
| MLF Adj:                      | 1.00                  | 1.00 | 1.00 | 1.00        | 1.00 | 1.00 | 1.00       | 1.00 | 1.00 | 1.00       | 1.00 | 1.00 |
| Final Volume:                 | 73                    | 43   | 63   | 80          | 124  | 59   | 54         | 1140 | 139  | 136        | 929  | 49   |
| Saturation Flow Module:       |                       |      |      |             |      |      |            |      |      |            |      |      |
| Sat/Lane:                     | 1900                  | 1900 | 1900 | 1900        | 1900 | 1900 | 1900       | 1900 | 1900 | 1900       | 1900 | 1900 |
| Adjustment:                   | 0.92                  | 1.00 | 0.92 | 0.92        | 1.00 | 0.92 | 0.92       | 1.00 | 0.92 | 0.92       | 1.00 | 0.92 |
| Lanes:                        | 1.00                  | 1.00 | 1.00 | 1.00        | 2.00 | 1.00 | 1.00       | 3.00 | 1.00 | 1.00       | 3.00 | 1.00 |
| Final Sat.:                   | 1750                  | 1900 | 1750 | 1750        | 3800 | 1750 | 1750       | 5700 | 1750 | 1750       | 5700 | 1750 |
| Capacity Analysis Module:     |                       |      |      |             |      |      |            |      |      |            |      |      |
| Vol/Sat:                      | 0.04                  | 0.02 | 0.04 | 0.05        | 0.03 | 0.03 | 0.03       | 0.20 | 0.08 | 0.08       | 0.16 | 0.03 |
| Crit Moves:                   | ****                  | **** | **** | ****        | **** | **** | ****       | **** | **** | ****       | **** | **** |
| Green Time:                   | 10.1                  | 10.8 | 10.8 | 13.7        | 14.4 | 36.4 | 22.0       | 60.1 | 70.2 | 23.4       | 61.5 | 75.2 |
| Volume/Cap:                   | 0.50                  | 0.25 | 0.40 | 0.40        | 0.27 | 0.11 | 0.17       | 0.40 | 0.14 | 0.40       | 0.32 | 0.04 |
| Delay/Veh:                    | 55.1                  | 51.1 | 52.5 | 50.6        | 48.3 | 30.2 | 41.5       | 18.8 | 11.3 | 43.0       | 17.1 | 8.6  |
| User DelAdj:                  | 1.00                  | 1.00 | 1.00 | 1.00        | 1.00 | 1.00 | 1.00       | 1.00 | 1.00 | 1.00       | 1.00 | 1.00 |
| AdjDel/Veh:                   | 55.1                  | 51.1 | 52.5 | 50.6        | 48.3 | 30.2 | 41.5       | 18.8 | 11.3 | 43.0       | 17.1 | 8.6  |
| LOS by Move:                  | E                     | D    | D    | D           | D    | C    | D          | B    | B    | D          | B    | A    |
| HCM2k95thQ:                   | 6                     | 3    | 5    | 7           | 5    | 3    | 3          | 15   | 5    | 9          | 12   | 2    |

Note: Queue reported is the number of cars per lane.

BART

Level Of Service Computation Report  
2000 HCM Operations (Future Volume Alternative)  
AM - Cumulative With Project

Intersection #1203: ECR/Lincoln 1203 [Study Int 43]

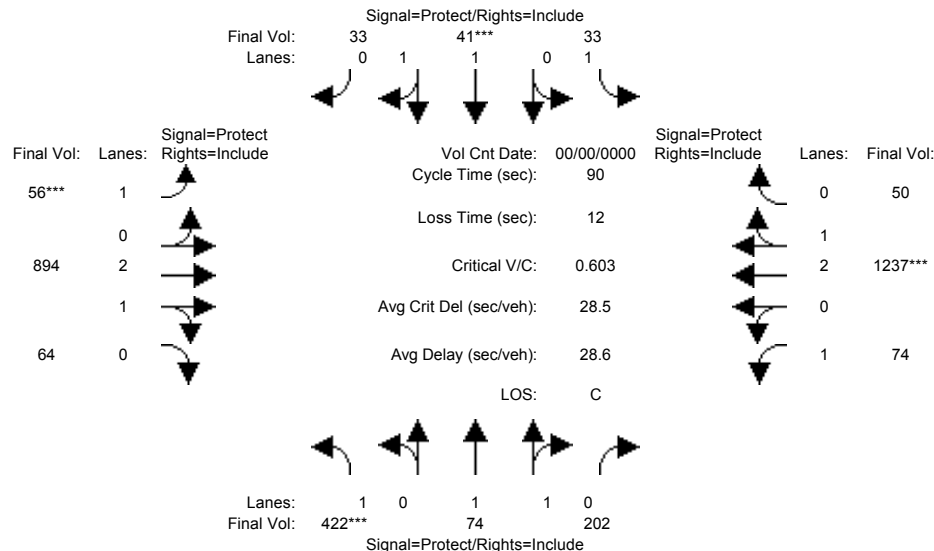

| Approach:                     | North Bound           |      |      | South Bound |      |      | East Bound |      |      | West Bound |      |      |
|-------------------------------|-----------------------|------|------|-------------|------|------|------------|------|------|------------|------|------|
| Movement:                     | L                     | T    | R    | L           | T    | R    | L          | T    | R    | L          | T    | R    |
| Min. Green:                   | 7                     | 10   | 10   | 7           | 10   | 10   | 7          | 10   | 10   | 7          | 10   | 10   |
| Y+R:                          | 4.0                   | 4.0  | 4.0  | 4.0         | 4.0  | 4.0  | 4.0        | 4.0  | 4.0  | 4.0        | 4.0  | 4.0  |
| Volume Module: >> Count Date: | 0 0 << 5:00 - 6:00 PM |      |      |             |      |      |            |      |      |            |      |      |
| Base Vol:                     | 422                   | 74   | 202  | 33          | 41   | 33   | 56         | 894  | 64   | 74         | 1237 | 50   |
| Growth Adj:                   | 1.00                  | 1.00 | 1.00 | 1.00        | 1.00 | 1.00 | 1.00       | 1.00 | 1.00 | 1.00       | 1.00 | 1.00 |
| Initial Bse:                  | 422                   | 74   | 202  | 33          | 41   | 33   | 56         | 894  | 64   | 74         | 1237 | 50   |
| Added Vol:                    | 0                     | 0    | 0    | 0           | 0    | 0    | 0          | 0    | 0    | 0          | 0    | 0    |
| PasserByVol:                  | 0                     | 0    | 0    | 0           | 0    | 0    | 0          | 0    | 0    | 0          | 0    | 0    |
| Initial Fut:                  | 422                   | 74   | 202  | 33          | 41   | 33   | 56         | 894  | 64   | 74         | 1237 | 50   |
| User Adj:                     | 1.00                  | 1.00 | 1.00 | 1.00        | 1.00 | 1.00 | 1.00       | 1.00 | 1.00 | 1.00       | 1.00 | 1.00 |
| PHF Adj:                      | 1.00                  | 1.00 | 1.00 | 1.00        | 1.00 | 1.00 | 1.00       | 1.00 | 1.00 | 1.00       | 1.00 | 1.00 |
| PHF Volume:                   | 422                   | 74   | 202  | 33          | 41   | 33   | 56         | 894  | 64   | 74         | 1237 | 50   |
| Reduct Vol:                   | 0                     | 0    | 0    | 0           | 0    | 0    | 0          | 0    | 0    | 0          | 0    | 0    |
| Reduced Vol:                  | 422                   | 74   | 202  | 33          | 41   | 33   | 56         | 894  | 64   | 74         | 1237 | 50   |
| PCE Adj:                      | 1.00                  | 1.00 | 1.00 | 1.00        | 1.00 | 1.00 | 1.00       | 1.00 | 1.00 | 1.00       | 1.00 | 1.00 |
| MLF Adj:                      | 1.00                  | 1.00 | 1.00 | 1.00        | 1.00 | 1.00 | 1.00       | 1.00 | 1.00 | 1.00       | 1.00 | 1.00 |
| Final Volume:                 | 422                   | 74   | 202  | 33          | 41   | 33   | 56         | 894  | 64   | 74         | 1237 | 50   |
| Saturation Flow Module:       |                       |      |      |             |      |      |            |      |      |            |      |      |
| Sat/Lane:                     | 1900                  | 1900 | 1900 | 1900        | 1900 | 1900 | 1900       | 1900 | 1900 | 1900       | 1900 | 1900 |
| Adjustment:                   | 0.92                  | 1.00 | 0.92 | 0.92        | 0.99 | 0.95 | 0.92       | 0.98 | 0.95 | 0.92       | 0.98 | 0.95 |
| Lanes:                        | 1.00                  | 1.00 | 1.00 | 1.00        | 1.08 | 0.92 | 1.00       | 2.79 | 0.21 | 1.00       | 2.88 | 0.12 |
| Final Sat.:                   | 1750                  | 1900 | 1750 | 1750        | 2049 | 1649 | 1750       | 5225 | 374  | 1750       | 5382 | 218  |
| Capacity Analysis Module:     |                       |      |      |             |      |      |            |      |      |            |      |      |
| Vol/Sat:                      | 0.24                  | 0.04 | 0.12 | 0.02        | 0.02 | 0.02 | 0.03       | 0.17 | 0.17 | 0.04       | 0.23 | 0.23 |
| Crit Moves:                   | ****                  |      |      | ****        |      |      | ****       |      |      | ****       |      |      |
| Green Time:                   | 31.2                  | 24.6 | 24.6 | 16.6        | 10.0 | 10.0 | 7.0        | 25.3 | 25.3 | 11.5       | 29.8 | 29.8 |
| Volume/Cap:                   | 0.69                  | 0.14 | 0.42 | 0.10        | 0.18 | 0.18 | 0.41       | 0.61 | 0.61 | 0.33       | 0.69 | 0.69 |
| Delay/Veh:                    | 28.8                  | 24.7 | 27.3 | 30.6        | 36.5 | 36.5 | 41.6       | 28.8 | 28.8 | 36.6       | 27.3 | 27.3 |
| User DelAdj:                  | 1.00                  | 1.00 | 1.00 | 1.00        | 1.00 | 1.00 | 1.00       | 1.00 | 1.00 | 1.00       | 1.00 | 1.00 |
| AdjDel/Veh:                   | 28.8                  | 24.7 | 27.3 | 30.6        | 36.5 | 36.5 | 41.6       | 28.8 | 28.8 | 36.6       | 27.3 | 27.3 |
| LOS by Move:                  | C                     | C    | C    | C           | D    | D    | D          | C    | C    | D          | C    | C    |
| HCM2k95thQ:                   | 20                    | 3    | 9    | 2           | 2    | 2    | 3          | 14   | 14   | 4          | 19   | 19   |

Note: Queue reported is the number of cars per lane.

BART

Level Of Service Computation Report  
2000 HCM Operations (Future Volume Alternative)  
PM - Cumulative With Project

Intersection #1203: ECR/Lincoln 1203 [Study Int 43]

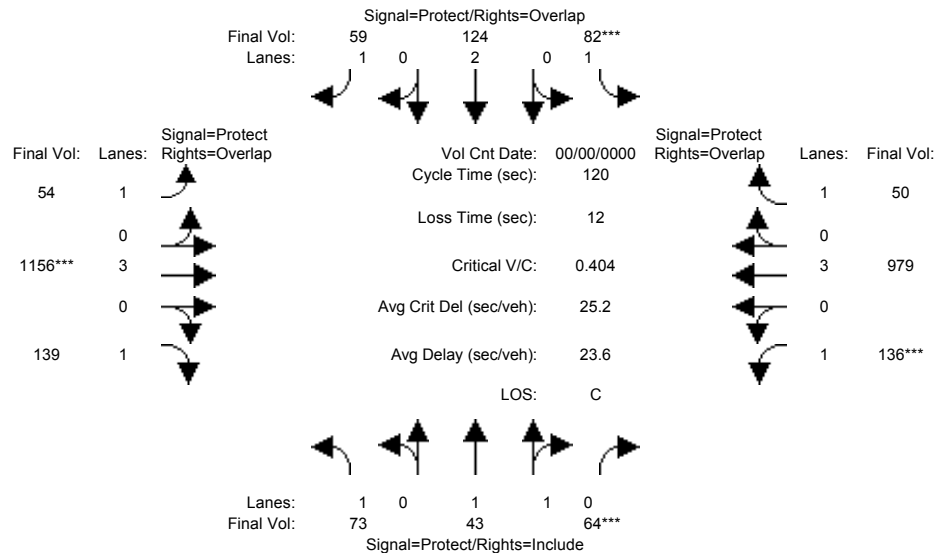

| Approach:   | North Bound |      |      | South Bound |      |      | East Bound |      |      | West Bound |      |      |
|---|-------------|------|------|-------------|------|------|------------|------|------|------------|------|------|
| Movement:   | L           | T    | R    | L           | T    | R    | L          | T    | R    | L          | T    | R    |
| Min. Green:   | 7           | 10   | 10   | 7           | 10   | 10   | 7          | 10   | 10   | 7          | 10   | 10   |
| Y+R:  | 4.0         | 4.0  | 4.0  | 4.0         | 4.0  | 4.0  | 4.0        | 4.0  | 4.0  | 4.0        | 4.0  | 4.0  |
| Volume Module: >> Count Date: 0 0 << 5:00 - 6:00 PM |             |      |      |             |      |      |            |      |      |            |      |      |
| Base Vol:   | 73          | 43   | 64   | 82          | 124  | 59   | 54         | 1156 | 139  | 136        | 979  | 50   |
| Growth Adj:   | 1.00        | 1.00 | 1.00 | 1.00        | 1.00 | 1.00 | 1.00       | 1.00 | 1.00 | 1.00       | 1.00 | 1.00 |
| Initial Bse:  | 73          | 43   | 64   | 82          | 124  | 59   | 54         | 1156 | 139  | 136        | 979  | 50   |
| Added Vol:  | 0           | 0    | 0    | 0           | 0    | 0    | 0          | 0    | 0    | 0          | 0    | 0    |
| PasserByVol:  | 0           | 0    | 0    | 0           | 0    | 0    | 0          | 0    | 0    | 0          | 0    | 0    |
| Initial Fut:  | 73          | 43   | 64   | 82          | 124  | 59   | 54         | 1156 | 139  | 136        | 979  | 50   |
| User Adj:   | 1.00        | 1.00 | 1.00 | 1.00        | 1.00 | 1.00 | 1.00       | 1.00 | 1.00 | 1.00       | 1.00 | 1.00 |
| PHF Adj:  | 1.00        | 1.00 | 1.00 | 1.00        | 1.00 | 1.00 | 1.00       | 1.00 | 1.00 | 1.00       | 1.00 | 1.00 |
| PHF Volume:   | 73          | 43   | 64   | 82          | 124  | 59   | 54         | 1156 | 139  | 136        | 979  | 50   |
| Reduct Vol:   | 0           | 0    | 0    | 0           | 0    | 0    | 0          | 0    | 0    | 0          | 0    | 0    |
| Reduced Vol:  | 73          | 43   | 64   | 82          | 124  | 59   | 54         | 1156 | 139  | 136        | 979  | 50   |
| PCE Adj:  | 1.00        | 1.00 | 1.00 | 1.00        | 1.00 | 1.00 | 1.00       | 1.00 | 1.00 | 1.00       | 1.00 | 1.00 |
| MLF Adj:  | 1.00        | 1.00 | 1.00 | 1.00        | 1.00 | 1.00 | 1.00       | 1.00 | 1.00 | 1.00       | 1.00 | 1.00 |
| Final Volume:                                       | 73          | 43   | 64   | 82          | 124  | 59   | 54         | 1156 | 139  | 136        | 979  | 50   |
| Saturation Flow Module:                             |             |      |      |             |      |      |            |      |      |            |      |      |
| Sat/Lane:   | 1900        | 1900 | 1900 | 1900        | 1900 | 1900 | 1900       | 1900 | 1900 | 1900       | 1900 | 1900 |
| Adjustment:   | 0.92        | 1.00 | 0.92 | 0.92        | 1.00 | 0.92 | 0.92       | 1.00 | 0.92 | 0.92       | 1.00 | 0.92 |
| Lanes:  | 1.00        | 1.00 | 1.00 | 1.00        | 2.00 | 1.00 | 1.00       | 3.00 | 1.00 | 1.00       | 3.00 | 1.00 |
| Final Sat.:   | 1750        | 1900 | 1750 | 1750        | 3800 | 1750 | 1750       | 5700 | 1750 | 1750       | 5700 | 1750 |
| Capacity Analysis Module:                           |             |      |      |             |      |      |            |      |      |            |      |      |
| Vol/Sat:  | 0.04        | 0.02 | 0.04 | 0.05        | 0.03 | 0.03 | 0.03       | 0.20 | 0.08 | 0.08       | 0.17 | 0.03 |
| Crit Moves:   | ****        | **** | **** | ****        | **** | **** | ****       | **** | **** | ****       | **** | **** |
| Green Time:   | 10.2        | 10.9 | 10.9 | 13.9        | 14.6 | 35.7 | 21.1       | 60.2 | 70.4 | 23.1       | 62.1 | 76.0 |
| Volume/Cap:   | 0.49        | 0.25 | 0.40 | 0.40        | 0.27 | 0.11 | 0.18       | 0.40 | 0.14 | 0.40       | 0.33 | 0.05 |
| Delay/Veh:  | 55.0        | 51.1 | 52.5 | 50.5        | 48.2 | 30.8 | 42.3       | 18.8 | 11.2 | 43.3       | 16.9 | 8.3  |
| User DelAdj:  | 1.00        | 1.00 | 1.00 | 1.00        | 1.00 | 1.00 | 1.00       | 1.00 | 1.00 | 1.00       | 1.00 | 1.00 |
| AdjDel/Veh:   | 55.0        | 51.1 | 52.5 | 50.5        | 48.2 | 30.8 | 42.3       | 18.8 | 11.2 | 43.3       | 16.9 | 8.3  |
| LOS by Move:  | D           | D    | D    | D           | D    | C    | D          | B    | B    | D          | B    | A    |
| HCM2k95thQ:   | 6           | 3    | 5    | 7           | 5    | 3    | 3          | 16   | 5    | 9          | 13   | 2    |

Note: Queue reported is the number of cars per lane.

BART

Level Of Service Computation Report  
 2000 HCM Operations (Future Volume Alternative)  
 AM - Cumulative No Project

Intersection #1204: MONROE/EL CAMINO REAL [Study Int 44]

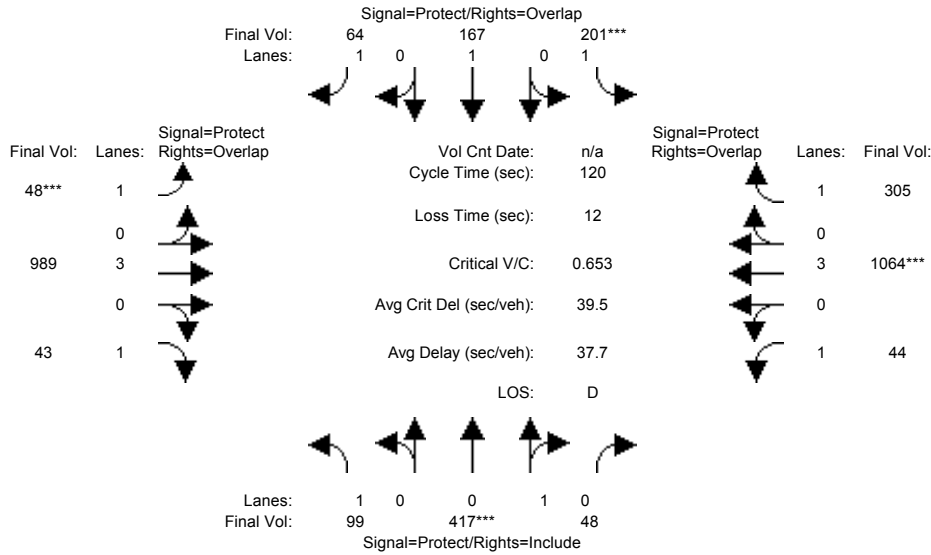

| Approach:                 | North Bound |      |      | South Bound |      |      | East Bound |      |      | West Bound |      |      |
|---------------------------|-------------|------|------|-------------|------|------|------------|------|------|------------|------|------|
| Movement:                 | L           | T    | R    | L           | T    | R    | L          | T    | R    | L          | T    | R    |
| Min. Green:               | 7           | 10   | 10   | 7           | 10   | 10   | 7          | 10   | 10   | 7          | 10   | 10   |
| Y+R:                      | 4.0         | 4.0  | 4.0  | 4.0         | 4.0  | 4.0  | 4.0        | 4.0  | 4.0  | 4.0        | 4.0  | 4.0  |
| Volume Module:            |             |      |      |             |      |      |            |      |      |            |      |      |
| Base Vol:                 | 99          | 417  | 48   | 201         | 167  | 64   | 48         | 989  | 43   | 44         | 1064 | 305  |
| Growth Adj:               | 1.00        | 1.00 | 1.00 | 1.00        | 1.00 | 1.00 | 1.00       | 1.00 | 1.00 | 1.00       | 1.00 | 1.00 |
| Initial Bse:              | 99          | 417  | 48   | 201         | 167  | 64   | 48         | 989  | 43   | 44         | 1064 | 305  |
| Added Vol:                | 0           | 0    | 0    | 0           | 0    | 0    | 0          | 0    | 0    | 0          | 0    | 0    |
| PasserByVol:              | 0           | 0    | 0    | 0           | 0    | 0    | 0          | 0    | 0    | 0          | 0    | 0    |
| Initial Fut:              | 99          | 417  | 48   | 201         | 167  | 64   | 48         | 989  | 43   | 44         | 1064 | 305  |
| User Adj:                 | 1.00        | 1.00 | 1.00 | 1.00        | 1.00 | 1.00 | 1.00       | 1.00 | 1.00 | 1.00       | 1.00 | 1.00 |
| PHF Adj:                  | 1.00        | 1.00 | 1.00 | 1.00        | 1.00 | 1.00 | 1.00       | 1.00 | 1.00 | 1.00       | 1.00 | 1.00 |
| PHF Volume:               | 99          | 417  | 48   | 201         | 167  | 64   | 48         | 989  | 43   | 44         | 1064 | 305  |
| Reduct Vol:               | 0           | 0    | 0    | 0           | 0    | 0    | 0          | 0    | 0    | 0          | 0    | 0    |
| Reduced Vol:              | 99          | 417  | 48   | 201         | 167  | 64   | 48         | 989  | 43   | 44         | 1064 | 305  |
| PCE Adj:                  | 1.00        | 1.00 | 1.00 | 1.00        | 1.00 | 1.00 | 1.00       | 1.00 | 1.00 | 1.00       | 1.00 | 1.00 |
| MLF Adj:                  | 1.00        | 1.00 | 1.00 | 1.00        | 1.00 | 1.00 | 1.00       | 1.00 | 1.00 | 1.00       | 1.00 | 1.00 |
| Final Volume:             | 99          | 417  | 48   | 201         | 167  | 64   | 48         | 989  | 43   | 44         | 1064 | 305  |
| Saturation Flow Module:   |             |      |      |             |      |      |            |      |      |            |      |      |
| Sat/Lane:                 | 1900        | 1900 | 1900 | 1900        | 1900 | 1900 | 1900       | 1900 | 1900 | 1900       | 1900 | 1900 |
| Adjustment:               | 0.92        | 0.95 | 0.95 | 0.92        | 1.00 | 0.92 | 0.92       | 1.00 | 0.92 | 0.92       | 1.00 | 0.92 |
| Lanes:                    | 1.00        | 0.90 | 0.10 | 1.00        | 1.00 | 1.00 | 1.00       | 3.00 | 1.00 | 1.00       | 3.00 | 1.00 |
| Final Sat.:               | 1750        | 1614 | 186  | 1750        | 1900 | 1750 | 1750       | 5700 | 1750 | 1750       | 5700 | 1750 |
| Capacity Analysis Module: |             |      |      |             |      |      |            |      |      |            |      |      |
| Vol/Sat:                  | 0.06        | 0.26 | 0.26 | 0.11        | 0.09 | 0.04 | 0.03       | 0.17 | 0.02 | 0.03       | 0.19 | 0.17 |
| Crit Moves:               | ****        | **** | **** | ****        | **** | **** | ****       | **** | **** | ****       | **** | **** |
| Green Time:               | 26.9        | 46.6 | 46.6 | 20.7        | 40.5 | 47.5 | 7.0        | 30.4 | 57.3 | 10.2       | 33.7 | 54.4 |
| Volume/Cap:               | 0.25        | 0.67 | 0.67 | 0.67        | 0.26 | 0.09 | 0.47       | 0.68 | 0.05 | 0.29       | 0.67 | 0.38 |
| Delay/Veh:                | 38.7        | 32.7 | 32.7 | 51.9        | 29.1 | 22.8 | 58.1       | 41.8 | 16.8 | 52.6       | 39.3 | 22.0 |
| User DelAdj:              | 1.00        | 1.00 | 1.00 | 1.00        | 1.00 | 1.00 | 1.00       | 1.00 | 1.00 | 1.00       | 1.00 | 1.00 |
| AdjDel/Veh:               | 38.7        | 32.7 | 32.7 | 51.9        | 29.1 | 22.8 | 58.1       | 41.8 | 16.8 | 52.6       | 39.3 | 22.0 |
| LOS by Move:              | D           | C    | C    | D           | C    | C    | E          | D    | B    | D          | D    | C    |
| HCM2k95thQ:               | 7           | 27   | 27   | 14          | 8    | 3    | 4          | 20   | 2    | 3          | 20   | 14   |

Note: Queue reported is the number of cars per lane.



BART

Level Of Service Computation Report  
 2000 HCM Operations (Future Volume Alternative)  
 PM - Cumulative No Project

Intersection #1204: MONROE/EL CAMINO REAL [Study Int 44]

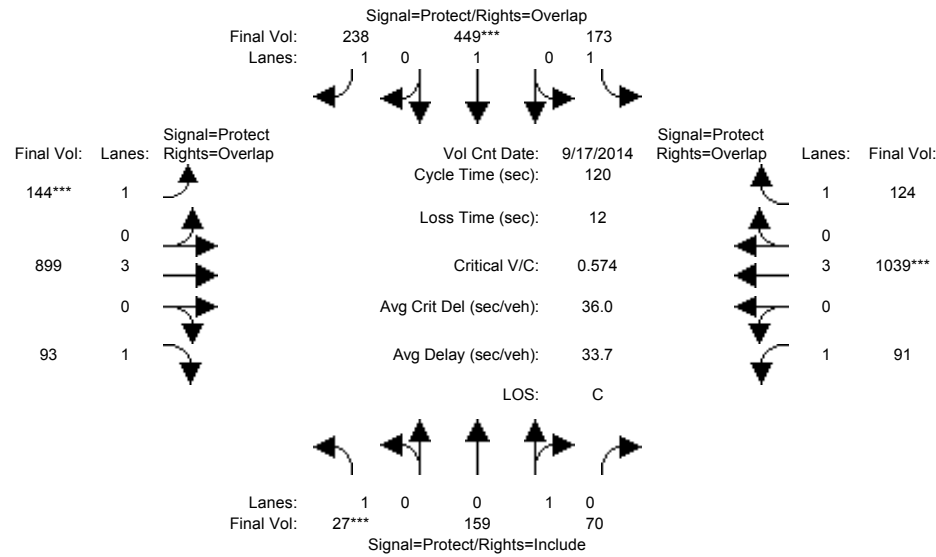

| Approach:                                    | North Bound |      |      | South Bound |      |      | East Bound |      |      | West Bound |      |      |
|--|-------------|------|------|-------------|------|------|------------|------|------|------------|------|------|
| Movement:                                    | L           | T    | R    | L           | T    | R    | L          | T    | R    | L          | T    | R    |
| Min. Green:                                  | 7           | 10   | 10   | 7           | 10   | 10   | 7          | 10   | 10   | 7          | 10   | 10   |
| Y+R:   | 4.0         | 4.0  | 4.0  | 4.0         | 4.0  | 4.0  | 4.0        | 4.0  | 4.0  | 4.0        | 4.0  | 4.0  |
| Volume Module: >> Count Date: 17 Sep 2014 << |             |      |      |             |      |      |            |      |      |            |      |      |
| Base Vol:                                    | 27          | 159  | 70   | 173         | 449  | 238  | 144        | 899  | 93   | 91         | 1039 | 124  |
| Growth Adj:                                  | 1.00        | 1.00 | 1.00 | 1.00        | 1.00 | 1.00 | 1.00       | 1.00 | 1.00 | 1.00       | 1.00 | 1.00 |
| Initial Bse:                                 | 27          | 159  | 70   | 173         | 449  | 238  | 144        | 899  | 93   | 91         | 1039 | 124  |
| Added Vol:                                   | 0           | 0    | 0    | 0           | 0    | 0    | 0          | 0    | 0    | 0          | 0    | 0    |
| PasserByVol:                                 | 0           | 0    | 0    | 0           | 0    | 0    | 0          | 0    | 0    | 0          | 0    | 0    |
| Initial Fut:                                 | 27          | 159  | 70   | 173         | 449  | 238  | 144        | 899  | 93   | 91         | 1039 | 124  |
| User Adj:                                    | 1.00        | 1.00 | 1.00 | 1.00        | 1.00 | 1.00 | 1.00       | 1.00 | 1.00 | 1.00       | 1.00 | 1.00 |
| PHF Adj:                                     | 1.00        | 1.00 | 1.00 | 1.00        | 1.00 | 1.00 | 1.00       | 1.00 | 1.00 | 1.00       | 1.00 | 1.00 |
| PHF Volume:                                  | 27          | 159  | 70   | 173         | 449  | 238  | 144        | 899  | 93   | 91         | 1039 | 124  |
| Reduct Vol:                                  | 0           | 0    | 0    | 0           | 0    | 0    | 0          | 0    | 0    | 0          | 0    | 0    |
| Reduced Vol:                                 | 27          | 159  | 70   | 173         | 449  | 238  | 144        | 899  | 93   | 91         | 1039 | 124  |
| PCE Adj:                                     | 1.00        | 1.00 | 1.00 | 1.00        | 1.00 | 1.00 | 1.00       | 1.00 | 1.00 | 1.00       | 1.00 | 1.00 |
| MLF Adj:                                     | 1.00        | 1.00 | 1.00 | 1.00        | 1.00 | 1.00 | 1.00       | 1.00 | 1.00 | 1.00       | 1.00 | 1.00 |
| Final Volume:                                | 27          | 159  | 70   | 173         | 449  | 238  | 144        | 899  | 93   | 91         | 1039 | 124  |
| Saturation Flow Module:                      |             |      |      |             |      |      |            |      |      |            |      |      |
| Sat/Lane:                                    | 1900        | 1900 | 1900 | 1900        | 1900 | 1900 | 1900       | 1900 | 1900 | 1900       | 1900 | 1900 |
| Adjustment:                                  | 0.92        | 0.95 | 0.95 | 0.92        | 1.00 | 0.92 | 0.92       | 1.00 | 0.92 | 0.92       | 1.00 | 0.92 |
| Lanes:                                       | 1.00        | 0.69 | 0.31 | 1.00        | 1.00 | 1.00 | 1.00       | 3.00 | 1.00 | 1.00       | 3.00 | 1.00 |
| Final Sat.:                                  | 1750        | 1250 | 550  | 1750        | 1900 | 1750 | 1750       | 5700 | 1750 | 1750       | 5700 | 1750 |
| Capacity Analysis Module:                    |             |      |      |             |      |      |            |      |      |            |      |      |
| Vol/Sat:                                     | 0.02        | 0.13 | 0.13 | 0.10        | 0.24 | 0.14 | 0.08       | 0.16 | 0.05 | 0.05       | 0.18 | 0.07 |
| Crit Moves:                                  | ****        | **** | **** | ****        | **** | **** | ****       | **** | **** | ****       | **** | **** |
| Green Time:                                  | 7.0         | 30.8 | 30.8 | 23.9        | 47.7 | 64.2 | 16.6       | 38.9 | 45.9 | 14.4       | 36.8 | 60.7 |
| Volume/Cap:                                  | 0.26        | 0.50 | 0.50 | 0.50        | 0.60 | 0.25 | 0.60       | 0.49 | 0.14 | 0.43       | 0.60 | 0.14 |
| Delay/Veh:                                   | 55.4        | 38.9 | 38.9 | 43.8        | 29.9 | 15.1 | 52.5       | 32.7 | 24.2 | 50.4       | 35.9 | 15.9 |
| User DelAdj:                                 | 1.00        | 1.00 | 1.00 | 1.00        | 1.00 | 1.00 | 1.00       | 1.00 | 1.00 | 1.00       | 1.00 | 1.00 |
| AdjDel/Veh:                                  | 55.4        | 38.9 | 38.9 | 43.8        | 29.9 | 15.1 | 52.5       | 32.7 | 24.2 | 50.4       | 35.9 | 15.9 |
| LOS by Move:                                 | E           | D    | D    | D           | C    | B    | D          | C    | C    | D          | D    | B    |
| HCM2k95thQ:                                  | 3           | 15   | 15   | 12          | 23   | 10   | 11         | 16   | 5    | 6          | 19   | 5    |

Note: Queue reported is the number of cars per lane.

BART

Level Of Service Computation Report  
 2000 HCM Operations (Future Volume Alternative)  
 AM - Cumulative With Project

Intersection #1204: MONROE/EL CAMINO REAL [Study Int 44]

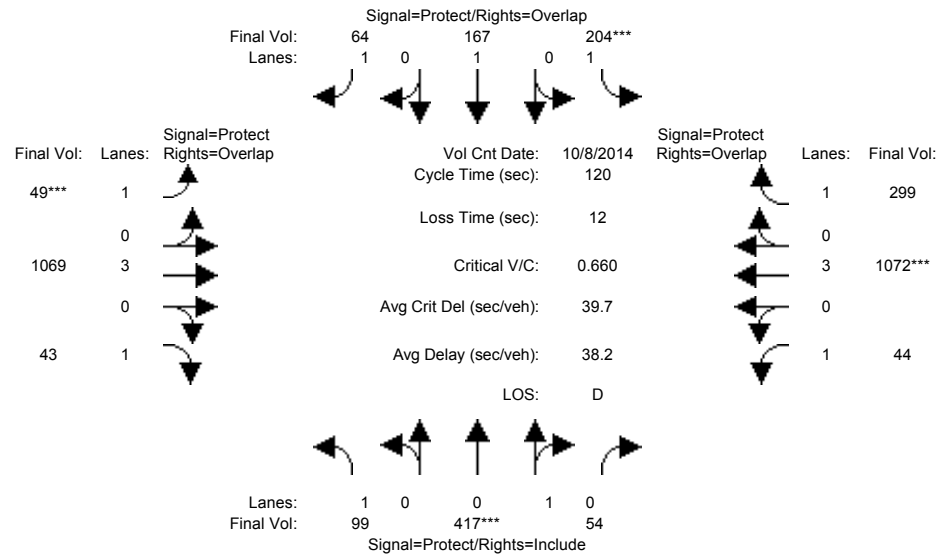

| Approach:                                   | North Bound |      |      | South Bound |      |      | East Bound |      |      | West Bound |      |      |
|---|-------------|------|------|-------------|------|------|------------|------|------|------------|------|------|
| Movement:                                   | L           | T    | R    | L           | T    | R    | L          | T    | R    | L          | T    | R    |
| Min. Green:                                 | 7           | 10   | 10   | 7           | 10   | 10   | 7          | 10   | 10   | 7          | 10   | 10   |
| Y+R:  | 4.0         | 4.0  | 4.0  | 4.0         | 4.0  | 4.0  | 4.0        | 4.0  | 4.0  | 4.0        | 4.0  | 4.0  |
| Volume Module: >> Count Date: 8 Oct 2014 << |             |      |      |             |      |      |            |      |      |            |      |      |
| Base Vol:                                   | 99          | 417  | 54   | 204         | 167  | 64   | 49         | 1069 | 43   | 44         | 1072 | 299  |
| Growth Adj:                                 | 1.00        | 1.00 | 1.00 | 1.00        | 1.00 | 1.00 | 1.00       | 1.00 | 1.00 | 1.00       | 1.00 | 1.00 |
| Initial Bse:                                | 99          | 417  | 54   | 204         | 167  | 64   | 49         | 1069 | 43   | 44         | 1072 | 299  |
| Added Vol:                                  | 0           | 0    | 0    | 0           | 0    | 0    | 0          | 0    | 0    | 0          | 0    | 0    |
| PasserByVol:                                | 0           | 0    | 0    | 0           | 0    | 0    | 0          | 0    | 0    | 0          | 0    | 0    |
| Initial Fut:                                | 99          | 417  | 54   | 204         | 167  | 64   | 49         | 1069 | 43   | 44         | 1072 | 299  |
| User Adj:                                   | 1.00        | 1.00 | 1.00 | 1.00        | 1.00 | 1.00 | 1.00       | 1.00 | 1.00 | 1.00       | 1.00 | 1.00 |
| PHF Adj:                                    | 1.00        | 1.00 | 1.00 | 1.00        | 1.00 | 1.00 | 1.00       | 1.00 | 1.00 | 1.00       | 1.00 | 1.00 |
| PHF Volume:                                 | 99          | 417  | 54   | 204         | 167  | 64   | 49         | 1069 | 43   | 44         | 1072 | 299  |
| Reduct Vol:                                 | 0           | 0    | 0    | 0           | 0    | 0    | 0          | 0    | 0    | 0          | 0    | 0    |
| Reduced Vol:                                | 99          | 417  | 54   | 204         | 167  | 64   | 49         | 1069 | 43   | 44         | 1072 | 299  |
| PCE Adj:                                    | 1.00        | 1.00 | 1.00 | 1.00        | 1.00 | 1.00 | 1.00       | 1.00 | 1.00 | 1.00       | 1.00 | 1.00 |
| MLF Adj:                                    | 1.00        | 1.00 | 1.00 | 1.00        | 1.00 | 1.00 | 1.00       | 1.00 | 1.00 | 1.00       | 1.00 | 1.00 |
| Final Volume:                               | 99          | 417  | 54   | 204         | 167  | 64   | 49         | 1069 | 43   | 44         | 1072 | 299  |
| Saturation Flow Module:                     |             |      |      |             |      |      |            |      |      |            |      |      |
| Sat/Lane:                                   | 1900        | 1900 | 1900 | 1900        | 1900 | 1900 | 1900       | 1900 | 1900 | 1900       | 1900 | 1900 |
| Adjustment:                                 | 0.92        | 0.95 | 0.95 | 0.92        | 1.00 | 0.92 | 0.92       | 1.00 | 0.92 | 0.92       | 1.00 | 0.92 |
| Lanes:                                      | 1.00        | 0.89 | 0.11 | 1.00        | 1.00 | 1.00 | 1.00       | 3.00 | 1.00 | 1.00       | 3.00 | 1.00 |
| Final Sat.:                                 | 1750        | 1594 | 206  | 1750        | 1900 | 1750 | 1750       | 5700 | 1750 | 1750       | 5700 | 1750 |
| Capacity Analysis Module:                   |             |      |      |             |      |      |            |      |      |            |      |      |
| Vol/Sat:                                    | 0.06        | 0.26 | 0.26 | 0.12        | 0.09 | 0.04 | 0.03       | 0.19 | 0.02 | 0.03       | 0.19 | 0.17 |
| Crit Moves:                                 | ****        | **** | **** | ****        | **** | **** | ****       | **** | **** | ****       | **** | **** |
| Green Time:                                 | 26.9        | 46.7 | 46.7 | 20.8        | 40.5 | 47.5 | 7.0        | 30.9 | 57.8 | 9.6        | 33.5 | 54.3 |
| Volume/Cap:                                 | 0.25        | 0.67 | 0.67 | 0.67        | 0.26 | 0.09 | 0.48       | 0.73 | 0.05 | 0.31       | 0.67 | 0.38 |
| Delay/Veh:                                  | 38.6        | 32.9 | 32.9 | 52.3        | 29.1 | 22.8 | 58.3       | 42.6 | 16.5 | 53.4       | 39.5 | 22.0 |
| User DelAdj:                                | 1.00        | 1.00 | 1.00 | 1.00        | 1.00 | 1.00 | 1.00       | 1.00 | 1.00 | 1.00       | 1.00 | 1.00 |
| AdjDel/Veh:                                 | 38.6        | 32.9 | 32.9 | 52.3        | 29.1 | 22.8 | 58.3       | 42.6 | 16.5 | 53.4       | 39.5 | 22.0 |
| LOS by Move:                                | D           | C    | C    | D           | C    | C    | E          | D    | B    | D          | D    | C    |
| HCM2k95thQ:                                 | 7           | 27   | 27   | 15          | 8    | 3    | 4          | 22   | 2    | 3          | 20   | 14   |

Note: Queue reported is the number of cars per lane.

BART

Level Of Service Computation Report  
2000 HCM Operations (Future Volume Alternative)  
PM - Cumulative With Project

Intersection #1204: MONROE/EL CAMINO REAL [Study Int 44]

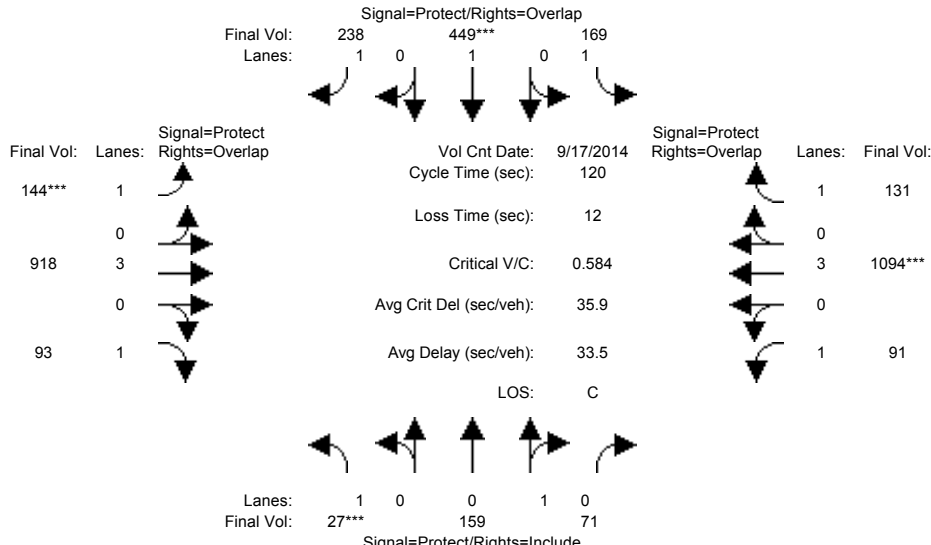

| Approach:                                    | North Bound |      |      | South Bound |      |      | East Bound |      |      | West Bound |      |      |
|--|-------------|------|------|-------------|------|------|------------|------|------|------------|------|------|
| Movement:                                    | L           | T    | R    | L           | T    | R    | L          | T    | R    | L          | T    | R    |
| Min. Green:                                  | 7           | 10   | 10   | 7           | 10   | 10   | 7          | 10   | 10   | 7          | 10   | 10   |
| Y+R:   | 4.0         | 4.0  | 4.0  | 4.0         | 4.0  | 4.0  | 4.0        | 4.0  | 4.0  | 4.0        | 4.0  | 4.0  |
| Volume Module: >> Count Date: 17 Sep 2014 << |             |      |      |             |      |      |            |      |      |            |      |      |
| Base Vol:                                    | 27          | 159  | 71   | 169         | 449  | 238  | 144        | 918  | 93   | 91         | 1094 | 131  |
| Growth Adj:                                  | 1.00        | 1.00 | 1.00 | 1.00        | 1.00 | 1.00 | 1.00       | 1.00 | 1.00 | 1.00       | 1.00 | 1.00 |
| Initial Bse:                                 | 27          | 159  | 71   | 169         | 449  | 238  | 144        | 918  | 93   | 91         | 1094 | 131  |
| Added Vol:                                   | 0           | 0    | 0    | 0           | 0    | 0    | 0          | 0    | 0    | 0          | 0    | 0    |
| PasserByVol:                                 | 0           | 0    | 0    | 0           | 0    | 0    | 0          | 0    | 0    | 0          | 0    | 0    |
| Initial Fut:                                 | 27          | 159  | 71   | 169         | 449  | 238  | 144        | 918  | 93   | 91         | 1094 | 131  |
| User Adj:                                    | 1.00        | 1.00 | 1.00 | 1.00        | 1.00 | 1.00 | 1.00       | 1.00 | 1.00 | 1.00       | 1.00 | 1.00 |
| PHF Adj:                                     | 1.00        | 1.00 | 1.00 | 1.00        | 1.00 | 1.00 | 1.00       | 1.00 | 1.00 | 1.00       | 1.00 | 1.00 |
| PHF Volume:                                  | 27          | 159  | 71   | 169         | 449  | 238  | 144        | 918  | 93   | 91         | 1094 | 131  |
| Reduct Vol:                                  | 0           | 0    | 0    | 0           | 0    | 0    | 0          | 0    | 0    | 0          | 0    | 0    |
| Reduced Vol:                                 | 27          | 159  | 71   | 169         | 449  | 238  | 144        | 918  | 93   | 91         | 1094 | 131  |
| PCE Adj:                                     | 1.00        | 1.00 | 1.00 | 1.00        | 1.00 | 1.00 | 1.00       | 1.00 | 1.00 | 1.00       | 1.00 | 1.00 |
| MLF Adj:                                     | 1.00        | 1.00 | 1.00 | 1.00        | 1.00 | 1.00 | 1.00       | 1.00 | 1.00 | 1.00       | 1.00 | 1.00 |
| Final Volume:                                | 27          | 159  | 71   | 169         | 449  | 238  | 144        | 918  | 93   | 91         | 1094 | 131  |
| Saturation Flow Module:                      |             |      |      |             |      |      |            |      |      |            |      |      |
| Sat/Lane:                                    | 1900        | 1900 | 1900 | 1900        | 1900 | 1900 | 1900       | 1900 | 1900 | 1900       | 1900 | 1900 |
| Adjustment:                                  | 0.92        | 0.95 | 0.95 | 0.92        | 1.00 | 0.92 | 0.92       | 1.00 | 0.92 | 0.92       | 1.00 | 0.92 |
| Lanes:                                       | 1.00        | 0.69 | 0.31 | 1.00        | 1.00 | 1.00 | 1.00       | 3.00 | 1.00 | 1.00       | 3.00 | 1.00 |
| Final Sat.:                                  | 1750        | 1244 | 556  | 1750        | 1900 | 1750 | 1750       | 5700 | 1750 | 1750       | 5700 | 1750 |
| Capacity Analysis Module:                    |             |      |      |             |      |      |            |      |      |            |      |      |
| Vol/Sat:                                     | 0.02        | 0.13 | 0.13 | 0.10        | 0.24 | 0.14 | 0.08       | 0.16 | 0.05 | 0.05       | 0.19 | 0.07 |
| Crit Moves:                                  | ****        | **** | **** | ****        | **** | **** | ****       | **** | **** | ****       | **** | **** |
| Green Time:                                  | 7.0         | 30.6 | 30.6 | 23.1        | 46.8 | 63.0 | 16.3       | 39.8 | 46.8 | 14.4       | 38.0 | 61.1 |
| Volume/Cap:                                  | 0.26        | 0.50 | 0.50 | 0.50        | 0.61 | 0.26 | 0.61       | 0.49 | 0.14 | 0.43       | 0.61 | 0.15 |
| Delay/Veh:                                   | 55.4        | 39.0 | 39.0 | 44.5        | 30.7 | 15.8 | 53.3       | 32.1 | 23.7 | 50.4       | 35.3 | 15.7 |
| User DelAdj:                                 | 1.00        | 1.00 | 1.00 | 1.00        | 1.00 | 1.00 | 1.00       | 1.00 | 1.00 | 1.00       | 1.00 | 1.00 |
| AdjDel/Veh:                                  | 55.4        | 39.0 | 39.0 | 44.5        | 30.7 | 15.8 | 53.3       | 32.1 | 23.7 | 50.4       | 35.3 | 15.7 |
| LOS by Move:                                 | E           | D    | D    | D           | C    | B    | D          | C    | C    | D          | D    | B    |
| HCM2k95thQ:                                  | 3           | 15   | 15   | 11          | 23   | 10   | 11         | 16   | 5    | 6          | 20   | 5    |

Note: Queue reported is the number of cars per lane.

BART

Level Of Service Computation Report  
 2000 HCM Operations (Future Volume Alternative)  
 AM - Cumulative No Project

Intersection #1205: SCOTT/EL CAMINO REAL [Study Int 42]

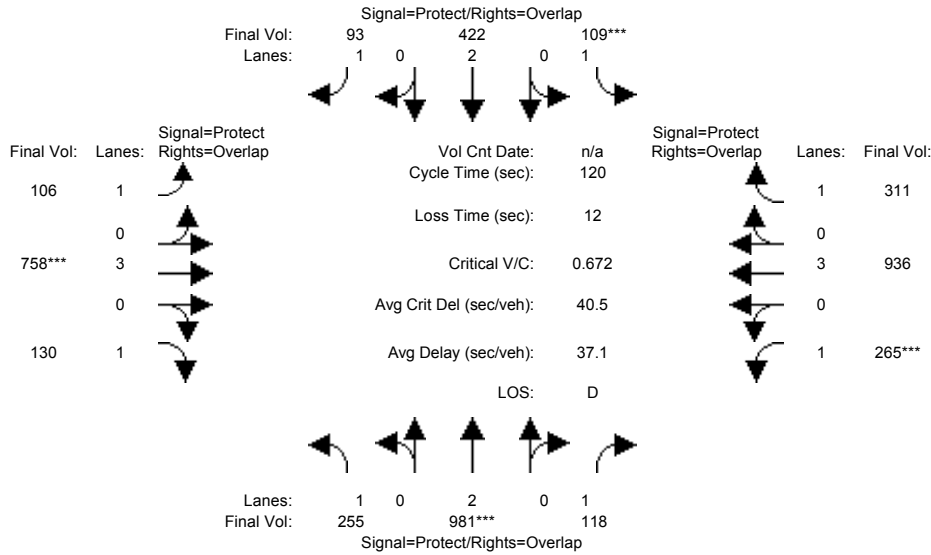

| Approach:                 | North Bound |      |      | South Bound |      |      | East Bound |      |      | West Bound |      |      |
|---------------------------|-------------|------|------|-------------|------|------|------------|------|------|------------|------|------|
| Movement:                 | L           | T    | R    | L           | T    | R    | L          | T    | R    | L          | T    | R    |
| Min. Green:               | 7           | 10   | 10   | 7           | 10   | 10   | 7          | 10   | 10   | 7          | 10   | 10   |
| Y+R:                      | 4.0         | 4.0  | 4.0  | 4.0         | 4.0  | 4.0  | 4.0        | 4.0  | 4.0  | 4.0        | 4.0  | 4.0  |
| Volume Module:            |             |      |      |             |      |      |            |      |      |            |      |      |
| Base Vol:                 | 255         | 981  | 118  | 109         | 422  | 93   | 106        | 758  | 130  | 265        | 936  | 311  |
| Growth Adj:               | 1.00        | 1.00 | 1.00 | 1.00        | 1.00 | 1.00 | 1.00       | 1.00 | 1.00 | 1.00       | 1.00 | 1.00 |
| Initial Bse:              | 255         | 981  | 118  | 109         | 422  | 93   | 106        | 758  | 130  | 265        | 936  | 311  |
| Added Vol:                | 0           | 0    | 0    | 0           | 0    | 0    | 0          | 0    | 0    | 0          | 0    | 0    |
| PasserByVol:              | 0           | 0    | 0    | 0           | 0    | 0    | 0          | 0    | 0    | 0          | 0    | 0    |
| Initial Fut:              | 255         | 981  | 118  | 109         | 422  | 93   | 106        | 758  | 130  | 265        | 936  | 311  |
| User Adj:                 | 1.00        | 1.00 | 1.00 | 1.00        | 1.00 | 1.00 | 1.00       | 1.00 | 1.00 | 1.00       | 1.00 | 1.00 |
| PHF Adj:                  | 1.00        | 1.00 | 1.00 | 1.00        | 1.00 | 1.00 | 1.00       | 1.00 | 1.00 | 1.00       | 1.00 | 1.00 |
| PHF Volume:               | 255         | 981  | 118  | 109         | 422  | 93   | 106        | 758  | 130  | 265        | 936  | 311  |
| Reduct Vol:               | 0           | 0    | 0    | 0           | 0    | 0    | 0          | 0    | 0    | 0          | 0    | 0    |
| Reduced Vol:              | 255         | 981  | 118  | 109         | 422  | 93   | 106        | 758  | 130  | 265        | 936  | 311  |
| PCE Adj:                  | 1.00        | 1.00 | 1.00 | 1.00        | 1.00 | 1.00 | 1.00       | 1.00 | 1.00 | 1.00       | 1.00 | 1.00 |
| MLF Adj:                  | 1.00        | 1.00 | 1.00 | 1.00        | 1.00 | 1.00 | 1.00       | 1.00 | 1.00 | 1.00       | 1.00 | 1.00 |
| Final Volume:             | 255         | 981  | 118  | 109         | 422  | 93   | 106        | 758  | 130  | 265        | 936  | 311  |
| Saturation Flow Module:   |             |      |      |             |      |      |            |      |      |            |      |      |
| Sat/Lane:                 | 1900        | 1900 | 1900 | 1900        | 1900 | 1900 | 1900       | 1900 | 1900 | 1900       | 1900 | 1900 |
| Adjustment:               | 0.92        | 1.00 | 0.92 | 0.92        | 1.00 | 0.92 | 0.92       | 1.00 | 0.92 | 0.92       | 1.00 | 0.92 |
| Lanes:                    | 1.00        | 2.00 | 1.00 | 1.00        | 2.00 | 1.00 | 1.00       | 3.00 | 1.00 | 1.00       | 3.00 | 1.00 |
| Final Sat.:               | 1750        | 3800 | 1750 | 1750        | 3800 | 1750 | 1750       | 5700 | 1750 | 1750       | 5700 | 1750 |
| Capacity Analysis Module: |             |      |      |             |      |      |            |      |      |            |      |      |
| Vol/Sat:                  | 0.15        | 0.26 | 0.07 | 0.06        | 0.11 | 0.05 | 0.06       | 0.13 | 0.07 | 0.15       | 0.16 | 0.18 |
| Crit Moves:               | ****        | **** | **** | ****        | **** | **** | ****       | **** | **** | ****       | **** | **** |
| Green Time:               | 32.5        | 46.1 | 73.1 | 11.1        | 24.7 | 38.4 | 13.7       | 23.7 | 56.2 | 27.0       | 37.1 | 48.2 |
| Volume/Cap:               | 0.54        | 0.67 | 0.11 | 0.67        | 0.54 | 0.17 | 0.53       | 0.67 | 0.16 | 0.67       | 0.53 | 0.44 |
| Delay/Veh:                | 38.6        | 31.9 | 9.9  | 63.2        | 43.3 | 29.4 | 52.9       | 46.1 | 18.4 | 46.9       | 34.6 | 26.6 |
| User DelAdj:              | 1.00        | 1.00 | 1.00 | 1.00        | 1.00 | 1.00 | 1.00       | 1.00 | 1.00 | 1.00       | 1.00 | 1.00 |
| AdjDel/Veh:               | 38.6        | 31.9 | 9.9  | 63.2        | 43.3 | 29.4 | 52.9       | 46.1 | 18.4 | 46.9       | 34.6 | 26.6 |
| LOS by Move:              | D           | C    | A    | E           | D    | C    | D          | D    | B    | D          | C    | C    |
| HCM2k95thQ:               | 16          | 26   | 4    | 9           | 13   | 5    | 8          | 16   | 6    | 17         | 17   | 16   |

Note: Queue reported is the number of cars per lane.

BART

Level Of Service Computation Report  
2000 HCM Operations (Future Volume Alternative)  
PM - Cumulative No Project

Intersection #1205: SCOTT/EL CAMINO REAL [Study Int 42]

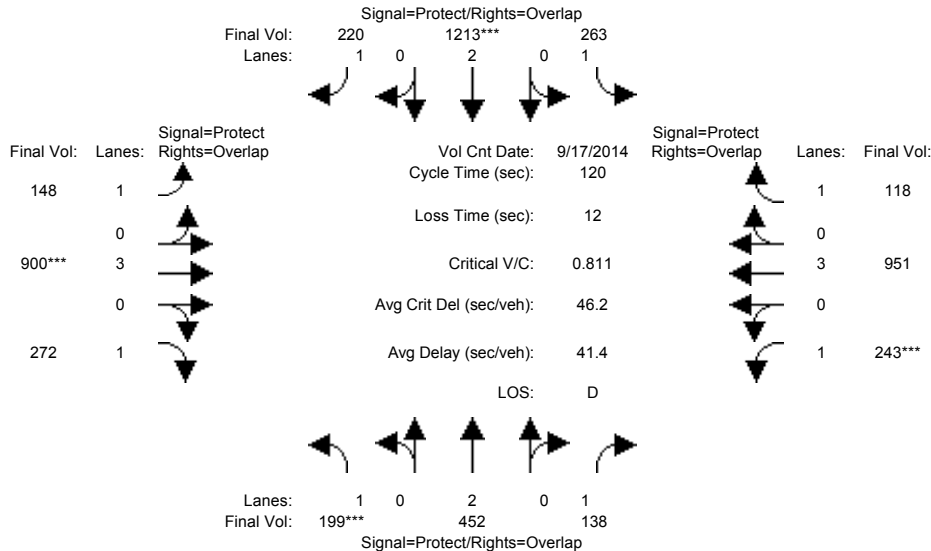

| Approach:                                    | North Bound |      |      | South Bound |      |      | East Bound |      |      | West Bound |      |      |
|--|-------------|------|------|-------------|------|------|------------|------|------|------------|------|------|
| Movement:                                    | L           | T    | R    | L           | T    | R    | L          | T    | R    | L          | T    | R    |
| Min. Green:                                  | 7           | 10   | 10   | 7           | 10   | 10   | 7          | 10   | 10   | 7          | 10   | 10   |
| Y+R:   | 4.0         | 4.0  | 4.0  | 4.0         | 4.0  | 4.0  | 4.0        | 4.0  | 4.0  | 4.0        | 4.0  | 4.0  |
| -----  |             |      |      |             |      |      |            |      |      |            |      |      |
| Volume Module: >> Count Date: 17 Sep 2014 << |             |      |      |             |      |      |            |      |      |            |      |      |
| Base Vol:                                    | 199         | 452  | 138  | 263         | 1213 | 220  | 148        | 900  | 272  | 243        | 951  | 118  |
| Growth Adj:                                  | 1.00        | 1.00 | 1.00 | 1.00        | 1.00 | 1.00 | 1.00       | 1.00 | 1.00 | 1.00       | 1.00 | 1.00 |
| Initial Bse:                                 | 199         | 452  | 138  | 263         | 1213 | 220  | 148        | 900  | 272  | 243        | 951  | 118  |
| Added Vol:                                   | 0           | 0    | 0    | 0           | 0    | 0    | 0          | 0    | 0    | 0          | 0    | 0    |
| PasserByVol:                                 | 0           | 0    | 0    | 0           | 0    | 0    | 0          | 0    | 0    | 0          | 0    | 0    |
| Initial Fut:                                 | 199         | 452  | 138  | 263         | 1213 | 220  | 148        | 900  | 272  | 243        | 951  | 118  |
| User Adj:                                    | 1.00        | 1.00 | 1.00 | 1.00        | 1.00 | 1.00 | 1.00       | 1.00 | 1.00 | 1.00       | 1.00 | 1.00 |
| PHF Adj:                                     | 1.00        | 1.00 | 1.00 | 1.00        | 1.00 | 1.00 | 1.00       | 1.00 | 1.00 | 1.00       | 1.00 | 1.00 |
| PHF Volume:                                  | 199         | 452  | 138  | 263         | 1213 | 220  | 148        | 900  | 272  | 243        | 951  | 118  |
| Reduct Vol:                                  | 0           | 0    | 0    | 0           | 0    | 0    | 0          | 0    | 0    | 0          | 0    | 0    |
| Reduced Vol:                                 | 199         | 452  | 138  | 263         | 1213 | 220  | 148        | 900  | 272  | 243        | 951  | 118  |
| PCE Adj:                                     | 1.00        | 1.00 | 1.00 | 1.00        | 1.00 | 1.00 | 1.00       | 1.00 | 1.00 | 1.00       | 1.00 | 1.00 |
| MLF Adj:                                     | 1.00        | 1.00 | 1.00 | 1.00        | 1.00 | 1.00 | 1.00       | 1.00 | 1.00 | 1.00       | 1.00 | 1.00 |
| Final Volume:                                | 199         | 452  | 138  | 263         | 1213 | 220  | 148        | 900  | 272  | 243        | 951  | 118  |
| -----  |             |      |      |             |      |      |            |      |      |            |      |      |
| Saturation Flow Module:                      |             |      |      |             |      |      |            |      |      |            |      |      |
| Sat/Lane:                                    | 1900        | 1900 | 1900 | 1900        | 1900 | 1900 | 1900       | 1900 | 1900 | 1900       | 1900 | 1900 |
| Adjustment:                                  | 0.92        | 1.00 | 0.92 | 0.92        | 1.00 | 0.92 | 0.92       | 1.00 | 0.92 | 0.92       | 1.00 | 0.92 |
| Lanes:                                       | 1.00        | 2.00 | 1.00 | 1.00        | 2.00 | 1.00 | 1.00       | 3.00 | 1.00 | 1.00       | 3.00 | 1.00 |
| Final Sat.:                                  | 1750        | 3800 | 1750 | 1750        | 3800 | 1750 | 1750       | 5700 | 1750 | 1750       | 5700 | 1750 |
| -----  |             |      |      |             |      |      |            |      |      |            |      |      |
| Capacity Analysis Module:                    |             |      |      |             |      |      |            |      |      |            |      |      |
| Vol/Sat:                                     | 0.11        | 0.12 | 0.08 | 0.15        | 0.32 | 0.13 | 0.08       | 0.16 | 0.16 | 0.14       | 0.17 | 0.07 |
| Crit Moves:                                  | ****        |      |      | ****        |      |      | ****       |      |      | ****       |      |      |
| Green Time:                                  | 16.8        | 28.3 | 48.9 | 35.8        | 47.2 | 62.0 | 14.8       | 23.4 | 40.2 | 20.6       | 29.1 | 64.9 |
| Volume/Cap:                                  | 0.81        | 0.50 | 0.19 | 0.50        | 0.81 | 0.24 | 0.69       | 0.81 | 0.46 | 0.81       | 0.69 | 0.12 |
| Delay/Veh:                                   | 68.1        | 40.2 | 23.0 | 35.6        | 35.8 | 16.2 | 59.3       | 50.8 | 32.0 | 63.1       | 42.7 | 13.6 |
| User DelAdj:                                 | 1.00        | 1.00 | 1.00 | 1.00        | 1.00 | 1.00 | 1.00       | 1.00 | 1.00 | 1.00       | 1.00 | 1.00 |
| AdjDel/Veh:                                  | 68.1        | 40.2 | 23.0 | 35.6        | 35.8 | 16.2 | 59.3       | 50.8 | 32.0 | 63.1       | 42.7 | 13.6 |
| LOS by Move:                                 | E           | D    | C    | D           | D    | B    | E          | D    | C    | E          | D    | B    |
| HCM2k95thQ:                                  | 16          | 13   | 7    | 16          | 35   | 9    | 11         | 20   | 16   | 18         | 19   | 4    |

Note: Queue reported is the number of cars per lane.

BART

Level Of Service Computation Report  
2000 HCM Operations (Future Volume Alternative)  
AM - Cumulative With Project

Intersection #1205: SCOTT/EL CAMINO REAL [Study Int 42]

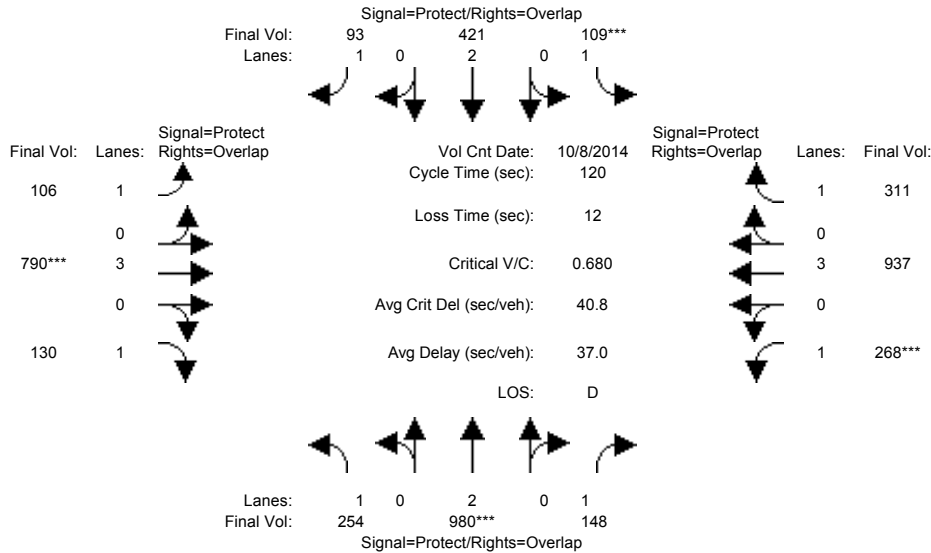

| Approach:                                   | North Bound |      |      | South Bound |      |      | East Bound |      |      | West Bound |      |      |
|---|-------------|------|------|-------------|------|------|------------|------|------|------------|------|------|
| Movement:                                   | L           | T    | R    | L           | T    | R    | L          | T    | R    | L          | T    | R    |
| Min. Green:                                 | 7           | 10   | 10   | 7           | 10   | 10   | 7          | 10   | 10   | 7          | 10   | 10   |
| Y+R:  | 4.0         | 4.0  | 4.0  | 4.0         | 4.0  | 4.0  | 4.0        | 4.0  | 4.0  | 4.0        | 4.0  | 4.0  |
| Volume Module: >> Count Date: 8 Oct 2014 << |             |      |      |             |      |      |            |      |      |            |      |      |
| Base Vol:                                   | 254         | 980  | 148  | 109         | 421  | 93   | 106        | 790  | 130  | 268        | 937  | 311  |
| Growth Adj:                                 | 1.00        | 1.00 | 1.00 | 1.00        | 1.00 | 1.00 | 1.00       | 1.00 | 1.00 | 1.00       | 1.00 | 1.00 |
| Initial Bse:                                | 254         | 980  | 148  | 109         | 421  | 93   | 106        | 790  | 130  | 268        | 937  | 311  |
| Added Vol:                                  | 0           | 0    | 0    | 0           | 0    | 0    | 0          | 0    | 0    | 0          | 0    | 0    |
| PasserByVol:                                | 0           | 0    | 0    | 0           | 0    | 0    | 0          | 0    | 0    | 0          | 0    | 0    |
| Initial Fut:                                | 254         | 980  | 148  | 109         | 421  | 93   | 106        | 790  | 130  | 268        | 937  | 311  |
| User Adj:                                   | 1.00        | 1.00 | 1.00 | 1.00        | 1.00 | 1.00 | 1.00       | 1.00 | 1.00 | 1.00       | 1.00 | 1.00 |
| PHF Adj:                                    | 1.00        | 1.00 | 1.00 | 1.00        | 1.00 | 1.00 | 1.00       | 1.00 | 1.00 | 1.00       | 1.00 | 1.00 |
| PHF Volume:                                 | 254         | 980  | 148  | 109         | 421  | 93   | 106        | 790  | 130  | 268        | 937  | 311  |
| Reduct Vol:                                 | 0           | 0    | 0    | 0           | 0    | 0    | 0          | 0    | 0    | 0          | 0    | 0    |
| Reduced Vol:                                | 254         | 980  | 148  | 109         | 421  | 93   | 106        | 790  | 130  | 268        | 937  | 311  |
| PCE Adj:                                    | 1.00        | 1.00 | 1.00 | 1.00        | 1.00 | 1.00 | 1.00       | 1.00 | 1.00 | 1.00       | 1.00 | 1.00 |
| MLF Adj:                                    | 1.00        | 1.00 | 1.00 | 1.00        | 1.00 | 1.00 | 1.00       | 1.00 | 1.00 | 1.00       | 1.00 | 1.00 |
| Final Volume:                               | 254         | 980  | 148  | 109         | 421  | 93   | 106        | 790  | 130  | 268        | 937  | 311  |
| Saturation Flow Module:                     |             |      |      |             |      |      |            |      |      |            |      |      |
| Sat/Lane:                                   | 1900        | 1900 | 1900 | 1900        | 1900 | 1900 | 1900       | 1900 | 1900 | 1900       | 1900 | 1900 |
| Adjustment:                                 | 0.92        | 1.00 | 0.92 | 0.92        | 1.00 | 0.92 | 0.92       | 1.00 | 0.92 | 0.92       | 1.00 | 0.92 |
| Lanes:                                      | 1.00        | 2.00 | 1.00 | 1.00        | 2.00 | 1.00 | 1.00       | 3.00 | 1.00 | 1.00       | 3.00 | 1.00 |
| Final Sat.:                                 | 1750        | 3800 | 1750 | 1750        | 3800 | 1750 | 1750       | 5700 | 1750 | 1750       | 5700 | 1750 |
| Capacity Analysis Module:                   |             |      |      |             |      |      |            |      |      |            |      |      |
| Vol/Sat:                                    | 0.15        | 0.26 | 0.08 | 0.06        | 0.11 | 0.05 | 0.06       | 0.14 | 0.07 | 0.15       | 0.16 | 0.18 |
| Crit Moves:                                 | ****        | **** | **** | ****        | **** | **** | ****       | **** | **** | ****       | **** | **** |
| Green Time:                                 | 32.0        | 45.5 | 72.5 | 11.0        | 24.5 | 38.3 | 13.9       | 24.5 | 56.5 | 27.0       | 37.6 | 48.6 |
| Volume/Cap:                                 | 0.54        | 0.68 | 0.14 | 0.68        | 0.54 | 0.17 | 0.52       | 0.68 | 0.16 | 0.68       | 0.52 | 0.44 |
| Delay/Veh:                                  | 39.0        | 32.5 | 10.3 | 64.0        | 43.6 | 29.5 | 52.5       | 45.8 | 18.2 | 47.3       | 34.1 | 26.3 |
| User DelAdj:                                | 1.00        | 1.00 | 1.00 | 1.00        | 1.00 | 1.00 | 1.00       | 1.00 | 1.00 | 1.00       | 1.00 | 1.00 |
| AdjDel/Veh:                                 | 39.0        | 32.5 | 10.3 | 64.0        | 43.6 | 29.5 | 52.5       | 45.8 | 18.2 | 47.3       | 34.1 | 26.3 |
| LOS by Move:                                | D           | C    | B    | E           | D    | C    | D          | D    | B    | D          | C    | C    |
| HCM2k95thQ:                                 | 16          | 26   | 5    | 9           | 13   | 5    | 8          | 17   | 6    | 18         | 17   | 16   |

Note: Queue reported is the number of cars per lane.

BART

Level Of Service Computation Report  
2000 HCM Operations (Future Volume Alternative)  
PM - Cumulative With Project

Intersection #1205: SCOTT/EL CAMINO REAL [Study Int 42]

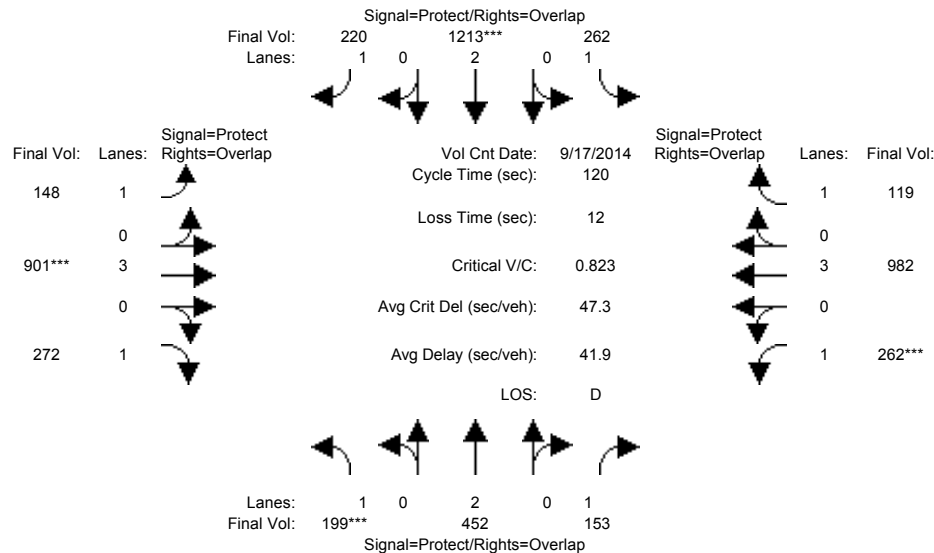

| Approach:                                    | North Bound |      |      | South Bound |      |      | East Bound |      |      | West Bound |      |      |
|--|-------------|------|------|-------------|------|------|------------|------|------|------------|------|------|
| Movement:                                    | L           | T    | R    | L           | T    | R    | L          | T    | R    | L          | T    | R    |
| Min. Green:                                  | 7           | 10   | 10   | 7           | 10   | 10   | 7          | 10   | 10   | 7          | 10   | 10   |
| Y+R:   | 4.0         | 4.0  | 4.0  | 4.0         | 4.0  | 4.0  | 4.0        | 4.0  | 4.0  | 4.0        | 4.0  | 4.0  |
| Volume Module: >> Count Date: 17 Sep 2014 << |             |      |      |             |      |      |            |      |      |            |      |      |
| Base Vol:                                    | 199         | 452  | 153  | 262         | 1213 | 220  | 148        | 901  | 272  | 262        | 982  | 119  |
| Growth Adj:                                  | 1.00        | 1.00 | 1.00 | 1.00        | 1.00 | 1.00 | 1.00       | 1.00 | 1.00 | 1.00       | 1.00 | 1.00 |
| Initial Bse:                                 | 199         | 452  | 153  | 262         | 1213 | 220  | 148        | 901  | 272  | 262        | 982  | 119  |
| Added Vol:                                   | 0           | 0    | 0    | 0           | 0    | 0    | 0          | 0    | 0    | 0          | 0    | 0    |
| PasserByVol:                                 | 0           | 0    | 0    | 0           | 0    | 0    | 0          | 0    | 0    | 0          | 0    | 0    |
| Initial Fut:                                 | 199         | 452  | 153  | 262         | 1213 | 220  | 148        | 901  | 272  | 262        | 982  | 119  |
| User Adj:                                    | 1.00        | 1.00 | 1.00 | 1.00        | 1.00 | 1.00 | 1.00       | 1.00 | 1.00 | 1.00       | 1.00 | 1.00 |
| PHF Adj:                                     | 1.00        | 1.00 | 1.00 | 1.00        | 1.00 | 1.00 | 1.00       | 1.00 | 1.00 | 1.00       | 1.00 | 1.00 |
| PHF Volume:                                  | 199         | 452  | 153  | 262         | 1213 | 220  | 148        | 901  | 272  | 262        | 982  | 119  |
| Reduct Vol:                                  | 0           | 0    | 0    | 0           | 0    | 0    | 0          | 0    | 0    | 0          | 0    | 0    |
| Reduced Vol:                                 | 199         | 452  | 153  | 262         | 1213 | 220  | 148        | 901  | 272  | 262        | 982  | 119  |
| PCE Adj:                                     | 1.00        | 1.00 | 1.00 | 1.00        | 1.00 | 1.00 | 1.00       | 1.00 | 1.00 | 1.00       | 1.00 | 1.00 |
| MLF Adj:                                     | 1.00        | 1.00 | 1.00 | 1.00        | 1.00 | 1.00 | 1.00       | 1.00 | 1.00 | 1.00       | 1.00 | 1.00 |
| Final Volume:                                | 199         | 452  | 153  | 262         | 1213 | 220  | 148        | 901  | 272  | 262        | 982  | 119  |
| Saturation Flow Module:                      |             |      |      |             |      |      |            |      |      |            |      |      |
| Sat/Lane:                                    | 1900        | 1900 | 1900 | 1900        | 1900 | 1900 | 1900       | 1900 | 1900 | 1900       | 1900 | 1900 |
| Adjustment:                                  | 0.92        | 1.00 | 0.92 | 0.92        | 1.00 | 0.92 | 0.92       | 1.00 | 0.92 | 0.92       | 1.00 | 0.92 |
| Lanes:                                       | 1.00        | 2.00 | 1.00 | 1.00        | 2.00 | 1.00 | 1.00       | 3.00 | 1.00 | 1.00       | 3.00 | 1.00 |
| Final Sat.:                                  | 1750        | 3800 | 1750 | 1750        | 3800 | 1750 | 1750       | 5700 | 1750 | 1750       | 5700 | 1750 |
| Capacity Analysis Module:                    |             |      |      |             |      |      |            |      |      |            |      |      |
| Vol/Sat:                                     | 0.11        | 0.12 | 0.09 | 0.15        | 0.32 | 0.13 | 0.08       | 0.16 | 0.16 | 0.15       | 0.17 | 0.07 |
| Crit Moves:                                  | ****        |      |      | ****        |      |      | ****       |      |      | ****       |      |      |
| Green Time:                                  | 16.6        | 27.9 | 49.8 | 35.2        | 46.5 | 61.3 | 14.8       | 23.0 | 39.6 | 21.8       | 30.1 | 65.3 |
| Volume/Cap:                                  | 0.82        | 0.51 | 0.21 | 0.51        | 0.82 | 0.25 | 0.69       | 0.82 | 0.47 | 0.82       | 0.69 | 0.13 |
| Delay/Veh:                                   | 70.1        | 40.6 | 22.7 | 36.1        | 36.9 | 16.6 | 59.3       | 51.7 | 32.5 | 63.0       | 42.1 | 13.4 |
| User DelAdj:                                 | 1.00        | 1.00 | 1.00 | 1.00        | 1.00 | 1.00 | 1.00       | 1.00 | 1.00 | 1.00       | 1.00 | 1.00 |
| AdjDel/Veh:                                  | 70.1        | 40.6 | 22.7 | 36.1        | 36.9 | 16.6 | 59.3       | 51.7 | 32.5 | 63.0       | 42.1 | 13.4 |
| LOS by Move:                                 | E           | D    | C    | D           | D    | B    | E          | D    | C    | E          | D    | B    |
| HCM2k95thQ:                                  | 16          | 13   | 7    | 16          | 35   | 9    | 11         | 21   | 16   | 20         | 20   | 5    |

Note: Queue reported is the number of cars per lane.

BART

Level Of Service Computation Report  
 2000 HCM Operations (Future Volume Alternative)  
 AM - Cumulative No Project

Intersection #1213: THE ALAMEDA/EL CAMINO REAL [Study Int 54]

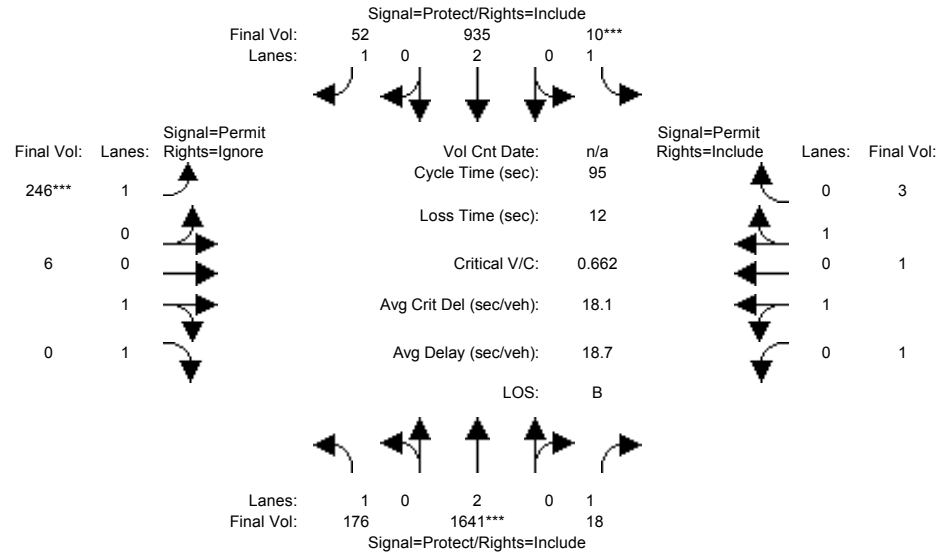

| Approach:                 | North Bound |      |      | South Bound |      |      | East Bound |      |      | West Bound |      |      |
|---------------------------|-------------|------|------|-------------|------|------|------------|------|------|------------|------|------|
| Movement:                 | L           | T    | R    | L           | T    | R    | L          | T    | R    | L          | T    | R    |
| Min. Green:               | 7           | 10   | 10   | 7           | 10   | 10   | 7          | 10   | 10   | 7          | 10   | 10   |
| Y+R:                      | 4.0         | 4.0  | 4.0  | 4.0         | 4.0  | 4.0  | 4.0        | 4.0  | 4.0  | 4.0        | 4.0  | 4.0  |
| Volume Module:            |             |      |      |             |      |      |            |      |      |            |      |      |
| Base Vol:                 | 176         | 1641 | 18   | 10          | 935  | 52   | 246        | 6    | 232  | 1          | 1    | 3    |
| Growth Adj:               | 1.00        | 1.00 | 1.00 | 1.00        | 1.00 | 1.00 | 1.00       | 1.00 | 1.00 | 1.00       | 1.00 | 1.00 |
| Initial Bse:              | 176         | 1641 | 18   | 10          | 935  | 52   | 246        | 6    | 232  | 1          | 1    | 3    |
| Added Vol:                | 0           | 0    | 0    | 0           | 0    | 0    | 0          | 0    | 0    | 0          | 0    | 0    |
| PasserByVol:              | 0           | 0    | 0    | 0           | 0    | 0    | 0          | 0    | 0    | 0          | 0    | 0    |
| Initial Fut:              | 176         | 1641 | 18   | 10          | 935  | 52   | 246        | 6    | 232  | 1          | 1    | 3    |
| User Adj:                 | 1.00        | 1.00 | 1.00 | 1.00        | 1.00 | 1.00 | 1.00       | 1.00 | 0.00 | 1.00       | 1.00 | 1.00 |
| PHF Adj:                  | 1.00        | 1.00 | 1.00 | 1.00        | 1.00 | 1.00 | 1.00       | 1.00 | 0.00 | 1.00       | 1.00 | 1.00 |
| PHF Volume:               | 176         | 1641 | 18   | 10          | 935  | 52   | 246        | 6    | 0    | 1          | 1    | 3    |
| Reduct Vol:               | 0           | 0    | 0    | 0           | 0    | 0    | 0          | 0    | 0    | 0          | 0    | 0    |
| Reduced Vol:              | 176         | 1641 | 18   | 10          | 935  | 52   | 246        | 6    | 0    | 1          | 1    | 3    |
| PCE Adj:                  | 1.00        | 1.00 | 1.00 | 1.00        | 1.00 | 1.00 | 1.00       | 1.00 | 0.00 | 1.00       | 1.00 | 1.00 |
| MLF Adj:                  | 1.00        | 1.00 | 1.00 | 1.00        | 1.00 | 1.00 | 1.00       | 1.00 | 0.00 | 1.00       | 1.00 | 1.00 |
| FinalVolume:              | 176         | 1641 | 18   | 10          | 935  | 52   | 246        | 6    | 0    | 1          | 1    | 3    |
| Saturation Flow Module:   |             |      |      |             |      |      |            |      |      |            |      |      |
| Sat/Lane:                 | 1900        | 1900 | 1900 | 1900        | 1900 | 1900 | 1900       | 1900 | 1900 | 1900       | 1900 | 1900 |
| Adjustment:               | 0.92        | 1.00 | 0.92 | 0.92        | 1.00 | 0.92 | 0.92       | 0.95 | 0.92 | 0.95       | 0.95 | 0.95 |
| Lanes:                    | 1.00        | 2.00 | 1.00 | 1.00        | 2.00 | 1.00 | 1.00       | 1.00 | 1.00 | 0.50       | 0.50 | 1.00 |
| Final Sat.:               | 1750        | 3800 | 1750 | 1750        | 3800 | 1750 | 1750       | 1800 | 1750 | 900        | 900  | 1800 |
| Capacity Analysis Module: |             |      |      |             |      |      |            |      |      |            |      |      |
| Vol/Sat:                  | 0.10        | 0.43 | 0.01 | 0.01        | 0.25 | 0.03 | 0.14       | 0.00 | 0.00 | 0.00       | 0.00 | 0.00 |
| Crit Moves:               | ****        | **** | **** | ****        | **** | **** | ****       | **** | **** | ****       | **** | **** |
| Green Time:               | 18.7        | 57.3 | 57.3 | 7.0         | 45.7 | 45.7 | 18.7       | 18.7 | 0.0  | 18.7       | 18.7 | 18.7 |
| Volume/Cap:               | 0.51        | 0.72 | 0.02 | 0.08        | 0.51 | 0.06 | 0.72       | 0.02 | 0.00 | 0.01       | 0.01 | 0.01 |
| Delay/Veh:                | 35.4        | 14.2 | 7.6  | 41.3        | 17.2 | 13.2 | 42.7       | 30.8 | 0.0  | 30.7       | 30.7 | 30.7 |
| User DelAdj:              | 1.00        | 1.00 | 1.00 | 1.00        | 1.00 | 1.00 | 1.00       | 1.00 | 1.00 | 1.00       | 1.00 | 1.00 |
| AdjDel/Veh:               | 35.4        | 14.2 | 7.6  | 41.3        | 17.2 | 13.2 | 42.7       | 30.8 | 0.0  | 30.7       | 30.7 | 30.7 |
| LOS by Move:              | D           | B    | A    | D           | B    | B    | D          | C    | A    | C          | C    | C    |
| HCM2k95thQ:               | 9           | 29   | 0    | 1           | 18   | 2    | 16         | 0    | 0    | 0          | 0    | 0    |

Note: Queue reported is the number of cars per lane.



BART

Level Of Service Computation Report  
 2000 HCM Operations (Future Volume Alternative)  
 PM - Cumulative No Project

Intersection #1213: THE ALAMEDA/EL CAMINO REAL [Study Int 54]

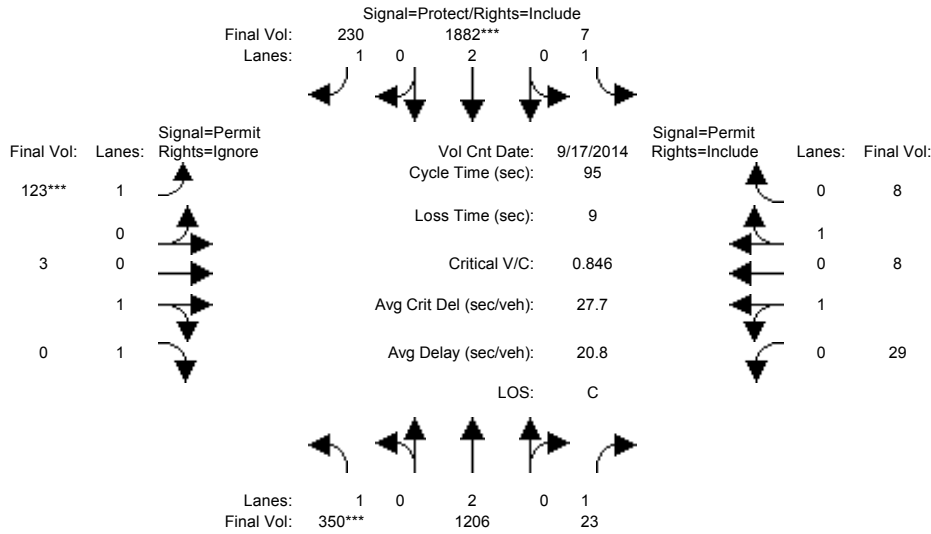

| Approach:                                    | North Bound |      |      | South Bound |      |      | East Bound |      |      | West Bound |      |      |
|--|-------------|------|------|-------------|------|------|------------|------|------|------------|------|------|
| Movement:                                    | L           | T    | R    | L           | T    | R    | L          | T    | R    | L          | T    | R    |
| Min. Green:                                  | 7           | 10   | 10   | 7           | 10   | 10   | 10         | 10   | 10   | 10         | 10   | 10   |
| Y+R:   | 4.0         | 4.0  | 4.0  | 4.0         | 4.0  | 4.0  | 4.0        | 4.0  | 4.0  | 4.0        | 4.0  | 4.0  |
| -----  |             |      |      |             |      |      |            |      |      |            |      |      |
| Volume Module: >> Count Date: 17 Sep 2014 << |             |      |      |             |      |      |            |      |      |            |      |      |
| Base Vol:                                    | 350         | 1206 | 23   | 7           | 1882 | 230  | 123        | 3    | 281  | 29         | 8    | 8    |
| Growth Adj:                                  | 1.00        | 1.00 | 1.00 | 1.00        | 1.00 | 1.00 | 1.00       | 1.00 | 1.00 | 1.00       | 1.00 | 1.00 |
| Initial Bse:                                 | 350         | 1206 | 23   | 7           | 1882 | 230  | 123        | 3    | 281  | 29         | 8    | 8    |
| Added Vol:                                   | 0           | 0    | 0    | 0           | 0    | 0    | 0          | 0    | 0    | 0          | 0    | 0    |
| PasserByVol:                                 | 0           | 0    | 0    | 0           | 0    | 0    | 0          | 0    | 0    | 0          | 0    | 0    |
| Initial Fut:                                 | 350         | 1206 | 23   | 7           | 1882 | 230  | 123        | 3    | 281  | 29         | 8    | 8    |
| User Adj:                                    | 1.00        | 1.00 | 1.00 | 1.00        | 1.00 | 1.00 | 1.00       | 1.00 | 0.00 | 1.00       | 1.00 | 1.00 |
| PHF Adj:                                     | 1.00        | 1.00 | 1.00 | 1.00        | 1.00 | 1.00 | 1.00       | 1.00 | 0.00 | 1.00       | 1.00 | 1.00 |
| PHF Volume:                                  | 350         | 1206 | 23   | 7           | 1882 | 230  | 123        | 3    | 0    | 29         | 8    | 8    |
| Reduct Vol:                                  | 0           | 0    | 0    | 0           | 0    | 0    | 0          | 0    | 0    | 0          | 0    | 0    |
| Reduced Vol:                                 | 350         | 1206 | 23   | 7           | 1882 | 230  | 123        | 3    | 0    | 29         | 8    | 8    |
| PCE Adj:                                     | 1.00        | 1.00 | 1.00 | 1.00        | 1.00 | 1.00 | 1.00       | 1.00 | 0.00 | 1.00       | 1.00 | 1.00 |
| MLF Adj:                                     | 1.00        | 1.00 | 1.00 | 1.00        | 1.00 | 1.00 | 1.00       | 1.00 | 0.00 | 1.00       | 1.00 | 1.00 |
| Final Volume:                                | 350         | 1206 | 23   | 7           | 1882 | 230  | 123        | 3    | 0    | 29         | 8    | 8    |
| -----  |             |      |      |             |      |      |            |      |      |            |      |      |
| Saturation Flow Module:                      |             |      |      |             |      |      |            |      |      |            |      |      |
| Sat/Lane:                                    | 1900        | 1900 | 1900 | 1900        | 1900 | 1900 | 1900       | 1900 | 1900 | 1900       | 1900 | 1900 |
| Adjustment:                                  | 0.92        | 1.00 | 0.92 | 0.92        | 1.00 | 0.92 | 0.92       | 0.95 | 0.92 | 0.95       | 0.95 | 0.95 |
| Lanes:                                       | 1.00        | 2.00 | 1.00 | 1.00        | 2.00 | 1.00 | 1.00       | 1.00 | 1.00 | 1.00       | 0.50 | 0.50 |
| Final Sat.:                                  | 1750        | 3800 | 1750 | 1750        | 3800 | 1750 | 1750       | 1800 | 1750 | 1800       | 900  | 900  |
| -----  |             |      |      |             |      |      |            |      |      |            |      |      |
| Capacity Analysis Module:                    |             |      |      |             |      |      |            |      |      |            |      |      |
| Vol/Sat:                                     | 0.20        | 0.32 | 0.01 | 0.00        | 0.50 | 0.13 | 0.07       | 0.00 | 0.00 | 0.02       | 0.01 | 0.01 |
| Crit Moves:                                  | ****        |      |      | ****        |      |      | ****       |      |      |            |      |      |
| Green Time:                                  | 21.9        | 61.7 | 61.7 | 14.3        | 54.1 | 54.1 | 10.0       | 10.0 | 0.0  | 10.0       | 10.0 | 10.0 |
| Volume/Cap:                                  | 0.87        | 0.49 | 0.02 | 0.03        | 0.87 | 0.23 | 0.67       | 0.02 | 0.00 | 0.15       | 0.08 | 0.08 |
| Delay/Veh:                                   | 53.2        | 8.7  | 5.9  | 34.4        | 21.5 | 10.2 | 49.9       | 38.1 | 0.0  | 38.9       | 38.4 | 38.4 |
| User DelAdj:                                 | 1.00        | 1.00 | 1.00 | 1.00        | 1.00 | 1.00 | 1.00       | 1.00 | 1.00 | 1.00       | 1.00 | 1.00 |
| AdjDel/Veh:                                  | 53.2        | 8.7  | 5.9  | 34.4        | 21.5 | 10.2 | 49.9       | 38.1 | 0.0  | 38.9       | 38.4 | 38.4 |
| LOS by Move:                                 | D           | A    | A    | C           | C    | B    | D          | D    | A    | D          | D    | D    |
| HCM2k95thQ:                                  | 21          | 16   | 1    | 0           | 43   | 7    | 10         | 0    | 0    | 2          | 1    | 1    |

Note: Queue reported is the number of cars per lane.

BART

Level Of Service Computation Report  
 2000 HCM Operations (Future Volume Alternative)  
 AM - Cumulative With Project

Intersection #1213: THE ALAMEDA/EL CAMINO REAL [Study Int 54]

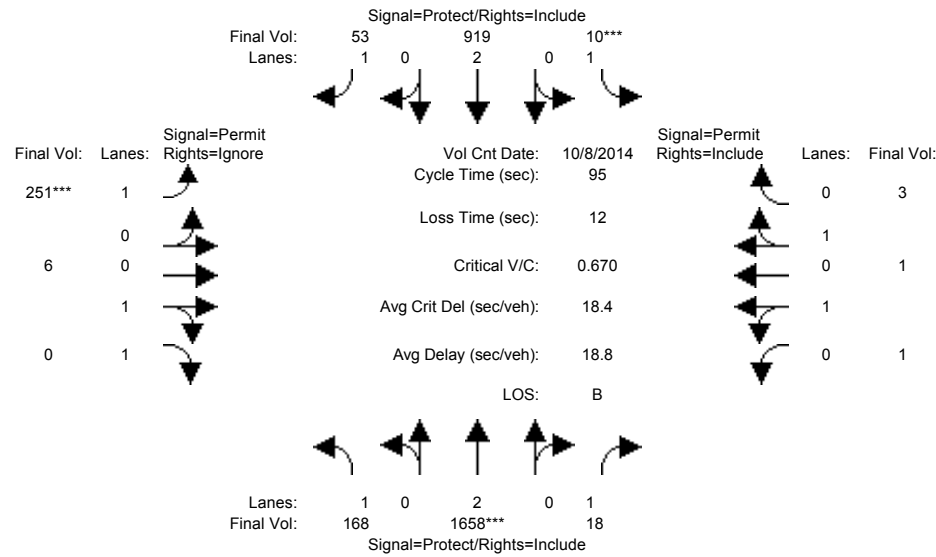

| Approach:                                   | North Bound |      |      | South Bound |      |      | East Bound |      |      | West Bound |      |      |
|---|-------------|------|------|-------------|------|------|------------|------|------|------------|------|------|
| Movement:                                   | L           | T    | R    | L           | T    | R    | L          | T    | R    | L          | T    | R    |
| Min. Green:                                 | 7           | 10   | 10   | 7           | 10   | 10   | 7          | 10   | 10   | 7          | 10   | 10   |
| Y+R:  | 4.0         | 4.0  | 4.0  | 4.0         | 4.0  | 4.0  | 4.0        | 4.0  | 4.0  | 4.0        | 4.0  | 4.0  |
| -----                                       |             |      |      |             |      |      |            |      |      |            |      |      |
| Volume Module: >> Count Date: 8 Oct 2014 << |             |      |      |             |      |      |            |      |      |            |      |      |
| Base Vol:                                   | 168         | 1658 | 18   | 10          | 919  | 53   | 251        | 6    | 215  | 1          | 1    | 3    |
| Growth Adj:                                 | 1.00        | 1.00 | 1.00 | 1.00        | 1.00 | 1.00 | 1.00       | 1.00 | 1.00 | 1.00       | 1.00 | 1.00 |
| Initial Bse:                                | 168         | 1658 | 18   | 10          | 919  | 53   | 251        | 6    | 215  | 1          | 1    | 3    |
| Added Vol:                                  | 0           | 0    | 0    | 0           | 0    | 0    | 0          | 0    | 0    | 0          | 0    | 0    |
| PasserByVol:                                | 0           | 0    | 0    | 0           | 0    | 0    | 0          | 0    | 0    | 0          | 0    | 0    |
| Initial Fut:                                | 168         | 1658 | 18   | 10          | 919  | 53   | 251        | 6    | 215  | 1          | 1    | 3    |
| User Adj:                                   | 1.00        | 1.00 | 1.00 | 1.00        | 1.00 | 1.00 | 1.00       | 1.00 | 0.00 | 1.00       | 1.00 | 1.00 |
| PHF Adj:                                    | 1.00        | 1.00 | 1.00 | 1.00        | 1.00 | 1.00 | 1.00       | 1.00 | 0.00 | 1.00       | 1.00 | 1.00 |
| PHF Volume:                                 | 168         | 1658 | 18   | 10          | 919  | 53   | 251        | 6    | 0    | 1          | 1    | 3    |
| Reduct Vol:                                 | 0           | 0    | 0    | 0           | 0    | 0    | 0          | 0    | 0    | 0          | 0    | 0    |
| Reduced Vol:                                | 168         | 1658 | 18   | 10          | 919  | 53   | 251        | 6    | 0    | 1          | 1    | 3    |
| PCE Adj:                                    | 1.00        | 1.00 | 1.00 | 1.00        | 1.00 | 1.00 | 1.00       | 1.00 | 0.00 | 1.00       | 1.00 | 1.00 |
| MLF Adj:                                    | 1.00        | 1.00 | 1.00 | 1.00        | 1.00 | 1.00 | 1.00       | 1.00 | 0.00 | 1.00       | 1.00 | 1.00 |
| FinalVolume:                                | 168         | 1658 | 18   | 10          | 919  | 53   | 251        | 6    | 0    | 1          | 1    | 3    |
| -----                                       |             |      |      |             |      |      |            |      |      |            |      |      |
| Saturation Flow Module:                     |             |      |      |             |      |      |            |      |      |            |      |      |
| Sat/Lane:                                   | 1900        | 1900 | 1900 | 1900        | 1900 | 1900 | 1900       | 1900 | 1900 | 1900       | 1900 | 1900 |
| Adjustment:                                 | 0.92        | 1.00 | 0.92 | 0.92        | 1.00 | 0.92 | 0.92       | 0.95 | 0.92 | 0.95       | 0.95 | 0.95 |
| Lanes:                                      | 1.00        | 2.00 | 1.00 | 1.00        | 2.00 | 1.00 | 1.00       | 1.00 | 1.00 | 0.50       | 0.50 | 1.00 |
| Final Sat.:                                 | 1750        | 3800 | 1750 | 1750        | 3800 | 1750 | 1750       | 1800 | 1750 | 900        | 900  | 1800 |
| -----                                       |             |      |      |             |      |      |            |      |      |            |      |      |
| Capacity Analysis Module:                   |             |      |      |             |      |      |            |      |      |            |      |      |
| Vol/Sat:                                    | 0.10        | 0.44 | 0.01 | 0.01        | 0.24 | 0.03 | 0.14       | 0.00 | 0.00 | 0.00       | 0.00 | 0.00 |
| Crit Moves:                                 | ****        | **** | **** | ****        | **** | **** | ****       | **** | **** | ****       | **** | **** |
| Green Time:                                 | 18.2        | 57.2 | 57.2 | 7.0         | 46.0 | 46.0 | 18.8       | 18.8 | 0.0  | 18.8       | 18.8 | 18.8 |
| Volume/Cap:                                 | 0.50        | 0.72 | 0.02 | 0.08        | 0.50 | 0.06 | 0.72       | 0.02 | 0.00 | 0.01       | 0.01 | 0.01 |
| Delay/Veh:                                  | 35.5        | 14.5 | 7.6  | 41.3        | 16.9 | 13.1 | 43.1       | 30.7 | 0.0  | 30.6       | 30.6 | 30.6 |
| User DelAdj:                                | 1.00        | 1.00 | 1.00 | 1.00        | 1.00 | 1.00 | 1.00       | 1.00 | 1.00 | 1.00       | 1.00 | 1.00 |
| AdjDel/Veh:                                 | 35.5        | 14.5 | 7.6  | 41.3        | 16.9 | 13.1 | 43.1       | 30.7 | 0.0  | 30.6       | 30.6 | 30.6 |
| LOS by Move:                                | D           | B    | A    | D           | B    | B    | D          | C    | A    | C          | C    | C    |
| HCM2k95thQ:                                 | 9           | 29   | 0    | 1           | 17   | 2    | 17         | 0    | 0    | 0          | 0    | 0    |

Note: Queue reported is the number of cars per lane.

BART

Level Of Service Computation Report  
 2000 HCM Operations (Future Volume Alternative)  
 PM - Cumulative With Project

Intersection #1213: THE ALAMEDA/EL CAMINO REAL [Study Int 54]

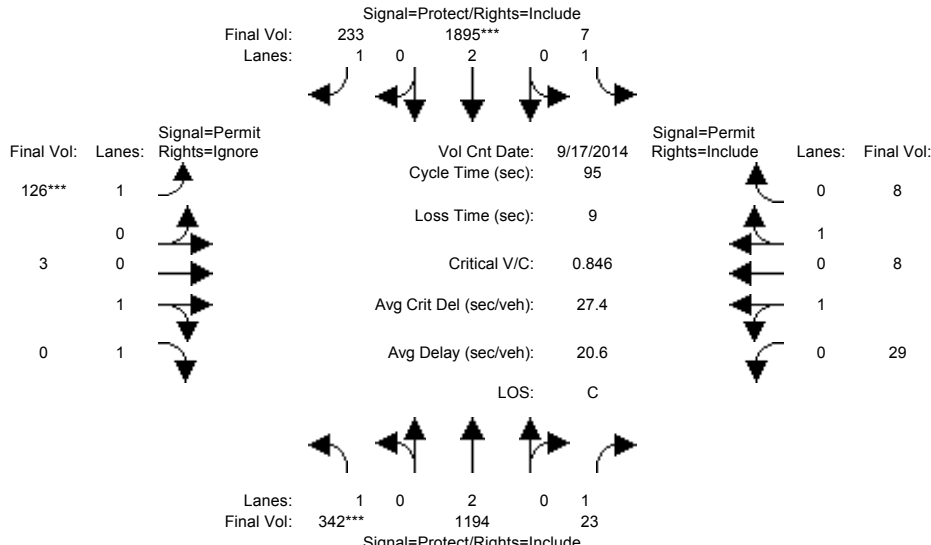

| Approach:                                    | North Bound |      |      | South Bound |      |      | East Bound |      |      | West Bound |      |      |
|--|-------------|------|------|-------------|------|------|------------|------|------|------------|------|------|
| Movement:                                    | L           | T    | R    | L           | T    | R    | L          | T    | R    | L          | T    | R    |
| Min. Green:                                  | 7           | 10   | 10   | 7           | 10   | 10   | 10         | 10   | 10   | 10         | 10   | 10   |
| Y+R:   | 4.0         | 4.0  | 4.0  | 4.0         | 4.0  | 4.0  | 4.0        | 4.0  | 4.0  | 4.0        | 4.0  | 4.0  |
| Volume Module: >> Count Date: 17 Sep 2014 << |             |      |      |             |      |      |            |      |      |            |      |      |
| Base Vol:                                    | 342         | 1194 | 23   | 7           | 1895 | 233  | 126        | 3    | 272  | 29         | 8    | 8    |
| Growth Adj:                                  | 1.00        | 1.00 | 1.00 | 1.00        | 1.00 | 1.00 | 1.00       | 1.00 | 1.00 | 1.00       | 1.00 | 1.00 |
| Initial Bse:                                 | 342         | 1194 | 23   | 7           | 1895 | 233  | 126        | 3    | 272  | 29         | 8    | 8    |
| Added Vol:                                   | 0           | 0    | 0    | 0           | 0    | 0    | 0          | 0    | 0    | 0          | 0    | 0    |
| PasserByVol:                                 | 0           | 0    | 0    | 0           | 0    | 0    | 0          | 0    | 0    | 0          | 0    | 0    |
| Initial Fut:                                 | 342         | 1194 | 23   | 7           | 1895 | 233  | 126        | 3    | 272  | 29         | 8    | 8    |
| User Adj:                                    | 1.00        | 1.00 | 1.00 | 1.00        | 1.00 | 1.00 | 1.00       | 1.00 | 0.00 | 1.00       | 1.00 | 1.00 |
| PHF Adj:                                     | 1.00        | 1.00 | 1.00 | 1.00        | 1.00 | 1.00 | 1.00       | 1.00 | 0.00 | 1.00       | 1.00 | 1.00 |
| PHF Volume:                                  | 342         | 1194 | 23   | 7           | 1895 | 233  | 126        | 3    | 0    | 29         | 8    | 8    |
| Reduct Vol:                                  | 0           | 0    | 0    | 0           | 0    | 0    | 0          | 0    | 0    | 0          | 0    | 0    |
| Reduced Vol:                                 | 342         | 1194 | 23   | 7           | 1895 | 233  | 126        | 3    | 0    | 29         | 8    | 8    |
| PCE Adj:                                     | 1.00        | 1.00 | 1.00 | 1.00        | 1.00 | 1.00 | 1.00       | 1.00 | 0.00 | 1.00       | 1.00 | 1.00 |
| MLF Adj:                                     | 1.00        | 1.00 | 1.00 | 1.00        | 1.00 | 1.00 | 1.00       | 1.00 | 0.00 | 1.00       | 1.00 | 1.00 |
| Final Volume:                                | 342         | 1194 | 23   | 7           | 1895 | 233  | 126        | 3    | 0    | 29         | 8    | 8    |
| Saturation Flow Module:                      |             |      |      |             |      |      |            |      |      |            |      |      |
| Sat/Lane:                                    | 1900        | 1900 | 1900 | 1900        | 1900 | 1900 | 1900       | 1900 | 1900 | 1900       | 1900 | 1900 |
| Adjustment:                                  | 0.92        | 1.00 | 0.92 | 0.92        | 1.00 | 0.92 | 0.92       | 0.95 | 0.92 | 0.95       | 0.95 | 0.95 |
| Lanes:                                       | 1.00        | 2.00 | 1.00 | 1.00        | 2.00 | 1.00 | 1.00       | 1.00 | 1.00 | 1.00       | 0.50 | 0.50 |
| Final Sat.:                                  | 1750        | 3800 | 1750 | 1750        | 3800 | 1750 | 1750       | 1800 | 1750 | 1800       | 900  | 900  |
| Capacity Analysis Module:                    |             |      |      |             |      |      |            |      |      |            |      |      |
| Vol/Sat:                                     | 0.20        | 0.31 | 0.01 | 0.00        | 0.50 | 0.13 | 0.07       | 0.00 | 0.00 | 0.02       | 0.01 | 0.01 |
| Crit Moves:                                  | ****        |      |      | ****        |      |      | ****       |      |      |            |      |      |
| Green Time:                                  | 21.4        | 61.6 | 61.6 | 14.4        | 54.6 | 54.6 | 10.0       | 10.0 | 0.0  | 10.0       | 10.0 | 10.0 |
| Volume/Cap:                                  | 0.87        | 0.48 | 0.02 | 0.03        | 0.87 | 0.23 | 0.68       | 0.02 | 0.00 | 0.15       | 0.08 | 0.08 |
| Delay/Veh:                                   | 53.5        | 8.7  | 6.0  | 34.3        | 21.1 | 10.0 | 51.1       | 38.1 | 0.0  | 38.9       | 38.4 | 38.4 |
| User DelAdj:                                 | 1.00        | 1.00 | 1.00 | 1.00        | 1.00 | 1.00 | 1.00       | 1.00 | 1.00 | 1.00       | 1.00 | 1.00 |
| AdjDel/Veh:                                  | 53.5        | 8.7  | 6.0  | 34.3        | 21.1 | 10.0 | 51.1       | 38.1 | 0.0  | 38.9       | 38.4 | 38.4 |
| LOS by Move:                                 | D           | A    | A    | C           | C    | B    | D          | D    | A    | D          | D    | D    |
| HCM2k95thQ:                                  | 20          | 16   | 1    | 0           | 43   | 7    | 10         | 0    | 0    | 2          | 1    | 1    |

Note: Queue reported is the number of cars per lane.

BART

Level Of Service Computation Report  
 2000 HCM Operations (Future Volume Alternative)  
 AM - Cumulative No Project

Intersection #1214: THE ALAMEDA/NEWHALL [Study Int 55]

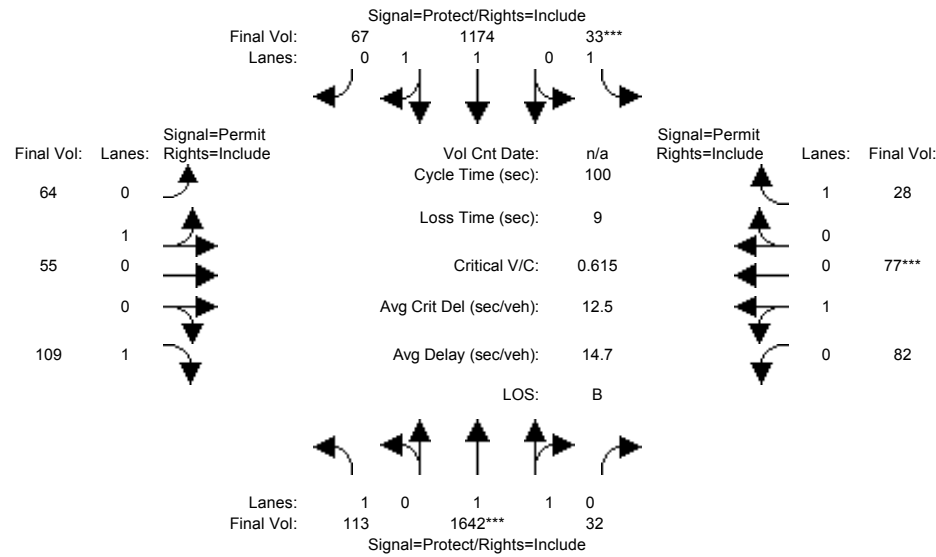

| Approach:                 | North Bound |      |      | South Bound |      |      | East Bound |      |      | West Bound |      |      |
|---------------------------|-------------|------|------|-------------|------|------|------------|------|------|------------|------|------|
| Movement:                 | L           | T    | R    | L           | T    | R    | L          | T    | R    | L          | T    | R    |
| Min. Green:               | 7           | 10   | 10   | 7           | 10   | 10   | 7          | 10   | 10   | 7          | 10   | 10   |
| Y+R:                      | 4.0         | 4.0  | 4.0  | 4.0         | 4.0  | 4.0  | 4.0        | 4.0  | 4.0  | 4.0        | 4.0  | 4.0  |
| Volume Module:            |             |      |      |             |      |      |            |      |      |            |      |      |
| Base Vol:                 | 113         | 1642 | 32   | 33          | 1174 | 67   | 64         | 55   | 109  | 82         | 77   | 28   |
| Growth Adj:               | 1.00        | 1.00 | 1.00 | 1.00        | 1.00 | 1.00 | 1.00       | 1.00 | 1.00 | 1.00       | 1.00 | 1.00 |
| Initial Bse:              | 113         | 1642 | 32   | 33          | 1174 | 67   | 64         | 55   | 109  | 82         | 77   | 28   |
| Added Vol:                | 0           | 0    | 0    | 0           | 0    | 0    | 0          | 0    | 0    | 0          | 0    | 0    |
| PasserByVol:              | 0           | 0    | 0    | 0           | 0    | 0    | 0          | 0    | 0    | 0          | 0    | 0    |
| Initial Fut:              | 113         | 1642 | 32   | 33          | 1174 | 67   | 64         | 55   | 109  | 82         | 77   | 28   |
| User Adj:                 | 1.00        | 1.00 | 1.00 | 1.00        | 1.00 | 1.00 | 1.00       | 1.00 | 1.00 | 1.00       | 1.00 | 1.00 |
| PHF Adj:                  | 1.00        | 1.00 | 1.00 | 1.00        | 1.00 | 1.00 | 1.00       | 1.00 | 1.00 | 1.00       | 1.00 | 1.00 |
| PHF Volume:               | 113         | 1642 | 32   | 33          | 1174 | 67   | 64         | 55   | 109  | 82         | 77   | 28   |
| Reduct Vol:               | 0           | 0    | 0    | 0           | 0    | 0    | 0          | 0    | 0    | 0          | 0    | 0    |
| Reduced Vol:              | 113         | 1642 | 32   | 33          | 1174 | 67   | 64         | 55   | 109  | 82         | 77   | 28   |
| PCE Adj:                  | 1.00        | 1.00 | 1.00 | 1.00        | 1.00 | 1.00 | 1.00       | 1.00 | 1.00 | 1.00       | 1.00 | 1.00 |
| MLF Adj:                  | 1.00        | 1.00 | 1.00 | 1.00        | 1.00 | 1.00 | 1.00       | 1.00 | 1.00 | 1.00       | 1.00 | 1.00 |
| Final Volume:             | 113         | 1642 | 32   | 33          | 1174 | 67   | 64         | 55   | 109  | 82         | 77   | 28   |
| Saturation Flow Module:   |             |      |      |             |      |      |            |      |      |            |      |      |
| Sat/Lane:                 | 1900        | 1900 | 1900 | 1900        | 1900 | 1900 | 1900       | 1900 | 1900 | 1900       | 1900 | 1900 |
| Adjustment:               | 0.92        | 0.97 | 0.95 | 0.92        | 0.98 | 0.95 | 0.95       | 0.95 | 0.92 | 0.95       | 0.95 | 0.92 |
| Lanes:                    | 1.00        | 1.96 | 0.04 | 1.00        | 1.89 | 0.11 | 0.54       | 0.46 | 1.00 | 0.52       | 0.48 | 1.00 |
| Final Sat.:               | 1750        | 3629 | 71   | 1750        | 3500 | 200  | 968        | 832  | 1750 | 928        | 872  | 1750 |
| Capacity Analysis Module: |             |      |      |             |      |      |            |      |      |            |      |      |
| Vol/Sat:                  | 0.06        | 0.45 | 0.45 | 0.02        | 0.34 | 0.34 | 0.07       | 0.07 | 0.06 | 0.09       | 0.09 | 0.02 |
| Crit Moves:               | ****        | **** | **** | ****        | **** | **** | ****       | **** | **** | ****       | **** | **** |
| Green Time:               | 13.3        | 70.3 | 70.3 | 7.0         | 63.9 | 63.9 | 13.7       | 13.7 | 13.7 | 13.7       | 13.7 | 13.7 |
| Volume/Cap:               | 0.48        | 0.64 | 0.64 | 0.27        | 0.52 | 0.52 | 0.48       | 0.48 | 0.45 | 0.64       | 0.64 | 0.12 |
| Delay/Veh:                | 41.7        | 8.6  | 8.6  | 45.3        | 10.0 | 10.0 | 41.3       | 41.3 | 41.1 | 46.5       | 46.5 | 38.0 |
| User DelAdj:              | 1.00        | 1.00 | 1.00 | 1.00        | 1.00 | 1.00 | 1.00       | 1.00 | 1.00 | 1.00       | 1.00 | 1.00 |
| AdjDel/Veh:               | 41.7        | 8.6  | 8.6  | 45.3        | 10.0 | 10.0 | 41.3       | 41.3 | 41.1 | 46.5       | 46.5 | 38.0 |
| LOS by Move:              | D           | A    | A    | D           | B    | B    | D          | D    | D    | D          | D    | D    |
| HCM2k95thQ:               | 7           | 25   | 25   | 2           | 19   | 19   | 7          | 7    | 7    | 12         | 12   | 2    |

Note: Queue reported is the number of cars per lane.

BART

Level Of Service Computation Report  
 2000 HCM Operations (Future Volume Alternative)  
 PM - Cumulative No Project

Intersection #1214: THE ALAMEDA/NEWHALL [Study Int 55]

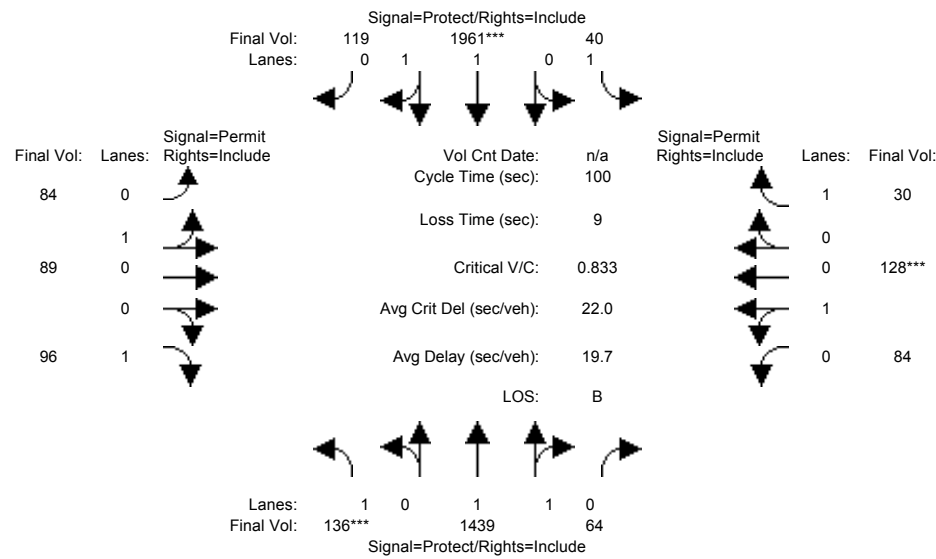

| Approach:                 | North Bound |      |      | South Bound |      |      | East Bound |      |      | West Bound |      |      |
|---------------------------|-------------|------|------|-------------|------|------|------------|------|------|------------|------|------|
| Movement:                 | L           | T    | R    | L           | T    | R    | L          | T    | R    | L          | T    | R    |
| Min. Green:               | 7           | 10   | 10   | 7           | 10   | 10   | 7          | 10   | 10   | 7          | 10   | 10   |
| Y+R:                      | 4.0         | 4.0  | 4.0  | 4.0         | 4.0  | 4.0  | 4.0        | 4.0  | 4.0  | 4.0        | 4.0  | 4.0  |
| Volume Module:            |             |      |      |             |      |      |            |      |      |            |      |      |
| Base Vol:                 | 136         | 1439 | 64   | 40          | 1961 | 119  | 84         | 89   | 96   | 84         | 128  | 30   |
| Growth Adj:               | 1.00        | 1.00 | 1.00 | 1.00        | 1.00 | 1.00 | 1.00       | 1.00 | 1.00 | 1.00       | 1.00 | 1.00 |
| Initial Bse:              | 136         | 1439 | 64   | 40          | 1961 | 119  | 84         | 89   | 96   | 84         | 128  | 30   |
| Added Vol:                | 0           | 0    | 0    | 0           | 0    | 0    | 0          | 0    | 0    | 0          | 0    | 0    |
| PasserByVol:              | 0           | 0    | 0    | 0           | 0    | 0    | 0          | 0    | 0    | 0          | 0    | 0    |
| Initial Fut:              | 136         | 1439 | 64   | 40          | 1961 | 119  | 84         | 89   | 96   | 84         | 128  | 30   |
| User Adj:                 | 1.00        | 1.00 | 1.00 | 1.00        | 1.00 | 1.00 | 1.00       | 1.00 | 1.00 | 1.00       | 1.00 | 1.00 |
| PHF Adj:                  | 1.00        | 1.00 | 1.00 | 1.00        | 1.00 | 1.00 | 1.00       | 1.00 | 1.00 | 1.00       | 1.00 | 1.00 |
| PHF Volume:               | 136         | 1439 | 64   | 40          | 1961 | 119  | 84         | 89   | 96   | 84         | 128  | 30   |
| Reduct Vol:               | 0           | 0    | 0    | 0           | 0    | 0    | 0          | 0    | 0    | 0          | 0    | 0    |
| Reduced Vol:              | 136         | 1439 | 64   | 40          | 1961 | 119  | 84         | 89   | 96   | 84         | 128  | 30   |
| PCE Adj:                  | 1.00        | 1.00 | 1.00 | 1.00        | 1.00 | 1.00 | 1.00       | 1.00 | 1.00 | 1.00       | 1.00 | 1.00 |
| MLF Adj:                  | 1.00        | 1.00 | 1.00 | 1.00        | 1.00 | 1.00 | 1.00       | 1.00 | 1.00 | 1.00       | 1.00 | 1.00 |
| Final Volume:             | 136         | 1439 | 64   | 40          | 1961 | 119  | 84         | 89   | 96   | 84         | 128  | 30   |
| Saturation Flow Module:   |             |      |      |             |      |      |            |      |      |            |      |      |
| Sat/Lane:                 | 1900        | 1900 | 1900 | 1900        | 1900 | 1900 | 1900       | 1900 | 1900 | 1900       | 1900 | 1900 |
| Adjustment:               | 0.92        | 0.97 | 0.95 | 0.92        | 0.98 | 0.95 | 0.95       | 0.95 | 0.92 | 0.95       | 0.95 | 0.92 |
| Lanes:                    | 1.00        | 1.91 | 0.09 | 1.00        | 1.88 | 0.12 | 0.49       | 0.51 | 1.00 | 0.40       | 0.60 | 1.00 |
| Final Sat.:               | 1750        | 3542 | 158  | 1750        | 3488 | 212  | 874        | 926  | 1750 | 713        | 1087 | 1750 |
| Capacity Analysis Module: |             |      |      |             |      |      |            |      |      |            |      |      |
| Vol/Sat:                  | 0.08        | 0.41 | 0.41 | 0.02        | 0.56 | 0.56 | 0.10       | 0.10 | 0.05 | 0.12       | 0.12 | 0.02 |
| Crit Moves:               | ****        |      |      | ****        |      |      |            |      |      | ****       |      |      |
| Green Time:               | 9.3         | 65.6 | 65.6 | 11.3        | 67.5 | 67.5 | 14.1       | 14.1 | 14.1 | 14.1       | 14.1 | 14.1 |
| Volume/Cap:               | 0.83        | 0.62 | 0.62 | 0.20        | 0.83 | 0.83 | 0.68       | 0.68 | 0.39 | 0.83       | 0.83 | 0.12 |
| Delay/Veh:                | 73.5        | 10.5 | 10.5 | 40.8        | 14.6 | 14.6 | 48.0       | 48.0 | 40.0 | 62.1       | 62.1 | 37.7 |
| User DelAdj:              | 1.00        | 1.00 | 1.00 | 1.00        | 1.00 | 1.00 | 1.00       | 1.00 | 1.00 | 1.00       | 1.00 | 1.00 |
| AdjDel/Veh:               | 73.5        | 10.5 | 10.5 | 40.8        | 14.6 | 14.6 | 48.0       | 48.0 | 40.0 | 62.1       | 62.1 | 37.7 |
| LOS by Move:              | E           | B    | B    | D           | B    | B    | D          | D    | D    | E          | E    | D    |
| HCM2k95thQ:               | 10          | 24   | 24   | 2           | 39   | 39   | 11         | 11   | 6    | 17         | 17   | 2    |

Note: Queue reported is the number of cars per lane.

BART

Level Of Service Computation Report  
 2000 HCM Operations (Future Volume Alternative)  
 AM - Cumulative With Project

Intersection #1214: THE ALAMEDA/NEWHALL [Study Int 55]

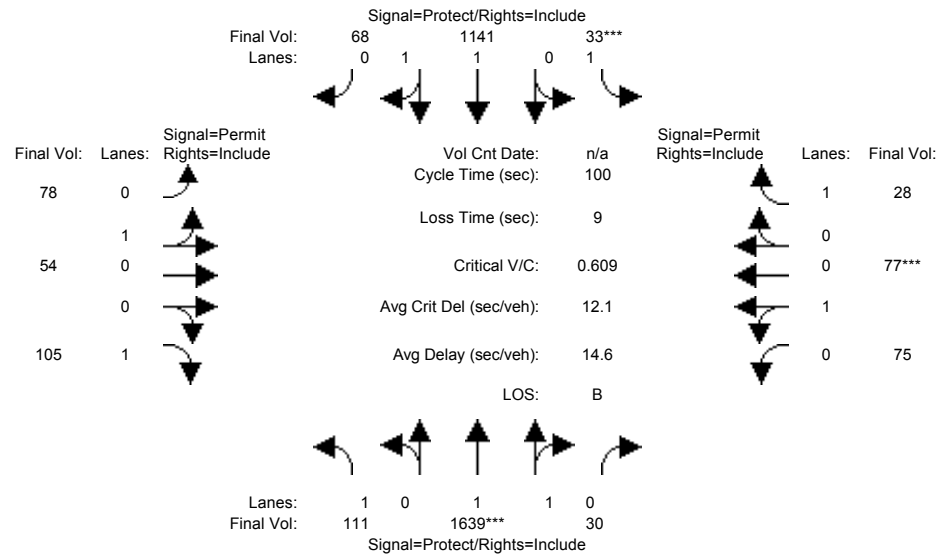

| Approach:                 | North Bound |      |      | South Bound |      |      | East Bound |      |      | West Bound |      |      |
|---------------------------|-------------|------|------|-------------|------|------|------------|------|------|------------|------|------|
| Movement:                 | L           | T    | R    | L           | T    | R    | L          | T    | R    | L          | T    | R    |
| Min. Green:               | 7           | 10   | 10   | 7           | 10   | 10   | 7          | 10   | 10   | 7          | 10   | 10   |
| Y+R:                      | 4.0         | 4.0  | 4.0  | 4.0         | 4.0  | 4.0  | 4.0        | 4.0  | 4.0  | 4.0        | 4.0  | 4.0  |
| Volume Module:            |             |      |      |             |      |      |            |      |      |            |      |      |
| Base Vol:                 | 111         | 1639 | 30   | 33          | 1141 | 68   | 78         | 54   | 105  | 75         | 77   | 28   |
| Growth Adj:               | 1.00        | 1.00 | 1.00 | 1.00        | 1.00 | 1.00 | 1.00       | 1.00 | 1.00 | 1.00       | 1.00 | 1.00 |
| Initial Bse:              | 111         | 1639 | 30   | 33          | 1141 | 68   | 78         | 54   | 105  | 75         | 77   | 28   |
| Added Vol:                | 0           | 0    | 0    | 0           | 0    | 0    | 0          | 0    | 0    | 0          | 0    | 0    |
| PasserByVol:              | 0           | 0    | 0    | 0           | 0    | 0    | 0          | 0    | 0    | 0          | 0    | 0    |
| Initial Fut:              | 111         | 1639 | 30   | 33          | 1141 | 68   | 78         | 54   | 105  | 75         | 77   | 28   |
| User Adj:                 | 1.00        | 1.00 | 1.00 | 1.00        | 1.00 | 1.00 | 1.00       | 1.00 | 1.00 | 1.00       | 1.00 | 1.00 |
| PHF Adj:                  | 1.00        | 1.00 | 1.00 | 1.00        | 1.00 | 1.00 | 1.00       | 1.00 | 1.00 | 1.00       | 1.00 | 1.00 |
| PHF Volume:               | 111         | 1639 | 30   | 33          | 1141 | 68   | 78         | 54   | 105  | 75         | 77   | 28   |
| Reduct Vol:               | 0           | 0    | 0    | 0           | 0    | 0    | 0          | 0    | 0    | 0          | 0    | 0    |
| Reduced Vol:              | 111         | 1639 | 30   | 33          | 1141 | 68   | 78         | 54   | 105  | 75         | 77   | 28   |
| PCE Adj:                  | 1.00        | 1.00 | 1.00 | 1.00        | 1.00 | 1.00 | 1.00       | 1.00 | 1.00 | 1.00       | 1.00 | 1.00 |
| MLF Adj:                  | 1.00        | 1.00 | 1.00 | 1.00        | 1.00 | 1.00 | 1.00       | 1.00 | 1.00 | 1.00       | 1.00 | 1.00 |
| Final Volume:             | 111         | 1639 | 30   | 33          | 1141 | 68   | 78         | 54   | 105  | 75         | 77   | 28   |
| Saturation Flow Module:   |             |      |      |             |      |      |            |      |      |            |      |      |
| Sat/Lane:                 | 1900        | 1900 | 1900 | 1900        | 1900 | 1900 | 1900       | 1900 | 1900 | 1900       | 1900 | 1900 |
| Adjustment:               | 0.92        | 0.97 | 0.95 | 0.92        | 0.98 | 0.95 | 0.95       | 0.95 | 0.92 | 0.95       | 0.95 | 0.92 |
| Lanes:                    | 1.00        | 1.96 | 0.04 | 1.00        | 1.88 | 0.12 | 0.59       | 0.41 | 1.00 | 0.49       | 0.51 | 1.00 |
| Final Sat.:               | 1750        | 3633 | 67   | 1750        | 3492 | 208  | 1064       | 736  | 1750 | 888        | 912  | 1750 |
| Capacity Analysis Module: |             |      |      |             |      |      |            |      |      |            |      |      |
| Vol/Sat:                  | 0.06        | 0.45 | 0.45 | 0.02        | 0.33 | 0.33 | 0.07       | 0.07 | 0.06 | 0.08       | 0.08 | 0.02 |
| Crit Moves:               | ****        | **** | **** | ****        | **** | **** | ****       | **** | **** | ****       | **** | **** |
| Green Time:               | 13.7        | 70.8 | 70.8 | 7.0         | 64.0 | 64.0 | 13.2       | 13.2 | 13.2 | 13.2       | 13.2 | 13.2 |
| Volume/Cap:               | 0.46        | 0.64 | 0.64 | 0.27        | 0.51 | 0.51 | 0.55       | 0.55 | 0.45 | 0.64       | 0.64 | 0.12 |
| Delay/Veh:                | 41.2        | 8.3  | 8.3  | 45.3        | 9.8  | 9.8  | 43.4       | 43.4 | 41.4 | 46.8       | 46.8 | 38.5 |
| User DelAdj:              | 1.00        | 1.00 | 1.00 | 1.00        | 1.00 | 1.00 | 1.00       | 1.00 | 1.00 | 1.00       | 1.00 | 1.00 |
| AdjDel/Veh:               | 41.2        | 8.3  | 8.3  | 45.3        | 9.8  | 9.8  | 43.4       | 43.4 | 41.4 | 46.8       | 46.8 | 38.5 |
| LOS by Move:              | D           | A    | A    | D           | A    | A    | D          | D    | D    | D          | D    | D    |
| HCM2k95thQ:               | 7           | 25   | 25   | 2           | 18   | 18   | 8          | 8    | 6    | 11         | 11   | 2    |

Note: Queue reported is the number of cars per lane.

BART

Level Of Service Computation Report  
 2000 HCM Operations (Future Volume Alternative)  
 PM - Cumulative With Project

Intersection #1214: THE ALAMEDA/NEWHALL [Study Int 55]

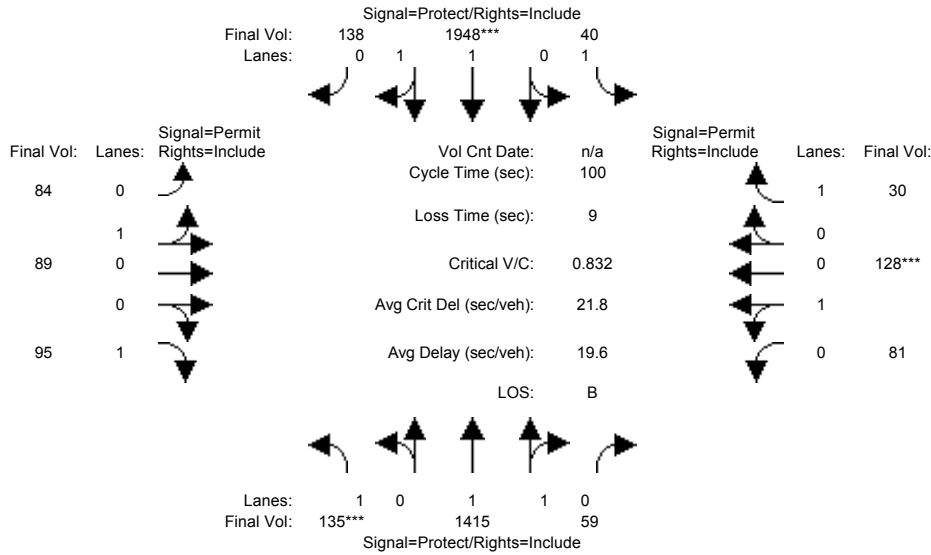

| Approach:                 | North Bound |      |      | South Bound |      |      | East Bound |      |      | West Bound |      |      |
|---------------------------|-------------|------|------|-------------|------|------|------------|------|------|------------|------|------|
| Movement:                 | L           | T    | R    | L           | T    | R    | L          | T    | R    | L          | T    | R    |
| Min. Green:               | 7           | 10   | 10   | 7           | 10   | 10   | 7          | 10   | 10   | 7          | 10   | 10   |
| Y+R:                      | 4.0         | 4.0  | 4.0  | 4.0         | 4.0  | 4.0  | 4.0        | 4.0  | 4.0  | 4.0        | 4.0  | 4.0  |
| Volume Module:            |             |      |      |             |      |      |            |      |      |            |      |      |
| Base Vol:                 | 135         | 1415 | 59   | 40          | 1948 | 138  | 84         | 89   | 95   | 81         | 128  | 30   |
| Growth Adj:               | 1.00        | 1.00 | 1.00 | 1.00        | 1.00 | 1.00 | 1.00       | 1.00 | 1.00 | 1.00       | 1.00 | 1.00 |
| Initial Bse:              | 135         | 1415 | 59   | 40          | 1948 | 138  | 84         | 89   | 95   | 81         | 128  | 30   |
| Added Vol:                | 0           | 0    | 0    | 0           | 0    | 0    | 0          | 0    | 0    | 0          | 0    | 0    |
| PasserByVol:              | 0           | 0    | 0    | 0           | 0    | 0    | 0          | 0    | 0    | 0          | 0    | 0    |
| Initial Fut:              | 135         | 1415 | 59   | 40          | 1948 | 138  | 84         | 89   | 95   | 81         | 128  | 30   |
| User Adj:                 | 1.00        | 1.00 | 1.00 | 1.00        | 1.00 | 1.00 | 1.00       | 1.00 | 1.00 | 1.00       | 1.00 | 1.00 |
| PHF Adj:                  | 1.00        | 1.00 | 1.00 | 1.00        | 1.00 | 1.00 | 1.00       | 1.00 | 1.00 | 1.00       | 1.00 | 1.00 |
| PHF Volume:               | 135         | 1415 | 59   | 40          | 1948 | 138  | 84         | 89   | 95   | 81         | 128  | 30   |
| Reduct Vol:               | 0           | 0    | 0    | 0           | 0    | 0    | 0          | 0    | 0    | 0          | 0    | 0    |
| Reduced Vol:              | 135         | 1415 | 59   | 40          | 1948 | 138  | 84         | 89   | 95   | 81         | 128  | 30   |
| PCE Adj:                  | 1.00        | 1.00 | 1.00 | 1.00        | 1.00 | 1.00 | 1.00       | 1.00 | 1.00 | 1.00       | 1.00 | 1.00 |
| MLF Adj:                  | 1.00        | 1.00 | 1.00 | 1.00        | 1.00 | 1.00 | 1.00       | 1.00 | 1.00 | 1.00       | 1.00 | 1.00 |
| Final Volume:             | 135         | 1415 | 59   | 40          | 1948 | 138  | 84         | 89   | 95   | 81         | 128  | 30   |
| Saturation Flow Module:   |             |      |      |             |      |      |            |      |      |            |      |      |
| Sat/Lane:                 | 1900        | 1900 | 1900 | 1900        | 1900 | 1900 | 1900       | 1900 | 1900 | 1900       | 1900 | 1900 |
| Adjustment:               | 0.92        | 0.97 | 0.95 | 0.92        | 0.98 | 0.95 | 0.95       | 0.95 | 0.92 | 0.95       | 0.95 | 0.92 |
| Lanes:                    | 1.00        | 1.92 | 0.08 | 1.00        | 1.86 | 0.14 | 0.49       | 0.51 | 1.00 | 0.39       | 0.61 | 1.00 |
| Final Sat.:               | 1750        | 3552 | 148  | 1750        | 3455 | 245  | 874        | 926  | 1750 | 698        | 1102 | 1750 |
| Capacity Analysis Module: |             |      |      |             |      |      |            |      |      |            |      |      |
| Vol/Sat:                  | 0.08        | 0.40 | 0.40 | 0.02        | 0.56 | 0.56 | 0.10       | 0.10 | 0.05 | 0.12       | 0.12 | 0.02 |
| Crit Moves:               | ****        |      |      | ****        |      |      |            |      |      | ****       |      |      |
| Green Time:               | 9.3         | 65.5 | 65.5 | 11.5        | 67.8 | 67.8 | 14.0       | 14.0 | 14.0 | 14.0       | 14.0 | 14.0 |
| Volume/Cap:               | 0.83        | 0.61 | 0.61 | 0.20        | 0.83 | 0.83 | 0.69       | 0.69 | 0.39 | 0.83       | 0.83 | 0.12 |
| Delay/Veh:                | 73.6        | 10.3 | 10.3 | 40.6        | 14.4 | 14.4 | 48.8       | 48.8 | 40.2 | 62.3       | 62.3 | 37.9 |
| User DelAdj:              | 1.00        | 1.00 | 1.00 | 1.00        | 1.00 | 1.00 | 1.00       | 1.00 | 1.00 | 1.00       | 1.00 | 1.00 |
| AdjDel/Veh:               | 73.6        | 10.3 | 10.3 | 40.6        | 14.4 | 14.4 | 48.8       | 48.8 | 40.2 | 62.3       | 62.3 | 37.9 |
| LOS by Move:              | E           | B    | B    | D           | B    | B    | D          | D    | D    | E          | E    | D    |
| HCM2k95thQ:               | 10          | 23   | 23   | 2           | 39   | 39   | 11         | 11   | 6    | 17         | 17   | 2    |

Note: Queue reported is the number of cars per lane.

BART

Level Of Service Computation Report  
 2000 HCM Operations (Future Volume Alternative)  
 AM - Cumulative No Project

Intersection #3016: 101/ALUM ROCK [Study Int 15]

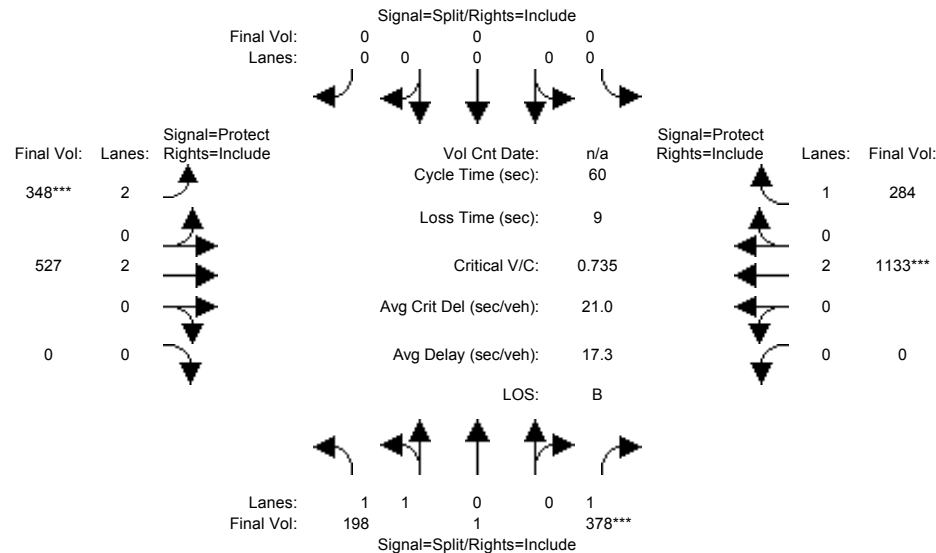

| Approach:                 | North Bound |      |      | South Bound |      |      | East Bound |      |      | West Bound |      |      |
|---------------------------|-------------|------|------|-------------|------|------|------------|------|------|------------|------|------|
| Movement:                 | L           | T    | R    | L           | T    | R    | L          | T    | R    | L          | T    | R    |
| Min. Green:               | 10          | 10   | 10   | 0           | 0    | 0    | 7          | 10   | 0    | 0          | 10   | 10   |
| Y+R:                      | 4.0         | 4.0  | 4.0  | 4.0         | 4.0  | 4.0  | 4.0        | 4.0  | 4.0  | 4.0        | 4.0  | 4.0  |
| Volume Module:            |             |      |      |             |      |      |            |      |      |            |      |      |
| Base Vol:                 | 198         | 1    | 378  | 0           | 0    | 0    | 348        | 527  | 0    | 0          | 1133 | 284  |
| Growth Adj:               | 1.00        | 1.00 | 1.00 | 1.00        | 1.00 | 1.00 | 1.00       | 1.00 | 1.00 | 1.00       | 1.00 | 1.00 |
| Initial Bse:              | 198         | 1    | 378  | 0           | 0    | 0    | 348        | 527  | 0    | 0          | 1133 | 284  |
| Added Vol:                | 0           | 0    | 0    | 0           | 0    | 0    | 0          | 0    | 0    | 0          | 0    | 0    |
| PasserByVol:              | 0           | 0    | 0    | 0           | 0    | 0    | 0          | 0    | 0    | 0          | 0    | 0    |
| Initial Fut:              | 198         | 1    | 378  | 0           | 0    | 0    | 348        | 527  | 0    | 0          | 1133 | 284  |
| User Adj:                 | 1.00        | 1.00 | 1.00 | 1.00        | 1.00 | 1.00 | 1.00       | 1.00 | 1.00 | 1.00       | 1.00 | 1.00 |
| PHF Adj:                  | 1.00        | 1.00 | 1.00 | 1.00        | 1.00 | 1.00 | 1.00       | 1.00 | 1.00 | 1.00       | 1.00 | 1.00 |
| PHF Volume:               | 198         | 1    | 378  | 0           | 0    | 0    | 348        | 527  | 0    | 0          | 1133 | 284  |
| Reduct Vol:               | 0           | 0    | 0    | 0           | 0    | 0    | 0          | 0    | 0    | 0          | 0    | 0    |
| Reduced Vol:              | 198         | 1    | 378  | 0           | 0    | 0    | 348        | 527  | 0    | 0          | 1133 | 284  |
| PCE Adj:                  | 1.00        | 1.00 | 1.00 | 1.00        | 1.00 | 1.00 | 1.00       | 1.00 | 1.00 | 1.00       | 1.00 | 1.00 |
| MLF Adj:                  | 1.00        | 1.00 | 1.00 | 1.00        | 1.00 | 1.00 | 1.00       | 1.00 | 1.00 | 1.00       | 1.00 | 1.00 |
| FinalVolume:              | 198         | 1    | 378  | 0           | 0    | 0    | 348        | 527  | 0    | 0          | 1133 | 284  |
| Saturation Flow Module:   |             |      |      |             |      |      |            |      |      |            |      |      |
| Sat/Lane:                 | 1900        | 1900 | 1900 | 1900        | 1900 | 1900 | 1900       | 1900 | 1900 | 1900       | 1900 | 1900 |
| Adjustment:               | 0.93        | 0.95 | 0.92 | 0.92        | 1.00 | 0.92 | 0.83       | 1.00 | 0.92 | 0.92       | 1.00 | 0.92 |
| Lanes:                    | 1.99        | 0.01 | 1.00 | 0.00        | 0.00 | 0.00 | 2.00       | 2.00 | 0.00 | 0.00       | 2.00 | 1.00 |
| Final Sat.:               | 3532        | 18   | 1750 | 0           | 0    | 0    | 3150       | 3800 | 0    | 0          | 3800 | 1750 |
| Capacity Analysis Module: |             |      |      |             |      |      |            |      |      |            |      |      |
| Vol/Sat:                  | 0.06        | 0.06 | 0.22 | 0.00        | 0.00 | 0.00 | 0.11       | 0.14 | 0.00 | 0.00       | 0.30 | 0.16 |
| Crit Moves:               | ****        |      |      | ****        |      |      | ****       |      |      | ****       |      |      |
| Green Time:               | 17.6        | 17.6 | 17.6 | 0.0         | 0.0  | 0.0  | 9.0        | 33.4 | 0.0  | 0.0        | 24.3 | 24.3 |
| Volume/Cap:               | 0.19        | 0.19 | 0.73 | 0.00        | 0.00 | 0.00 | 0.73       | 0.25 | 0.00 | 0.00       | 0.73 | 0.40 |
| Delay/Veh:                | 15.9        | 15.9 | 24.5 | 0.0         | 0.0  | 0.0  | 30.3       | 6.9  | 0.0  | 0.0        | 17.0 | 13.0 |
| User DelAdj:              | 1.00        | 1.00 | 1.00 | 1.00        | 1.00 | 1.00 | 1.00       | 1.00 | 1.00 | 1.00       | 1.00 | 1.00 |
| AdjDel/Veh:               | 15.9        | 15.9 | 24.5 | 0.0         | 0.0  | 0.0  | 30.3       | 6.9  | 0.0  | 0.0        | 17.0 | 13.0 |
| LOS by Move:              | B           | B    | C    | A           | A    | A    | C          | A    | A    | A          | B    | B    |
| HCM2k95thQ:               | 3           | 3    | 16   | 0           | 0    | 0    | 8          | 5    | 0    | 0          | 17   | 8    |

Note: Queue reported is the number of cars per lane.



BART

Level Of Service Computation Report  
2000 HCM Operations (Future Volume Alternative)  
PM - Cumulative No Project

Intersection #3016: 101/ALUM ROCK [Study Int 15]

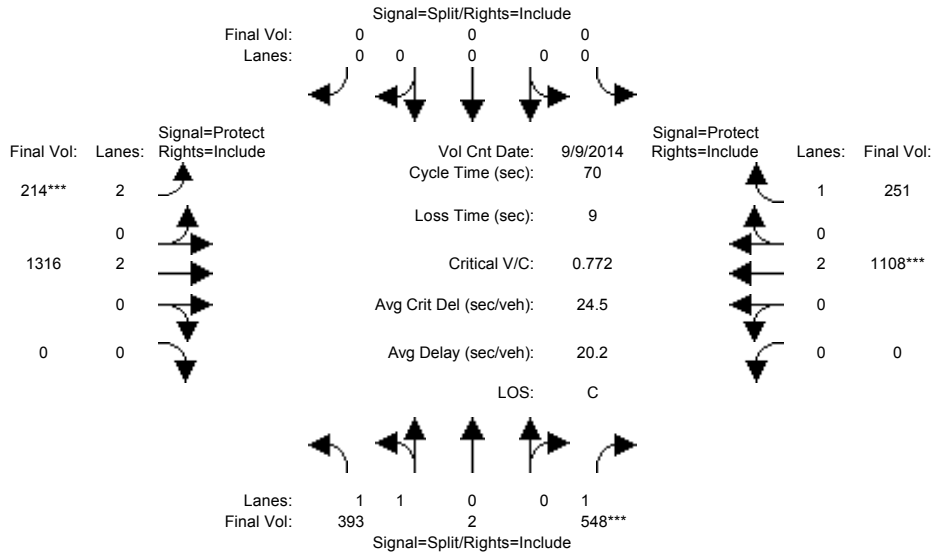

| Approach:                                   | North Bound |      |      | South Bound |      |      | East Bound |      |      | West Bound |      |      |
|---|-------------|------|------|-------------|------|------|------------|------|------|------------|------|------|
| Movement:                                   | L           | T    | R    | L           | T    | R    | L          | T    | R    | L          | T    | R    |
| Min. Green:                                 | 10          | 10   | 10   | 0           | 0    | 0    | 7          | 10   | 0    | 0          | 10   | 10   |
| Y+R:  | 4.0         | 4.0  | 4.0  | 4.0         | 4.0  | 4.0  | 4.0        | 4.0  | 4.0  | 4.0        | 4.0  | 4.0  |
| Volume Module: >> Count Date: 9 Sep 2014 << |             |      |      |             |      |      |            |      |      |            |      |      |
| Base Vol:                                   | 393         | 2    | 548  | 0           | 0    | 0    | 214        | 1316 | 0    | 0          | 1108 | 251  |
| Growth Adj:                                 | 1.00        | 1.00 | 1.00 | 1.00        | 1.00 | 1.00 | 1.00       | 1.00 | 1.00 | 1.00       | 1.00 | 1.00 |
| Initial Bse:                                | 393         | 2    | 548  | 0           | 0    | 0    | 214        | 1316 | 0    | 0          | 1108 | 251  |
| Added Vol:                                  | 0           | 0    | 0    | 0           | 0    | 0    | 0          | 0    | 0    | 0          | 0    | 0    |
| PasserByVol:                                | 0           | 0    | 0    | 0           | 0    | 0    | 0          | 0    | 0    | 0          | 0    | 0    |
| Initial Fut:                                | 393         | 2    | 548  | 0           | 0    | 0    | 214        | 1316 | 0    | 0          | 1108 | 251  |
| User Adj:                                   | 1.00        | 1.00 | 1.00 | 1.00        | 1.00 | 1.00 | 1.00       | 1.00 | 1.00 | 1.00       | 1.00 | 1.00 |
| PHF Adj:                                    | 1.00        | 1.00 | 1.00 | 1.00        | 1.00 | 1.00 | 1.00       | 1.00 | 1.00 | 1.00       | 1.00 | 1.00 |
| PHF Volume:                                 | 393         | 2    | 548  | 0           | 0    | 0    | 214        | 1316 | 0    | 0          | 1108 | 251  |
| Reduct Vol:                                 | 0           | 0    | 0    | 0           | 0    | 0    | 0          | 0    | 0    | 0          | 0    | 0    |
| Reduced Vol:                                | 393         | 2    | 548  | 0           | 0    | 0    | 214        | 1316 | 0    | 0          | 1108 | 251  |
| PCE Adj:                                    | 1.00        | 1.00 | 1.00 | 1.00        | 1.00 | 1.00 | 1.00       | 1.00 | 1.00 | 1.00       | 1.00 | 1.00 |
| MLF Adj:                                    | 1.00        | 1.00 | 1.00 | 1.00        | 1.00 | 1.00 | 1.00       | 1.00 | 1.00 | 1.00       | 1.00 | 1.00 |
| FinalVolume:                                | 393         | 2    | 548  | 0           | 0    | 0    | 214        | 1316 | 0    | 0          | 1108 | 251  |
| Saturation Flow Module:                     |             |      |      |             |      |      |            |      |      |            |      |      |
| Sat/Lane:                                   | 1900        | 1900 | 1900 | 1900        | 1900 | 1900 | 1900       | 1900 | 1900 | 1900       | 1900 | 1900 |
| Adjustment:                                 | 0.93        | 0.95 | 0.92 | 0.92        | 1.00 | 0.92 | 0.83       | 1.00 | 0.92 | 0.92       | 1.00 | 0.92 |
| Lanes:                                      | 1.99        | 0.01 | 1.00 | 0.00        | 0.00 | 0.00 | 2.00       | 2.00 | 0.00 | 0.00       | 2.00 | 1.00 |
| Final Sat.:                                 | 3532        | 18   | 1750 | 0           | 0    | 0    | 3150       | 3800 | 0    | 0          | 3800 | 1750 |
| Capacity Analysis Module:                   |             |      |      |             |      |      |            |      |      |            |      |      |
| Vol/Sat:                                    | 0.11        | 0.11 | 0.31 | 0.00        | 0.00 | 0.00 | 0.07       | 0.35 | 0.00 | 0.00       | 0.29 | 0.14 |
| Crit Moves:                                 | ****        |      |      | ****        |      |      | ****       |      |      | ****       |      |      |
| Green Time:                                 | 28.0        | 28.0 | 28.0 | 0.0         | 0.0  | 0.0  | 7.0        | 33.0 | 0.0  | 0.0        | 26.0 | 26.0 |
| Volume/Cap:                                 | 0.28        | 0.28 | 0.78 | 0.00        | 0.00 | 0.00 | 0.68       | 0.73 | 0.00 | 0.00       | 0.78 | 0.39 |
| Delay/Veh:                                  | 14.3        | 14.3 | 24.2 | 0.0         | 0.0  | 0.0  | 36.3       | 16.5 | 0.0  | 0.0        | 22.4 | 16.5 |
| User DelAdj:                                | 1.00        | 1.00 | 1.00 | 1.00        | 1.00 | 1.00 | 1.00       | 1.00 | 1.00 | 1.00       | 1.00 | 1.00 |
| AdjDel/Veh:                                 | 14.3        | 14.3 | 24.2 | 0.0         | 0.0  | 0.0  | 36.3       | 16.5 | 0.0  | 0.0        | 22.4 | 16.5 |
| LOS by Move:                                | B           | B    | C    | A           | A    | A    | D          | B    | A    | A          | C    | B    |
| HCM2k95thQ:                                 | 6           | 6    | 24   | 0           | 0    | 0    | 6          | 21   | 0    | 0          | 20   | 8    |

Note: Queue reported is the number of cars per lane.

BART

Level Of Service Computation Report  
 2000 HCM Operations (Future Volume Alternative)  
 AM - Cumulative With Project

Intersection #3016: 101/ALUM ROCK [Study Int 15]

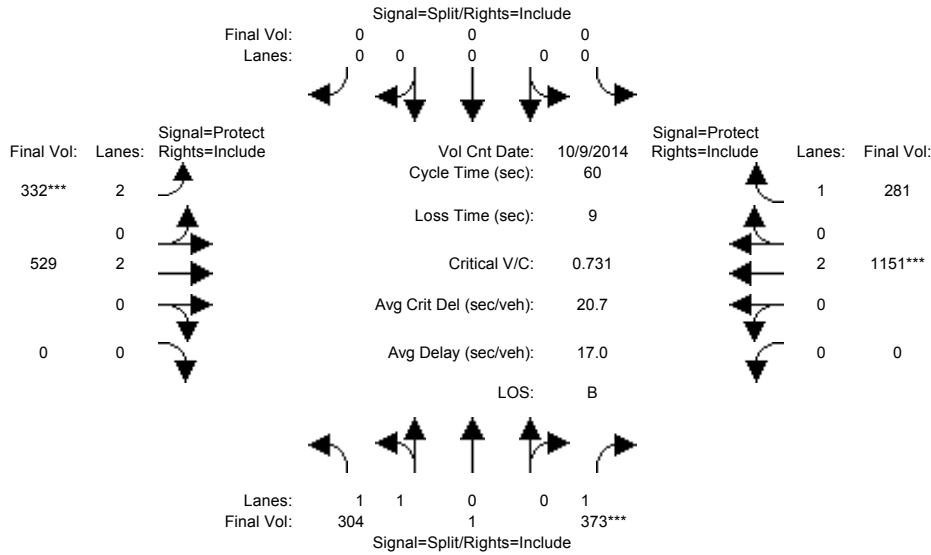

| Approach:                                   | North Bound |      |      | South Bound |      |      | East Bound |      |      | West Bound |      |      |
|---|-------------|------|------|-------------|------|------|------------|------|------|------------|------|------|
| Movement:                                   | L           | T    | R    | L           | T    | R    | L          | T    | R    | L          | T    | R    |
| Min. Green:                                 | 10          | 10   | 10   | 0           | 0    | 0    | 7          | 10   | 0    | 0          | 10   | 10   |
| Y+R:  | 4.0         | 4.0  | 4.0  | 4.0         | 4.0  | 4.0  | 4.0        | 4.0  | 4.0  | 4.0        | 4.0  | 4.0  |
| Volume Module: >> Count Date: 9 Oct 2014 << |             |      |      |             |      |      |            |      |      |            |      |      |
| Base Vol:                                   | 304         | 1    | 373  | 0           | 0    | 0    | 332        | 529  | 0    | 0          | 1151 | 281  |
| Growth Adj:                                 | 1.00        | 1.00 | 1.00 | 1.00        | 1.00 | 1.00 | 1.00       | 1.00 | 1.00 | 1.00       | 1.00 | 1.00 |
| Initial Bse:                                | 304         | 1    | 373  | 0           | 0    | 0    | 332        | 529  | 0    | 0          | 1151 | 281  |
| Added Vol:                                  | 0           | 0    | 0    | 0           | 0    | 0    | 0          | 0    | 0    | 0          | 0    | 0    |
| PasserByVol:                                | 0           | 0    | 0    | 0           | 0    | 0    | 0          | 0    | 0    | 0          | 0    | 0    |
| Initial Fut:                                | 304         | 1    | 373  | 0           | 0    | 0    | 332        | 529  | 0    | 0          | 1151 | 281  |
| User Adj:                                   | 1.00        | 1.00 | 1.00 | 1.00        | 1.00 | 1.00 | 1.00       | 1.00 | 1.00 | 1.00       | 1.00 | 1.00 |
| PHF Adj:                                    | 1.00        | 1.00 | 1.00 | 1.00        | 1.00 | 1.00 | 1.00       | 1.00 | 1.00 | 1.00       | 1.00 | 1.00 |
| PHF Volume:                                 | 304         | 1    | 373  | 0           | 0    | 0    | 332        | 529  | 0    | 0          | 1151 | 281  |
| Reduct Vol:                                 | 0           | 0    | 0    | 0           | 0    | 0    | 0          | 0    | 0    | 0          | 0    | 0    |
| Reduced Vol:                                | 304         | 1    | 373  | 0           | 0    | 0    | 332        | 529  | 0    | 0          | 1151 | 281  |
| PCE Adj:                                    | 1.00        | 1.00 | 1.00 | 1.00        | 1.00 | 1.00 | 1.00       | 1.00 | 1.00 | 1.00       | 1.00 | 1.00 |
| MLF Adj:                                    | 1.00        | 1.00 | 1.00 | 1.00        | 1.00 | 1.00 | 1.00       | 1.00 | 1.00 | 1.00       | 1.00 | 1.00 |
| Final Volume:                               | 304         | 1    | 373  | 0           | 0    | 0    | 332        | 529  | 0    | 0          | 1151 | 281  |
| Saturation Flow Module:                     |             |      |      |             |      |      |            |      |      |            |      |      |
| Sat/Lane:                                   | 1900        | 1900 | 1900 | 1900        | 1900 | 1900 | 1900       | 1900 | 1900 | 1900       | 1900 | 1900 |
| Adjustment:                                 | 0.93        | 0.95 | 0.92 | 0.92        | 1.00 | 0.92 | 0.83       | 1.00 | 0.92 | 0.92       | 1.00 | 0.92 |
| Lanes:                                      | 1.99        | 0.01 | 1.00 | 0.00        | 0.00 | 0.00 | 2.00       | 2.00 | 0.00 | 0.00       | 2.00 | 1.00 |
| Final Sat.:                                 | 3538        | 12   | 1750 | 0           | 0    | 0    | 3150       | 3800 | 0    | 0          | 3800 | 1750 |
| Capacity Analysis Module:                   |             |      |      |             |      |      |            |      |      |            |      |      |
| Vol/Sat:                                    | 0.09        | 0.09 | 0.21 | 0.00        | 0.00 | 0.00 | 0.11       | 0.14 | 0.00 | 0.00       | 0.30 | 0.16 |
| Crit Moves:                                 | ****        |      |      | ****        |      |      | ****       |      |      | ****       |      |      |
| Green Time:                                 | 17.5        | 17.5 | 17.5 | 0.0         | 0.0  | 0.0  | 8.6        | 33.5 | 0.0  | 0.0        | 24.9 | 24.9 |
| Volume/Cap:                                 | 0.29        | 0.29 | 0.73 | 0.00        | 0.00 | 0.00 | 0.73       | 0.25 | 0.00 | 0.00       | 0.73 | 0.39 |
| Delay/Veh:                                  | 16.6        | 16.6 | 24.5 | 0.0         | 0.0  | 0.0  | 30.6       | 6.9  | 0.0  | 0.0        | 16.6 | 12.6 |
| User DelAdj:                                | 1.00        | 1.00 | 1.00 | 1.00        | 1.00 | 1.00 | 1.00       | 1.00 | 1.00 | 1.00       | 1.00 | 1.00 |
| AdjDel/Veh:                                 | 16.6        | 16.6 | 24.5 | 0.0         | 0.0  | 0.0  | 30.6       | 6.9  | 0.0  | 0.0        | 16.6 | 12.6 |
| LOS by Move:                                | B           | B    | C    | A           | A    | A    | C          | A    | A    | A          | B    | B    |
| HCM2k95thQ:                                 | 5           | 5    | 16   | 0           | 0    | 0    | 8          | 5    | 0    | 0          | 17   | 8    |

Note: Queue reported is the number of cars per lane.

BART

Level Of Service Computation Report  
 2000 HCM Operations (Future Volume Alternative)  
 PM - Cumulative With Project

Intersection #3016: 101/ALUM ROCK [Study Int 15]

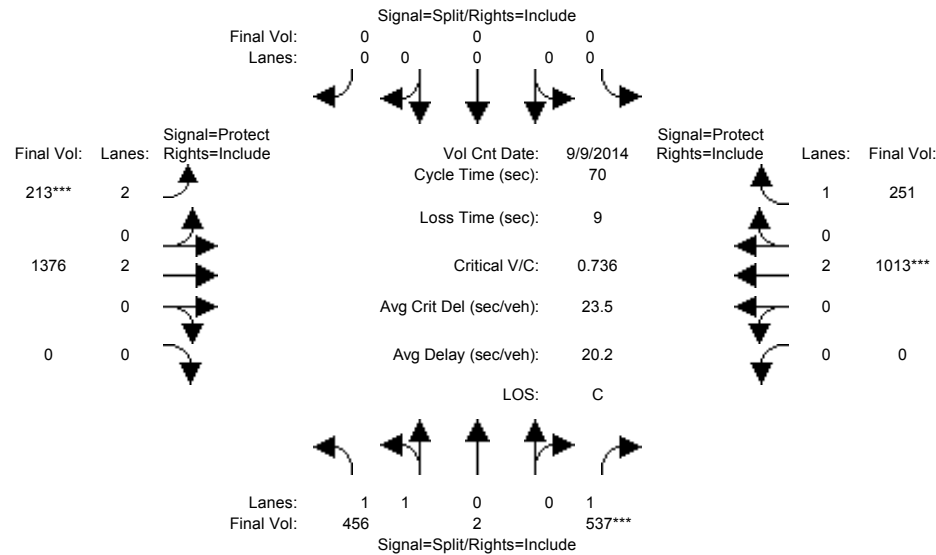

| Approach:                                   | North Bound |      |      | South Bound |      |      | East Bound |      |      | West Bound |      |      |
|---|-------------|------|------|-------------|------|------|------------|------|------|------------|------|------|
| Movement:                                   | L           | T    | R    | L           | T    | R    | L          | T    | R    | L          | T    | R    |
| Min. Green:                                 | 10          | 10   | 10   | 0           | 0    | 0    | 7          | 10   | 0    | 0          | 10   | 10   |
| Y+R:  | 4.0         | 4.0  | 4.0  | 4.0         | 4.0  | 4.0  | 4.0        | 4.0  | 4.0  | 4.0        | 4.0  | 4.0  |
| Volume Module: >> Count Date: 9 Sep 2014 << |             |      |      |             |      |      |            |      |      |            |      |      |
| Base Vol:                                   | 456         | 2    | 537  | 0           | 0    | 0    | 213        | 1376 | 0    | 0          | 1013 | 251  |
| Growth Adj:                                 | 1.00        | 1.00 | 1.00 | 1.00        | 1.00 | 1.00 | 1.00       | 1.00 | 1.00 | 1.00       | 1.00 | 1.00 |
| Initial Bse:                                | 456         | 2    | 537  | 0           | 0    | 0    | 213        | 1376 | 0    | 0          | 1013 | 251  |
| Added Vol:                                  | 0           | 0    | 0    | 0           | 0    | 0    | 0          | 0    | 0    | 0          | 0    | 0    |
| PasserByVol:                                | 0           | 0    | 0    | 0           | 0    | 0    | 0          | 0    | 0    | 0          | 0    | 0    |
| Initial Fut:                                | 456         | 2    | 537  | 0           | 0    | 0    | 213        | 1376 | 0    | 0          | 1013 | 251  |
| User Adj:                                   | 1.00        | 1.00 | 1.00 | 1.00        | 1.00 | 1.00 | 1.00       | 1.00 | 1.00 | 1.00       | 1.00 | 1.00 |
| PHF Adj:                                    | 1.00        | 1.00 | 1.00 | 1.00        | 1.00 | 1.00 | 1.00       | 1.00 | 1.00 | 1.00       | 1.00 | 1.00 |
| PHF Volume:                                 | 456         | 2    | 537  | 0           | 0    | 0    | 213        | 1376 | 0    | 0          | 1013 | 251  |
| Reduct Vol:                                 | 0           | 0    | 0    | 0           | 0    | 0    | 0          | 0    | 0    | 0          | 0    | 0    |
| Reduced Vol:                                | 456         | 2    | 537  | 0           | 0    | 0    | 213        | 1376 | 0    | 0          | 1013 | 251  |
| PCE Adj:                                    | 1.00        | 1.00 | 1.00 | 1.00        | 1.00 | 1.00 | 1.00       | 1.00 | 1.00 | 1.00       | 1.00 | 1.00 |
| MLF Adj:                                    | 1.00        | 1.00 | 1.00 | 1.00        | 1.00 | 1.00 | 1.00       | 1.00 | 1.00 | 1.00       | 1.00 | 1.00 |
| FinalVolume:                                | 456         | 2    | 537  | 0           | 0    | 0    | 213        | 1376 | 0    | 0          | 1013 | 251  |
| Saturation Flow Module:                     |             |      |      |             |      |      |            |      |      |            |      |      |
| Sat/Lane:                                   | 1900        | 1900 | 1900 | 1900        | 1900 | 1900 | 1900       | 1900 | 1900 | 1900       | 1900 | 1900 |
| Adjustment:                                 | 0.93        | 0.95 | 0.92 | 0.92        | 1.00 | 0.92 | 0.83       | 1.00 | 0.92 | 0.92       | 1.00 | 0.92 |
| Lanes:                                      | 1.99        | 0.01 | 1.00 | 0.00        | 0.00 | 0.00 | 2.00       | 2.00 | 0.00 | 0.00       | 2.00 | 1.00 |
| Final Sat.:                                 | 3534        | 16   | 1750 | 0           | 0    | 0    | 3150       | 3800 | 0    | 0          | 3800 | 1750 |
| Capacity Analysis Module:                   |             |      |      |             |      |      |            |      |      |            |      |      |
| Vol/Sat:                                    | 0.13        | 0.13 | 0.31 | 0.00        | 0.00 | 0.00 | 0.07       | 0.36 | 0.00 | 0.00       | 0.27 | 0.14 |
| Crit Moves:                                 | ****        |      |      | ****        |      |      | ****       |      |      | ****       |      |      |
| Green Time:                                 | 28.9        | 28.9 | 28.9 | 0.0         | 0.0  | 0.0  | 7.0        | 32.1 | 0.0  | 0.0        | 25.1 | 25.1 |
| Volume/Cap:                                 | 0.31        | 0.31 | 0.74 | 0.00        | 0.00 | 0.00 | 0.68       | 0.79 | 0.00 | 0.00       | 0.74 | 0.40 |
| Delay/Veh:                                  | 14.0        | 14.0 | 21.6 | 0.0         | 0.0  | 0.0  | 36.2       | 18.6 | 0.0  | 0.0        | 21.9 | 17.2 |
| User DelAdj:                                | 1.00        | 1.00 | 1.00 | 1.00        | 1.00 | 1.00 | 1.00       | 1.00 | 1.00 | 1.00       | 1.00 | 1.00 |
| AdjDel/Veh:                                 | 14.0        | 14.0 | 21.6 | 0.0         | 0.0  | 0.0  | 36.2       | 18.6 | 0.0  | 0.0        | 21.9 | 17.2 |
| LOS by Move:                                | B           | B    | C    | A           | A    | A    | D          | B    | A    | A          | C    | B    |
| HCM2k95thQ:                                 | 7           | 7    | 22   | 0           | 0    | 0    | 6          | 23   | 0    | 0          | 18   | 8    |

Note: Queue reported is the number of cars per lane.

BART

Level Of Service Computation Report  
 2000 HCM Operations (Future Volume Alternative)  
 AM - Cumulative No Project

Intersection #3023: 101/SANTA CLARA [Study Int 14]

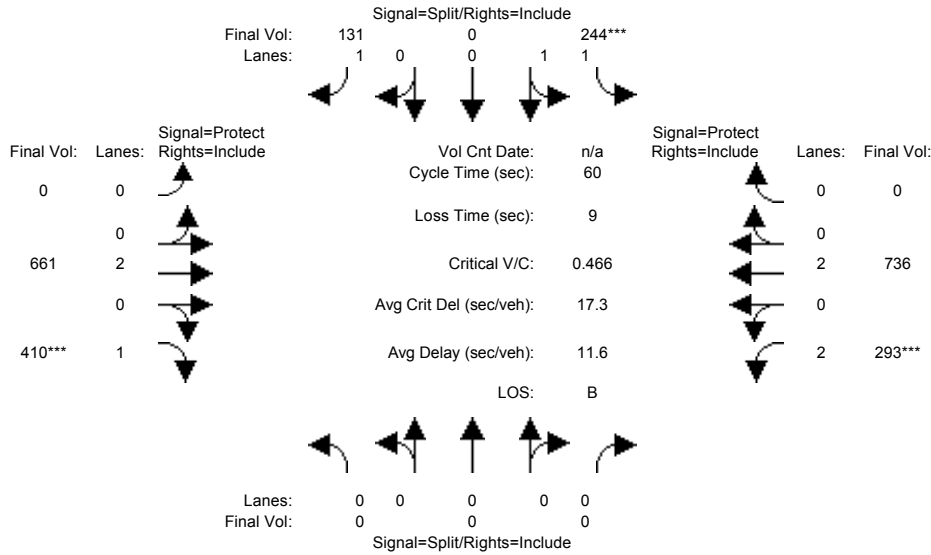

| Approach:                 | North Bound |      |      | South Bound |      |      | East Bound |      |      | West Bound |      |      |
|---------------------------|-------------|------|------|-------------|------|------|------------|------|------|------------|------|------|
| Movement:                 | L           | T    | R    | L           | T    | R    | L          | T    | R    | L          | T    | R    |
| Min. Green:               | 0           | 0    | 0    | 10          | 10   | 10   | 0          | 10   | 10   | 7          | 10   | 0    |
| Y+R:                      | 4.0         | 4.0  | 4.0  | 4.0         | 4.0  | 4.0  | 4.0        | 4.0  | 4.0  | 4.0        | 4.0  | 4.0  |
| Volume Module:            |             |      |      |             |      |      |            |      |      |            |      |      |
| Base Vol:                 | 0           | 0    | 0    | 244         | 0    | 131  | 0          | 661  | 410  | 293        | 736  | 0    |
| Growth Adj:               | 1.00        | 1.00 | 1.00 | 1.00        | 1.00 | 1.00 | 1.00       | 1.00 | 1.00 | 1.00       | 1.00 | 1.00 |
| Initial Bse:              | 0           | 0    | 0    | 244         | 0    | 131  | 0          | 661  | 410  | 293        | 736  | 0    |
| Added Vol:                | 0           | 0    | 0    | 0           | 0    | 0    | 0          | 0    | 0    | 0          | 0    | 0    |
| PasserByVol:              | 0           | 0    | 0    | 0           | 0    | 0    | 0          | 0    | 0    | 0          | 0    | 0    |
| Initial Fut:              | 0           | 0    | 0    | 244         | 0    | 131  | 0          | 661  | 410  | 293        | 736  | 0    |
| User Adj:                 | 1.00        | 1.00 | 1.00 | 1.00        | 1.00 | 1.00 | 1.00       | 1.00 | 1.00 | 1.00       | 1.00 | 1.00 |
| PHF Adj:                  | 1.00        | 1.00 | 1.00 | 1.00        | 1.00 | 1.00 | 1.00       | 1.00 | 1.00 | 1.00       | 1.00 | 1.00 |
| PHF Volume:               | 0           | 0    | 0    | 244         | 0    | 131  | 0          | 661  | 410  | 293        | 736  | 0    |
| Reduct Vol:               | 0           | 0    | 0    | 0           | 0    | 0    | 0          | 0    | 0    | 0          | 0    | 0    |
| Reduced Vol:              | 0           | 0    | 0    | 244         | 0    | 131  | 0          | 661  | 410  | 293        | 736  | 0    |
| PCE Adj:                  | 1.00        | 1.00 | 1.00 | 1.00        | 1.00 | 1.00 | 1.00       | 1.00 | 1.00 | 1.00       | 1.00 | 1.00 |
| MLF Adj:                  | 1.00        | 1.00 | 1.00 | 1.00        | 1.00 | 1.00 | 1.00       | 1.00 | 1.00 | 1.00       | 1.00 | 1.00 |
| FinalVolume:              | 0           | 0    | 0    | 244         | 0    | 131  | 0          | 661  | 410  | 293        | 736  | 0    |
| Saturation Flow Module:   |             |      |      |             |      |      |            |      |      |            |      |      |
| Sat/Lane:                 | 1900        | 1900 | 1900 | 1900        | 1900 | 1900 | 1900       | 1900 | 1900 | 1900       | 1900 | 1900 |
| Adjustment:               | 0.92        | 1.00 | 0.92 | 0.93        | 1.00 | 0.92 | 0.92       | 1.00 | 0.92 | 0.83       | 1.00 | 0.92 |
| Lanes:                    | 0.00        | 0.00 | 0.00 | 2.00        | 0.00 | 1.00 | 0.00       | 2.00 | 1.00 | 2.00       | 2.00 | 0.00 |
| Final Sat.:               | 0           | 0    | 0    | 3550        | 0    | 1750 | 0          | 3800 | 1750 | 3150       | 3800 | 0    |
| Capacity Analysis Module: |             |      |      |             |      |      |            |      |      |            |      |      |
| Vol/Sat:                  | 0.00        | 0.00 | 0.00 | 0.07        | 0.00 | 0.07 | 0.00       | 0.17 | 0.23 | 0.09       | 0.19 | 0.00 |
| Crit Moves:               |             |      |      | ****        |      |      |            |      | **** | ****       |      |      |
| Green Time:               | 0.0         | 0.0  | 0.0  | 10.0        | 0.0  | 10.0 | 0.0        | 29.3 | 29.3 | 11.7       | 41.0 | 0.0  |
| Volume/Cap:               | 0.00        | 0.00 | 0.00 | 0.41        | 0.00 | 0.45 | 0.00       | 0.36 | 0.48 | 0.48       | 0.28 | 0.00 |
| Delay/Veh:                | 0.0         | 0.0  | 0.0  | 22.8        | 0.0  | 23.6 | 0.0        | 9.6  | 10.6 | 22.1       | 3.8  | 0.0  |
| User DelAdj:              | 1.00        | 1.00 | 1.00 | 1.00        | 1.00 | 1.00 | 1.00       | 1.00 | 1.00 | 1.00       | 1.00 | 1.00 |
| AdjDel/Veh:               | 0.0         | 0.0  | 0.0  | 22.8        | 0.0  | 23.6 | 0.0        | 9.6  | 10.6 | 22.1       | 3.8  | 0.0  |
| LOS by Move:              | A           | A    | A    | C           | A    | C    | A          | A    | B    | C          | A    | A    |
| HCM2k95thQ:               | 0           | 0    | 0    | 5           | 0    | 6    | 0          | 7    | 10   | 6          | 5    | 0    |

Note: Queue reported is the number of cars per lane.

BART

Level Of Service Computation Report  
 2000 HCM Operations (Future Volume Alternative)  
 PM - Cumulative No Project

Intersection #3023: 101/SANTA CLARA [Study Int 14]

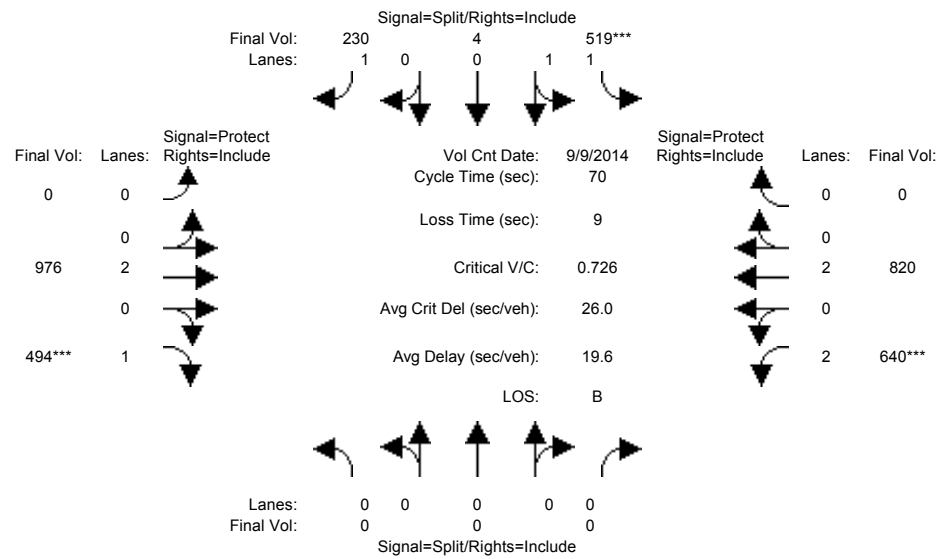

| Approach:                                   | North Bound |      |      | South Bound |      |      | East Bound |      |      | West Bound |      |      |
|---|-------------|------|------|-------------|------|------|------------|------|------|------------|------|------|
| Movement:                                   | L           | T    | R    | L           | T    | R    | L          | T    | R    | L          | T    | R    |
| Min. Green:                                 | 0           | 0    | 0    | 10          | 10   | 10   | 0          | 10   | 10   | 7          | 10   | 0    |
| Y+R:  | 4.0         | 4.0  | 4.0  | 4.0         | 4.0  | 4.0  | 4.0        | 4.0  | 4.0  | 4.0        | 4.0  | 4.0  |
| Volume Module: >> Count Date: 9 Sep 2014 << |             |      |      |             |      |      |            |      |      |            |      |      |
| Base Vol:                                   | 0           | 0    | 0    | 519         | 4    | 230  | 0          | 976  | 494  | 640        | 820  | 0    |
| Growth Adj:                                 | 1.00        | 1.00 | 1.00 | 1.00        | 1.00 | 1.00 | 1.00       | 1.00 | 1.00 | 1.00       | 1.00 | 1.00 |
| Initial Bse:                                | 0           | 0    | 0    | 519         | 4    | 230  | 0          | 976  | 494  | 640        | 820  | 0    |
| Added Vol:                                  | 0           | 0    | 0    | 0           | 0    | 0    | 0          | 0    | 0    | 0          | 0    | 0    |
| PasserByVol:                                | 0           | 0    | 0    | 0           | 0    | 0    | 0          | 0    | 0    | 0          | 0    | 0    |
| Initial Fut:                                | 0           | 0    | 0    | 519         | 4    | 230  | 0          | 976  | 494  | 640        | 820  | 0    |
| User Adj:                                   | 1.00        | 1.00 | 1.00 | 1.00        | 1.00 | 1.00 | 1.00       | 1.00 | 1.00 | 1.00       | 1.00 | 1.00 |
| PHF Adj:                                    | 1.00        | 1.00 | 1.00 | 1.00        | 1.00 | 1.00 | 1.00       | 1.00 | 1.00 | 1.00       | 1.00 | 1.00 |
| PHF Volume:                                 | 0           | 0    | 0    | 519         | 4    | 230  | 0          | 976  | 494  | 640        | 820  | 0    |
| Reduct Vol:                                 | 0           | 0    | 0    | 0           | 0    | 0    | 0          | 0    | 0    | 0          | 0    | 0    |
| Reduced Vol:                                | 0           | 0    | 0    | 519         | 4    | 230  | 0          | 976  | 494  | 640        | 820  | 0    |
| PCE Adj:                                    | 1.00        | 1.00 | 1.00 | 1.00        | 1.00 | 1.00 | 1.00       | 1.00 | 1.00 | 1.00       | 1.00 | 1.00 |
| MLF Adj:                                    | 1.00        | 1.00 | 1.00 | 1.00        | 1.00 | 1.00 | 1.00       | 1.00 | 1.00 | 1.00       | 1.00 | 1.00 |
| FinalVolume:                                | 0           | 0    | 0    | 519         | 4    | 230  | 0          | 976  | 494  | 640        | 820  | 0    |
| Saturation Flow Module:                     |             |      |      |             |      |      |            |      |      |            |      |      |
| Sat/Lane:                                   | 1900        | 1900 | 1900 | 1900        | 1900 | 1900 | 1900       | 1900 | 1900 | 1900       | 1900 | 1900 |
| Adjustment:                                 | 0.92        | 1.00 | 0.92 | 0.93        | 0.95 | 0.92 | 0.92       | 1.00 | 0.92 | 0.83       | 1.00 | 0.92 |
| Lanes:                                      | 0.00        | 0.00 | 0.00 | 1.98        | 0.02 | 1.00 | 0.00       | 2.00 | 1.00 | 2.00       | 2.00 | 0.00 |
| Final Sat.:                                 | 0           | 0    | 0    | 3523        | 27   | 1750 | 0          | 3800 | 1750 | 3150       | 3800 | 0    |
| Capacity Analysis Module:                   |             |      |      |             |      |      |            |      |      |            |      |      |
| Vol/Sat:                                    | 0.00        | 0.00 | 0.00 | 0.15        | 0.15 | 0.13 | 0.00       | 0.26 | 0.28 | 0.20       | 0.22 | 0.00 |
| Crit Moves:                                 |             |      |      | ****        |      |      | ****       |      | **** | ****       |      |      |
| Green Time:                                 | 0.0         | 0.0  | 0.0  | 14.2        | 14.2 | 14.2 | 0.0        | 27.2 | 27.2 | 19.6       | 46.8 | 0.0  |
| Volume/Cap:                                 | 0.00        | 0.00 | 0.00 | 0.73        | 0.73 | 0.65 | 0.00       | 0.66 | 0.73 | 0.73       | 0.32 | 0.00 |
| Delay/Veh:                                  | 0.0         | 0.0  | 0.0  | 29.8        | 29.8 | 29.8 | 0.0        | 18.7 | 22.1 | 25.8       | 5.0  | 0.0  |
| User DelAdj:                                | 1.00        | 1.00 | 1.00 | 1.00        | 1.00 | 1.00 | 1.00       | 1.00 | 1.00 | 1.00       | 1.00 | 1.00 |
| AdjDel/Veh:                                 | 0.0         | 0.0  | 0.0  | 29.8        | 29.8 | 29.8 | 0.0        | 18.7 | 22.1 | 25.8       | 5.0  | 0.0  |
| LOS by Move:                                | A           | A    | A    | C           | C    | C    | A          | B    | C    | C          | A    | A    |
| HCM2k95thQ:                                 | 0           | 0    | 0    | 14          | 14   | 12   | 0          | 16   | 18   | 14         | 7    | 0    |

Note: Queue reported is the number of cars per lane.

BART

Level Of Service Computation Report  
 2000 HCM Operations (Future Volume Alternative)  
 AM - Cumulative With Project

Intersection #3023: 101/SANTA CLARA [Study Int 14]

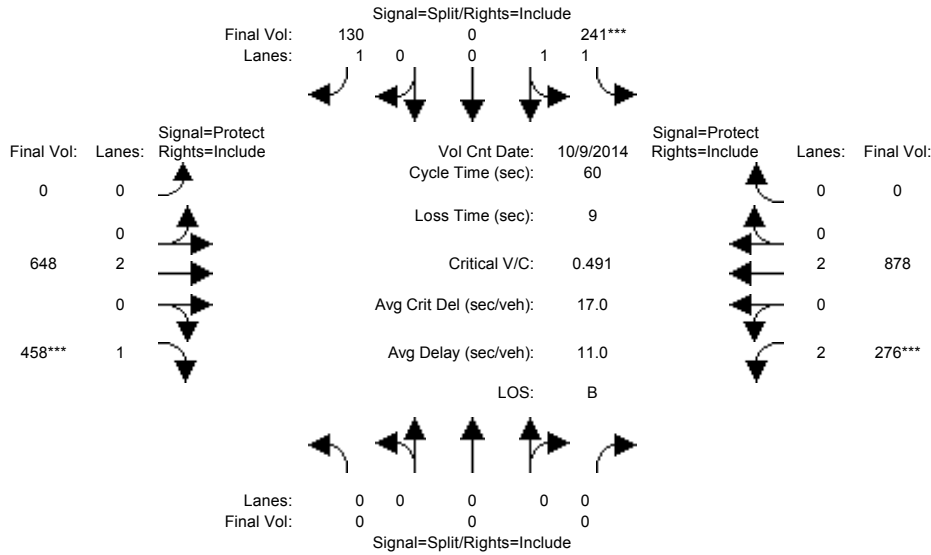

| Approach:                                   | North Bound |      |      | South Bound |      |      | East Bound |      |      | West Bound |      |      |
|---|-------------|------|------|-------------|------|------|------------|------|------|------------|------|------|
| Movement:                                   | L           | T    | R    | L           | T    | R    | L          | T    | R    | L          | T    | R    |
| Min. Green:                                 | 0           | 0    | 0    | 10          | 10   | 10   | 0          | 10   | 10   | 7          | 10   | 0    |
| Y+R:  | 4.0         | 4.0  | 4.0  | 4.0         | 4.0  | 4.0  | 4.0        | 4.0  | 4.0  | 4.0        | 4.0  | 4.0  |
| Volume Module: >> Count Date: 9 Oct 2014 << |             |      |      |             |      |      |            |      |      |            |      |      |
| Base Vol:                                   | 0           | 0    | 0    | 241         | 0    | 130  | 0          | 648  | 458  | 276        | 878  | 0    |
| Growth Adj:                                 | 1.00        | 1.00 | 1.00 | 1.00        | 1.00 | 1.00 | 1.00       | 1.00 | 1.00 | 1.00       | 1.00 | 1.00 |
| Initial Bse:                                | 0           | 0    | 0    | 241         | 0    | 130  | 0          | 648  | 458  | 276        | 878  | 0    |
| Added Vol:                                  | 0           | 0    | 0    | 0           | 0    | 0    | 0          | 0    | 0    | 0          | 0    | 0    |
| PasserByVol:                                | 0           | 0    | 0    | 0           | 0    | 0    | 0          | 0    | 0    | 0          | 0    | 0    |
| Initial Fut:                                | 0           | 0    | 0    | 241         | 0    | 130  | 0          | 648  | 458  | 276        | 878  | 0    |
| User Adj:                                   | 1.00        | 1.00 | 1.00 | 1.00        | 1.00 | 1.00 | 1.00       | 1.00 | 1.00 | 1.00       | 1.00 | 1.00 |
| PHF Adj:                                    | 1.00        | 1.00 | 1.00 | 1.00        | 1.00 | 1.00 | 1.00       | 1.00 | 1.00 | 1.00       | 1.00 | 1.00 |
| PHF Volume:                                 | 0           | 0    | 0    | 241         | 0    | 130  | 0          | 648  | 458  | 276        | 878  | 0    |
| Reduct Vol:                                 | 0           | 0    | 0    | 0           | 0    | 0    | 0          | 0    | 0    | 0          | 0    | 0    |
| Reduced Vol:                                | 0           | 0    | 0    | 241         | 0    | 130  | 0          | 648  | 458  | 276        | 878  | 0    |
| PCE Adj:                                    | 1.00        | 1.00 | 1.00 | 1.00        | 1.00 | 1.00 | 1.00       | 1.00 | 1.00 | 1.00       | 1.00 | 1.00 |
| MLF Adj:                                    | 1.00        | 1.00 | 1.00 | 1.00        | 1.00 | 1.00 | 1.00       | 1.00 | 1.00 | 1.00       | 1.00 | 1.00 |
| FinalVolume:                                | 0           | 0    | 0    | 241         | 0    | 130  | 0          | 648  | 458  | 276        | 878  | 0    |
| Saturation Flow Module:                     |             |      |      |             |      |      |            |      |      |            |      |      |
| Sat/Lane:                                   | 1900        | 1900 | 1900 | 1900        | 1900 | 1900 | 1900       | 1900 | 1900 | 1900       | 1900 | 1900 |
| Adjustment:                                 | 0.92        | 1.00 | 0.92 | 0.93        | 1.00 | 0.92 | 0.92       | 1.00 | 0.92 | 0.83       | 1.00 | 0.92 |
| Lanes:                                      | 0.00        | 0.00 | 0.00 | 2.00        | 0.00 | 1.00 | 0.00       | 2.00 | 1.00 | 2.00       | 2.00 | 0.00 |
| Final Sat.:                                 | 0           | 0    | 0    | 3550        | 0    | 1750 | 0          | 3800 | 1750 | 3150       | 3800 | 0    |
| Capacity Analysis Module:                   |             |      |      |             |      |      |            |      |      |            |      |      |
| Vol/Sat:                                    | 0.00        | 0.00 | 0.00 | 0.07        | 0.00 | 0.07 | 0.00       | 0.17 | 0.26 | 0.09       | 0.23 | 0.00 |
| Crit Moves:                                 | ****        |      |      |             |      |      |            |      |      |            |      |      |
| Green Time:                                 | 0.0         | 0.0  | 0.0  | 10.0        | 0.0  | 10.0 | 0.0        | 30.7 | 30.7 | 10.3       | 41.0 | 0.0  |
| Volume/Cap:                                 | 0.00        | 0.00 | 0.00 | 0.41        | 0.00 | 0.45 | 0.00       | 0.33 | 0.51 | 0.51       | 0.34 | 0.00 |
| Delay/Veh:                                  | 0.0         | 0.0  | 0.0  | 22.8        | 0.0  | 23.6 | 0.0        | 8.7  | 10.2 | 23.4       | 4.0  | 0.0  |
| User DelAdj:                                | 1.00        | 1.00 | 1.00 | 1.00        | 1.00 | 1.00 | 1.00       | 1.00 | 1.00 | 1.00       | 1.00 | 1.00 |
| AdjDel/Veh:                                 | 0.0         | 0.0  | 0.0  | 22.8        | 0.0  | 23.6 | 0.0        | 8.7  | 10.2 | 23.4       | 4.0  | 0.0  |
| LOS by Move:                                | A           | A    | A    | C           | A    | C    | A          | A    | B    | C          | A    | A    |
| HCM2k95thQ:                                 | 0           | 0    | 0    | 5           | 0    | 6    | 0          | 7    | 11   | 5          | 6    | 0    |

Note: Queue reported is the number of cars per lane.

BART

Level Of Service Computation Report  
 2000 HCM Operations (Future Volume Alternative)  
 PM - Cumulative With Project

Intersection #3023: 101/SANTA CLARA [Study Int 14]

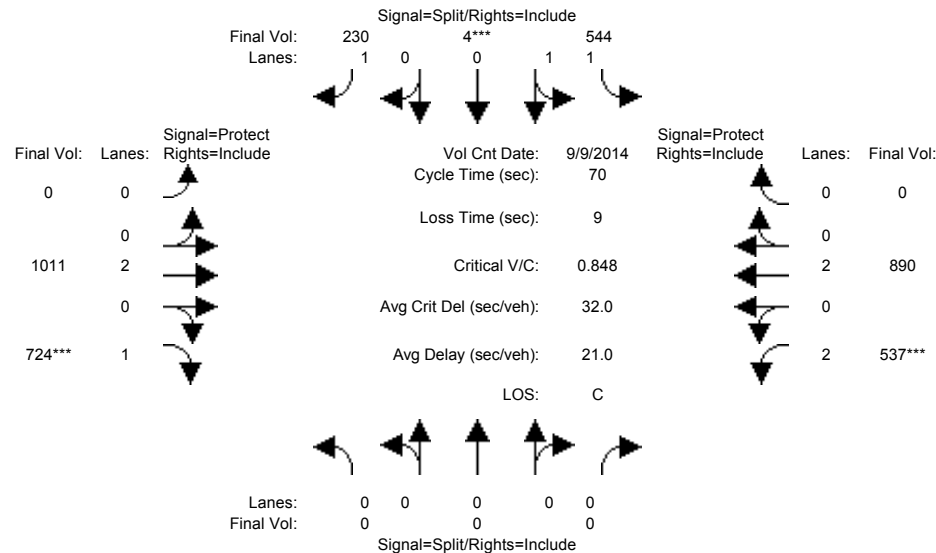

| Approach:                                   | North Bound |      |      | South Bound |      |      | East Bound |      |      | West Bound |      |      |
|---|-------------|------|------|-------------|------|------|------------|------|------|------------|------|------|
| Movement:                                   | L           | T    | R    | L           | T    | R    | L          | T    | R    | L          | T    | R    |
| Min. Green:                                 | 0           | 0    | 0    | 10          | 10   | 10   | 0          | 10   | 10   | 7          | 10   | 0    |
| Y+R:  | 4.0         | 4.0  | 4.0  | 4.0         | 4.0  | 4.0  | 4.0        | 4.0  | 4.0  | 4.0        | 4.0  | 4.0  |
| Volume Module: >> Count Date: 9 Sep 2014 << |             |      |      |             |      |      |            |      |      |            |      |      |
| Base Vol:                                   | 0           | 0    | 0    | 544         | 4    | 230  | 0          | 1011 | 724  | 537        | 890  | 0    |
| Growth Adj:                                 | 1.00        | 1.00 | 1.00 | 1.00        | 1.00 | 1.00 | 1.00       | 1.00 | 1.00 | 1.00       | 1.00 | 1.00 |
| Initial Bse:                                | 0           | 0    | 0    | 544         | 4    | 230  | 0          | 1011 | 724  | 537        | 890  | 0    |
| Added Vol:                                  | 0           | 0    | 0    | 0           | 0    | 0    | 0          | 0    | 0    | 0          | 0    | 0    |
| PasserByVol:                                | 0           | 0    | 0    | 0           | 0    | 0    | 0          | 0    | 0    | 0          | 0    | 0    |
| Initial Fut:                                | 0           | 0    | 0    | 544         | 4    | 230  | 0          | 1011 | 724  | 537        | 890  | 0    |
| User Adj:                                   | 1.00        | 1.00 | 1.00 | 1.00        | 1.00 | 1.00 | 1.00       | 1.00 | 1.00 | 1.00       | 1.00 | 1.00 |
| PHF Adj:                                    | 1.00        | 1.00 | 1.00 | 1.00        | 1.00 | 1.00 | 1.00       | 1.00 | 1.00 | 1.00       | 1.00 | 1.00 |
| PHF Volume:                                 | 0           | 0    | 0    | 544         | 4    | 230  | 0          | 1011 | 724  | 537        | 890  | 0    |
| Reduct Vol:                                 | 0           | 0    | 0    | 0           | 0    | 0    | 0          | 0    | 0    | 0          | 0    | 0    |
| Reduced Vol:                                | 0           | 0    | 0    | 544         | 4    | 230  | 0          | 1011 | 724  | 537        | 890  | 0    |
| PCE Adj:                                    | 1.00        | 1.00 | 1.00 | 1.00        | 1.00 | 1.00 | 1.00       | 1.00 | 1.00 | 1.00       | 1.00 | 1.00 |
| MLF Adj:                                    | 1.00        | 1.00 | 1.00 | 1.00        | 1.00 | 1.00 | 1.00       | 1.00 | 1.00 | 1.00       | 1.00 | 1.00 |
| FinalVolume:                                | 0           | 0    | 0    | 544         | 4    | 230  | 0          | 1011 | 724  | 537        | 890  | 0    |
| Saturation Flow Module:                     |             |      |      |             |      |      |            |      |      |            |      |      |
| Sat/Lane:                                   | 1900        | 1900 | 1900 | 1900        | 1900 | 1900 | 1900       | 1900 | 1900 | 1900       | 1900 | 1900 |
| Adjustment:                                 | 0.92        | 1.00 | 0.92 | 0.93        | 0.95 | 0.92 | 0.92       | 1.00 | 0.92 | 0.83       | 1.00 | 0.92 |
| Lanes:                                      | 0.00        | 0.00 | 0.00 | 1.99        | 0.01 | 1.00 | 0.00       | 2.00 | 1.00 | 2.00       | 2.00 | 0.00 |
| Final Sat.:                                 | 0           | 0    | 0    | 3524        | 26   | 1750 | 0          | 3800 | 1750 | 3150       | 3800 | 0    |
| Capacity Analysis Module:                   |             |      |      |             |      |      |            |      |      |            |      |      |
| Vol/Sat:                                    | 0.00        | 0.00 | 0.00 | 0.15        | 0.15 | 0.13 | 0.00       | 0.27 | 0.41 | 0.17       | 0.23 | 0.00 |
| Crit Moves:                                 | *****       |      |      |             |      |      |            |      |      |            |      |      |
| Green Time:                                 | 0.0         | 0.0  | 0.0  | 12.7        | 12.7 | 12.7 | 0.0        | 34.2 | 34.2 | 14.1       | 48.3 | 0.0  |
| Volume/Cap:                                 | 0.00        | 0.00 | 0.00 | 0.85        | 0.85 | 0.72 | 0.00       | 0.55 | 0.85 | 0.85       | 0.34 | 0.00 |
| Delay/Veh:                                  | 0.0         | 0.0  | 0.0  | 37.9        | 37.9 | 34.8 | 0.0        | 12.8 | 23.6 | 37.3       | 4.5  | 0.0  |
| User DelAdj:                                | 1.00        | 1.00 | 1.00 | 1.00        | 1.00 | 1.00 | 1.00       | 1.00 | 1.00 | 1.00       | 1.00 | 1.00 |
| AdjDel/Veh:                                 | 0.0         | 0.0  | 0.0  | 37.9        | 37.9 | 34.8 | 0.0        | 12.8 | 23.6 | 37.3       | 4.5  | 0.0  |
| LOS by Move:                                | A           | A    | A    | D           | D    | C    | A          | B    | C    | D          | A    | A    |
| HCM2k95thQ:                                 | 0           | 0    | 0    | 17          | 17   | 13   | 0          | 14   | 27   | 13         | 7    | 0    |

Note: Queue reported is the number of cars per lane.

BART

Level Of Service Computation Report  
 2000 HCM Operations (Future Volume Alternative)  
 AM - Cumulative No Project

Intersection #3036: 280/MCLAUGHLIN [Study Int 25]

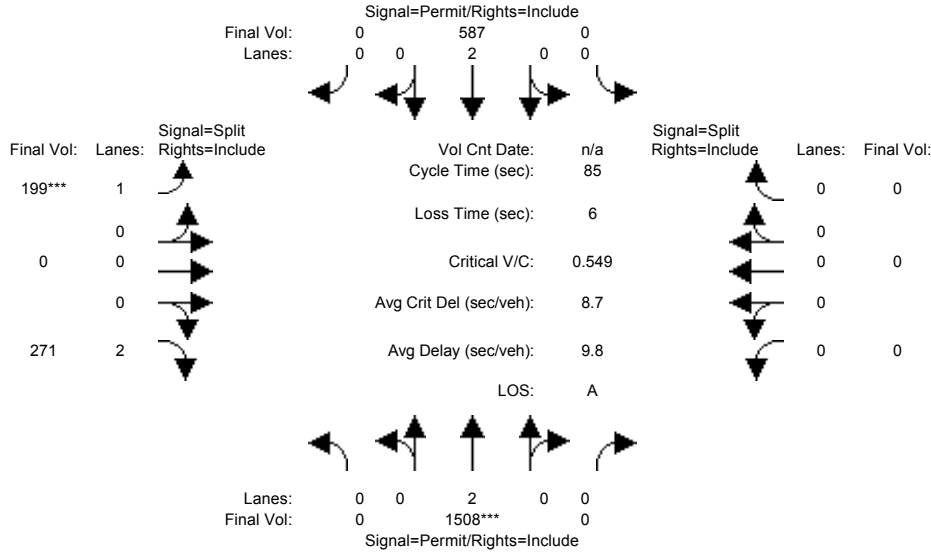

| Approach:                 | North Bound |      |      | South Bound |      |      | East Bound |      |      | West Bound |      |      |
|---------------------------|-------------|------|------|-------------|------|------|------------|------|------|------------|------|------|
| Movement:                 | L           | T    | R    | L           | T    | R    | L          | T    | R    | L          | T    | R    |
| Min. Green:               | 0           | 10   | 0    | 0           | 10   | 0    | 10         | 0    | 10   | 0          | 0    | 0    |
| Y+R:                      | 4.0         | 4.0  | 4.0  | 4.0         | 4.0  | 4.0  | 4.0        | 4.0  | 4.0  | 4.0        | 4.0  | 4.0  |
| Volume Module:            |             |      |      |             |      |      |            |      |      |            |      |      |
| Base Vol:                 | 0           | 1508 | 0    | 0           | 587  | 0    | 199        | 0    | 271  | 0          | 0    | 0    |
| Growth Adj:               | 1.00        | 1.00 | 1.00 | 1.00        | 1.00 | 1.00 | 1.00       | 1.00 | 1.00 | 1.00       | 1.00 | 1.00 |
| Initial Bse:              | 0           | 1508 | 0    | 0           | 587  | 0    | 199        | 0    | 271  | 0          | 0    | 0    |
| Added Vol:                | 0           | 0    | 0    | 0           | 0    | 0    | 0          | 0    | 0    | 0          | 0    | 0    |
| PasserByVol:              | 0           | 0    | 0    | 0           | 0    | 0    | 0          | 0    | 0    | 0          | 0    | 0    |
| Initial Fut:              | 0           | 1508 | 0    | 0           | 587  | 0    | 199        | 0    | 271  | 0          | 0    | 0    |
| User Adj:                 | 1.00        | 1.00 | 1.00 | 1.00        | 1.00 | 1.00 | 1.00       | 1.00 | 1.00 | 1.00       | 1.00 | 1.00 |
| PHF Adj:                  | 1.00        | 1.00 | 1.00 | 1.00        | 1.00 | 1.00 | 1.00       | 1.00 | 1.00 | 1.00       | 1.00 | 1.00 |
| PHF Volume:               | 0           | 1508 | 0    | 0           | 587  | 0    | 199        | 0    | 271  | 0          | 0    | 0    |
| Reduct Vol:               | 0           | 0    | 0    | 0           | 0    | 0    | 0          | 0    | 0    | 0          | 0    | 0    |
| Reduced Vol:              | 0           | 1508 | 0    | 0           | 587  | 0    | 199        | 0    | 271  | 0          | 0    | 0    |
| PCE Adj:                  | 1.00        | 1.00 | 1.00 | 1.00        | 1.00 | 1.00 | 1.00       | 1.00 | 1.00 | 1.00       | 1.00 | 1.00 |
| MLF Adj:                  | 1.00        | 1.00 | 1.00 | 1.00        | 1.00 | 1.00 | 1.00       | 1.00 | 1.00 | 1.00       | 1.00 | 1.00 |
| Final Volume:             | 0           | 1508 | 0    | 0           | 587  | 0    | 199        | 0    | 271  | 0          | 0    | 0    |
| Saturation Flow Module:   |             |      |      |             |      |      |            |      |      |            |      |      |
| Sat/Lane:                 | 1900        | 1900 | 1900 | 1900        | 1900 | 1900 | 1900       | 1900 | 1900 | 1900       | 1900 | 1900 |
| Adjustment:               | 0.92        | 1.00 | 0.92 | 0.92        | 1.00 | 0.92 | 0.92       | 1.00 | 0.83 | 0.92       | 1.00 | 0.92 |
| Lanes:                    | 0.00        | 2.00 | 0.00 | 0.00        | 2.00 | 0.00 | 1.00       | 0.00 | 2.00 | 0.00       | 0.00 | 0.00 |
| Final Sat.:               | 0           | 3800 | 0    | 0           | 3800 | 0    | 1750       | 0    | 3150 | 0          | 0    | 0    |
| Capacity Analysis Module: |             |      |      |             |      |      |            |      |      |            |      |      |
| Vol/Sat:                  | 0.00        | 0.40 | 0.00 | 0.00        | 0.15 | 0.00 | 0.11       | 0.00 | 0.09 | 0.00       | 0.00 | 0.00 |
| Crit Moves:               | ****        |      |      | ****        |      |      | ****       |      |      | ****       |      |      |
| Green Time:               | 0.0         | 61.4 | 0.0  | 0.0         | 61.4 | 0.0  | 17.6       | 0.0  | 17.6 | 0.0        | 0.0  | 0.0  |
| Volume/Cap:               | 0.00        | 0.55 | 0.00 | 0.00        | 0.21 | 0.00 | 0.55       | 0.00 | 0.42 | 0.00       | 0.00 | 0.00 |
| Delay/Veh:                | 0.0         | 5.7  | 0.0  | 0.0         | 3.9  | 0.0  | 31.9       | 0.0  | 29.7 | 0.0        | 0.0  | 0.0  |
| User DelAdj:              | 1.00        | 1.00 | 1.00 | 1.00        | 1.00 | 1.00 | 1.00       | 1.00 | 1.00 | 1.00       | 1.00 | 1.00 |
| AdjDel/Veh:               | 0.0         | 5.7  | 0.0  | 0.0         | 3.9  | 0.0  | 31.9       | 0.0  | 29.7 | 0.0        | 0.0  | 0.0  |
| LOS by Move:              | A           | A    | A    | A           | A    | A    | C          | A    | C    | A          | A    | A    |
| HCM2k95thQ:               | 0           | 17   | 0    | 0           | 5    | 0    | 11         | 0    | 8    | 0          | 0    | 0    |

Note: Queue reported is the number of cars per lane.



BART

Level Of Service Computation Report  
 2000 HCM Operations (Future Volume Alternative)  
 PM - Cumulative No Project

Intersection #3036: 280/MCLAUGHLIN [Study Int 25]

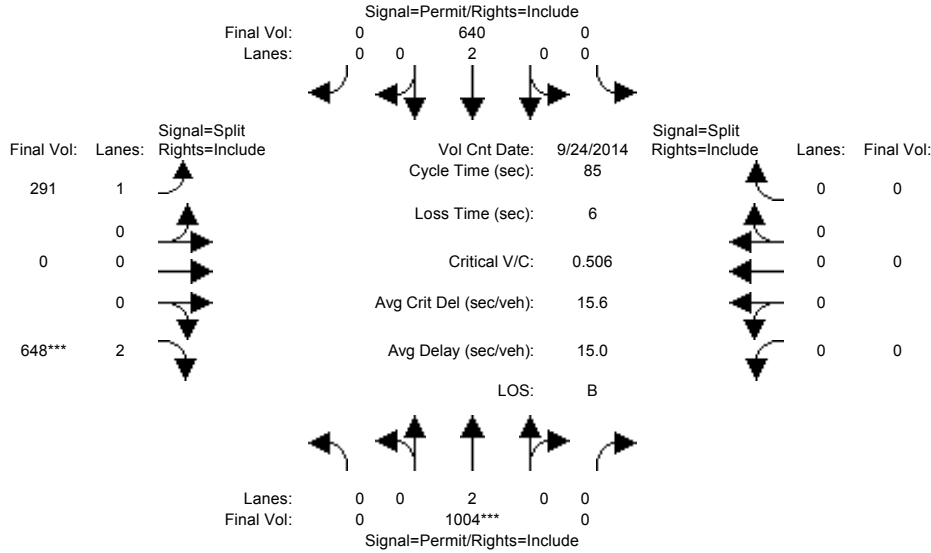

| Approach:                                    | North Bound |      |      | South Bound |      |      | East Bound |      |      | West Bound |      |      |
|--|-------------|------|------|-------------|------|------|------------|------|------|------------|------|------|
| Movement:                                    | L           | T    | R    | L           | T    | R    | L          | T    | R    | L          | T    | R    |
| Min. Green:                                  | 0           | 10   | 0    | 0           | 10   | 0    | 10         | 0    | 10   | 0          | 0    | 0    |
| Y+R:   | 4.0         | 4.0  | 4.0  | 4.0         | 4.0  | 4.0  | 4.0        | 4.0  | 4.0  | 4.0        | 4.0  | 4.0  |
| Volume Module: >> Count Date: 24 Sep 2014 << |             |      |      |             |      |      |            |      |      |            |      |      |
| Base Vol:                                    | 0           | 1004 | 0    | 0           | 640  | 0    | 291        | 0    | 648  | 0          | 0    | 0    |
| Growth Adj:                                  | 1.00        | 1.00 | 1.00 | 1.00        | 1.00 | 1.00 | 1.00       | 1.00 | 1.00 | 1.00       | 1.00 | 1.00 |
| Initial Bse:                                 | 0           | 1004 | 0    | 0           | 640  | 0    | 291        | 0    | 648  | 0          | 0    | 0    |
| Added Vol:                                   | 0           | 0    | 0    | 0           | 0    | 0    | 0          | 0    | 0    | 0          | 0    | 0    |
| PasserByVol:                                 | 0           | 0    | 0    | 0           | 0    | 0    | 0          | 0    | 0    | 0          | 0    | 0    |
| Initial Fut:                                 | 0           | 1004 | 0    | 0           | 640  | 0    | 291        | 0    | 648  | 0          | 0    | 0    |
| User Adj:                                    | 1.00        | 1.00 | 1.00 | 1.00        | 1.00 | 1.00 | 1.00       | 1.00 | 1.00 | 1.00       | 1.00 | 1.00 |
| PHF Adj:                                     | 1.00        | 1.00 | 1.00 | 1.00        | 1.00 | 1.00 | 1.00       | 1.00 | 1.00 | 1.00       | 1.00 | 1.00 |
| PHF Volume:                                  | 0           | 1004 | 0    | 0           | 640  | 0    | 291        | 0    | 648  | 0          | 0    | 0    |
| Reduct Vol:                                  | 0           | 0    | 0    | 0           | 0    | 0    | 0          | 0    | 0    | 0          | 0    | 0    |
| Reduced Vol:                                 | 0           | 1004 | 0    | 0           | 640  | 0    | 291        | 0    | 648  | 0          | 0    | 0    |
| PCE Adj:                                     | 1.00        | 1.00 | 1.00 | 1.00        | 1.00 | 1.00 | 1.00       | 1.00 | 1.00 | 1.00       | 1.00 | 1.00 |
| MLF Adj:                                     | 1.00        | 1.00 | 1.00 | 1.00        | 1.00 | 1.00 | 1.00       | 1.00 | 1.00 | 1.00       | 1.00 | 1.00 |
| FinalVolume:                                 | 0           | 1004 | 0    | 0           | 640  | 0    | 291        | 0    | 648  | 0          | 0    | 0    |
| Saturation Flow Module:                      |             |      |      |             |      |      |            |      |      |            |      |      |
| Sat/Lane:                                    | 1900        | 1900 | 1900 | 1900        | 1900 | 1900 | 1900       | 1900 | 1900 | 1900       | 1900 | 1900 |
| Adjustment:                                  | 0.92        | 1.00 | 0.92 | 0.92        | 1.00 | 0.92 | 0.92       | 1.00 | 0.83 | 0.92       | 1.00 | 0.92 |
| Lanes:                                       | 0.00        | 2.00 | 0.00 | 0.00        | 2.00 | 0.00 | 1.00       | 0.00 | 2.00 | 0.00       | 0.00 | 0.00 |
| Final Sat.:                                  | 0           | 3800 | 0    | 0           | 3800 | 0    | 1750       | 0    | 3150 | 0          | 0    | 0    |
| Capacity Analysis Module:                    |             |      |      |             |      |      |            |      |      |            |      |      |
| Vol/Sat:                                     | 0.00        | 0.26 | 0.00 | 0.00        | 0.17 | 0.00 | 0.17       | 0.00 | 0.21 | 0.00       | 0.00 | 0.00 |
| Crit Moves:                                  | ****        |      |      | ****        |      |      | ****       |      |      | ****       |      |      |
| Green Time:                                  | 0.0         | 44.4 | 0.0  | 0.0         | 44.4 | 0.0  | 34.6       | 0.0  | 34.6 | 0.0        | 0.0  | 0.0  |
| Volume/Cap:                                  | 0.00        | 0.51 | 0.00 | 0.00        | 0.32 | 0.00 | 0.41       | 0.00 | 0.51 | 0.00       | 0.00 | 0.00 |
| Delay/Veh:                                   | 0.0         | 13.4 | 0.0  | 0.0         | 11.7 | 0.0  | 18.3       | 0.0  | 19.2 | 0.0        | 0.0  | 0.0  |
| User DelAdj:                                 | 1.00        | 1.00 | 1.00 | 1.00        | 1.00 | 1.00 | 1.00       | 1.00 | 1.00 | 1.00       | 1.00 | 1.00 |
| AdjDel/Veh:                                  | 0.0         | 13.4 | 0.0  | 0.0         | 11.7 | 0.0  | 18.3       | 0.0  | 19.2 | 0.0        | 0.0  | 0.0  |
| LOS by Move:                                 | A           | B    | A    | A           | B    | A    | B          | A    | B    | A          | A    | A    |
| HCM2k95thQ:                                  | 0           | 16   | 0    | 0           | 9    | 0    | 12         | 0    | 15   | 0          | 0    | 0    |

Note: Queue reported is the number of cars per lane.

BART

Level Of Service Computation Report  
 2000 HCM Operations (Future Volume Alternative)  
 AM - Cumulative With Project

Intersection #3036: 280/MCLAUGHLIN [Study Int 25]

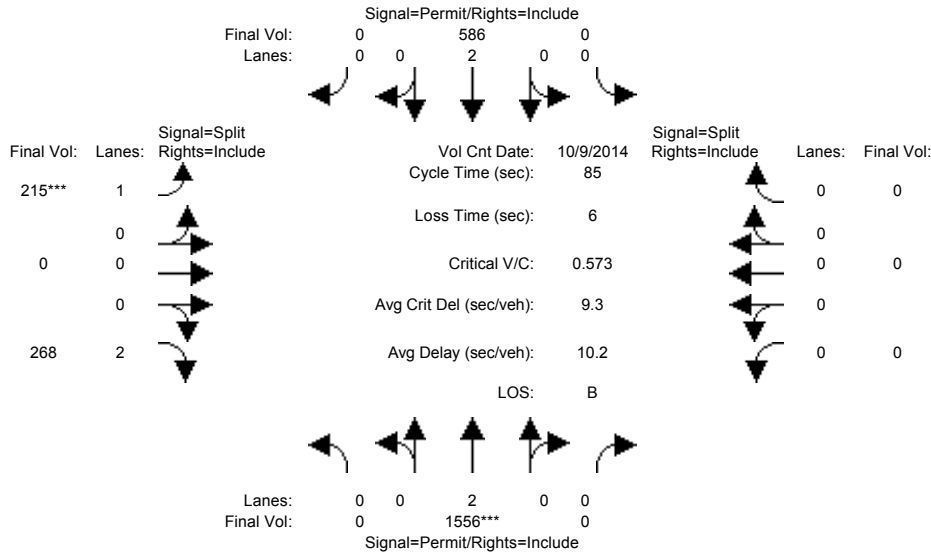

| Approach:   | North Bound |      |      | South Bound |      |      | East Bound |      |      | West Bound |      |      |
|---|-------------|------|------|-------------|------|------|------------|------|------|------------|------|------|
| Movement:   | L           | T    | R    | L           | T    | R    | L          | T    | R    | L          | T    | R    |
| Min. Green:   | 0           | 10   | 0    | 0           | 10   | 0    | 10         | 0    | 10   | 0          | 0    | 0    |
| Y+R:  | 4.0         | 4.0  | 4.0  | 4.0         | 4.0  | 4.0  | 4.0        | 4.0  | 4.0  | 4.0        | 4.0  | 4.0  |
| ----- ----- ----- ----- ----- ----- ----- ----- ----- ----- ----- ----- |             |      |      |             |      |      |            |      |      |            |      |      |
| Volume Module: >> Count Date: 9 Oct 2014 <<                             |             |      |      |             |      |      |            |      |      |            |      |      |
| Base Vol:   | 0           | 1556 | 0    | 0           | 586  | 0    | 215        | 0    | 268  | 0          | 0    | 0    |
| Growth Adj:   | 1.00        | 1.00 | 1.00 | 1.00        | 1.00 | 1.00 | 1.00       | 1.00 | 1.00 | 1.00       | 1.00 | 1.00 |
| Initial Bse:  | 0           | 1556 | 0    | 0           | 586  | 0    | 215        | 0    | 268  | 0          | 0    | 0    |
| Added Vol:  | 0           | 0    | 0    | 0           | 0    | 0    | 0          | 0    | 0    | 0          | 0    | 0    |
| PasserByVol:  | 0           | 0    | 0    | 0           | 0    | 0    | 0          | 0    | 0    | 0          | 0    | 0    |
| Initial Fut:  | 0           | 1556 | 0    | 0           | 586  | 0    | 215        | 0    | 268  | 0          | 0    | 0    |
| User Adj:   | 1.00        | 1.00 | 1.00 | 1.00        | 1.00 | 1.00 | 1.00       | 1.00 | 1.00 | 1.00       | 1.00 | 1.00 |
| PHF Adj:  | 1.00        | 1.00 | 1.00 | 1.00        | 1.00 | 1.00 | 1.00       | 1.00 | 1.00 | 1.00       | 1.00 | 1.00 |
| PHF Volume:   | 0           | 1556 | 0    | 0           | 586  | 0    | 215        | 0    | 268  | 0          | 0    | 0    |
| Reduct Vol:   | 0           | 0    | 0    | 0           | 0    | 0    | 0          | 0    | 0    | 0          | 0    | 0    |
| Reduced Vol:  | 0           | 1556 | 0    | 0           | 586  | 0    | 215        | 0    | 268  | 0          | 0    | 0    |
| PCE Adj:  | 1.00        | 1.00 | 1.00 | 1.00        | 1.00 | 1.00 | 1.00       | 1.00 | 1.00 | 1.00       | 1.00 | 1.00 |
| MLF Adj:  | 1.00        | 1.00 | 1.00 | 1.00        | 1.00 | 1.00 | 1.00       | 1.00 | 1.00 | 1.00       | 1.00 | 1.00 |
| FinalVolume:  | 0           | 1556 | 0    | 0           | 586  | 0    | 215        | 0    | 268  | 0          | 0    | 0    |
| ----- ----- ----- ----- ----- ----- ----- ----- ----- ----- -----       |             |      |      |             |      |      |            |      |      |            |      |      |
| Saturation Flow Module:   |             |      |      |             |      |      |            |      |      |            |      |      |
| Sat/Lane:   | 1900        | 1900 | 1900 | 1900        | 1900 | 1900 | 1900       | 1900 | 1900 | 1900       | 1900 | 1900 |
| Adjustment:   | 0.92        | 1.00 | 0.92 | 0.92        | 1.00 | 0.92 | 0.92       | 1.00 | 0.83 | 0.92       | 1.00 | 0.92 |
| Lanes:  | 0.00        | 2.00 | 0.00 | 0.00        | 2.00 | 0.00 | 1.00       | 0.00 | 2.00 | 0.00       | 0.00 | 0.00 |
| Final Sat.:   | 0           | 3800 | 0    | 0           | 3800 | 0    | 1750       | 0    | 3150 | 0          | 0    | 0    |
| ----- ----- ----- ----- ----- ----- ----- ----- ----- ----- -----       |             |      |      |             |      |      |            |      |      |            |      |      |
| Capacity Analysis Module:   |             |      |      |             |      |      |            |      |      |            |      |      |
| Vol/Sat:  | 0.00        | 0.41 | 0.00 | 0.00        | 0.15 | 0.00 | 0.12       | 0.00 | 0.09 | 0.00       | 0.00 | 0.00 |
| Crit Moves:   | *****       |      |      |             |      |      |            |      |      |            |      |      |
| Green Time:   | 0.0         | 60.8 | 0.0  | 0.0         | 60.8 | 0.0  | 18.2       | 0.0  | 18.2 | 0.0        | 0.0  | 0.0  |
| Volume/Cap:   | 0.00        | 0.57 | 0.00 | 0.00        | 0.22 | 0.00 | 0.57       | 0.00 | 0.40 | 0.00       | 0.00 | 0.00 |
| Delay/Veh:  | 0.0         | 6.1  | 0.0  | 0.0         | 4.1  | 0.0  | 32.0       | 0.0  | 29.0 | 0.0        | 0.0  | 0.0  |
| User DelAdj:  | 1.00        | 1.00 | 1.00 | 1.00        | 1.00 | 1.00 | 1.00       | 1.00 | 1.00 | 1.00       | 1.00 | 1.00 |
| AdjDel/Veh:   | 0.0         | 6.1  | 0.0  | 0.0         | 4.1  | 0.0  | 32.0       | 0.0  | 29.0 | 0.0        | 0.0  | 0.0  |
| LOS by Move:  | A           | A    | A    | A           | A    | A    | C          | A    | C    | A          | A    | A    |
| HCM2k95thQ:   | 0           | 18   | 0    | 0           | 5    | 0    | 12         | 0    | 8    | 0          | 0    | 0    |

Note: Queue reported is the number of cars per lane.

BART

Level Of Service Computation Report  
 2000 HCM Operations (Future Volume Alternative)  
 PM - Cumulative With Project

Intersection #3036: 280/MCLAUGHLIN [Study Int 25]

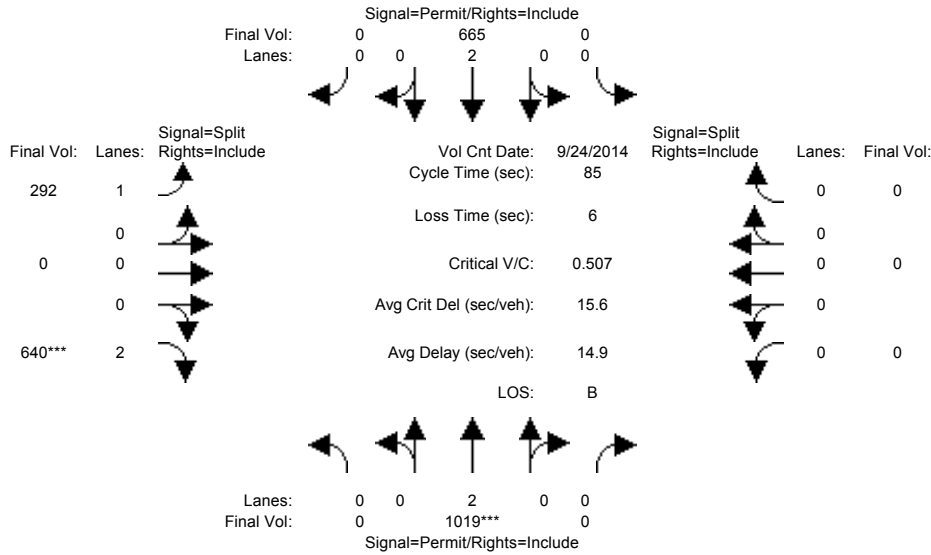

| Approach:                                    | North Bound |      |      | South Bound |      |      | East Bound |      |      | West Bound |      |      |
|--|-------------|------|------|-------------|------|------|------------|------|------|------------|------|------|
| Movement:                                    | L           | T    | R    | L           | T    | R    | L          | T    | R    | L          | T    | R    |
| Min. Green:                                  | 0           | 10   | 0    | 0           | 10   | 0    | 10         | 0    | 10   | 0          | 0    | 0    |
| Y+R:   | 4.0         | 4.0  | 4.0  | 4.0         | 4.0  | 4.0  | 4.0        | 4.0  | 4.0  | 4.0        | 4.0  | 4.0  |
| Volume Module: >> Count Date: 24 Sep 2014 << |             |      |      |             |      |      |            |      |      |            |      |      |
| Base Vol:                                    | 0           | 1019 | 0    | 0           | 665  | 0    | 292        | 0    | 640  | 0          | 0    | 0    |
| Growth Adj:                                  | 1.00        | 1.00 | 1.00 | 1.00        | 1.00 | 1.00 | 1.00       | 1.00 | 1.00 | 1.00       | 1.00 | 1.00 |
| Initial Bse:                                 | 0           | 1019 | 0    | 0           | 665  | 0    | 292        | 0    | 640  | 0          | 0    | 0    |
| Added Vol:                                   | 0           | 0    | 0    | 0           | 0    | 0    | 0          | 0    | 0    | 0          | 0    | 0    |
| PasserByVol:                                 | 0           | 0    | 0    | 0           | 0    | 0    | 0          | 0    | 0    | 0          | 0    | 0    |
| Initial Fut:                                 | 0           | 1019 | 0    | 0           | 665  | 0    | 292        | 0    | 640  | 0          | 0    | 0    |
| User Adj:                                    | 1.00        | 1.00 | 1.00 | 1.00        | 1.00 | 1.00 | 1.00       | 1.00 | 1.00 | 1.00       | 1.00 | 1.00 |
| PHF Adj:                                     | 1.00        | 1.00 | 1.00 | 1.00        | 1.00 | 1.00 | 1.00       | 1.00 | 1.00 | 1.00       | 1.00 | 1.00 |
| PHF Volume:                                  | 0           | 1019 | 0    | 0           | 665  | 0    | 292        | 0    | 640  | 0          | 0    | 0    |
| Reduct Vol:                                  | 0           | 0    | 0    | 0           | 0    | 0    | 0          | 0    | 0    | 0          | 0    | 0    |
| Reduced Vol:                                 | 0           | 1019 | 0    | 0           | 665  | 0    | 292        | 0    | 640  | 0          | 0    | 0    |
| PCE Adj:                                     | 1.00        | 1.00 | 1.00 | 1.00        | 1.00 | 1.00 | 1.00       | 1.00 | 1.00 | 1.00       | 1.00 | 1.00 |
| MLF Adj:                                     | 1.00        | 1.00 | 1.00 | 1.00        | 1.00 | 1.00 | 1.00       | 1.00 | 1.00 | 1.00       | 1.00 | 1.00 |
| Final Volume:                                | 0           | 1019 | 0    | 0           | 665  | 0    | 292        | 0    | 640  | 0          | 0    | 0    |
| Saturation Flow Module:                      |             |      |      |             |      |      |            |      |      |            |      |      |
| Sat/Lane:                                    | 1900        | 1900 | 1900 | 1900        | 1900 | 1900 | 1900       | 1900 | 1900 | 1900       | 1900 | 1900 |
| Adjustment:                                  | 0.92        | 1.00 | 0.92 | 0.92        | 1.00 | 0.92 | 0.92       | 1.00 | 0.83 | 0.92       | 1.00 | 0.92 |
| Lanes:                                       | 0.00        | 2.00 | 0.00 | 0.00        | 2.00 | 0.00 | 1.00       | 0.00 | 2.00 | 0.00       | 0.00 | 0.00 |
| Final Sat.:                                  | 0           | 3800 | 0    | 0           | 3800 | 0    | 1750       | 0    | 3150 | 0          | 0    | 0    |
| Capacity Analysis Module:                    |             |      |      |             |      |      |            |      |      |            |      |      |
| Vol/Sat:                                     | 0.00        | 0.27 | 0.00 | 0.00        | 0.17 | 0.00 | 0.17       | 0.00 | 0.20 | 0.00       | 0.00 | 0.00 |
| Crit Moves:                                  | ****        |      |      | ****        |      |      | ****       |      |      | ****       |      |      |
| Green Time:                                  | 0.0         | 44.9 | 0.0  | 0.0         | 44.9 | 0.0  | 34.1       | 0.0  | 34.1 | 0.0        | 0.0  | 0.0  |
| Volume/Cap:                                  | 0.00        | 0.51 | 0.00 | 0.00        | 0.33 | 0.00 | 0.42       | 0.00 | 0.51 | 0.00       | 0.00 | 0.00 |
| Delay/Veh:                                   | 0.0         | 13.1 | 0.0  | 0.0         | 11.5 | 0.0  | 18.7       | 0.0  | 19.5 | 0.0        | 0.0  | 0.0  |
| User DelAdj:                                 | 1.00        | 1.00 | 1.00 | 1.00        | 1.00 | 1.00 | 1.00       | 1.00 | 1.00 | 1.00       | 1.00 | 1.00 |
| AdjDel/Veh:                                  | 0.0         | 13.1 | 0.0  | 0.0         | 11.5 | 0.0  | 18.7       | 0.0  | 19.5 | 0.0        | 0.0  | 0.0  |
| LOS by Move:                                 | A           | B    | A    | A           | B    | A    | B          | A    | B    | A          | A    | A    |
| HCM2k95thQ:                                  | 0           | 16   | 0    | 0           | 10   | 0    | 12         | 0    | 15   | 0          | 0    | 0    |

Note: Queue reported is the number of cars per lane.

BART

Level Of Service Computation Report  
2000 HCM Operations (Future Volume Alternative)  
AM - Cumulative No Project

Intersection #3042: 680N/ALUM ROCK (E) [Study Int 20]

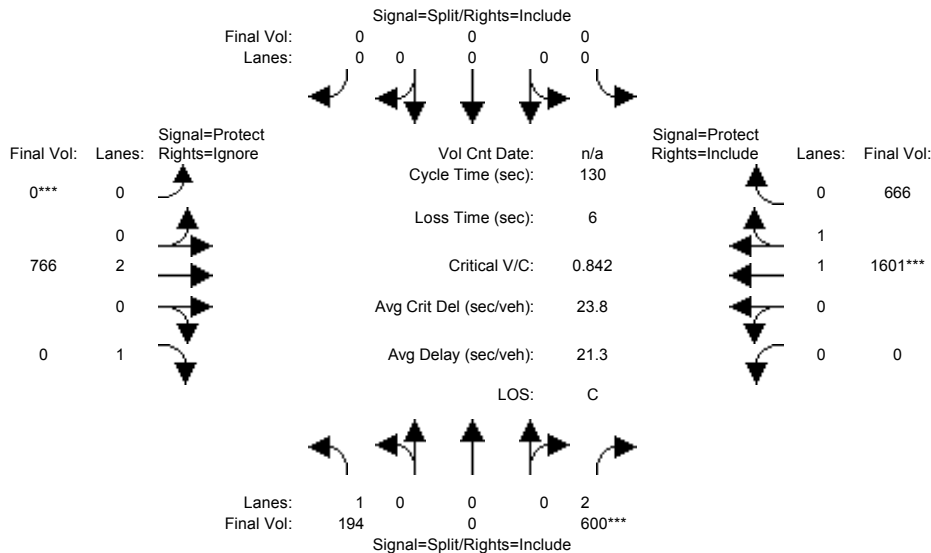

| Approach:                 | North Bound |      |      | South Bound |      |      | East Bound |      |      | West Bound |      |      |
|---------------------------|-------------|------|------|-------------|------|------|------------|------|------|------------|------|------|
| Movement:                 | L           | T    | R    | L           | T    | R    | L          | T    | R    | L          | T    | R    |
| Min. Green:               | 10          | 0    | 10   | 0           | 0    | 0    | 0          | 10   | 10   | 0          | 10   | 10   |
| Y+R:                      | 4.0         | 4.0  | 4.0  | 4.0         | 4.0  | 4.0  | 4.0        | 4.0  | 4.0  | 4.0        | 4.0  | 4.0  |
| Volume Module:            |             |      |      |             |      |      |            |      |      |            |      |      |
| Base Vol:                 | 194         | 0    | 600  | 0           | 0    | 0    | 0          | 766  | 361  | 0          | 1601 | 666  |
| Growth Adj:               | 1.00        | 1.00 | 1.00 | 1.00        | 1.00 | 1.00 | 1.00       | 1.00 | 1.00 | 1.00       | 1.00 | 1.00 |
| Initial Bse:              | 194         | 0    | 600  | 0           | 0    | 0    | 0          | 766  | 361  | 0          | 1601 | 666  |
| Added Vol:                | 0           | 0    | 0    | 0           | 0    | 0    | 0          | 0    | 0    | 0          | 0    | 0    |
| PasserByVol:              | 0           | 0    | 0    | 0           | 0    | 0    | 0          | 0    | 0    | 0          | 0    | 0    |
| Initial Fut:              | 194         | 0    | 600  | 0           | 0    | 0    | 0          | 766  | 361  | 0          | 1601 | 666  |
| User Adj:                 | 1.00        | 1.00 | 1.00 | 1.00        | 1.00 | 1.00 | 1.00       | 1.00 | 0.00 | 1.00       | 1.00 | 1.00 |
| PHF Adj:                  | 1.00        | 1.00 | 1.00 | 1.00        | 1.00 | 1.00 | 1.00       | 1.00 | 0.00 | 1.00       | 1.00 | 1.00 |
| PHF Volume:               | 194         | 0    | 600  | 0           | 0    | 0    | 0          | 766  | 0    | 0          | 1601 | 666  |
| Reduct Vol:               | 0           | 0    | 0    | 0           | 0    | 0    | 0          | 0    | 0    | 0          | 0    | 0    |
| Reduced Vol:              | 194         | 0    | 600  | 0           | 0    | 0    | 0          | 766  | 0    | 0          | 1601 | 666  |
| PCE Adj:                  | 1.00        | 1.00 | 1.00 | 1.00        | 1.00 | 1.00 | 1.00       | 1.00 | 0.00 | 1.00       | 1.00 | 1.00 |
| MLF Adj:                  | 1.00        | 1.00 | 1.00 | 1.00        | 1.00 | 1.00 | 1.00       | 1.00 | 0.00 | 1.00       | 1.00 | 1.00 |
| FinalVolume:              | 194         | 0    | 600  | 0           | 0    | 0    | 0          | 766  | 0    | 0          | 1601 | 666  |
| Saturation Flow Module:   |             |      |      |             |      |      |            |      |      |            |      |      |
| Sat/Lane:                 | 1900        | 1900 | 1900 | 1900        | 1900 | 1900 | 1900       | 1900 | 1900 | 1900       | 1900 | 1900 |
| Adjustment:               | 0.92        | 1.00 | 0.83 | 0.92        | 1.00 | 0.92 | 0.92       | 1.00 | 0.92 | 0.92       | 0.98 | 0.95 |
| Lanes:                    | 1.00        | 0.00 | 2.00 | 0.00        | 0.00 | 0.00 | 0.00       | 2.00 | 1.00 | 0.00       | 1.40 | 0.60 |
| Final Sat.:               | 1750        | 0    | 3150 | 0           | 0    | 0    | 0          | 3800 | 1750 | 0          | 2612 | 1087 |
| Capacity Analysis Module: |             |      |      |             |      |      |            |      |      |            |      |      |
| Vol/Sat:                  | 0.11        | 0.00 | 0.19 | 0.00        | 0.00 | 0.00 | 0.00       | 0.20 | 0.00 | 0.00       | 0.61 | 0.61 |
| Crit Moves:               | ****        |      |      | ****        |      |      | ****       |      |      | ****       |      |      |
| Green Time:               | 29.4        | 0.0  | 29.4 | 0.0         | 0.0  | 0.0  | 0.0        | 94.6 | 0.0  | 0.0        | 94.6 | 94.6 |
| Volume/Cap:               | 0.49        | 0.00 | 0.84 | 0.00        | 0.00 | 0.00 | 0.00       | 0.28 | 0.00 | 0.00       | 0.84 | 0.84 |
| Delay/Veh:                | 44.7        | 0.0  | 57.0 | 0.0         | 0.0  | 0.0  | 0.0        | 6.1  | 0.0  | 0.0        | 15.0 | 15.0 |
| User DelAdj:              | 1.00        | 1.00 | 1.00 | 1.00        | 1.00 | 1.00 | 1.00       | 1.00 | 1.00 | 1.00       | 1.00 | 1.00 |
| AdjDel/Veh:               | 44.7        | 0.0  | 57.0 | 0.0         | 0.0  | 0.0  | 0.0        | 6.1  | 0.0  | 0.0        | 15.0 | 15.0 |
| LOS by Move:              | D           | A    | E    | A           | A    | A    | A          | A    | A    | A          | B    | B    |
| HCM2k95thQ:               | 14          | 0    | 28   | 0           | 0    | 0    | 0          | 10   | 0    | 0          | 55   | 55   |

Note: Queue reported is the number of cars per lane.

BART

Level Of Service Computation Report  
2000 HCM Operations (Future Volume Alternative)  
PM - Cumulative No Project

Intersection #3042: 680N/ALUM ROCK (E) [Study Int 20]

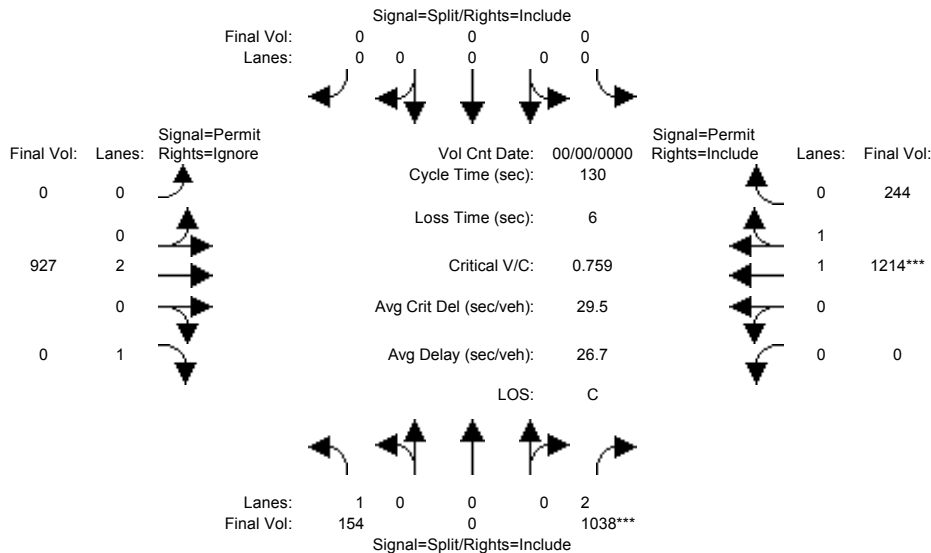

| Approach:  | North Bound |      |      | South Bound |      |      | East Bound |      |      | West Bound |      |      |
|--|-------------|------|------|-------------|------|------|------------|------|------|------------|------|------|
| Movement:  | L           | T    | R    | L           | T    | R    | L          | T    | R    | L          | T    | R    |
| Min. Green:                                      | 10          | 0    | 10   | 0           | 0    | 0    | 0          | 10   | 10   | 0          | 10   | 10   |
| Y+R:   | 4.0         | 4.0  | 4.0  | 4.0         | 4.0  | 4.0  | 4.0        | 4.0  | 4.0  | 4.0        | 4.0  | 4.0  |
| Volume Module: >> Count Date: 0 0 << 4:30-5:30PM |             |      |      |             |      |      |            |      |      |            |      |      |
| Base Vol:  | 154         | 0    | 1038 | 0           | 0    | 0    | 0          | 927  | 8    | 0          | 1214 | 244  |
| Growth Adj:                                      | 1.00        | 1.00 | 1.00 | 1.00        | 1.00 | 1.00 | 1.00       | 1.00 | 1.00 | 1.00       | 1.00 | 1.00 |
| Initial Bse:                                     | 154         | 0    | 1038 | 0           | 0    | 0    | 0          | 927  | 8    | 0          | 1214 | 244  |
| Added Vol:                                       | 0           | 0    | 0    | 0           | 0    | 0    | 0          | 0    | 0    | 0          | 0    | 0    |
| PasserByVol:                                     | 0           | 0    | 0    | 0           | 0    | 0    | 0          | 0    | 0    | 0          | 0    | 0    |
| Initial Fut:                                     | 154         | 0    | 1038 | 0           | 0    | 0    | 0          | 927  | 8    | 0          | 1214 | 244  |
| User Adj:  | 1.00        | 1.00 | 1.00 | 1.00        | 1.00 | 1.00 | 1.00       | 1.00 | 0.00 | 1.00       | 1.00 | 1.00 |
| PHF Adj:   | 1.00        | 1.00 | 1.00 | 1.00        | 1.00 | 1.00 | 1.00       | 1.00 | 0.00 | 1.00       | 1.00 | 1.00 |
| PHF Volume:                                      | 154         | 0    | 1038 | 0           | 0    | 0    | 0          | 927  | 0    | 0          | 1214 | 244  |
| Reduct Vol:                                      | 0           | 0    | 0    | 0           | 0    | 0    | 0          | 0    | 0    | 0          | 0    | 0    |
| Reduced Vol:                                     | 154         | 0    | 1038 | 0           | 0    | 0    | 0          | 927  | 0    | 0          | 1214 | 244  |
| PCE Adj:   | 1.00        | 1.00 | 1.00 | 1.00        | 1.00 | 1.00 | 1.00       | 1.00 | 0.00 | 1.00       | 1.00 | 1.00 |
| MLF Adj:   | 1.00        | 1.00 | 1.00 | 1.00        | 1.00 | 1.00 | 1.00       | 1.00 | 0.00 | 1.00       | 1.00 | 1.00 |
| Final Volume:                                    | 154         | 0    | 1038 | 0           | 0    | 0    | 0          | 927  | 0    | 0          | 1214 | 244  |
| Saturation Flow Module:                          |             |      |      |             |      |      |            |      |      |            |      |      |
| Sat/Lane:  | 1900        | 1900 | 1900 | 1900        | 1900 | 1900 | 1900       | 1900 | 1900 | 1900       | 1900 | 1900 |
| Adjustment:                                      | 0.92        | 1.00 | 0.83 | 0.92        | 1.00 | 0.92 | 0.92       | 1.00 | 0.92 | 0.92       | 0.98 | 0.95 |
| Lanes:   | 1.00        | 0.00 | 2.00 | 0.00        | 0.00 | 0.00 | 0.00       | 2.00 | 1.00 | 0.00       | 1.66 | 0.34 |
| Final Sat.:                                      | 1750        | 0    | 3150 | 0           | 0    | 0    | 0          | 3800 | 1750 | 0          | 3080 | 619  |
| Capacity Analysis Module:                        |             |      |      |             |      |      |            |      |      |            |      |      |
| Vol/Sat:   | 0.09        | 0.00 | 0.33 | 0.00        | 0.00 | 0.00 | 0.00       | 0.24 | 0.00 | 0.00       | 0.39 | 0.39 |
| Crit Moves:                                      | ****        |      |      |             |      |      |            |      |      |            |      |      |
| Green Time:                                      | 56.5        | 0.0  | 56.5 | 0.0         | 0.0  | 0.0  | 0.0        | 67.5 | 0.0  | 0.0        | 67.5 | 67.5 |
| Volume/Cap:                                      | 0.20        | 0.00 | 0.76 | 0.00        | 0.00 | 0.00 | 0.00       | 0.47 | 0.00 | 0.00       | 0.76 | 0.76 |
| Delay/Veh:                                       | 22.9        | 0.0  | 33.5 | 0.0         | 0.0  | 0.0  | 0.0        | 20.0 | 0.0  | 0.0        | 26.6 | 26.6 |
| User DelAdj:                                     | 1.00        | 1.00 | 1.00 | 1.00        | 1.00 | 1.00 | 1.00       | 1.00 | 1.00 | 1.00       | 1.00 | 1.00 |
| AdjDel/Veh:                                      | 22.9        | 0.0  | 33.5 | 0.0         | 0.0  | 0.0  | 0.0        | 20.0 | 0.0  | 0.0        | 26.6 | 26.6 |
| LOS by Move:                                     | C           | A    | C    | A           | A    | A    | A          | C    | A    | A          | C    | C    |
| HCM2k95thQ:                                      | 8           | 0    | 37   | 0           | 0    | 0    | 0          | 21   | 0    | 0          | 40   | 40   |

Note: Queue reported is the number of cars per lane.

BART

Level Of Service Computation Report  
 2000 HCM Operations (Future Volume Alternative)  
 AM - Cumulative With Project

Intersection #3042: 680N/ALUM ROCK (E) [Study Int 20]

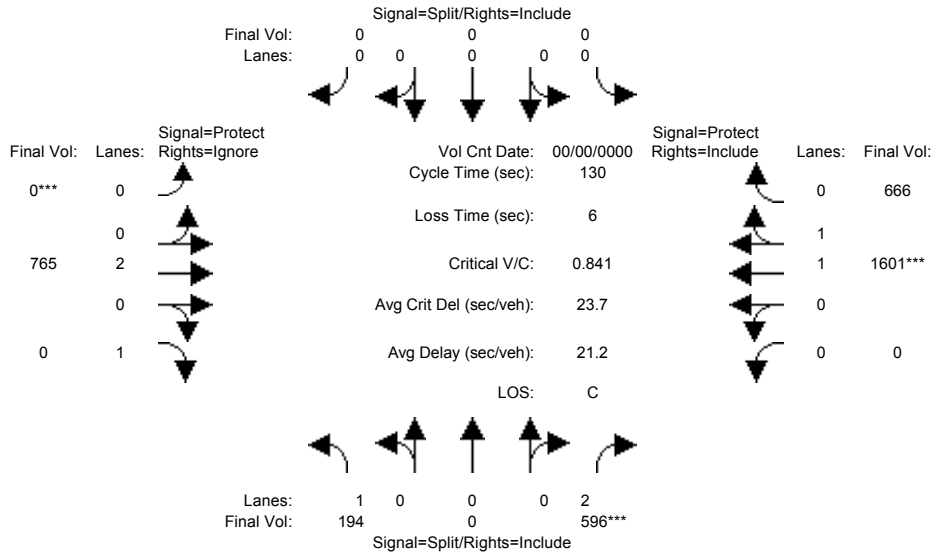

| Approach:  | North Bound |      |      | South Bound |      |      | East Bound |      |      | West Bound |      |      |
|--|-------------|------|------|-------------|------|------|------------|------|------|------------|------|------|
| Movement:  | L           | T    | R    | L           | T    | R    | L          | T    | R    | L          | T    | R    |
| Min. Green:                                      | 10          | 0    | 10   | 0           | 0    | 0    | 0          | 10   | 10   | 0          | 10   | 10   |
| Y+R:   | 4.0         | 4.0  | 4.0  | 4.0         | 4.0  | 4.0  | 4.0        | 4.0  | 4.0  | 4.0        | 4.0  | 4.0  |
| Volume Module: >> Count Date: 0 0 << 7:15-8:15AM |             |      |      |             |      |      |            |      |      |            |      |      |
| Base Vol:  | 194         | 0    | 596  | 0           | 0    | 0    | 0          | 765  | 361  | 0          | 1601 | 666  |
| Growth Adj:                                      | 1.00        | 1.00 | 1.00 | 1.00        | 1.00 | 1.00 | 1.00       | 1.00 | 1.00 | 1.00       | 1.00 | 1.00 |
| Initial Bse:                                     | 194         | 0    | 596  | 0           | 0    | 0    | 0          | 765  | 361  | 0          | 1601 | 666  |
| Added Vol:                                       | 0           | 0    | 0    | 0           | 0    | 0    | 0          | 0    | 0    | 0          | 0    | 0    |
| PasserByVol:                                     | 0           | 0    | 0    | 0           | 0    | 0    | 0          | 0    | 0    | 0          | 0    | 0    |
| Initial Fut:                                     | 194         | 0    | 596  | 0           | 0    | 0    | 0          | 765  | 361  | 0          | 1601 | 666  |
| User Adj:  | 1.00        | 1.00 | 1.00 | 1.00        | 1.00 | 1.00 | 1.00       | 1.00 | 0.00 | 1.00       | 1.00 | 1.00 |
| PHF Adj:   | 1.00        | 1.00 | 1.00 | 1.00        | 1.00 | 1.00 | 1.00       | 1.00 | 0.00 | 1.00       | 1.00 | 1.00 |
| PHF Volume:                                      | 194         | 0    | 596  | 0           | 0    | 0    | 0          | 765  | 0    | 0          | 1601 | 666  |
| Reduct Vol:                                      | 0           | 0    | 0    | 0           | 0    | 0    | 0          | 0    | 0    | 0          | 0    | 0    |
| Reduced Vol:                                     | 194         | 0    | 596  | 0           | 0    | 0    | 0          | 765  | 0    | 0          | 1601 | 666  |
| PCE Adj:   | 1.00        | 1.00 | 1.00 | 1.00        | 1.00 | 1.00 | 1.00       | 1.00 | 0.00 | 1.00       | 1.00 | 1.00 |
| MLF Adj:   | 1.00        | 1.00 | 1.00 | 1.00        | 1.00 | 1.00 | 1.00       | 1.00 | 0.00 | 1.00       | 1.00 | 1.00 |
| Final Volume:                                    | 194         | 0    | 596  | 0           | 0    | 0    | 0          | 765  | 0    | 0          | 1601 | 666  |
| Saturation Flow Module:                          |             |      |      |             |      |      |            |      |      |            |      |      |
| Sat/Lane:  | 1900        | 1900 | 1900 | 1900        | 1900 | 1900 | 1900       | 1900 | 1900 | 1900       | 1900 | 1900 |
| Adjustment:                                      | 0.92        | 1.00 | 0.83 | 0.92        | 1.00 | 0.92 | 0.92       | 1.00 | 0.92 | 0.92       | 0.98 | 0.95 |
| Lanes:   | 1.00        | 0.00 | 2.00 | 0.00        | 0.00 | 0.00 | 0.00       | 2.00 | 1.00 | 0.00       | 1.40 | 0.60 |
| Final Sat.:                                      | 1750        | 0    | 3150 | 0           | 0    | 0    | 0          | 3800 | 1750 | 0          | 2612 | 1087 |
| Capacity Analysis Module:                        |             |      |      |             |      |      |            |      |      |            |      |      |
| Vol/Sat:   | 0.11        | 0.00 | 0.19 | 0.00        | 0.00 | 0.00 | 0.00       | 0.20 | 0.00 | 0.00       | 0.61 | 0.61 |
| Crit Moves:                                      | ****        |      |      | ****        |      |      | ****       |      |      | ****       |      |      |
| Green Time:                                      | 29.3        | 0.0  | 29.3 | 0.0         | 0.0  | 0.0  | 0.0        | 94.7 | 0.0  | 0.0        | 94.7 | 94.7 |
| Volume/Cap:                                      | 0.49        | 0.00 | 0.84 | 0.00        | 0.00 | 0.00 | 0.00       | 0.28 | 0.00 | 0.00       | 0.84 | 0.84 |
| Delay/Veh:                                       | 44.9        | 0.0  | 57.1 | 0.0         | 0.0  | 0.0  | 0.0        | 6.0  | 0.0  | 0.0        | 14.9 | 14.9 |
| User DelAdj:                                     | 1.00        | 1.00 | 1.00 | 1.00        | 1.00 | 1.00 | 1.00       | 1.00 | 1.00 | 1.00       | 1.00 | 1.00 |
| AdjDel/Veh:                                      | 44.9        | 0.0  | 57.1 | 0.0         | 0.0  | 0.0  | 0.0        | 6.0  | 0.0  | 0.0        | 14.9 | 14.9 |
| LOS by Move:                                     | D           | A    | E    | A           | A    | A    | A          | A    | A    | A          | B    | B    |
| HCM2k95thQ:                                      | 14          | 0    | 28   | 0           | 0    | 0    | 0          | 10   | 0    | 0          | 54   | 54   |

Note: Queue reported is the number of cars per lane.

BART

Level Of Service Computation Report  
 2000 HCM Operations (Future Volume Alternative)  
 PM - Cumulative With Project

Intersection #3042: 680N/ALUM ROCK (E) [Study Int 20]

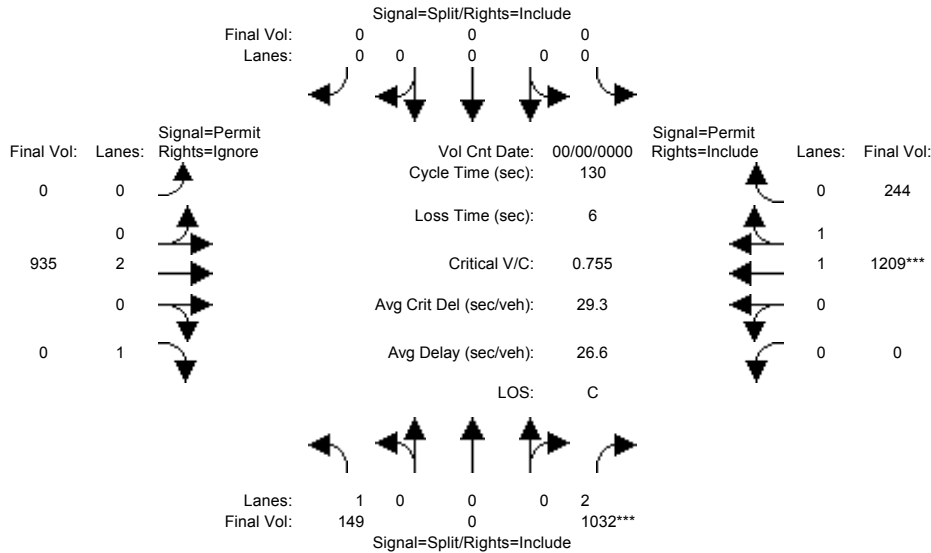

| Approach:                     | North Bound        |      |      | South Bound |      |      | East Bound |      |      | West Bound |      |      |
|-------------------------------|--------------------|------|------|-------------|------|------|------------|------|------|------------|------|------|
| Movement:                     | L                  | T    | R    | L           | T    | R    | L          | T    | R    | L          | T    | R    |
| Min. Green:                   | 10                 | 0    | 10   | 0           | 0    | 0    | 0          | 10   | 10   | 0          | 10   | 10   |
| Y+R:                          | 4.0                | 4.0  | 4.0  | 4.0         | 4.0  | 4.0  | 4.0        | 4.0  | 4.0  | 4.0        | 4.0  | 4.0  |
| Volume Module: >> Count Date: | 0 0 << 4:30-5:30PM |      |      |             |      |      |            |      |      |            |      |      |
| Base Vol:                     | 149                | 0    | 1032 | 0           | 0    | 0    | 0          | 935  | 8    | 0          | 1209 | 244  |
| Growth Adj:                   | 1.00               | 1.00 | 1.00 | 1.00        | 1.00 | 1.00 | 1.00       | 1.00 | 1.00 | 1.00       | 1.00 | 1.00 |
| Initial Bse:                  | 149                | 0    | 1032 | 0           | 0    | 0    | 0          | 935  | 8    | 0          | 1209 | 244  |
| Added Vol:                    | 0                  | 0    | 0    | 0           | 0    | 0    | 0          | 0    | 0    | 0          | 0    | 0    |
| PasserByVol:                  | 0                  | 0    | 0    | 0           | 0    | 0    | 0          | 0    | 0    | 0          | 0    | 0    |
| Initial Fut:                  | 149                | 0    | 1032 | 0           | 0    | 0    | 0          | 935  | 8    | 0          | 1209 | 244  |
| User Adj:                     | 1.00               | 1.00 | 1.00 | 1.00        | 1.00 | 1.00 | 1.00       | 1.00 | 0.00 | 1.00       | 1.00 | 1.00 |
| PHF Adj:                      | 1.00               | 1.00 | 1.00 | 1.00        | 1.00 | 1.00 | 1.00       | 1.00 | 0.00 | 1.00       | 1.00 | 1.00 |
| PHF Volume:                   | 149                | 0    | 1032 | 0           | 0    | 0    | 0          | 935  | 0    | 0          | 1209 | 244  |
| Reduct Vol:                   | 0                  | 0    | 0    | 0           | 0    | 0    | 0          | 0    | 0    | 0          | 0    | 0    |
| Reduced Vol:                  | 149                | 0    | 1032 | 0           | 0    | 0    | 0          | 935  | 0    | 0          | 1209 | 244  |
| PCE Adj:                      | 1.00               | 1.00 | 1.00 | 1.00        | 1.00 | 1.00 | 1.00       | 1.00 | 0.00 | 1.00       | 1.00 | 1.00 |
| MLF Adj:                      | 1.00               | 1.00 | 1.00 | 1.00        | 1.00 | 1.00 | 1.00       | 1.00 | 0.00 | 1.00       | 1.00 | 1.00 |
| FinalVolume:                  | 149                | 0    | 1032 | 0           | 0    | 0    | 0          | 935  | 0    | 0          | 1209 | 244  |
| Saturation Flow Module:       |                    |      |      |             |      |      |            |      |      |            |      |      |
| Sat/Lane:                     | 1900               | 1900 | 1900 | 1900        | 1900 | 1900 | 1900       | 1900 | 1900 | 1900       | 1900 | 1900 |
| Adjustment:                   | 0.92               | 1.00 | 0.83 | 0.92        | 1.00 | 0.92 | 0.92       | 1.00 | 0.92 | 0.92       | 0.98 | 0.95 |
| Lanes:                        | 1.00               | 0.00 | 2.00 | 0.00        | 0.00 | 0.00 | 0.00       | 2.00 | 1.00 | 0.00       | 1.65 | 0.35 |
| Final Sat.:                   | 1750               | 0    | 3150 | 0           | 0    | 0    | 0          | 3800 | 1750 | 0          | 3078 | 621  |
| Capacity Analysis Module:     |                    |      |      |             |      |      |            |      |      |            |      |      |
| Vol/Sat:                      | 0.09               | 0.00 | 0.33 | 0.00        | 0.00 | 0.00 | 0.00       | 0.25 | 0.00 | 0.00       | 0.39 | 0.39 |
| Crit Moves:                   | ****               |      |      |             |      |      |            |      |      |            |      |      |
| Green Time:                   | 56.4               | 0.0  | 56.4 | 0.0         | 0.0  | 0.0  | 0.0        | 67.6 | 0.0  | 0.0        | 67.6 | 67.6 |
| Volume/Cap:                   | 0.20               | 0.00 | 0.76 | 0.00        | 0.00 | 0.00 | 0.00       | 0.47 | 0.00 | 0.00       | 0.76 | 0.76 |
| Delay/Veh:                    | 22.9               | 0.0  | 33.4 | 0.0         | 0.0  | 0.0  | 0.0        | 20.0 | 0.0  | 0.0        | 26.4 | 26.4 |
| User DelAdj:                  | 1.00               | 1.00 | 1.00 | 1.00        | 1.00 | 1.00 | 1.00       | 1.00 | 1.00 | 1.00       | 1.00 | 1.00 |
| AdjDel/Veh:                   | 22.9               | 0.0  | 33.4 | 0.0         | 0.0  | 0.0  | 0.0        | 20.0 | 0.0  | 0.0        | 26.4 | 26.4 |
| LOS by Move:                  | C                  | A    | C    | A           | A    | A    | A          | C    | A    | A          | C    | C    |
| HCM2k95thQ:                   | 8                  | 0    | 36   | 0           | 0    | 0    | 0          | 21   | 0    | 0          | 39   | 39   |

Note: Queue reported is the number of cars per lane.

BART

Level Of Service Computation Report  
2000 HCM Operations (Future Volume Alternative)  
AM - Cumulative No Project

Intersection #3043: 680S/ALUM ROCK (W) [Study Int 19]

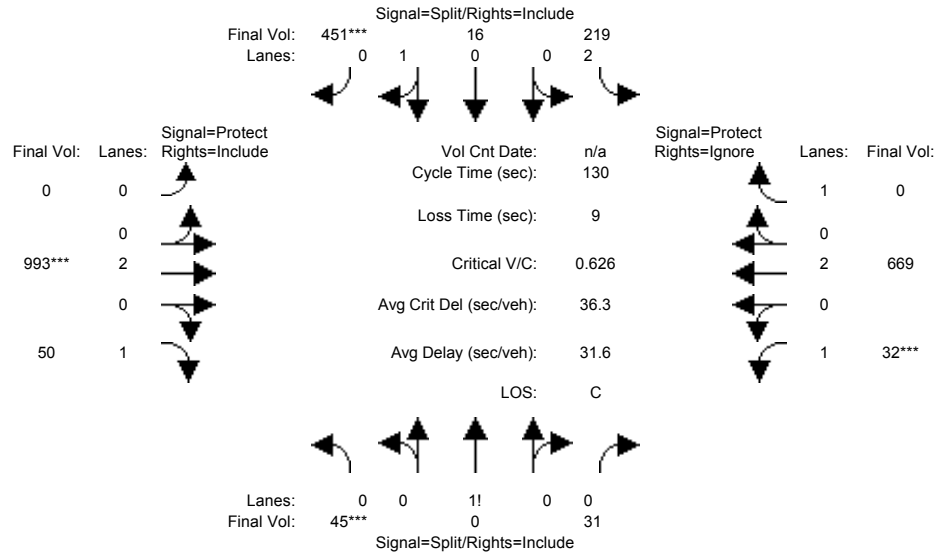

| Approach:                 | North Bound |      |      | South Bound |      |      | East Bound |      |      | West Bound |      |      |
|---------------------------|-------------|------|------|-------------|------|------|------------|------|------|------------|------|------|
| Movement:                 | L           | T    | R    | L           | T    | R    | L          | T    | R    | L          | T    | R    |
| Min. Green:               | 10          | 0    | 10   | 10          | 10   | 10   | 0          | 10   | 10   | 10         | 10   | 10   |
| Y+R:                      | 4.0         | 4.0  | 4.0  | 4.0         | 4.0  | 4.0  | 4.0        | 4.0  | 4.0  | 4.0        | 4.0  | 4.0  |
| Volume Module:            |             |      |      |             |      |      |            |      |      |            |      |      |
| Base Vol:                 | 45          | 0    | 31   | 219         | 16   | 451  | 0          | 993  | 50   | 32         | 669  | 0    |
| Growth Adj:               | 1.00        | 1.00 | 1.00 | 1.00        | 1.00 | 1.00 | 1.00       | 1.00 | 1.00 | 1.00       | 1.00 | 1.00 |
| Initial Bse:              | 45          | 0    | 31   | 219         | 16   | 451  | 0          | 993  | 50   | 32         | 669  | 0    |
| Added Vol:                | 0           | 0    | 0    | 0           | 0    | 0    | 0          | 0    | 0    | 0          | 0    | 0    |
| PasserByVol:              | 0           | 0    | 0    | 0           | 0    | 0    | 0          | 0    | 0    | 0          | 0    | 0    |
| Initial Fut:              | 45          | 0    | 31   | 219         | 16   | 451  | 0          | 993  | 50   | 32         | 669  | 0    |
| User Adj:                 | 1.00        | 1.00 | 1.00 | 1.00        | 1.00 | 1.00 | 1.00       | 1.00 | 1.00 | 1.00       | 1.00 | 0.00 |
| PHF Adj:                  | 1.00        | 1.00 | 1.00 | 1.00        | 1.00 | 1.00 | 1.00       | 1.00 | 1.00 | 1.00       | 1.00 | 0.00 |
| PHF Volume:               | 45          | 0    | 31   | 219         | 16   | 451  | 0          | 993  | 50   | 32         | 669  | 0    |
| Reduct Vol:               | 0           | 0    | 0    | 0           | 0    | 0    | 0          | 0    | 0    | 0          | 0    | 0    |
| Reduced Vol:              | 45          | 0    | 31   | 219         | 16   | 451  | 0          | 993  | 50   | 32         | 669  | 0    |
| PCE Adj:                  | 1.00        | 1.00 | 1.00 | 1.00        | 1.00 | 1.00 | 1.00       | 1.00 | 1.00 | 1.00       | 1.00 | 0.00 |
| MLF Adj:                  | 1.00        | 1.00 | 1.00 | 1.00        | 1.00 | 1.00 | 1.00       | 1.00 | 1.00 | 1.00       | 1.00 | 0.00 |
| FinalVolume:              | 45          | 0    | 31   | 219         | 16   | 451  | 0          | 993  | 50   | 32         | 669  | 0    |
| Saturation Flow Module:   |             |      |      |             |      |      |            |      |      |            |      |      |
| Sat/Lane:                 | 1900        | 1900 | 1900 | 1900        | 1900 | 1900 | 1900       | 1900 | 1900 | 1900       | 1900 | 1900 |
| Adjustment:               | 0.92        | 0.92 | 0.92 | 0.83        | 0.95 | 0.95 | 0.92       | 1.00 | 0.92 | 0.92       | 1.00 | 0.92 |
| Lanes:                    | 0.59        | 0.00 | 0.41 | 2.00        | 0.03 | 0.97 | 0.00       | 2.00 | 1.00 | 1.00       | 2.00 | 1.00 |
| Final Sat.:               | 1036        | 0    | 714  | 3150        | 62   | 1738 | 0          | 3800 | 1750 | 1750       | 3800 | 1750 |
| Capacity Analysis Module: |             |      |      |             |      |      |            |      |      |            |      |      |
| Vol/Sat:                  | 0.04        | 0.00 | 0.04 | 0.07        | 0.26 | 0.26 | 0.00       | 0.26 | 0.03 | 0.02       | 0.18 | 0.00 |
| Crit Moves:               | ****        |      |      | ****        |      |      | ****       |      |      | ****       |      |      |
| Green Time:               | 10.0        | 0.0  | 10.0 | 50.3        | 50.3 | 50.3 | 0.0        | 50.7 | 50.7 | 10.0       | 60.7 | 0.0  |
| Volume/Cap:               | 0.56        | 0.00 | 0.56 | 0.18        | 0.67 | 0.67 | 0.00       | 0.67 | 0.07 | 0.24       | 0.38 | 0.00 |
| Delay/Veh:                | 63.4        | 0.0  | 63.4 | 26.3        | 35.5 | 35.5 | 0.0        | 34.0 | 25.0 | 57.3       | 22.6 | 0.0  |
| User DelAdj:              | 1.00        | 1.00 | 1.00 | 1.00        | 1.00 | 1.00 | 1.00       | 1.00 | 1.00 | 1.00       | 1.00 | 1.00 |
| AdjDel/Veh:               | 63.4        | 0.0  | 63.4 | 26.3        | 35.5 | 35.5 | 0.0        | 34.0 | 25.0 | 57.3       | 22.6 | 0.0  |
| LOS by Move:              | E           | A    | E    | C           | D    | D    | A          | C    | C    | E          | C    | A    |
| HCM2k95thQ:               | 8           | 0    | 8    | 7           | 29   | 29   | 0          | 26   | 3    | 3          | 16   | 0    |

Note: Queue reported is the number of cars per lane.



BART

Level Of Service Computation Report  
 2000 HCM Operations (Future Volume Alternative)  
 PM - Cumulative No Project

Intersection #3043: 680S/ALUM ROCK (W) [Study Int 19]

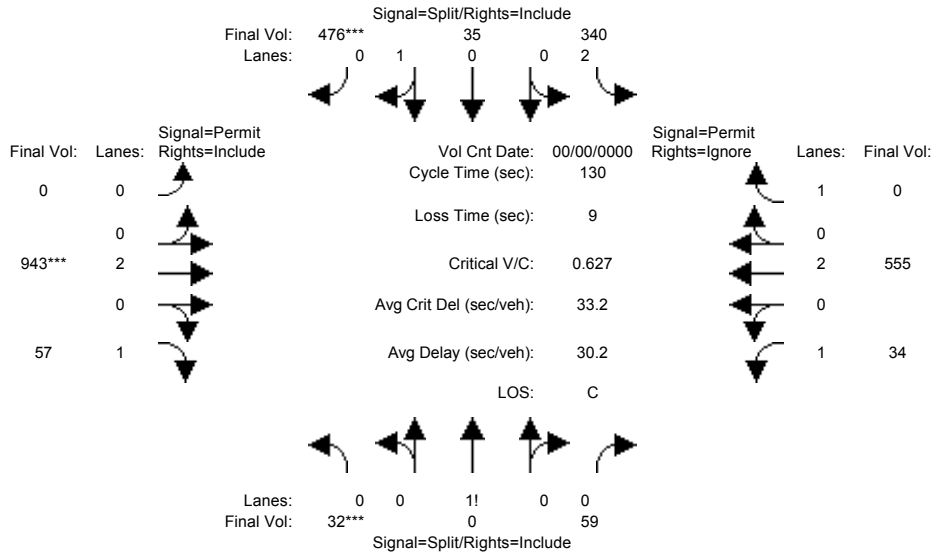

| Approach:  | North Bound |      |      | South Bound |      |      | East Bound |      |      | West Bound |      |      |
|--|-------------|------|------|-------------|------|------|------------|------|------|------------|------|------|
| Movement:  | L           | T    | R    | L           | T    | R    | L          | T    | R    | L          | T    | R    |
| Min. Green:                                      | 10          | 0    | 10   | 10          | 10   | 10   | 0          | 10   | 10   | 10         | 10   | 10   |
| Y+R:   | 4.0         | 4.0  | 4.0  | 4.0         | 4.0  | 4.0  | 4.0        | 4.0  | 4.0  | 4.0        | 4.0  | 4.0  |
| Volume Module: >> Count Date: 0 0 << 4:45-5:45PM |             |      |      |             |      |      |            |      |      |            |      |      |
| Base Vol:  | 32          | 0    | 59   | 340         | 35   | 476  | 0          | 943  | 57   | 34         | 555  | 592  |
| Growth Adj:                                      | 1.00        | 1.00 | 1.00 | 1.00        | 1.00 | 1.00 | 1.00       | 1.00 | 1.00 | 1.00       | 1.00 | 1.00 |
| Initial Bse:                                     | 32          | 0    | 59   | 340         | 35   | 476  | 0          | 943  | 57   | 34         | 555  | 592  |
| Added Vol:                                       | 0           | 0    | 0    | 0           | 0    | 0    | 0          | 0    | 0    | 0          | 0    | 0    |
| PasserByVol:                                     | 0           | 0    | 0    | 0           | 0    | 0    | 0          | 0    | 0    | 0          | 0    | 0    |
| Initial Fut:                                     | 32          | 0    | 59   | 340         | 35   | 476  | 0          | 943  | 57   | 34         | 555  | 592  |
| User Adj:  | 1.00        | 1.00 | 1.00 | 1.00        | 1.00 | 1.00 | 1.00       | 1.00 | 1.00 | 1.00       | 1.00 | 0.00 |
| PHF Adj:   | 1.00        | 1.00 | 1.00 | 1.00        | 1.00 | 1.00 | 1.00       | 1.00 | 1.00 | 1.00       | 1.00 | 0.00 |
| PHF Volume:                                      | 32          | 0    | 59   | 340         | 35   | 476  | 0          | 943  | 57   | 34         | 555  | 0    |
| Reduct Vol:                                      | 0           | 0    | 0    | 0           | 0    | 0    | 0          | 0    | 0    | 0          | 0    | 0    |
| Reduced Vol:                                     | 32          | 0    | 59   | 340         | 35   | 476  | 0          | 943  | 57   | 34         | 555  | 0    |
| PCE Adj:   | 1.00        | 1.00 | 1.00 | 1.00        | 1.00 | 1.00 | 1.00       | 1.00 | 1.00 | 1.00       | 1.00 | 0.00 |
| MLF Adj:   | 1.00        | 1.00 | 1.00 | 1.00        | 1.00 | 1.00 | 1.00       | 1.00 | 1.00 | 1.00       | 1.00 | 0.00 |
| FinalVolume:                                     | 32          | 0    | 59   | 340         | 35   | 476  | 0          | 943  | 57   | 34         | 555  | 0    |
| Saturation Flow Module:                          |             |      |      |             |      |      |            |      |      |            |      |      |
| Sat/Lane:  | 1900        | 1900 | 1900 | 1900        | 1900 | 1900 | 1900       | 1900 | 1900 | 1900       | 1900 | 1900 |
| Adjustment:                                      | 0.92        | 0.92 | 0.92 | 0.83        | 0.95 | 0.95 | 0.92       | 1.00 | 0.92 | 0.92       | 1.00 | 0.92 |
| Lanes:   | 0.35        | 0.00 | 0.65 | 2.00        | 0.07 | 0.93 | 0.00       | 2.00 | 1.00 | 1.00       | 2.00 | 1.00 |
| Final Sat.:                                      | 615         | 0    | 1135 | 3150        | 123  | 1677 | 0          | 3800 | 1750 | 1750       | 3800 | 1750 |
| Capacity Analysis Module:                        |             |      |      |             |      |      |            |      |      |            |      |      |
| Vol/Sat:   | 0.05        | 0.00 | 0.05 | 0.11        | 0.28 | 0.28 | 0.00       | 0.25 | 0.03 | 0.02       | 0.15 | 0.00 |
| Crit Moves:                                      | ****        |      |      | ****        |      |      | ****       |      |      |            |      |      |
| Green Time:                                      | 10.8        | 0.0  | 10.8 | 58.8        | 58.8 | 58.8 | 0.0        | 51.4 | 51.4 | 51.4       | 51.4 | 0.0  |
| Volume/Cap:                                      | 0.63        | 0.00 | 0.63 | 0.24        | 0.63 | 0.63 | 0.00       | 0.63 | 0.08 | 0.05       | 0.37 | 0.00 |
| Delay/Veh:                                       | 66.1        | 0.0  | 66.1 | 21.9        | 28.8 | 28.8 | 0.0        | 32.4 | 24.6 | 24.3       | 28.0 | 0.0  |
| User DelAdj:                                     | 1.00        | 1.00 | 1.00 | 1.00        | 1.00 | 1.00 | 1.00       | 1.00 | 1.00 | 1.00       | 1.00 | 1.00 |
| AdjDel/Veh:                                      | 66.1        | 0.0  | 66.1 | 21.9        | 28.8 | 28.8 | 0.0        | 32.4 | 24.6 | 24.3       | 28.0 | 0.0  |
| LOS by Move:                                     | E           | A    | E    | C           | C    | C    | A          | C    | C    | C          | C    | A    |
| HCM2k95thQ:                                      | 10          | 0    | 10   | 10          | 29   | 29   | 0          | 25   | 3    | 2          | 15   | 0    |

Note: Queue reported is the number of cars per lane.

BART

Level Of Service Computation Report  
 2000 HCM Operations (Future Volume Alternative)  
 AM - Cumulative With Project

Intersection #3043: 680S/ALUM ROCK (W) [Study Int 19]

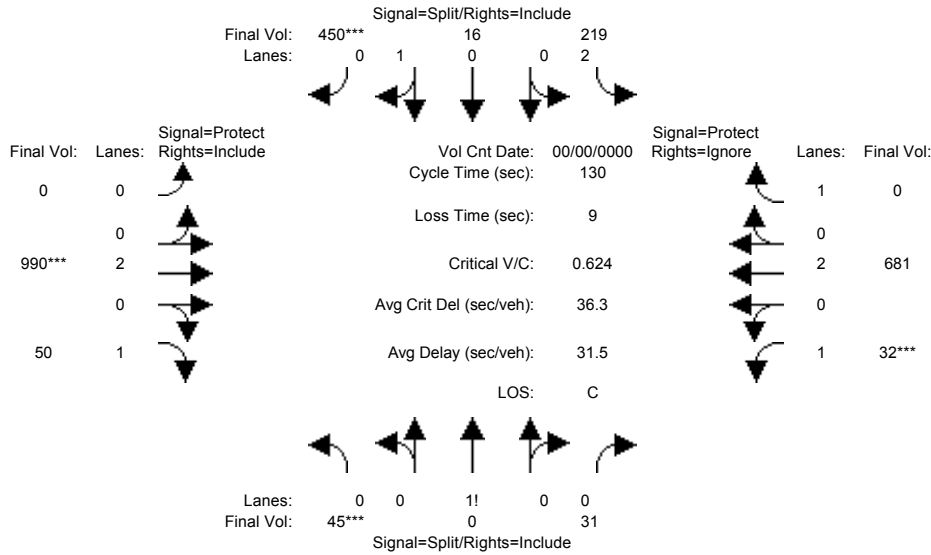

| Approach:  | North Bound |      |      | South Bound |      |      | East Bound |      |      | West Bound |      |      |
|--|-------------|------|------|-------------|------|------|------------|------|------|------------|------|------|
| Movement:  | L           | T    | R    | L           | T    | R    | L          | T    | R    | L          | T    | R    |
| Min. Green:                                      | 10          | 0    | 10   | 10          | 10   | 10   | 0          | 10   | 10   | 10         | 10   | 10   |
| Y+R:   | 4.0         | 4.0  | 4.0  | 4.0         | 4.0  | 4.0  | 4.0        | 4.0  | 4.0  | 4.0        | 4.0  | 4.0  |
| Volume Module: >> Count Date: 0 0 << 7:00-8:00AM |             |      |      |             |      |      |            |      |      |            |      |      |
| Base Vol:  | 45          | 0    | 31   | 219         | 16   | 450  | 0          | 990  | 50   | 32         | 681  | 0    |
| Growth Adj:                                      | 1.00        | 1.00 | 1.00 | 1.00        | 1.00 | 1.00 | 1.00       | 1.00 | 1.00 | 1.00       | 1.00 | 1.00 |
| Initial Bse:                                     | 45          | 0    | 31   | 219         | 16   | 450  | 0          | 990  | 50   | 32         | 681  | 0    |
| Added Vol:                                       | 0           | 0    | 0    | 0           | 0    | 0    | 0          | 0    | 0    | 0          | 0    | 0    |
| PasserByVol:                                     | 0           | 0    | 0    | 0           | 0    | 0    | 0          | 0    | 0    | 0          | 0    | 0    |
| Initial Fut:                                     | 45          | 0    | 31   | 219         | 16   | 450  | 0          | 990  | 50   | 32         | 681  | 0    |
| User Adj:  | 1.00        | 1.00 | 1.00 | 1.00        | 1.00 | 1.00 | 1.00       | 1.00 | 1.00 | 1.00       | 1.00 | 0.00 |
| PHF Adj:   | 1.00        | 1.00 | 1.00 | 1.00        | 1.00 | 1.00 | 1.00       | 1.00 | 1.00 | 1.00       | 1.00 | 0.00 |
| PHF Volume:                                      | 45          | 0    | 31   | 219         | 16   | 450  | 0          | 990  | 50   | 32         | 681  | 0    |
| Reduct Vol:                                      | 0           | 0    | 0    | 0           | 0    | 0    | 0          | 0    | 0    | 0          | 0    | 0    |
| Reduced Vol:                                     | 45          | 0    | 31   | 219         | 16   | 450  | 0          | 990  | 50   | 32         | 681  | 0    |
| PCE Adj:   | 1.00        | 1.00 | 1.00 | 1.00        | 1.00 | 1.00 | 1.00       | 1.00 | 1.00 | 1.00       | 1.00 | 0.00 |
| MLF Adj:   | 1.00        | 1.00 | 1.00 | 1.00        | 1.00 | 1.00 | 1.00       | 1.00 | 1.00 | 1.00       | 1.00 | 0.00 |
| FinalVolume:                                     | 45          | 0    | 31   | 219         | 16   | 450  | 0          | 990  | 50   | 32         | 681  | 0    |
| Saturation Flow Module:                          |             |      |      |             |      |      |            |      |      |            |      |      |
| Sat/Lane:  | 1900        | 1900 | 1900 | 1900        | 1900 | 1900 | 1900       | 1900 | 1900 | 1900       | 1900 | 1900 |
| Adjustment:                                      | 0.92        | 0.92 | 0.92 | 0.83        | 0.95 | 0.95 | 0.92       | 1.00 | 0.92 | 0.92       | 1.00 | 0.92 |
| Lanes:   | 0.59        | 0.00 | 0.41 | 2.00        | 0.03 | 0.97 | 0.00       | 2.00 | 1.00 | 1.00       | 2.00 | 1.00 |
| Final Sat.:                                      | 1036        | 0    | 714  | 3150        | 62   | 1738 | 0          | 3800 | 1750 | 1750       | 3800 | 1750 |
| Capacity Analysis Module:                        |             |      |      |             |      |      |            |      |      |            |      |      |
| Vol/Sat:   | 0.04        | 0.00 | 0.04 | 0.07        | 0.26 | 0.26 | 0.00       | 0.26 | 0.03 | 0.02       | 0.18 | 0.00 |
| Crit Moves:                                      | ****        |      |      | ****        |      |      | ****       |      |      | ****       |      |      |
| Green Time:                                      | 10.0        | 0.0  | 10.0 | 50.3        | 50.3 | 50.3 | 0.0        | 50.7 | 50.7 | 10.0       | 60.7 | 0.0  |
| Volume/Cap:                                      | 0.56        | 0.00 | 0.56 | 0.18        | 0.67 | 0.67 | 0.00       | 0.67 | 0.07 | 0.24       | 0.38 | 0.00 |
| Delay/Veh:                                       | 63.4        | 0.0  | 63.4 | 26.3        | 35.4 | 35.4 | 0.0        | 33.9 | 25.0 | 57.3       | 22.7 | 0.0  |
| User DelAdj:                                     | 1.00        | 1.00 | 1.00 | 1.00        | 1.00 | 1.00 | 1.00       | 1.00 | 1.00 | 1.00       | 1.00 | 1.00 |
| AdjDel/Veh:                                      | 63.4        | 0.0  | 63.4 | 26.3        | 35.4 | 35.4 | 0.0        | 33.9 | 25.0 | 57.3       | 22.7 | 0.0  |
| LOS by Move:                                     | E           | A    | E    | C           | D    | D    | A          | C    | C    | E          | C    | A    |
| HCM2k95thQ:                                      | 8           | 0    | 8    | 7           | 29   | 29   | 0          | 26   | 3    | 3          | 16   | 0    |

Note: Queue reported is the number of cars per lane.

BART

Level Of Service Computation Report  
 2000 HCM Operations (Future Volume Alternative)  
 PM - Cumulative With Project

Intersection #3043: 680S/ALUM ROCK (W) [Study Int 19]

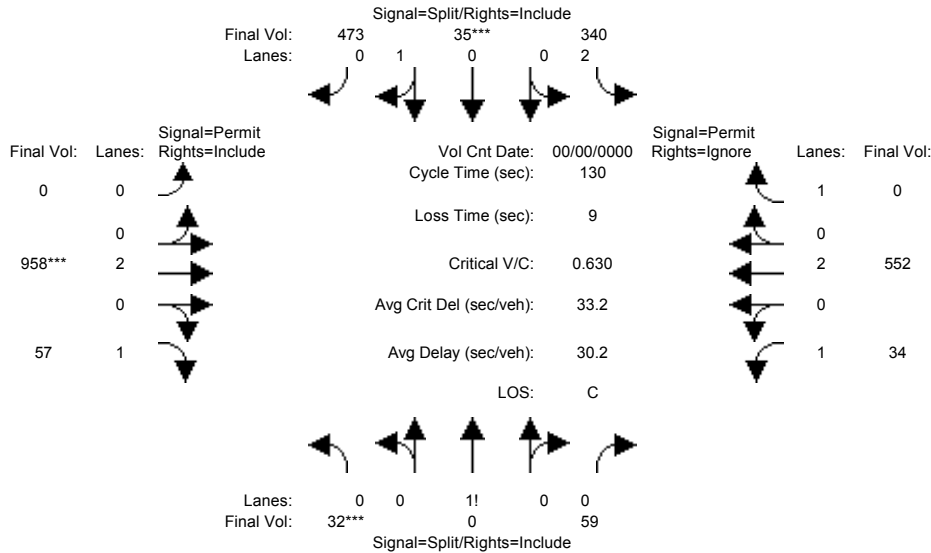

| Approach:                     | North Bound        |      |      | South Bound |      |      | East Bound |      |      | West Bound |      |      |
|-------------------------------|--------------------|------|------|-------------|------|------|------------|------|------|------------|------|------|
| Movement:                     | L                  | T    | R    | L           | T    | R    | L          | T    | R    | L          | T    | R    |
| Min. Green:                   | 10                 | 0    | 10   | 10          | 10   | 10   | 0          | 10   | 10   | 10         | 10   | 10   |
| Y+R:                          | 4.0                | 4.0  | 4.0  | 4.0         | 4.0  | 4.0  | 4.0        | 4.0  | 4.0  | 4.0        | 4.0  | 4.0  |
| Volume Module: >> Count Date: | 0 0 << 4:45-5:45PM |      |      |             |      |      |            |      |      |            |      |      |
| Base Vol:                     | 32                 | 0    | 59   | 340         | 35   | 473  | 0          | 958  | 57   | 34         | 552  | 592  |
| Growth Adj:                   | 1.00               | 1.00 | 1.00 | 1.00        | 1.00 | 1.00 | 1.00       | 1.00 | 1.00 | 1.00       | 1.00 | 1.00 |
| Initial Bse:                  | 32                 | 0    | 59   | 340         | 35   | 473  | 0          | 958  | 57   | 34         | 552  | 592  |
| Added Vol:                    | 0                  | 0    | 0    | 0           | 0    | 0    | 0          | 0    | 0    | 0          | 0    | 0    |
| PasserByVol:                  | 0                  | 0    | 0    | 0           | 0    | 0    | 0          | 0    | 0    | 0          | 0    | 0    |
| Initial Fut:                  | 32                 | 0    | 59   | 340         | 35   | 473  | 0          | 958  | 57   | 34         | 552  | 592  |
| User Adj:                     | 1.00               | 1.00 | 1.00 | 1.00        | 1.00 | 1.00 | 1.00       | 1.00 | 1.00 | 1.00       | 1.00 | 0.00 |
| PHF Adj:                      | 1.00               | 1.00 | 1.00 | 1.00        | 1.00 | 1.00 | 1.00       | 1.00 | 1.00 | 1.00       | 1.00 | 0.00 |
| PHF Volume:                   | 32                 | 0    | 59   | 340         | 35   | 473  | 0          | 958  | 57   | 34         | 552  | 0    |
| Reduct Vol:                   | 0                  | 0    | 0    | 0           | 0    | 0    | 0          | 0    | 0    | 0          | 0    | 0    |
| Reduced Vol:                  | 32                 | 0    | 59   | 340         | 35   | 473  | 0          | 958  | 57   | 34         | 552  | 0    |
| PCE Adj:                      | 1.00               | 1.00 | 1.00 | 1.00        | 1.00 | 1.00 | 1.00       | 1.00 | 1.00 | 1.00       | 1.00 | 0.00 |
| MLF Adj:                      | 1.00               | 1.00 | 1.00 | 1.00        | 1.00 | 1.00 | 1.00       | 1.00 | 1.00 | 1.00       | 1.00 | 0.00 |
| Final Volume:                 | 32                 | 0    | 59   | 340         | 35   | 473  | 0          | 958  | 57   | 34         | 552  | 0    |
| Saturation Flow Module:       |                    |      |      |             |      |      |            |      |      |            |      |      |
| Sat/Lane:                     | 1900               | 1900 | 1900 | 1900        | 1900 | 1900 | 1900       | 1900 | 1900 | 1900       | 1900 | 1900 |
| Adjustment:                   | 0.92               | 0.92 | 0.92 | 0.83        | 0.95 | 0.95 | 0.92       | 1.00 | 0.92 | 0.92       | 1.00 | 0.92 |
| Lanes:                        | 0.35               | 0.00 | 0.65 | 2.00        | 0.07 | 0.93 | 0.00       | 2.00 | 1.00 | 1.00       | 2.00 | 1.00 |
| Final Sat.:                   | 615                | 0    | 1135 | 3150        | 124  | 1676 | 0          | 3800 | 1750 | 1750       | 3800 | 1750 |
| Capacity Analysis Module:     |                    |      |      |             |      |      |            |      |      |            |      |      |
| Vol/Sat:                      | 0.05               | 0.00 | 0.05 | 0.11        | 0.28 | 0.28 | 0.00       | 0.25 | 0.03 | 0.02       | 0.15 | 0.00 |
| Crit Moves:                   | ****               |      |      |             |      |      |            |      |      |            |      |      |
| Green Time:                   | 10.7               | 0.0  | 10.7 | 58.2        | 58.2 | 58.2 | 0.0        | 52.0 | 52.0 | 52.0       | 52.0 | 0.0  |
| Volume/Cap:                   | 0.63               | 0.00 | 0.63 | 0.24        | 0.63 | 0.63 | 0.00       | 0.63 | 0.08 | 0.05       | 0.36 | 0.00 |
| Delay/Veh:                    | 66.3               | 0.0  | 66.3 | 22.3        | 29.2 | 29.2 | 0.0        | 32.1 | 24.2 | 23.9       | 27.5 | 0.0  |
| User DelAdj:                  | 1.00               | 1.00 | 1.00 | 1.00        | 1.00 | 1.00 | 1.00       | 1.00 | 1.00 | 1.00       | 1.00 | 1.00 |
| AdjDel/Veh:                   | 66.3               | 0.0  | 66.3 | 22.3        | 29.2 | 29.2 | 0.0        | 32.1 | 24.2 | 23.9       | 27.5 | 0.0  |
| LOS by Move:                  | E                  | A    | E    | C           | C    | C    | A          | C    | C    | C          | C    | A    |
| HCM2k95thQ:                   | 10                 | 0    | 10   | 10          | 29   | 29   | 0          | 25   | 3    | 2          | 14   | 0    |

Note: Queue reported is the number of cars per lane.

BART

Level Of Service Computation Report  
 2000 HCM Operations (Future Volume Alternative)  
 AM - Cumulative No Project

Intersection #3046: The Alameda/880 SB Ramps [Study Int 56]

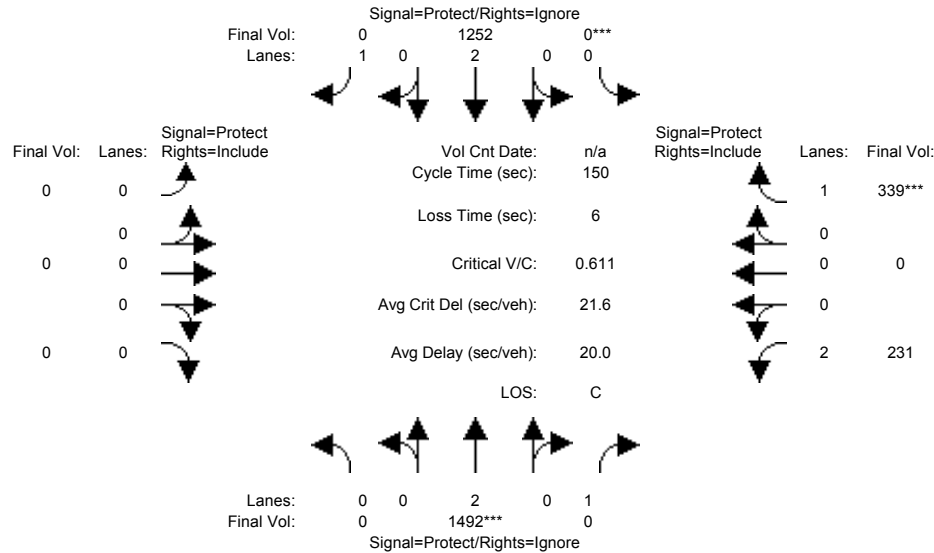

| Approach:                 | North Bound |      |      | South Bound |      |      | East Bound |      |      | West Bound |      |      |
|---------------------------|-------------|------|------|-------------|------|------|------------|------|------|------------|------|------|
| Movement:                 | L           | T    | R    | L           | T    | R    | L          | T    | R    | L          | T    | R    |
| Min. Green:               | 0           | 10   | 10   | 0           | 10   | 10   | 0          | 0    | 0    | 10         | 0    | 10   |
| Y+R:                      | 4.0         | 4.0  | 4.0  | 4.0         | 4.0  | 4.0  | 4.0        | 4.0  | 4.0  | 4.0        | 4.0  | 4.0  |
| Volume Module:            |             |      |      |             |      |      |            |      |      |            |      |      |
| Base Vol:                 | 0           | 1492 | 313  | 0           | 1252 | 193  | 0          | 0    | 0    | 231        | 0    | 339  |
| Growth Adj:               | 1.00        | 1.00 | 1.00 | 1.00        | 1.00 | 1.00 | 1.00       | 1.00 | 1.00 | 1.00       | 1.00 | 1.00 |
| Initial Bse:              | 0           | 1492 | 313  | 0           | 1252 | 193  | 0          | 0    | 0    | 231        | 0    | 339  |
| Added Vol:                | 0           | 0    | 0    | 0           | 0    | 0    | 0          | 0    | 0    | 0          | 0    | 0    |
| PasserByVol:              | 0           | 0    | 0    | 0           | 0    | 0    | 0          | 0    | 0    | 0          | 0    | 0    |
| Initial Fut:              | 0           | 1492 | 313  | 0           | 1252 | 193  | 0          | 0    | 0    | 231        | 0    | 339  |
| User Adj:                 | 1.00        | 1.00 | 0.00 | 1.00        | 1.00 | 0.00 | 1.00       | 1.00 | 1.00 | 1.00       | 1.00 | 1.00 |
| PHF Adj:                  | 1.00        | 1.00 | 0.00 | 1.00        | 1.00 | 0.00 | 1.00       | 1.00 | 1.00 | 1.00       | 1.00 | 1.00 |
| PHF Volume:               | 0           | 1492 | 0    | 0           | 1252 | 0    | 0          | 0    | 0    | 231        | 0    | 339  |
| Reduct Vol:               | 0           | 0    | 0    | 0           | 0    | 0    | 0          | 0    | 0    | 0          | 0    | 0    |
| Reduced Vol:              | 0           | 1492 | 0    | 0           | 1252 | 0    | 0          | 0    | 0    | 231        | 0    | 339  |
| PCE Adj:                  | 1.00        | 1.00 | 0.00 | 1.00        | 1.00 | 0.00 | 1.00       | 1.00 | 1.00 | 1.00       | 1.00 | 1.00 |
| MLF Adj:                  | 1.00        | 1.00 | 0.00 | 1.00        | 1.00 | 0.00 | 1.00       | 1.00 | 1.00 | 1.00       | 1.00 | 1.00 |
| FinalVolume:              | 0           | 1492 | 0    | 0           | 1252 | 0    | 0          | 0    | 0    | 231        | 0    | 339  |
| Saturation Flow Module:   |             |      |      |             |      |      |            |      |      |            |      |      |
| Sat/Lane:                 | 1900        | 1900 | 1900 | 1900        | 1900 | 1900 | 1900       | 1900 | 1900 | 1900       | 1900 | 1900 |
| Adjustment:               | 0.92        | 1.00 | 0.92 | 0.92        | 1.00 | 0.92 | 0.92       | 1.00 | 0.92 | 0.83       | 1.00 | 0.92 |
| Lanes:                    | 0.00        | 2.00 | 1.00 | 0.00        | 2.00 | 1.00 | 0.00       | 0.00 | 0.00 | 2.00       | 0.00 | 1.00 |
| Final Sat.:               | 0           | 3800 | 1750 | 0           | 3800 | 1750 | 0          | 0    | 0    | 3150       | 0    | 1750 |
| Capacity Analysis Module: |             |      |      |             |      |      |            |      |      |            |      |      |
| Vol/Sat:                  | 0.00        | 0.39 | 0.00 | 0.00        | 0.33 | 0.00 | 0.00       | 0.00 | 0.00 | 0.07       | 0.00 | 0.19 |
| Crit Moves:               | ****        | **** | **** | ****        | **** | **** | ****       | **** | **** | ****       | **** | **** |
| Green Time:               | 0.0         | 96.4 | 0.0  | 0.0         | 96.4 | 0.0  | 0.0        | 0.0  | 0.0  | 47.6       | 0.0  | 47.6 |
| Volume/Cap:               | 0.00        | 0.61 | 0.00 | 0.00        | 0.51 | 0.00 | 0.00       | 0.00 | 0.00 | 0.23       | 0.00 | 0.61 |
| Delay/Veh:                | 0.0         | 16.2 | 0.0  | 0.0         | 14.5 | 0.0  | 0.0        | 0.0  | 0.0  | 37.9       | 0.0  | 45.4 |
| User DelAdj:              | 1.00        | 1.00 | 1.00 | 1.00        | 1.00 | 1.00 | 1.00       | 1.00 | 1.00 | 1.00       | 1.00 | 1.00 |
| AdjDel/Veh:               | 0.0         | 16.2 | 0.0  | 0.0         | 14.5 | 0.0  | 0.0        | 0.0  | 0.0  | 37.9       | 0.0  | 45.4 |
| LOS by Move:              | A           | B    | A    | A           | B    | A    | A          | A    | A    | D          | A    | D    |
| HCM2k95thQ:               | 0           | 34   | 0    | 0           | 26   | 0    | 0          | 0    | 0    | 9          | 0    | 26   |

Note: Queue reported is the number of cars per lane.

BART

Level Of Service Computation Report  
 2000 HCM Operations (Future Volume Alternative)  
 PM - Cumulative No Project

Intersection #3046: The Alameda/880 SB Ramps [Study Int 56]

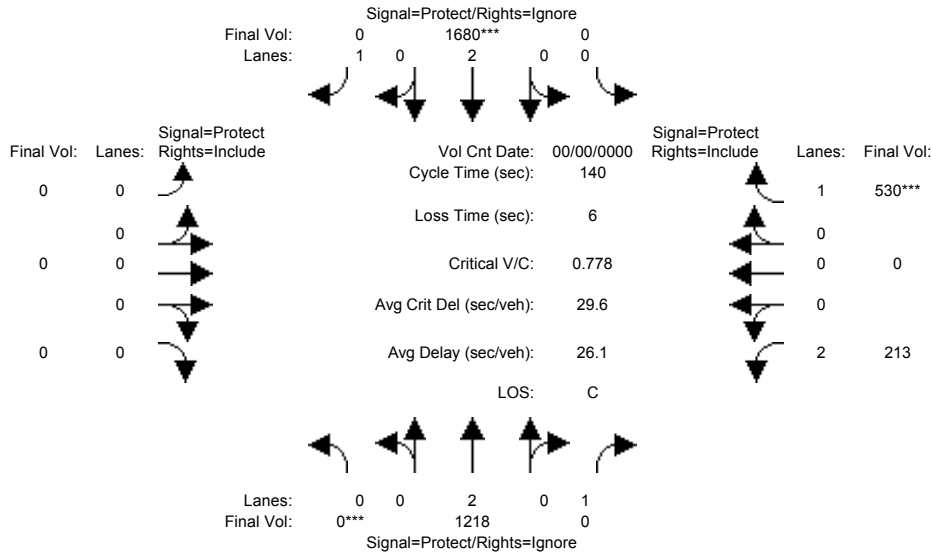

| Approach:                               | North Bound |      |      | South Bound |      |      | East Bound |      |      | West Bound |      |      |
|---|-------------|------|------|-------------|------|------|------------|------|------|------------|------|------|
| Movement:                               | L           | T    | R    | L           | T    | R    | L          | T    | R    | L          | T    | R    |
| Min. Green:                             | 0           | 10   | 10   | 0           | 10   | 10   | 0          | 0    | 0    | 10         | 0    | 10   |
| Y+R:                                    | 4.0         | 4.0  | 4.0  | 4.0         | 4.0  | 4.0  | 4.0        | 4.0  | 4.0  | 4.0        | 4.0  | 4.0  |
| Volume Module: >> Count Date: 0 0 << AM |             |      |      |             |      |      |            |      |      |            |      |      |
| Base Vol:                               | 0           | 1218 | 394  | 0           | 1680 | 362  | 0          | 0    | 0    | 213        | 0    | 530  |
| Growth Adj:                             | 1.00        | 1.00 | 1.00 | 1.00        | 1.00 | 1.00 | 1.00       | 1.00 | 1.00 | 1.00       | 1.00 | 1.00 |
| Initial Bse:                            | 0           | 1218 | 394  | 0           | 1680 | 362  | 0          | 0    | 0    | 213        | 0    | 530  |
| Added Vol:                              | 0           | 0    | 0    | 0           | 0    | 0    | 0          | 0    | 0    | 0          | 0    | 0    |
| PasserByVol:                            | 0           | 0    | 0    | 0           | 0    | 0    | 0          | 0    | 0    | 0          | 0    | 0    |
| Initial Fut:                            | 0           | 1218 | 394  | 0           | 1680 | 362  | 0          | 0    | 0    | 213        | 0    | 530  |
| User Adj:                               | 1.00        | 1.00 | 0.00 | 1.00        | 1.00 | 0.00 | 1.00       | 1.00 | 1.00 | 1.00       | 1.00 | 1.00 |
| PHF Adj:                                | 1.00        | 1.00 | 0.00 | 1.00        | 1.00 | 0.00 | 1.00       | 1.00 | 1.00 | 1.00       | 1.00 | 1.00 |
| PHF Volume:                             | 0           | 1218 | 0    | 0           | 1680 | 0    | 0          | 0    | 0    | 213        | 0    | 530  |
| Reduct Vol:                             | 0           | 0    | 0    | 0           | 0    | 0    | 0          | 0    | 0    | 0          | 0    | 0    |
| Reduced Vol:                            | 0           | 1218 | 0    | 0           | 1680 | 0    | 0          | 0    | 0    | 213        | 0    | 530  |
| PCE Adj:                                | 1.00        | 1.00 | 0.00 | 1.00        | 1.00 | 0.00 | 1.00       | 1.00 | 1.00 | 1.00       | 1.00 | 1.00 |
| MLF Adj:                                | 1.00        | 1.00 | 0.00 | 1.00        | 1.00 | 0.00 | 1.00       | 1.00 | 1.00 | 1.00       | 1.00 | 1.00 |
| Final Volume:                           | 0           | 1218 | 0    | 0           | 1680 | 0    | 0          | 0    | 0    | 213        | 0    | 530  |
| Saturation Flow Module:                 |             |      |      |             |      |      |            |      |      |            |      |      |
| Sat/Lane:                               | 1900        | 1900 | 1900 | 1900        | 1900 | 1900 | 1900       | 1900 | 1900 | 1900       | 1900 | 1900 |
| Adjustment:                             | 0.92        | 1.00 | 0.92 | 0.92        | 1.00 | 0.92 | 0.92       | 1.00 | 0.92 | 0.83       | 1.00 | 0.92 |
| Lanes:                                  | 0.00        | 2.00 | 1.00 | 0.00        | 2.00 | 1.00 | 0.00       | 0.00 | 0.00 | 2.00       | 0.00 | 1.00 |
| Final Sat.:                             | 0           | 3800 | 1750 | 0           | 3800 | 1750 | 0          | 0    | 0    | 3150       | 0    | 1750 |
| Capacity Analysis Module:               |             |      |      |             |      |      |            |      |      |            |      |      |
| Vol/Sat:                                | 0.00        | 0.32 | 0.00 | 0.00        | 0.44 | 0.00 | 0.00       | 0.00 | 0.00 | 0.07       | 0.00 | 0.30 |
| Crit Moves:                             | ****        |      |      | ****        |      |      |            |      |      | ****       |      |      |
| Green Time:                             | 0.0         | 79.5 | 0.0  | 0.0         | 79.5 | 0.0  | 0.0        | 0.0  | 0.0  | 54.5       | 0.0  | 54.5 |
| Volume/Cap:                             | 0.00        | 0.56 | 0.00 | 0.00        | 0.78 | 0.00 | 0.00       | 0.00 | 0.00 | 0.17       | 0.00 | 0.78 |
| Delay/Veh:                              | 0.0         | 19.6 | 0.0  | 0.0         | 25.3 | 0.0  | 0.0        | 0.0  | 0.0  | 28.1       | 0.0  | 43.2 |
| User DelAdj:                            | 1.00        | 1.00 | 1.00 | 1.00        | 1.00 | 1.00 | 1.00       | 1.00 | 1.00 | 1.00       | 1.00 | 1.00 |
| AdjDel/Veh:                             | 0.0         | 19.6 | 0.0  | 0.0         | 25.3 | 0.0  | 0.0        | 0.0  | 0.0  | 28.1       | 0.0  | 43.2 |
| LOS by Move:                            | A           | B    | A    | A           | C    | A    | A          | A    | A    | C          | A    | D    |
| HCM2k95thQ:                             | 0           | 28   | 0    | 0           | 44   | 0    | 0          | 0    | 0    | 7          | 0    | 38   |

Note: Queue reported is the number of cars per lane.

BART

Level Of Service Computation Report  
 2000 HCM Operations (Future Volume Alternative)  
 AM - Cumulative With Project

Intersection #3046: The Alameda/880 SB Ramps [Study Int 56]

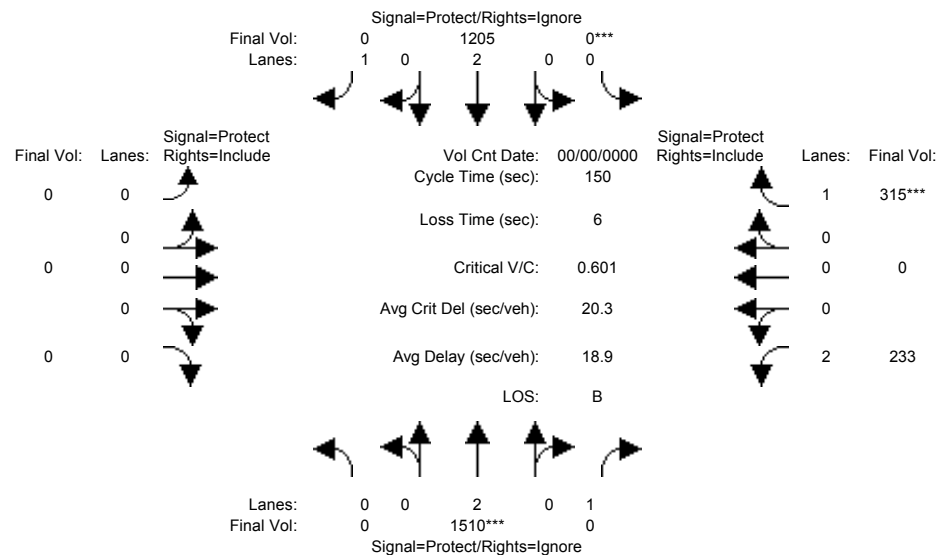

| Approach:                               | North Bound |      |      | South Bound |      |      | East Bound |      |      | West Bound |      |      |
|---|-------------|------|------|-------------|------|------|------------|------|------|------------|------|------|
| Movement:                               | L           | T    | R    | L           | T    | R    | L          | T    | R    | L          | T    | R    |
| Min. Green:                             | 0           | 10   | 10   | 0           | 10   | 10   | 0          | 0    | 0    | 10         | 0    | 10   |
| Y+R:                                    | 4.0         | 4.0  | 4.0  | 4.0         | 4.0  | 4.0  | 4.0        | 4.0  | 4.0  | 4.0        | 4.0  | 4.0  |
| Volume Module: >> Count Date: 0 0 << AM |             |      |      |             |      |      |            |      |      |            |      |      |
| Base Vol:                               | 0           | 1510 | 313  | 0           | 1205 | 193  | 0          | 0    | 0    | 233        | 0    | 315  |
| Growth Adj:                             | 1.00        | 1.00 | 1.00 | 1.00        | 1.00 | 1.00 | 1.00       | 1.00 | 1.00 | 1.00       | 1.00 | 1.00 |
| Initial Bse:                            | 0           | 1510 | 313  | 0           | 1205 | 193  | 0          | 0    | 0    | 233        | 0    | 315  |
| Added Vol:                              | 0           | 0    | 0    | 0           | 0    | 0    | 0          | 0    | 0    | 0          | 0    | 0    |
| PasserByVol:                            | 0           | 0    | 0    | 0           | 0    | 0    | 0          | 0    | 0    | 0          | 0    | 0    |
| Initial Fut:                            | 0           | 1510 | 313  | 0           | 1205 | 193  | 0          | 0    | 0    | 233        | 0    | 315  |
| User Adj:                               | 1.00        | 1.00 | 0.00 | 1.00        | 1.00 | 0.00 | 1.00       | 1.00 | 1.00 | 1.00       | 1.00 | 1.00 |
| PHF Adj:                                | 1.00        | 1.00 | 0.00 | 1.00        | 1.00 | 0.00 | 1.00       | 1.00 | 1.00 | 1.00       | 1.00 | 1.00 |
| PHF Volume:                             | 0           | 1510 | 0    | 0           | 1205 | 0    | 0          | 0    | 0    | 233        | 0    | 315  |
| Reduct Vol:                             | 0           | 0    | 0    | 0           | 0    | 0    | 0          | 0    | 0    | 0          | 0    | 0    |
| Reduced Vol:                            | 0           | 1510 | 0    | 0           | 1205 | 0    | 0          | 0    | 0    | 233        | 0    | 315  |
| PCE Adj:                                | 1.00        | 1.00 | 0.00 | 1.00        | 1.00 | 0.00 | 1.00       | 1.00 | 1.00 | 1.00       | 1.00 | 1.00 |
| MLF Adj:                                | 1.00        | 1.00 | 0.00 | 1.00        | 1.00 | 0.00 | 1.00       | 1.00 | 1.00 | 1.00       | 1.00 | 1.00 |
| Final Volume:                           | 0           | 1510 | 0    | 0           | 1205 | 0    | 0          | 0    | 0    | 233        | 0    | 315  |
| Saturation Flow Module:                 |             |      |      |             |      |      |            |      |      |            |      |      |
| Sat/Lane:                               | 1900        | 1900 | 1900 | 1900        | 1900 | 1900 | 1900       | 1900 | 1900 | 1900       | 1900 | 1900 |
| Adjustment:                             | 0.92        | 1.00 | 0.92 | 0.92        | 1.00 | 0.92 | 0.92       | 1.00 | 0.92 | 0.83       | 1.00 | 0.92 |
| Lanes:                                  | 0.00        | 2.00 | 1.00 | 0.00        | 2.00 | 1.00 | 0.00       | 0.00 | 0.00 | 2.00       | 0.00 | 1.00 |
| Final Sat.:                             | 0           | 3800 | 1750 | 0           | 3800 | 1750 | 0          | 0    | 0    | 3150       | 0    | 1750 |
| Capacity Analysis Module:               |             |      |      |             |      |      |            |      |      |            |      |      |
| Vol/Sat:                                | 0.00        | 0.40 | 0.00 | 0.00        | 0.32 | 0.00 | 0.00       | 0.00 | 0.00 | 0.07       | 0.00 | 0.18 |
| Crit Moves:                             | ****        | **** | **** | ****        | **** | **** | ****       | **** | **** | ****       | **** | **** |
| Green Time:                             | 0.0         | 99.1 | 0.0  | 0.0         | 99.1 | 0.0  | 0.0        | 0.0  | 0.0  | 44.9       | 0.0  | 44.9 |
| Volume/Cap:                             | 0.00        | 0.60 | 0.00 | 0.00        | 0.48 | 0.00 | 0.00       | 0.00 | 0.00 | 0.25       | 0.00 | 0.60 |
| Delay/Veh:                              | 0.0         | 14.7 | 0.0  | 0.0         | 12.8 | 0.0  | 0.0        | 0.0  | 0.0  | 39.9       | 0.0  | 46.9 |
| User DelAdj:                            | 1.00        | 1.00 | 1.00 | 1.00        | 1.00 | 1.00 | 1.00       | 1.00 | 1.00 | 1.00       | 1.00 | 1.00 |
| AdjDel/Veh:                             | 0.0         | 14.7 | 0.0  | 0.0         | 12.8 | 0.0  | 0.0        | 0.0  | 0.0  | 39.9       | 0.0  | 46.9 |
| LOS by Move:                            | A           | B    | A    | A           | B    | A    | A          | A    | A    | D          | A    | D    |
| HCM2k95thQ:                             | 0           | 33   | 0    | 0           | 24   | 0    | 0          | 0    | 0    | 9          | 0    | 24   |

Note: Queue reported is the number of cars per lane.

BART

Level Of Service Computation Report  
 2000 HCM Operations (Future Volume Alternative)  
 PM - Cumulative With Project

Intersection #3046: The Alameda/880 SB Ramps [Study Int 56]

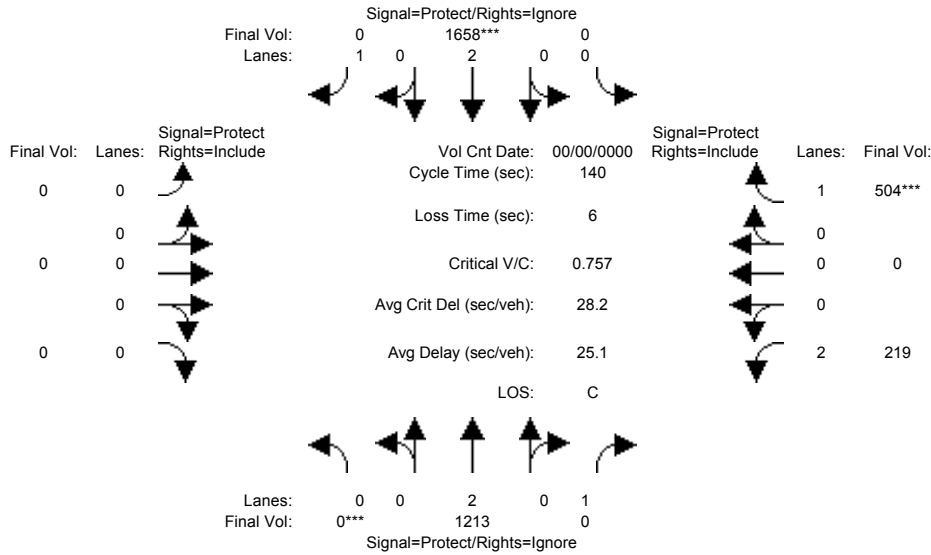

| Approach:                               | North Bound |      |      | South Bound |      |      | East Bound |      |      | West Bound |      |      |
|---|-------------|------|------|-------------|------|------|------------|------|------|------------|------|------|
| Movement:                               | L           | T    | R    | L           | T    | R    | L          | T    | R    | L          | T    | R    |
| Min. Green:                             | 0           | 10   | 10   | 0           | 10   | 10   | 0          | 0    | 0    | 10         | 0    | 10   |
| Y+R:                                    | 4.0         | 4.0  | 4.0  | 4.0         | 4.0  | 4.0  | 4.0        | 4.0  | 4.0  | 4.0        | 4.0  | 4.0  |
| Volume Module: >> Count Date: 0 0 << AM |             |      |      |             |      |      |            |      |      |            |      |      |
| Base Vol:                               | 0           | 1213 | 394  | 0           | 1658 | 362  | 0          | 0    | 0    | 219        | 0    | 504  |
| Growth Adj:                             | 1.00        | 1.00 | 1.00 | 1.00        | 1.00 | 1.00 | 1.00       | 1.00 | 1.00 | 1.00       | 1.00 | 1.00 |
| Initial Bse:                            | 0           | 1213 | 394  | 0           | 1658 | 362  | 0          | 0    | 0    | 219        | 0    | 504  |
| Added Vol:                              | 0           | 0    | 0    | 0           | 0    | 0    | 0          | 0    | 0    | 0          | 0    | 0    |
| PasserByVol:                            | 0           | 0    | 0    | 0           | 0    | 0    | 0          | 0    | 0    | 0          | 0    | 0    |
| Initial Fut:                            | 0           | 1213 | 394  | 0           | 1658 | 362  | 0          | 0    | 0    | 219        | 0    | 504  |
| User Adj:                               | 1.00        | 1.00 | 0.00 | 1.00        | 1.00 | 0.00 | 1.00       | 1.00 | 1.00 | 1.00       | 1.00 | 1.00 |
| PHF Adj:                                | 1.00        | 1.00 | 0.00 | 1.00        | 1.00 | 0.00 | 1.00       | 1.00 | 1.00 | 1.00       | 1.00 | 1.00 |
| PHF Volume:                             | 0           | 1213 | 0    | 0           | 1658 | 0    | 0          | 0    | 0    | 219        | 0    | 504  |
| Reduct Vol:                             | 0           | 0    | 0    | 0           | 0    | 0    | 0          | 0    | 0    | 0          | 0    | 0    |
| Reduced Vol:                            | 0           | 1213 | 0    | 0           | 1658 | 0    | 0          | 0    | 0    | 219        | 0    | 504  |
| PCE Adj:                                | 1.00        | 1.00 | 0.00 | 1.00        | 1.00 | 0.00 | 1.00       | 1.00 | 1.00 | 1.00       | 1.00 | 1.00 |
| MLF Adj:                                | 1.00        | 1.00 | 0.00 | 1.00        | 1.00 | 0.00 | 1.00       | 1.00 | 1.00 | 1.00       | 1.00 | 1.00 |
| Final Volume:                           | 0           | 1213 | 0    | 0           | 1658 | 0    | 0          | 0    | 0    | 219        | 0    | 504  |
| Saturation Flow Module:                 |             |      |      |             |      |      |            |      |      |            |      |      |
| Sat/Lane:                               | 1900        | 1900 | 1900 | 1900        | 1900 | 1900 | 1900       | 1900 | 1900 | 1900       | 1900 | 1900 |
| Adjustment:                             | 0.92        | 1.00 | 0.92 | 0.92        | 1.00 | 0.92 | 0.92       | 1.00 | 0.92 | 0.83       | 1.00 | 0.92 |
| Lanes:                                  | 0.00        | 2.00 | 1.00 | 0.00        | 2.00 | 1.00 | 0.00       | 0.00 | 0.00 | 2.00       | 0.00 | 1.00 |
| Final Sat.:                             | 0           | 3800 | 1750 | 0           | 3800 | 1750 | 0          | 0    | 0    | 3150       | 0    | 1750 |
| Capacity Analysis Module:               |             |      |      |             |      |      |            |      |      |            |      |      |
| Vol/Sat:                                | 0.00        | 0.32 | 0.00 | 0.00        | 0.44 | 0.00 | 0.00       | 0.00 | 0.00 | 0.07       | 0.00 | 0.29 |
| Crit Moves:                             | ****        |      |      | ****        |      |      |            |      |      |            | **** |      |
| Green Time:                             | 0.0         | 80.7 | 0.0  | 0.0         | 80.7 | 0.0  | 0.0        | 0.0  | 0.0  | 53.3       | 0.0  | 53.3 |
| Volume/Cap:                             | 0.00        | 0.55 | 0.00 | 0.00        | 0.76 | 0.00 | 0.00       | 0.00 | 0.00 | 0.18       | 0.00 | 0.76 |
| Delay/Veh:                              | 0.0         | 18.7 | 0.0  | 0.0         | 23.8 | 0.0  | 0.0        | 0.0  | 0.0  | 28.9       | 0.0  | 42.7 |
| User DelAdj:                            | 1.00        | 1.00 | 1.00 | 1.00        | 1.00 | 1.00 | 1.00       | 1.00 | 1.00 | 1.00       | 1.00 | 1.00 |
| AdjDel/Veh:                             | 0.0         | 18.7 | 0.0  | 0.0         | 23.8 | 0.0  | 0.0        | 0.0  | 0.0  | 28.9       | 0.0  | 42.7 |
| LOS by Move:                            | A           | B    | A    | A           | C    | A    | A          | A    | A    | C          | A    | D    |
| HCM2k95thQ:                             | 0           | 28   | 0    | 0           | 42   | 0    | 0          | 0    | 0    | 7          | 0    | 36   |

Note: Queue reported is the number of cars per lane.

BART

Level Of Service Computation Report  
 2000 HCM Operations (Future Volume Alternative)  
 AM - Cumulative No Project

Intersection #3047: The Alameda/880 NB Ramps [Study Int 57]

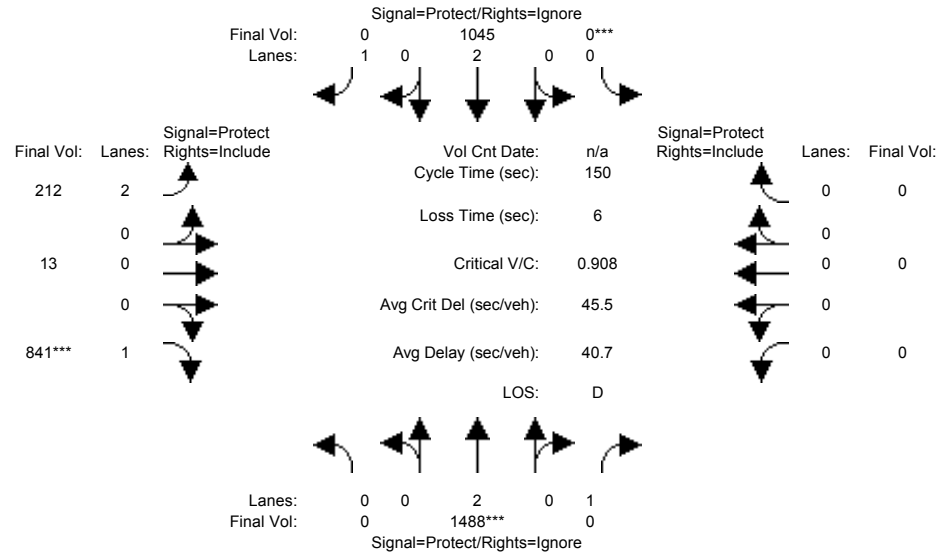

| Approach:                 | North Bound |      |      | South Bound |      |      | East Bound |      |      | West Bound |      |      |
|---------------------------|-------------|------|------|-------------|------|------|------------|------|------|------------|------|------|
| Movement:                 | L           | T    | R    | L           | T    | R    | L          | T    | R    | L          | T    | R    |
| Min. Green:               | 0           | 10   | 10   | 0           | 10   | 10   | 10         | 0    | 10   | 0          | 0    | 0    |
| Y+R:                      | 4.0         | 4.0  | 4.0  | 4.0         | 4.0  | 4.0  | 4.0        | 4.0  | 4.0  | 4.0        | 4.0  | 4.0  |
| Volume Module:            |             |      |      |             |      |      |            |      |      |            |      |      |
| Base Vol:                 | 0           | 1488 | 469  | 0           | 1045 | 269  | 212        | 13   | 841  | 0          | 0    | 0    |
| Growth Adj:               | 1.00        | 1.00 | 1.00 | 1.00        | 1.00 | 1.00 | 1.00       | 1.00 | 1.00 | 1.00       | 1.00 | 1.00 |
| Initial Bse:              | 0           | 1488 | 469  | 0           | 1045 | 269  | 212        | 13   | 841  | 0          | 0    | 0    |
| Added Vol:                | 0           | 0    | 0    | 0           | 0    | 0    | 0          | 0    | 0    | 0          | 0    | 0    |
| PasserByVol:              | 0           | 0    | 0    | 0           | 0    | 0    | 0          | 0    | 0    | 0          | 0    | 0    |
| Initial Fut:              | 0           | 1488 | 469  | 0           | 1045 | 269  | 212        | 13   | 841  | 0          | 0    | 0    |
| User Adj:                 | 1.00        | 1.00 | 0.00 | 1.00        | 1.00 | 0.00 | 1.00       | 1.00 | 1.00 | 1.00       | 1.00 | 1.00 |
| PHF Adj:                  | 1.00        | 1.00 | 0.00 | 1.00        | 1.00 | 0.00 | 1.00       | 1.00 | 1.00 | 1.00       | 1.00 | 1.00 |
| PHF Volume:               | 0           | 1488 | 0    | 0           | 1045 | 0    | 212        | 13   | 841  | 0          | 0    | 0    |
| Reduct Vol:               | 0           | 0    | 0    | 0           | 0    | 0    | 0          | 0    | 0    | 0          | 0    | 0    |
| Reduced Vol:              | 0           | 1488 | 0    | 0           | 1045 | 0    | 212        | 13   | 841  | 0          | 0    | 0    |
| PCE Adj:                  | 1.00        | 1.00 | 0.00 | 1.00        | 1.00 | 0.00 | 1.00       | 1.00 | 1.00 | 1.00       | 1.00 | 1.00 |
| MLF Adj:                  | 1.00        | 1.00 | 0.00 | 1.00        | 1.00 | 0.00 | 1.00       | 1.00 | 1.00 | 1.00       | 1.00 | 1.00 |
| FinalVolume:              | 0           | 1488 | 0    | 0           | 1045 | 0    | 212        | 13   | 841  | 0          | 0    | 0    |
| Saturation Flow Module:   |             |      |      |             |      |      |            |      |      |            |      |      |
| Sat/Lane:                 | 1900        | 1900 | 1900 | 1900        | 1900 | 1900 | 1900       | 1900 | 1900 | 1900       | 1900 | 1900 |
| Adjustment:               | 0.92        | 1.00 | 0.92 | 0.92        | 1.00 | 0.92 | 0.92       | 1.00 | 0.92 | 0.92       | 1.00 | 0.92 |
| Lanes:                    | 0.00        | 2.00 | 1.00 | 0.00        | 2.00 | 1.00 | 1.89       | 0.11 | 1.00 | 0.00       | 0.00 | 0.00 |
| Final Sat.:               | 0           | 3800 | 1750 | 0           | 3800 | 1750 | 3313       | 203  | 1750 | 0          | 0    | 0    |
| Capacity Analysis Module: |             |      |      |             |      |      |            |      |      |            |      |      |
| Vol/Sat:                  | 0.00        | 0.39 | 0.00 | 0.00        | 0.28 | 0.00 | 0.06       | 0.06 | 0.48 | 0.00       | 0.00 | 0.00 |
| Crit Moves:               | ****        | **** | **** | ****        | **** | **** | ****       | **** | **** | ****       | **** | **** |
| Green Time:               | 0.0         | 64.7 | 0.0  | 0.0         | 64.7 | 0.0  | 79.3       | 79.3 | 79.3 | 0.0        | 0.0  | 0.0  |
| Volume/Cap:               | 0.00        | 0.91 | 0.00 | 0.00        | 0.64 | 0.00 | 0.12       | 0.12 | 0.91 | 0.00       | 0.00 | 0.00 |
| Delay/Veh:                | 0.0         | 47.7 | 0.0  | 0.0         | 34.3 | 0.0  | 17.8       | 17.8 | 42.4 | 0.0        | 0.0  | 0.0  |
| User DelAdj:              | 1.00        | 1.00 | 1.00 | 1.00        | 1.00 | 1.00 | 1.00       | 1.00 | 1.00 | 1.00       | 1.00 | 1.00 |
| AdjDel/Veh:               | 0.0         | 47.7 | 0.0  | 0.0         | 34.3 | 0.0  | 17.8       | 17.8 | 42.4 | 0.0        | 0.0  | 0.0  |
| LOS by Move:              | A           | D    | A    | A           | C    | A    | B          | B    | D    | A          | A    | A    |
| HCM2k95thQ:               | 0           | 48   | 0    | 0           | 32   | 0    | 5          | 5    | 64   | 0          | 0    | 0    |

Note: Queue reported is the number of cars per lane.



BART

Level Of Service Computation Report  
 2000 HCM Operations (Future Volume Alternative)  
 PM - Cumulative No Project

Intersection #3047: The Alameda/880 NB Ramps [Study Int 57]

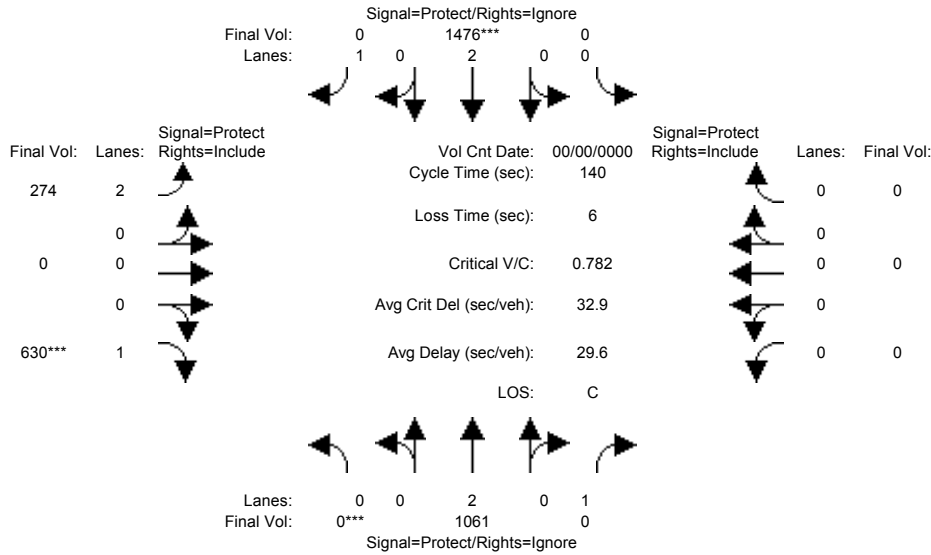

| Approach:                               | North Bound |      |      | South Bound |      |      | East Bound |      |      | West Bound |      |      |
|---|-------------|------|------|-------------|------|------|------------|------|------|------------|------|------|
| Movement:                               | L           | T    | R    | L           | T    | R    | L          | T    | R    | L          | T    | R    |
| Min. Green:                             | 0           | 10   | 10   | 0           | 10   | 10   | 10         | 0    | 10   | 0          | 0    | 0    |
| Y+R:                                    | 4.0         | 4.0  | 4.0  | 4.0         | 4.0  | 4.0  | 4.0        | 4.0  | 4.0  | 4.0        | 4.0  | 4.0  |
| Volume Module: >> Count Date: 0 0 << AM |             |      |      |             |      |      |            |      |      |            |      |      |
| Base Vol:                               | 0           | 1061 | 225  | 0           | 1476 | 466  | 274        | 0    | 630  | 0          | 0    | 0    |
| Growth Adj:                             | 1.00        | 1.00 | 1.00 | 1.00        | 1.00 | 1.00 | 1.00       | 1.00 | 1.00 | 1.00       | 1.00 | 1.00 |
| Initial Bse:                            | 0           | 1061 | 225  | 0           | 1476 | 466  | 274        | 0    | 630  | 0          | 0    | 0    |
| Added Vol:                              | 0           | 0    | 0    | 0           | 0    | 0    | 0          | 0    | 0    | 0          | 0    | 0    |
| PasserByVol:                            | 0           | 0    | 0    | 0           | 0    | 0    | 0          | 0    | 0    | 0          | 0    | 0    |
| Initial Fut:                            | 0           | 1061 | 225  | 0           | 1476 | 466  | 274        | 0    | 630  | 0          | 0    | 0    |
| User Adj:                               | 1.00        | 1.00 | 0.00 | 1.00        | 1.00 | 0.00 | 1.00       | 1.00 | 1.00 | 1.00       | 1.00 | 1.00 |
| PHF Adj:                                | 1.00        | 1.00 | 0.00 | 1.00        | 1.00 | 0.00 | 1.00       | 1.00 | 1.00 | 1.00       | 1.00 | 1.00 |
| PHF Volume:                             | 0           | 1061 | 0    | 0           | 1476 | 0    | 274        | 0    | 630  | 0          | 0    | 0    |
| Reduct Vol:                             | 0           | 0    | 0    | 0           | 0    | 0    | 0          | 0    | 0    | 0          | 0    | 0    |
| Reduced Vol:                            | 0           | 1061 | 0    | 0           | 1476 | 0    | 274        | 0    | 630  | 0          | 0    | 0    |
| PCE Adj:                                | 1.00        | 1.00 | 0.00 | 1.00        | 1.00 | 0.00 | 1.00       | 1.00 | 1.00 | 1.00       | 1.00 | 1.00 |
| MLF Adj:                                | 1.00        | 1.00 | 0.00 | 1.00        | 1.00 | 0.00 | 1.00       | 1.00 | 1.00 | 1.00       | 1.00 | 1.00 |
| FinalVolume:                            | 0           | 1061 | 0    | 0           | 1476 | 0    | 274        | 0    | 630  | 0          | 0    | 0    |
| Saturation Flow Module:                 |             |      |      |             |      |      |            |      |      |            |      |      |
| Sat/Lane:                               | 1900        | 1900 | 1900 | 1900        | 1900 | 1900 | 1900       | 1900 | 1900 | 1900       | 1900 | 1900 |
| Adjustment:                             | 0.92        | 1.00 | 0.92 | 0.92        | 1.00 | 0.92 | 0.83       | 1.00 | 0.92 | 0.92       | 1.00 | 0.92 |
| Lanes:                                  | 0.00        | 2.00 | 1.00 | 0.00        | 2.00 | 1.00 | 2.00       | 0.00 | 1.00 | 0.00       | 0.00 | 0.00 |
| Final Sat.:                             | 0           | 3800 | 1750 | 0           | 3800 | 1750 | 3150       | 0    | 1750 | 0          | 0    | 0    |
| Capacity Analysis Module:               |             |      |      |             |      |      |            |      |      |            |      |      |
| Vol/Sat:                                | 0.00        | 0.28 | 0.00 | 0.00        | 0.39 | 0.00 | 0.09       | 0.00 | 0.36 | 0.00       | 0.00 | 0.00 |
| Crit Moves:                             | ****        |      |      | ****        |      |      | ****       |      |      | ****       |      |      |
| Green Time:                             | 0.0         | 69.5 | 0.0  | 0.0         | 69.5 | 0.0  | 64.5       | 0.0  | 64.5 | 0.0        | 0.0  | 0.0  |
| Volume/Cap:                             | 0.00        | 0.56 | 0.00 | 0.00        | 0.78 | 0.00 | 0.19       | 0.00 | 0.78 | 0.00       | 0.00 | 0.00 |
| Delay/Veh:                              | 0.0         | 25.0 | 0.0  | 0.0         | 31.2 | 0.0  | 22.4       | 0.0  | 36.8 | 0.0        | 0.0  | 0.0  |
| User DelAdj:                            | 1.00        | 1.00 | 1.00 | 1.00        | 1.00 | 1.00 | 1.00       | 1.00 | 1.00 | 1.00       | 1.00 | 1.00 |
| AdjDel/Veh:                             | 0.0         | 25.0 | 0.0  | 0.0         | 31.2 | 0.0  | 22.4       | 0.0  | 36.8 | 0.0        | 0.0  | 0.0  |
| LOS by Move:                            | A           | C    | A    | A           | C    | A    | C          | A    | D    | A          | A    | A    |
| HCM2k95thQ:                             | 0           | 26   | 0    | 0           | 44   | 0    | 8          | 0    | 42   | 0          | 0    | 0    |

Note: Queue reported is the number of cars per lane.

BART

Level Of Service Computation Report  
 2000 HCM Operations (Future Volume Alternative)  
 AM - Cumulative With Project

Intersection #3047: The Alameda/880 NB Ramps [Study Int 57]

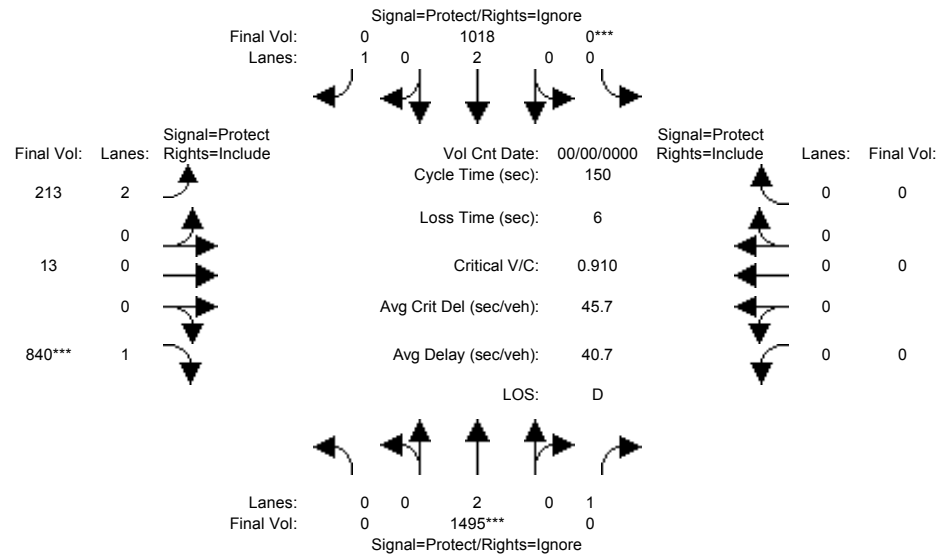

| Approach:                     | North Bound |      |      | South Bound |      |      | East Bound |      |      | West Bound |      |      |
|-------------------------------|-------------|------|------|-------------|------|------|------------|------|------|------------|------|------|
| Movement:                     | L           | T    | R    | L           | T    | R    | L          | T    | R    | L          | T    | R    |
| Min. Green:                   | 0           | 10   | 10   | 0           | 10   | 10   | 10         | 0    | 10   | 0          | 0    | 0    |
| Y+R:                          | 4.0         | 4.0  | 4.0  | 4.0         | 4.0  | 4.0  | 4.0        | 4.0  | 4.0  | 4.0        | 4.0  | 4.0  |
| Volume Module: >> Count Date: | 0 0 << AM   |      |      |             |      |      |            |      |      |            |      |      |
| Base Vol:                     | 0           | 1495 | 469  | 0           | 1018 | 269  | 213        | 13   | 840  | 0          | 0    | 0    |
| Growth Adj:                   | 1.00        | 1.00 | 1.00 | 1.00        | 1.00 | 1.00 | 1.00       | 1.00 | 1.00 | 1.00       | 1.00 | 1.00 |
| Initial Bse:                  | 0           | 1495 | 469  | 0           | 1018 | 269  | 213        | 13   | 840  | 0          | 0    | 0    |
| Added Vol:                    | 0           | 0    | 0    | 0           | 0    | 0    | 0          | 0    | 0    | 0          | 0    | 0    |
| PasserByVol:                  | 0           | 0    | 0    | 0           | 0    | 0    | 0          | 0    | 0    | 0          | 0    | 0    |
| Initial Fut:                  | 0           | 1495 | 469  | 0           | 1018 | 269  | 213        | 13   | 840  | 0          | 0    | 0    |
| User Adj:                     | 1.00        | 1.00 | 0.00 | 1.00        | 1.00 | 0.00 | 1.00       | 1.00 | 1.00 | 1.00       | 1.00 | 1.00 |
| PHF Adj:                      | 1.00        | 1.00 | 0.00 | 1.00        | 1.00 | 0.00 | 1.00       | 1.00 | 1.00 | 1.00       | 1.00 | 1.00 |
| PHF Volume:                   | 0           | 1495 | 0    | 0           | 1018 | 0    | 213        | 13   | 840  | 0          | 0    | 0    |
| Reduct Vol:                   | 0           | 0    | 0    | 0           | 0    | 0    | 0          | 0    | 0    | 0          | 0    | 0    |
| Reduced Vol:                  | 0           | 1495 | 0    | 0           | 1018 | 0    | 213        | 13   | 840  | 0          | 0    | 0    |
| PCE Adj:                      | 1.00        | 1.00 | 0.00 | 1.00        | 1.00 | 0.00 | 1.00       | 1.00 | 1.00 | 1.00       | 1.00 | 1.00 |
| MLF Adj:                      | 1.00        | 1.00 | 0.00 | 1.00        | 1.00 | 0.00 | 1.00       | 1.00 | 1.00 | 1.00       | 1.00 | 1.00 |
| Final Volume:                 | 0           | 1495 | 0    | 0           | 1018 | 0    | 213        | 13   | 840  | 0          | 0    | 0    |
| Saturation Flow Module:       |             |      |      |             |      |      |            |      |      |            |      |      |
| Sat/Lane:                     | 1900        | 1900 | 1900 | 1900        | 1900 | 1900 | 1900       | 1900 | 1900 | 1900       | 1900 | 1900 |
| Adjustment:                   | 0.92        | 1.00 | 0.92 | 0.92        | 1.00 | 0.92 | 0.92       | 1.00 | 0.92 | 0.92       | 1.00 | 0.92 |
| Lanes:                        | 0.00        | 2.00 | 1.00 | 0.00        | 2.00 | 1.00 | 1.89       | 0.11 | 1.00 | 0.00       | 0.00 | 0.00 |
| Final Sat.:                   | 0           | 3800 | 1750 | 0           | 3800 | 1750 | 3314       | 202  | 1750 | 0          | 0    | 0    |
| Capacity Analysis Module:     |             |      |      |             |      |      |            |      |      |            |      |      |
| Vol/Sat:                      | 0.00        | 0.39 | 0.00 | 0.00        | 0.27 | 0.00 | 0.06       | 0.06 | 0.48 | 0.00       | 0.00 | 0.00 |
| Crit Moves:                   | ****        |      |      |             |      |      |            |      |      |            |      |      |
| Green Time:                   | 0.0         | 64.9 | 0.0  | 0.0         | 64.9 | 0.0  | 79.1       | 79.1 | 79.1 | 0.0        | 0.0  | 0.0  |
| Volume/Cap:                   | 0.00        | 0.91 | 0.00 | 0.00        | 0.62 | 0.00 | 0.12       | 0.12 | 0.91 | 0.00       | 0.00 | 0.00 |
| Delay/Veh:                    | 0.0         | 47.7 | 0.0  | 0.0         | 33.7 | 0.0  | 17.9       | 17.9 | 42.7 | 0.0        | 0.0  | 0.0  |
| User DelAdj:                  | 1.00        | 1.00 | 1.00 | 1.00        | 1.00 | 1.00 | 1.00       | 1.00 | 1.00 | 1.00       | 1.00 | 1.00 |
| AdjDel/Veh:                   | 0.0         | 47.7 | 0.0  | 0.0         | 33.7 | 0.0  | 17.9       | 17.9 | 42.7 | 0.0        | 0.0  | 0.0  |
| LOS by Move:                  | A           | D    | A    | A           | C    | A    | B          | B    | D    | A          | A    | A    |
| HCM2k95thQ:                   | 0           | 48   | 0    | 0           | 31   | 0    | 5          | 5    | 64   | 0          | 0    | 0    |

Note: Queue reported is the number of cars per lane.

BART

Level Of Service Computation Report  
 2000 HCM Operations (Future Volume Alternative)  
 PM - Cumulative With Project

Intersection #3047: The Alameda/880 NB Ramps [Study Int 57]

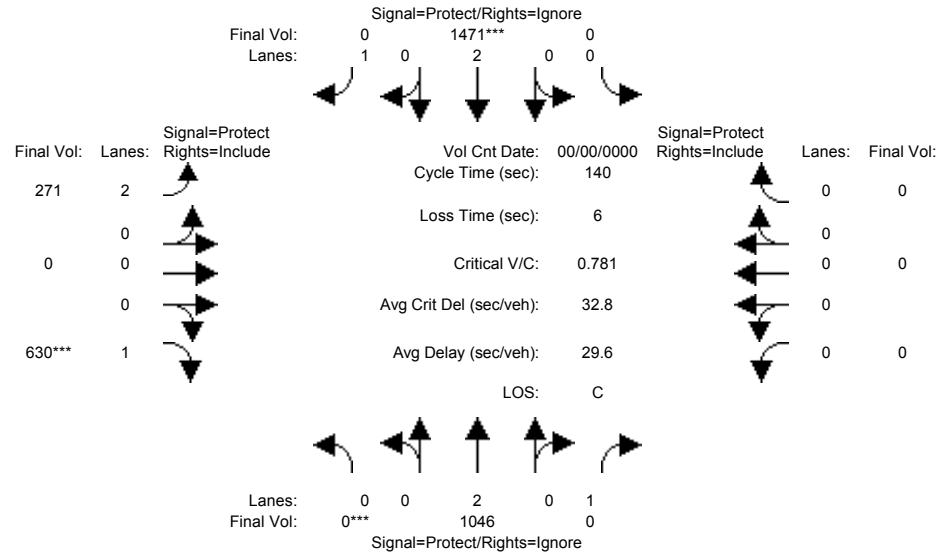

| Approach:                               | North Bound |      |      | South Bound |      |      | East Bound |      |      | West Bound |      |      |
|---|-------------|------|------|-------------|------|------|------------|------|------|------------|------|------|
| Movement:                               | L           | T    | R    | L           | T    | R    | L          | T    | R    | L          | T    | R    |
| Min. Green:                             | 0           | 10   | 10   | 0           | 10   | 10   | 10         | 0    | 10   | 0          | 0    | 0    |
| Y+R:                                    | 4.0         | 4.0  | 4.0  | 4.0         | 4.0  | 4.0  | 4.0        | 4.0  | 4.0  | 4.0        | 4.0  | 4.0  |
| Volume Module: >> Count Date: 0 0 << AM |             |      |      |             |      |      |            |      |      |            |      |      |
| Base Vol:                               | 0           | 1046 | 225  | 0           | 1471 | 466  | 271        | 0    | 630  | 0          | 0    | 0    |
| Growth Adj:                             | 1.00        | 1.00 | 1.00 | 1.00        | 1.00 | 1.00 | 1.00       | 1.00 | 1.00 | 1.00       | 1.00 | 1.00 |
| Initial Bse:                            | 0           | 1046 | 225  | 0           | 1471 | 466  | 271        | 0    | 630  | 0          | 0    | 0    |
| Added Vol:                              | 0           | 0    | 0    | 0           | 0    | 0    | 0          | 0    | 0    | 0          | 0    | 0    |
| PasserByVol:                            | 0           | 0    | 0    | 0           | 0    | 0    | 0          | 0    | 0    | 0          | 0    | 0    |
| Initial Fut:                            | 0           | 1046 | 225  | 0           | 1471 | 466  | 271        | 0    | 630  | 0          | 0    | 0    |
| User Adj:                               | 1.00        | 1.00 | 0.00 | 1.00        | 1.00 | 0.00 | 1.00       | 1.00 | 1.00 | 1.00       | 1.00 | 1.00 |
| PHF Adj:                                | 1.00        | 1.00 | 0.00 | 1.00        | 1.00 | 0.00 | 1.00       | 1.00 | 1.00 | 1.00       | 1.00 | 1.00 |
| PHF Volume:                             | 0           | 1046 | 0    | 0           | 1471 | 0    | 271        | 0    | 630  | 0          | 0    | 0    |
| Reduct Vol:                             | 0           | 0    | 0    | 0           | 0    | 0    | 0          | 0    | 0    | 0          | 0    | 0    |
| Reduced Vol:                            | 0           | 1046 | 0    | 0           | 1471 | 0    | 271        | 0    | 630  | 0          | 0    | 0    |
| PCE Adj:                                | 1.00        | 1.00 | 0.00 | 1.00        | 1.00 | 0.00 | 1.00       | 1.00 | 1.00 | 1.00       | 1.00 | 1.00 |
| MLF Adj:                                | 1.00        | 1.00 | 0.00 | 1.00        | 1.00 | 0.00 | 1.00       | 1.00 | 1.00 | 1.00       | 1.00 | 1.00 |
| Final Volume:                           | 0           | 1046 | 0    | 0           | 1471 | 0    | 271        | 0    | 630  | 0          | 0    | 0    |
| Saturation Flow Module:                 |             |      |      |             |      |      |            |      |      |            |      |      |
| Sat/Lane:                               | 1900        | 1900 | 1900 | 1900        | 1900 | 1900 | 1900       | 1900 | 1900 | 1900       | 1900 | 1900 |
| Adjustment:                             | 0.92        | 1.00 | 0.92 | 0.92        | 1.00 | 0.92 | 0.83       | 1.00 | 0.92 | 0.92       | 1.00 | 0.92 |
| Lanes:                                  | 0.00        | 2.00 | 1.00 | 0.00        | 2.00 | 1.00 | 2.00       | 0.00 | 1.00 | 0.00       | 0.00 | 0.00 |
| Final Sat.:                             | 0           | 3800 | 1750 | 0           | 3800 | 1750 | 3150       | 0    | 1750 | 0          | 0    | 0    |
| Capacity Analysis Module:               |             |      |      |             |      |      |            |      |      |            |      |      |
| Vol/Sat:                                | 0.00        | 0.28 | 0.00 | 0.00        | 0.39 | 0.00 | 0.09       | 0.00 | 0.36 | 0.00       | 0.00 | 0.00 |
| Crit Moves:                             | ****        |      |      | ****        |      |      | ****       |      |      | ****       |      |      |
| Green Time:                             | 0.0         | 69.4 | 0.0  | 0.0         | 69.4 | 0.0  | 64.6       | 0.0  | 64.6 | 0.0        | 0.0  | 0.0  |
| Volume/Cap:                             | 0.00        | 0.56 | 0.00 | 0.00        | 0.78 | 0.00 | 0.19       | 0.00 | 0.78 | 0.00       | 0.00 | 0.00 |
| Delay/Veh:                              | 0.0         | 24.9 | 0.0  | 0.0         | 31.2 | 0.0  | 22.3       | 0.0  | 36.7 | 0.0        | 0.0  | 0.0  |
| User DelAdj:                            | 1.00        | 1.00 | 1.00 | 1.00        | 1.00 | 1.00 | 1.00       | 1.00 | 1.00 | 1.00       | 1.00 | 1.00 |
| AdjDel/Veh:                             | 0.0         | 24.9 | 0.0  | 0.0         | 31.2 | 0.0  | 22.3       | 0.0  | 36.7 | 0.0        | 0.0  | 0.0  |
| LOS by Move:                            | A           | C    | A    | A           | C    | A    | C          | A    | D    | A          | A    | A    |
| HCM2k95thQ:                             | 0           | 25   | 0    | 0           | 44   | 0    | 8          | 0    | 42   | 0          | 0    | 0    |

Note: Queue reported is the number of cars per lane.

BART

Level Of Service Computation Report  
2000 HCM Operations (Future Volume Alternative)  
AM - Cumulative No Project

Intersection #3052: 880 SB Ramps/Coleman [Study Int 36]

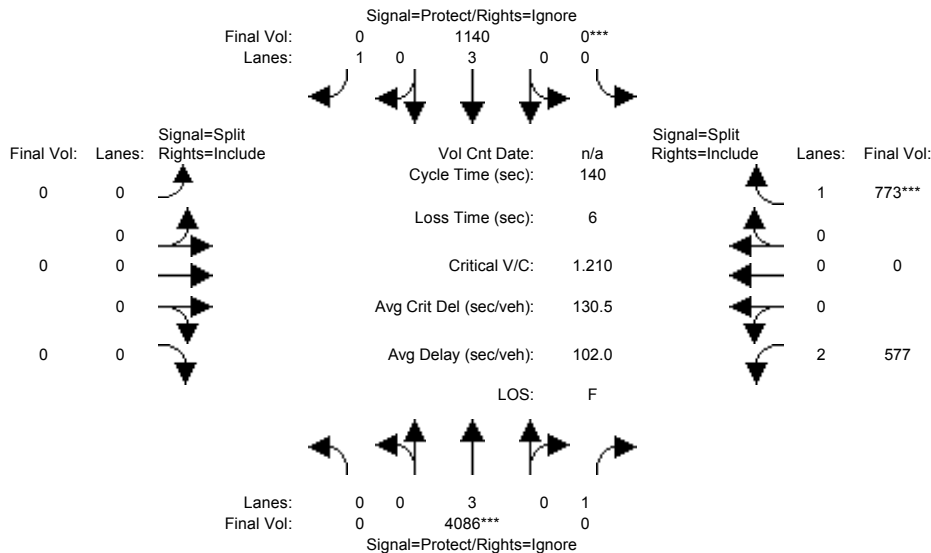

| Approach:                 | North Bound |      |      | South Bound |      |      | East Bound |      |      | West Bound |      |       |
|---------------------------|-------------|------|------|-------------|------|------|------------|------|------|------------|------|-------|
| Movement:                 | L           | T    | R    | L           | T    | R    | L          | T    | R    | L          | T    | R     |
| Min. Green:               | 0           | 10   | 10   | 0           | 10   | 10   | 0          | 0    | 0    | 10         | 0    | 10    |
| Y+R:                      | 4.0         | 4.0  | 4.0  | 4.0         | 4.0  | 4.0  | 4.0        | 4.0  | 4.0  | 4.0        | 4.0  | 4.0   |
| Volume Module:            |             |      |      |             |      |      |            |      |      |            |      |       |
| Base Vol:                 | 0           | 4086 | 179  | 0           | 1140 | 193  | 0          | 0    | 0    | 577        | 0    | 773   |
| Growth Adj:               | 1.00        | 1.00 | 1.00 | 1.00        | 1.00 | 1.00 | 1.00       | 1.00 | 1.00 | 1.00       | 1.00 | 1.00  |
| Initial Bse:              | 0           | 4086 | 179  | 0           | 1140 | 193  | 0          | 0    | 0    | 577        | 0    | 773   |
| Added Vol:                | 0           | 0    | 0    | 0           | 0    | 0    | 0          | 0    | 0    | 0          | 0    | 0     |
| PasserByVol:              | 0           | 0    | 0    | 0           | 0    | 0    | 0          | 0    | 0    | 0          | 0    | 0     |
| Initial Fut:              | 0           | 4086 | 179  | 0           | 1140 | 193  | 0          | 0    | 0    | 577        | 0    | 773   |
| User Adj:                 | 1.00        | 1.00 | 0.00 | 1.00        | 1.00 | 0.00 | 1.00       | 1.00 | 1.00 | 1.00       | 1.00 | 1.00  |
| PHF Adj:                  | 1.00        | 1.00 | 0.00 | 1.00        | 1.00 | 0.00 | 1.00       | 1.00 | 1.00 | 1.00       | 1.00 | 1.00  |
| PHF Volume:               | 0           | 4086 | 0    | 0           | 1140 | 0    | 0          | 0    | 0    | 577        | 0    | 773   |
| Reduct Vol:               | 0           | 0    | 0    | 0           | 0    | 0    | 0          | 0    | 0    | 0          | 0    | 0     |
| Reduced Vol:              | 0           | 4086 | 0    | 0           | 1140 | 0    | 0          | 0    | 0    | 577        | 0    | 773   |
| PCE Adj:                  | 1.00        | 1.00 | 0.00 | 1.00        | 1.00 | 0.00 | 1.00       | 1.00 | 1.00 | 1.00       | 1.00 | 1.00  |
| MLF Adj:                  | 1.00        | 1.00 | 0.00 | 1.00        | 1.00 | 0.00 | 1.00       | 1.00 | 1.00 | 1.00       | 1.00 | 1.00  |
| Final Volume:             | 0           | 4086 | 0    | 0           | 1140 | 0    | 0          | 0    | 0    | 577        | 0    | 773   |
| Saturation Flow Module:   |             |      |      |             |      |      |            |      |      |            |      |       |
| Sat/Lane:                 | 1900        | 1900 | 1900 | 1900        | 1900 | 1900 | 1900       | 1900 | 1900 | 1900       | 1900 | 1900  |
| Adjustment:               | 0.92        | 1.00 | 0.92 | 0.92        | 1.00 | 0.92 | 0.92       | 1.00 | 0.92 | 0.83       | 1.00 | 0.92  |
| Lanes:                    | 0.00        | 3.00 | 1.00 | 0.00        | 3.00 | 1.00 | 0.00       | 0.00 | 0.00 | 2.00       | 0.00 | 1.00  |
| Final Sat.:               | 0           | 5700 | 1750 | 0           | 5700 | 1750 | 0          | 0    | 0    | 3150       | 0    | 1750  |
| Capacity Analysis Module: |             |      |      |             |      |      |            |      |      |            |      |       |
| Vol/Sat:                  | 0.00        | 0.72 | 0.00 | 0.00        | 0.20 | 0.00 | 0.00       | 0.00 | 0.00 | 0.18       | 0.00 | 0.44  |
| Crit Moves:               | ****        | **** | **** | ****        | **** | **** | ****       | **** | **** | ****       | **** | ****  |
| Green Time:               | 0.0         | 82.9 | 0.0  | 0.0         | 82.9 | 0.0  | 0.0        | 0.0  | 0.0  | 51.1       | 0.0  | 51.1  |
| Volume/Cap:               | 0.00        | 1.21 | 0.00 | 0.00        | 0.34 | 0.00 | 0.00       | 0.00 | 0.00 | 0.50       | 0.00 | 1.21  |
| Delay/Veh:                | 0.0         | 126  | 0.0  | 0.0         | 14.6 | 0.0  | 0.0        | 0.0  | 0.0  | 34.9       | 0.0  | 153.3 |
| User DelAdj:              | 1.00        | 1.00 | 1.00 | 1.00        | 1.00 | 1.00 | 1.00       | 1.00 | 1.00 | 1.00       | 1.00 | 1.00  |
| AdjDel/Veh:               | 0.0         | 126  | 0.0  | 0.0         | 14.6 | 0.0  | 0.0        | 0.0  | 0.0  | 34.9       | 0.0  | 153.3 |
| LOS by Move:              | A           | F    | A    | A           | B    | A    | A          | A    | A    | C          | A    | F     |
| HCM2k95thQ:               | 0           | 132  | 0    | 0           | 15   | 0    | 0          | 0    | 0    | 21         | 0    | 85    |

Note: Queue reported is the number of cars per lane.

BART

Level Of Service Computation Report  
 2000 HCM Operations (Future Volume Alternative)  
 PM - Cumulative No Project

Intersection #3052: 880 SB Ramps/Coleman [Study Int 36]

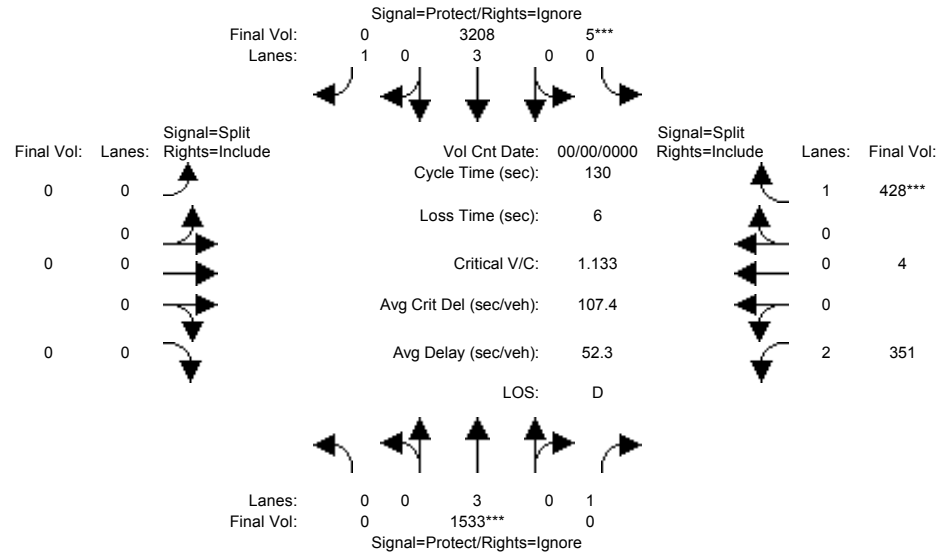

| Approach:                     | North Bound        |      |      | South Bound |      |      | East Bound |      |      | West Bound |      |       |
|-------------------------------|--------------------|------|------|-------------|------|------|------------|------|------|------------|------|-------|
| Movement:                     | L                  | T    | R    | L           | T    | R    | L          | T    | R    | L          | T    | R     |
| Min. Green:                   | 0                  | 10   | 10   | 0           | 10   | 10   | 0          | 0    | 0    | 10         | 0    | 10    |
| Y+R:                          | 4.0                | 4.0  | 4.0  | 4.0         | 4.0  | 4.0  | 4.0        | 4.0  | 4.0  | 4.0        | 4.0  | 4.0   |
| Volume Module: >> Count Date: | 0 0 << 7:30-8:30AM |      |      |             |      |      |            |      |      |            |      |       |
| Base Vol:                     | 0                  | 1533 | 301  | 5           | 3208 | 773  | 0          | 0    | 0    | 351        | 4    | 428   |
| Growth Adj:                   | 1.00               | 1.00 | 1.00 | 1.00        | 1.00 | 1.00 | 1.00       | 1.00 | 1.00 | 1.00       | 1.00 | 1.00  |
| Initial Bse:                  | 0                  | 1533 | 301  | 5           | 3208 | 773  | 0          | 0    | 0    | 351        | 4    | 428   |
| Added Vol:                    | 0                  | 0    | 0    | 0           | 0    | 0    | 0          | 0    | 0    | 0          | 0    | 0     |
| PasserByVol:                  | 0                  | 0    | 0    | 0           | 0    | 0    | 0          | 0    | 0    | 0          | 0    | 0     |
| Initial Fut:                  | 0                  | 1533 | 301  | 5           | 3208 | 773  | 0          | 0    | 0    | 351        | 4    | 428   |
| User Adj:                     | 1.00               | 1.00 | 0.00 | 1.00        | 1.00 | 0.00 | 1.00       | 1.00 | 1.00 | 1.00       | 1.00 | 1.00  |
| PHF Adj:                      | 1.00               | 1.00 | 0.00 | 1.00        | 1.00 | 0.00 | 1.00       | 1.00 | 1.00 | 1.00       | 1.00 | 1.00  |
| PHF Volume:                   | 0                  | 1533 | 0    | 5           | 3208 | 0    | 0          | 0    | 0    | 351        | 4    | 428   |
| Reduct Vol:                   | 0                  | 0    | 0    | 0           | 0    | 0    | 0          | 0    | 0    | 0          | 0    | 0     |
| Reduced Vol:                  | 0                  | 1533 | 0    | 5           | 3208 | 0    | 0          | 0    | 0    | 351        | 4    | 428   |
| PCE Adj:                      | 1.00               | 1.00 | 0.00 | 1.00        | 1.00 | 0.00 | 1.00       | 1.00 | 1.00 | 1.00       | 1.00 | 1.00  |
| MLF Adj:                      | 1.00               | 1.00 | 0.00 | 1.00        | 1.00 | 0.00 | 1.00       | 1.00 | 1.00 | 1.00       | 1.00 | 1.00  |
| Final Volume:                 | 0                  | 1533 | 0    | 5           | 3208 | 0    | 0          | 0    | 0    | 351        | 4    | 428   |
| Saturation Flow Module:       |                    |      |      |             |      |      |            |      |      |            |      |       |
| Sat/Lane:                     | 1900               | 1900 | 1900 | 1900        | 1900 | 1900 | 1900       | 1900 | 1900 | 1900       | 1900 | 1900  |
| Adjustment:                   | 0.92               | 1.00 | 0.92 | 0.95        | 0.98 | 0.92 | 0.92       | 1.00 | 0.92 | 0.93       | 0.95 | 0.95  |
| Lanes:                        | 0.00               | 3.00 | 1.00 | 0.01        | 2.99 | 1.00 | 0.00       | 0.00 | 0.00 | 1.98       | 0.02 | 1.00  |
| Final Sat.:                   | 0                  | 5700 | 1750 | 9           | 5591 | 1750 | 0          | 0    | 0    | 3487       | 40   | 1800  |
| Capacity Analysis Module:     |                    |      |      |             |      |      |            |      |      |            |      |       |
| Vol/Sat:                      | 0.00               | 0.27 | 0.00 | 0.57        | 0.57 | 0.00 | 0.00       | 0.00 | 0.00 | 0.10       | 0.10 | 0.24  |
| Crit Moves:                   | ****               |      |      |             |      |      |            |      |      |            |      |       |
| Green Time:                   | 0.0                | 30.9 | 0.0  | 65.8        | 96.7 | 0.0  | 0.0        | 0.0  | 0.0  | 27.3       | 27.3 | 27.3  |
| Volume/Cap:                   | 0.00               | 1.13 | 0.00 | 1.13        | 0.77 | 0.00 | 0.00       | 0.00 | 0.00 | 0.48       | 0.48 | 1.13  |
| Delay/Veh:                    | 0.0                | 119  | 0.0  | 96.8        | 10.9 | 0.0  | 0.0        | 0.0  | 0.0  | 45.3       | 45.3 | 128.3 |
| User DelAdj:                  | 1.00               | 1.00 | 1.00 | 1.00        | 1.00 | 1.00 | 1.00       | 1.00 | 1.00 | 1.00       | 1.00 | 1.00  |
| AdjDel/Veh:                   | 0.0                | 119  | 0.0  | 96.8        | 10.9 | 0.0  | 0.0        | 0.0  | 0.0  | 45.3       | 45.3 | 128.3 |
| LOS by Move:                  | A                  | F    | A    | F           | B    | A    | A          | A    | A    | D          | D    | F     |
| HCM2k95thQ:                   | 0                  | 50   | 0    | 92          | 44   | 0    | 0          | 0    | 0    | 13         | 13   | 45    |

Note: Queue reported is the number of cars per lane.

BART

Level Of Service Computation Report  
 2000 HCM Operations (Future Volume Alternative)  
 AM - Cumulative With Project

Intersection #3052: 880 SB Ramps/Coleman [Study Int 36]

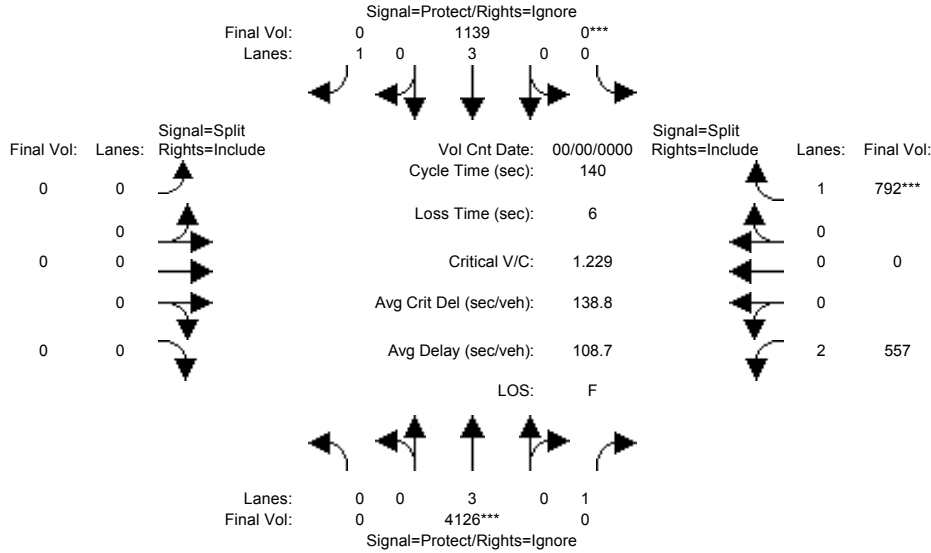

| Approach:                     | North Bound        |      |      | South Bound |      |      | East Bound |      |      | West Bound |      |       |
|-------------------------------|--------------------|------|------|-------------|------|------|------------|------|------|------------|------|-------|
| Movement:                     | L                  | T    | R    | L           | T    | R    | L          | T    | R    | L          | T    | R     |
| Min. Green:                   | 0                  | 10   | 10   | 0           | 10   | 10   | 0          | 0    | 0    | 10         | 0    | 10    |
| Y+R:                          | 4.0                | 4.0  | 4.0  | 4.0         | 4.0  | 4.0  | 4.0        | 4.0  | 4.0  | 4.0        | 4.0  | 4.0   |
| Volume Module: >> Count Date: | 0 0 << 7:30-8:30AM |      |      |             |      |      |            |      |      |            |      |       |
| Base Vol:                     | 0                  | 4126 | 179  | 0           | 1139 | 193  | 0          | 0    | 0    | 557        | 0    | 792   |
| Growth Adj:                   | 1.00               | 1.00 | 1.00 | 1.00        | 1.00 | 1.00 | 1.00       | 1.00 | 1.00 | 1.00       | 1.00 | 1.00  |
| Initial Bse:                  | 0                  | 4126 | 179  | 0           | 1139 | 193  | 0          | 0    | 0    | 557        | 0    | 792   |
| Added Vol:                    | 0                  | 0    | 0    | 0           | 0    | 0    | 0          | 0    | 0    | 0          | 0    | 0     |
| PasserByVol:                  | 0                  | 0    | 0    | 0           | 0    | 0    | 0          | 0    | 0    | 0          | 0    | 0     |
| Initial Fut:                  | 0                  | 4126 | 179  | 0           | 1139 | 193  | 0          | 0    | 0    | 557        | 0    | 792   |
| User Adj:                     | 1.00               | 1.00 | 0.00 | 1.00        | 1.00 | 0.00 | 1.00       | 1.00 | 1.00 | 1.00       | 1.00 | 1.00  |
| PHF Adj:                      | 1.00               | 1.00 | 0.00 | 1.00        | 1.00 | 0.00 | 1.00       | 1.00 | 1.00 | 1.00       | 1.00 | 1.00  |
| PHF Volume:                   | 0                  | 4126 | 0    | 0           | 1139 | 0    | 0          | 0    | 0    | 557        | 0    | 792   |
| Reduct Vol:                   | 0                  | 0    | 0    | 0           | 0    | 0    | 0          | 0    | 0    | 0          | 0    | 0     |
| Reduced Vol:                  | 0                  | 4126 | 0    | 0           | 1139 | 0    | 0          | 0    | 0    | 557        | 0    | 792   |
| PCE Adj:                      | 1.00               | 1.00 | 0.00 | 1.00        | 1.00 | 0.00 | 1.00       | 1.00 | 1.00 | 1.00       | 1.00 | 1.00  |
| MLF Adj:                      | 1.00               | 1.00 | 0.00 | 1.00        | 1.00 | 0.00 | 1.00       | 1.00 | 1.00 | 1.00       | 1.00 | 1.00  |
| Final Volume:                 | 0                  | 4126 | 0    | 0           | 1139 | 0    | 0          | 0    | 0    | 557        | 0    | 792   |
| Saturation Flow Module:       |                    |      |      |             |      |      |            |      |      |            |      |       |
| Sat/Lane:                     | 1900               | 1900 | 1900 | 1900        | 1900 | 1900 | 1900       | 1900 | 1900 | 1900       | 1900 | 1900  |
| Adjustment:                   | 0.92               | 1.00 | 0.92 | 0.92        | 1.00 | 0.92 | 0.92       | 1.00 | 0.92 | 0.83       | 1.00 | 0.92  |
| Lanes:                        | 0.00               | 3.00 | 1.00 | 0.00        | 3.00 | 1.00 | 0.00       | 0.00 | 0.00 | 2.00       | 0.00 | 1.00  |
| Final Sat.:                   | 0                  | 5700 | 1750 | 0           | 5700 | 1750 | 0          | 0    | 0    | 3150       | 0    | 1750  |
| Capacity Analysis Module:     |                    |      |      |             |      |      |            |      |      |            |      |       |
| Vol/Sat:                      | 0.00               | 0.72 | 0.00 | 0.00        | 0.20 | 0.00 | 0.00       | 0.00 | 0.00 | 0.18       | 0.00 | 0.45  |
| Crit Moves:                   | *****              |      |      |             |      |      |            |      |      |            |      |       |
| Green Time:                   | 0.0                | 82.5 | 0.0  | 0.0         | 82.5 | 0.0  | 0.0        | 0.0  | 0.0  | 51.5       | 0.0  | 51.5  |
| Volume/Cap:                   | 0.00               | 1.23 | 0.00 | 0.00        | 0.34 | 0.00 | 0.00       | 0.00 | 0.00 | 0.48       | 0.00 | 1.23  |
| Delay/Veh:                    | 0.0                | 135  | 0.0  | 0.0         | 14.8 | 0.0  | 0.0        | 0.0  | 0.0  | 34.3       | 0.0  | 160.6 |
| User DelAdj:                  | 1.00               | 1.00 | 1.00 | 1.00        | 1.00 | 1.00 | 1.00       | 1.00 | 1.00 | 1.00       | 1.00 | 1.00  |
| AdjDel/Veh:                   | 0.0                | 135  | 0.0  | 0.0         | 14.8 | 0.0  | 0.0        | 0.0  | 0.0  | 34.3       | 0.0  | 160.6 |
| LOS by Move:                  | A                  | F    | A    | A           | B    | A    | A          | A    | A    | C          | A    | F     |
| HCM2k95thQ:                   | 0                  | 136  | 0    | 0           | 15   | 0    | 0          | 0    | 0    | 20         | 0    | 88    |

Note: Queue reported is the number of cars per lane.

BART

Level Of Service Computation Report  
2000 HCM Operations (Future Volume Alternative)  
PM - Cumulative With Project

Intersection #3052: 880 SB Ramps/Coleman [Study Int 36]

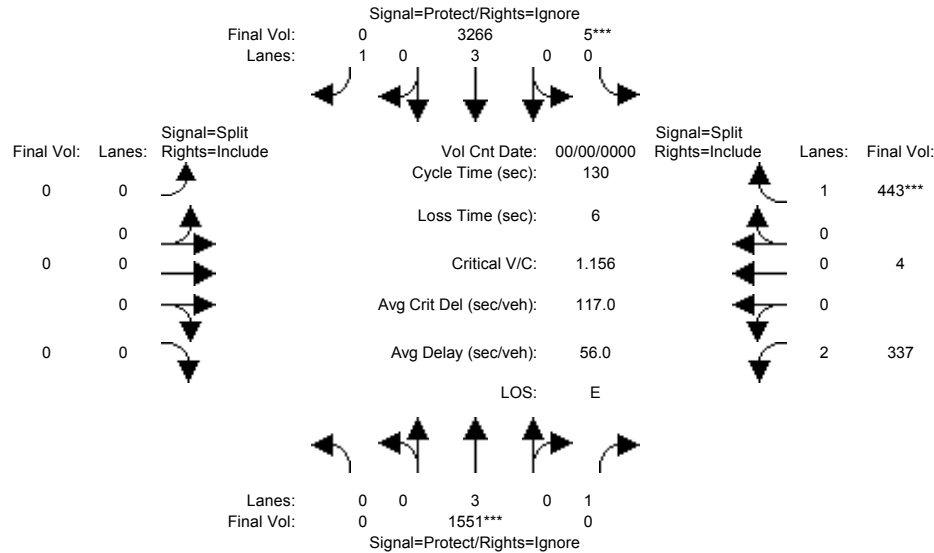

| Approach:                     | North Bound        |      |      | South Bound |      |      | East Bound |      |      | West Bound |      |       |
|-------------------------------|--------------------|------|------|-------------|------|------|------------|------|------|------------|------|-------|
| Movement:                     | L                  | T    | R    | L           | T    | R    | L          | T    | R    | L          | T    | R     |
| Min. Green:                   | 0                  | 10   | 10   | 0           | 10   | 10   | 0          | 0    | 0    | 10         | 0    | 10    |
| Y+R:                          | 4.0                | 4.0  | 4.0  | 4.0         | 4.0  | 4.0  | 4.0        | 4.0  | 4.0  | 4.0        | 4.0  | 4.0   |
| Volume Module: >> Count Date: | 0 0 << 7:30-8:30AM |      |      |             |      |      |            |      |      |            |      |       |
| Base Vol:                     | 0                  | 1551 | 301  | 5           | 3266 | 773  | 0          | 0    | 0    | 337        | 4    | 443   |
| Growth Adj:                   | 1.00               | 1.00 | 1.00 | 1.00        | 1.00 | 1.00 | 1.00       | 1.00 | 1.00 | 1.00       | 1.00 | 1.00  |
| Initial Bse:                  | 0                  | 1551 | 301  | 5           | 3266 | 773  | 0          | 0    | 0    | 337        | 4    | 443   |
| Added Vol:                    | 0                  | 0    | 0    | 0           | 0    | 0    | 0          | 0    | 0    | 0          | 0    | 0     |
| PasserByVol:                  | 0                  | 0    | 0    | 0           | 0    | 0    | 0          | 0    | 0    | 0          | 0    | 0     |
| Initial Fut:                  | 0                  | 1551 | 301  | 5           | 3266 | 773  | 0          | 0    | 0    | 337        | 4    | 443   |
| User Adj:                     | 1.00               | 1.00 | 0.00 | 1.00        | 1.00 | 0.00 | 1.00       | 1.00 | 1.00 | 1.00       | 1.00 | 1.00  |
| PHF Adj:                      | 1.00               | 1.00 | 0.00 | 1.00        | 1.00 | 0.00 | 1.00       | 1.00 | 1.00 | 1.00       | 1.00 | 1.00  |
| PHF Volume:                   | 0                  | 1551 | 0    | 5           | 3266 | 0    | 0          | 0    | 0    | 337        | 4    | 443   |
| Reduct Vol:                   | 0                  | 0    | 0    | 0           | 0    | 0    | 0          | 0    | 0    | 0          | 0    | 0     |
| Reduced Vol:                  | 0                  | 1551 | 0    | 5           | 3266 | 0    | 0          | 0    | 0    | 337        | 4    | 443   |
| PCE Adj:                      | 1.00               | 1.00 | 0.00 | 1.00        | 1.00 | 0.00 | 1.00       | 1.00 | 1.00 | 1.00       | 1.00 | 1.00  |
| MLF Adj:                      | 1.00               | 1.00 | 0.00 | 1.00        | 1.00 | 0.00 | 1.00       | 1.00 | 1.00 | 1.00       | 1.00 | 1.00  |
| Final Volume:                 | 0                  | 1551 | 0    | 5           | 3266 | 0    | 0          | 0    | 0    | 337        | 4    | 443   |
| Saturation Flow Module:       |                    |      |      |             |      |      |            |      |      |            |      |       |
| Sat/Lane:                     | 1900               | 1900 | 1900 | 1900        | 1900 | 1900 | 1900       | 1900 | 1900 | 1900       | 1900 | 1900  |
| Adjustment:                   | 0.92               | 1.00 | 0.92 | 0.95        | 0.98 | 0.92 | 0.92       | 1.00 | 0.92 | 0.93       | 0.95 | 0.95  |
| Lanes:                        | 0.00               | 3.00 | 1.00 | 0.01        | 2.99 | 1.00 | 0.00       | 0.00 | 0.00 | 1.98       | 0.02 | 1.00  |
| Final Sat.:                   | 0                  | 5700 | 1750 | 9           | 5591 | 1750 | 0          | 0    | 0    | 3482       | 41   | 1800  |
| Capacity Analysis Module:     |                    |      |      |             |      |      |            |      |      |            |      |       |
| Vol/Sat:                      | 0.00               | 0.27 | 0.00 | 0.58        | 0.58 | 0.00 | 0.00       | 0.00 | 0.00 | 0.10       | 0.10 | 0.25  |
| Crit Moves:                   | ****               |      |      |             |      |      |            |      |      |            |      |       |
| Green Time:                   | 0.0                | 30.6 | 0.0  | 65.7        | 96.3 | 0.0  | 0.0        | 0.0  | 0.0  | 27.7       | 27.7 | 27.7  |
| Volume/Cap:                   | 0.00               | 1.16 | 0.00 | 1.16        | 0.79 | 0.00 | 0.00       | 0.00 | 0.00 | 0.45       | 0.45 | 1.16  |
| Delay/Veh:                    | 0.0                | 129  | 0.0  | 106.6       | 11.6 | 0.0  | 0.0        | 0.0  | 0.0  | 44.8       | 44.8 | 137.2 |
| User DelAdj:                  | 1.00               | 1.00 | 1.00 | 1.00        | 1.00 | 1.00 | 1.00       | 1.00 | 1.00 | 1.00       | 1.00 | 1.00  |
| AdjDel/Veh:                   | 0.0                | 129  | 0.0  | 106.6       | 11.6 | 0.0  | 0.0        | 0.0  | 0.0  | 44.8       | 44.8 | 137.2 |
| LOS by Move:                  | A                  | F    | A    | F           | B    | A    | A          | A    | A    | D          | D    | F     |
| HCM2k95thQ:                   | 0                  | 51   | 0    | 97          | 46   | 0    | 0          | 0    | 0    | 13         | 13   | 48    |

Note: Queue reported is the number of cars per lane.

BART

Level Of Service Computation Report  
2000 HCM Operations (Future Volume Alternative)  
AM - Cumulative No Project

Intersection #3053: 880 NB Ramps/Coleman [Study Int 37]

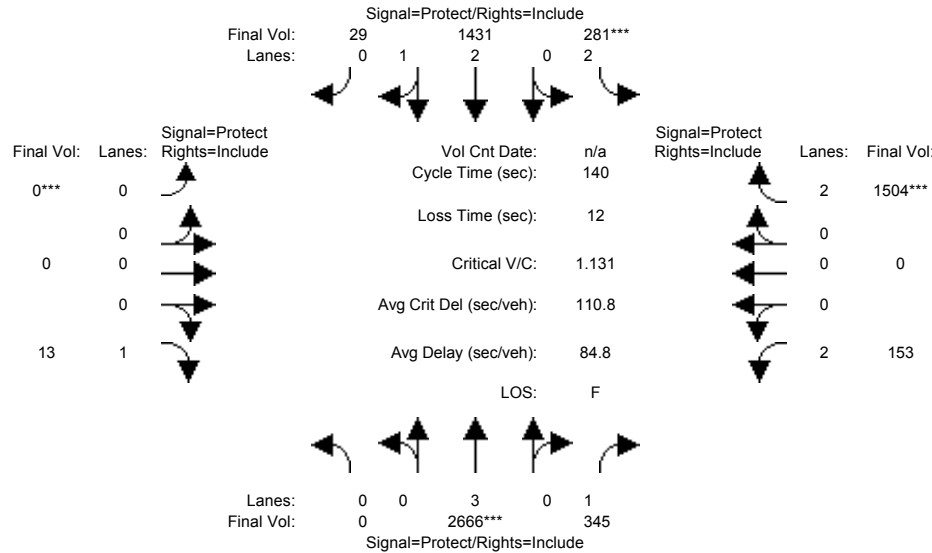

| Approach:                 | North Bound |      |      | South Bound |      |      | East Bound |      |      | West Bound |      |       |
|---------------------------|-------------|------|------|-------------|------|------|------------|------|------|------------|------|-------|
| Movement:                 | L           | T    | R    | L           | T    | R    | L          | T    | R    | L          | T    | R     |
| Min. Green:               | 0           | 10   | 10   | 7           | 10   | 10   | 0          | 0    | 10   | 10         | 0    | 10    |
| Y+R:                      | 4.0         | 4.0  | 4.0  | 4.0         | 4.0  | 4.0  | 4.0        | 4.0  | 4.0  | 4.0        | 4.0  | 4.0   |
| Volume Module:            |             |      |      |             |      |      |            |      |      |            |      |       |
| Base Vol:                 | 0           | 2666 | 345  | 281         | 1431 | 29   | 0          | 0    | 13   | 153        | 0    | 1504  |
| Growth Adj:               | 1.00        | 1.00 | 1.00 | 1.00        | 1.00 | 1.00 | 1.00       | 1.00 | 1.00 | 1.00       | 1.00 | 1.00  |
| Initial Bse:              | 0           | 2666 | 345  | 281         | 1431 | 29   | 0          | 0    | 13   | 153        | 0    | 1504  |
| Added Vol:                | 0           | 0    | 0    | 0           | 0    | 0    | 0          | 0    | 0    | 0          | 0    | 0     |
| PasserByVol:              | 0           | 0    | 0    | 0           | 0    | 0    | 0          | 0    | 0    | 0          | 0    | 0     |
| Initial Fut:              | 0           | 2666 | 345  | 281         | 1431 | 29   | 0          | 0    | 13   | 153        | 0    | 1504  |
| User Adj:                 | 1.00        | 1.00 | 1.00 | 1.00        | 1.00 | 1.00 | 1.00       | 1.00 | 1.00 | 1.00       | 1.00 | 1.00  |
| PHF Adj:                  | 1.00        | 1.00 | 1.00 | 1.00        | 1.00 | 1.00 | 1.00       | 1.00 | 1.00 | 1.00       | 1.00 | 1.00  |
| PHF Volume:               | 0           | 2666 | 345  | 281         | 1431 | 29   | 0          | 0    | 13   | 153        | 0    | 1504  |
| Reduct Vol:               | 0           | 0    | 0    | 0           | 0    | 0    | 0          | 0    | 0    | 0          | 0    | 0     |
| Reduced Vol:              | 0           | 2666 | 345  | 281         | 1431 | 29   | 0          | 0    | 13   | 153        | 0    | 1504  |
| PCE Adj:                  | 1.00        | 1.00 | 1.00 | 1.00        | 1.00 | 1.00 | 1.00       | 1.00 | 1.00 | 1.00       | 1.00 | 1.00  |
| MLF Adj:                  | 1.00        | 1.00 | 1.00 | 1.00        | 1.00 | 1.00 | 1.00       | 1.00 | 1.00 | 1.00       | 1.00 | 1.00  |
| Final Volume:             | 0           | 2666 | 345  | 281         | 1431 | 29   | 0          | 0    | 13   | 153        | 0    | 1504  |
| Saturation Flow Module:   |             |      |      |             |      |      |            |      |      |            |      |       |
| Sat/Lane:                 | 1900        | 1900 | 1900 | 1900        | 1900 | 1900 | 1900       | 1900 | 1900 | 1900       | 1900 | 1900  |
| Adjustment:               | 0.92        | 1.00 | 0.92 | 0.83        | 0.98 | 0.95 | 0.92       | 1.00 | 0.92 | 0.83       | 1.00 | 0.83  |
| Lanes:                    | 0.00        | 3.00 | 1.00 | 2.00        | 2.94 | 0.06 | 0.00       | 0.00 | 1.00 | 2.00       | 0.00 | 2.00  |
| Final Sat.:               | 0           | 5700 | 1750 | 3150        | 5489 | 111  | 0          | 0    | 1750 | 3150       | 0    | 3150  |
| Capacity Analysis Module: |             |      |      |             |      |      |            |      |      |            |      |       |
| Vol/Sat:                  | 0.00        | 0.47 | 0.20 | 0.09        | 0.26 | 0.26 | 0.00       | 0.00 | 0.01 | 0.05       | 0.00 | 0.48  |
| Crit Moves:               | ****        | **** | **** | ****        | **** | **** | ****       | **** | **** | ****       | **** | ****  |
| Green Time:               | 0.0         | 57.9 | 57.9 | 11.0        | 68.9 | 68.9 | 0.0        | 0.0  | 5.6  | 53.5       | 0.0  | 59.1  |
| Volume/Cap:               | 0.00        | 1.13 | 0.48 | 1.13        | 0.53 | 0.53 | 0.00       | 0.00 | 0.19 | 0.13       | 0.00 | 1.13  |
| Delay/Veh:                | 0.0         | 106  | 30.5 | 161.6       | 24.6 | 24.6 | 0.0        | 0.0  | 66.3 | 28.1       | 0.0  | 109.5 |
| User DelAdj:              | 1.00        | 1.00 | 1.00 | 1.00        | 1.00 | 1.00 | 1.00       | 1.00 | 1.00 | 1.00       | 1.00 | 1.00  |
| AdjDel/Veh:               | 0.0         | 106  | 30.5 | 161.6       | 24.6 | 24.6 | 0.0        | 0.0  | 66.3 | 28.1       | 0.0  | 109.5 |
| LOS by Move:              | A           | F    | C    | F           | C    | C    | A          | A    | E    | C          | A    | F     |
| HCM2k95thQ:               | 0           | 74   | 20   | 23          | 25   | 25   | 0          | 0    | 2    | 5          | 0    | 83    |

Note: Queue reported is the number of cars per lane.



BART

Level Of Service Computation Report  
2000 HCM Operations (Future Volume Alternative)  
PM - Cumulative No Project

Intersection #3053: 880 NB Ramps/Coleman [Study Int 37]

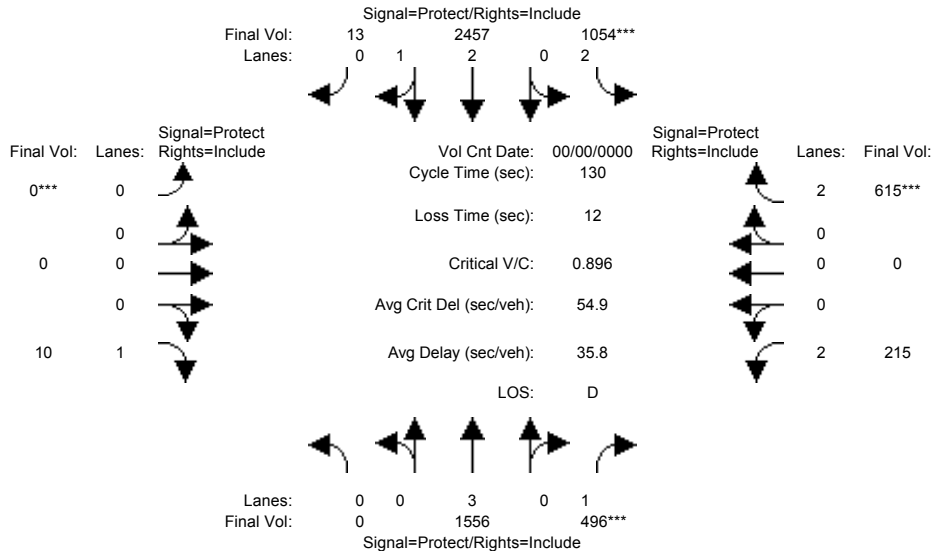

| Approach:  | North Bound |      |      | South Bound |      |      | East Bound |      |      | West Bound |      |      |
|--|-------------|------|------|-------------|------|------|------------|------|------|------------|------|------|
| Movement:  | L           | T    | R    | L           | T    | R    | L          | T    | R    | L          | T    | R    |
| Min. Green:                                      | 0           | 10   | 10   | 7           | 10   | 10   | 0          | 0    | 10   | 10         | 0    | 10   |
| Y+R:   | 4.0         | 4.0  | 4.0  | 4.0         | 4.0  | 4.0  | 4.0        | 4.0  | 4.0  | 4.0        | 4.0  | 4.0  |
| Volume Module: >> Count Date: 0 0 << 7:30-8:30AM |             |      |      |             |      |      |            |      |      |            |      |      |
| Base Vol:  | 0           | 1556 | 496  | 1054        | 2457 | 13   | 0          | 0    | 10   | 215        | 0    | 615  |
| Growth Adj:                                      | 1.00        | 1.00 | 1.00 | 1.00        | 1.00 | 1.00 | 1.00       | 1.00 | 1.00 | 1.00       | 1.00 | 1.00 |
| Initial Bse:                                     | 0           | 1556 | 496  | 1054        | 2457 | 13   | 0          | 0    | 10   | 215        | 0    | 615  |
| Added Vol:                                       | 0           | 0    | 0    | 0           | 0    | 0    | 0          | 0    | 0    | 0          | 0    | 0    |
| PasserByVol:                                     | 0           | 0    | 0    | 0           | 0    | 0    | 0          | 0    | 0    | 0          | 0    | 0    |
| Initial Fut:                                     | 0           | 1556 | 496  | 1054        | 2457 | 13   | 0          | 0    | 10   | 215        | 0    | 615  |
| User Adj:  | 1.00        | 1.00 | 1.00 | 1.00        | 1.00 | 1.00 | 1.00       | 1.00 | 1.00 | 1.00       | 1.00 | 1.00 |
| PHF Adj:   | 1.00        | 1.00 | 1.00 | 1.00        | 1.00 | 1.00 | 1.00       | 1.00 | 1.00 | 1.00       | 1.00 | 1.00 |
| PHF Volume:                                      | 0           | 1556 | 496  | 1054        | 2457 | 13   | 0          | 0    | 10   | 215        | 0    | 615  |
| Reduct Vol:                                      | 0           | 0    | 0    | 0           | 0    | 0    | 0          | 0    | 0    | 0          | 0    | 0    |
| Reduced Vol:                                     | 0           | 1556 | 496  | 1054        | 2457 | 13   | 0          | 0    | 10   | 215        | 0    | 615  |
| PCE Adj:   | 1.00        | 1.00 | 1.00 | 1.00        | 1.00 | 1.00 | 1.00       | 1.00 | 1.00 | 1.00       | 1.00 | 1.00 |
| MLF Adj:   | 1.00        | 1.00 | 1.00 | 1.00        | 1.00 | 1.00 | 1.00       | 1.00 | 1.00 | 1.00       | 1.00 | 1.00 |
| Final Volume:                                    | 0           | 1556 | 496  | 1054        | 2457 | 13   | 0          | 0    | 10   | 215        | 0    | 615  |
| Saturation Flow Module:                          |             |      |      |             |      |      |            |      |      |            |      |      |
| Sat/Lane:  | 1900        | 1900 | 1900 | 1900        | 1900 | 1900 | 1900       | 1900 | 1900 | 1900       | 1900 | 1900 |
| Adjustment:                                      | 0.92        | 1.00 | 0.92 | 0.83        | 0.98 | 0.95 | 0.92       | 1.00 | 0.92 | 0.83       | 1.00 | 0.83 |
| Lanes:   | 0.00        | 3.00 | 1.00 | 2.00        | 2.98 | 0.02 | 0.00       | 0.00 | 1.00 | 2.00       | 0.00 | 2.00 |
| Final Sat.:                                      | 0           | 5700 | 1750 | 3150        | 5570 | 29   | 0          | 0    | 1750 | 3150       | 0    | 3150 |
| Capacity Analysis Module:                        |             |      |      |             |      |      |            |      |      |            |      |      |
| Vol/Sat:   | 0.00        | 0.27 | 0.28 | 0.33        | 0.44 | 0.44 | 0.00       | 0.00 | 0.01 | 0.07       | 0.00 | 0.20 |
| Crit Moves:                                      | 0.00        | 41.1 | 41.1 | 48.5        | 89.7 | 89.7 | 0.00       | 0.00 | 2.0  | 26.4       | 0.0  | 28.3 |
| Green Time:                                      | 0.00        | 46.4 | 59.5 | 47.5        | 11.6 | 11.6 | 0.00       | 0.00 | 72.3 | 44.6       | 0.0  | 63.8 |
| Volume/Cap:                                      | 1.00        | 1.00 | 1.00 | 1.00        | 1.00 | 1.00 | 1.00       | 1.00 | 1.00 | 1.00       | 1.00 | 1.00 |
| Delay/Veh:                                       | 0.00        | 46.4 | 59.5 | 47.5        | 11.6 | 11.6 | 0.00       | 0.00 | 72.3 | 44.6       | 0.0  | 63.8 |
| User DelAdj:                                     | 0.00        | 46.4 | 59.5 | 47.5        | 11.6 | 11.6 | 0.00       | 0.00 | 72.3 | 44.6       | 0.0  | 63.8 |
| AdjDel/Veh:                                      | A           | D    | E    | D           | B    | B    | A          | A    | E    | D          | A    | E    |
| LOS by Move:                                     | 0           | 31   | 32   | 44          | 32   | 32   | 0          | 0    | 2    | 9          | 0    | 30   |
| HCM2k95thQ:                                      | 0           | 31   | 32   | 44          | 32   | 32   | 0          | 0    | 2    | 9          | 0    | 30   |

Note: Queue reported is the number of cars per lane.

BART

Level Of Service Computation Report  
 2000 HCM Operations (Future Volume Alternative)  
 AM - Cumulative With Project

Intersection #3053: 880 NB Ramps/Coleman [Study Int 37]

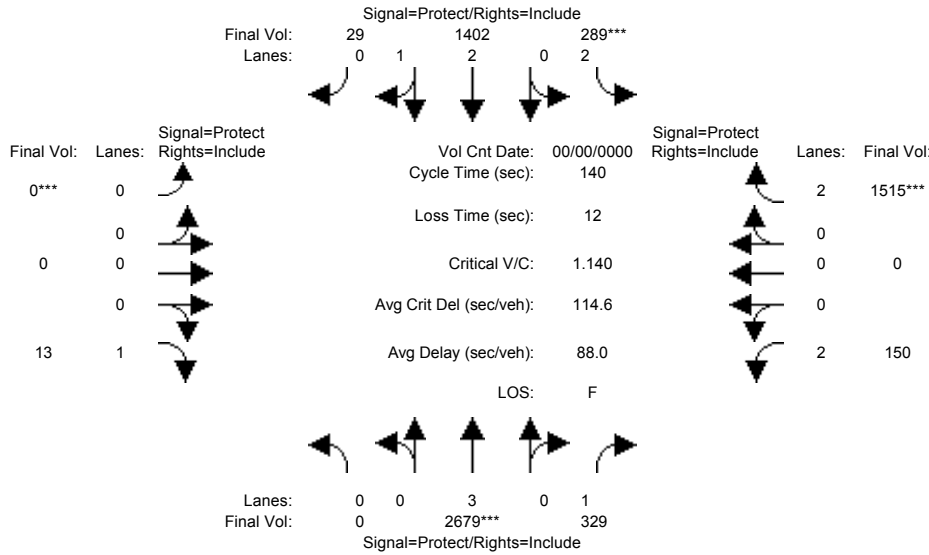

| Approach:  | North Bound |      |      | South Bound |      |      | East Bound |      |      | West Bound |      |       |
|--|-------------|------|------|-------------|------|------|------------|------|------|------------|------|-------|
| Movement:  | L           | T    | R    | L           | T    | R    | L          | T    | R    | L          | T    | R     |
| Min. Green:                                      | 0           | 10   | 10   | 7           | 10   | 10   | 0          | 0    | 10   | 10         | 0    | 10    |
| Y+R:   | 4.0         | 4.0  | 4.0  | 4.0         | 4.0  | 4.0  | 4.0        | 4.0  | 4.0  | 4.0        | 4.0  | 4.0   |
| Volume Module: >> Count Date: 0 0 << 7:30-8:30AM |             |      |      |             |      |      |            |      |      |            |      |       |
| Base Vol:  | 0           | 2679 | 329  | 289         | 1402 | 29   | 0          | 0    | 13   | 150        | 0    | 1515  |
| Growth Adj:                                      | 1.00        | 1.00 | 1.00 | 1.00        | 1.00 | 1.00 | 1.00       | 1.00 | 1.00 | 1.00       | 1.00 | 1.00  |
| Initial Bse:                                     | 0           | 2679 | 329  | 289         | 1402 | 29   | 0          | 0    | 13   | 150        | 0    | 1515  |
| Added Vol:                                       | 0           | 0    | 0    | 0           | 0    | 0    | 0          | 0    | 0    | 0          | 0    | 0     |
| PasserByVol:                                     | 0           | 0    | 0    | 0           | 0    | 0    | 0          | 0    | 0    | 0          | 0    | 0     |
| Initial Fut:                                     | 0           | 2679 | 329  | 289         | 1402 | 29   | 0          | 0    | 13   | 150        | 0    | 1515  |
| User Adj:  | 1.00        | 1.00 | 1.00 | 1.00        | 1.00 | 1.00 | 1.00       | 1.00 | 1.00 | 1.00       | 1.00 | 1.00  |
| PHF Adj:   | 1.00        | 1.00 | 1.00 | 1.00        | 1.00 | 1.00 | 1.00       | 1.00 | 1.00 | 1.00       | 1.00 | 1.00  |
| PHF Volume:                                      | 0           | 2679 | 329  | 289         | 1402 | 29   | 0          | 0    | 13   | 150        | 0    | 1515  |
| Reduct Vol:                                      | 0           | 0    | 0    | 0           | 0    | 0    | 0          | 0    | 0    | 0          | 0    | 0     |
| Reduced Vol:                                     | 0           | 2679 | 329  | 289         | 1402 | 29   | 0          | 0    | 13   | 150        | 0    | 1515  |
| PCE Adj:   | 1.00        | 1.00 | 1.00 | 1.00        | 1.00 | 1.00 | 1.00       | 1.00 | 1.00 | 1.00       | 1.00 | 1.00  |
| MLF Adj:   | 1.00        | 1.00 | 1.00 | 1.00        | 1.00 | 1.00 | 1.00       | 1.00 | 1.00 | 1.00       | 1.00 | 1.00  |
| Final Volume:                                    | 0           | 2679 | 329  | 289         | 1402 | 29   | 0          | 0    | 13   | 150        | 0    | 1515  |
| Saturation Flow Module:                          |             |      |      |             |      |      |            |      |      |            |      |       |
| Sat/Lane:  | 1900        | 1900 | 1900 | 1900        | 1900 | 1900 | 1900       | 1900 | 1900 | 1900       | 1900 | 1900  |
| Adjustment:                                      | 0.92        | 1.00 | 0.92 | 0.83        | 0.98 | 0.95 | 0.92       | 1.00 | 0.92 | 0.83       | 1.00 | 0.83  |
| Lanes:   | 0.00        | 3.00 | 1.00 | 2.00        | 2.94 | 0.06 | 0.00       | 0.00 | 1.00 | 2.00       | 0.00 | 2.00  |
| Final Sat.:                                      | 0           | 5700 | 1750 | 3150        | 5486 | 113  | 0          | 0    | 1750 | 3150       | 0    | 3150  |
| Capacity Analysis Module:                        |             |      |      |             |      |      |            |      |      |            |      |       |
| Vol/Sat:   | 0.00        | 0.47 | 0.19 | 0.09        | 0.26 | 0.26 | 0.00       | 0.00 | 0.01 | 0.05       | 0.00 | 0.48  |
| Crit Moves:                                      | ****        | **** | **** | ****        | **** | **** | ****       | **** | **** | ****       | **** | ****  |
| Green Time:                                      | 0.0         | 57.7 | 57.7 | 11.3        | 69.0 | 69.0 | 0.0        | 0.0  | 5.6  | 53.5       | 0.0  | 59.0  |
| Volume/Cap:                                      | 0.00        | 1.14 | 0.46 | 1.14        | 0.52 | 0.52 | 0.00       | 0.00 | 0.19 | 0.12       | 0.00 | 1.14  |
| Delay/Veh:                                       | 0.0         | 110  | 30.3 | 164.1       | 24.4 | 24.4 | 0.0        | 0.0  | 66.3 | 28.1       | 0.0  | 113.2 |
| User DelAdj:                                     | 1.00        | 1.00 | 1.00 | 1.00        | 1.00 | 1.00 | 1.00       | 1.00 | 1.00 | 1.00       | 1.00 | 1.00  |
| AdjDel/Veh:                                      | 0.0         | 110  | 30.3 | 164.1       | 24.4 | 24.4 | 0.0        | 0.0  | 66.3 | 28.1       | 0.0  | 113.2 |
| LOS by Move:                                     | A           | F    | C    | F           | C    | C    | A          | A    | E    | C          | A    | F     |
| HCM2k95thQ:                                      | 0           | 76   | 19   | 23          | 25   | 25   | 0          | 0    | 2    | 5          | 0    | 85    |

Note: Queue reported is the number of cars per lane.

BART

Level Of Service Computation Report  
2000 HCM Operations (Future Volume Alternative)  
PM - Cumulative With Project

Intersection #3053: 880 NB Ramps/Coleman [Study Int 37]

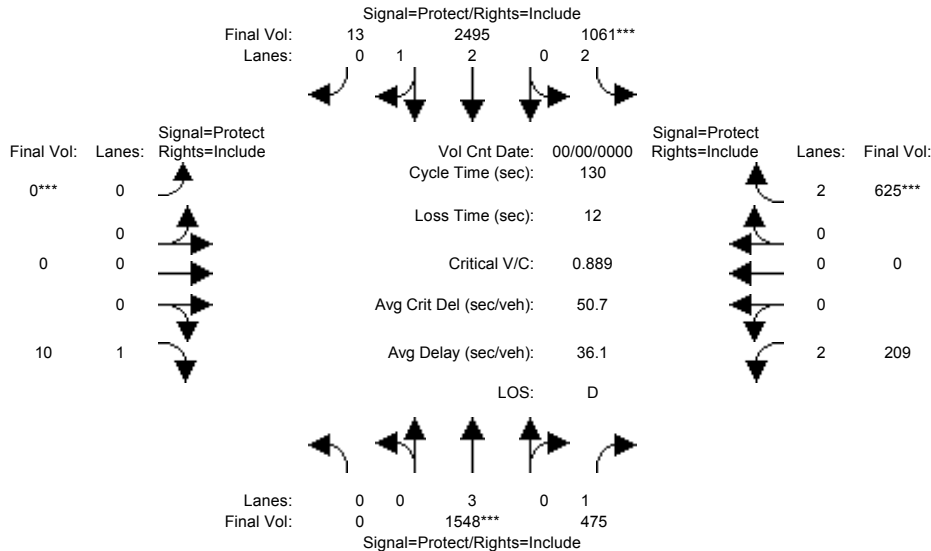

| Approach:  | North Bound |      |      | South Bound |      |      | East Bound |      |      | West Bound |      |      |
|--|-------------|------|------|-------------|------|------|------------|------|------|------------|------|------|
| Movement:  | L           | T    | R    | L           | T    | R    | L          | T    | R    | L          | T    | R    |
| Min. Green:                                      | 0           | 10   | 10   | 7           | 10   | 10   | 0          | 0    | 10   | 10         | 0    | 10   |
| Y+R:   | 4.0         | 4.0  | 4.0  | 4.0         | 4.0  | 4.0  | 4.0        | 4.0  | 4.0  | 4.0        | 4.0  | 4.0  |
| Volume Module: >> Count Date: 0 0 << 7:30-8:30AM |             |      |      |             |      |      |            |      |      |            |      |      |
| Base Vol:  | 0           | 1548 | 475  | 1061        | 2495 | 13   | 0          | 0    | 10   | 209        | 0    | 625  |
| Growth Adj:                                      | 1.00        | 1.00 | 1.00 | 1.00        | 1.00 | 1.00 | 1.00       | 1.00 | 1.00 | 1.00       | 1.00 | 1.00 |
| Initial Bse:                                     | 0           | 1548 | 475  | 1061        | 2495 | 13   | 0          | 0    | 10   | 209        | 0    | 625  |
| Added Vol:                                       | 0           | 0    | 0    | 0           | 0    | 0    | 0          | 0    | 0    | 0          | 0    | 0    |
| PasserByVol:                                     | 0           | 0    | 0    | 0           | 0    | 0    | 0          | 0    | 0    | 0          | 0    | 0    |
| Initial Fut:                                     | 0           | 1548 | 475  | 1061        | 2495 | 13   | 0          | 0    | 10   | 209        | 0    | 625  |
| User Adj:  | 1.00        | 1.00 | 1.00 | 1.00        | 1.00 | 1.00 | 1.00       | 1.00 | 1.00 | 1.00       | 1.00 | 1.00 |
| PHF Adj:   | 1.00        | 1.00 | 1.00 | 1.00        | 1.00 | 1.00 | 1.00       | 1.00 | 1.00 | 1.00       | 1.00 | 1.00 |
| PHF Volume:                                      | 0           | 1548 | 475  | 1061        | 2495 | 13   | 0          | 0    | 10   | 209        | 0    | 625  |
| Reduct Vol:                                      | 0           | 0    | 0    | 0           | 0    | 0    | 0          | 0    | 0    | 0          | 0    | 0    |
| Reduced Vol:                                     | 0           | 1548 | 475  | 1061        | 2495 | 13   | 0          | 0    | 10   | 209        | 0    | 625  |
| PCE Adj:   | 1.00        | 1.00 | 1.00 | 1.00        | 1.00 | 1.00 | 1.00       | 1.00 | 1.00 | 1.00       | 1.00 | 1.00 |
| MLF Adj:   | 1.00        | 1.00 | 1.00 | 1.00        | 1.00 | 1.00 | 1.00       | 1.00 | 1.00 | 1.00       | 1.00 | 1.00 |
| Final Volume:                                    | 0           | 1548 | 475  | 1061        | 2495 | 13   | 0          | 0    | 10   | 209        | 0    | 625  |
| Saturation Flow Module:                          |             |      |      |             |      |      |            |      |      |            |      |      |
| Sat/Lane:  | 1900        | 1900 | 1900 | 1900        | 1900 | 1900 | 1900       | 1900 | 1900 | 1900       | 1900 | 1900 |
| Adjustment:                                      | 0.92        | 1.00 | 0.92 | 0.83        | 0.98 | 0.95 | 0.92       | 1.00 | 0.92 | 0.83       | 1.00 | 0.83 |
| Lanes:   | 0.00        | 3.00 | 1.00 | 2.00        | 2.98 | 0.02 | 0.00       | 0.00 | 1.00 | 2.00       | 0.00 | 2.00 |
| Final Sat.:                                      | 0           | 5700 | 1750 | 3150        | 5571 | 29   | 0          | 0    | 1750 | 3150       | 0    | 3150 |
| Capacity Analysis Module:                        |             |      |      |             |      |      |            |      |      |            |      |      |
| Vol/Sat:   | 0.00        | 0.27 | 0.27 | 0.34        | 0.45 | 0.45 | 0.00       | 0.00 | 0.01 | 0.07       | 0.00 | 0.20 |
| Crit Moves:                                      | ****        | **** | **** | ****        | **** | **** | ****       | **** | **** | ****       | **** | **** |
| Green Time:                                      | 0.0         | 39.7 | 39.7 | 49.3        | 89.0 | 89.0 | 0.0        | 0.0  | 2.0  | 27.0       | 0.0  | 29.0 |
| Volume/Cap:                                      | 0.00        | 0.89 | 0.89 | 0.89        | 0.65 | 0.65 | 0.00       | 0.00 | 0.37 | 0.32       | 0.00 | 0.89 |
| Delay/Veh:                                       | 0.0         | 49.1 | 59.6 | 46.3        | 12.1 | 12.1 | 0.0        | 0.0  | 71.7 | 44.0       | 0.0  | 62.2 |
| User DelAdj:                                     | 1.00        | 1.00 | 1.00 | 1.00        | 1.00 | 1.00 | 1.00       | 1.00 | 1.00 | 1.00       | 1.00 | 1.00 |
| AdjDel/Veh:                                      | 0.0         | 49.1 | 59.6 | 46.3        | 12.1 | 12.1 | 0.0        | 0.0  | 71.7 | 44.0       | 0.0  | 62.2 |
| LOS by Move:                                     | A           | D    | E    | D           | B    | B    | A          | A    | E    | D          | A    | E    |
| HCM2k95thQ:                                      | 0           | 31   | 31   | 44          | 33   | 33   | 0          | 0    | 2    | 9          | 0    | 31   |

Note: Queue reported is the number of cars per lane.

BART

Level Of Service Computation Report  
 2000 HCM Operations (Future Volume Alternative)  
 AM - Cumulative No Project

Intersection #3057: The Alameda/Hedding [Study Int 58]

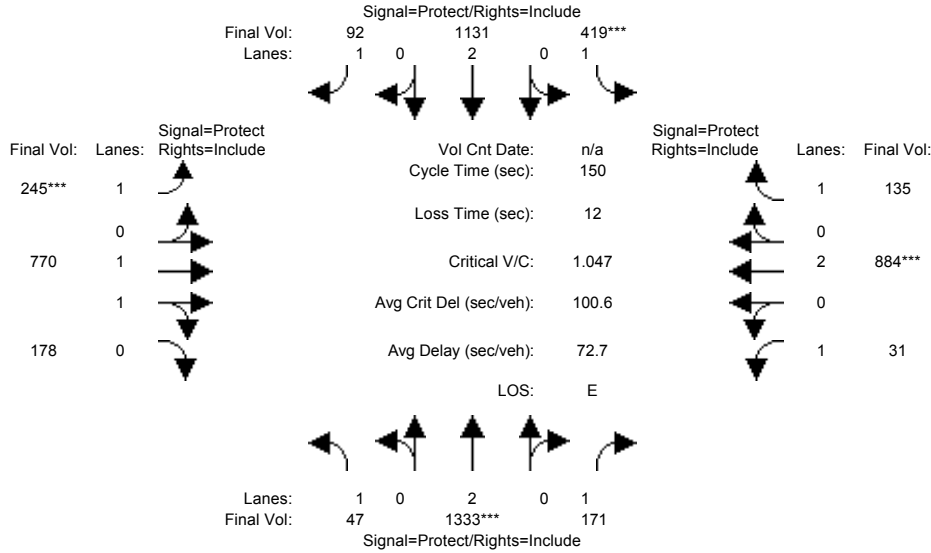

| Approach:                 | North Bound |      |      | South Bound |      |      | East Bound |      |      | West Bound |      |      |
|---------------------------|-------------|------|------|-------------|------|------|------------|------|------|------------|------|------|
| Movement:                 | L           | T    | R    | L           | T    | R    | L          | T    | R    | L          | T    | R    |
| Min. Green:               | 7           | 10   | 10   | 7           | 10   | 10   | 7          | 10   | 10   | 7          | 10   | 10   |
| Y+R:                      | 4.0         | 4.0  | 4.0  | 4.0         | 4.0  | 4.0  | 4.0        | 4.0  | 4.0  | 4.0        | 4.0  | 4.0  |
| Volume Module:            |             |      |      |             |      |      |            |      |      |            |      |      |
| Base Vol:                 | 47          | 1333 | 171  | 419         | 1131 | 92   | 245        | 770  | 178  | 31         | 884  | 135  |
| Growth Adj:               | 1.00        | 1.00 | 1.00 | 1.00        | 1.00 | 1.00 | 1.00       | 1.00 | 1.00 | 1.00       | 1.00 | 1.00 |
| Initial Bse:              | 47          | 1333 | 171  | 419         | 1131 | 92   | 245        | 770  | 178  | 31         | 884  | 135  |
| Added Vol:                | 0           | 0    | 0    | 0           | 0    | 0    | 0          | 0    | 0    | 0          | 0    | 0    |
| PasserByVol:              | 0           | 0    | 0    | 0           | 0    | 0    | 0          | 0    | 0    | 0          | 0    | 0    |
| Initial Fut:              | 47          | 1333 | 171  | 419         | 1131 | 92   | 245        | 770  | 178  | 31         | 884  | 135  |
| User Adj:                 | 1.00        | 1.00 | 1.00 | 1.00        | 1.00 | 1.00 | 1.00       | 1.00 | 1.00 | 1.00       | 1.00 | 1.00 |
| PHF Adj:                  | 1.00        | 1.00 | 1.00 | 1.00        | 1.00 | 1.00 | 1.00       | 1.00 | 1.00 | 1.00       | 1.00 | 1.00 |
| PHF Volume:               | 47          | 1333 | 171  | 419         | 1131 | 92   | 245        | 770  | 178  | 31         | 884  | 135  |
| Reduct Vol:               | 0           | 0    | 0    | 0           | 0    | 0    | 0          | 0    | 0    | 0          | 0    | 0    |
| Reduced Vol:              | 47          | 1333 | 171  | 419         | 1131 | 92   | 245        | 770  | 178  | 31         | 884  | 135  |
| PCE Adj:                  | 1.00        | 1.00 | 1.00 | 1.00        | 1.00 | 1.00 | 1.00       | 1.00 | 1.00 | 1.00       | 1.00 | 1.00 |
| MLF Adj:                  | 1.00        | 1.00 | 1.00 | 1.00        | 1.00 | 1.00 | 1.00       | 1.00 | 1.00 | 1.00       | 1.00 | 1.00 |
| Final Volume:             | 47          | 1333 | 171  | 419         | 1131 | 92   | 245        | 770  | 178  | 31         | 884  | 135  |
| Saturation Flow Module:   |             |      |      |             |      |      |            |      |      |            |      |      |
| Sat/Lane:                 | 1900        | 1900 | 1900 | 1900        | 1900 | 1900 | 1900       | 1900 | 1900 | 1900       | 1900 | 1900 |
| Adjustment:               | 0.92        | 1.00 | 0.92 | 0.92        | 1.00 | 0.92 | 0.92       | 0.98 | 0.95 | 0.92       | 1.00 | 0.92 |
| Lanes:                    | 1.00        | 2.00 | 1.00 | 1.00        | 2.00 | 1.00 | 1.00       | 1.61 | 0.39 | 1.00       | 2.00 | 1.00 |
| Final Sat.:               | 1750        | 3800 | 1750 | 1750        | 3800 | 1750 | 1750       | 3005 | 695  | 1750       | 3800 | 1750 |
| Capacity Analysis Module: |             |      |      |             |      |      |            |      |      |            |      |      |
| Vol/Sat:                  | 0.03        | 0.35 | 0.10 | 0.24        | 0.30 | 0.05 | 0.14       | 0.26 | 0.26 | 0.02       | 0.23 | 0.08 |
| Crit Moves:               | ****        | **** | **** | ****        | **** | **** | ****       | **** | **** | ****       | **** | **** |
| Green Time:               | 11.5        | 50.3 | 50.3 | 34.3        | 73.1 | 73.1 | 20.1       | 45.2 | 45.2 | 8.2        | 33.3 | 33.3 |
| Volume/Cap:               | 0.35        | 1.05 | 0.29 | 1.05        | 0.61 | 0.11 | 1.05       | 0.85 | 0.85 | 0.32       | 1.05 | 0.35 |
| Delay/Veh:                | 67.3        | 88.2 | 37.0 | 115.5       | 28.6 | 20.8 | 136.5      | 55.6 | 55.6 | 70.2       | 102  | 49.7 |
| User DelAdj:              | 1.00        | 1.00 | 1.00 | 1.00        | 1.00 | 1.00 | 1.00       | 1.00 | 1.00 | 1.00       | 1.00 | 1.00 |
| AdjDel/Veh:               | 67.3        | 88.2 | 37.0 | 115.5       | 28.6 | 20.8 | 136.5      | 55.6 | 55.6 | 70.2       | 102  | 49.7 |
| LOS by Move:              | E           | F    | D    | F           | C    | C    | F          | E    | E    | E          | F    | D    |
| HCM2k95thQ:               | 4           | 52   | 11   | 42          | 31   | 5    | 30         | 39   | 39   | 3          | 37   | 10   |

Note: Queue reported is the number of cars per lane.

BART

Level Of Service Computation Report  
2000 HCM Operations (Future Volume Alternative)  
PM - Cumulative No Project

Intersection #3057: The Alameda/Hedding [Study Int 58]

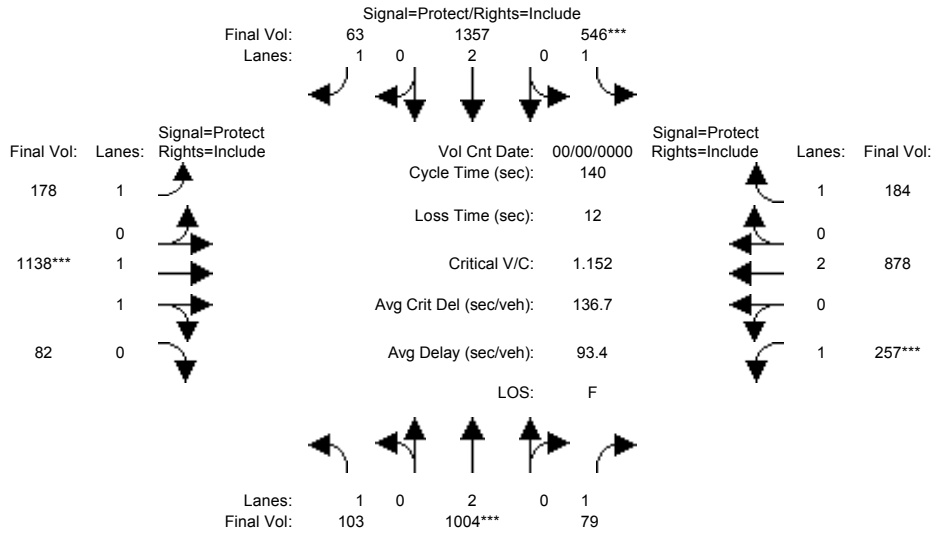

| Approach:                               | North Bound |      |      | South Bound |      |      | East Bound |      |       | West Bound |      |      |
|---|-------------|------|------|-------------|------|------|------------|------|-------|------------|------|------|
| Movement:                               | L           | T    | R    | L           | T    | R    | L          | T    | R     | L          | T    | R    |
| Min. Green:                             | 7           | 10   | 10   | 7           | 10   | 10   | 7          | 10   | 10    | 7          | 10   | 10   |
| Y+R:                                    | 4.0         | 4.0  | 4.0  | 4.0         | 4.0  | 4.0  | 4.0        | 4.0  | 4.0   | 4.0        | 4.0  | 4.0  |
| Volume Module: >> Count Date: 0 0 << AM |             |      |      |             |      |      |            |      |       |            |      |      |
| Base Vol:                               | 103         | 1004 | 79   | 546         | 1357 | 63   | 178        | 1138 | 82    | 257        | 878  | 184  |
| Growth Adj:                             | 1.00        | 1.00 | 1.00 | 1.00        | 1.00 | 1.00 | 1.00       | 1.00 | 1.00  | 1.00       | 1.00 | 1.00 |
| Initial Bse:                            | 103         | 1004 | 79   | 546         | 1357 | 63   | 178        | 1138 | 82    | 257        | 878  | 184  |
| Added Vol:                              | 0           | 0    | 0    | 0           | 0    | 0    | 0          | 0    | 0     | 0          | 0    | 0    |
| PasserByVol:                            | 0           | 0    | 0    | 0           | 0    | 0    | 0          | 0    | 0     | 0          | 0    | 0    |
| Initial Fut:                            | 103         | 1004 | 79   | 546         | 1357 | 63   | 178        | 1138 | 82    | 257        | 878  | 184  |
| User Adj:                               | 1.00        | 1.00 | 1.00 | 1.00        | 1.00 | 1.00 | 1.00       | 1.00 | 1.00  | 1.00       | 1.00 | 1.00 |
| PHF Adj:                                | 1.00        | 1.00 | 1.00 | 1.00        | 1.00 | 1.00 | 1.00       | 1.00 | 1.00  | 1.00       | 1.00 | 1.00 |
| PHF Volume:                             | 103         | 1004 | 79   | 546         | 1357 | 63   | 178        | 1138 | 82    | 257        | 878  | 184  |
| Reduct Vol:                             | 0           | 0    | 0    | 0           | 0    | 0    | 0          | 0    | 0     | 0          | 0    | 0    |
| Reduced Vol:                            | 103         | 1004 | 79   | 546         | 1357 | 63   | 178        | 1138 | 82    | 257        | 878  | 184  |
| PCE Adj:                                | 1.00        | 1.00 | 1.00 | 1.00        | 1.00 | 1.00 | 1.00       | 1.00 | 1.00  | 1.00       | 1.00 | 1.00 |
| MLF Adj:                                | 1.00        | 1.00 | 1.00 | 1.00        | 1.00 | 1.00 | 1.00       | 1.00 | 1.00  | 1.00       | 1.00 | 1.00 |
| Final Volume:                           | 103         | 1004 | 79   | 546         | 1357 | 63   | 178        | 1138 | 82    | 257        | 878  | 184  |
| Saturation Flow Module:                 |             |      |      |             |      |      |            |      |       |            |      |      |
| Sat/Lane:                               | 1900        | 1900 | 1900 | 1900        | 1900 | 1900 | 1900       | 1900 | 1900  | 1900       | 1900 | 1900 |
| Adjustment:                             | 0.92        | 1.00 | 0.92 | 0.92        | 1.00 | 0.92 | 0.92       | 0.98 | 0.95  | 0.92       | 1.00 | 0.92 |
| Lanes:                                  | 1.00        | 2.00 | 1.00 | 1.00        | 2.00 | 1.00 | 1.00       | 1.86 | 0.14  | 1.00       | 2.00 | 1.00 |
| Final Sat.:                             | 1750        | 3800 | 1750 | 1750        | 3800 | 1750 | 1750       | 3451 | 249   | 1750       | 3800 | 1750 |
| Capacity Analysis Module:               |             |      |      |             |      |      |            |      |       |            |      |      |
| Vol/Sat:                                | 0.06        | 0.26 | 0.05 | 0.31        | 0.36 | 0.04 | 0.10       | 0.33 | 0.33  | 0.15       | 0.23 | 0.11 |
| Crit Moves:                             | ****        | **** | **** | ****        | **** | **** | ****       | **** | ****  | ****       | **** | **** |
| Green Time:                             | 9.9         | 32.1 | 32.1 | 37.9        | 60.1 | 60.1 | 17.7       | 40.1 | 40.1  | 17.9       | 40.2 | 40.2 |
| Volume/Cap:                             | 0.83        | 1.15 | 0.20 | 1.15        | 0.83 | 0.08 | 0.80       | 1.15 | 1.15  | 1.15       | 0.80 | 0.37 |
| Delay/Veh:                              | 99.8        | 135  | 43.8 | 141.1       | 39.2 | 23.7 | 78.3       | 129  | 129.2 | 168.2      | 50.6 | 40.2 |
| User DelAdj:                            | 1.00        | 1.00 | 1.00 | 1.00        | 1.00 | 1.00 | 1.00       | 1.00 | 1.00  | 1.00       | 1.00 | 1.00 |
| AdjDel/Veh:                             | 99.8        | 135  | 43.8 | 141.1       | 39.2 | 23.7 | 78.3       | 129  | 129.2 | 168.2      | 50.6 | 40.2 |
| LOS by Move:                            | F           | F    | D    | F           | D    | C    | E          | F    | F     | F          | D    | D    |
| HCM2k95thQ:                             | 10          | 48   | 6    | 55          | 42   | 3    | 19         | 62   | 62    | 29         | 30   | 12   |

Note: Queue reported is the number of cars per lane.

BART

Level Of Service Computation Report  
2000 HCM Operations (Future Volume Alternative)  
AM - Cumulative With Project

Intersection #3057: The Alameda/Hedding [Study Int 58]

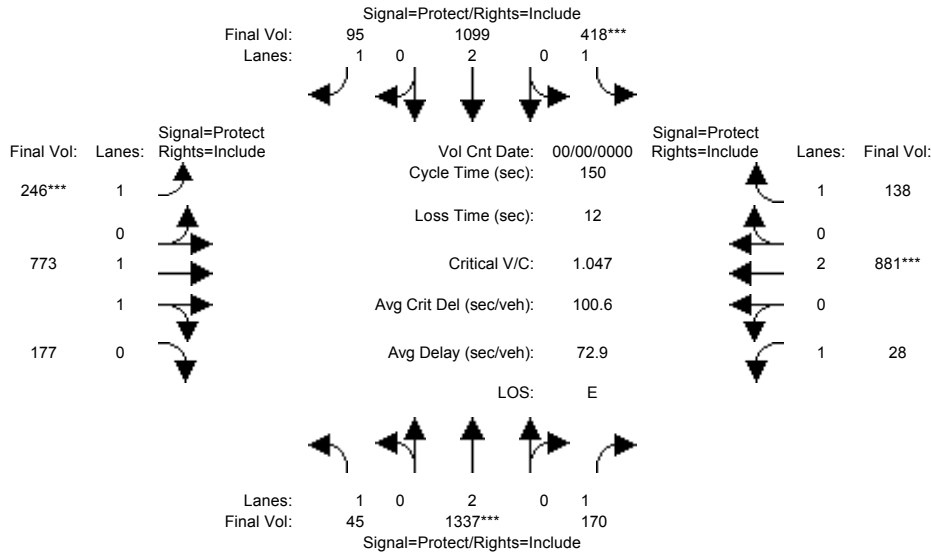

| Approach:                               | North Bound |      |      | South Bound |      |      | East Bound |      |      | West Bound |      |      |
|---|-------------|------|------|-------------|------|------|------------|------|------|------------|------|------|
| Movement:                               | L           | T    | R    | L           | T    | R    | L          | T    | R    | L          | T    | R    |
| Min. Green:                             | 7           | 10   | 10   | 7           | 10   | 10   | 7          | 10   | 10   | 7          | 10   | 10   |
| Y+R:                                    | 4.0         | 4.0  | 4.0  | 4.0         | 4.0  | 4.0  | 4.0        | 4.0  | 4.0  | 4.0        | 4.0  | 4.0  |
| Volume Module: >> Count Date: 0 0 << AM |             |      |      |             |      |      |            |      |      |            |      |      |
| Base Vol:                               | 45          | 1337 | 170  | 418         | 1099 | 95   | 246        | 773  | 177  | 28         | 881  | 138  |
| Growth Adj:                             | 1.00        | 1.00 | 1.00 | 1.00        | 1.00 | 1.00 | 1.00       | 1.00 | 1.00 | 1.00       | 1.00 | 1.00 |
| Initial Bse:                            | 45          | 1337 | 170  | 418         | 1099 | 95   | 246        | 773  | 177  | 28         | 881  | 138  |
| Added Vol:                              | 0           | 0    | 0    | 0           | 0    | 0    | 0          | 0    | 0    | 0          | 0    | 0    |
| PasserByVol:                            | 0           | 0    | 0    | 0           | 0    | 0    | 0          | 0    | 0    | 0          | 0    | 0    |
| Initial Fut:                            | 45          | 1337 | 170  | 418         | 1099 | 95   | 246        | 773  | 177  | 28         | 881  | 138  |
| User Adj:                               | 1.00        | 1.00 | 1.00 | 1.00        | 1.00 | 1.00 | 1.00       | 1.00 | 1.00 | 1.00       | 1.00 | 1.00 |
| PHF Adj:                                | 1.00        | 1.00 | 1.00 | 1.00        | 1.00 | 1.00 | 1.00       | 1.00 | 1.00 | 1.00       | 1.00 | 1.00 |
| PHF Volume:                             | 45          | 1337 | 170  | 418         | 1099 | 95   | 246        | 773  | 177  | 28         | 881  | 138  |
| Reduct Vol:                             | 0           | 0    | 0    | 0           | 0    | 0    | 0          | 0    | 0    | 0          | 0    | 0    |
| Reduced Vol:                            | 45          | 1337 | 170  | 418         | 1099 | 95   | 246        | 773  | 177  | 28         | 881  | 138  |
| PCE Adj:                                | 1.00        | 1.00 | 1.00 | 1.00        | 1.00 | 1.00 | 1.00       | 1.00 | 1.00 | 1.00       | 1.00 | 1.00 |
| MLF Adj:                                | 1.00        | 1.00 | 1.00 | 1.00        | 1.00 | 1.00 | 1.00       | 1.00 | 1.00 | 1.00       | 1.00 | 1.00 |
| Final Volume:                           | 45          | 1337 | 170  | 418         | 1099 | 95   | 246        | 773  | 177  | 28         | 881  | 138  |
| Saturation Flow Module:                 |             |      |      |             |      |      |            |      |      |            |      |      |
| Sat/Lane:                               | 1900        | 1900 | 1900 | 1900        | 1900 | 1900 | 1900       | 1900 | 1900 | 1900       | 1900 | 1900 |
| Adjustment:                             | 0.92        | 1.00 | 0.92 | 0.92        | 1.00 | 0.92 | 0.92       | 0.98 | 0.95 | 0.92       | 1.00 | 0.92 |
| Lanes:                                  | 1.00        | 2.00 | 1.00 | 1.00        | 2.00 | 1.00 | 1.00       | 1.62 | 0.38 | 1.00       | 2.00 | 1.00 |
| Final Sat.:                             | 1750        | 3800 | 1750 | 1750        | 3800 | 1750 | 1750       | 3010 | 689  | 1750       | 3800 | 1750 |
| Capacity Analysis Module:               |             |      |      |             |      |      |            |      |      |            |      |      |
| Vol/Sat:                                | 0.03        | 0.35 | 0.10 | 0.24        | 0.29 | 0.05 | 0.14       | 0.26 | 0.26 | 0.02       | 0.23 | 0.08 |
| Crit Moves:                             | ****        | **** | **** | ****        | **** | **** | ****       | **** | **** | ****       | **** | **** |
| Green Time:                             | 11.8        | 50.4 | 50.4 | 34.2        | 72.9 | 72.9 | 20.1       | 45.2 | 45.2 | 8.2        | 33.2 | 33.2 |
| Volume/Cap:                             | 0.33        | 1.05 | 0.29 | 1.05        | 0.60 | 0.11 | 1.05       | 0.85 | 0.85 | 0.29       | 1.05 | 0.36 |
| Delay/Veh:                              | 66.8        | 88.2 | 36.9 | 115.7       | 28.4 | 21.0 | 136.5      | 55.8 | 55.8 | 69.8       | 102  | 49.9 |
| User DelAdj:                            | 1.00        | 1.00 | 1.00 | 1.00        | 1.00 | 1.00 | 1.00       | 1.00 | 1.00 | 1.00       | 1.00 | 1.00 |
| AdjDel/Veh:                             | 66.8        | 88.2 | 36.9 | 115.7       | 28.4 | 21.0 | 136.5      | 55.8 | 55.8 | 69.8       | 102  | 49.9 |
| LOS by Move:                            | E           | F    | D    | F           | C    | C    | F          | E    | E    | E          | F    | D    |
| HCM2k95thQ:                             | 4           | 52   | 11   | 42          | 30   | 5    | 31         | 39   | 39   | 3          | 37   | 10   |

Note: Queue reported is the number of cars per lane.

BART

Level Of Service Computation Report  
 2000 HCM Operations (Future Volume Alternative)  
 PM - Cumulative With Project

Intersection #3057: The Alameda/Hedding [Study Int 58]

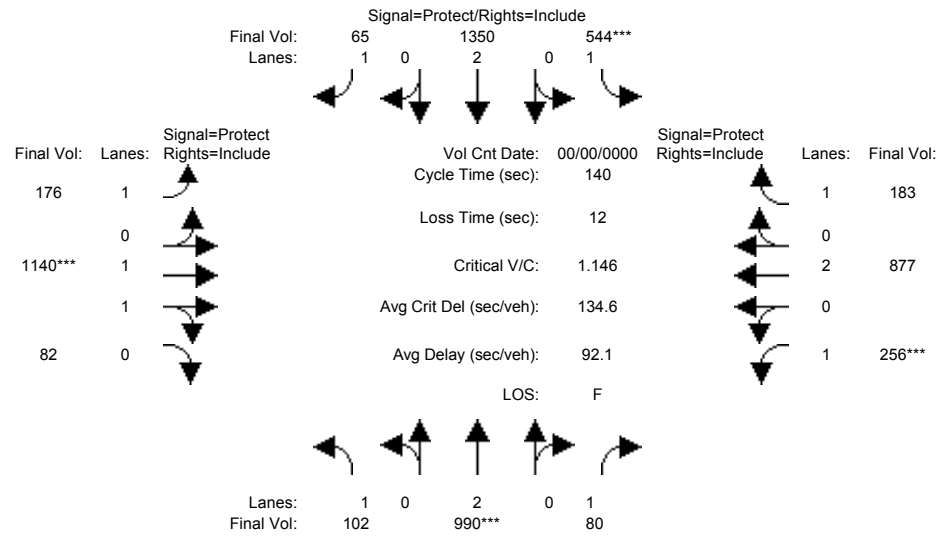

| Approach:                               | North Bound |      |      | South Bound |      |      | East Bound |      |       | West Bound |      |      |
|---|-------------|------|------|-------------|------|------|------------|------|-------|------------|------|------|
| Movement:                               | L           | T    | R    | L           | T    | R    | L          | T    | R     | L          | T    | R    |
| Min. Green:                             | 7           | 10   | 10   | 7           | 10   | 10   | 7          | 10   | 10    | 7          | 10   | 10   |
| Y+R:                                    | 4.0         | 4.0  | 4.0  | 4.0         | 4.0  | 4.0  | 4.0        | 4.0  | 4.0   | 4.0        | 4.0  | 4.0  |
| Volume Module: >> Count Date: 0 0 << AM |             |      |      |             |      |      |            |      |       |            |      |      |
| Base Vol:                               | 102         | 990  | 80   | 544         | 1350 | 65   | 176        | 1140 | 82    | 256        | 877  | 183  |
| Growth Adj:                             | 1.00        | 1.00 | 1.00 | 1.00        | 1.00 | 1.00 | 1.00       | 1.00 | 1.00  | 1.00       | 1.00 | 1.00 |
| Initial Bse:                            | 102         | 990  | 80   | 544         | 1350 | 65   | 176        | 1140 | 82    | 256        | 877  | 183  |
| Added Vol:                              | 0           | 0    | 0    | 0           | 0    | 0    | 0          | 0    | 0     | 0          | 0    | 0    |
| PasserByVol:                            | 0           | 0    | 0    | 0           | 0    | 0    | 0          | 0    | 0     | 0          | 0    | 0    |
| Initial Fut:                            | 102         | 990  | 80   | 544         | 1350 | 65   | 176        | 1140 | 82    | 256        | 877  | 183  |
| User Adj:                               | 1.00        | 1.00 | 1.00 | 1.00        | 1.00 | 1.00 | 1.00       | 1.00 | 1.00  | 1.00       | 1.00 | 1.00 |
| PHF Adj:                                | 1.00        | 1.00 | 1.00 | 1.00        | 1.00 | 1.00 | 1.00       | 1.00 | 1.00  | 1.00       | 1.00 | 1.00 |
| PHF Volume:                             | 102         | 990  | 80   | 544         | 1350 | 65   | 176        | 1140 | 82    | 256        | 877  | 183  |
| Reduct Vol:                             | 0           | 0    | 0    | 0           | 0    | 0    | 0          | 0    | 0     | 0          | 0    | 0    |
| Reduced Vol:                            | 102         | 990  | 80   | 544         | 1350 | 65   | 176        | 1140 | 82    | 256        | 877  | 183  |
| PCE Adj:                                | 1.00        | 1.00 | 1.00 | 1.00        | 1.00 | 1.00 | 1.00       | 1.00 | 1.00  | 1.00       | 1.00 | 1.00 |
| MLF Adj:                                | 1.00        | 1.00 | 1.00 | 1.00        | 1.00 | 1.00 | 1.00       | 1.00 | 1.00  | 1.00       | 1.00 | 1.00 |
| Final Volume:                           | 102         | 990  | 80   | 544         | 1350 | 65   | 176        | 1140 | 82    | 256        | 877  | 183  |
| Saturation Flow Module:                 |             |      |      |             |      |      |            |      |       |            |      |      |
| Sat/Lane:                               | 1900        | 1900 | 1900 | 1900        | 1900 | 1900 | 1900       | 1900 | 1900  | 1900       | 1900 | 1900 |
| Adjustment:                             | 0.92        | 1.00 | 0.92 | 0.92        | 1.00 | 0.92 | 0.92       | 0.98 | 0.95  | 0.92       | 1.00 | 0.92 |
| Lanes:                                  | 1.00        | 2.00 | 1.00 | 1.00        | 2.00 | 1.00 | 1.00       | 1.86 | 0.14  | 1.00       | 2.00 | 1.00 |
| Final Sat.:                             | 1750        | 3800 | 1750 | 1750        | 3800 | 1750 | 1750       | 3452 | 248   | 1750       | 3800 | 1750 |
| Capacity Analysis Module:               |             |      |      |             |      |      |            |      |       |            |      |      |
| Vol/Sat:                                | 0.06        | 0.26 | 0.05 | 0.31        | 0.36 | 0.04 | 0.10       | 0.33 | 0.33  | 0.15       | 0.23 | 0.10 |
| Crit Moves:                             | ****        | **** | **** | ****        | **** | **** | ****       | **** | ****  | ****       | **** | **** |
| Green Time:                             | 9.8         | 31.8 | 31.8 | 38.0        | 60.0 | 60.0 | 17.7       | 40.3 | 40.3  | 17.9       | 40.5 | 40.5 |
| Volume/Cap:                             | 0.83        | 1.15 | 0.20 | 1.15        | 0.83 | 0.09 | 0.80       | 1.15 | 1.15  | 1.15       | 0.80 | 0.36 |
| Delay/Veh:                              | 99.7        | 133  | 44.0 | 139.0       | 39.2 | 23.8 | 77.5       | 127  | 126.9 | 166.3      | 50.1 | 39.9 |
| User DelAdj:                            | 1.00        | 1.00 | 1.00 | 1.00        | 1.00 | 1.00 | 1.00       | 1.00 | 1.00  | 1.00       | 1.00 | 1.00 |
| AdjDel/Veh:                             | 99.7        | 133  | 44.0 | 139.0       | 39.2 | 23.8 | 77.5       | 127  | 126.9 | 166.3      | 50.1 | 39.9 |
| LOS by Move:                            | F           | F    | D    | F           | D    | C    | E          | F    | F     | F          | D    | D    |
| HCM2k95thQ:                             | 10          | 47   | 6    | 55          | 41   | 3    | 18         | 62   | 62    | 29         | 30   | 12   |

Note: Queue reported is the number of cars per lane.

BART

Level Of Service Computation Report  
 2000 HCM Operations (Future Volume Alternative)  
 AM - Cumulative No Project

Intersection #3058: The Alameda/Naglee [Study Int 59]

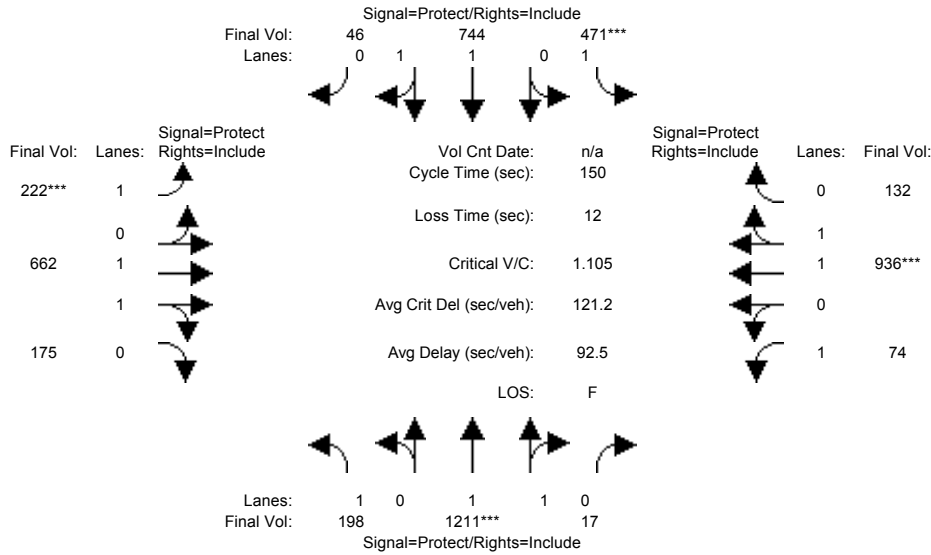

| Approach:                 | North Bound |      |       | South Bound |      |      | East Bound |      |      | West Bound |      |       |
|---------------------------|-------------|------|-------|-------------|------|------|------------|------|------|------------|------|-------|
| Movement:                 | L           | T    | R     | L           | T    | R    | L          | T    | R    | L          | T    | R     |
| Min. Green:               | 7           | 10   | 10    | 7           | 10   | 10   | 7          | 10   | 10   | 7          | 10   | 10    |
| Y+R:                      | 4.0         | 4.0  | 4.0   | 4.0         | 4.0  | 4.0  | 4.0        | 4.0  | 4.0  | 4.0        | 4.0  | 4.0   |
| Volume Module:            |             |      |       |             |      |      |            |      |      |            |      |       |
| Base Vol:                 | 198         | 1211 | 17    | 471         | 744  | 46   | 222        | 662  | 175  | 74         | 936  | 132   |
| Growth Adj:               | 1.00        | 1.00 | 1.00  | 1.00        | 1.00 | 1.00 | 1.00       | 1.00 | 1.00 | 1.00       | 1.00 | 1.00  |
| Initial Bse:              | 198         | 1211 | 17    | 471         | 744  | 46   | 222        | 662  | 175  | 74         | 936  | 132   |
| Added Vol:                | 0           | 0    | 0     | 0           | 0    | 0    | 0          | 0    | 0    | 0          | 0    | 0     |
| PasserByVol:              | 0           | 0    | 0     | 0           | 0    | 0    | 0          | 0    | 0    | 0          | 0    | 0     |
| Initial Fut:              | 198         | 1211 | 17    | 471         | 744  | 46   | 222        | 662  | 175  | 74         | 936  | 132   |
| User Adj:                 | 1.00        | 1.00 | 1.00  | 1.00        | 1.00 | 1.00 | 1.00       | 1.00 | 1.00 | 1.00       | 1.00 | 1.00  |
| PHF Adj:                  | 1.00        | 1.00 | 1.00  | 1.00        | 1.00 | 1.00 | 1.00       | 1.00 | 1.00 | 1.00       | 1.00 | 1.00  |
| PHF Volume:               | 198         | 1211 | 17    | 471         | 744  | 46   | 222        | 662  | 175  | 74         | 936  | 132   |
| Reduct Vol:               | 0           | 0    | 0     | 0           | 0    | 0    | 0          | 0    | 0    | 0          | 0    | 0     |
| Reduced Vol:              | 198         | 1211 | 17    | 471         | 744  | 46   | 222        | 662  | 175  | 74         | 936  | 132   |
| PCE Adj:                  | 1.00        | 1.00 | 1.00  | 1.00        | 1.00 | 1.00 | 1.00       | 1.00 | 1.00 | 1.00       | 1.00 | 1.00  |
| MLF Adj:                  | 1.00        | 1.00 | 1.00  | 1.00        | 1.00 | 1.00 | 1.00       | 1.00 | 1.00 | 1.00       | 1.00 | 1.00  |
| Final Volume:             | 198         | 1211 | 17    | 471         | 744  | 46   | 222        | 662  | 175  | 74         | 936  | 132   |
| Saturation Flow Module:   |             |      |       |             |      |      |            |      |      |            |      |       |
| Sat/Lane:                 | 1900        | 1900 | 1900  | 1900        | 1900 | 1900 | 1900       | 1900 | 1900 | 1900       | 1900 | 1900  |
| Adjustment:               | 0.92        | 0.97 | 0.95  | 0.92        | 0.98 | 0.95 | 0.92       | 0.98 | 0.95 | 0.92       | 0.98 | 0.95  |
| Lanes:                    | 1.00        | 1.97 | 0.03  | 1.00        | 1.88 | 0.12 | 1.00       | 1.57 | 0.43 | 1.00       | 1.75 | 0.25  |
| Final Sat.:               | 1750        | 3649 | 51    | 1750        | 3484 | 215  | 1750       | 2926 | 773  | 1750       | 3242 | 457   |
| Capacity Analysis Module: |             |      |       |             |      |      |            |      |      |            |      |       |
| Vol/Sat:                  | 0.11        | 0.33 | 0.33  | 0.27        | 0.21 | 0.21 | 0.13       | 0.23 | 0.23 | 0.04       | 0.29 | 0.29  |
| Crit Moves:               | ****        | **** | ****  | ****        | **** | **** | ****       | **** | **** | ****       | **** | ****  |
| Green Time:               | 28.3        | 45.1 | 45.1  | 36.5        | 53.3 | 53.3 | 17.2       | 46.8 | 46.8 | 9.6        | 39.2 | 39.2  |
| Volume/Cap:               | 0.60        | 1.10 | 1.10  | 1.10        | 0.60 | 0.60 | 1.10       | 0.73 | 0.73 | 0.66       | 1.10 | 1.10  |
| Delay/Veh:                | 58.8        | 113  | 113.0 | 131.9       | 40.4 | 40.4 | 160.8      | 48.2 | 48.2 | 81.9       | 118  | 117.5 |
| User DelAdj:              | 1.00        | 1.00 | 1.00  | 1.00        | 1.00 | 1.00 | 1.00       | 1.00 | 1.00 | 1.00       | 1.00 | 1.00  |
| AdjDel/Veh:               | 58.8        | 113  | 113.0 | 131.9       | 40.4 | 40.4 | 160.8      | 48.2 | 48.2 | 81.9       | 118  | 117.5 |
| LOS by Move:              | E           | F    | F     | F           | D    | D    | F          | D    | D    | F          | F    | F     |
| HCM2k95thQ:               | 18          | 62   | 62    | 49          | 26   | 26   | 30         | 31   | 31   | 7          | 50   | 50    |

Note: Queue reported is the number of cars per lane.



BART

Level Of Service Computation Report  
 2000 HCM Operations (Future Volume Alternative)  
 PM - Cumulative No Project

Intersection #3058: The Alameda/Naglee [Study Int 59]

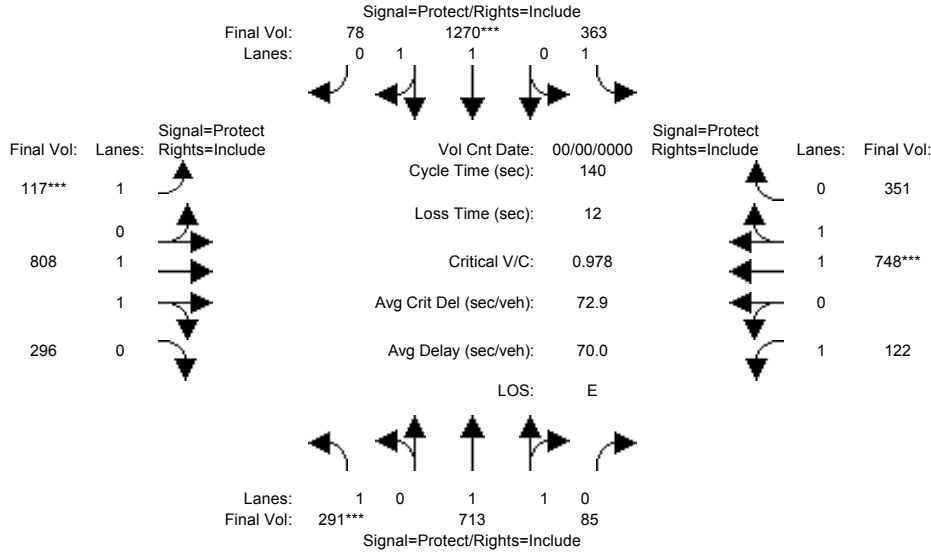

| Approach:                               | North Bound |      |      | South Bound |      |      | East Bound |      |      | West Bound |      |      |
|---|-------------|------|------|-------------|------|------|------------|------|------|------------|------|------|
| Movement:                               | L           | T    | R    | L           | T    | R    | L          | T    | R    | L          | T    | R    |
| Min. Green:                             | 7           | 10   | 10   | 7           | 10   | 10   | 7          | 10   | 10   | 7          | 10   | 10   |
| Y+R:                                    | 4.0         | 4.0  | 4.0  | 4.0         | 4.0  | 4.0  | 4.0        | 4.0  | 4.0  | 4.0        | 4.0  | 4.0  |
| Volume Module: >> Count Date: 0 0 << AM |             |      |      |             |      |      |            |      |      |            |      |      |
| Base Vol:                               | 291         | 713  | 85   | 363         | 1270 | 78   | 117        | 808  | 296  | 122        | 748  | 351  |
| Growth Adj:                             | 1.00        | 1.00 | 1.00 | 1.00        | 1.00 | 1.00 | 1.00       | 1.00 | 1.00 | 1.00       | 1.00 | 1.00 |
| Initial Bse:                            | 291         | 713  | 85   | 363         | 1270 | 78   | 117        | 808  | 296  | 122        | 748  | 351  |
| Added Vol:                              | 0           | 0    | 0    | 0           | 0    | 0    | 0          | 0    | 0    | 0          | 0    | 0    |
| PasserByVol:                            | 0           | 0    | 0    | 0           | 0    | 0    | 0          | 0    | 0    | 0          | 0    | 0    |
| Initial Fut:                            | 291         | 713  | 85   | 363         | 1270 | 78   | 117        | 808  | 296  | 122        | 748  | 351  |
| User Adj:                               | 1.00        | 1.00 | 1.00 | 1.00        | 1.00 | 1.00 | 1.00       | 1.00 | 1.00 | 1.00       | 1.00 | 1.00 |
| PHF Adj:                                | 1.00        | 1.00 | 1.00 | 1.00        | 1.00 | 1.00 | 1.00       | 1.00 | 1.00 | 1.00       | 1.00 | 1.00 |
| PHF Volume:                             | 291         | 713  | 85   | 363         | 1270 | 78   | 117        | 808  | 296  | 122        | 748  | 351  |
| Reduct Vol:                             | 0           | 0    | 0    | 0           | 0    | 0    | 0          | 0    | 0    | 0          | 0    | 0    |
| Reduced Vol:                            | 291         | 713  | 85   | 363         | 1270 | 78   | 117        | 808  | 296  | 122        | 748  | 351  |
| PCE Adj:                                | 1.00        | 1.00 | 1.00 | 1.00        | 1.00 | 1.00 | 1.00       | 1.00 | 1.00 | 1.00       | 1.00 | 1.00 |
| MLF Adj:                                | 1.00        | 1.00 | 1.00 | 1.00        | 1.00 | 1.00 | 1.00       | 1.00 | 1.00 | 1.00       | 1.00 | 1.00 |
| Final Volume:                           | 291         | 713  | 85   | 363         | 1270 | 78   | 117        | 808  | 296  | 122        | 748  | 351  |
| Saturation Flow Module:                 |             |      |      |             |      |      |            |      |      |            |      |      |
| Sat/Lane:                               | 1900        | 1900 | 1900 | 1900        | 1900 | 1900 | 1900       | 1900 | 1900 | 1900       | 1900 | 1900 |
| Adjustment:                             | 0.92        | 0.98 | 0.95 | 0.92        | 0.98 | 0.95 | 0.92       | 0.98 | 0.95 | 0.92       | 0.99 | 0.95 |
| Lanes:                                  | 1.00        | 1.78 | 0.22 | 1.00        | 1.88 | 0.12 | 1.00       | 1.45 | 0.55 | 1.00       | 1.34 | 0.66 |
| Final Sat.:                             | 1750        | 3306 | 394  | 1750        | 3486 | 214  | 1750       | 2707 | 992  | 1750       | 2517 | 1181 |
| Capacity Analysis Module:               |             |      |      |             |      |      |            |      |      |            |      |      |
| Vol/Sat:                                | 0.17        | 0.22 | 0.22 | 0.21        | 0.36 | 0.36 | 0.07       | 0.30 | 0.30 | 0.07       | 0.30 | 0.30 |
| Crit Moves:                             | ****        |      |      | ****        |      |      | ****       |      |      | ****       |      |      |
| Green Time:                             | 23.8        | 38.7 | 38.7 | 37.2        | 52.1 | 52.1 | 9.6        | 42.2 | 42.2 | 9.9        | 42.5 | 42.5 |
| Volume/Cap:                             | 0.98        | 0.78 | 0.78 | 0.78        | 0.98 | 0.98 | 0.98       | 0.98 | 0.99 | 0.99       | 0.99 | 0.98 |
| Delay/Veh:                              | 104.0       | 50.6 | 50.6 | 55.9        | 62.6 | 62.6 | 140.4      | 73.1 | 73.1 | 142.7      | 70.0 | 70.0 |
| User DelAdj:                            | 1.00        | 1.00 | 1.00 | 1.00        | 1.00 | 1.00 | 1.00       | 1.00 | 1.00 | 1.00       | 1.00 | 1.00 |
| AdjDel/Veh:                             | 104.0       | 50.6 | 50.6 | 55.9        | 62.6 | 62.6 | 140.4      | 73.1 | 73.1 | 142.7      | 70.0 | 70.0 |
| LOS by Move:                            | F           | D    | D    | E           | E    | E    | F          | E    | E    | F          | E    | E    |
| HCM2k95thQ:                             | 31          | 30   | 30   | 27          | 50   | 50   | 16         | 48   | 48   | 13         | 43   | 43   |

Note: Queue reported is the number of cars per lane.

BART

Level Of Service Computation Report  
2000 HCM Operations (Future Volume Alternative)  
AM - Cumulative With Project

Intersection #3058: The Alameda/Naglee [Study Int 59]

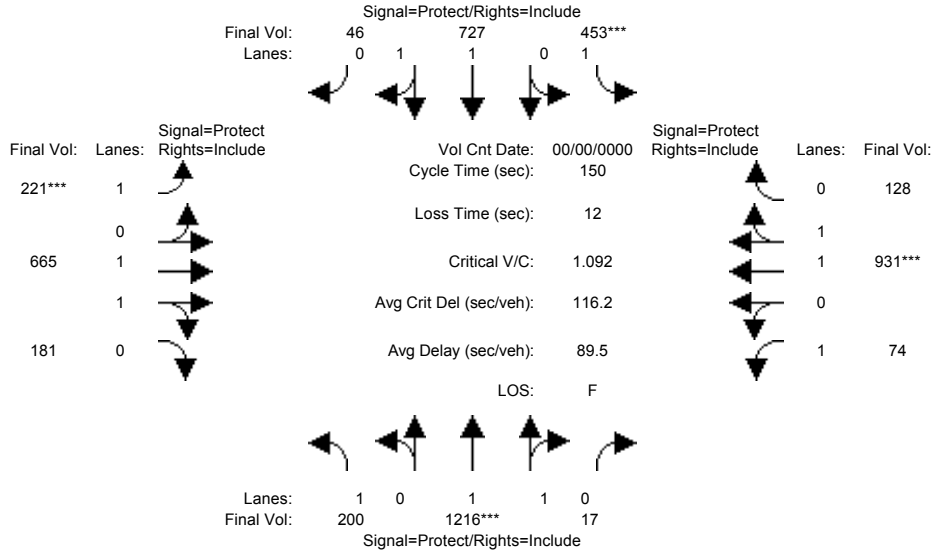

| Approach:                               | North Bound |      |       | South Bound |      |      | East Bound |      |      | West Bound |      |       |
|---|-------------|------|-------|-------------|------|------|------------|------|------|------------|------|-------|
| Movement:                               | L           | T    | R     | L           | T    | R    | L          | T    | R    | L          | T    | R     |
| Min. Green:                             | 7           | 10   | 10    | 7           | 10   | 10   | 7          | 10   | 10   | 7          | 10   | 10    |
| Y+R:                                    | 4.0         | 4.0  | 4.0   | 4.0         | 4.0  | 4.0  | 4.0        | 4.0  | 4.0  | 4.0        | 4.0  | 4.0   |
| Volume Module: >> Count Date: 0 0 << AM |             |      |       |             |      |      |            |      |      |            |      |       |
| Base Vol:                               | 200         | 1216 | 17    | 453         | 727  | 46   | 221        | 665  | 181  | 74         | 931  | 128   |
| Growth Adj:                             | 1.00        | 1.00 | 1.00  | 1.00        | 1.00 | 1.00 | 1.00       | 1.00 | 1.00 | 1.00       | 1.00 | 1.00  |
| Initial Bse:                            | 200         | 1216 | 17    | 453         | 727  | 46   | 221        | 665  | 181  | 74         | 931  | 128   |
| Added Vol:                              | 0           | 0    | 0     | 0           | 0    | 0    | 0          | 0    | 0    | 0          | 0    | 0     |
| PasserByVol:                            | 0           | 0    | 0     | 0           | 0    | 0    | 0          | 0    | 0    | 0          | 0    | 0     |
| Initial Fut:                            | 200         | 1216 | 17    | 453         | 727  | 46   | 221        | 665  | 181  | 74         | 931  | 128   |
| User Adj:                               | 1.00        | 1.00 | 1.00  | 1.00        | 1.00 | 1.00 | 1.00       | 1.00 | 1.00 | 1.00       | 1.00 | 1.00  |
| PHF Adj:                                | 1.00        | 1.00 | 1.00  | 1.00        | 1.00 | 1.00 | 1.00       | 1.00 | 1.00 | 1.00       | 1.00 | 1.00  |
| PHF Volume:                             | 200         | 1216 | 17    | 453         | 727  | 46   | 221        | 665  | 181  | 74         | 931  | 128   |
| Reduct Vol:                             | 0           | 0    | 0     | 0           | 0    | 0    | 0          | 0    | 0    | 0          | 0    | 0     |
| Reduced Vol:                            | 200         | 1216 | 17    | 453         | 727  | 46   | 221        | 665  | 181  | 74         | 931  | 128   |
| PCE Adj:                                | 1.00        | 1.00 | 1.00  | 1.00        | 1.00 | 1.00 | 1.00       | 1.00 | 1.00 | 1.00       | 1.00 | 1.00  |
| MLF Adj:                                | 1.00        | 1.00 | 1.00  | 1.00        | 1.00 | 1.00 | 1.00       | 1.00 | 1.00 | 1.00       | 1.00 | 1.00  |
| Final Volume:                           | 200         | 1216 | 17    | 453         | 727  | 46   | 221        | 665  | 181  | 74         | 931  | 128   |
| Saturation Flow Module:                 |             |      |       |             |      |      |            |      |      |            |      |       |
| Sat/Lane:                               | 1900        | 1900 | 1900  | 1900        | 1900 | 1900 | 1900       | 1900 | 1900 | 1900       | 1900 | 1900  |
| Adjustment:                             | 0.92        | 0.97 | 0.95  | 0.92        | 0.98 | 0.95 | 0.92       | 0.98 | 0.95 | 0.92       | 0.98 | 0.95  |
| Lanes:                                  | 1.00        | 1.97 | 0.03  | 1.00        | 1.88 | 0.12 | 1.00       | 1.56 | 0.44 | 1.00       | 1.75 | 0.25  |
| Final Sat.:                             | 1750        | 3649 | 51    | 1750        | 3480 | 220  | 1750       | 2908 | 791  | 1750       | 3252 | 447   |
| Capacity Analysis Module:               |             |      |       |             |      |      |            |      |      |            |      |       |
| Vol/Sat:                                | 0.11        | 0.33 | 0.33  | 0.26        | 0.21 | 0.21 | 0.13       | 0.23 | 0.23 | 0.04       | 0.29 | 0.29  |
| Crit Moves:                             | ****        | **** | ****  | ****        | **** | **** | ****       | **** | **** | ****       | **** | ****  |
| Green Time:                             | 28.8        | 45.8 | 45.8  | 35.6        | 52.6 | 52.6 | 17.3       | 47.1 | 47.1 | 9.6        | 39.3 | 39.3  |
| Volume/Cap:                             | 0.60        | 1.09 | 1.09  | 1.09        | 0.60 | 0.60 | 1.09       | 0.73 | 0.73 | 0.66       | 1.09 | 1.09  |
| Delay/Veh:                              | 58.2        | 108  | 107.6 | 128.5       | 40.8 | 40.8 | 156.3      | 48.2 | 48.2 | 82.3       | 113  | 112.7 |
| User DelAdj:                            | 1.00        | 1.00 | 1.00  | 1.00        | 1.00 | 1.00 | 1.00       | 1.00 | 1.00 | 1.00       | 1.00 | 1.00  |
| AdjDel/Veh:                             | 58.2        | 108  | 107.6 | 128.5       | 40.8 | 40.8 | 156.3      | 48.2 | 48.2 | 82.3       | 113  | 112.7 |
| LOS by Move:                            | E           | F    | F     | F           | D    | D    | F          | D    | D    | F          | F    | F     |
| HCM2k95thQ:                             | 18          | 61   | 61    | 47          | 25   | 25   | 29         | 32   | 32   | 7          | 48   | 48    |

Note: Queue reported is the number of cars per lane.

BART

Level Of Service Computation Report  
 2000 HCM Operations (Future Volume Alternative)  
 PM - Cumulative With Project

Intersection #3058: The Alameda/Naglee [Study Int 59]

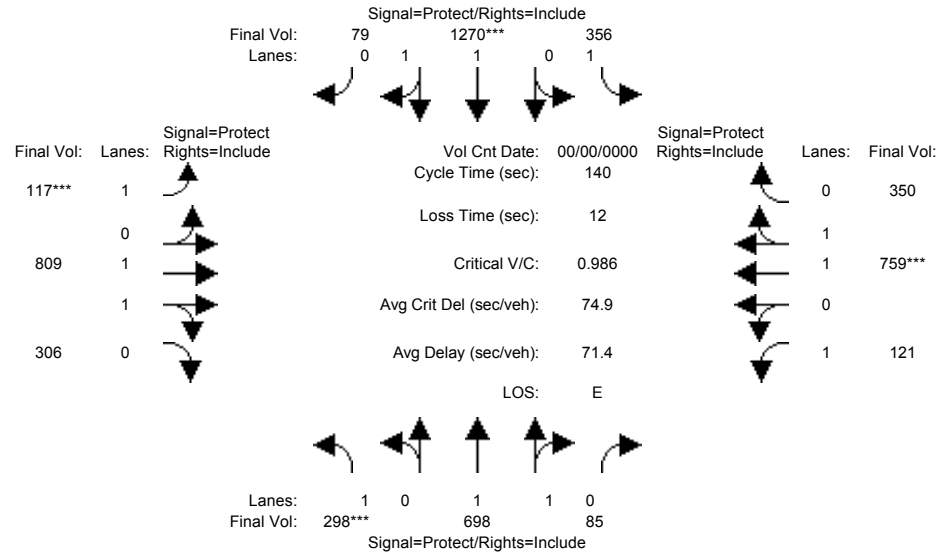

| Approach:                               | North Bound |      |      | South Bound |      |      | East Bound |      |      | West Bound |      |      |
|---|-------------|------|------|-------------|------|------|------------|------|------|------------|------|------|
| Movement:                               | L           | T    | R    | L           | T    | R    | L          | T    | R    | L          | T    | R    |
| Min. Green:                             | 7           | 10   | 10   | 7           | 10   | 10   | 7          | 10   | 10   | 7          | 10   | 10   |
| Y+R:                                    | 4.0         | 4.0  | 4.0  | 4.0         | 4.0  | 4.0  | 4.0        | 4.0  | 4.0  | 4.0        | 4.0  | 4.0  |
| -----                                   |             |      |      |             |      |      |            |      |      |            |      |      |
| Volume Module: >> Count Date: 0 0 << AM |             |      |      |             |      |      |            |      |      |            |      |      |
| Base Vol:                               | 298         | 698  | 85   | 356         | 1270 | 79   | 117        | 809  | 306  | 121        | 759  | 350  |
| Growth Adj:                             | 1.00        | 1.00 | 1.00 | 1.00        | 1.00 | 1.00 | 1.00       | 1.00 | 1.00 | 1.00       | 1.00 | 1.00 |
| Initial Bse:                            | 298         | 698  | 85   | 356         | 1270 | 79   | 117        | 809  | 306  | 121        | 759  | 350  |
| Added Vol:                              | 0           | 0    | 0    | 0           | 0    | 0    | 0          | 0    | 0    | 0          | 0    | 0    |
| PasserByVol:                            | 0           | 0    | 0    | 0           | 0    | 0    | 0          | 0    | 0    | 0          | 0    | 0    |
| Initial Fut:                            | 298         | 698  | 85   | 356         | 1270 | 79   | 117        | 809  | 306  | 121        | 759  | 350  |
| User Adj:                               | 1.00        | 1.00 | 1.00 | 1.00        | 1.00 | 1.00 | 1.00       | 1.00 | 1.00 | 1.00       | 1.00 | 1.00 |
| PHF Adj:                                | 1.00        | 1.00 | 1.00 | 1.00        | 1.00 | 1.00 | 1.00       | 1.00 | 1.00 | 1.00       | 1.00 | 1.00 |
| PHF Volume:                             | 298         | 698  | 85   | 356         | 1270 | 79   | 117        | 809  | 306  | 121        | 759  | 350  |
| Reduct Vol:                             | 0           | 0    | 0    | 0           | 0    | 0    | 0          | 0    | 0    | 0          | 0    | 0    |
| Reduced Vol:                            | 298         | 698  | 85   | 356         | 1270 | 79   | 117        | 809  | 306  | 121        | 759  | 350  |
| PCE Adj:                                | 1.00        | 1.00 | 1.00 | 1.00        | 1.00 | 1.00 | 1.00       | 1.00 | 1.00 | 1.00       | 1.00 | 1.00 |
| MLF Adj:                                | 1.00        | 1.00 | 1.00 | 1.00        | 1.00 | 1.00 | 1.00       | 1.00 | 1.00 | 1.00       | 1.00 | 1.00 |
| Final Volume:                           | 298         | 698  | 85   | 356         | 1270 | 79   | 117        | 809  | 306  | 121        | 759  | 350  |
| -----                                   |             |      |      |             |      |      |            |      |      |            |      |      |
| Saturation Flow Module:                 |             |      |      |             |      |      |            |      |      |            |      |      |
| Sat/Lane:                               | 1900        | 1900 | 1900 | 1900        | 1900 | 1900 | 1900       | 1900 | 1900 | 1900       | 1900 | 1900 |
| Adjustment:                             | 0.92        | 0.98 | 0.95 | 0.92        | 0.98 | 0.95 | 0.92       | 0.98 | 0.95 | 0.92       | 0.99 | 0.95 |
| Lanes:                                  | 1.00        | 1.78 | 0.22 | 1.00        | 1.88 | 0.12 | 1.00       | 1.44 | 0.56 | 1.00       | 1.35 | 0.65 |
| Final Sat.:                             | 1750        | 3298 | 402  | 1750        | 3483 | 217  | 1750       | 2684 | 1015 | 1750       | 2531 | 1167 |
| -----                                   |             |      |      |             |      |      |            |      |      |            |      |      |
| Capacity Analysis Module:               |             |      |      |             |      |      |            |      |      |            |      |      |
| Vol/Sat:                                | 0.17        | 0.21 | 0.21 | 0.20        | 0.36 | 0.36 | 0.07       | 0.30 | 0.30 | 0.07       | 0.30 | 0.30 |
| Crit Moves:                             | ****        |      |      | ****        |      |      | ****       |      |      | ****       |      |      |
| Green Time:                             | 24.2        | 38.7 | 38.7 | 37.2        | 51.8 | 51.8 | 9.5        | 42.3 | 42.3 | 9.7        | 42.6 | 42.6 |
| Volume/Cap:                             | 0.99        | 0.77 | 0.77 | 0.77        | 0.99 | 0.99 | 0.99       | 1.00 | 1.00 | 1.00       | 1.00 | 0.99 |
| Delay/Veh:                              | 105.6       | 50.0 | 50.0 | 54.8        | 64.7 | 64.7 | 143.3      | 74.8 | 74.8 | 145.7      | 71.8 | 71.8 |
| User DelAdj:                            | 1.00        | 1.00 | 1.00 | 1.00        | 1.00 | 1.00 | 1.00       | 1.00 | 1.00 | 1.00       | 1.00 | 1.00 |
| AdjDel/Veh:                             | 105.6       | 50.0 | 50.0 | 54.8        | 64.7 | 64.7 | 143.3      | 74.8 | 74.8 | 145.7      | 71.8 | 71.8 |
| LOS by Move:                            | F           | D    | D    | D           | E    | E    | F          | E    | E    | F          | E    | E    |
| HCM2k95thQ:                             | 32          | 30   | 30   | 26          | 50   | 50   | 16         | 49   | 49   | 13         | 44   | 44   |

Note: Queue reported is the number of cars per lane.

BART

Level Of Service Computation Report  
2000 HCM Operations (Future Volume Alternative)  
AM - Cumulative No Project

Intersection #3063: ALUM ROCK/JACKSON [Study Int 18]

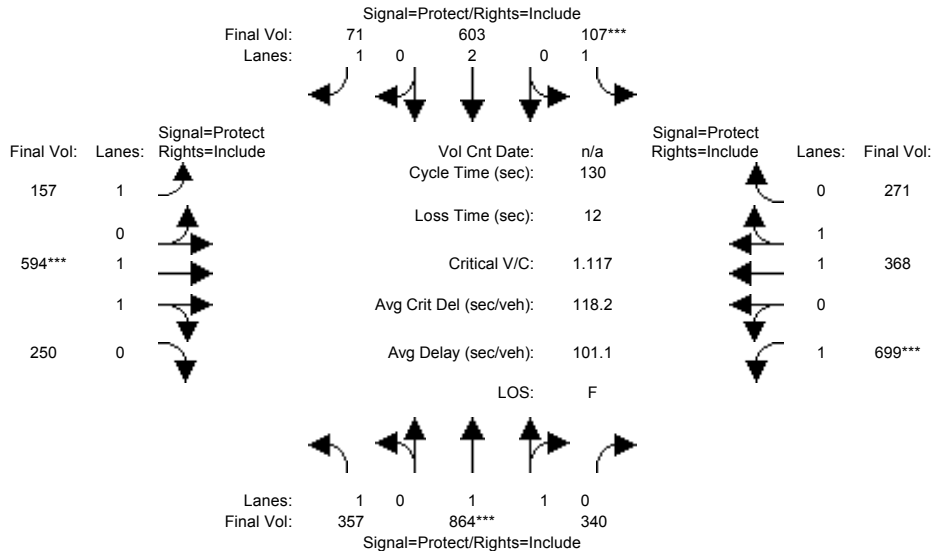

| Approach:                 | North Bound |      |       | South Bound |      |      | East Bound |      |       | West Bound |      |      |
|---------------------------|-------------|------|-------|-------------|------|------|------------|------|-------|------------|------|------|
| Movement:                 | L           | T    | R     | L           | T    | R    | L          | T    | R     | L          | T    | R    |
| Min. Green:               | 7           | 10   | 10    | 7           | 10   | 10   | 7          | 10   | 10    | 7          | 10   | 10   |
| Y+R:                      | 4.0         | 4.0  | 4.0   | 4.0         | 4.0  | 4.0  | 4.0        | 4.0  | 4.0   | 4.0        | 4.0  | 4.0  |
| Volume Module:            |             |      |       |             |      |      |            |      |       |            |      |      |
| Base Vol:                 | 357         | 864  | 340   | 107         | 603  | 71   | 157        | 594  | 250   | 699        | 368  | 271  |
| Growth Adj:               | 1.00        | 1.00 | 1.00  | 1.00        | 1.00 | 1.00 | 1.00       | 1.00 | 1.00  | 1.00       | 1.00 | 1.00 |
| Initial Bse:              | 357         | 864  | 340   | 107         | 603  | 71   | 157        | 594  | 250   | 699        | 368  | 271  |
| Added Vol:                | 0           | 0    | 0     | 0           | 0    | 0    | 0          | 0    | 0     | 0          | 0    | 0    |
| PasserByVol:              | 0           | 0    | 0     | 0           | 0    | 0    | 0          | 0    | 0     | 0          | 0    | 0    |
| Initial Fut:              | 357         | 864  | 340   | 107         | 603  | 71   | 157        | 594  | 250   | 699        | 368  | 271  |
| User Adj:                 | 1.00        | 1.00 | 1.00  | 1.00        | 1.00 | 1.00 | 1.00       | 1.00 | 1.00  | 1.00       | 1.00 | 1.00 |
| PHF Adj:                  | 1.00        | 1.00 | 1.00  | 1.00        | 1.00 | 1.00 | 1.00       | 1.00 | 1.00  | 1.00       | 1.00 | 1.00 |
| PHF Volume:               | 357         | 864  | 340   | 107         | 603  | 71   | 157        | 594  | 250   | 699        | 368  | 271  |
| Reduct Vol:               | 0           | 0    | 0     | 0           | 0    | 0    | 0          | 0    | 0     | 0          | 0    | 0    |
| Reduced Vol:              | 357         | 864  | 340   | 107         | 603  | 71   | 157        | 594  | 250   | 699        | 368  | 271  |
| PCE Adj:                  | 1.00        | 1.00 | 1.00  | 1.00        | 1.00 | 1.00 | 1.00       | 1.00 | 1.00  | 1.00       | 1.00 | 1.00 |
| MLF Adj:                  | 1.00        | 1.00 | 1.00  | 1.00        | 1.00 | 1.00 | 1.00       | 1.00 | 1.00  | 1.00       | 1.00 | 1.00 |
| FinalVolume:              | 357         | 864  | 340   | 107         | 603  | 71   | 157        | 594  | 250   | 699        | 368  | 271  |
| Saturation Flow Module:   |             |      |       |             |      |      |            |      |       |            |      |      |
| Sat/Lane:                 | 1900        | 1900 | 1900  | 1900        | 1900 | 1900 | 1900       | 1900 | 1900  | 1900       | 1900 | 1900 |
| Adjustment:               | 0.92        | 0.98 | 0.95  | 0.92        | 1.00 | 0.92 | 0.92       | 0.98 | 0.95  | 0.92       | 0.99 | 0.95 |
| Lanes:                    | 1.00        | 1.42 | 0.58  | 1.00        | 2.00 | 1.00 | 1.00       | 1.39 | 0.61  | 1.00       | 1.13 | 0.87 |
| Final Sat.:               | 1750        | 2654 | 1045  | 1750        | 3800 | 1750 | 1750       | 2603 | 1096  | 1750       | 2130 | 1568 |
| Capacity Analysis Module: |             |      |       |             |      |      |            |      |       |            |      |      |
| Vol/Sat:                  | 0.20        | 0.33 | 0.33  | 0.06        | 0.16 | 0.04 | 0.09       | 0.23 | 0.23  | 0.40       | 0.17 | 0.17 |
| Crit Moves:               | ****        | **** | ****  | ****        | **** | **** | ****       | **** | ****  | ****       | **** | **** |
| Green Time:               | 25.3        | 37.9 | 37.9  | 7.1         | 19.7 | 19.7 | 25.0       | 26.5 | 26.5  | 46.5       | 48.1 | 48.1 |
| Volume/Cap:               | 1.05        | 1.12 | 1.12  | 1.12        | 1.05 | 0.27 | 0.47       | 1.12 | 1.12  | 1.12       | 0.47 | 0.47 |
| Delay/Veh:                | 114.3       | 112  | 111.7 | 188.6       | 106  | 49.3 | 47.7       | 122  | 121.7 | 114.5      | 31.5 | 31.5 |
| User DelAdj:              | 1.00        | 1.00 | 1.00  | 1.00        | 1.00 | 1.00 | 1.00       | 1.00 | 1.00  | 1.00       | 1.00 | 1.00 |
| AdjDel/Veh:               | 114.3       | 112  | 111.7 | 188.6       | 106  | 49.3 | 47.7       | 122  | 121.7 | 114.5      | 31.5 | 31.5 |
| LOS by Move:              | F           | F    | F     | F           | F    | D    | D          | F    | F     | F          | C    | C    |
| HCM2k95thQ:               | 37          | 57   | 57    | 17          | 31   | 6    | 11         | 40   | 40    | 65         | 18   | 18   |

Note: Queue reported is the number of cars per lane.

BART

Level Of Service Computation Report  
2000 HCM Operations (Future Volume Alternative)  
PM - Cumulative No Project

Intersection #3063: ALUM ROCK/JACKSON [Study Int 18]

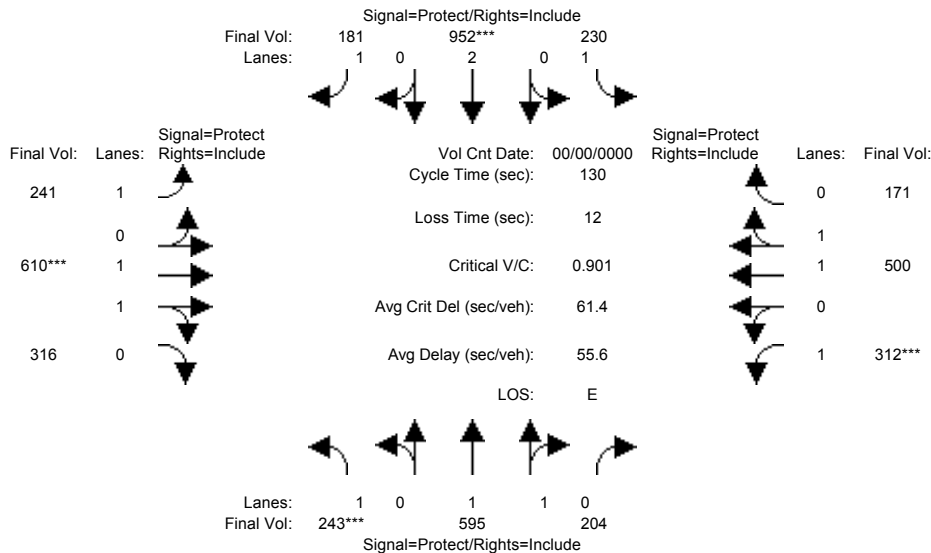

| Approach:  | North Bound |      |      | South Bound |      |      | East Bound |      |      | West Bound |      |      |
|--|-------------|------|------|-------------|------|------|------------|------|------|------------|------|------|
| Movement:  | L           | T    | R    | L           | T    | R    | L          | T    | R    | L          | T    | R    |
| Min. Green:                                      | 7           | 10   | 10   | 7           | 10   | 10   | 7          | 10   | 10   | 7          | 10   | 10   |
| Y+R:   | 4.0         | 4.0  | 4.0  | 4.0         | 4.0  | 4.0  | 4.0        | 4.0  | 4.0  | 4.0        | 4.0  | 4.0  |
| Volume Module: >> Count Date: 0 0 << 4:15-5:15PM |             |      |      |             |      |      |            |      |      |            |      |      |
| Base Vol:  | 243         | 595  | 204  | 230         | 952  | 181  | 241        | 610  | 316  | 312        | 500  | 171  |
| Growth Adj:                                      | 1.00        | 1.00 | 1.00 | 1.00        | 1.00 | 1.00 | 1.00       | 1.00 | 1.00 | 1.00       | 1.00 | 1.00 |
| Initial Bse:                                     | 243         | 595  | 204  | 230         | 952  | 181  | 241        | 610  | 316  | 312        | 500  | 171  |
| Added Vol:                                       | 0           | 0    | 0    | 0           | 0    | 0    | 0          | 0    | 0    | 0          | 0    | 0    |
| PasserByVol:                                     | 0           | 0    | 0    | 0           | 0    | 0    | 0          | 0    | 0    | 0          | 0    | 0    |
| Initial Fut:                                     | 243         | 595  | 204  | 230         | 952  | 181  | 241        | 610  | 316  | 312        | 500  | 171  |
| User Adj:  | 1.00        | 1.00 | 1.00 | 1.00        | 1.00 | 1.00 | 1.00       | 1.00 | 1.00 | 1.00       | 1.00 | 1.00 |
| PHF Adj:   | 1.00        | 1.00 | 1.00 | 1.00        | 1.00 | 1.00 | 1.00       | 1.00 | 1.00 | 1.00       | 1.00 | 1.00 |
| PHF Volume:                                      | 243         | 595  | 204  | 230         | 952  | 181  | 241        | 610  | 316  | 312        | 500  | 171  |
| Reduct Vol:                                      | 0           | 0    | 0    | 0           | 0    | 0    | 0          | 0    | 0    | 0          | 0    | 0    |
| Reduced Vol:                                     | 243         | 595  | 204  | 230         | 952  | 181  | 241        | 610  | 316  | 312        | 500  | 171  |
| PCE Adj:   | 1.00        | 1.00 | 1.00 | 1.00        | 1.00 | 1.00 | 1.00       | 1.00 | 1.00 | 1.00       | 1.00 | 1.00 |
| MLF Adj:   | 1.00        | 1.00 | 1.00 | 1.00        | 1.00 | 1.00 | 1.00       | 1.00 | 1.00 | 1.00       | 1.00 | 1.00 |
| Final Volume:                                    | 243         | 595  | 204  | 230         | 952  | 181  | 241        | 610  | 316  | 312        | 500  | 171  |
| Saturation Flow Module:                          |             |      |      |             |      |      |            |      |      |            |      |      |
| Sat/Lane:  | 1900        | 1900 | 1900 | 1900        | 1900 | 1900 | 1900       | 1900 | 1900 | 1900       | 1900 | 1900 |
| Adjustment:                                      | 0.92        | 0.98 | 0.95 | 0.92        | 1.00 | 0.92 | 0.92       | 0.99 | 0.95 | 0.92       | 0.98 | 0.95 |
| Lanes:   | 1.00        | 1.48 | 0.52 | 1.00        | 2.00 | 1.00 | 1.00       | 1.30 | 0.70 | 1.00       | 1.48 | 0.52 |
| Final Sat.:                                      | 1750        | 2755 | 944  | 1750        | 3800 | 1750 | 1750       | 2436 | 1262 | 1750       | 2756 | 943  |
| Capacity Analysis Module:                        |             |      |      |             |      |      |            |      |      |            |      |      |
| Vol/Sat:   | 0.14        | 0.22 | 0.22 | 0.13        | 0.25 | 0.10 | 0.14       | 0.25 | 0.25 | 0.18       | 0.18 | 0.18 |
| Crit Moves:                                      | ****        |      |      | ****        |      |      | ****       |      |      | ****       |      |      |
| Green Time:                                      | 20.0        | 34.9 | 34.9 | 21.2        | 36.1 | 36.1 | 26.7       | 36.1 | 36.1 | 25.7       | 35.1 | 35.1 |
| Volume/Cap:                                      | 0.90        | 0.80 | 0.80 | 0.80        | 0.90 | 0.37 | 0.67       | 0.90 | 0.90 | 0.90       | 0.67 | 0.67 |
| Delay/Veh:                                       | 84.5        | 49.2 | 49.2 | 67.5        | 55.8 | 38.3 | 52.5       | 56.0 | 56.0 | 76.3       | 44.1 | 44.1 |
| User DelAdj:                                     | 1.00        | 1.00 | 1.00 | 1.00        | 1.00 | 1.00 | 1.00       | 1.00 | 1.00 | 1.00       | 1.00 | 1.00 |
| AdjDel/Veh:                                      | 84.5        | 49.2 | 49.2 | 67.5        | 55.8 | 38.3 | 52.5       | 56.0 | 56.0 | 76.3       | 44.1 | 44.1 |
| LOS by Move:                                     | F           | D    | D    | E           | E    | D    | D          | E    | E    | E          | D    | D    |
| HCM2k95thQ:                                      | 24          | 30   | 30   | 21          | 36   | 12   | 18         | 34   | 34   | 26         | 22   | 22   |

Note: Queue reported is the number of cars per lane.

BART

Level Of Service Computation Report  
 2000 HCM Operations (Future Volume Alternative)  
 AM - Cumulative With Project

Intersection #3063: ALUM ROCK/JACKSON [Study Int 18]

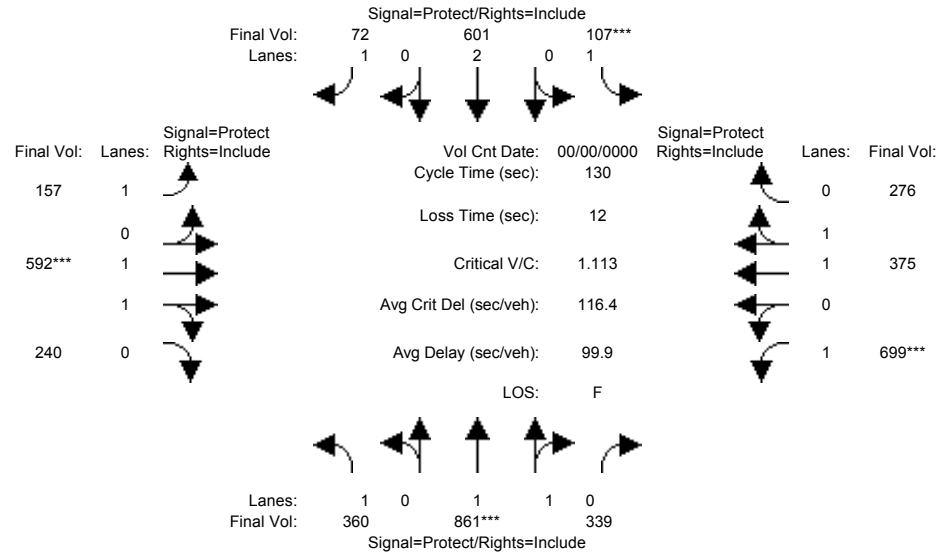

| Approach:  | North Bound |      |       | South Bound |      |      | East Bound |      |       | West Bound |      |      |
|--|-------------|------|-------|-------------|------|------|------------|------|-------|------------|------|------|
| Movement:  | L           | T    | R     | L           | T    | R    | L          | T    | R     | L          | T    | R    |
| Min. Green:                                      | 7           | 10   | 10    | 7           | 10   | 10   | 7          | 10   | 10    | 7          | 10   | 10   |
| Y+R:   | 4.0         | 4.0  | 4.0   | 4.0         | 4.0  | 4.0  | 4.0        | 4.0  | 4.0   | 4.0        | 4.0  | 4.0  |
| Volume Module: >> Count Date: 0 0 << 7:30-8:30AM |             |      |       |             |      |      |            |      |       |            |      |      |
| Base Vol:  | 360         | 861  | 339   | 107         | 601  | 72   | 157        | 592  | 240   | 699        | 375  | 276  |
| Growth Adj:                                      | 1.00        | 1.00 | 1.00  | 1.00        | 1.00 | 1.00 | 1.00       | 1.00 | 1.00  | 1.00       | 1.00 | 1.00 |
| Initial Bse:                                     | 360         | 861  | 339   | 107         | 601  | 72   | 157        | 592  | 240   | 699        | 375  | 276  |
| Added Vol:                                       | 0           | 0    | 0     | 0           | 0    | 0    | 0          | 0    | 0     | 0          | 0    | 0    |
| PasserByVol:                                     | 0           | 0    | 0     | 0           | 0    | 0    | 0          | 0    | 0     | 0          | 0    | 0    |
| Initial Fut:                                     | 360         | 861  | 339   | 107         | 601  | 72   | 157        | 592  | 240   | 699        | 375  | 276  |
| User Adj:  | 1.00        | 1.00 | 1.00  | 1.00        | 1.00 | 1.00 | 1.00       | 1.00 | 1.00  | 1.00       | 1.00 | 1.00 |
| PHF Adj:   | 1.00        | 1.00 | 1.00  | 1.00        | 1.00 | 1.00 | 1.00       | 1.00 | 1.00  | 1.00       | 1.00 | 1.00 |
| PHF Volume:                                      | 360         | 861  | 339   | 107         | 601  | 72   | 157        | 592  | 240   | 699        | 375  | 276  |
| Reduct Vol:                                      | 0           | 0    | 0     | 0           | 0    | 0    | 0          | 0    | 0     | 0          | 0    | 0    |
| Reduced Vol:                                     | 360         | 861  | 339   | 107         | 601  | 72   | 157        | 592  | 240   | 699        | 375  | 276  |
| PCE Adj:   | 1.00        | 1.00 | 1.00  | 1.00        | 1.00 | 1.00 | 1.00       | 1.00 | 1.00  | 1.00       | 1.00 | 1.00 |
| MLF Adj:   | 1.00        | 1.00 | 1.00  | 1.00        | 1.00 | 1.00 | 1.00       | 1.00 | 1.00  | 1.00       | 1.00 | 1.00 |
| Final Volume:                                    | 360         | 861  | 339   | 107         | 601  | 72   | 157        | 592  | 240   | 699        | 375  | 276  |
| Saturation Flow Module:                          |             |      |       |             |      |      |            |      |       |            |      |      |
| Sat/Lane:  | 1900        | 1900 | 1900  | 1900        | 1900 | 1900 | 1900       | 1900 | 1900  | 1900       | 1900 | 1900 |
| Adjustment:                                      | 0.92        | 0.98 | 0.95  | 0.92        | 1.00 | 0.92 | 0.92       | 0.98 | 0.95  | 0.92       | 0.99 | 0.95 |
| Lanes:   | 1.00        | 1.42 | 0.58  | 1.00        | 2.00 | 1.00 | 1.00       | 1.41 | 0.59  | 1.00       | 1.13 | 0.87 |
| Final Sat.:                                      | 1750        | 2654 | 1045  | 1750        | 3800 | 1750 | 1750       | 2632 | 1067  | 1750       | 2130 | 1568 |
| Capacity Analysis Module:                        |             |      |       |             |      |      |            |      |       |            |      |      |
| Vol/Sat:   | 0.21        | 0.32 | 0.32  | 0.06        | 0.16 | 0.04 | 0.09       | 0.22 | 0.22  | 0.40       | 0.18 | 0.18 |
| Crit Moves:                                      | ****        | **** | ****  | ****        | **** | **** | ****       | **** | ****  | ****       | **** | **** |
| Green Time:                                      | 25.5        | 37.9 | 37.9  | 7.1         | 19.6 | 19.6 | 24.6       | 26.3 | 26.3  | 46.7       | 48.3 | 48.3 |
| Volume/Cap:                                      | 1.05        | 1.11 | 1.11  | 1.11        | 1.05 | 0.27 | 0.47       | 1.11 | 1.11  | 1.11       | 0.47 | 0.47 |
| Delay/Veh:                                       | 114.6       | 110  | 109.8 | 186.8       | 107  | 49.5 | 48.0       | 120  | 120.2 | 112.6      | 31.4 | 31.4 |
| User DelAdj:                                     | 1.00        | 1.00 | 1.00  | 1.00        | 1.00 | 1.00 | 1.00       | 1.00 | 1.00  | 1.00       | 1.00 | 1.00 |
| AdjDel/Veh:                                      | 114.6       | 110  | 109.8 | 186.8       | 107  | 49.5 | 48.0       | 120  | 120.2 | 112.6      | 31.4 | 31.4 |
| LOS by Move:                                     | F           | F    | F     | F           | F    | D    | D          | F    | F     | F          | C    | C    |
| HCM2k95thQ:                                      | 37          | 57   | 57    | 16          | 31   | 6    | 11         | 40   | 40    | 65         | 18   | 18   |

Note: Queue reported is the number of cars per lane.

BART

Level Of Service Computation Report  
 2000 HCM Operations (Future Volume Alternative)  
 PM - Cumulative With Project

Intersection #3063: ALUM ROCK/JACKSON [Study Int 18]

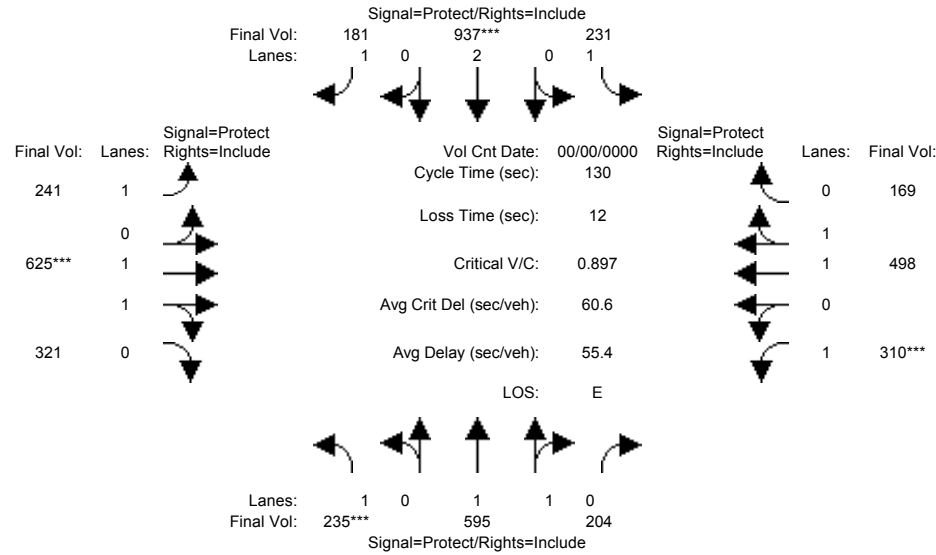

| Approach:  | North Bound |      |      | South Bound |      |      | East Bound |      |      | West Bound |      |      |
|--|-------------|------|------|-------------|------|------|------------|------|------|------------|------|------|
| Movement:  | L           | T    | R    | L           | T    | R    | L          | T    | R    | L          | T    | R    |
| Min. Green:                                      | 7           | 10   | 10   | 7           | 10   | 10   | 7          | 10   | 10   | 7          | 10   | 10   |
| Y+R:   | 4.0         | 4.0  | 4.0  | 4.0         | 4.0  | 4.0  | 4.0        | 4.0  | 4.0  | 4.0        | 4.0  | 4.0  |
| Volume Module: >> Count Date: 0 0 << 4:15-5:15PM |             |      |      |             |      |      |            |      |      |            |      |      |
| Base Vol:  | 235         | 595  | 204  | 231         | 937  | 181  | 241        | 625  | 321  | 310        | 498  | 169  |
| Growth Adj:                                      | 1.00        | 1.00 | 1.00 | 1.00        | 1.00 | 1.00 | 1.00       | 1.00 | 1.00 | 1.00       | 1.00 | 1.00 |
| Initial Bse:                                     | 235         | 595  | 204  | 231         | 937  | 181  | 241        | 625  | 321  | 310        | 498  | 169  |
| Added Vol:                                       | 0           | 0    | 0    | 0           | 0    | 0    | 0          | 0    | 0    | 0          | 0    | 0    |
| PasserByVol:                                     | 0           | 0    | 0    | 0           | 0    | 0    | 0          | 0    | 0    | 0          | 0    | 0    |
| Initial Fut:                                     | 235         | 595  | 204  | 231         | 937  | 181  | 241        | 625  | 321  | 310        | 498  | 169  |
| User Adj:  | 1.00        | 1.00 | 1.00 | 1.00        | 1.00 | 1.00 | 1.00       | 1.00 | 1.00 | 1.00       | 1.00 | 1.00 |
| PHF Adj:   | 1.00        | 1.00 | 1.00 | 1.00        | 1.00 | 1.00 | 1.00       | 1.00 | 1.00 | 1.00       | 1.00 | 1.00 |
| PHF Volume:                                      | 235         | 595  | 204  | 231         | 937  | 181  | 241        | 625  | 321  | 310        | 498  | 169  |
| Reduct Vol:                                      | 0           | 0    | 0    | 0           | 0    | 0    | 0          | 0    | 0    | 0          | 0    | 0    |
| Reduced Vol:                                     | 235         | 595  | 204  | 231         | 937  | 181  | 241        | 625  | 321  | 310        | 498  | 169  |
| PCE Adj:   | 1.00        | 1.00 | 1.00 | 1.00        | 1.00 | 1.00 | 1.00       | 1.00 | 1.00 | 1.00       | 1.00 | 1.00 |
| MLF Adj:   | 1.00        | 1.00 | 1.00 | 1.00        | 1.00 | 1.00 | 1.00       | 1.00 | 1.00 | 1.00       | 1.00 | 1.00 |
| Final Volume:                                    | 235         | 595  | 204  | 231         | 937  | 181  | 241        | 625  | 321  | 310        | 498  | 169  |
| Saturation Flow Module:                          |             |      |      |             |      |      |            |      |      |            |      |      |
| Sat/Lane:  | 1900        | 1900 | 1900 | 1900        | 1900 | 1900 | 1900       | 1900 | 1900 | 1900       | 1900 | 1900 |
| Adjustment:                                      | 0.92        | 0.98 | 0.95 | 0.92        | 1.00 | 0.92 | 0.92       | 0.99 | 0.95 | 0.92       | 0.98 | 0.95 |
| Lanes:   | 1.00        | 1.48 | 0.52 | 1.00        | 2.00 | 1.00 | 1.00       | 1.30 | 0.70 | 1.00       | 1.48 | 0.52 |
| Final Sat.:                                      | 1750        | 2755 | 944  | 1750        | 3800 | 1750 | 1750       | 2444 | 1255 | 1750       | 2762 | 937  |
| Capacity Analysis Module:                        |             |      |      |             |      |      |            |      |      |            |      |      |
| Vol/Sat:   | 0.13        | 0.22 | 0.22 | 0.13        | 0.25 | 0.10 | 0.14       | 0.26 | 0.26 | 0.18       | 0.18 | 0.18 |
| Crit Moves:                                      | ****        |      |      | ****        |      |      | ****       |      |      | ****       |      |      |
| Green Time:                                      | 19.5        | 34.3 | 34.3 | 20.9        | 35.8 | 35.8 | 27.2       | 37.1 | 37.1 | 25.7       | 35.6 | 35.6 |
| Volume/Cap:                                      | 0.90        | 0.82 | 0.82 | 0.82        | 0.90 | 0.38 | 0.66       | 0.90 | 0.90 | 0.90       | 0.66 | 0.66 |
| Delay/Veh:                                       | 84.4        | 50.5 | 50.5 | 69.7        | 55.6 | 38.6 | 51.5       | 54.7 | 54.7 | 75.5       | 43.4 | 43.4 |
| User DelAdj:                                     | 1.00        | 1.00 | 1.00 | 1.00        | 1.00 | 1.00 | 1.00       | 1.00 | 1.00 | 1.00       | 1.00 | 1.00 |
| AdjDel/Veh:                                      | 84.4        | 50.5 | 50.5 | 69.7        | 55.6 | 38.6 | 51.5       | 54.7 | 54.7 | 75.5       | 43.4 | 43.4 |
| LOS by Move:                                     | F           | D    | D    | E           | E    | D    | D          | D    | D    | E          | D    | D    |
| HCM2k95thQ:                                      | 24          | 30   | 30   | 21          | 36   | 12   | 18         | 34   | 34   | 25         | 22   | 22   |

Note: Queue reported is the number of cars per lane.

BART

Level Of Service Computation Report  
 2000 HCM Operations (Future Volume Alternative)  
 AM - Cumulative No Project

Intersection #3064: ALUM ROCK/KING [Study Int 17]

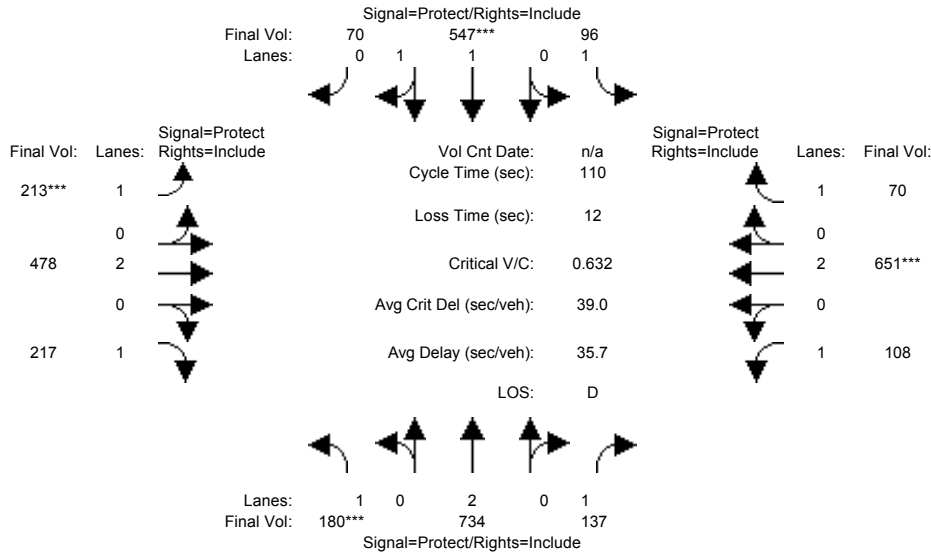

| Approach:                 | North Bound |      |      | South Bound |      |      | East Bound |      |      | West Bound |      |      |
|---------------------------|-------------|------|------|-------------|------|------|------------|------|------|------------|------|------|
| Movement:                 | L           | T    | R    | L           | T    | R    | L          | T    | R    | L          | T    | R    |
| Min. Green:               | 7           | 10   | 10   | 7           | 10   | 10   | 7          | 10   | 10   | 7          | 10   | 10   |
| Y+R:                      | 4.0         | 4.0  | 4.0  | 4.0         | 4.0  | 4.0  | 4.0        | 4.0  | 4.0  | 4.0        | 4.0  | 4.0  |
| Volume Module:            |             |      |      |             |      |      |            |      |      |            |      |      |
| Base Vol:                 | 180         | 734  | 137  | 96          | 547  | 70   | 213        | 478  | 217  | 108        | 651  | 70   |
| Growth Adj:               | 1.00        | 1.00 | 1.00 | 1.00        | 1.00 | 1.00 | 1.00       | 1.00 | 1.00 | 1.00       | 1.00 | 1.00 |
| Initial Bse:              | 180         | 734  | 137  | 96          | 547  | 70   | 213        | 478  | 217  | 108        | 651  | 70   |
| Added Vol:                | 0           | 0    | 0    | 0           | 0    | 0    | 0          | 0    | 0    | 0          | 0    | 0    |
| PasserByVol:              | 0           | 0    | 0    | 0           | 0    | 0    | 0          | 0    | 0    | 0          | 0    | 0    |
| Initial Fut:              | 180         | 734  | 137  | 96          | 547  | 70   | 213        | 478  | 217  | 108        | 651  | 70   |
| User Adj:                 | 1.00        | 1.00 | 1.00 | 1.00        | 1.00 | 1.00 | 1.00       | 1.00 | 1.00 | 1.00       | 1.00 | 1.00 |
| PHF Adj:                  | 1.00        | 1.00 | 1.00 | 1.00        | 1.00 | 1.00 | 1.00       | 1.00 | 1.00 | 1.00       | 1.00 | 1.00 |
| PHF Volume:               | 180         | 734  | 137  | 96          | 547  | 70   | 213        | 478  | 217  | 108        | 651  | 70   |
| Reduct Vol:               | 0           | 0    | 0    | 0           | 0    | 0    | 0          | 0    | 0    | 0          | 0    | 0    |
| Reduced Vol:              | 180         | 734  | 137  | 96          | 547  | 70   | 213        | 478  | 217  | 108        | 651  | 70   |
| PCE Adj:                  | 1.00        | 1.00 | 1.00 | 1.00        | 1.00 | 1.00 | 1.00       | 1.00 | 1.00 | 1.00       | 1.00 | 1.00 |
| MLF Adj:                  | 1.00        | 1.00 | 1.00 | 1.00        | 1.00 | 1.00 | 1.00       | 1.00 | 1.00 | 1.00       | 1.00 | 1.00 |
| Final Volume:             | 180         | 734  | 137  | 96          | 547  | 70   | 213        | 478  | 217  | 108        | 651  | 70   |
| Saturation Flow Module:   |             |      |      |             |      |      |            |      |      |            |      |      |
| Sat/Lane:                 | 1900        | 1900 | 1900 | 1900        | 1900 | 1900 | 1900       | 1900 | 1900 | 1900       | 1900 | 1900 |
| Adjustment:               | 0.92        | 1.00 | 0.92 | 0.92        | 0.98 | 0.95 | 0.92       | 1.00 | 0.92 | 0.92       | 1.00 | 0.92 |
| Lanes:                    | 1.00        | 2.00 | 1.00 | 1.00        | 1.77 | 0.23 | 1.00       | 2.00 | 1.00 | 1.00       | 2.00 | 1.00 |
| Final Sat.:               | 1750        | 3800 | 1750 | 1750        | 3280 | 420  | 1750       | 3800 | 1750 | 1750       | 3800 | 1750 |
| Capacity Analysis Module: |             |      |      |             |      |      |            |      |      |            |      |      |
| Vol/Sat:                  | 0.10        | 0.19 | 0.08 | 0.05        | 0.17 | 0.17 | 0.12       | 0.13 | 0.12 | 0.06       | 0.17 | 0.04 |
| Crit Moves:               | ****        |      |      | ****        |      |      | ****       |      |      | ****       |      |      |
| Green Time:               | 17.9        | 35.3 | 35.3 | 11.6        | 29.0 | 29.0 | 21.2       | 33.9 | 33.9 | 17.1       | 29.8 | 29.8 |
| Volume/Cap:               | 0.63        | 0.60 | 0.24 | 0.52        | 0.63 | 0.63 | 0.63       | 0.41 | 0.40 | 0.40       | 0.63 | 0.15 |
| Delay/Veh:                | 47.5        | 32.3 | 27.7 | 49.1        | 37.1 | 37.1 | 44.7       | 30.4 | 30.5 | 42.7       | 36.5 | 30.6 |
| User DelAdj:              | 1.00        | 1.00 | 1.00 | 1.00        | 1.00 | 1.00 | 1.00       | 1.00 | 1.00 | 1.00       | 1.00 | 1.00 |
| AdjDel/Veh:               | 47.5        | 32.3 | 27.7 | 49.1        | 37.1 | 37.1 | 44.7       | 30.4 | 30.5 | 42.7       | 36.5 | 30.6 |
| LOS by Move:              | D           | C    | C    | D           | D    | D    | D          | C    | C    | D          | D    | C    |
| HCM2k95thQ:               | 12          | 19   | 7    | 7           | 17   | 17   | 14         | 12   | 12   | 8          | 19   | 4    |

Note: Queue reported is the number of cars per lane.



BART

Level Of Service Computation Report  
 2000 HCM Operations (Future Volume Alternative)  
 PM - Cumulative No Project

Intersection #3064: ALUM ROCK/KING [Study Int 17]

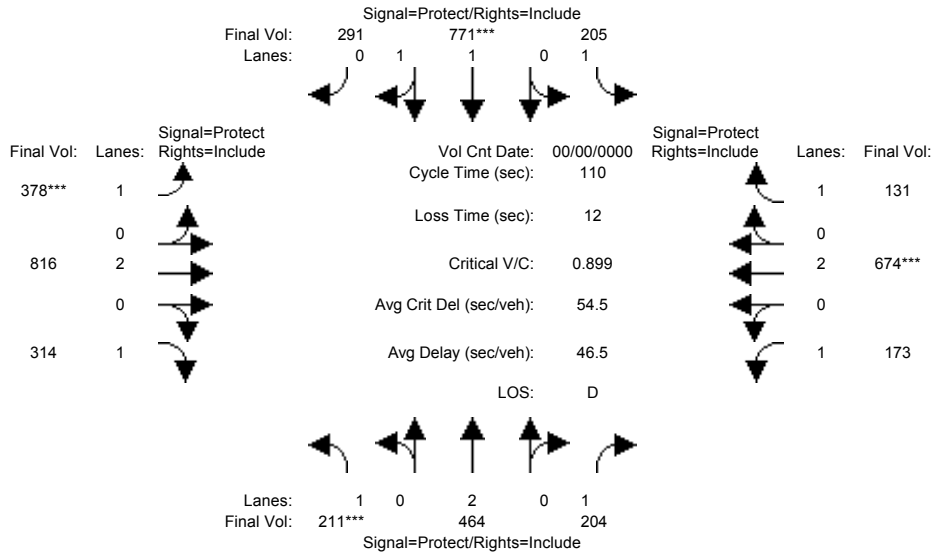

| Approach:                            | North Bound |      |      | South Bound |      |      | East Bound |      |      | West Bound |      |      |
|--------------------------------------|-------------|------|------|-------------|------|------|------------|------|------|------------|------|------|
| Movement:                            | L           | T    | R    | L           | T    | R    | L          | T    | R    | L          | T    | R    |
| Min. Green:                          | 7           | 10   | 10   | 7           | 10   | 10   | 7          | 10   | 10   | 7          | 10   | 10   |
| Y+R:                                 | 4.0         | 4.0  | 4.0  | 4.0         | 4.0  | 4.0  | 4.0        | 4.0  | 4.0  | 4.0        | 4.0  | 4.0  |
| Volume Module: >> Count Date: 0 0 << |             |      |      |             |      |      |            |      |      |            |      |      |
| Base Vol:                            | 211         | 464  | 204  | 205         | 771  | 291  | 378        | 816  | 314  | 173        | 674  | 131  |
| Growth Adj:                          | 1.00        | 1.00 | 1.00 | 1.00        | 1.00 | 1.00 | 1.00       | 1.00 | 1.00 | 1.00       | 1.00 | 1.00 |
| Initial Bse:                         | 211         | 464  | 204  | 205         | 771  | 291  | 378        | 816  | 314  | 173        | 674  | 131  |
| Added Vol:                           | 0           | 0    | 0    | 0           | 0    | 0    | 0          | 0    | 0    | 0          | 0    | 0    |
| PasserByVol:                         | 0           | 0    | 0    | 0           | 0    | 0    | 0          | 0    | 0    | 0          | 0    | 0    |
| Initial Fut:                         | 211         | 464  | 204  | 205         | 771  | 291  | 378        | 816  | 314  | 173        | 674  | 131  |
| User Adj:                            | 1.00        | 1.00 | 1.00 | 1.00        | 1.00 | 1.00 | 1.00       | 1.00 | 1.00 | 1.00       | 1.00 | 1.00 |
| PHF Adj:                             | 1.00        | 1.00 | 1.00 | 1.00        | 1.00 | 1.00 | 1.00       | 1.00 | 1.00 | 1.00       | 1.00 | 1.00 |
| PHF Volume:                          | 211         | 464  | 204  | 205         | 771  | 291  | 378        | 816  | 314  | 173        | 674  | 131  |
| Reduct Vol:                          | 0           | 0    | 0    | 0           | 0    | 0    | 0          | 0    | 0    | 0          | 0    | 0    |
| Reduced Vol:                         | 211         | 464  | 204  | 205         | 771  | 291  | 378        | 816  | 314  | 173        | 674  | 131  |
| PCE Adj:                             | 1.00        | 1.00 | 1.00 | 1.00        | 1.00 | 1.00 | 1.00       | 1.00 | 1.00 | 1.00       | 1.00 | 1.00 |
| MLF Adj:                             | 1.00        | 1.00 | 1.00 | 1.00        | 1.00 | 1.00 | 1.00       | 1.00 | 1.00 | 1.00       | 1.00 | 1.00 |
| Final Volume:                        | 211         | 464  | 204  | 205         | 771  | 291  | 378        | 816  | 314  | 173        | 674  | 131  |
| Saturation Flow Module:              |             |      |      |             |      |      |            |      |      |            |      |      |
| Sat/Lane:                            | 1900        | 1900 | 1900 | 1900        | 1900 | 1900 | 1900       | 1900 | 1900 | 1900       | 1900 | 1900 |
| Adjustment:                          | 0.92        | 1.00 | 0.92 | 0.92        | 0.98 | 0.95 | 0.92       | 1.00 | 0.92 | 0.92       | 1.00 | 0.92 |
| Lanes:                               | 1.00        | 2.00 | 1.00 | 1.00        | 1.44 | 0.56 | 1.00       | 2.00 | 1.00 | 1.00       | 2.00 | 1.00 |
| Final Sat.:                          | 1750        | 3800 | 1750 | 1750        | 2685 | 1014 | 1750       | 3800 | 1750 | 1750       | 3800 | 1750 |
| Capacity Analysis Module:            |             |      |      |             |      |      |            |      |      |            |      |      |
| Vol/Sat:                             | 0.12        | 0.12 | 0.12 | 0.12        | 0.29 | 0.29 | 0.22       | 0.21 | 0.18 | 0.10       | 0.18 | 0.07 |
| Crit Moves:                          | ****        |      |      | ****        |      |      | ****       |      |      | ****       |      |      |
| Green Time:                          | 14.8        | 25.5 | 25.5 | 24.4        | 35.1 | 35.1 | 26.4       | 33.0 | 33.0 | 15.2       | 21.7 | 21.7 |
| Volume/Cap:                          | 0.90        | 0.53 | 0.50 | 0.53        | 0.90 | 0.90 | 0.90       | 0.72 | 0.60 | 0.72       | 0.90 | 0.38 |
| Delay/Veh:                           | 80.0        | 37.6 | 37.8 | 39.1        | 45.2 | 45.2 | 62.2       | 36.6 | 34.8 | 55.2       | 56.9 | 39.0 |
| User DelAdj:                         | 1.00        | 1.00 | 1.00 | 1.00        | 1.00 | 1.00 | 1.00       | 1.00 | 1.00 | 1.00       | 1.00 | 1.00 |
| AdjDel/Veh:                          | 80.0        | 37.6 | 37.8 | 39.1        | 45.2 | 45.2 | 62.2       | 36.6 | 34.8 | 55.2       | 56.9 | 39.0 |
| LOS by Move:                         | F           | D    | D    | D           | D    | D    | E          | D    | C    | E          | E    | D    |
| HCM2k95thQ:                          | 16          | 13   | 12   | 12          | 33   | 33   | 26         | 22   | 18   | 14         | 26   | 9    |

Note: Queue reported is the number of cars per lane.

BART

Level Of Service Computation Report  
 2000 HCM Operations (Future Volume Alternative)  
 AM - Cumulative With Project

Intersection #3064: ALUM ROCK/KING [Study Int 17]

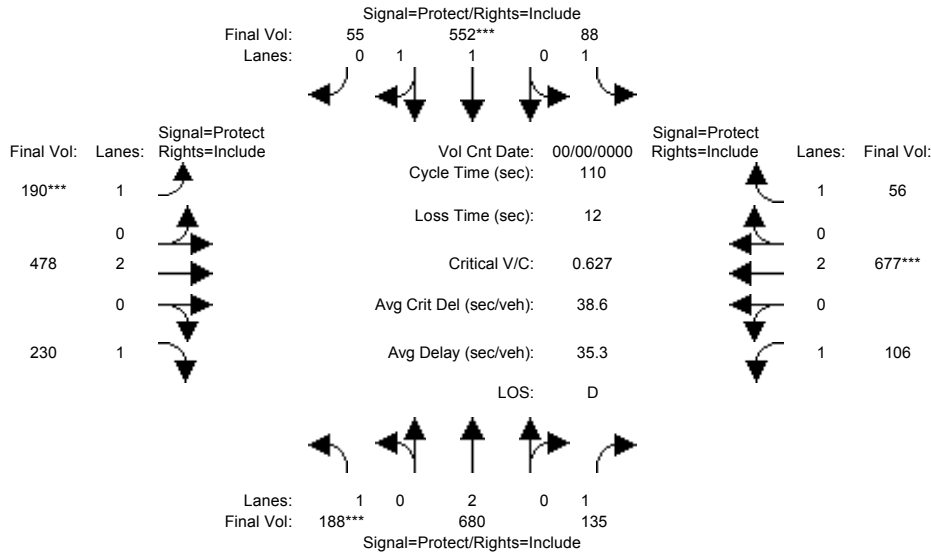

| Approach:                            | North Bound |      |      | South Bound |      |      | East Bound |      |      | West Bound |      |      |
|--------------------------------------|-------------|------|------|-------------|------|------|------------|------|------|------------|------|------|
| Movement:                            | L           | T    | R    | L           | T    | R    | L          | T    | R    | L          | T    | R    |
| Min. Green:                          | 7           | 10   | 10   | 7           | 10   | 10   | 7          | 10   | 10   | 7          | 10   | 10   |
| Y+R:                                 | 4.0         | 4.0  | 4.0  | 4.0         | 4.0  | 4.0  | 4.0        | 4.0  | 4.0  | 4.0        | 4.0  | 4.0  |
| Volume Module: >> Count Date: 0 0 << |             |      |      |             |      |      |            |      |      |            |      |      |
| Base Vol:                            | 188         | 680  | 135  | 88          | 552  | 55   | 190        | 478  | 230  | 106        | 677  | 56   |
| Growth Adj:                          | 1.00        | 1.00 | 1.00 | 1.00        | 1.00 | 1.00 | 1.00       | 1.00 | 1.00 | 1.00       | 1.00 | 1.00 |
| Initial Bse:                         | 188         | 680  | 135  | 88          | 552  | 55   | 190        | 478  | 230  | 106        | 677  | 56   |
| Added Vol:                           | 0           | 0    | 0    | 0           | 0    | 0    | 0          | 0    | 0    | 0          | 0    | 0    |
| PasserByVol:                         | 0           | 0    | 0    | 0           | 0    | 0    | 0          | 0    | 0    | 0          | 0    | 0    |
| Initial Fut:                         | 188         | 680  | 135  | 88          | 552  | 55   | 190        | 478  | 230  | 106        | 677  | 56   |
| User Adj:                            | 1.00        | 1.00 | 1.00 | 1.00        | 1.00 | 1.00 | 1.00       | 1.00 | 1.00 | 1.00       | 1.00 | 1.00 |
| PHF Adj:                             | 1.00        | 1.00 | 1.00 | 1.00        | 1.00 | 1.00 | 1.00       | 1.00 | 1.00 | 1.00       | 1.00 | 1.00 |
| PHF Volume:                          | 188         | 680  | 135  | 88          | 552  | 55   | 190        | 478  | 230  | 106        | 677  | 56   |
| Reduct Vol:                          | 0           | 0    | 0    | 0           | 0    | 0    | 0          | 0    | 0    | 0          | 0    | 0    |
| Reduced Vol:                         | 188         | 680  | 135  | 88          | 552  | 55   | 190        | 478  | 230  | 106        | 677  | 56   |
| PCE Adj:                             | 1.00        | 1.00 | 1.00 | 1.00        | 1.00 | 1.00 | 1.00       | 1.00 | 1.00 | 1.00       | 1.00 | 1.00 |
| MLF Adj:                             | 1.00        | 1.00 | 1.00 | 1.00        | 1.00 | 1.00 | 1.00       | 1.00 | 1.00 | 1.00       | 1.00 | 1.00 |
| Final Volume:                        | 188         | 680  | 135  | 88          | 552  | 55   | 190        | 478  | 230  | 106        | 677  | 56   |
| Saturation Flow Module:              |             |      |      |             |      |      |            |      |      |            |      |      |
| Sat/Lane:                            | 1900        | 1900 | 1900 | 1900        | 1900 | 1900 | 1900       | 1900 | 1900 | 1900       | 1900 | 1900 |
| Adjustment:                          | 0.92        | 1.00 | 0.92 | 0.92        | 0.98 | 0.95 | 0.92       | 1.00 | 0.92 | 0.92       | 1.00 | 0.92 |
| Lanes:                               | 1.00        | 2.00 | 1.00 | 1.00        | 1.81 | 0.19 | 1.00       | 2.00 | 1.00 | 1.00       | 2.00 | 1.00 |
| Final Sat.:                          | 1750        | 3800 | 1750 | 1750        | 3364 | 335  | 1750       | 3800 | 1750 | 1750       | 3800 | 1750 |
| Capacity Analysis Module:            |             |      |      |             |      |      |            |      |      |            |      |      |
| Vol/Sat:                             | 0.11        | 0.18 | 0.08 | 0.05        | 0.16 | 0.16 | 0.11       | 0.13 | 0.13 | 0.06       | 0.18 | 0.03 |
| Crit Moves:                          | ****        |      |      | ****        |      |      | ****       |      |      | ****       |      |      |
| Green Time:                          | 18.9        | 35.2 | 35.2 | 12.5        | 28.8 | 28.8 | 19.1       | 33.9 | 33.9 | 16.4       | 31.3 | 31.3 |
| Volume/Cap:                          | 0.63        | 0.56 | 0.24 | 0.44        | 0.63 | 0.63 | 0.63       | 0.41 | 0.43 | 0.41       | 0.63 | 0.11 |
| Delay/Veh:                           | 46.5        | 31.6 | 27.8 | 47.1        | 37.2 | 37.2 | 46.3       | 30.3 | 30.8 | 43.4       | 35.4 | 29.2 |
| User DelAdj:                         | 1.00        | 1.00 | 1.00 | 1.00        | 1.00 | 1.00 | 1.00       | 1.00 | 1.00 | 1.00       | 1.00 | 1.00 |
| AdjDel/Veh:                          | 46.5        | 31.6 | 27.8 | 47.1        | 37.2 | 37.2 | 46.3       | 30.3 | 30.8 | 43.4       | 35.4 | 29.2 |
| LOS by Move:                         | D           | C    | C    | D           | D    | D    | D          | C    | C    | D          | D    | C    |
| HCM2k95thQ:                          | 12          | 17   | 7    | 6           | 17   | 17   | 12         | 12   | 12   | 8          | 19   | 3    |

Note: Queue reported is the number of cars per lane.

BART

Level Of Service Computation Report  
 2000 HCM Operations (Future Volume Alternative)  
 PM - Cumulative With Project

Intersection #3064: ALUM ROCK/KING [Study Int 17]

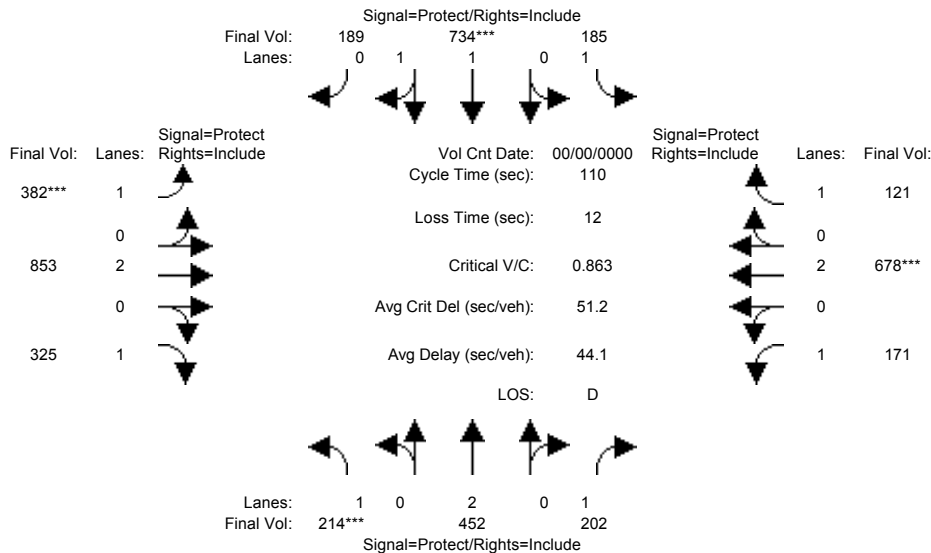

| Approach:                            | North Bound |      |      | South Bound |      |      | East Bound |      |      | West Bound |      |      |
|--------------------------------------|-------------|------|------|-------------|------|------|------------|------|------|------------|------|------|
| Movement:                            | L           | T    | R    | L           | T    | R    | L          | T    | R    | L          | T    | R    |
| Min. Green:                          | 7           | 10   | 10   | 7           | 10   | 10   | 7          | 10   | 10   | 7          | 10   | 10   |
| Y+R:                                 | 4.0         | 4.0  | 4.0  | 4.0         | 4.0  | 4.0  | 4.0        | 4.0  | 4.0  | 4.0        | 4.0  | 4.0  |
| Volume Module: >> Count Date: 0 0 << |             |      |      |             |      |      |            |      |      |            |      |      |
| Base Vol:                            | 214         | 452  | 202  | 185         | 734  | 189  | 382        | 853  | 325  | 171        | 678  | 121  |
| Growth Adj:                          | 1.00        | 1.00 | 1.00 | 1.00        | 1.00 | 1.00 | 1.00       | 1.00 | 1.00 | 1.00       | 1.00 | 1.00 |
| Initial Bse:                         | 214         | 452  | 202  | 185         | 734  | 189  | 382        | 853  | 325  | 171        | 678  | 121  |
| Added Vol:                           | 0           | 0    | 0    | 0           | 0    | 0    | 0          | 0    | 0    | 0          | 0    | 0    |
| PasserByVol:                         | 0           | 0    | 0    | 0           | 0    | 0    | 0          | 0    | 0    | 0          | 0    | 0    |
| Initial Fut:                         | 214         | 452  | 202  | 185         | 734  | 189  | 382        | 853  | 325  | 171        | 678  | 121  |
| User Adj:                            | 1.00        | 1.00 | 1.00 | 1.00        | 1.00 | 1.00 | 1.00       | 1.00 | 1.00 | 1.00       | 1.00 | 1.00 |
| PHF Adj:                             | 1.00        | 1.00 | 1.00 | 1.00        | 1.00 | 1.00 | 1.00       | 1.00 | 1.00 | 1.00       | 1.00 | 1.00 |
| PHF Volume:                          | 214         | 452  | 202  | 185         | 734  | 189  | 382        | 853  | 325  | 171        | 678  | 121  |
| Reduct Vol:                          | 0           | 0    | 0    | 0           | 0    | 0    | 0          | 0    | 0    | 0          | 0    | 0    |
| Reduced Vol:                         | 214         | 452  | 202  | 185         | 734  | 189  | 382        | 853  | 325  | 171        | 678  | 121  |
| PCE Adj:                             | 1.00        | 1.00 | 1.00 | 1.00        | 1.00 | 1.00 | 1.00       | 1.00 | 1.00 | 1.00       | 1.00 | 1.00 |
| MLF Adj:                             | 1.00        | 1.00 | 1.00 | 1.00        | 1.00 | 1.00 | 1.00       | 1.00 | 1.00 | 1.00       | 1.00 | 1.00 |
| Final Volume:                        | 214         | 452  | 202  | 185         | 734  | 189  | 382        | 853  | 325  | 171        | 678  | 121  |
| Saturation Flow Module:              |             |      |      |             |      |      |            |      |      |            |      |      |
| Sat/Lane:                            | 1900        | 1900 | 1900 | 1900        | 1900 | 1900 | 1900       | 1900 | 1900 | 1900       | 1900 | 1900 |
| Adjustment:                          | 0.92        | 1.00 | 0.92 | 0.92        | 0.98 | 0.95 | 0.92       | 1.00 | 0.92 | 0.92       | 1.00 | 0.92 |
| Lanes:                               | 1.00        | 2.00 | 1.00 | 1.00        | 1.58 | 0.42 | 1.00       | 2.00 | 1.00 | 1.00       | 2.00 | 1.00 |
| Final Sat.:                          | 1750        | 3800 | 1750 | 1750        | 2942 | 757  | 1750       | 3800 | 1750 | 1750       | 3800 | 1750 |
| Capacity Analysis Module:            |             |      |      |             |      |      |            |      |      |            |      |      |
| Vol/Sat:                             | 0.12        | 0.12 | 0.12 | 0.11        | 0.25 | 0.25 | 0.22       | 0.22 | 0.19 | 0.10       | 0.18 | 0.07 |
| Crit Moves:                          | ****        |      |      | ****        |      |      | ****       |      |      | ****       |      |      |
| Green Time:                          | 15.6        | 25.1 | 25.1 | 22.3        | 31.8 | 31.8 | 27.8       | 35.2 | 35.2 | 15.3       | 22.8 | 22.8 |
| Volume/Cap:                          | 0.86        | 0.52 | 0.51 | 0.52        | 0.86 | 0.86 | 0.86       | 0.70 | 0.58 | 0.70       | 0.86 | 0.33 |
| Delay/Veh:                           | 71.4        | 37.8 | 38.1 | 40.5        | 44.4 | 44.4 | 55.1       | 34.6 | 32.7 | 53.9       | 51.8 | 37.7 |
| User DelAdj:                         | 1.00        | 1.00 | 1.00 | 1.00        | 1.00 | 1.00 | 1.00       | 1.00 | 1.00 | 1.00       | 1.00 | 1.00 |
| AdjDel/Veh:                          | 71.4        | 37.8 | 38.1 | 40.5        | 44.4 | 44.4 | 55.1       | 34.6 | 32.7 | 53.9       | 51.8 | 37.7 |
| LOS by Move:                         | E           | D    | D    | D           | D    | D    | E          | C    | C    | D          | D    | D    |
| HCM2k95thQ:                          | 16          | 13   | 12   | 11          | 29   | 29   | 26         | 23   | 18   | 14         | 25   | 8    |

Note: Queue reported is the number of cars per lane.

BART

Level Of Service Computation Report  
 2000 HCM Operations (Future Volume Alternative)  
 AM - Cumulative No Project

Intersection #3210: 101/Julian-McKee (W) [Study Int 4]

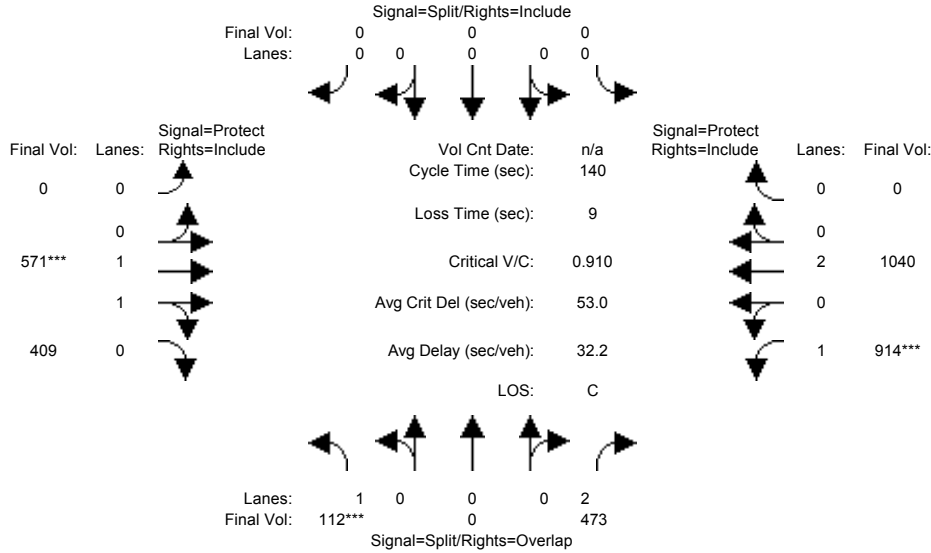

| Approach:                 | North Bound |      |      | South Bound |      |      | East Bound |      |      | West Bound |      |      |
|---------------------------|-------------|------|------|-------------|------|------|------------|------|------|------------|------|------|
| Movement:                 | L           | T    | R    | L           | T    | R    | L          | T    | R    | L          | T    | R    |
| Min. Green:               | 10          | 0    | 10   | 0           | 0    | 0    | 0          | 10   | 10   | 7          | 10   | 0    |
| Y+R:                      | 4.0         | 4.0  | 4.0  | 4.0         | 4.0  | 4.0  | 4.0        | 4.0  | 4.0  | 4.0        | 4.0  | 0    |
| Volume Module:            |             |      |      |             |      |      |            |      |      |            |      |      |
| Base Vol:                 | 112         | 0    | 473  | 0           | 0    | 0    | 0          | 571  | 409  | 914        | 1040 | 0    |
| Growth Adj:               | 1.00        | 1.00 | 1.00 | 1.00        | 1.00 | 1.00 | 1.00       | 1.00 | 1.00 | 1.00       | 1.00 | 1.00 |
| Initial Bse:              | 112         | 0    | 473  | 0           | 0    | 0    | 0          | 571  | 409  | 914        | 1040 | 0    |
| Added Vol:                | 0           | 0    | 0    | 0           | 0    | 0    | 0          | 0    | 0    | 0          | 0    | 0    |
| PasserByVol:              | 0           | 0    | 0    | 0           | 0    | 0    | 0          | 0    | 0    | 0          | 0    | 0    |
| Initial Fut:              | 112         | 0    | 473  | 0           | 0    | 0    | 0          | 571  | 409  | 914        | 1040 | 0    |
| User Adj:                 | 1.00        | 1.00 | 1.00 | 1.00        | 1.00 | 1.00 | 1.00       | 1.00 | 1.00 | 1.00       | 1.00 | 1.00 |
| PHF Adj:                  | 1.00        | 1.00 | 1.00 | 1.00        | 1.00 | 1.00 | 1.00       | 1.00 | 1.00 | 1.00       | 1.00 | 1.00 |
| PHF Volume:               | 112         | 0    | 473  | 0           | 0    | 0    | 0          | 571  | 409  | 914        | 1040 | 0    |
| Reduct Vol:               | 0           | 0    | 0    | 0           | 0    | 0    | 0          | 0    | 0    | 0          | 0    | 0    |
| Reduced Vol:              | 112         | 0    | 473  | 0           | 0    | 0    | 0          | 571  | 409  | 914        | 1040 | 0    |
| PCE Adj:                  | 1.00        | 1.00 | 1.00 | 1.00        | 1.00 | 1.00 | 1.00       | 1.00 | 1.00 | 1.00       | 1.00 | 1.00 |
| MLF Adj:                  | 1.00        | 1.00 | 1.00 | 1.00        | 1.00 | 1.00 | 1.00       | 1.00 | 1.00 | 1.00       | 1.00 | 1.00 |
| FinalVolume:              | 112         | 0    | 473  | 0           | 0    | 0    | 0          | 571  | 409  | 914        | 1040 | 0    |
| Saturation Flow Module:   |             |      |      |             |      |      |            |      |      |            |      |      |
| Sat/Lane:                 | 1900        | 1900 | 1900 | 1900        | 1900 | 1900 | 1900       | 1900 | 1900 | 1900       | 1900 | 1900 |
| Adjustment:               | 0.92        | 1.00 | 0.83 | 0.92        | 1.00 | 0.92 | 0.92       | 0.99 | 0.95 | 0.92       | 1.00 | 0.92 |
| Lanes:                    | 1.00        | 0.00 | 2.00 | 0.00        | 0.00 | 0.00 | 0.00       | 1.14 | 0.86 | 1.00       | 2.00 | 0.00 |
| Final Sat.:               | 1750        | 0    | 3150 | 0           | 0    | 0    | 0          | 2155 | 1543 | 1750       | 3800 | 0    |
| Capacity Analysis Module: |             |      |      |             |      |      |            |      |      |            |      |      |
| Vol/Sat:                  | 0.06        | 0.00 | 0.15 | 0.00        | 0.00 | 0.00 | 0.00       | 0.27 | 0.27 | 0.52       | 0.27 | 0.00 |
| Crit Moves:               | ****        |      |      |             |      |      | ****       |      |      | ****       |      |      |
| Green Time:               | 10.0        | 0.0  | 90.3 | 0.0         | 0.0  | 0.0  | 0.0        | 40.7 | 40.7 | 80.3       | 121  | 0.0  |
| Volume/Cap:               | 0.90        | 0.00 | 0.23 | 0.00        | 0.00 | 0.00 | 0.00       | 0.91 | 0.91 | 0.91       | 0.32 | 0.00 |
| Delay/Veh:                | 114.5       | 0.0  | 10.5 | 0.0         | 0.0  | 0.0  | 0.0        | 59.3 | 59.3 | 38.8       | 1.8  | 0.0  |
| User DelAdj:              | 1.00        | 1.00 | 1.00 | 1.00        | 1.00 | 1.00 | 1.00       | 1.00 | 1.00 | 1.00       | 1.00 | 1.00 |
| AdjDel/Veh:               | 114.5       | 0.0  | 10.5 | 0.0         | 0.0  | 0.0  | 0.0        | 59.3 | 59.3 | 38.8       | 1.8  | 0.0  |
| LOS by Move:              | F           | A    | B    | A           | A    | A    | A          | E    | E    | D          | A    | A    |
| HCM2k95thQ:               | 15          | 0    | 10   | 0           | 0    | 0    | 0          | 37   | 37   | 64         | 8    | 0    |

Note: Queue reported is the number of cars per lane.

BART

Level Of Service Computation Report  
 2000 HCM Operations (Future Volume Alternative)  
 PM - Cumulative No Project

Intersection #3210: 101/Julian-McKee (W) [Study Int 4]

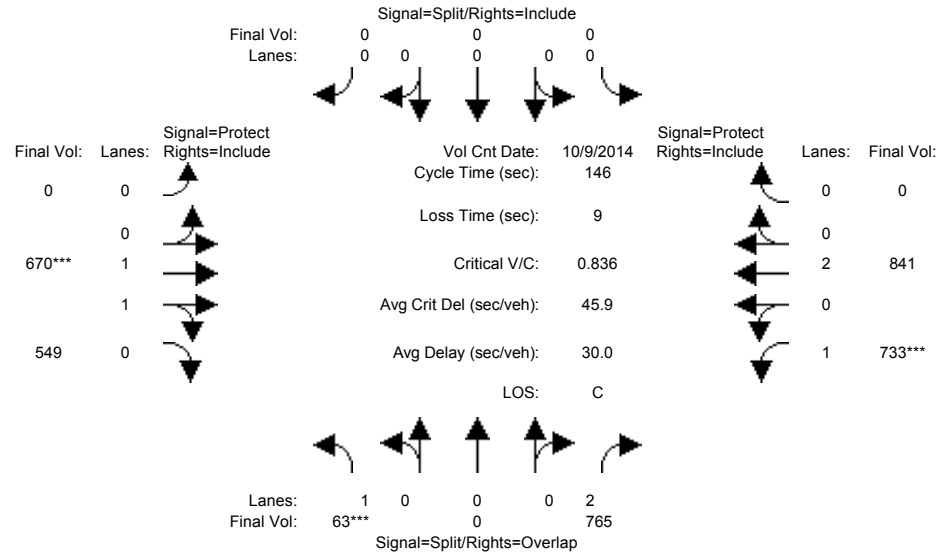

| Approach:                 | North Bound                  |      |      | South Bound |      |      | East Bound |      |      | West Bound |      |      |
|---------------------------|------------------------------|------|------|-------------|------|------|------------|------|------|------------|------|------|
| Movement:                 | L                            | T    | R    | L           | T    | R    | L          | T    | R    | L          | T    | R    |
| Min. Green:               | 10                           | 0    | 10   | 0           | 0    | 0    | 0          | 10   | 10   | 7          | 10   | 0    |
| Y+R:                      | 4.0                          | 4.0  | 4.0  | 4.0         | 4.0  | 4.0  | 4.0        | 4.0  | 4.0  | 4.0        | 4.0  | 4.0  |
| -----                     |                              |      |      |             |      |      |            |      |      |            |      |      |
| Volume Module:            | >> Count Date: 9 Oct 2014 << |      |      |             |      |      |            |      |      |            |      |      |
| Base Vol:                 | 63                           | 0    | 765  | 0           | 0    | 0    | 0          | 670  | 549  | 733        | 841  | 0    |
| Growth Adj:               | 1.00                         | 1.00 | 1.00 | 1.00        | 1.00 | 1.00 | 1.00       | 1.00 | 1.00 | 1.00       | 1.00 | 1.00 |
| Initial Bse:              | 63                           | 0    | 765  | 0           | 0    | 0    | 0          | 670  | 549  | 733        | 841  | 0    |
| Added Vol:                | 0                            | 0    | 0    | 0           | 0    | 0    | 0          | 0    | 0    | 0          | 0    | 0    |
| PasserByVol:              | 0                            | 0    | 0    | 0           | 0    | 0    | 0          | 0    | 0    | 0          | 0    | 0    |
| Initial Fut:              | 63                           | 0    | 765  | 0           | 0    | 0    | 0          | 670  | 549  | 733        | 841  | 0    |
| User Adj:                 | 1.00                         | 1.00 | 1.00 | 1.00        | 1.00 | 1.00 | 1.00       | 1.00 | 1.00 | 1.00       | 1.00 | 1.00 |
| PHF Adj:                  | 1.00                         | 1.00 | 1.00 | 1.00        | 1.00 | 1.00 | 1.00       | 1.00 | 1.00 | 1.00       | 1.00 | 1.00 |
| PHF Volume:               | 63                           | 0    | 765  | 0           | 0    | 0    | 0          | 670  | 549  | 733        | 841  | 0    |
| Reduct Vol:               | 0                            | 0    | 0    | 0           | 0    | 0    | 0          | 0    | 0    | 0          | 0    | 0    |
| Reduced Vol:              | 63                           | 0    | 765  | 0           | 0    | 0    | 0          | 670  | 549  | 733        | 841  | 0    |
| PCE Adj:                  | 1.00                         | 1.00 | 1.00 | 1.00        | 1.00 | 1.00 | 1.00       | 1.00 | 1.00 | 1.00       | 1.00 | 1.00 |
| MLF Adj:                  | 1.00                         | 1.00 | 1.00 | 1.00        | 1.00 | 1.00 | 1.00       | 1.00 | 1.00 | 1.00       | 1.00 | 1.00 |
| FinalVolume:              | 63                           | 0    | 765  | 0           | 0    | 0    | 0          | 670  | 549  | 733        | 841  | 0    |
| -----                     |                              |      |      |             |      |      |            |      |      |            |      |      |
| Saturation Flow Module:   |                              |      |      |             |      |      |            |      |      |            |      |      |
| Sat/Lane:                 | 1900                         | 1900 | 1900 | 1900        | 1900 | 1900 | 1900       | 1900 | 1900 | 1900       | 1900 | 1900 |
| Adjustment:               | 0.92                         | 1.00 | 0.83 | 0.92        | 1.00 | 0.92 | 0.92       | 1.00 | 0.95 | 0.92       | 1.00 | 0.92 |
| Lanes:                    | 1.00                         | 0.00 | 2.00 | 0.00        | 0.00 | 0.00 | 0.00       | 1.07 | 0.93 | 1.00       | 2.00 | 0.00 |
| Final Sat.:               | 1750                         | 0    | 3150 | 0           | 0    | 0    | 0          | 2032 | 1665 | 1750       | 3800 | 0    |
| -----                     |                              |      |      |             |      |      |            |      |      |            |      |      |
| Capacity Analysis Module: |                              |      |      |             |      |      |            |      |      |            |      |      |
| Vol/Sat:                  | 0.04                         | 0.00 | 0.24 | 0.00        | 0.00 | 0.00 | 0.00       | 0.33 | 0.33 | 0.42       | 0.22 | 0.00 |
| Crit Moves:               | ****                         |      |      | ****        |      |      | ****       |      |      | ****       |      |      |
| Green Time:               | 10.0                         | 0.0  | 81.1 | 0.0         | 0.0  | 0.0  | 0.0        | 55.9 | 55.9 | 71.1       | 127  | 0.0  |
| Volume/Cap:               | 0.53                         | 0.00 | 0.44 | 0.00        | 0.00 | 0.00 | 0.00       | 0.86 | 0.86 | 0.86       | 0.25 | 0.00 |
| Delay/Veh:                | 70.0                         | 0.0  | 19.2 | 0.0         | 0.0  | 0.0  | 0.0        | 47.0 | 47.0 | 42.0       | 1.6  | 0.0  |
| User DelAdj:              | 1.00                         | 1.00 | 1.00 | 1.00        | 1.00 | 1.00 | 1.00       | 1.00 | 1.00 | 1.00       | 1.00 | 1.00 |
| AdjDel/Veh:               | 70.0                         | 0.0  | 19.2 | 0.0         | 0.0  | 0.0  | 0.0        | 47.0 | 47.0 | 42.0       | 1.6  | 0.0  |
| LOS by Move:              | E                            | A    | B    | A           | A    | A    | A          | D    | D    | D          | A    | A    |
| HCM2k95thQ:               | 7                            | 0    | 21   | 0           | 0    | 0    | 0          | 44   | 44   | 53         | 6    | 0    |

Note: Queue reported is the number of cars per lane.

BART

Level Of Service Computation Report  
 2000 HCM Operations (Future Volume Alternative)  
 AM - Cumulative With Project

Intersection #3210: 101/Julian-McKee (W) [Study Int 4]

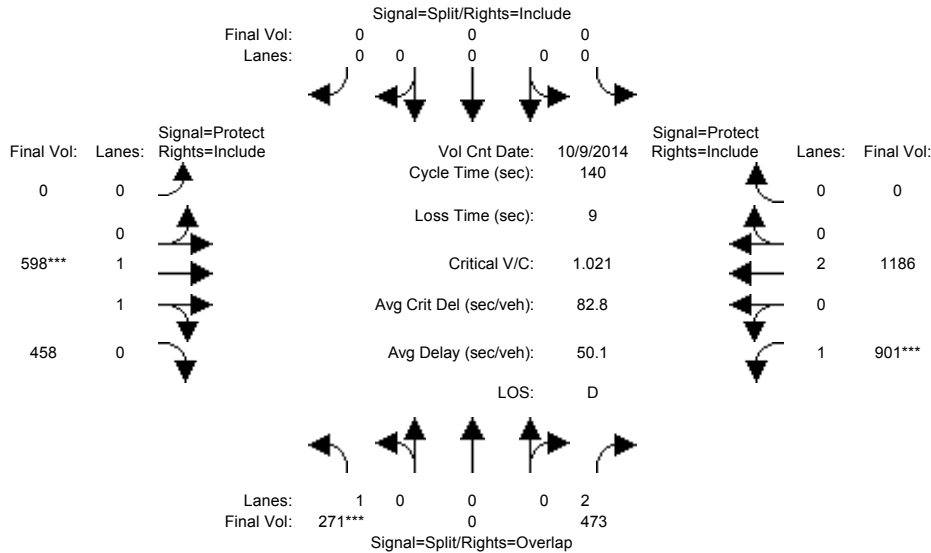

| Approach:                                   | North Bound |      |      | South Bound |      |      | East Bound |      |      | West Bound |      |      |
|---|-------------|------|------|-------------|------|------|------------|------|------|------------|------|------|
| Movement:                                   | L           | T    | R    | L           | T    | R    | L          | T    | R    | L          | T    | R    |
| Min. Green:                                 | 10          | 0    | 10   | 0           | 0    | 0    | 0          | 10   | 10   | 7          | 10   | 0    |
| Y+R:  | 4.0         | 4.0  | 4.0  | 4.0         | 4.0  | 4.0  | 4.0        | 4.0  | 4.0  | 4.0        | 4.0  | 0    |
| -----                                       |             |      |      |             |      |      |            |      |      |            |      |      |
| Volume Module: >> Count Date: 9 Oct 2014 << |             |      |      |             |      |      |            |      |      |            |      |      |
| Base Vol:                                   | 271         | 0    | 473  | 0           | 0    | 0    | 0          | 598  | 458  | 901        | 1186 | 0    |
| Growth Adj:                                 | 1.00        | 1.00 | 1.00 | 1.00        | 1.00 | 1.00 | 1.00       | 1.00 | 1.00 | 1.00       | 1.00 | 1.00 |
| Initial Bse:                                | 271         | 0    | 473  | 0           | 0    | 0    | 0          | 598  | 458  | 901        | 1186 | 0    |
| Added Vol:                                  | 0           | 0    | 0    | 0           | 0    | 0    | 0          | 0    | 0    | 0          | 0    | 0    |
| PasserByVol:                                | 0           | 0    | 0    | 0           | 0    | 0    | 0          | 0    | 0    | 0          | 0    | 0    |
| Initial Fut:                                | 271         | 0    | 473  | 0           | 0    | 0    | 0          | 598  | 458  | 901        | 1186 | 0    |
| User Adj:                                   | 1.00        | 1.00 | 1.00 | 1.00        | 1.00 | 1.00 | 1.00       | 1.00 | 1.00 | 1.00       | 1.00 | 1.00 |
| PHF Adj:                                    | 1.00        | 1.00 | 1.00 | 1.00        | 1.00 | 1.00 | 1.00       | 1.00 | 1.00 | 1.00       | 1.00 | 1.00 |
| PHF Volume:                                 | 271         | 0    | 473  | 0           | 0    | 0    | 0          | 598  | 458  | 901        | 1186 | 0    |
| Reduct Vol:                                 | 0           | 0    | 0    | 0           | 0    | 0    | 0          | 0    | 0    | 0          | 0    | 0    |
| Reduced Vol:                                | 271         | 0    | 473  | 0           | 0    | 0    | 0          | 598  | 458  | 901        | 1186 | 0    |
| PCE Adj:                                    | 1.00        | 1.00 | 1.00 | 1.00        | 1.00 | 1.00 | 1.00       | 1.00 | 1.00 | 1.00       | 1.00 | 1.00 |
| MLF Adj:                                    | 1.00        | 1.00 | 1.00 | 1.00        | 1.00 | 1.00 | 1.00       | 1.00 | 1.00 | 1.00       | 1.00 | 1.00 |
| FinalVolume:                                | 271         | 0    | 473  | 0           | 0    | 0    | 0          | 598  | 458  | 901        | 1186 | 0    |
| -----                                       |             |      |      |             |      |      |            |      |      |            |      |      |
| Saturation Flow Module:                     |             |      |      |             |      |      |            |      |      |            |      |      |
| Sat/Lane:                                   | 1900        | 1900 | 1900 | 1900        | 1900 | 1900 | 1900       | 1900 | 1900 | 1900       | 1900 | 1900 |
| Adjustment:                                 | 0.92        | 1.00 | 0.83 | 0.92        | 1.00 | 0.92 | 0.92       | 0.99 | 0.95 | 0.92       | 1.00 | 0.92 |
| Lanes:                                      | 1.00        | 0.00 | 2.00 | 0.00        | 0.00 | 0.00 | 0.00       | 1.11 | 0.89 | 1.00       | 2.00 | 0.00 |
| Final Sat.:                                 | 1750        | 0    | 3150 | 0           | 0    | 0    | 0          | 2094 | 1604 | 1750       | 3800 | 0    |
| -----                                       |             |      |      |             |      |      |            |      |      |            |      |      |
| Capacity Analysis Module:                   |             |      |      |             |      |      |            |      |      |            |      |      |
| Vol/Sat:                                    | 0.15        | 0.00 | 0.15 | 0.00        | 0.00 | 0.00 | 0.00       | 0.29 | 0.29 | 0.51       | 0.31 | 0.00 |
| Crit Moves:                                 | ****        |      |      |             |      |      |            | **** |      |            | **** |      |
| Green Time:                                 | 21.2        | 0.0  | 91.8 | 0.0         | 0.0  | 0.0  | 0.0        | 39.2 | 39.2 | 70.6       | 110  | 0.0  |
| Volume/Cap:                                 | 1.02        | 0.00 | 0.23 | 0.00        | 0.00 | 0.00 | 0.00       | 1.02 | 1.02 | 1.02       | 0.40 | 0.00 |
| Delay/Veh:                                  | 120.1       | 0.0  | 9.8  | 0.0         | 0.0  | 0.0  | 0.0        | 83.8 | 83.8 | 70.4       | 4.8  | 0.0  |
| User DelAdj:                                | 1.00        | 1.00 | 1.00 | 1.00        | 1.00 | 1.00 | 1.00       | 1.00 | 1.00 | 1.00       | 1.00 | 1.00 |
| AdjDel/Veh:                                 | 120.1       | 0.0  | 9.8  | 0.0         | 0.0  | 0.0  | 0.0        | 83.8 | 83.8 | 70.4       | 4.8  | 0.0  |
| LOS by Move:                                | F           | A    | A    | A           | A    | A    | A          | F    | F    | E          | A    | A    |
| HCM2k95thQ:                                 | 31          | 0    | 9    | 0           | 0    | 0    | 0          | 44   | 44   | 77         | 15   | 0    |

Note: Queue reported is the number of cars per lane.

BART

Level Of Service Computation Report  
 2000 HCM Operations (Future Volume Alternative)  
 PM - Cumulative With Project

Intersection #3210: 101/Julian-McKee (W) [Study Int 4]

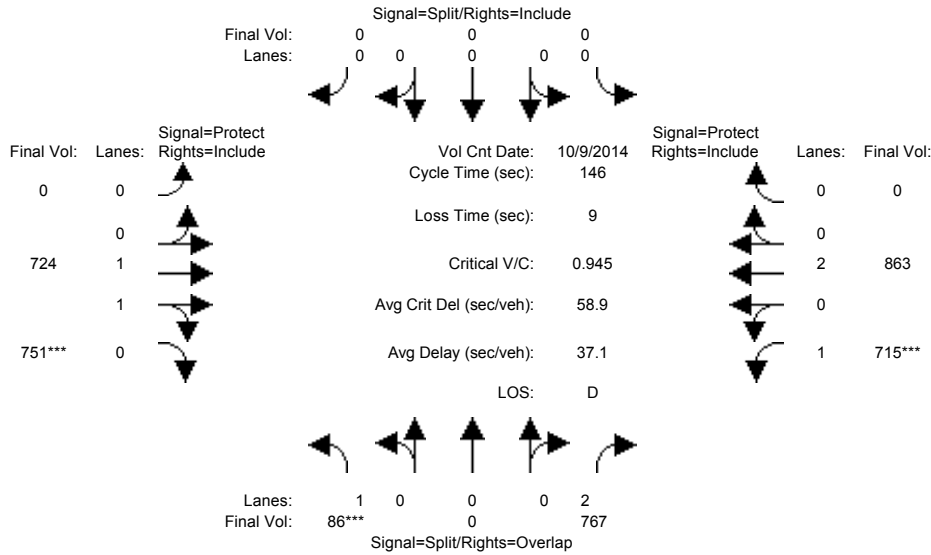

| Approach:                                   | North Bound |      |      | South Bound |      |      | East Bound |      |      | West Bound |      |      |
|---|-------------|------|------|-------------|------|------|------------|------|------|------------|------|------|
| Movement:                                   | L           | T    | R    | L           | T    | R    | L          | T    | R    | L          | T    | R    |
| Min. Green:                                 | 10          | 0    | 10   | 0           | 0    | 0    | 0          | 10   | 10   | 7          | 10   | 0    |
| Y+R:  | 4.0         | 4.0  | 4.0  | 4.0         | 4.0  | 4.0  | 4.0        | 4.0  | 4.0  | 4.0        | 4.0  | 0    |
| Volume Module: >> Count Date: 9 Oct 2014 << |             |      |      |             |      |      |            |      |      |            |      |      |
| Base Vol:                                   | 86          | 0    | 767  | 0           | 0    | 0    | 0          | 724  | 751  | 715        | 863  | 0    |
| Growth Adj:                                 | 1.00        | 1.00 | 1.00 | 1.00        | 1.00 | 1.00 | 1.00       | 1.00 | 1.00 | 1.00       | 1.00 | 1.00 |
| Initial Bse:                                | 86          | 0    | 767  | 0           | 0    | 0    | 0          | 724  | 751  | 715        | 863  | 0    |
| Added Vol:                                  | 0           | 0    | 0    | 0           | 0    | 0    | 0          | 0    | 0    | 0          | 0    | 0    |
| PasserByVol:                                | 0           | 0    | 0    | 0           | 0    | 0    | 0          | 0    | 0    | 0          | 0    | 0    |
| Initial Fut:                                | 86          | 0    | 767  | 0           | 0    | 0    | 0          | 724  | 751  | 715        | 863  | 0    |
| User Adj:                                   | 1.00        | 1.00 | 1.00 | 1.00        | 1.00 | 1.00 | 1.00       | 1.00 | 1.00 | 1.00       | 1.00 | 1.00 |
| PHF Adj:                                    | 1.00        | 1.00 | 1.00 | 1.00        | 1.00 | 1.00 | 1.00       | 1.00 | 1.00 | 1.00       | 1.00 | 1.00 |
| PHF Volume:                                 | 86          | 0    | 767  | 0           | 0    | 0    | 0          | 724  | 751  | 715        | 863  | 0    |
| Reduct Vol:                                 | 0           | 0    | 0    | 0           | 0    | 0    | 0          | 0    | 0    | 0          | 0    | 0    |
| Reduced Vol:                                | 86          | 0    | 767  | 0           | 0    | 0    | 0          | 724  | 751  | 715        | 863  | 0    |
| PCE Adj:                                    | 1.00        | 1.00 | 1.00 | 1.00        | 1.00 | 1.00 | 1.00       | 1.00 | 1.00 | 1.00       | 1.00 | 1.00 |
| MLF Adj:                                    | 1.00        | 1.00 | 1.00 | 1.00        | 1.00 | 1.00 | 1.00       | 1.00 | 1.00 | 1.00       | 1.00 | 1.00 |
| FinalVolume:                                | 86          | 0    | 767  | 0           | 0    | 0    | 0          | 724  | 751  | 715        | 863  | 0    |
| Saturation Flow Module:                     |             |      |      |             |      |      |            |      |      |            |      |      |
| Sat/Lane:                                   | 1900        | 1900 | 1900 | 1900        | 1900 | 1900 | 1900       | 1900 | 1900 | 1900       | 1900 | 1900 |
| Adjustment:                                 | 0.92        | 1.00 | 0.83 | 0.92        | 1.00 | 0.92 | 0.92       | 1.00 | 0.92 | 0.92       | 1.00 | 0.92 |
| Lanes:                                      | 1.00        | 0.00 | 2.00 | 0.00        | 0.00 | 0.00 | 0.00       | 1.00 | 1.00 | 1.00       | 2.00 | 0.00 |
| Final Sat.:                                 | 1750        | 0    | 3150 | 0           | 0    | 0    | 0          | 1900 | 1750 | 1750       | 3800 | 0    |
| Capacity Analysis Module:                   |             |      |      |             |      |      |            |      |      |            |      |      |
| Vol/Sat:                                    | 0.05        | 0.00 | 0.24 | 0.00        | 0.00 | 0.00 | 0.00       | 0.38 | 0.43 | 0.41       | 0.23 | 0.00 |
| Crit Moves:                                 | ****        |      |      |             |      |      |            |      | **** | ****       |      |      |
| Green Time:                                 | 10.0        | 0.0  | 71.9 | 0.0         | 0.0  | 0.0  | 0.0        | 65.1 | 65.1 | 61.9       | 127  | 0.0  |
| Volume/Cap:                                 | 0.72        | 0.00 | 0.49 | 0.00        | 0.00 | 0.00 | 0.00       | 0.86 | 0.96 | 0.96       | 0.26 | 0.00 |
| Delay/Veh:                                  | 85.4        | 0.0  | 25.1 | 0.0         | 0.0  | 0.0  | 0.0        | 40.7 | 54.4 | 65.1       | 1.6  | 0.0  |
| User DelAdj:                                | 1.00        | 1.00 | 1.00 | 1.00        | 1.00 | 1.00 | 1.00       | 1.00 | 1.00 | 1.00       | 1.00 | 1.00 |
| AdjDel/Veh:                                 | 85.4        | 0.0  | 25.1 | 0.0         | 0.0  | 0.0  | 0.0        | 40.7 | 54.4 | 65.1       | 1.6  | 0.0  |
| LOS by Move:                                | F           | A    | C    | A           | A    | A    | A          | D    | D    | E          | A    | A    |
| HCM2k95thQ:                                 | 11          | 0    | 24   | 0           | 0    | 0    | 0          | 48   | 61   | 61         | 7    | 0    |

Note: Queue reported is the number of cars per lane.

BART

Level Of Service Computation Report  
 2000 HCM Operations (Future Volume Alternative)  
 AM - Cumulative No Project

Intersection #3211: 101/McKee(E) [Study Int 5]

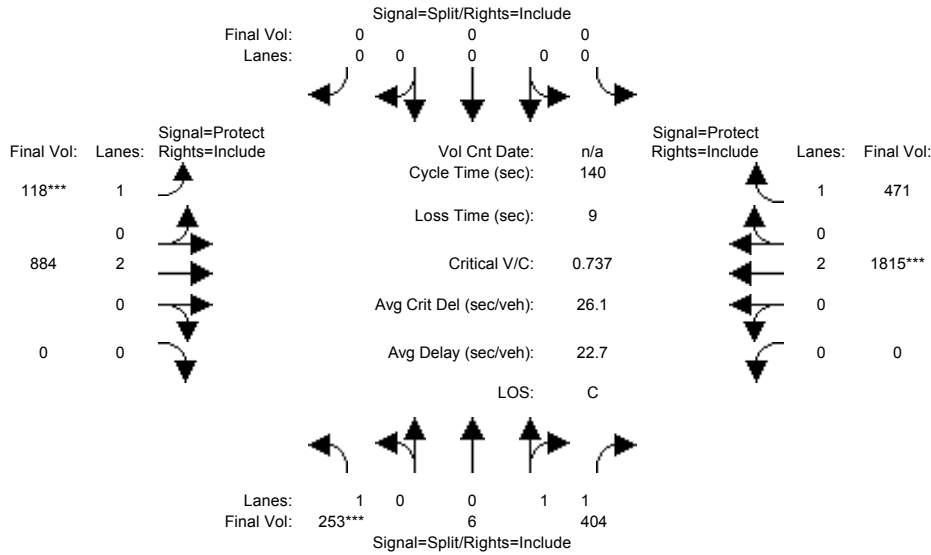

| Approach:                 | North Bound |      |      | South Bound |      |      | East Bound |      |      | West Bound |      |      |
|---------------------------|-------------|------|------|-------------|------|------|------------|------|------|------------|------|------|
| Movement:                 | L           | T    | R    | L           | T    | R    | L          | T    | R    | L          | T    | R    |
| Min. Green:               | 10          | 10   | 10   | 0           | 0    | 0    | 7          | 10   | 0    | 0          | 10   | 10   |
| Y+R:                      | 4.0         | 4.0  | 4.0  | 4.0         | 4.0  | 4.0  | 4.0        | 4.0  | 4.0  | 4.0        | 4.0  | 4.0  |
| Volume Module:            |             |      |      |             |      |      |            |      |      |            |      |      |
| Base Vol:                 | 253         | 6    | 404  | 0           | 0    | 0    | 118        | 884  | 0    | 0          | 1815 | 471  |
| Growth Adj:               | 1.00        | 1.00 | 1.00 | 1.00        | 1.00 | 1.00 | 1.00       | 1.00 | 1.00 | 1.00       | 1.00 | 1.00 |
| Initial Bse:              | 253         | 6    | 404  | 0           | 0    | 0    | 118        | 884  | 0    | 0          | 1815 | 471  |
| Added Vol:                | 0           | 0    | 0    | 0           | 0    | 0    | 0          | 0    | 0    | 0          | 0    | 0    |
| PasserByVol:              | 0           | 0    | 0    | 0           | 0    | 0    | 0          | 0    | 0    | 0          | 0    | 0    |
| Initial Fut:              | 253         | 6    | 404  | 0           | 0    | 0    | 118        | 884  | 0    | 0          | 1815 | 471  |
| User Adj:                 | 1.00        | 1.00 | 1.00 | 1.00        | 1.00 | 1.00 | 1.00       | 1.00 | 1.00 | 1.00       | 1.00 | 1.00 |
| PHF Adj:                  | 1.00        | 1.00 | 1.00 | 1.00        | 1.00 | 1.00 | 1.00       | 1.00 | 1.00 | 1.00       | 1.00 | 1.00 |
| PHF Volume:               | 253         | 6    | 404  | 0           | 0    | 0    | 118        | 884  | 0    | 0          | 1815 | 471  |
| Reduct Vol:               | 0           | 0    | 0    | 0           | 0    | 0    | 0          | 0    | 0    | 0          | 0    | 0    |
| Reduced Vol:              | 253         | 6    | 404  | 0           | 0    | 0    | 118        | 884  | 0    | 0          | 1815 | 471  |
| PCE Adj:                  | 1.00        | 1.00 | 1.00 | 1.00        | 1.00 | 1.00 | 1.00       | 1.00 | 1.00 | 1.00       | 1.00 | 1.00 |
| MLF Adj:                  | 1.00        | 1.00 | 1.00 | 1.00        | 1.00 | 1.00 | 1.00       | 1.00 | 1.00 | 1.00       | 1.00 | 1.00 |
| FinalVolume:              | 253         | 6    | 404  | 0           | 0    | 0    | 118        | 884  | 0    | 0          | 1815 | 471  |
| Saturation Flow Module:   |             |      |      |             |      |      |            |      |      |            |      |      |
| Sat/Lane:                 | 1900        | 1900 | 1900 | 1900        | 1900 | 1900 | 1900       | 1900 | 1900 | 1900       | 1900 | 1900 |
| Adjustment:               | 0.92        | 0.95 | 0.95 | 0.92        | 1.00 | 0.92 | 0.92       | 1.00 | 0.92 | 0.92       | 1.00 | 0.92 |
| Lanes:                    | 1.00        | 0.03 | 1.97 | 0.00        | 0.00 | 0.00 | 1.00       | 2.00 | 0.00 | 0.00       | 2.00 | 1.00 |
| Final Sat.:               | 1750        | 53   | 3547 | 0           | 0    | 0    | 1750       | 3800 | 0    | 0          | 3800 | 1750 |
| Capacity Analysis Module: |             |      |      |             |      |      |            |      |      |            |      |      |
| Vol/Sat:                  | 0.14        | 0.11 | 0.11 | 0.00        | 0.00 | 0.00 | 0.07       | 0.23 | 0.00 | 0.00       | 0.48 | 0.27 |
| Crit Moves:               | ****        |      |      |             |      |      | ****       |      |      | ****       |      |      |
| Green Time:               | 27.5        | 27.5 | 27.5 | 0.0         | 0.0  | 0.0  | 12.8       | 104  | 0.0  | 0.0        | 90.7 | 90.7 |
| Volume/Cap:               | 0.74        | 0.58 | 0.58 | 0.00        | 0.00 | 0.00 | 0.74       | 0.31 | 0.00 | 0.00       | 0.74 | 0.42 |
| Delay/Veh:                | 61.0        | 52.3 | 52.3 | 0.0         | 0.0  | 0.0  | 78.3       | 6.3  | 0.0  | 0.0        | 17.8 | 12.1 |
| User DelAdj:              | 1.00        | 1.00 | 1.00 | 1.00        | 1.00 | 1.00 | 1.00       | 1.00 | 1.00 | 1.00       | 1.00 | 1.00 |
| AdjDel/Veh:               | 61.0        | 52.3 | 52.3 | 0.0         | 0.0  | 0.0  | 78.3       | 6.3  | 0.0  | 0.0        | 17.8 | 12.1 |
| LOS by Move:              | E           | D    | D    | A           | A    | A    | E          | A    | A    | A          | B    | B    |
| HCM2k95thQ:               | 22          | 17   | 17   | 0           | 0    | 0    | 13         | 12   | 0    | 0          | 40   | 18   |

Note: Queue reported is the number of cars per lane.



BART

Level Of Service Computation Report  
 2000 HCM Operations (Future Volume Alternative)  
 PM - Cumulative No Project

Intersection #3211: 101/McKee(E) [Study Int 5]

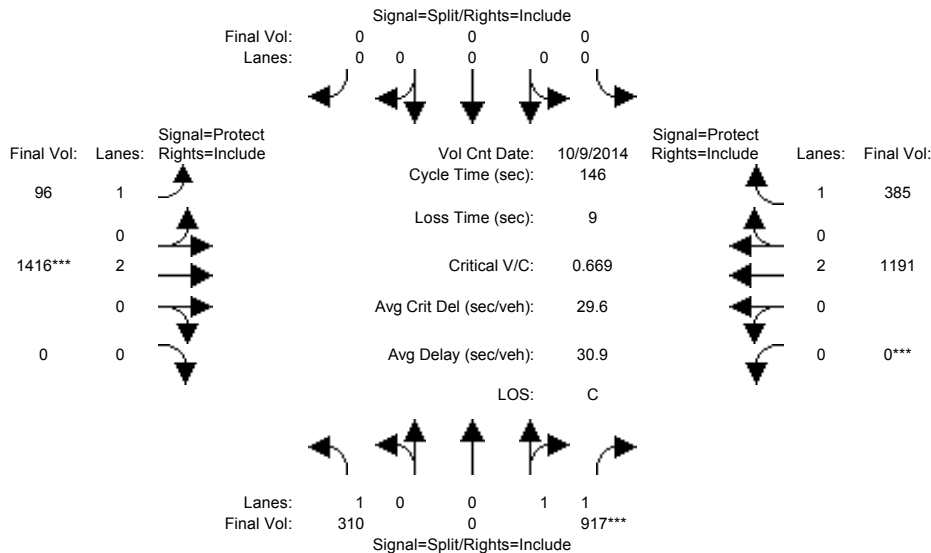

| Approach:                                   | North Bound |      |      | South Bound |      |      | East Bound |      |      | West Bound |      |      |
|---|-------------|------|------|-------------|------|------|------------|------|------|------------|------|------|
| Movement:                                   | L           | T    | R    | L           | T    | R    | L          | T    | R    | L          | T    | R    |
| Min. Green:                                 | 10          | 10   | 10   | 0           | 0    | 0    | 7          | 10   | 0    | 0          | 10   | 10   |
| Y+R:  | 4.0         | 4.0  | 4.0  | 4.0         | 4.0  | 4.0  | 4.0        | 4.0  | 4.0  | 4.0        | 4.0  | 4.0  |
| Volume Module: >> Count Date: 9 Oct 2014 << |             |      |      |             |      |      |            |      |      |            |      |      |
| Base Vol:                                   | 310         | 0    | 917  | 0           | 0    | 0    | 96         | 1416 | 0    | 0          | 1191 | 385  |
| Growth Adj:                                 | 1.00        | 1.00 | 1.00 | 1.00        | 1.00 | 1.00 | 1.00       | 1.00 | 1.00 | 1.00       | 1.00 | 1.00 |
| Initial Bse:                                | 310         | 0    | 917  | 0           | 0    | 0    | 96         | 1416 | 0    | 0          | 1191 | 385  |
| Added Vol:                                  | 0           | 0    | 0    | 0           | 0    | 0    | 0          | 0    | 0    | 0          | 0    | 0    |
| PasserByVol:                                | 0           | 0    | 0    | 0           | 0    | 0    | 0          | 0    | 0    | 0          | 0    | 0    |
| Initial Fut:                                | 310         | 0    | 917  | 0           | 0    | 0    | 96         | 1416 | 0    | 0          | 1191 | 385  |
| User Adj:                                   | 1.00        | 1.00 | 1.00 | 1.00        | 1.00 | 1.00 | 1.00       | 1.00 | 1.00 | 1.00       | 1.00 | 1.00 |
| PHF Adj:                                    | 1.00        | 1.00 | 1.00 | 1.00        | 1.00 | 1.00 | 1.00       | 1.00 | 1.00 | 1.00       | 1.00 | 1.00 |
| PHF Volume:                                 | 310         | 0    | 917  | 0           | 0    | 0    | 96         | 1416 | 0    | 0          | 1191 | 385  |
| Reduct Vol:                                 | 0           | 0    | 0    | 0           | 0    | 0    | 0          | 0    | 0    | 0          | 0    | 0    |
| Reduced Vol:                                | 310         | 0    | 917  | 0           | 0    | 0    | 96         | 1416 | 0    | 0          | 1191 | 385  |
| PCE Adj:                                    | 1.00        | 1.00 | 1.00 | 1.00        | 1.00 | 1.00 | 1.00       | 1.00 | 1.00 | 1.00       | 1.00 | 1.00 |
| MLF Adj:                                    | 1.00        | 1.00 | 1.00 | 1.00        | 1.00 | 1.00 | 1.00       | 1.00 | 1.00 | 1.00       | 1.00 | 1.00 |
| Final Volume:                               | 310         | 0    | 917  | 0           | 0    | 0    | 96         | 1416 | 0    | 0          | 1191 | 385  |
| Saturation Flow Module:                     |             |      |      |             |      |      |            |      |      |            |      |      |
| Sat/Lane:                                   | 1900        | 1900 | 1900 | 1900        | 1900 | 1900 | 1900       | 1900 | 1900 | 1900       | 1900 | 1900 |
| Adjustment:                                 | 0.92        | 1.00 | 0.95 | 0.92        | 1.00 | 0.92 | 0.92       | 1.00 | 0.92 | 0.92       | 1.00 | 0.92 |
| Lanes:                                      | 1.00        | 0.00 | 2.00 | 0.00        | 0.00 | 0.00 | 1.00       | 2.00 | 0.00 | 0.00       | 2.00 | 1.00 |
| Final Sat.:                                 | 1750        | 0    | 3600 | 0           | 0    | 0    | 1750       | 3800 | 0    | 0          | 3800 | 1750 |
| Capacity Analysis Module:                   |             |      |      |             |      |      |            |      |      |            |      |      |
| Vol/Sat:                                    | 0.18        | 0.00 | 0.25 | 0.00        | 0.00 | 0.00 | 0.05       | 0.37 | 0.00 | 0.00       | 0.31 | 0.22 |
| Crit Moves:                                 | ****        |      |      | ****        |      |      | ****       |      |      | ****       |      |      |
| Green Time:                                 | 55.6        | 0.0  | 55.6 | 0.0         | 0.0  | 0.0  | 12.1       | 81.4 | 0.0  | 0.0        | 69.3 | 69.3 |
| Volume/Cap:                                 | 0.46        | 0.00 | 0.67 | 0.00        | 0.00 | 0.00 | 0.66       | 0.67 | 0.00 | 0.00       | 0.66 | 0.46 |
| Delay/Veh:                                  | 34.5        | 0.0  | 38.8 | 0.0         | 0.0  | 0.0  | 75.7       | 23.6 | 0.0  | 0.0        | 30.3 | 26.3 |
| User DelAdj:                                | 1.00        | 1.00 | 1.00 | 1.00        | 1.00 | 1.00 | 1.00       | 1.00 | 1.00 | 1.00       | 1.00 | 1.00 |
| AdjDel/Veh:                                 | 34.5        | 0.0  | 38.8 | 0.0         | 0.0  | 0.0  | 75.7       | 23.6 | 0.0  | 0.0        | 30.3 | 26.3 |
| LOS by Move:                                | C           | A    | D    | A           | A    | A    | E          | C    | A    | A          | C    | C    |
| HCM2k95thQ:                                 | 20          | 0    | 31   | 0           | 0    | 0    | 11         | 37   | 0    | 0          | 33   | 22   |

Note: Queue reported is the number of cars per lane.

BART

Level Of Service Computation Report  
 2000 HCM Operations (Future Volume Alternative)  
 AM - Cumulative With Project

Intersection #3211: 101/McKee(E) [Study Int 5]

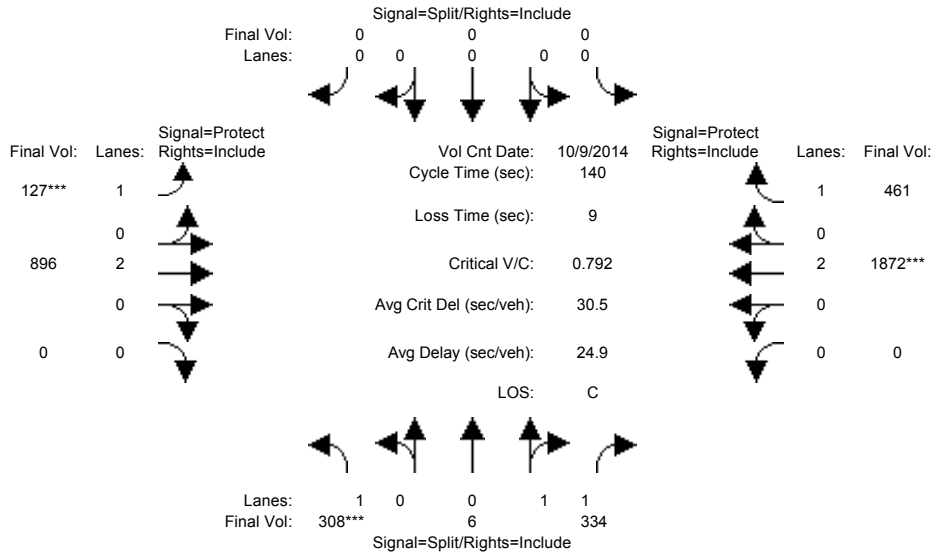

| Approach:                                   | North Bound |      |      | South Bound |      |      | East Bound |      |      | West Bound |      |      |
|---|-------------|------|------|-------------|------|------|------------|------|------|------------|------|------|
| Movement:                                   | L           | T    | R    | L           | T    | R    | L          | T    | R    | L          | T    | R    |
| Min. Green:                                 | 10          | 10   | 10   | 0           | 0    | 0    | 7          | 10   | 0    | 0          | 10   | 10   |
| Y+R:  | 4.0         | 4.0  | 4.0  | 4.0         | 4.0  | 4.0  | 4.0        | 4.0  | 4.0  | 4.0        | 4.0  | 4.0  |
| Volume Module: >> Count Date: 9 Oct 2014 << |             |      |      |             |      |      |            |      |      |            |      |      |
| Base Vol:                                   | 308         | 6    | 334  | 0           | 0    | 0    | 127        | 896  | 0    | 0          | 1872 | 461  |
| Growth Adj:                                 | 1.00        | 1.00 | 1.00 | 1.00        | 1.00 | 1.00 | 1.00       | 1.00 | 1.00 | 1.00       | 1.00 | 1.00 |
| Initial Bse:                                | 308         | 6    | 334  | 0           | 0    | 0    | 127        | 896  | 0    | 0          | 1872 | 461  |
| Added Vol:                                  | 0           | 0    | 0    | 0           | 0    | 0    | 0          | 0    | 0    | 0          | 0    | 0    |
| PasserByVol:                                | 0           | 0    | 0    | 0           | 0    | 0    | 0          | 0    | 0    | 0          | 0    | 0    |
| Initial Fut:                                | 308         | 6    | 334  | 0           | 0    | 0    | 127        | 896  | 0    | 0          | 1872 | 461  |
| User Adj:                                   | 1.00        | 1.00 | 1.00 | 1.00        | 1.00 | 1.00 | 1.00       | 1.00 | 1.00 | 1.00       | 1.00 | 1.00 |
| PHF Adj:                                    | 1.00        | 1.00 | 1.00 | 1.00        | 1.00 | 1.00 | 1.00       | 1.00 | 1.00 | 1.00       | 1.00 | 1.00 |
| PHF Volume:                                 | 308         | 6    | 334  | 0           | 0    | 0    | 127        | 896  | 0    | 0          | 1872 | 461  |
| Reduct Vol:                                 | 0           | 0    | 0    | 0           | 0    | 0    | 0          | 0    | 0    | 0          | 0    | 0    |
| Reduced Vol:                                | 308         | 6    | 334  | 0           | 0    | 0    | 127        | 896  | 0    | 0          | 1872 | 461  |
| PCE Adj:                                    | 1.00        | 1.00 | 1.00 | 1.00        | 1.00 | 1.00 | 1.00       | 1.00 | 1.00 | 1.00       | 1.00 | 1.00 |
| MLF Adj:                                    | 1.00        | 1.00 | 1.00 | 1.00        | 1.00 | 1.00 | 1.00       | 1.00 | 1.00 | 1.00       | 1.00 | 1.00 |
| FinalVolume:                                | 308         | 6    | 334  | 0           | 0    | 0    | 127        | 896  | 0    | 0          | 1872 | 461  |
| Saturation Flow Module:                     |             |      |      |             |      |      |            |      |      |            |      |      |
| Sat/Lane:                                   | 1900        | 1900 | 1900 | 1900        | 1900 | 1900 | 1900       | 1900 | 1900 | 1900       | 1900 | 1900 |
| Adjustment:                                 | 0.92        | 0.95 | 0.95 | 0.92        | 1.00 | 0.92 | 0.92       | 1.00 | 0.92 | 0.92       | 1.00 | 0.92 |
| Lanes:                                      | 1.00        | 0.04 | 1.96 | 0.00        | 0.00 | 0.00 | 1.00       | 2.00 | 0.00 | 0.00       | 2.00 | 1.00 |
| Final Sat.:                                 | 1750        | 64   | 3536 | 0           | 0    | 0    | 1750       | 3800 | 0    | 0          | 3800 | 1750 |
| Capacity Analysis Module:                   |             |      |      |             |      |      |            |      |      |            |      |      |
| Vol/Sat:                                    | 0.18        | 0.09 | 0.09 | 0.00        | 0.00 | 0.00 | 0.07       | 0.24 | 0.00 | 0.00       | 0.49 | 0.26 |
| Crit Moves:                                 | ****        |      |      |             |      |      | ****       |      |      | ****       |      |      |
| Green Time:                                 | 31.1        | 31.1 | 31.1 | 0.0         | 0.0  | 0.0  | 12.8       | 99.9 | 0.0  | 0.0        | 87.1 | 87.1 |
| Volume/Cap:                                 | 0.79        | 0.43 | 0.43 | 0.00        | 0.00 | 0.00 | 0.79       | 0.33 | 0.00 | 0.00       | 0.79 | 0.42 |
| Delay/Veh:                                  | 62.0        | 47.1 | 47.1 | 0.0         | 0.0  | 0.0  | 85.3       | 7.6  | 0.0  | 0.0        | 21.6 | 13.9 |
| User DelAdj:                                | 1.00        | 1.00 | 1.00 | 1.00        | 1.00 | 1.00 | 1.00       | 1.00 | 1.00 | 1.00       | 1.00 | 1.00 |
| AdjDel/Veh:                                 | 62.0        | 47.1 | 47.1 | 0.0         | 0.0  | 0.0  | 85.3       | 7.6  | 0.0  | 0.0        | 21.6 | 13.9 |
| LOS by Move:                                | E           | D    | D    | A           | A    | A    | F          | A    | A    | A          | C    | B    |
| HCM2k95thQ:                                 | 27          | 13   | 13   | 0           | 0    | 0    | 15         | 13   | 0    | 0          | 45   | 19   |

Note: Queue reported is the number of cars per lane.

BART

Level Of Service Computation Report  
2000 HCM Operations (Future Volume Alternative)  
PM - Cumulative With Project

Intersection #3211: 101/McKee(E) [Study Int 5]

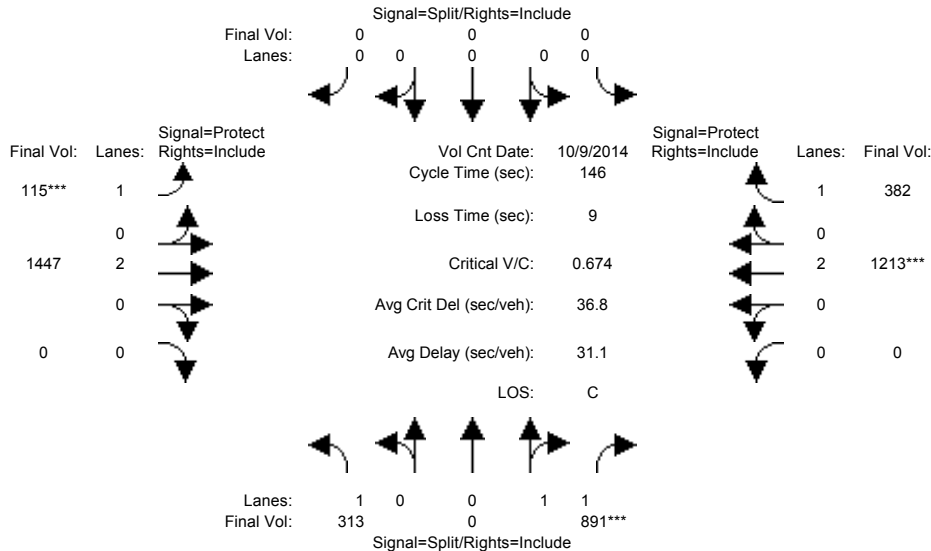

| Approach:                                   | North Bound |      |      | South Bound |      |      | East Bound |      |      | West Bound |      |      |
|---|-------------|------|------|-------------|------|------|------------|------|------|------------|------|------|
| Movement:                                   | L           | T    | R    | L           | T    | R    | L          | T    | R    | L          | T    | R    |
| Min. Green:                                 | 10          | 10   | 10   | 0           | 0    | 0    | 7          | 10   | 0    | 0          | 10   | 10   |
| Y+R:  | 4.0         | 4.0  | 4.0  | 4.0         | 4.0  | 4.0  | 4.0        | 4.0  | 4.0  | 4.0        | 4.0  | 4.0  |
| Volume Module: >> Count Date: 9 Oct 2014 << |             |      |      |             |      |      |            |      |      |            |      |      |
| Base Vol:                                   | 313         | 0    | 891  | 0           | 0    | 0    | 115        | 1447 | 0    | 0          | 1213 | 382  |
| Growth Adj:                                 | 1.00        | 1.00 | 1.00 | 1.00        | 1.00 | 1.00 | 1.00       | 1.00 | 1.00 | 1.00       | 1.00 | 1.00 |
| Initial Bse:                                | 313         | 0    | 891  | 0           | 0    | 0    | 115        | 1447 | 0    | 0          | 1213 | 382  |
| Added Vol:                                  | 0           | 0    | 0    | 0           | 0    | 0    | 0          | 0    | 0    | 0          | 0    | 0    |
| PasserByVol:                                | 0           | 0    | 0    | 0           | 0    | 0    | 0          | 0    | 0    | 0          | 0    | 0    |
| Initial Fut:                                | 313         | 0    | 891  | 0           | 0    | 0    | 115        | 1447 | 0    | 0          | 1213 | 382  |
| User Adj:                                   | 1.00        | 1.00 | 1.00 | 1.00        | 1.00 | 1.00 | 1.00       | 1.00 | 1.00 | 1.00       | 1.00 | 1.00 |
| PHF Adj:                                    | 1.00        | 1.00 | 1.00 | 1.00        | 1.00 | 1.00 | 1.00       | 1.00 | 1.00 | 1.00       | 1.00 | 1.00 |
| PHF Volume:                                 | 313         | 0    | 891  | 0           | 0    | 0    | 115        | 1447 | 0    | 0          | 1213 | 382  |
| Reduct Vol:                                 | 0           | 0    | 0    | 0           | 0    | 0    | 0          | 0    | 0    | 0          | 0    | 0    |
| Reduced Vol:                                | 313         | 0    | 891  | 0           | 0    | 0    | 115        | 1447 | 0    | 0          | 1213 | 382  |
| PCE Adj:                                    | 1.00        | 1.00 | 1.00 | 1.00        | 1.00 | 1.00 | 1.00       | 1.00 | 1.00 | 1.00       | 1.00 | 1.00 |
| MLF Adj:                                    | 1.00        | 1.00 | 1.00 | 1.00        | 1.00 | 1.00 | 1.00       | 1.00 | 1.00 | 1.00       | 1.00 | 1.00 |
| Final Volume:                               | 313         | 0    | 891  | 0           | 0    | 0    | 115        | 1447 | 0    | 0          | 1213 | 382  |
| Saturation Flow Module:                     |             |      |      |             |      |      |            |      |      |            |      |      |
| Sat/Lane:                                   | 1900        | 1900 | 1900 | 1900        | 1900 | 1900 | 1900       | 1900 | 1900 | 1900       | 1900 | 1900 |
| Adjustment:                                 | 0.92        | 1.00 | 0.95 | 0.92        | 1.00 | 0.92 | 0.92       | 1.00 | 0.92 | 0.92       | 1.00 | 0.92 |
| Lanes:                                      | 1.00        | 0.00 | 2.00 | 0.00        | 0.00 | 0.00 | 1.00       | 2.00 | 0.00 | 0.00       | 2.00 | 1.00 |
| Final Sat.:                                 | 1750        | 0    | 3600 | 0           | 0    | 0    | 1750       | 3800 | 0    | 0          | 3800 | 1750 |
| Capacity Analysis Module:                   |             |      |      |             |      |      |            |      |      |            |      |      |
| Vol/Sat:                                    | 0.18        | 0.00 | 0.25 | 0.00        | 0.00 | 0.00 | 0.07       | 0.38 | 0.00 | 0.00       | 0.32 | 0.22 |
| Crit Moves:                                 | ****        |      |      | ****        |      |      | ****       |      |      | ****       |      |      |
| Green Time:                                 | 53.6        | 0.0  | 53.6 | 0.0         | 0.0  | 0.0  | 14.2       | 83.4 | 0.0  | 0.0        | 69.1 | 69.1 |
| Volume/Cap:                                 | 0.49        | 0.00 | 0.67 | 0.00        | 0.00 | 0.00 | 0.67       | 0.67 | 0.00 | 0.00       | 0.67 | 0.46 |
| Delay/Veh:                                  | 36.2        | 0.0  | 40.2 | 0.0         | 0.0  | 0.0  | 73.8       | 22.5 | 0.0  | 0.0        | 30.7 | 26.3 |
| User DelAdj:                                | 1.00        | 1.00 | 1.00 | 1.00        | 1.00 | 1.00 | 1.00       | 1.00 | 1.00 | 1.00       | 1.00 | 1.00 |
| AdjDel/Veh:                                 | 36.2        | 0.0  | 40.2 | 0.0         | 0.0  | 0.0  | 73.8       | 22.5 | 0.0  | 0.0        | 30.7 | 26.3 |
| LOS by Move:                                | D           | A    | D    | A           | A    | A    | E          | C    | A    | A          | C    | C    |
| HCM2k95thQ:                                 | 21          | 0    | 31   | 0           | 0    | 0    | 13         | 37   | 0    | 0          | 34   | 21   |

Note: Queue reported is the number of cars per lane.

BART

Level Of Service Computation Report  
 2000 HCM Operations (Future Volume Alternative)  
 AM - Cumulative No Project

Intersection #3260: ALUM ROCK/33rd [Study Int 16]

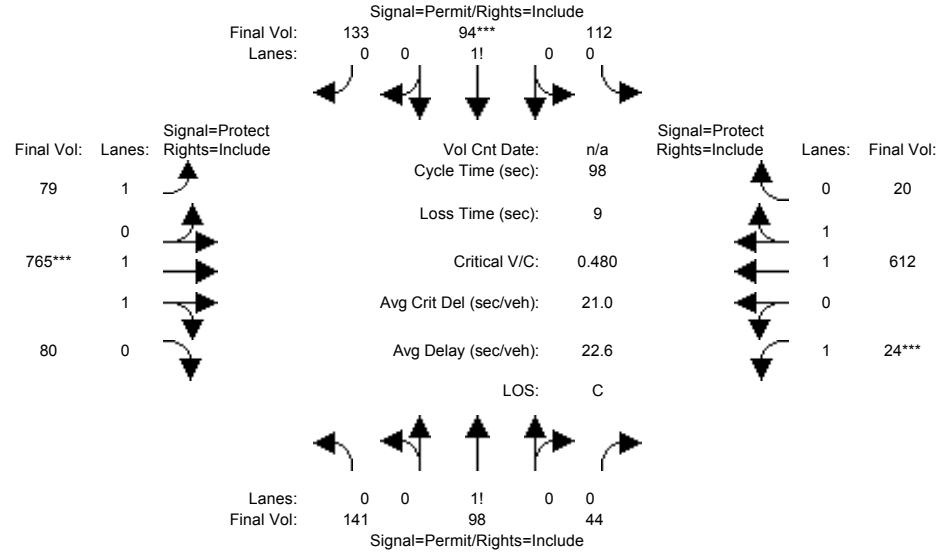

| Approach:                 | North Bound |      |      | South Bound |      |      | East Bound |      |      | West Bound |      |      |
|---------------------------|-------------|------|------|-------------|------|------|------------|------|------|------------|------|------|
| Movement:                 | L           | T    | R    | L           | T    | R    | L          | T    | R    | L          | T    | R    |
| Min. Green:               | 10          | 10   | 10   | 10          | 10   | 10   | 7          | 10   | 10   | 7          | 10   | 10   |
| Y+R:                      | 4.0         | 4.0  | 4.0  | 4.0         | 4.0  | 4.0  | 4.0        | 4.0  | 4.0  | 4.0        | 4.0  | 4.0  |
| Volume Module:            |             |      |      |             |      |      |            |      |      |            |      |      |
| Base Vol:                 | 141         | 98   | 44   | 112         | 94   | 133  | 79         | 765  | 80   | 24         | 612  | 20   |
| Growth Adj:               | 1.00        | 1.00 | 1.00 | 1.00        | 1.00 | 1.00 | 1.00       | 1.00 | 1.00 | 1.00       | 1.00 | 1.00 |
| Initial Bse:              | 141         | 98   | 44   | 112         | 94   | 133  | 79         | 765  | 80   | 24         | 612  | 20   |
| Added Vol:                | 0           | 0    | 0    | 0           | 0    | 0    | 0          | 0    | 0    | 0          | 0    | 0    |
| PasserByVol:              | 0           | 0    | 0    | 0           | 0    | 0    | 0          | 0    | 0    | 0          | 0    | 0    |
| Initial Fut:              | 141         | 98   | 44   | 112         | 94   | 133  | 79         | 765  | 80   | 24         | 612  | 20   |
| User Adj:                 | 1.00        | 1.00 | 1.00 | 1.00        | 1.00 | 1.00 | 1.00       | 1.00 | 1.00 | 1.00       | 1.00 | 1.00 |
| PHF Adj:                  | 1.00        | 1.00 | 1.00 | 1.00        | 1.00 | 1.00 | 1.00       | 1.00 | 1.00 | 1.00       | 1.00 | 1.00 |
| PHF Volume:               | 141         | 98   | 44   | 112         | 94   | 133  | 79         | 765  | 80   | 24         | 612  | 20   |
| Reduct Vol:               | 0           | 0    | 0    | 0           | 0    | 0    | 0          | 0    | 0    | 0          | 0    | 0    |
| Reduced Vol:              | 141         | 98   | 44   | 112         | 94   | 133  | 79         | 765  | 80   | 24         | 612  | 20   |
| PCE Adj:                  | 1.00        | 1.00 | 1.00 | 1.00        | 1.00 | 1.00 | 1.00       | 1.00 | 1.00 | 1.00       | 1.00 | 1.00 |
| MLF Adj:                  | 1.00        | 1.00 | 1.00 | 1.00        | 1.00 | 1.00 | 1.00       | 1.00 | 1.00 | 1.00       | 1.00 | 1.00 |
| Final Volume:             | 141         | 98   | 44   | 112         | 94   | 133  | 79         | 765  | 80   | 24         | 612  | 20   |
| Saturation Flow Module:   |             |      |      |             |      |      |            |      |      |            |      |      |
| Sat/Lane:                 | 1900        | 1900 | 1900 | 1900        | 1900 | 1900 | 1900       | 1900 | 1900 | 1900       | 1900 | 1900 |
| Adjustment:               | 0.92        | 0.92 | 0.92 | 0.92        | 0.92 | 0.92 | 0.92       | 0.98 | 0.95 | 0.92       | 0.97 | 0.95 |
| Lanes:                    | 0.50        | 0.35 | 0.15 | 0.33        | 0.28 | 0.39 | 1.00       | 1.81 | 0.19 | 1.00       | 1.93 | 0.07 |
| Final Sat.:               | 872         | 606  | 272  | 578         | 485  | 687  | 1750       | 3349 | 350  | 1750       | 3583 | 117  |
| Capacity Analysis Module: |             |      |      |             |      |      |            |      |      |            |      |      |
| Vol/Sat:                  | 0.16        | 0.16 | 0.16 | 0.19        | 0.19 | 0.19 | 0.05       | 0.23 | 0.23 | 0.01       | 0.17 | 0.17 |
| Crit Moves:               | ****        |      |      | ****        |      |      | ****       |      |      | ****       |      |      |
| Green Time:               | 37.6        | 37.6 | 37.6 | 37.6        | 37.6 | 37.6 | 15.1       | 44.4 | 44.4 | 7.0        | 36.2 | 36.2 |
| Volume/Cap:               | 0.42        | 0.42 | 0.42 | 0.50        | 0.50 | 0.50 | 0.29       | 0.50 | 0.50 | 0.19       | 0.46 | 0.46 |
| Delay/Veh:                | 22.6        | 22.6 | 22.6 | 23.7        | 23.7 | 23.7 | 37.3       | 19.3 | 19.3 | 43.6       | 23.7 | 23.7 |
| User DelAdj:              | 1.00        | 1.00 | 1.00 | 1.00        | 1.00 | 1.00 | 1.00       | 1.00 | 1.00 | 1.00       | 1.00 | 1.00 |
| AdjDel/Veh:               | 22.6        | 22.6 | 22.6 | 23.7        | 23.7 | 23.7 | 37.3       | 19.3 | 19.3 | 43.6       | 23.7 | 23.7 |
| LOS by Move:              | C           | C    | C    | C           | C    | C    | D          | B    | B    | D          | C    | C    |
| HCM2k95thQ:               | 13          | 13   | 13   | 15          | 15   | 15   | 4          | 17   | 17   | 1          | 14   | 14   |

Note: Queue reported is the number of cars per lane.

BART

Level Of Service Computation Report  
 2000 HCM Operations (Future Volume Alternative)  
 PM - Cumulative No Project

Intersection #3260: ALUM ROCK/33rd [Study Int 16]

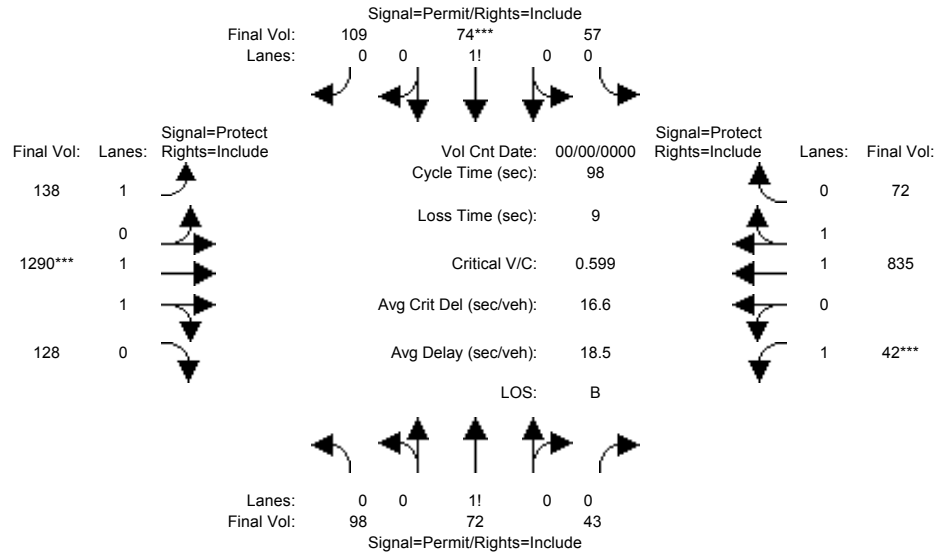

| Approach:                            | North Bound |      |      | South Bound |      |      | East Bound |      |      | West Bound |      |      |
|--------------------------------------|-------------|------|------|-------------|------|------|------------|------|------|------------|------|------|
| Movement:                            | L           | T    | R    | L           | T    | R    | L          | T    | R    | L          | T    | R    |
| Min. Green:                          | 10          | 10   | 10   | 10          | 10   | 10   | 7          | 10   | 10   | 7          | 10   | 10   |
| Y+R:                                 | 4.0         | 4.0  | 4.0  | 4.0         | 4.0  | 4.0  | 4.0        | 4.0  | 4.0  | 4.0        | 4.0  | 4.0  |
| Volume Module: >> Count Date: 0 0 << |             |      |      |             |      |      |            |      |      |            |      |      |
| Base Vol:                            | 98          | 72   | 43   | 57          | 74   | 109  | 138        | 1290 | 128  | 42         | 835  | 72   |
| Growth Adj:                          | 1.00        | 1.00 | 1.00 | 1.00        | 1.00 | 1.00 | 1.00       | 1.00 | 1.00 | 1.00       | 1.00 | 1.00 |
| Initial Bse:                         | 98          | 72   | 43   | 57          | 74   | 109  | 138        | 1290 | 128  | 42         | 835  | 72   |
| Added Vol:                           | 0           | 0    | 0    | 0           | 0    | 0    | 0          | 0    | 0    | 0          | 0    | 0    |
| PasserByVol:                         | 0           | 0    | 0    | 0           | 0    | 0    | 0          | 0    | 0    | 0          | 0    | 0    |
| Initial Fut:                         | 98          | 72   | 43   | 57          | 74   | 109  | 138        | 1290 | 128  | 42         | 835  | 72   |
| User Adj:                            | 1.00        | 1.00 | 1.00 | 1.00        | 1.00 | 1.00 | 1.00       | 1.00 | 1.00 | 1.00       | 1.00 | 1.00 |
| PHF Adj:                             | 1.00        | 1.00 | 1.00 | 1.00        | 1.00 | 1.00 | 1.00       | 1.00 | 1.00 | 1.00       | 1.00 | 1.00 |
| PHF Volume:                          | 98          | 72   | 43   | 57          | 74   | 109  | 138        | 1290 | 128  | 42         | 835  | 72   |
| Reduct Vol:                          | 0           | 0    | 0    | 0           | 0    | 0    | 0          | 0    | 0    | 0          | 0    | 0    |
| Reduced Vol:                         | 98          | 72   | 43   | 57          | 74   | 109  | 138        | 1290 | 128  | 42         | 835  | 72   |
| PCE Adj:                             | 1.00        | 1.00 | 1.00 | 1.00        | 1.00 | 1.00 | 1.00       | 1.00 | 1.00 | 1.00       | 1.00 | 1.00 |
| MLF Adj:                             | 1.00        | 1.00 | 1.00 | 1.00        | 1.00 | 1.00 | 1.00       | 1.00 | 1.00 | 1.00       | 1.00 | 1.00 |
| Final Volume:                        | 98          | 72   | 43   | 57          | 74   | 109  | 138        | 1290 | 128  | 42         | 835  | 72   |
| Saturation Flow Module:              |             |      |      |             |      |      |            |      |      |            |      |      |
| Sat/Lane:                            | 1900        | 1900 | 1900 | 1900        | 1900 | 1900 | 1900       | 1900 | 1900 | 1900       | 1900 | 1900 |
| Adjustment:                          | 0.92        | 0.92 | 0.92 | 0.92        | 0.92 | 0.92 | 0.92       | 0.98 | 0.95 | 0.92       | 0.98 | 0.95 |
| Lanes:                               | 0.46        | 0.34 | 0.20 | 0.24        | 0.31 | 0.45 | 1.00       | 1.81 | 0.19 | 1.00       | 1.84 | 0.16 |
| Final Sat.:                          | 805         | 592  | 353  | 416         | 540  | 795  | 1750       | 3366 | 334  | 1750       | 3406 | 294  |
| Capacity Analysis Module:            |             |      |      |             |      |      |            |      |      |            |      |      |
| Vol/Sat:                             | 0.12        | 0.12 | 0.12 | 0.14        | 0.14 | 0.14 | 0.08       | 0.38 | 0.38 | 0.02       | 0.25 | 0.25 |
| Crit Moves:                          | *****       |      |      |             |      |      |            |      |      |            |      |      |
| Green Time:                          | 21.6        | 21.6 | 21.6 | 21.6        | 21.6 | 21.6 | 16.4       | 60.4 | 60.4 | 7.0        | 51.0 | 51.0 |
| Volume/Cap:                          | 0.55        | 0.55 | 0.55 | 0.62        | 0.62 | 0.62 | 0.47       | 0.62 | 0.62 | 0.34       | 0.47 | 0.47 |
| Delay/Veh:                           | 35.6        | 35.6 | 35.6 | 37.6        | 37.6 | 37.6 | 38.1       | 12.2 | 12.2 | 44.9       | 15.1 | 15.1 |
| User DelAdj:                         | 1.00        | 1.00 | 1.00 | 1.00        | 1.00 | 1.00 | 1.00       | 1.00 | 1.00 | 1.00       | 1.00 | 1.00 |
| AdjDel/Veh:                          | 35.6        | 35.6 | 35.6 | 37.6        | 37.6 | 37.6 | 38.1       | 12.2 | 12.2 | 44.9       | 15.1 | 15.1 |
| LOS by Move:                         | D           | D    | D    | D           | D    | D    | D          | B    | B    | D          | B    | B    |
| HCM2k95thQ:                          | 13          | 13   | 13   | 13          | 13   | 13   | 8          | 23   | 23   | 3          | 16   | 16   |

Note: Queue reported is the number of cars per lane.

BART

Level Of Service Computation Report  
2000 HCM Operations (Future Volume Alternative)  
AM - Cumulative With Project

Intersection #3260: ALUM ROCK/33rd [Study Int 16]

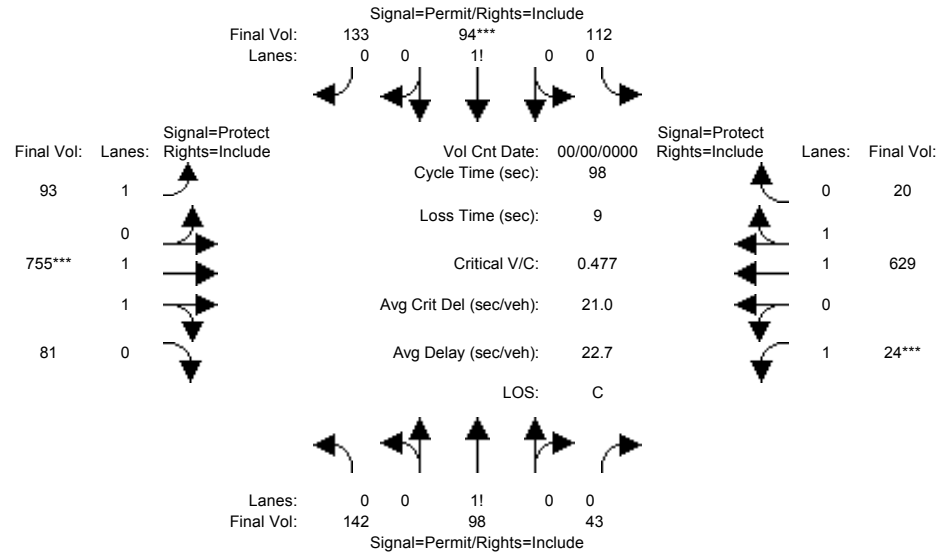

| Approach:                            | North Bound |      |      | South Bound |      |      | East Bound |      |      | West Bound |      |      |
|--------------------------------------|-------------|------|------|-------------|------|------|------------|------|------|------------|------|------|
| Movement:                            | L           | T    | R    | L           | T    | R    | L          | T    | R    | L          | T    | R    |
| Min. Green:                          | 10          | 10   | 10   | 10          | 10   | 10   | 7          | 10   | 10   | 7          | 10   | 10   |
| Y+R:                                 | 4.0         | 4.0  | 4.0  | 4.0         | 4.0  | 4.0  | 4.0        | 4.0  | 4.0  | 4.0        | 4.0  | 4.0  |
| Volume Module: >> Count Date: 0 0 << |             |      |      |             |      |      |            |      |      |            |      |      |
| Base Vol:                            | 142         | 98   | 43   | 112         | 94   | 133  | 93         | 755  | 81   | 24         | 629  | 20   |
| Growth Adj:                          | 1.00        | 1.00 | 1.00 | 1.00        | 1.00 | 1.00 | 1.00       | 1.00 | 1.00 | 1.00       | 1.00 | 1.00 |
| Initial Bse:                         | 142         | 98   | 43   | 112         | 94   | 133  | 93         | 755  | 81   | 24         | 629  | 20   |
| Added Vol:                           | 0           | 0    | 0    | 0           | 0    | 0    | 0          | 0    | 0    | 0          | 0    | 0    |
| PasserByVol:                         | 0           | 0    | 0    | 0           | 0    | 0    | 0          | 0    | 0    | 0          | 0    | 0    |
| Initial Fut:                         | 142         | 98   | 43   | 112         | 94   | 133  | 93         | 755  | 81   | 24         | 629  | 20   |
| User Adj:                            | 1.00        | 1.00 | 1.00 | 1.00        | 1.00 | 1.00 | 1.00       | 1.00 | 1.00 | 1.00       | 1.00 | 1.00 |
| PHF Adj:                             | 1.00        | 1.00 | 1.00 | 1.00        | 1.00 | 1.00 | 1.00       | 1.00 | 1.00 | 1.00       | 1.00 | 1.00 |
| PHF Volume:                          | 142         | 98   | 43   | 112         | 94   | 133  | 93         | 755  | 81   | 24         | 629  | 20   |
| Reduct Vol:                          | 0           | 0    | 0    | 0           | 0    | 0    | 0          | 0    | 0    | 0          | 0    | 0    |
| Reduced Vol:                         | 142         | 98   | 43   | 112         | 94   | 133  | 93         | 755  | 81   | 24         | 629  | 20   |
| PCE Adj:                             | 1.00        | 1.00 | 1.00 | 1.00        | 1.00 | 1.00 | 1.00       | 1.00 | 1.00 | 1.00       | 1.00 | 1.00 |
| MLF Adj:                             | 1.00        | 1.00 | 1.00 | 1.00        | 1.00 | 1.00 | 1.00       | 1.00 | 1.00 | 1.00       | 1.00 | 1.00 |
| Final Volume:                        | 142         | 98   | 43   | 112         | 94   | 133  | 93         | 755  | 81   | 24         | 629  | 20   |
| Saturation Flow Module:              |             |      |      |             |      |      |            |      |      |            |      |      |
| Sat/Lane:                            | 1900        | 1900 | 1900 | 1900        | 1900 | 1900 | 1900       | 1900 | 1900 | 1900       | 1900 | 1900 |
| Adjustment:                          | 0.92        | 0.92 | 0.92 | 0.92        | 0.92 | 0.92 | 0.92       | 0.98 | 0.95 | 0.92       | 0.97 | 0.95 |
| Lanes:                               | 0.50        | 0.35 | 0.15 | 0.33        | 0.28 | 0.39 | 1.00       | 1.80 | 0.20 | 1.00       | 1.94 | 0.06 |
| Final Sat.:                          | 878         | 606  | 266  | 578         | 485  | 687  | 1750       | 3341 | 358  | 1750       | 3586 | 114  |
| Capacity Analysis Module:            |             |      |      |             |      |      |            |      |      |            |      |      |
| Vol/Sat:                             | 0.16        | 0.16 | 0.16 | 0.19        | 0.19 | 0.19 | 0.05       | 0.23 | 0.23 | 0.01       | 0.18 | 0.18 |
| Crit Moves:                          | *****       |      |      |             |      |      |            |      |      |            |      |      |
| Green Time:                          | 37.8        | 37.8 | 37.8 | 37.8        | 37.8 | 37.8 | 14.8       | 44.2 | 44.2 | 7.0        | 36.3 | 36.3 |
| Volume/Cap:                          | 0.42        | 0.42 | 0.42 | 0.50        | 0.50 | 0.50 | 0.35       | 0.50 | 0.50 | 0.19       | 0.47 | 0.47 |
| Delay/Veh:                           | 22.4        | 22.4 | 22.4 | 23.5        | 23.5 | 23.5 | 38.1       | 19.4 | 19.4 | 43.6       | 23.8 | 23.8 |
| User DelAdj:                         | 1.00        | 1.00 | 1.00 | 1.00        | 1.00 | 1.00 | 1.00       | 1.00 | 1.00 | 1.00       | 1.00 | 1.00 |
| AdjDel/Veh:                          | 22.4        | 22.4 | 22.4 | 23.5        | 23.5 | 23.5 | 38.1       | 19.4 | 19.4 | 43.6       | 23.8 | 23.8 |
| LOS by Move:                         | C           | C    | C    | C           | C    | C    | D          | B    | B    | D          | C    | C    |
| HCM2k95thQ:                          | 13          | 13   | 13   | 15          | 15   | 15   | 5          | 17   | 17   | 1          | 14   | 14   |

Note: Queue reported is the number of cars per lane.

BART

Level Of Service Computation Report  
 2000 HCM Operations (Future Volume Alternative)  
 PM - Cumulative With Project

Intersection #3260: ALUM ROCK/33rd [Study Int 16]

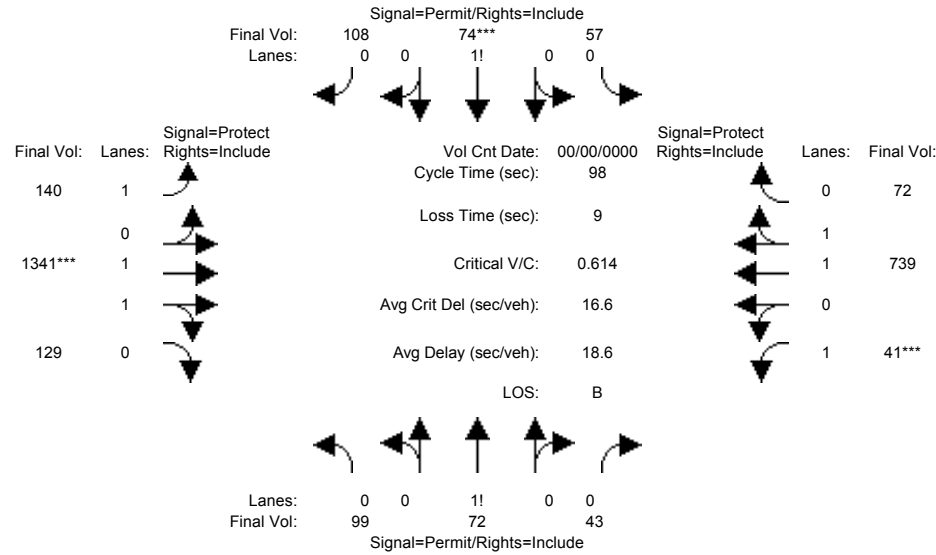

| Approach:                            | North Bound |      |      | South Bound |      |      | East Bound |      |      | West Bound |      |      |
|--------------------------------------|-------------|------|------|-------------|------|------|------------|------|------|------------|------|------|
| Movement:                            | L           | T    | R    | L           | T    | R    | L          | T    | R    | L          | T    | R    |
| Min. Green:                          | 10          | 10   | 10   | 10          | 10   | 10   | 7          | 10   | 10   | 7          | 10   | 10   |
| Y+R:                                 | 4.0         | 4.0  | 4.0  | 4.0         | 4.0  | 4.0  | 4.0        | 4.0  | 4.0  | 4.0        | 4.0  | 4.0  |
| Volume Module: >> Count Date: 0 0 << |             |      |      |             |      |      |            |      |      |            |      |      |
| Base Vol:                            | 99          | 72   | 43   | 57          | 74   | 108  | 140        | 1341 | 129  | 41         | 739  | 72   |
| Growth Adj:                          | 1.00        | 1.00 | 1.00 | 1.00        | 1.00 | 1.00 | 1.00       | 1.00 | 1.00 | 1.00       | 1.00 | 1.00 |
| Initial Bse:                         | 99          | 72   | 43   | 57          | 74   | 108  | 140        | 1341 | 129  | 41         | 739  | 72   |
| Added Vol:                           | 0           | 0    | 0    | 0           | 0    | 0    | 0          | 0    | 0    | 0          | 0    | 0    |
| PasserByVol:                         | 0           | 0    | 0    | 0           | 0    | 0    | 0          | 0    | 0    | 0          | 0    | 0    |
| Initial Fut:                         | 99          | 72   | 43   | 57          | 74   | 108  | 140        | 1341 | 129  | 41         | 739  | 72   |
| User Adj:                            | 1.00        | 1.00 | 1.00 | 1.00        | 1.00 | 1.00 | 1.00       | 1.00 | 1.00 | 1.00       | 1.00 | 1.00 |
| PHF Adj:                             | 1.00        | 1.00 | 1.00 | 1.00        | 1.00 | 1.00 | 1.00       | 1.00 | 1.00 | 1.00       | 1.00 | 1.00 |
| PHF Volume:                          | 99          | 72   | 43   | 57          | 74   | 108  | 140        | 1341 | 129  | 41         | 739  | 72   |
| Reduct Vol:                          | 0           | 0    | 0    | 0           | 0    | 0    | 0          | 0    | 0    | 0          | 0    | 0    |
| Reduced Vol:                         | 99          | 72   | 43   | 57          | 74   | 108  | 140        | 1341 | 129  | 41         | 739  | 72   |
| PCE Adj:                             | 1.00        | 1.00 | 1.00 | 1.00        | 1.00 | 1.00 | 1.00       | 1.00 | 1.00 | 1.00       | 1.00 | 1.00 |
| MLF Adj:                             | 1.00        | 1.00 | 1.00 | 1.00        | 1.00 | 1.00 | 1.00       | 1.00 | 1.00 | 1.00       | 1.00 | 1.00 |
| Final Volume:                        | 99          | 72   | 43   | 57          | 74   | 108  | 140        | 1341 | 129  | 41         | 739  | 72   |
| Saturation Flow Module:              |             |      |      |             |      |      |            |      |      |            |      |      |
| Sat/Lane:                            | 1900        | 1900 | 1900 | 1900        | 1900 | 1900 | 1900       | 1900 | 1900 | 1900       | 1900 | 1900 |
| Adjustment:                          | 0.92        | 0.92 | 0.92 | 0.92        | 0.92 | 0.92 | 0.92       | 0.98 | 0.95 | 0.92       | 0.98 | 0.95 |
| Lanes:                               | 0.46        | 0.34 | 0.20 | 0.24        | 0.31 | 0.45 | 1.00       | 1.82 | 0.18 | 1.00       | 1.82 | 0.18 |
| Final Sat.:                          | 810         | 589  | 352  | 417         | 542  | 791  | 1750       | 3375 | 325  | 1750       | 3371 | 328  |
| Capacity Analysis Module:            |             |      |      |             |      |      |            |      |      |            |      |      |
| Vol/Sat:                             | 0.12        | 0.12 | 0.12 | 0.14        | 0.14 | 0.14 | 0.08       | 0.40 | 0.40 | 0.02       | 0.22 | 0.22 |
| Crit Moves:                          | *****       |      |      |             |      |      |            |      |      |            |      |      |
| Green Time:                          | 21.0        | 21.0 | 21.0 | 21.0        | 21.0 | 21.0 | 18.2       | 61.0 | 61.0 | 7.0        | 49.8 | 49.8 |
| Volume/Cap:                          | 0.57        | 0.57 | 0.57 | 0.64        | 0.64 | 0.64 | 0.43       | 0.64 | 0.64 | 0.33       | 0.43 | 0.43 |
| Delay/Veh:                           | 36.6        | 36.6 | 36.6 | 38.7        | 38.7 | 38.7 | 36.2       | 12.2 | 12.2 | 44.8       | 15.3 | 15.3 |
| User DelAdj:                         | 1.00        | 1.00 | 1.00 | 1.00        | 1.00 | 1.00 | 1.00       | 1.00 | 1.00 | 1.00       | 1.00 | 1.00 |
| AdjDel/Veh:                          | 36.6        | 36.6 | 36.6 | 38.7        | 38.7 | 38.7 | 36.2       | 12.2 | 12.2 | 44.8       | 15.3 | 15.3 |
| LOS by Move:                         | D           | D    | D    | D           | D    | D    | D          | B    | B    | D          | B    | B    |
| HCM2k95thQ:                          | 13          | 13   | 13   | 13          | 13   | 13   | 8          | 24   | 24   | 3          | 15   | 15   |

Note: Queue reported is the number of cars per lane.

BART

Level Of Service Computation Report  
2000 HCM Operations (Future Volume Alternative)  
AM - Cumulative No Project

Intersection #3384: JACKSON/CAPITOL/SAN ANTONIO [Study Int 23]

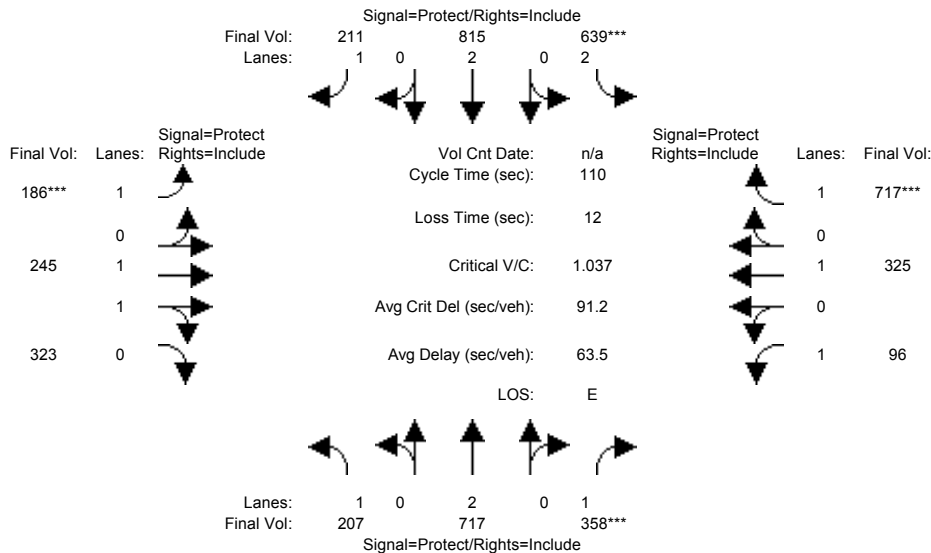

| Approach:                 | North Bound |      |       | South Bound |      |      | East Bound |      |      | West Bound |      |      |
|---------------------------|-------------|------|-------|-------------|------|------|------------|------|------|------------|------|------|
| Movement:                 | L           | T    | R     | L           | T    | R    | L          | T    | R    | L          | T    | R    |
| Min. Green:               | 7           | 10   | 10    | 7           | 10   | 10   | 7          | 10   | 10   | 7          | 10   | 10   |
| Y+R:                      | 4.0         | 4.0  | 4.0   | 4.0         | 4.0  | 4.0  | 4.0        | 4.0  | 4.0  | 4.0        | 4.0  | 4.0  |
| Volume Module:            |             |      |       |             |      |      |            |      |      |            |      |      |
| Base Vol:                 | 207         | 717  | 358   | 639         | 815  | 211  | 186        | 245  | 323  | 96         | 325  | 717  |
| Growth Adj:               | 1.00        | 1.00 | 1.00  | 1.00        | 1.00 | 1.00 | 1.00       | 1.00 | 1.00 | 1.00       | 1.00 | 1.00 |
| Initial Bse:              | 207         | 717  | 358   | 639         | 815  | 211  | 186        | 245  | 323  | 96         | 325  | 717  |
| Added Vol:                | 0           | 0    | 0     | 0           | 0    | 0    | 0          | 0    | 0    | 0          | 0    | 0    |
| PasserByVol:              | 0           | 0    | 0     | 0           | 0    | 0    | 0          | 0    | 0    | 0          | 0    | 0    |
| Initial Fut:              | 207         | 717  | 358   | 639         | 815  | 211  | 186        | 245  | 323  | 96         | 325  | 717  |
| User Adj:                 | 1.00        | 1.00 | 1.00  | 1.00        | 1.00 | 1.00 | 1.00       | 1.00 | 1.00 | 1.00       | 1.00 | 1.00 |
| PHF Adj:                  | 1.00        | 1.00 | 1.00  | 1.00        | 1.00 | 1.00 | 1.00       | 1.00 | 1.00 | 1.00       | 1.00 | 1.00 |
| PHF Volume:               | 207         | 717  | 358   | 639         | 815  | 211  | 186        | 245  | 323  | 96         | 325  | 717  |
| Reduct Vol:               | 0           | 0    | 0     | 0           | 0    | 0    | 0          | 0    | 0    | 0          | 0    | 0    |
| Reduced Vol:              | 207         | 717  | 358   | 639         | 815  | 211  | 186        | 245  | 323  | 96         | 325  | 717  |
| PCE Adj:                  | 1.00        | 1.00 | 1.00  | 1.00        | 1.00 | 1.00 | 1.00       | 1.00 | 1.00 | 1.00       | 1.00 | 1.00 |
| MLF Adj:                  | 1.00        | 1.00 | 1.00  | 1.00        | 1.00 | 1.00 | 1.00       | 1.00 | 1.00 | 1.00       | 1.00 | 1.00 |
| Final Volume:             | 207         | 717  | 358   | 639         | 815  | 211  | 186        | 245  | 323  | 96         | 325  | 717  |
| Saturation Flow Module:   |             |      |       |             |      |      |            |      |      |            |      |      |
| Sat/Lane:                 | 1900        | 1900 | 1900  | 1900        | 1900 | 1900 | 1900       | 1900 | 1900 | 1900       | 1900 | 1900 |
| Adjustment:               | 0.92        | 1.00 | 0.92  | 0.83        | 1.00 | 0.92 | 0.92       | 1.00 | 0.92 | 0.92       | 1.00 | 0.92 |
| Lanes:                    | 1.00        | 2.00 | 1.00  | 2.00        | 2.00 | 1.00 | 1.00       | 1.00 | 1.00 | 1.00       | 1.00 | 1.00 |
| Final Sat.:               | 1750        | 3800 | 1750  | 3150        | 3800 | 1750 | 1750       | 1900 | 1750 | 1750       | 1900 | 1750 |
| Capacity Analysis Module: |             |      |       |             |      |      |            |      |      |            |      |      |
| Vol/Sat:                  | 0.12        | 0.19 | 0.20  | 0.20        | 0.21 | 0.12 | 0.11       | 0.13 | 0.18 | 0.05       | 0.17 | 0.41 |
| Crit Moves:               | ****        | **** | ****  | ****        | **** | **** | ****       | **** | **** | ****       | **** | **** |
| Green Time:               | 15.4        | 21.7 | 21.7  | 21.5        | 27.9 | 27.9 | 11.3       | 40.7 | 40.7 | 14.0       | 43.5 | 43.5 |
| Volume/Cap:               | 0.85        | 0.96 | 1.04  | 1.04        | 0.85 | 0.48 | 1.04       | 0.35 | 0.50 | 0.43       | 0.43 | 1.04 |
| Delay/Veh:                | 69.2        | 66.3 | 102.3 | 90.3        | 46.1 | 35.7 | 126.5      | 25.2 | 27.1 | 45.6       | 24.7 | 77.3 |
| User DelAdj:              | 1.00        | 1.00 | 1.00  | 1.00        | 1.00 | 1.00 | 1.00       | 1.00 | 1.00 | 1.00       | 1.00 | 1.00 |
| AdjDel/Veh:               | 69.2        | 66.3 | 102.3 | 90.3        | 46.1 | 35.7 | 126.5      | 25.2 | 27.1 | 45.6       | 24.7 | 77.3 |
| LOS by Move:              | E           | E    | F     | F           | D    | D    | F          | C    | C    | D          | C    | E    |
| HCM2k95thQ:               | 15          | 25   | 30    | 33          | 28   | 13   | 17         | 11   | 17   | 7          | 15   | 56   |

Note: Queue reported is the number of cars per lane.



BART

Level Of Service Computation Report  
 2000 HCM Operations (Future Volume Alternative)  
 PM - Cumulative No Project

Intersection #3384: JACKSON/CAPITOL/SAN ANTONIO [Study Int 23]

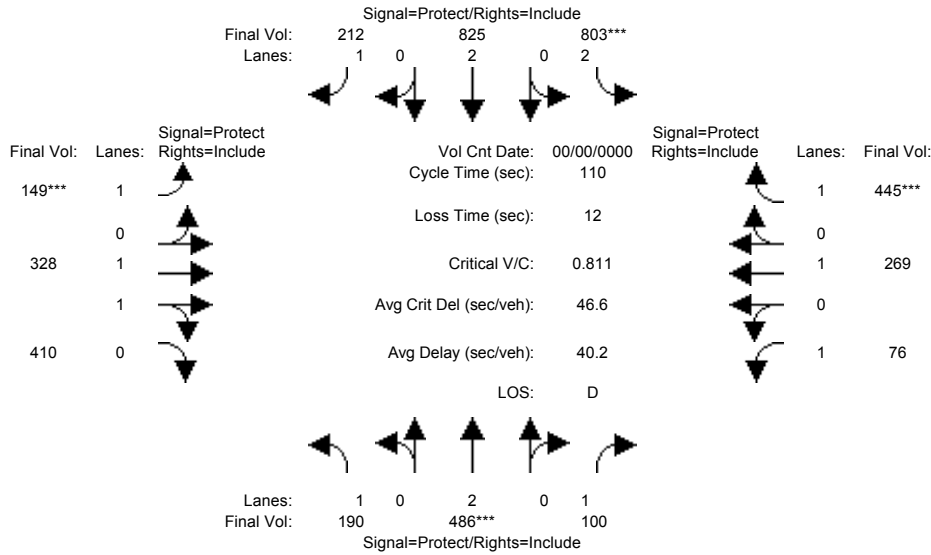

| Approach:                            | North Bound |      |      | South Bound |      |      | East Bound |      |      | West Bound |      |      |
|--------------------------------------|-------------|------|------|-------------|------|------|------------|------|------|------------|------|------|
| Movement:                            | L           | T    | R    | L           | T    | R    | L          | T    | R    | L          | T    | R    |
| Min. Green:                          | 7           | 10   | 10   | 7           | 10   | 10   | 7          | 10   | 10   | 7          | 10   | 10   |
| Y+R:                                 | 4.0         | 4.0  | 4.0  | 4.0         | 4.0  | 4.0  | 4.0        | 4.0  | 4.0  | 4.0        | 4.0  | 4.0  |
| Volume Module: >> Count Date: 0 0 << |             |      |      |             |      |      |            |      |      |            |      |      |
| Base Vol:                            | 190         | 486  | 100  | 803         | 825  | 212  | 149        | 328  | 410  | 76         | 269  | 445  |
| Growth Adj:                          | 1.00        | 1.00 | 1.00 | 1.00        | 1.00 | 1.00 | 1.00       | 1.00 | 1.00 | 1.00       | 1.00 | 1.00 |
| Initial Bse:                         | 190         | 486  | 100  | 803         | 825  | 212  | 149        | 328  | 410  | 76         | 269  | 445  |
| Added Vol:                           | 0           | 0    | 0    | 0           | 0    | 0    | 0          | 0    | 0    | 0          | 0    | 0    |
| PasserByVol:                         | 0           | 0    | 0    | 0           | 0    | 0    | 0          | 0    | 0    | 0          | 0    | 0    |
| Initial Fut:                         | 190         | 486  | 100  | 803         | 825  | 212  | 149        | 328  | 410  | 76         | 269  | 445  |
| User Adj:                            | 1.00        | 1.00 | 1.00 | 1.00        | 1.00 | 1.00 | 1.00       | 1.00 | 1.00 | 1.00       | 1.00 | 1.00 |
| PHF Adj:                             | 1.00        | 1.00 | 1.00 | 1.00        | 1.00 | 1.00 | 1.00       | 1.00 | 1.00 | 1.00       | 1.00 | 1.00 |
| PHF Volume:                          | 190         | 486  | 100  | 803         | 825  | 212  | 149        | 328  | 410  | 76         | 269  | 445  |
| Reduct Vol:                          | 0           | 0    | 0    | 0           | 0    | 0    | 0          | 0    | 0    | 0          | 0    | 0    |
| Reduced Vol:                         | 190         | 486  | 100  | 803         | 825  | 212  | 149        | 328  | 410  | 76         | 269  | 445  |
| PCE Adj:                             | 1.00        | 1.00 | 1.00 | 1.00        | 1.00 | 1.00 | 1.00       | 1.00 | 1.00 | 1.00       | 1.00 | 1.00 |
| MLF Adj:                             | 1.00        | 1.00 | 1.00 | 1.00        | 1.00 | 1.00 | 1.00       | 1.00 | 1.00 | 1.00       | 1.00 | 1.00 |
| Final Volume:                        | 190         | 486  | 100  | 803         | 825  | 212  | 149        | 328  | 410  | 76         | 269  | 445  |
| Saturation Flow Module:              |             |      |      |             |      |      |            |      |      |            |      |      |
| Sat/Lane:                            | 1900        | 1900 | 1900 | 1900        | 1900 | 1900 | 1900       | 1900 | 1900 | 1900       | 1900 | 1900 |
| Adjustment:                          | 0.92        | 1.00 | 0.92 | 0.83        | 1.00 | 0.92 | 0.92       | 1.00 | 0.92 | 0.92       | 1.00 | 0.92 |
| Lanes:                               | 1.00        | 2.00 | 1.00 | 2.00        | 2.00 | 1.00 | 1.00       | 1.00 | 1.00 | 1.00       | 1.00 | 1.00 |
| Final Sat.:                          | 1750        | 3800 | 1750 | 3150        | 3800 | 1750 | 1750       | 1900 | 1750 | 1750       | 1900 | 1750 |
| Capacity Analysis Module:            |             |      |      |             |      |      |            |      |      |            |      |      |
| Vol/Sat:                             | 0.11        | 0.13 | 0.06 | 0.25        | 0.22 | 0.12 | 0.09       | 0.17 | 0.23 | 0.04       | 0.14 | 0.25 |
| Crit Moves:                          | ****        | **** | **** | ****        | **** | **** | ****       | **** | **** | ****       | **** | **** |
| Green Time:                          | 17.3        | 17.4 | 17.4 | 34.6        | 34.6 | 34.6 | 11.6       | 36.2 | 36.2 | 9.8        | 34.5 | 34.5 |
| Volume/Cap:                          | 0.69        | 0.81 | 0.36 | 0.81        | 0.69 | 0.38 | 0.81       | 0.52 | 0.71 | 0.49       | 0.45 | 0.81 |
| Delay/Veh:                           | 51.0        | 52.9 | 42.2 | 39.8        | 34.7 | 29.8 | 71.2       | 30.3 | 34.7 | 50.0       | 30.7 | 43.6 |
| User DelAdj:                         | 1.00        | 1.00 | 1.00 | 1.00        | 1.00 | 1.00 | 1.00       | 1.00 | 1.00 | 1.00       | 1.00 | 1.00 |
| AdjDel/Veh:                          | 51.0        | 52.9 | 42.2 | 39.8        | 34.7 | 29.8 | 71.2       | 30.3 | 34.7 | 50.0       | 30.7 | 43.6 |
| LOS by Move:                         | D           | D    | D    | D           | C    | C    | E          | C    | C    | D          | C    | D    |
| HCM2k95thQ:                          | 13          | 16   | 6    | 30          | 23   | 12   | 11         | 16   | 24   | 7          | 14   | 30   |

Note: Queue reported is the number of cars per lane.

BART

Level Of Service Computation Report  
 2000 HCM Operations (Future Volume Alternative)  
 AM - Cumulative With Project

Intersection #3384: JACKSON/CAPITOL/SAN ANTONIO [Study Int 23]

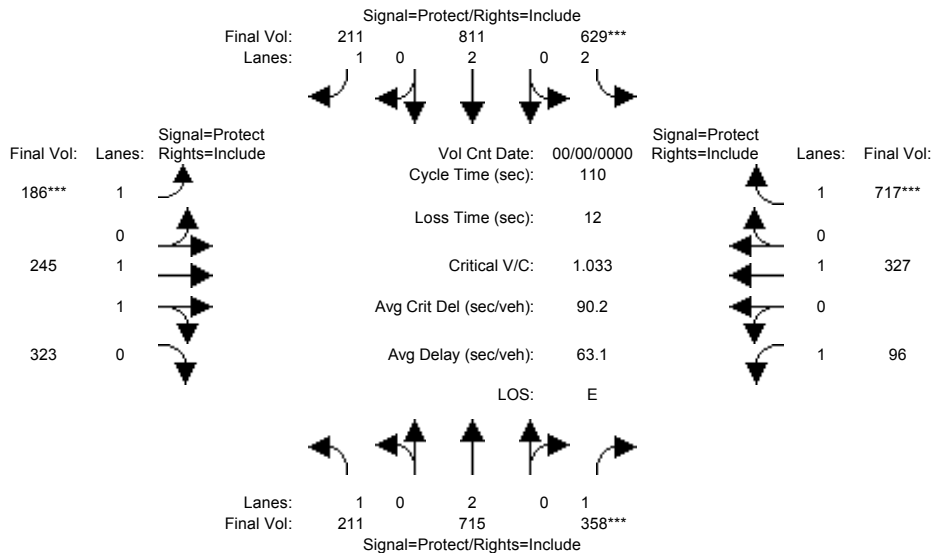

| Approach:                            | North Bound |      |       | South Bound |      |      | East Bound |      |      | West Bound |      |      |
|--------------------------------------|-------------|------|-------|-------------|------|------|------------|------|------|------------|------|------|
| Movement:                            | L           | T    | R     | L           | T    | R    | L          | T    | R    | L          | T    | R    |
| Min. Green:                          | 7           | 10   | 10    | 7           | 10   | 10   | 7          | 10   | 10   | 7          | 10   | 10   |
| Y+R:                                 | 4.0         | 4.0  | 4.0   | 4.0         | 4.0  | 4.0  | 4.0        | 4.0  | 4.0  | 4.0        | 4.0  | 4.0  |
| Volume Module: >> Count Date: 0 0 << |             |      |       |             |      |      |            |      |      |            |      |      |
| Base Vol:                            | 211         | 715  | 358   | 629         | 811  | 211  | 186        | 245  | 323  | 96         | 327  | 717  |
| Growth Adj:                          | 1.00        | 1.00 | 1.00  | 1.00        | 1.00 | 1.00 | 1.00       | 1.00 | 1.00 | 1.00       | 1.00 | 1.00 |
| Initial Bse:                         | 211         | 715  | 358   | 629         | 811  | 211  | 186        | 245  | 323  | 96         | 327  | 717  |
| Added Vol:                           | 0           | 0    | 0     | 0           | 0    | 0    | 0          | 0    | 0    | 0          | 0    | 0    |
| PasserByVol:                         | 0           | 0    | 0     | 0           | 0    | 0    | 0          | 0    | 0    | 0          | 0    | 0    |
| Initial Fut:                         | 211         | 715  | 358   | 629         | 811  | 211  | 186        | 245  | 323  | 96         | 327  | 717  |
| User Adj:                            | 1.00        | 1.00 | 1.00  | 1.00        | 1.00 | 1.00 | 1.00       | 1.00 | 1.00 | 1.00       | 1.00 | 1.00 |
| PHF Adj:                             | 1.00        | 1.00 | 1.00  | 1.00        | 1.00 | 1.00 | 1.00       | 1.00 | 1.00 | 1.00       | 1.00 | 1.00 |
| PHF Volume:                          | 211         | 715  | 358   | 629         | 811  | 211  | 186        | 245  | 323  | 96         | 327  | 717  |
| Reduct Vol:                          | 0           | 0    | 0     | 0           | 0    | 0    | 0          | 0    | 0    | 0          | 0    | 0    |
| Reduced Vol:                         | 211         | 715  | 358   | 629         | 811  | 211  | 186        | 245  | 323  | 96         | 327  | 717  |
| PCE Adj:                             | 1.00        | 1.00 | 1.00  | 1.00        | 1.00 | 1.00 | 1.00       | 1.00 | 1.00 | 1.00       | 1.00 | 1.00 |
| MLF Adj:                             | 1.00        | 1.00 | 1.00  | 1.00        | 1.00 | 1.00 | 1.00       | 1.00 | 1.00 | 1.00       | 1.00 | 1.00 |
| Final Volume:                        | 211         | 715  | 358   | 629         | 811  | 211  | 186        | 245  | 323  | 96         | 327  | 717  |
| Saturation Flow Module:              |             |      |       |             |      |      |            |      |      |            |      |      |
| Sat/Lane:                            | 1900        | 1900 | 1900  | 1900        | 1900 | 1900 | 1900       | 1900 | 1900 | 1900       | 1900 | 1900 |
| Adjustment:                          | 0.92        | 1.00 | 0.92  | 0.83        | 1.00 | 0.92 | 0.92       | 1.00 | 0.92 | 0.92       | 1.00 | 0.92 |
| Lanes:                               | 1.00        | 2.00 | 1.00  | 2.00        | 2.00 | 1.00 | 1.00       | 1.00 | 1.00 | 1.00       | 1.00 | 1.00 |
| Final Sat.:                          | 1750        | 3800 | 1750  | 3150        | 3800 | 1750 | 1750       | 1900 | 1750 | 1750       | 1900 | 1750 |
| Capacity Analysis Module:            |             |      |       |             |      |      |            |      |      |            |      |      |
| Vol/Sat:                             | 0.12        | 0.19 | 0.20  | 0.20        | 0.21 | 0.12 | 0.11       | 0.13 | 0.18 | 0.05       | 0.17 | 0.41 |
| Crit Moves:                          | ****        | **** | ****  | ****        | **** | **** | ****       | **** | **** | ****       | **** | **** |
| Green Time:                          | 15.5        | 21.8 | 21.8  | 21.3        | 27.5 | 27.5 | 11.3       | 40.9 | 40.9 | 14.1       | 43.6 | 43.6 |
| Volume/Cap:                          | 0.85        | 0.95 | 1.03  | 1.03        | 0.85 | 0.48 | 1.03       | 0.35 | 0.50 | 0.43       | 0.43 | 1.03 |
| Delay/Veh:                           | 69.9        | 65.0 | 101.2 | 89.6        | 46.9 | 36.0 | 125.3      | 25.1 | 27.0 | 45.6       | 24.6 | 76.1 |
| User DelAdj:                         | 1.00        | 1.00 | 1.00  | 1.00        | 1.00 | 1.00 | 1.00       | 1.00 | 1.00 | 1.00       | 1.00 | 1.00 |
| AdjDel/Veh:                          | 69.9        | 65.0 | 101.2 | 89.6        | 46.9 | 36.0 | 125.3      | 25.1 | 27.0 | 45.6       | 24.6 | 76.1 |
| LOS by Move:                         | E           | E    | F     | F           | D    | D    | F          | C    | C    | D          | C    | E    |
| HCM2k95thQ:                          | 16          | 25   | 30    | 33          | 28   | 13   | 17         | 11   | 17   | 7          | 15   | 56   |

Note: Queue reported is the number of cars per lane.

BART

Level Of Service Computation Report  
 2000 HCM Operations (Future Volume Alternative)  
 PM - Cumulative With Project

Intersection #3384: JACKSON/CAPITOL/SAN ANTONIO [Study Int 23]

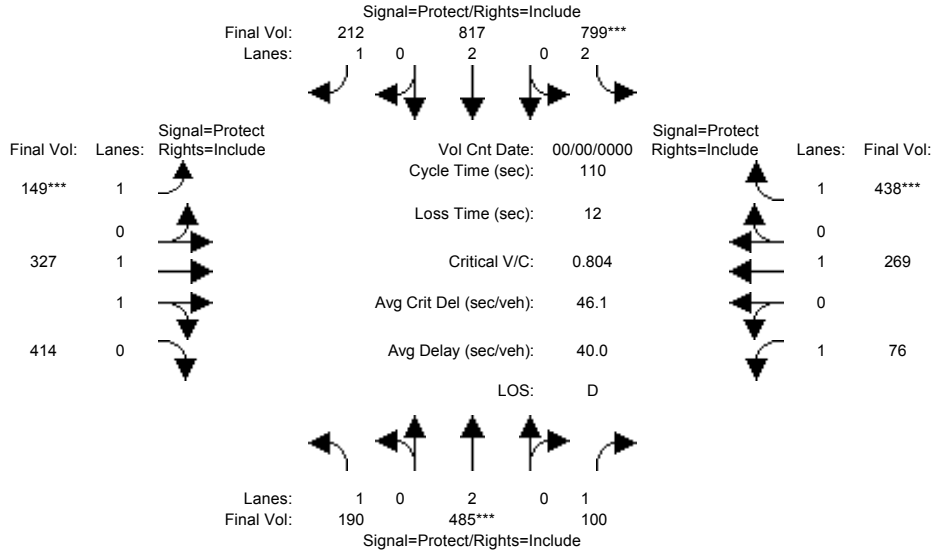

| Approach:                            | North Bound |      |      | South Bound |      |      | East Bound |      |      | West Bound |      |      |
|--------------------------------------|-------------|------|------|-------------|------|------|------------|------|------|------------|------|------|
| Movement:                            | L           | T    | R    | L           | T    | R    | L          | T    | R    | L          | T    | R    |
| Min. Green:                          | 7           | 10   | 10   | 7           | 10   | 10   | 7          | 10   | 10   | 7          | 10   | 10   |
| Y+R:                                 | 4.0         | 4.0  | 4.0  | 4.0         | 4.0  | 4.0  | 4.0        | 4.0  | 4.0  | 4.0        | 4.0  | 4.0  |
| Volume Module: >> Count Date: 0 0 << |             |      |      |             |      |      |            |      |      |            |      |      |
| Base Vol:                            | 190         | 485  | 100  | 799         | 817  | 212  | 149        | 327  | 414  | 76         | 269  | 438  |
| Growth Adj:                          | 1.00        | 1.00 | 1.00 | 1.00        | 1.00 | 1.00 | 1.00       | 1.00 | 1.00 | 1.00       | 1.00 | 1.00 |
| Initial Bse:                         | 190         | 485  | 100  | 799         | 817  | 212  | 149        | 327  | 414  | 76         | 269  | 438  |
| Added Vol:                           | 0           | 0    | 0    | 0           | 0    | 0    | 0          | 0    | 0    | 0          | 0    | 0    |
| PasserByVol:                         | 0           | 0    | 0    | 0           | 0    | 0    | 0          | 0    | 0    | 0          | 0    | 0    |
| Initial Fut:                         | 190         | 485  | 100  | 799         | 817  | 212  | 149        | 327  | 414  | 76         | 269  | 438  |
| User Adj:                            | 1.00        | 1.00 | 1.00 | 1.00        | 1.00 | 1.00 | 1.00       | 1.00 | 1.00 | 1.00       | 1.00 | 1.00 |
| PHF Adj:                             | 1.00        | 1.00 | 1.00 | 1.00        | 1.00 | 1.00 | 1.00       | 1.00 | 1.00 | 1.00       | 1.00 | 1.00 |
| PHF Volume:                          | 190         | 485  | 100  | 799         | 817  | 212  | 149        | 327  | 414  | 76         | 269  | 438  |
| Reduct Vol:                          | 0           | 0    | 0    | 0           | 0    | 0    | 0          | 0    | 0    | 0          | 0    | 0    |
| Reduced Vol:                         | 190         | 485  | 100  | 799         | 817  | 212  | 149        | 327  | 414  | 76         | 269  | 438  |
| PCE Adj:                             | 1.00        | 1.00 | 1.00 | 1.00        | 1.00 | 1.00 | 1.00       | 1.00 | 1.00 | 1.00       | 1.00 | 1.00 |
| MLF Adj:                             | 1.00        | 1.00 | 1.00 | 1.00        | 1.00 | 1.00 | 1.00       | 1.00 | 1.00 | 1.00       | 1.00 | 1.00 |
| Final Volume:                        | 190         | 485  | 100  | 799         | 817  | 212  | 149        | 327  | 414  | 76         | 269  | 438  |
| Saturation Flow Module:              |             |      |      |             |      |      |            |      |      |            |      |      |
| Sat/Lane:                            | 1900        | 1900 | 1900 | 1900        | 1900 | 1900 | 1900       | 1900 | 1900 | 1900       | 1900 | 1900 |
| Adjustment:                          | 0.92        | 1.00 | 0.92 | 0.83        | 1.00 | 0.92 | 0.92       | 1.00 | 0.92 | 0.92       | 1.00 | 0.92 |
| Lanes:                               | 1.00        | 2.00 | 1.00 | 2.00        | 2.00 | 1.00 | 1.00       | 1.00 | 1.00 | 1.00       | 1.00 | 1.00 |
| Final Sat.:                          | 1750        | 3800 | 1750 | 3150        | 3800 | 1750 | 1750       | 1900 | 1750 | 1750       | 1900 | 1750 |
| Capacity Analysis Module:            |             |      |      |             |      |      |            |      |      |            |      |      |
| Vol/Sat:                             | 0.11        | 0.13 | 0.06 | 0.25        | 0.22 | 0.12 | 0.09       | 0.17 | 0.24 | 0.04       | 0.14 | 0.25 |
| Crit Moves:                          | ****        | **** | **** | ****        | **** | **** | ****       | **** | **** | ****       | **** | **** |
| Green Time:                          | 17.5        | 17.5 | 17.5 | 34.7        | 34.6 | 34.6 | 11.6       | 36.1 | 36.1 | 9.7        | 34.2 | 34.2 |
| Volume/Cap:                          | 0.68        | 0.80 | 0.36 | 0.80        | 0.68 | 0.38 | 0.80       | 0.52 | 0.72 | 0.49       | 0.46 | 0.80 |
| Delay/Veh:                           | 50.4        | 52.4 | 42.1 | 39.4        | 34.5 | 29.8 | 70.0       | 30.3 | 35.0 | 50.2       | 31.0 | 43.3 |
| User DelAdj:                         | 1.00        | 1.00 | 1.00 | 1.00        | 1.00 | 1.00 | 1.00       | 1.00 | 1.00 | 1.00       | 1.00 | 1.00 |
| AdjDel/Veh:                          | 50.4        | 52.4 | 42.1 | 39.4        | 34.5 | 29.8 | 70.0       | 30.3 | 35.0 | 50.2       | 31.0 | 43.3 |
| LOS by Move:                         | D           | D    | D    | D           | C    | C    | E          | C    | C    | D          | C    | D    |
| HCM2k95thQ:                          | 13          | 16   | 6    | 29          | 23   | 12   | 11         | 16   | 24   | 7          | 14   | 29   |

Note: Queue reported is the number of cars per lane.

BART

Level Of Service Computation Report  
2000 HCM Operations (Future Volume Alternative)  
AM - Cumulative No Project

Intersection #3411: AVIATION/COLEMAN [Study Int 34]

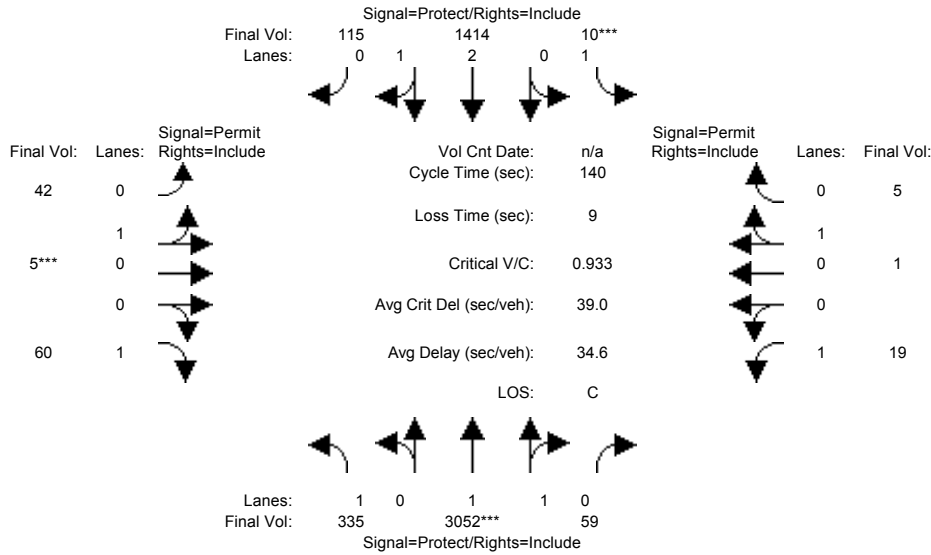

| Approach:                 | North Bound |      |       | South Bound |      |      | East Bound |      |      | West Bound |      |      |
|---------------------------|-------------|------|-------|-------------|------|------|------------|------|------|------------|------|------|
| Movement:                 | L           | T    | R     | L           | T    | R    | L          | T    | R    | L          | T    | R    |
| Min. Green:               | 7           | 10   | 10    | 7           | 10   | 10   | 10         | 10   | 10   | 10         | 10   | 10   |
| Y+R:                      | 4.0         | 4.0  | 4.0   | 4.0         | 4.0  | 4.0  | 4.0        | 4.0  | 4.0  | 4.0        | 4.0  | 4.0  |
| Volume Module:            |             |      |       |             |      |      |            |      |      |            |      |      |
| Base Vol:                 | 335         | 3052 | 59    | 10          | 1414 | 115  | 42         | 5    | 60   | 19         | 1    | 5    |
| Growth Adj:               | 1.00        | 1.00 | 1.00  | 1.00        | 1.00 | 1.00 | 1.00       | 1.00 | 1.00 | 1.00       | 1.00 | 1.00 |
| Initial Bse:              | 335         | 3052 | 59    | 10          | 1414 | 115  | 42         | 5    | 60   | 19         | 1    | 5    |
| Added Vol:                | 0           | 0    | 0     | 0           | 0    | 0    | 0          | 0    | 0    | 0          | 0    | 0    |
| PasserByVol:              | 0           | 0    | 0     | 0           | 0    | 0    | 0          | 0    | 0    | 0          | 0    | 0    |
| Initial Fut:              | 335         | 3052 | 59    | 10          | 1414 | 115  | 42         | 5    | 60   | 19         | 1    | 5    |
| User Adj:                 | 1.00        | 1.00 | 1.00  | 1.00        | 1.00 | 1.00 | 1.00       | 1.00 | 1.00 | 1.00       | 1.00 | 1.00 |
| PHF Adj:                  | 1.00        | 1.00 | 1.00  | 1.00        | 1.00 | 1.00 | 1.00       | 1.00 | 1.00 | 1.00       | 1.00 | 1.00 |
| PHF Volume:               | 335         | 3052 | 59    | 10          | 1414 | 115  | 42         | 5    | 60   | 19         | 1    | 5    |
| Reduct Vol:               | 0           | 0    | 0     | 0           | 0    | 0    | 0          | 0    | 0    | 0          | 0    | 0    |
| Reduced Vol:              | 335         | 3052 | 59    | 10          | 1414 | 115  | 42         | 5    | 60   | 19         | 1    | 5    |
| PCE Adj:                  | 1.00        | 1.00 | 1.00  | 1.00        | 1.00 | 1.00 | 1.00       | 1.00 | 1.00 | 1.00       | 1.00 | 1.00 |
| MLF Adj:                  | 1.00        | 1.00 | 1.00  | 1.00        | 1.00 | 1.00 | 1.00       | 1.00 | 1.00 | 1.00       | 1.00 | 1.00 |
| Final Volume:             | 335         | 3052 | 59    | 10          | 1414 | 115  | 42         | 5    | 60   | 19         | 1    | 5    |
| Saturation Flow Module:   |             |      |       |             |      |      |            |      |      |            |      |      |
| Sat/Lane:                 | 1900        | 1900 | 1900  | 1900        | 1900 | 1900 | 1900       | 1900 | 1900 | 1900       | 1900 | 1900 |
| Adjustment:               | 0.92        | 0.97 | 0.95  | 0.92        | 0.99 | 0.95 | 0.95       | 0.95 | 0.92 | 0.92       | 0.95 | 0.95 |
| Lanes:                    | 1.00        | 1.96 | 0.04  | 1.00        | 2.77 | 0.23 | 0.89       | 0.11 | 1.00 | 1.00       | 0.17 | 0.83 |
| Final Sat.:               | 1750        | 3630 | 70    | 1750        | 5178 | 421  | 1609       | 191  | 1750 | 1750       | 300  | 1500 |
| Capacity Analysis Module: |             |      |       |             |      |      |            |      |      |            |      |      |
| Vol/Sat:                  | 0.19        | 0.84 | 0.84  | 0.01        | 0.27 | 0.27 | 0.03       | 0.03 | 0.03 | 0.01       | 0.00 | 0.00 |
| Crit Moves:               | ****        | **** | ****  | ****        | **** | **** | ****       | **** | **** | ****       | **** | **** |
| Green Time:               | 49.9        | 114  | 114.0 | 7.0         | 71.1 | 71.1 | 10.0       | 10.0 | 10.0 | 10.0       | 10.0 | 10.0 |
| Volume/Cap:               | 0.54        | 1.03 | 1.03  | 0.11        | 0.54 | 0.54 | 0.37       | 0.37 | 0.48 | 0.15       | 0.05 | 0.05 |
| Delay/Veh:                | 36.8        | 38.5 | 38.5  | 64.1        | 23.5 | 23.5 | 63.7       | 63.7 | 65.4 | 61.6       | 60.7 | 60.7 |
| User DelAdj:              | 1.00        | 1.00 | 1.00  | 1.00        | 1.00 | 1.00 | 1.00       | 1.00 | 1.00 | 1.00       | 1.00 | 1.00 |
| AdjDel/Veh:               | 36.8        | 38.5 | 38.5  | 64.1        | 23.5 | 23.5 | 63.7       | 63.7 | 65.4 | 61.6       | 60.7 | 60.7 |
| LOS by Move:              | D           | D    | D     | E           | C    | C    | E          | E    | E    | E          | E    | E    |
| HCM2k95thQ:               | 21          | 115  | 115   | 1           | 26   | 26   | 5          | 5    | 7    | 2          | 1    | 1    |

Note: Queue reported is the number of cars per lane.

BART

Level Of Service Computation Report  
2000 HCM Operations (Future Volume Alternative)  
PM - Cumulative No Project

Intersection #3411: AVIATION/COLEMAN [Study Int 34]

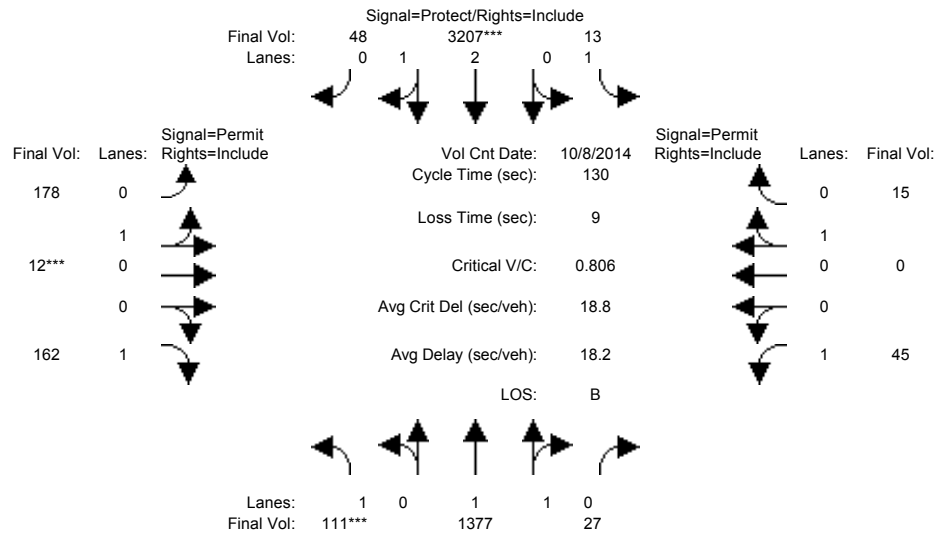

| Approach:                                   | North Bound |      |      | South Bound |      |      | East Bound |      |      | West Bound |      |      |
|---|-------------|------|------|-------------|------|------|------------|------|------|------------|------|------|
| Movement:                                   | L           | T    | R    | L           | T    | R    | L          | T    | R    | L          | T    | R    |
| Min. Green:                                 | 7           | 10   | 10   | 7           | 10   | 10   | 10         | 10   | 10   | 10         | 10   | 10   |
| Y+R:  | 4.0         | 4.0  | 4.0  | 4.0         | 4.0  | 4.0  | 4.0        | 4.0  | 4.0  | 4.0        | 4.0  | 4.0  |
| Volume Module: >> Count Date: 8 Oct 2014 << |             |      |      |             |      |      |            |      |      |            |      |      |
| Base Vol:                                   | 111         | 1377 | 27   | 13          | 3207 | 48   | 178        | 12   | 162  | 45         | 0    | 15   |
| Growth Adj:                                 | 1.00        | 1.00 | 1.00 | 1.00        | 1.00 | 1.00 | 1.00       | 1.00 | 1.00 | 1.00       | 1.00 | 1.00 |
| Initial Bse:                                | 111         | 1377 | 27   | 13          | 3207 | 48   | 178        | 12   | 162  | 45         | 0    | 15   |
| Added Vol:                                  | 0           | 0    | 0    | 0           | 0    | 0    | 0          | 0    | 0    | 0          | 0    | 0    |
| PasserByVol:                                | 0           | 0    | 0    | 0           | 0    | 0    | 0          | 0    | 0    | 0          | 0    | 0    |
| Initial Fut:                                | 111         | 1377 | 27   | 13          | 3207 | 48   | 178        | 12   | 162  | 45         | 0    | 15   |
| User Adj:                                   | 1.00        | 1.00 | 1.00 | 1.00        | 1.00 | 1.00 | 1.00       | 1.00 | 1.00 | 1.00       | 1.00 | 1.00 |
| PHF Adj:                                    | 1.00        | 1.00 | 1.00 | 1.00        | 1.00 | 1.00 | 1.00       | 1.00 | 1.00 | 1.00       | 1.00 | 1.00 |
| PHF Volume:                                 | 111         | 1377 | 27   | 13          | 3207 | 48   | 178        | 12   | 162  | 45         | 0    | 15   |
| Reduct Vol:                                 | 0           | 0    | 0    | 0           | 0    | 0    | 0          | 0    | 0    | 0          | 0    | 0    |
| Reduced Vol:                                | 111         | 1377 | 27   | 13          | 3207 | 48   | 178        | 12   | 162  | 45         | 0    | 15   |
| PCE Adj:                                    | 1.00        | 1.00 | 1.00 | 1.00        | 1.00 | 1.00 | 1.00       | 1.00 | 1.00 | 1.00       | 1.00 | 1.00 |
| MLF Adj:                                    | 1.00        | 1.00 | 1.00 | 1.00        | 1.00 | 1.00 | 1.00       | 1.00 | 1.00 | 1.00       | 1.00 | 1.00 |
| Final Volume:                               | 111         | 1377 | 27   | 13          | 3207 | 48   | 178        | 12   | 162  | 45         | 0    | 15   |
| Saturation Flow Module:                     |             |      |      |             |      |      |            |      |      |            |      |      |
| Sat/Lane:                                   | 1900        | 1900 | 1900 | 1900        | 1900 | 1900 | 1900       | 1900 | 1900 | 1900       | 1900 | 1900 |
| Adjustment:                                 | 0.92        | 0.97 | 0.95 | 0.92        | 0.98 | 0.95 | 0.95       | 0.95 | 0.92 | 0.92       | 1.00 | 0.95 |
| Lanes:                                      | 1.00        | 1.96 | 0.04 | 1.00        | 2.95 | 0.05 | 0.94       | 0.06 | 1.00 | 1.00       | 0.00 | 1.00 |
| Final Sat.:                                 | 1750        | 3629 | 71   | 1750        | 5517 | 83   | 1686       | 114  | 1750 | 1750       | 0    | 1800 |
| Capacity Analysis Module:                   |             |      |      |             |      |      |            |      |      |            |      |      |
| Vol/Sat:                                    | 0.06        | 0.38 | 0.38 | 0.01        | 0.58 | 0.58 | 0.11       | 0.11 | 0.09 | 0.03       | 0.00 | 0.01 |
| Crit Moves:                                 | ****        |      |      | ****        |      |      | ****       |      |      |            |      |      |
| Green Time:                                 | 10.2        | 91.1 | 91.1 | 12.9        | 93.7 | 93.7 | 17.0       | 17.0 | 17.0 | 17.0       | 17.0 | 17.0 |
| Volume/Cap:                                 | 0.81        | 0.54 | 0.54 | 0.07        | 0.81 | 0.81 | 0.81       | 0.81 | 0.71 | 0.20       | 0.00 | 0.06 |
| Delay/Veh:                                  | 87.2        | 9.6  | 9.6  | 53.3        | 13.3 | 13.3 | 73.0       | 73.0 | 63.8 | 50.8       | 0.0  | 49.6 |
| User DelAdj:                                | 1.00        | 1.00 | 1.00 | 1.00        | 1.00 | 1.00 | 1.00       | 1.00 | 1.00 | 1.00       | 1.00 | 1.00 |
| AdjDel/Veh:                                 | 87.2        | 9.6  | 9.6  | 53.3        | 13.3 | 13.3 | 73.0       | 73.0 | 63.8 | 50.8       | 0.0  | 49.6 |
| LOS by Move:                                | F           | A    | A    | D           | B    | B    | E          | E    | E    | D          | A    | D    |
| HCM2k95thQ:                                 | 10          | 24   | 24   | 1           | 44   | 44   | 18         | 18   | 15   | 4          | 0    | 1    |

Note: Queue reported is the number of cars per lane.

BART

Level Of Service Computation Report  
 2000 HCM Operations (Future Volume Alternative)  
 AM - Cumulative With Project

Intersection #3411: AVIATION/COLEMAN [Study Int 34]

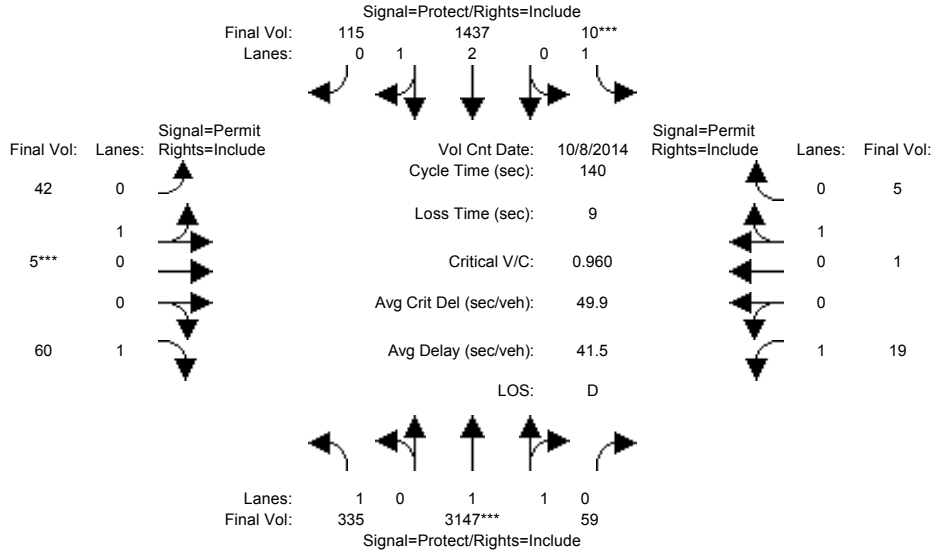

| Approach:                                   | North Bound |      |       | South Bound |      |      | East Bound |      |      | West Bound |      |      |
|---|-------------|------|-------|-------------|------|------|------------|------|------|------------|------|------|
| Movement:                                   | L           | T    | R     | L           | T    | R    | L          | T    | R    | L          | T    | R    |
| Min. Green:                                 | 7           | 10   | 10    | 7           | 10   | 10   | 10         | 10   | 10   | 10         | 10   | 10   |
| Y+R:  | 4.0         | 4.0  | 4.0   | 4.0         | 4.0  | 4.0  | 4.0        | 4.0  | 4.0  | 4.0        | 4.0  | 4.0  |
| Volume Module: >> Count Date: 8 Oct 2014 << |             |      |       |             |      |      |            |      |      |            |      |      |
| Base Vol:                                   | 335         | 3147 | 59    | 10          | 1437 | 115  | 42         | 5    | 60   | 19         | 1    | 5    |
| Growth Adj:                                 | 1.00        | 1.00 | 1.00  | 1.00        | 1.00 | 1.00 | 1.00       | 1.00 | 1.00 | 1.00       | 1.00 | 1.00 |
| Initial Bse:                                | 335         | 3147 | 59    | 10          | 1437 | 115  | 42         | 5    | 60   | 19         | 1    | 5    |
| Added Vol:                                  | 0           | 0    | 0     | 0           | 0    | 0    | 0          | 0    | 0    | 0          | 0    | 0    |
| PasserByVol:                                | 0           | 0    | 0     | 0           | 0    | 0    | 0          | 0    | 0    | 0          | 0    | 0    |
| Initial Fut:                                | 335         | 3147 | 59    | 10          | 1437 | 115  | 42         | 5    | 60   | 19         | 1    | 5    |
| User Adj:                                   | 1.00        | 1.00 | 1.00  | 1.00        | 1.00 | 1.00 | 1.00       | 1.00 | 1.00 | 1.00       | 1.00 | 1.00 |
| PHF Adj:                                    | 1.00        | 1.00 | 1.00  | 1.00        | 1.00 | 1.00 | 1.00       | 1.00 | 1.00 | 1.00       | 1.00 | 1.00 |
| PHF Volume:                                 | 335         | 3147 | 59    | 10          | 1437 | 115  | 42         | 5    | 60   | 19         | 1    | 5    |
| Reduct Vol:                                 | 0           | 0    | 0     | 0           | 0    | 0    | 0          | 0    | 0    | 0          | 0    | 0    |
| Reduced Vol:                                | 335         | 3147 | 59    | 10          | 1437 | 115  | 42         | 5    | 60   | 19         | 1    | 5    |
| PCE Adj:                                    | 1.00        | 1.00 | 1.00  | 1.00        | 1.00 | 1.00 | 1.00       | 1.00 | 1.00 | 1.00       | 1.00 | 1.00 |
| MLF Adj:                                    | 1.00        | 1.00 | 1.00  | 1.00        | 1.00 | 1.00 | 1.00       | 1.00 | 1.00 | 1.00       | 1.00 | 1.00 |
| Final Volume:                               | 335         | 3147 | 59    | 10          | 1437 | 115  | 42         | 5    | 60   | 19         | 1    | 5    |
| Saturation Flow Module:                     |             |      |       |             |      |      |            |      |      |            |      |      |
| Sat/Lane:                                   | 1900        | 1900 | 1900  | 1900        | 1900 | 1900 | 1900       | 1900 | 1900 | 1900       | 1900 | 1900 |
| Adjustment:                                 | 0.92        | 0.97 | 0.95  | 0.92        | 0.99 | 0.95 | 0.95       | 0.95 | 0.92 | 0.92       | 0.95 | 0.95 |
| Lanes:                                      | 1.00        | 1.96 | 0.04  | 1.00        | 2.77 | 0.23 | 0.89       | 0.11 | 1.00 | 1.00       | 0.17 | 0.83 |
| Final Sat.:                                 | 1750        | 3632 | 68    | 1750        | 5185 | 415  | 1609       | 191  | 1750 | 1750       | 300  | 1500 |
| Capacity Analysis Module:                   |             |      |       |             |      |      |            |      |      |            |      |      |
| Vol/Sat:                                    | 0.19        | 0.87 | 0.87  | 0.01        | 0.28 | 0.28 | 0.03       | 0.03 | 0.03 | 0.01       | 0.00 | 0.00 |
| Crit Moves:                                 | ****        | **** | ****  | ****        | **** | **** | ****       | **** | **** | ****       | **** | **** |
| Green Time:                                 | 49.4        | 114  | 114.0 | 7.0         | 71.6 | 71.6 | 10.0       | 10.0 | 10.0 | 10.0       | 10.0 | 10.0 |
| Volume/Cap:                                 | 0.54        | 1.06 | 1.06  | 0.11        | 0.54 | 0.54 | 0.37       | 0.37 | 0.48 | 0.15       | 0.05 | 0.05 |
| Delay/Veh:                                  | 37.2        | 49.7 | 49.7  | 64.1        | 23.4 | 23.4 | 63.7       | 63.7 | 65.4 | 61.6       | 60.7 | 60.7 |
| User DelAdj:                                | 1.00        | 1.00 | 1.00  | 1.00        | 1.00 | 1.00 | 1.00       | 1.00 | 1.00 | 1.00       | 1.00 | 1.00 |
| AdjDel/Veh:                                 | 37.2        | 49.7 | 49.7  | 64.1        | 23.4 | 23.4 | 63.7       | 63.7 | 65.4 | 61.6       | 60.7 | 60.7 |
| LOS by Move:                                | D           | D    | D     | E           | C    | C    | E          | E    | E    | E          | E    | E    |
| HCM2k95thQ:                                 | 21          | 124  | 124   | 1           | 26   | 26   | 5          | 5    | 7    | 2          | 1    | 1    |

Note: Queue reported is the number of cars per lane.

BART

Level Of Service Computation Report  
2000 HCM Operations (Future Volume Alternative)  
PM - Cumulative With Project

Intersection #3411: AVIATION/COLEMAN [Study Int 34]

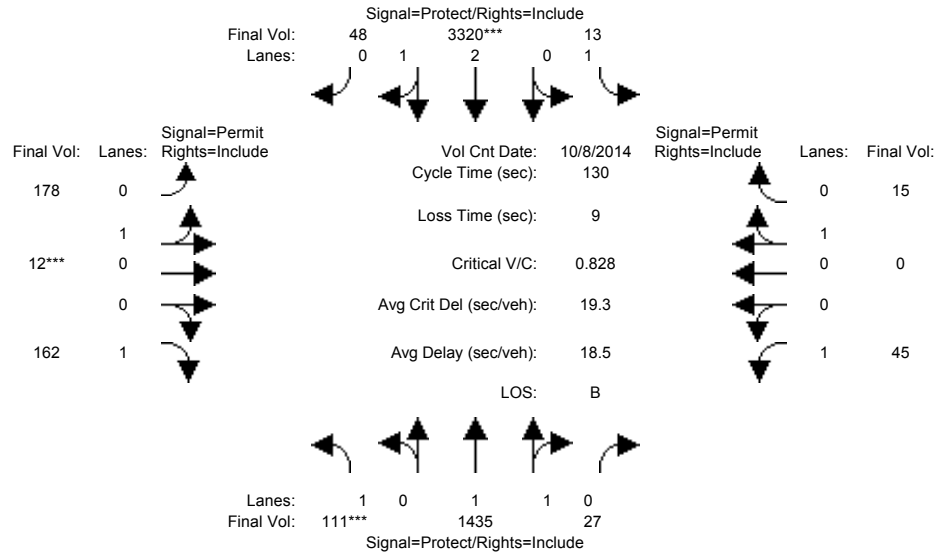

| Approach:                 | North Bound                  |      |      | South Bound |      |      | East Bound |      |      | West Bound |      |      |
|---------------------------|------------------------------|------|------|-------------|------|------|------------|------|------|------------|------|------|
| Movement:                 | L                            | T    | R    | L           | T    | R    | L          | T    | R    | L          | T    | R    |
| Min. Green:               | 7                            | 10   | 10   | 7           | 10   | 10   | 10         | 10   | 10   | 10         | 10   | 10   |
| Y+R:                      | 4.0                          | 4.0  | 4.0  | 4.0         | 4.0  | 4.0  | 4.0        | 4.0  | 4.0  | 4.0        | 4.0  | 4.0  |
| -----                     |                              |      |      |             |      |      |            |      |      |            |      |      |
| Volume Module:            | >> Count Date: 8 Oct 2014 << |      |      |             |      |      |            |      |      |            |      |      |
| Base Vol:                 | 111                          | 1435 | 27   | 13          | 3320 | 48   | 178        | 12   | 162  | 45         | 0    | 15   |
| Growth Adj:               | 1.00                         | 1.00 | 1.00 | 1.00        | 1.00 | 1.00 | 1.00       | 1.00 | 1.00 | 1.00       | 1.00 | 1.00 |
| Initial Bse:              | 111                          | 1435 | 27   | 13          | 3320 | 48   | 178        | 12   | 162  | 45         | 0    | 15   |
| Added Vol:                | 0                            | 0    | 0    | 0           | 0    | 0    | 0          | 0    | 0    | 0          | 0    | 0    |
| PasserByVol:              | 0                            | 0    | 0    | 0           | 0    | 0    | 0          | 0    | 0    | 0          | 0    | 0    |
| Initial Fut:              | 111                          | 1435 | 27   | 13          | 3320 | 48   | 178        | 12   | 162  | 45         | 0    | 15   |
| User Adj:                 | 1.00                         | 1.00 | 1.00 | 1.00        | 1.00 | 1.00 | 1.00       | 1.00 | 1.00 | 1.00       | 1.00 | 1.00 |
| PHF Adj:                  | 1.00                         | 1.00 | 1.00 | 1.00        | 1.00 | 1.00 | 1.00       | 1.00 | 1.00 | 1.00       | 1.00 | 1.00 |
| PHF Volume:               | 111                          | 1435 | 27   | 13          | 3320 | 48   | 178        | 12   | 162  | 45         | 0    | 15   |
| Reduct Vol:               | 0                            | 0    | 0    | 0           | 0    | 0    | 0          | 0    | 0    | 0          | 0    | 0    |
| Reduced Vol:              | 111                          | 1435 | 27   | 13          | 3320 | 48   | 178        | 12   | 162  | 45         | 0    | 15   |
| PCE Adj:                  | 1.00                         | 1.00 | 1.00 | 1.00        | 1.00 | 1.00 | 1.00       | 1.00 | 1.00 | 1.00       | 1.00 | 1.00 |
| MLF Adj:                  | 1.00                         | 1.00 | 1.00 | 1.00        | 1.00 | 1.00 | 1.00       | 1.00 | 1.00 | 1.00       | 1.00 | 1.00 |
| Final Volume:             | 111                          | 1435 | 27   | 13          | 3320 | 48   | 178        | 12   | 162  | 45         | 0    | 15   |
| -----                     |                              |      |      |             |      |      |            |      |      |            |      |      |
| Saturation Flow Module:   |                              |      |      |             |      |      |            |      |      |            |      |      |
| Sat/Lane:                 | 1900                         | 1900 | 1900 | 1900        | 1900 | 1900 | 1900       | 1900 | 1900 | 1900       | 1900 | 1900 |
| Adjustment:               | 0.92                         | 0.97 | 0.95 | 0.92        | 0.98 | 0.95 | 0.95       | 0.95 | 0.92 | 0.92       | 1.00 | 0.95 |
| Lanes:                    | 1.00                         | 1.96 | 0.04 | 1.00        | 2.96 | 0.04 | 0.94       | 0.06 | 1.00 | 1.00       | 0.00 | 1.00 |
| Final Sat.:               | 1750                         | 3632 | 68   | 1750        | 5520 | 80   | 1686       | 114  | 1750 | 1750       | 0    | 1800 |
| -----                     |                              |      |      |             |      |      |            |      |      |            |      |      |
| Capacity Analysis Module: |                              |      |      |             |      |      |            |      |      |            |      |      |
| Vol/Sat:                  | 0.06                         | 0.40 | 0.40 | 0.01        | 0.60 | 0.60 | 0.11       | 0.11 | 0.09 | 0.03       | 0.00 | 0.01 |
| Crit Moves:               | ****                         |      |      | ****        |      |      | ****       |      |      |            |      |      |
| Green Time:               | 10.0                         | 91.9 | 91.9 | 12.5        | 94.5 | 94.5 | 16.6       | 16.6 | 16.6 | 16.6       | 0.0  | 16.6 |
| Volume/Cap:               | 0.83                         | 0.56 | 0.56 | 0.08        | 0.83 | 0.83 | 0.83       | 0.83 | 0.73 | 0.20       | 0.00 | 0.07 |
| Delay/Veh:                | 92.0                         | 9.5  | 9.5  | 53.7        | 13.7 | 13.7 | 76.7       | 76.7 | 65.8 | 51.2       | 0.0  | 50.0 |
| User DelAdj:              | 1.00                         | 1.00 | 1.00 | 1.00        | 1.00 | 1.00 | 1.00       | 1.00 | 1.00 | 1.00       | 1.00 | 1.00 |
| AdjDel/Veh:               | 92.0                         | 9.5  | 9.5  | 53.7        | 13.7 | 13.7 | 76.7       | 76.7 | 65.8 | 51.2       | 0.0  | 50.0 |
| LOS by Move:              | F                            | A    | A    | D           | B    | B    | E          | E    | E    | D          | A    | D    |
| HCM2k95thQ:               | 10                           | 25   | 25   | 1           | 47   | 47   | 19         | 19   | 15   | 4          | 0    | 1    |

Note: Queue reported is the number of cars per lane.

BART

Level Of Service Computation Report  
 2000 HCM Operations (Future Volume Alternative)  
 AM - Cumulative No Project

Intersection #3413: Coleman/Hedding [Study Int 38]

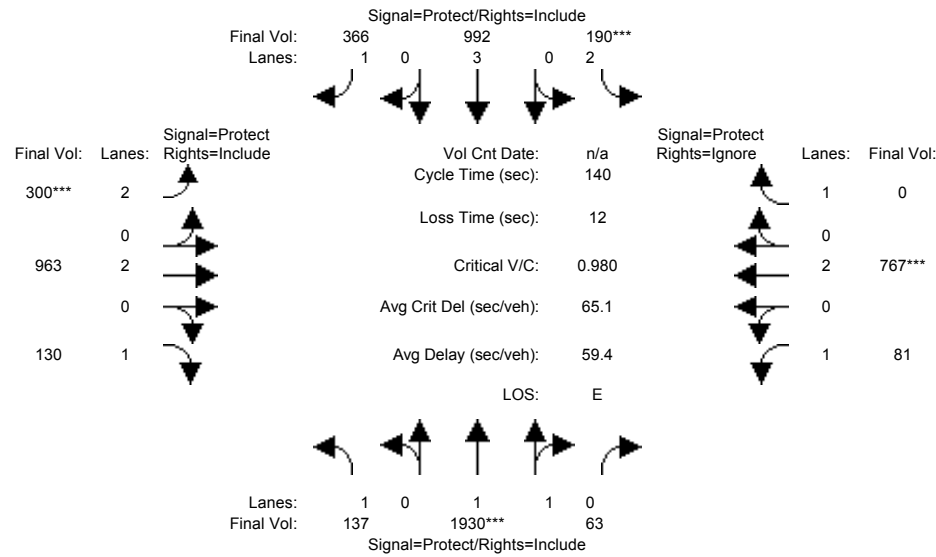

| Approach:                 | North Bound |      |      | South Bound |      |      | East Bound |      |      | West Bound |      |      |
|---------------------------|-------------|------|------|-------------|------|------|------------|------|------|------------|------|------|
| Movement:                 | L           | T    | R    | L           | T    | R    | L          | T    | R    | L          | T    | R    |
| Min. Green:               | 7           | 10   | 10   | 7           | 10   | 10   | 7          | 10   | 10   | 7          | 10   | 10   |
| Y+R:                      | 4.0         | 4.0  | 4.0  | 4.0         | 4.0  | 4.0  | 4.0        | 4.0  | 4.0  | 4.0        | 4.0  | 4.0  |
| Volume Module:            |             |      |      |             |      |      |            |      |      |            |      |      |
| Base Vol:                 | 137         | 1930 | 63   | 190         | 992  | 366  | 300        | 963  | 130  | 81         | 767  | 1001 |
| Growth Adj:               | 1.00        | 1.00 | 1.00 | 1.00        | 1.00 | 1.00 | 1.00       | 1.00 | 1.00 | 1.00       | 1.00 | 1.00 |
| Initial Bse:              | 137         | 1930 | 63   | 190         | 992  | 366  | 300        | 963  | 130  | 81         | 767  | 1001 |
| Added Vol:                | 0           | 0    | 0    | 0           | 0    | 0    | 0          | 0    | 0    | 0          | 0    | 0    |
| PasserByVol:              | 0           | 0    | 0    | 0           | 0    | 0    | 0          | 0    | 0    | 0          | 0    | 0    |
| Initial Fut:              | 137         | 1930 | 63   | 190         | 992  | 366  | 300        | 963  | 130  | 81         | 767  | 1001 |
| User Adj:                 | 1.00        | 1.00 | 1.00 | 1.00        | 1.00 | 1.00 | 1.00       | 1.00 | 1.00 | 1.00       | 1.00 | 0.00 |
| PHF Adj:                  | 1.00        | 1.00 | 1.00 | 1.00        | 1.00 | 1.00 | 1.00       | 1.00 | 1.00 | 1.00       | 1.00 | 0.00 |
| PHF Volume:               | 137         | 1930 | 63   | 190         | 992  | 366  | 300        | 963  | 130  | 81         | 767  | 0    |
| Reduct Vol:               | 0           | 0    | 0    | 0           | 0    | 0    | 0          | 0    | 0    | 0          | 0    | 0    |
| Reduced Vol:              | 137         | 1930 | 63   | 190         | 992  | 366  | 300        | 963  | 130  | 81         | 767  | 0    |
| PCE Adj:                  | 1.00        | 1.00 | 1.00 | 1.00        | 1.00 | 1.00 | 1.00       | 1.00 | 1.00 | 1.00       | 1.00 | 0.00 |
| MLF Adj:                  | 1.00        | 1.00 | 1.00 | 1.00        | 1.00 | 1.00 | 1.00       | 1.00 | 1.00 | 1.00       | 1.00 | 0.00 |
| Final Volume:             | 137         | 1930 | 63   | 190         | 992  | 366  | 300        | 963  | 130  | 81         | 767  | 0    |
| Saturation Flow Module:   |             |      |      |             |      |      |            |      |      |            |      |      |
| Sat/Lane:                 | 1900        | 1900 | 1900 | 1900        | 1900 | 1900 | 1900       | 1900 | 1900 | 1900       | 1900 | 1900 |
| Adjustment:               | 0.92        | 0.97 | 0.95 | 0.83        | 0.83 | 0.92 | 0.83       | 1.00 | 0.92 | 0.92       | 1.00 | 0.92 |
| Lanes:                    | 1.00        | 1.94 | 0.06 | 2.00        | 3.00 | 1.00 | 2.00       | 2.00 | 1.00 | 1.00       | 2.00 | 1.00 |
| Final Sat.:               | 1750        | 3583 | 117  | 3150        | 4750 | 1750 | 3150       | 3800 | 1750 | 1750       | 3800 | 1750 |
| Capacity Analysis Module: |             |      |      |             |      |      |            |      |      |            |      |      |
| Vol/Sat:                  | 0.08        | 0.54 | 0.54 | 0.06        | 0.21 | 0.21 | 0.10       | 0.25 | 0.07 | 0.05       | 0.20 | 0.00 |
| Crit Moves:               | ****        | **** | **** | ****        | **** | **** | ****       | **** | **** | ****       | **** | **** |
| Green Time:               | 23.3        | 76.9 | 76.9 | 8.6         | 62.3 | 62.3 | 13.6       | 35.4 | 35.4 | 7.0        | 28.8 | 0.0  |
| Volume/Cap:               | 0.47        | 0.98 | 0.98 | 0.98        | 0.47 | 0.47 | 0.98       | 1.00 | 0.29 | 0.93       | 0.98 | 0.00 |
| Delay/Veh:                | 54.0        | 46.2 | 46.2 | 124.2       | 27.4 | 27.7 | 108.9      | 81.6 | 42.6 | 138.0      | 82.5 | 0.0  |
| User DelAdj:              | 1.00        | 1.00 | 1.00 | 1.00        | 1.00 | 1.00 | 1.00       | 1.00 | 1.00 | 1.00       | 1.00 | 1.00 |
| AdjDel/Veh:               | 54.0        | 46.2 | 46.2 | 124.2       | 27.4 | 27.7 | 108.9      | 81.6 | 42.6 | 138.0      | 82.5 | 0.0  |
| LOS by Move:              | D           | D    | D    | F           | C    | C    | F          | F    | D    | F          | F    | A    |
| HCM2k95thQ:               | 10          | 64   | 64   | 12          | 18   | 21   | 16         | 38   | 9    | 12         | 36   | 0    |

Note: Queue reported is the number of cars per lane.



BART

Level Of Service Computation Report  
 2000 HCM Operations (Future Volume Alternative)  
 PM - Cumulative No Project

Intersection #3413: Coleman/Hedding [Study Int 38]

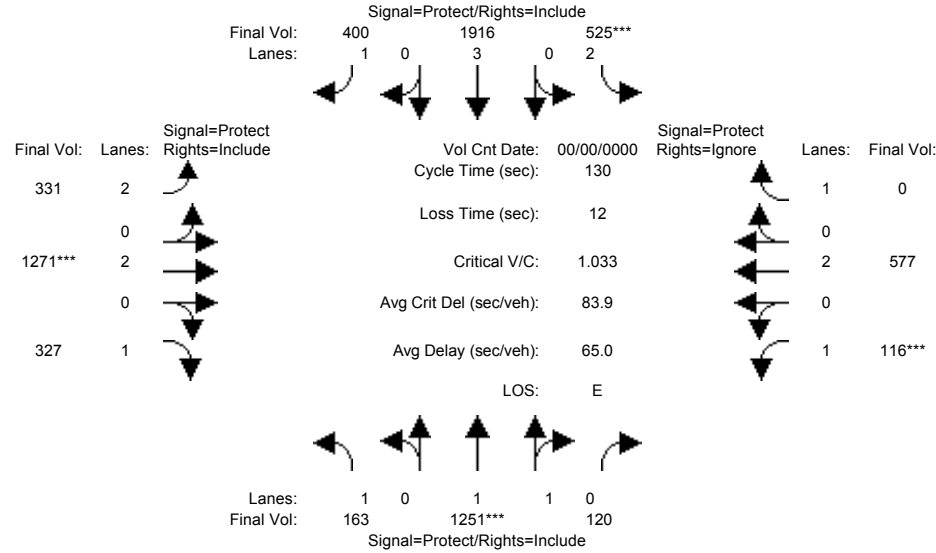

| Approach:                            | North Bound |      |      | South Bound |      |      | East Bound |      |      | West Bound |      |      |
|--------------------------------------|-------------|------|------|-------------|------|------|------------|------|------|------------|------|------|
| Movement:                            | L           | T    | R    | L           | T    | R    | L          | T    | R    | L          | T    | R    |
| Min. Green:                          | 7           | 10   | 10   | 7           | 10   | 10   | 7          | 10   | 10   | 7          | 10   | 10   |
| Y+R:                                 | 4.0         | 4.0  | 4.0  | 4.0         | 4.0  | 4.0  | 4.0        | 4.0  | 4.0  | 4.0        | 4.0  | 4.0  |
| Volume Module: >> Count Date: 0 0 << |             |      |      |             |      |      |            |      |      |            |      |      |
| Base Vol:                            | 163         | 1251 | 120  | 525         | 1916 | 400  | 331        | 1271 | 327  | 116        | 577  | 479  |
| Growth Adj:                          | 1.00        | 1.00 | 1.00 | 1.00        | 1.00 | 1.00 | 1.00       | 1.00 | 1.00 | 1.00       | 1.00 | 1.00 |
| Initial Bse:                         | 163         | 1251 | 120  | 525         | 1916 | 400  | 331        | 1271 | 327  | 116        | 577  | 479  |
| Added Vol:                           | 0           | 0    | 0    | 0           | 0    | 0    | 0          | 0    | 0    | 0          | 0    | 0    |
| PasserByVol:                         | 0           | 0    | 0    | 0           | 0    | 0    | 0          | 0    | 0    | 0          | 0    | 0    |
| Initial Fut:                         | 163         | 1251 | 120  | 525         | 1916 | 400  | 331        | 1271 | 327  | 116        | 577  | 479  |
| User Adj:                            | 1.00        | 1.00 | 1.00 | 1.00        | 1.00 | 1.00 | 1.00       | 1.00 | 1.00 | 1.00       | 1.00 | 0.00 |
| PHF Adj:                             | 1.00        | 1.00 | 1.00 | 1.00        | 1.00 | 1.00 | 1.00       | 1.00 | 1.00 | 1.00       | 1.00 | 0.00 |
| PHF Volume:                          | 163         | 1251 | 120  | 525         | 1916 | 400  | 331        | 1271 | 327  | 116        | 577  | 0    |
| Reduct Vol:                          | 0           | 0    | 0    | 0           | 0    | 0    | 0          | 0    | 0    | 0          | 0    | 0    |
| Reduced Vol:                         | 163         | 1251 | 120  | 525         | 1916 | 400  | 331        | 1271 | 327  | 116        | 577  | 0    |
| PCE Adj:                             | 1.00        | 1.00 | 1.00 | 1.00        | 1.00 | 1.00 | 1.00       | 1.00 | 1.00 | 1.00       | 1.00 | 0.00 |
| MLF Adj:                             | 1.00        | 1.00 | 1.00 | 1.00        | 1.00 | 1.00 | 1.00       | 1.00 | 1.00 | 1.00       | 1.00 | 0.00 |
| Final Volume:                        | 163         | 1251 | 120  | 525         | 1916 | 400  | 331        | 1271 | 327  | 116        | 577  | 0    |
| Saturation Flow Module:              |             |      |      |             |      |      |            |      |      |            |      |      |
| Sat/Lane:                            | 1900        | 1900 | 1900 | 1900        | 1900 | 1900 | 1900       | 1900 | 1900 | 1900       | 1900 | 1900 |
| Adjustment:                          | 0.92        | 0.98 | 0.95 | 0.83        | 0.83 | 0.92 | 0.83       | 1.00 | 0.92 | 0.92       | 1.00 | 0.92 |
| Lanes:                               | 1.00        | 1.82 | 0.18 | 2.00        | 3.00 | 1.00 | 2.00       | 2.00 | 1.00 | 1.00       | 2.00 | 1.00 |
| Final Sat.:                          | 1750        | 3376 | 324  | 3150        | 4750 | 1750 | 3150       | 3800 | 1750 | 1750       | 3800 | 1750 |
| Capacity Analysis Module:            |             |      |      |             |      |      |            |      |      |            |      |      |
| Vol/Sat:                             | 0.09        | 0.37 | 0.37 | 0.17        | 0.40 | 0.23 | 0.11       | 0.33 | 0.19 | 0.07       | 0.15 | 0.00 |
| Crit Moves:                          | ****        | **** | **** | ****        | **** | **** | ****       | **** | **** | ****       | **** | **** |
| Green Time:                          | 12.7        | 46.6 | 46.6 | 21.0        | 54.9 | 54.9 | 20.6       | 42.1 | 42.1 | 8.3        | 29.8 | 0.0  |
| Volume/Cap:                          | 0.96        | 1.03 | 1.03 | 1.03        | 0.96 | 0.54 | 0.66       | 1.03 | 0.58 | 1.03       | 0.66 | 0.00 |
| Delay/Veh:                           | 113.9       | 75.4 | 75.4 | 103.3       | 47.7 | 28.9 | 54.7       | 78.6 | 38.0 | 155.0      | 47.5 | 0.0  |
| User DelAdj:                         | 1.00        | 1.00 | 1.00 | 1.00        | 1.00 | 1.00 | 1.00       | 1.00 | 1.00 | 1.00       | 1.00 | 1.00 |
| AdjDel/Veh:                          | 113.9       | 75.4 | 75.4 | 103.3       | 47.7 | 28.9 | 54.7       | 78.6 | 38.0 | 155.0      | 47.5 | 0.0  |
| LOS by Move:                         | F           | E    | E    | F           | D    | C    | D          | E    | D    | F          | D    | A    |
| HCM2k95thQ:                          | 13          | 48   | 48   | 27          | 44   | 22   | 13         | 44   | 20   | 16         | 20   | 0    |

Note: Queue reported is the number of cars per lane.

BART

Level Of Service Computation Report  
 2000 HCM Operations (Future Volume Alternative)  
 AM - Cumulative With Project

Intersection #3413: Coleman/Hedding [Study Int 38]

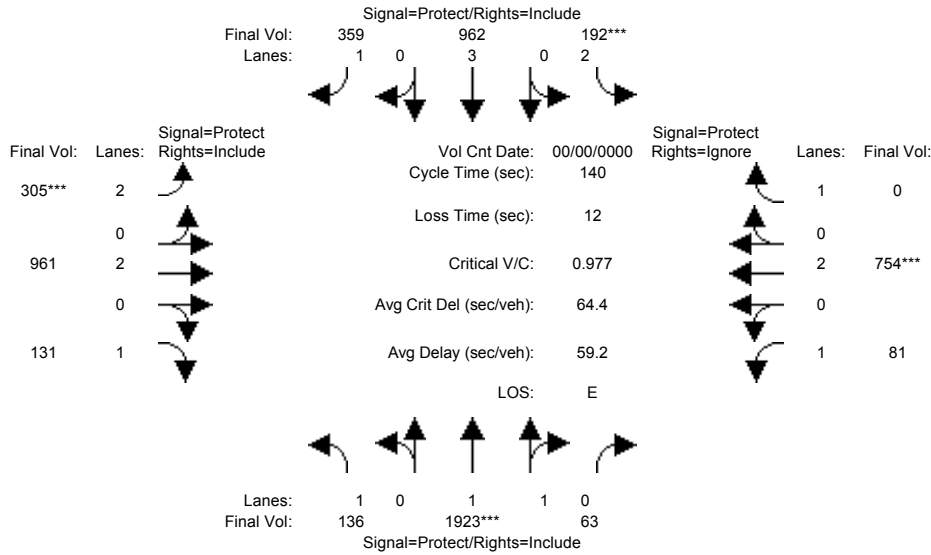

| Approach:                            | North Bound |      |      | South Bound |      |      | East Bound |      |      | West Bound |      |      |
|--------------------------------------|-------------|------|------|-------------|------|------|------------|------|------|------------|------|------|
| Movement:                            | L           | T    | R    | L           | T    | R    | L          | T    | R    | L          | T    | R    |
| Min. Green:                          | 7           | 10   | 10   | 7           | 10   | 10   | 7          | 10   | 10   | 7          | 10   | 10   |
| Y+R:                                 | 4.0         | 4.0  | 4.0  | 4.0         | 4.0  | 4.0  | 4.0        | 4.0  | 4.0  | 4.0        | 4.0  | 4.0  |
| Volume Module: >> Count Date: 0 0 << |             |      |      |             |      |      |            |      |      |            |      |      |
| Base Vol:                            | 136         | 1923 | 63   | 192         | 962  | 359  | 305        | 961  | 131  | 81         | 754  | 1000 |
| Growth Adj:                          | 1.00        | 1.00 | 1.00 | 1.00        | 1.00 | 1.00 | 1.00       | 1.00 | 1.00 | 1.00       | 1.00 | 1.00 |
| Initial Bse:                         | 136         | 1923 | 63   | 192         | 962  | 359  | 305        | 961  | 131  | 81         | 754  | 1000 |
| Added Vol:                           | 0           | 0    | 0    | 0           | 0    | 0    | 0          | 0    | 0    | 0          | 0    | 0    |
| PasserByVol:                         | 0           | 0    | 0    | 0           | 0    | 0    | 0          | 0    | 0    | 0          | 0    | 0    |
| Initial Fut:                         | 136         | 1923 | 63   | 192         | 962  | 359  | 305        | 961  | 131  | 81         | 754  | 1000 |
| User Adj:                            | 1.00        | 1.00 | 1.00 | 1.00        | 1.00 | 1.00 | 1.00       | 1.00 | 1.00 | 1.00       | 1.00 | 0.00 |
| PHF Adj:                             | 1.00        | 1.00 | 1.00 | 1.00        | 1.00 | 1.00 | 1.00       | 1.00 | 1.00 | 1.00       | 1.00 | 0.00 |
| PHF Volume:                          | 136         | 1923 | 63   | 192         | 962  | 359  | 305        | 961  | 131  | 81         | 754  | 0    |
| Reduct Vol:                          | 0           | 0    | 0    | 0           | 0    | 0    | 0          | 0    | 0    | 0          | 0    | 0    |
| Reduced Vol:                         | 136         | 1923 | 63   | 192         | 962  | 359  | 305        | 961  | 131  | 81         | 754  | 0    |
| PCE Adj:                             | 1.00        | 1.00 | 1.00 | 1.00        | 1.00 | 1.00 | 1.00       | 1.00 | 1.00 | 1.00       | 1.00 | 0.00 |
| MLF Adj:                             | 1.00        | 1.00 | 1.00 | 1.00        | 1.00 | 1.00 | 1.00       | 1.00 | 1.00 | 1.00       | 1.00 | 0.00 |
| Final Volume:                        | 136         | 1923 | 63   | 192         | 962  | 359  | 305        | 961  | 131  | 81         | 754  | 0    |
| Saturation Flow Module:              |             |      |      |             |      |      |            |      |      |            |      |      |
| Sat/Lane:                            | 1900        | 1900 | 1900 | 1900        | 1900 | 1900 | 1900       | 1900 | 1900 | 1900       | 1900 | 1900 |
| Adjustment:                          | 0.92        | 0.97 | 0.95 | 0.83        | 0.83 | 0.92 | 0.83       | 1.00 | 0.92 | 0.92       | 1.00 | 0.92 |
| Lanes:                               | 1.00        | 1.93 | 0.07 | 2.00        | 3.00 | 1.00 | 2.00       | 2.00 | 1.00 | 1.00       | 2.00 | 1.00 |
| Final Sat.:                          | 1750        | 3583 | 117  | 3150        | 4750 | 1750 | 3150       | 3800 | 1750 | 1750       | 3800 | 1750 |
| Capacity Analysis Module:            |             |      |      |             |      |      |            |      |      |            |      |      |
| Vol/Sat:                             | 0.08        | 0.54 | 0.54 | 0.06        | 0.20 | 0.21 | 0.10       | 0.25 | 0.07 | 0.05       | 0.20 | 0.00 |
| Crit Moves:                          | ****        | **** | **** | ****        | **** | **** | ****       | **** | **** | ****       | **** | **** |
| Green Time:                          | 23.5        | 76.9 | 76.9 | 8.7         | 62.1 | 62.1 | 13.9       | 35.3 | 35.3 | 7.0        | 28.4 | 0.0  |
| Volume/Cap:                          | 0.46        | 0.98 | 0.98 | 0.98        | 0.46 | 0.46 | 0.98       | 1.00 | 0.30 | 0.93       | 0.98 | 0.00 |
| Delay/Veh:                           | 53.7        | 45.5 | 45.5 | 122.7       | 27.3 | 27.7 | 107.3      | 82.0 | 42.7 | 138.0      | 82.0 | 0.0  |
| User DelAdj:                         | 1.00        | 1.00 | 1.00 | 1.00        | 1.00 | 1.00 | 1.00       | 1.00 | 1.00 | 1.00       | 1.00 | 1.00 |
| AdjDel/Veh:                          | 53.7        | 45.5 | 45.5 | 122.7       | 27.3 | 27.7 | 107.3      | 82.0 | 42.7 | 138.0      | 82.0 | 0.0  |
| LOS by Move:                         | D           | D    | D    | F           | C    | C    | F          | F    | D    | F          | F    | A    |
| HCM2k95thQ:                          | 10          | 64   | 64   | 12          | 17   | 20   | 16         | 38   | 9    | 12         | 35   | 0    |

Note: Queue reported is the number of cars per lane.

BART

Level Of Service Computation Report  
2000 HCM Operations (Future Volume Alternative)  
PM - Cumulative With Project

Intersection #3413: Coleman/Hedding [Study Int 38]

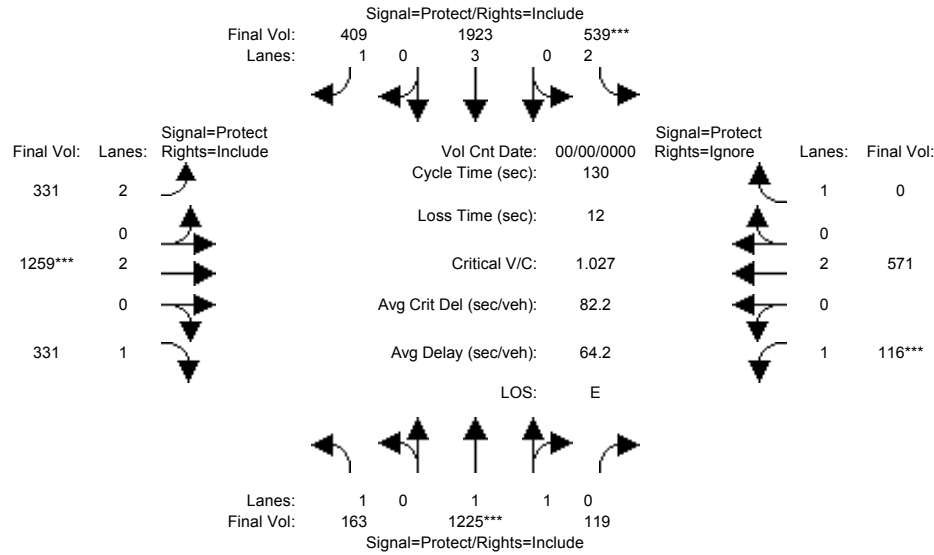

| Approach:                            | North Bound |      |      | South Bound |      |      | East Bound |      |      | West Bound |      |      |
|--------------------------------------|-------------|------|------|-------------|------|------|------------|------|------|------------|------|------|
| Movement:                            | L           | T    | R    | L           | T    | R    | L          | T    | R    | L          | T    | R    |
| Min. Green:                          | 7           | 10   | 10   | 7           | 10   | 10   | 7          | 10   | 10   | 7          | 10   | 10   |
| Y+R:                                 | 4.0         | 4.0  | 4.0  | 4.0         | 4.0  | 4.0  | 4.0        | 4.0  | 4.0  | 4.0        | 4.0  | 4.0  |
| Volume Module: >> Count Date: 0 0 << |             |      |      |             |      |      |            |      |      |            |      |      |
| Base Vol:                            | 163         | 1225 | 119  | 539         | 1923 | 409  | 331        | 1259 | 331  | 116        | 571  | 479  |
| Growth Adj:                          | 1.00        | 1.00 | 1.00 | 1.00        | 1.00 | 1.00 | 1.00       | 1.00 | 1.00 | 1.00       | 1.00 | 1.00 |
| Initial Bse:                         | 163         | 1225 | 119  | 539         | 1923 | 409  | 331        | 1259 | 331  | 116        | 571  | 479  |
| Added Vol:                           | 0           | 0    | 0    | 0           | 0    | 0    | 0          | 0    | 0    | 0          | 0    | 0    |
| PasserByVol:                         | 0           | 0    | 0    | 0           | 0    | 0    | 0          | 0    | 0    | 0          | 0    | 0    |
| Initial Fut:                         | 163         | 1225 | 119  | 539         | 1923 | 409  | 331        | 1259 | 331  | 116        | 571  | 479  |
| User Adj:                            | 1.00        | 1.00 | 1.00 | 1.00        | 1.00 | 1.00 | 1.00       | 1.00 | 1.00 | 1.00       | 1.00 | 0.00 |
| PHF Adj:                             | 1.00        | 1.00 | 1.00 | 1.00        | 1.00 | 1.00 | 1.00       | 1.00 | 1.00 | 1.00       | 1.00 | 0.00 |
| PHF Volume:                          | 163         | 1225 | 119  | 539         | 1923 | 409  | 331        | 1259 | 331  | 116        | 571  | 0    |
| Reduct Vol:                          | 0           | 0    | 0    | 0           | 0    | 0    | 0          | 0    | 0    | 0          | 0    | 0    |
| Reduced Vol:                         | 163         | 1225 | 119  | 539         | 1923 | 409  | 331        | 1259 | 331  | 116        | 571  | 0    |
| PCE Adj:                             | 1.00        | 1.00 | 1.00 | 1.00        | 1.00 | 1.00 | 1.00       | 1.00 | 1.00 | 1.00       | 1.00 | 0.00 |
| MLF Adj:                             | 1.00        | 1.00 | 1.00 | 1.00        | 1.00 | 1.00 | 1.00       | 1.00 | 1.00 | 1.00       | 1.00 | 0.00 |
| Final Volume:                        | 163         | 1225 | 119  | 539         | 1923 | 409  | 331        | 1259 | 331  | 116        | 571  | 0    |
| Saturation Flow Module:              |             |      |      |             |      |      |            |      |      |            |      |      |
| Sat/Lane:                            | 1900        | 1900 | 1900 | 1900        | 1900 | 1900 | 1900       | 1900 | 1900 | 1900       | 1900 | 1900 |
| Adjustment:                          | 0.92        | 0.98 | 0.95 | 0.83        | 0.83 | 0.92 | 0.83       | 1.00 | 0.92 | 0.92       | 1.00 | 0.92 |
| Lanes:                               | 1.00        | 1.82 | 0.18 | 2.00        | 3.00 | 1.00 | 2.00       | 2.00 | 1.00 | 1.00       | 2.00 | 1.00 |
| Final Sat.:                          | 1750        | 3372 | 328  | 3150        | 4750 | 1750 | 3150       | 3800 | 1750 | 1750       | 3800 | 1750 |
| Capacity Analysis Module:            |             |      |      |             |      |      |            |      |      |            |      |      |
| Vol/Sat:                             | 0.09        | 0.36 | 0.36 | 0.17        | 0.40 | 0.23 | 0.11       | 0.33 | 0.19 | 0.07       | 0.15 | 0.00 |
| Crit Moves:                          | ****        | **** | **** | ****        | **** | **** | ****       | **** | **** | ****       | **** | **** |
| Green Time:                          | 12.7        | 46.0 | 46.0 | 21.7        | 55.0 | 55.0 | 20.7       | 41.9 | 41.9 | 8.4        | 29.6 | 0.0  |
| Volume/Cap:                          | 0.96        | 1.03 | 1.03 | 1.03        | 0.96 | 0.55 | 0.66       | 1.03 | 0.59 | 1.03       | 0.66 | 0.00 |
| Delay/Veh:                           | 114.5       | 73.9 | 73.9 | 100.4       | 47.9 | 29.1 | 54.6       | 76.8 | 38.4 | 152.8      | 47.5 | 0.0  |
| User DelAdj:                         | 1.00        | 1.00 | 1.00 | 1.00        | 1.00 | 1.00 | 1.00       | 1.00 | 1.00 | 1.00       | 1.00 | 1.00 |
| AdjDel/Veh:                          | 114.5       | 73.9 | 73.9 | 100.4       | 47.9 | 29.1 | 54.6       | 76.8 | 38.4 | 152.8      | 47.5 | 0.0  |
| LOS by Move:                         | F           | E    | E    | F           | D    | C    | D          | E    | D    | F          | D    | A    |
| HCM2k95thQ:                          | 13          | 46   | 46   | 28          | 44   | 23   | 13         | 43   | 20   | 16         | 20   | 0    |

Note: Queue reported is the number of cars per lane.

BART

Level Of Service Computation Report  
 2000 HCM Operations (Future Volume Alternative)  
 AM - Cumulative No Project

Intersection #3417: Coleman/Taylor [Study Int 39]

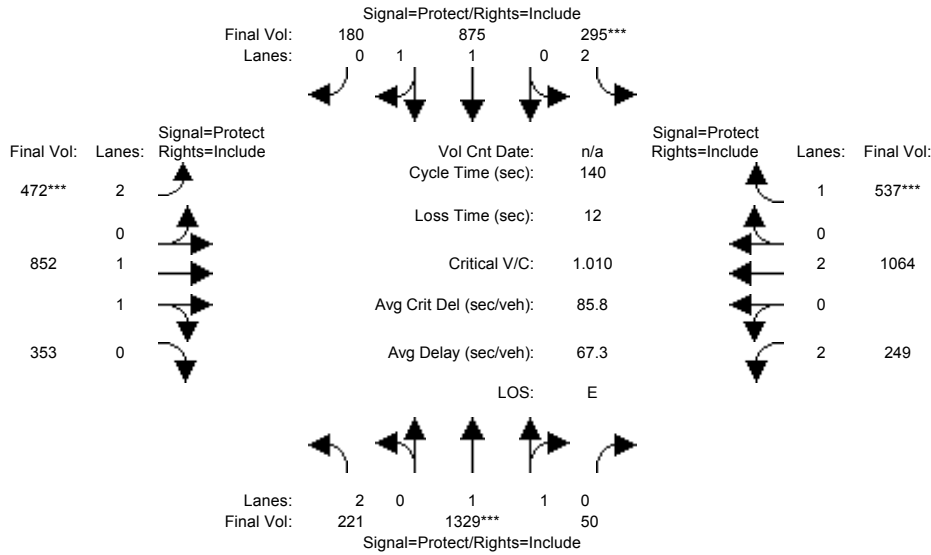

| Approach:                 | North Bound |      |      | South Bound |      |      | East Bound |      |      | West Bound |      |      |
|---------------------------|-------------|------|------|-------------|------|------|------------|------|------|------------|------|------|
| Movement:                 | L           | T    | R    | L           | T    | R    | L          | T    | R    | L          | T    | R    |
| Min. Green:               | 7           | 10   | 10   | 7           | 10   | 10   | 7          | 10   | 10   | 7          | 10   | 10   |
| Y+R:                      | 4.0         | 4.0  | 4.0  | 4.0         | 4.0  | 4.0  | 4.0        | 4.0  | 4.0  | 4.0        | 4.0  | 4.0  |
| Volume Module:            |             |      |      |             |      |      |            |      |      |            |      |      |
| Base Vol:                 | 221         | 1329 | 50   | 295         | 875  | 180  | 472        | 852  | 353  | 249        | 1064 | 537  |
| Growth Adj:               | 1.00        | 1.00 | 1.00 | 1.00        | 1.00 | 1.00 | 1.00       | 1.00 | 1.00 | 1.00       | 1.00 | 1.00 |
| Initial Bse:              | 221         | 1329 | 50   | 295         | 875  | 180  | 472        | 852  | 353  | 249        | 1064 | 537  |
| Added Vol:                | 0           | 0    | 0    | 0           | 0    | 0    | 0          | 0    | 0    | 0          | 0    | 0    |
| PasserByVol:              | 0           | 0    | 0    | 0           | 0    | 0    | 0          | 0    | 0    | 0          | 0    | 0    |
| Initial Fut:              | 221         | 1329 | 50   | 295         | 875  | 180  | 472        | 852  | 353  | 249        | 1064 | 537  |
| User Adj:                 | 1.00        | 1.00 | 1.00 | 1.00        | 1.00 | 1.00 | 1.00       | 1.00 | 1.00 | 1.00       | 1.00 | 1.00 |
| PHF Adj:                  | 1.00        | 1.00 | 1.00 | 1.00        | 1.00 | 1.00 | 1.00       | 1.00 | 1.00 | 1.00       | 1.00 | 1.00 |
| PHF Volume:               | 221         | 1329 | 50   | 295         | 875  | 180  | 472        | 852  | 353  | 249        | 1064 | 537  |
| Reduct Vol:               | 0           | 0    | 0    | 0           | 0    | 0    | 0          | 0    | 0    | 0          | 0    | 0    |
| Reduced Vol:              | 221         | 1329 | 50   | 295         | 875  | 180  | 472        | 852  | 353  | 249        | 1064 | 537  |
| PCE Adj:                  | 1.00        | 1.00 | 1.00 | 1.00        | 1.00 | 1.00 | 1.00       | 1.00 | 1.00 | 1.00       | 1.00 | 1.00 |
| MLF Adj:                  | 1.00        | 1.00 | 1.00 | 1.00        | 1.00 | 1.00 | 1.00       | 1.00 | 1.00 | 1.00       | 1.00 | 1.00 |
| Final Volume:             | 221         | 1329 | 50   | 295         | 875  | 180  | 472        | 852  | 353  | 249        | 1064 | 537  |
| Saturation Flow Module:   |             |      |      |             |      |      |            |      |      |            |      |      |
| Sat/Lane:                 | 1900        | 1900 | 1900 | 1900        | 1900 | 1900 | 1900       | 1900 | 1900 | 1900       | 1900 | 1900 |
| Adjustment:               | 0.83        | 0.97 | 0.95 | 0.83        | 0.98 | 0.95 | 0.83       | 0.98 | 0.95 | 0.83       | 1.00 | 0.92 |
| Lanes:                    | 2.00        | 1.93 | 0.07 | 2.00        | 1.65 | 0.35 | 2.00       | 1.40 | 0.60 | 2.00       | 2.00 | 1.00 |
| Final Sat.:               | 3150        | 3566 | 134  | 3150        | 3068 | 631  | 3150       | 2615 | 1084 | 3150       | 3800 | 1750 |
| Capacity Analysis Module: |             |      |      |             |      |      |            |      |      |            |      |      |
| Vol/Sat:                  | 0.07        | 0.37 | 0.37 | 0.09        | 0.29 | 0.29 | 0.15       | 0.33 | 0.33 | 0.08       | 0.28 | 0.31 |
| Crit Moves:               | ****        | **** | **** | ****        | **** | **** | ****       | **** | **** | ****       | **** | **** |
| Green Time:               | 12.8        | 51.7 | 51.7 | 13.0        | 51.9 | 51.9 | 20.8       | 51.0 | 51.0 | 12.4       | 42.6 | 42.6 |
| Volume/Cap:               | 0.77        | 1.01 | 1.01 | 1.01        | 0.77 | 0.77 | 1.01       | 0.89 | 0.89 | 0.89       | 0.92 | 1.01 |
| Delay/Veh:                | 74.1        | 70.9 | 70.9 | 118.6       | 41.5 | 41.5 | 103.7      | 50.1 | 50.1 | 91.7       | 59.0 | 90.2 |
| User DelAdj:              | 1.00        | 1.00 | 1.00 | 1.00        | 1.00 | 1.00 | 1.00       | 1.00 | 1.00 | 1.00       | 1.00 | 1.00 |
| AdjDel/Veh:               | 74.1        | 70.9 | 70.9 | 118.6       | 41.5 | 41.5 | 103.7      | 50.1 | 50.1 | 91.7       | 59.0 | 90.2 |
| LOS by Move:              | E           | E    | E    | F           | D    | D    | F          | D    | D    | F          | E    | F    |
| HCM2k95thQ:               | 14          | 59   | 59   | 18          | 35   | 35   | 25         | 42   | 42   | 14         | 39   | 47   |

Note: Queue reported is the number of cars per lane.

BART

Level Of Service Computation Report  
2000 HCM Operations (Future Volume Alternative)  
PM - Cumulative No Project

Intersection #3417: Coleman/Taylor [Study Int 39]

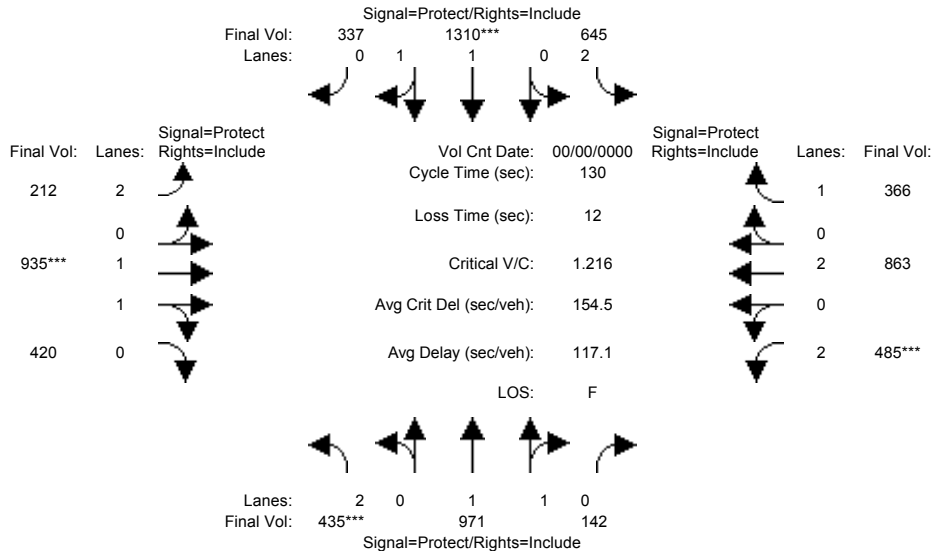

| Approach:                            | North Bound |      |      | South Bound |      |       | East Bound |      |       | West Bound |      |      |
|--------------------------------------|-------------|------|------|-------------|------|-------|------------|------|-------|------------|------|------|
| Movement:                            | L           | T    | R    | L           | T    | R     | L          | T    | R     | L          | T    | R    |
| Min. Green:                          | 7           | 10   | 10   | 7           | 10   | 10    | 7          | 10   | 10    | 7          | 10   | 10   |
| Y+R:                                 | 4.0         | 4.0  | 4.0  | 4.0         | 4.0  | 4.0   | 4.0        | 4.0  | 4.0   | 4.0        | 4.0  | 4.0  |
| Volume Module: >> Count Date: 0 0 << |             |      |      |             |      |       |            |      |       |            |      |      |
| Base Vol:                            | 435         | 971  | 142  | 645         | 1310 | 337   | 212        | 935  | 420   | 485        | 863  | 366  |
| Growth Adj:                          | 1.00        | 1.00 | 1.00 | 1.00        | 1.00 | 1.00  | 1.00       | 1.00 | 1.00  | 1.00       | 1.00 | 1.00 |
| Initial Bse:                         | 435         | 971  | 142  | 645         | 1310 | 337   | 212        | 935  | 420   | 485        | 863  | 366  |
| Added Vol:                           | 0           | 0    | 0    | 0           | 0    | 0     | 0          | 0    | 0     | 0          | 0    | 0    |
| PasserByVol:                         | 0           | 0    | 0    | 0           | 0    | 0     | 0          | 0    | 0     | 0          | 0    | 0    |
| Initial Fut:                         | 435         | 971  | 142  | 645         | 1310 | 337   | 212        | 935  | 420   | 485        | 863  | 366  |
| User Adj:                            | 1.00        | 1.00 | 1.00 | 1.00        | 1.00 | 1.00  | 1.00       | 1.00 | 1.00  | 1.00       | 1.00 | 1.00 |
| PHF Adj:                             | 1.00        | 1.00 | 1.00 | 1.00        | 1.00 | 1.00  | 1.00       | 1.00 | 1.00  | 1.00       | 1.00 | 1.00 |
| PHF Volume:                          | 435         | 971  | 142  | 645         | 1310 | 337   | 212        | 935  | 420   | 485        | 863  | 366  |
| Reduct Vol:                          | 0           | 0    | 0    | 0           | 0    | 0     | 0          | 0    | 0     | 0          | 0    | 0    |
| Reduced Vol:                         | 435         | 971  | 142  | 645         | 1310 | 337   | 212        | 935  | 420   | 485        | 863  | 366  |
| PCE Adj:                             | 1.00        | 1.00 | 1.00 | 1.00        | 1.00 | 1.00  | 1.00       | 1.00 | 1.00  | 1.00       | 1.00 | 1.00 |
| MLF Adj:                             | 1.00        | 1.00 | 1.00 | 1.00        | 1.00 | 1.00  | 1.00       | 1.00 | 1.00  | 1.00       | 1.00 | 1.00 |
| Final Volume:                        | 435         | 971  | 142  | 645         | 1310 | 337   | 212        | 935  | 420   | 485        | 863  | 366  |
| Saturation Flow Module:              |             |      |      |             |      |       |            |      |       |            |      |      |
| Sat/Lane:                            | 1900        | 1900 | 1900 | 1900        | 1900 | 1900  | 1900       | 1900 | 1900  | 1900       | 1900 | 1900 |
| Adjustment:                          | 0.83        | 0.98 | 0.95 | 0.83        | 0.98 | 0.95  | 0.83       | 0.99 | 0.95  | 0.83       | 1.00 | 0.92 |
| Lanes:                               | 2.00        | 1.74 | 0.26 | 2.00        | 1.58 | 0.42  | 2.00       | 1.36 | 0.64  | 2.00       | 2.00 | 1.00 |
| Final Sat.:                          | 3150        | 3228 | 472  | 3150        | 2942 | 757   | 3150       | 2552 | 1146  | 3150       | 3800 | 1750 |
| Capacity Analysis Module:            |             |      |      |             |      |       |            |      |       |            |      |      |
| Vol/Sat:                             | 0.14        | 0.30 | 0.30 | 0.20        | 0.45 | 0.45  | 0.07       | 0.37 | 0.37  | 0.15       | 0.23 | 0.21 |
| Crit Moves:                          | ****        |      |      | ****        |      |       | ****       |      |       | ****       |      |      |
| Green Time:                          | 14.8        | 37.1 | 37.1 | 25.3        | 47.6 | 47.6  | 12.7       | 39.2 | 39.2  | 16.5       | 42.9 | 42.9 |
| Volume/Cap:                          | 1.22        | 1.05 | 1.05 | 1.05        | 1.22 | 1.22  | 0.69       | 1.22 | 1.22  | 1.22       | 0.69 | 0.63 |
| Delay/Veh:                           | 177.7       | 89.5 | 89.5 | 103.8       | 145  | 145.3 | 63.1       | 151  | 150.9 | 174.8      | 39.4 | 39.2 |
| User DelAdj:                         | 1.00        | 1.00 | 1.00 | 1.00        | 1.00 | 1.00  | 1.00       | 1.00 | 1.00  | 1.00       | 1.00 | 1.00 |
| AdjDel/Veh:                          | 177.7       | 89.5 | 89.5 | 103.8       | 145  | 145.3 | 63.1       | 151  | 150.9 | 174.8      | 39.4 | 39.2 |
| LOS by Move:                         | F           | F    | F    | F           | F    | F     | E          | F    | F     | F          | D    | D    |
| HCM2k95thQ:                          | 32          | 50   | 50   | 31          | 77   | 77    | 9          | 64   | 64    | 32         | 26   | 23   |

Note: Queue reported is the number of cars per lane.

BART

Level Of Service Computation Report  
2000 HCM Operations (Future Volume Alternative)  
AM - Cumulative With Project

Intersection #3417: Coleman/Taylor [Study Int 39]

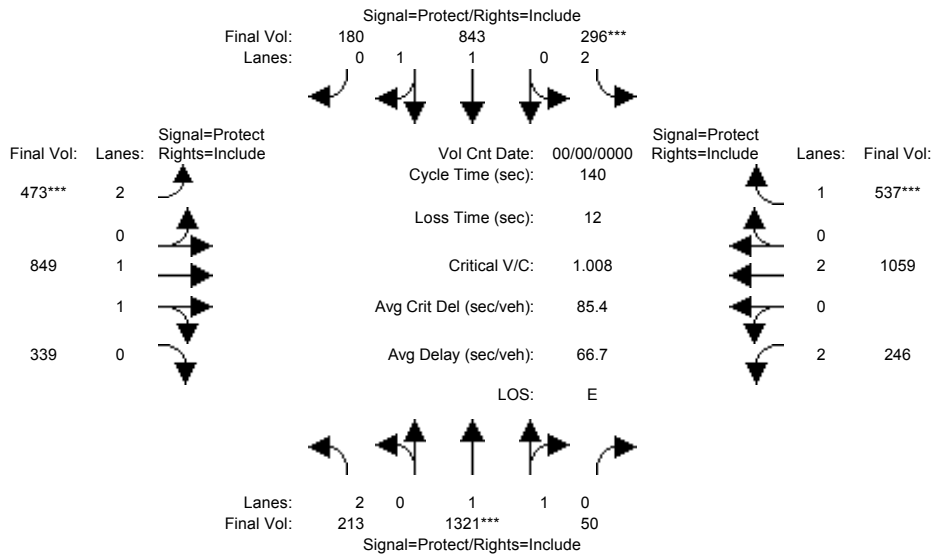

| Approach:                            | North Bound |      |      | South Bound |      |      | East Bound |      |      | West Bound |      |      |
|--------------------------------------|-------------|------|------|-------------|------|------|------------|------|------|------------|------|------|
| Movement:                            | L           | T    | R    | L           | T    | R    | L          | T    | R    | L          | T    | R    |
| Min. Green:                          | 7           | 10   | 10   | 7           | 10   | 10   | 7          | 10   | 10   | 7          | 10   | 10   |
| Y+R:                                 | 4.0         | 4.0  | 4.0  | 4.0         | 4.0  | 4.0  | 4.0        | 4.0  | 4.0  | 4.0        | 4.0  | 4.0  |
| Volume Module: >> Count Date: 0 0 << |             |      |      |             |      |      |            |      |      |            |      |      |
| Base Vol:                            | 213         | 1321 | 50   | 296         | 843  | 180  | 473        | 849  | 339  | 246        | 1059 | 537  |
| Growth Adj:                          | 1.00        | 1.00 | 1.00 | 1.00        | 1.00 | 1.00 | 1.00       | 1.00 | 1.00 | 1.00       | 1.00 | 1.00 |
| Initial Bse:                         | 213         | 1321 | 50   | 296         | 843  | 180  | 473        | 849  | 339  | 246        | 1059 | 537  |
| Added Vol:                           | 0           | 0    | 0    | 0           | 0    | 0    | 0          | 0    | 0    | 0          | 0    | 0    |
| PasserByVol:                         | 0           | 0    | 0    | 0           | 0    | 0    | 0          | 0    | 0    | 0          | 0    | 0    |
| Initial Fut:                         | 213         | 1321 | 50   | 296         | 843  | 180  | 473        | 849  | 339  | 246        | 1059 | 537  |
| User Adj:                            | 1.00        | 1.00 | 1.00 | 1.00        | 1.00 | 1.00 | 1.00       | 1.00 | 1.00 | 1.00       | 1.00 | 1.00 |
| PHF Adj:                             | 1.00        | 1.00 | 1.00 | 1.00        | 1.00 | 1.00 | 1.00       | 1.00 | 1.00 | 1.00       | 1.00 | 1.00 |
| PHF Volume:                          | 213         | 1321 | 50   | 296         | 843  | 180  | 473        | 849  | 339  | 246        | 1059 | 537  |
| Reduct Vol:                          | 0           | 0    | 0    | 0           | 0    | 0    | 0          | 0    | 0    | 0          | 0    | 0    |
| Reduced Vol:                         | 213         | 1321 | 50   | 296         | 843  | 180  | 473        | 849  | 339  | 246        | 1059 | 537  |
| PCE Adj:                             | 1.00        | 1.00 | 1.00 | 1.00        | 1.00 | 1.00 | 1.00       | 1.00 | 1.00 | 1.00       | 1.00 | 1.00 |
| MLF Adj:                             | 1.00        | 1.00 | 1.00 | 1.00        | 1.00 | 1.00 | 1.00       | 1.00 | 1.00 | 1.00       | 1.00 | 1.00 |
| Final Volume:                        | 213         | 1321 | 50   | 296         | 843  | 180  | 473        | 849  | 339  | 246        | 1059 | 537  |
| Saturation Flow Module:              |             |      |      |             |      |      |            |      |      |            |      |      |
| Sat/Lane:                            | 1900        | 1900 | 1900 | 1900        | 1900 | 1900 | 1900       | 1900 | 1900 | 1900       | 1900 | 1900 |
| Adjustment:                          | 0.83        | 0.97 | 0.95 | 0.83        | 0.98 | 0.95 | 0.83       | 0.98 | 0.95 | 0.83       | 1.00 | 0.92 |
| Lanes:                               | 2.00        | 1.93 | 0.07 | 2.00        | 1.64 | 0.36 | 2.00       | 1.41 | 0.59 | 2.00       | 2.00 | 1.00 |
| Final Sat.:                          | 3150        | 3565 | 135  | 3150        | 3048 | 651  | 3150       | 2643 | 1055 | 3150       | 3800 | 1750 |
| Capacity Analysis Module:            |             |      |      |             |      |      |            |      |      |            |      |      |
| Vol/Sat:                             | 0.07        | 0.37 | 0.37 | 0.09        | 0.28 | 0.28 | 0.15       | 0.32 | 0.32 | 0.08       | 0.28 | 0.31 |
| Crit Moves:                          | ****        | **** | **** | ****        | **** | **** | ****       | **** | **** | ****       | **** | **** |
| Green Time:                          | 12.7        | 51.5 | 51.5 | 13.1        | 51.8 | 51.8 | 20.9       | 51.1 | 51.1 | 12.4       | 42.6 | 42.6 |
| Volume/Cap:                          | 0.75        | 1.01 | 1.01 | 1.01        | 0.75 | 0.75 | 1.01       | 0.88 | 0.88 | 0.88       | 0.92 | 1.01 |
| Delay/Veh:                           | 72.4        | 70.6 | 70.6 | 118.0       | 40.7 | 40.7 | 103.1      | 48.7 | 48.7 | 89.0       | 58.2 | 89.7 |
| User DelAdj:                         | 1.00        | 1.00 | 1.00 | 1.00        | 1.00 | 1.00 | 1.00       | 1.00 | 1.00 | 1.00       | 1.00 | 1.00 |
| AdjDel/Veh:                          | 72.4        | 70.6 | 70.6 | 118.0       | 40.7 | 40.7 | 103.1      | 48.7 | 48.7 | 89.0       | 58.2 | 89.7 |
| LOS by Move:                         | E           | E    | E    | F           | D    | D    | F          | D    | D    | F          | E    | F    |
| HCM2k95thQ:                          | 13          | 59   | 59   | 18          | 33   | 33   | 25         | 41   | 41   | 13         | 39   | 47   |

Note: Queue reported is the number of cars per lane.

BART

Level Of Service Computation Report  
 2000 HCM Operations (Future Volume Alternative)  
 PM - Cumulative With Project

Intersection #3417: Coleman/Taylor [Study Int 39]

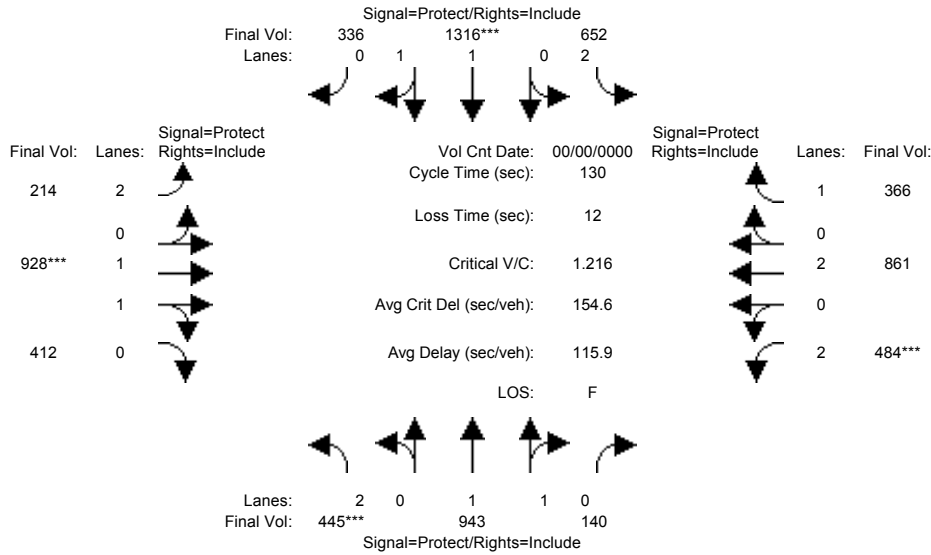

| Approach:                            | North Bound |      |      | South Bound |      |       | East Bound |      |       | West Bound |      |      |
|--------------------------------------|-------------|------|------|-------------|------|-------|------------|------|-------|------------|------|------|
| Movement:                            | L           | T    | R    | L           | T    | R     | L          | T    | R     | L          | T    | R    |
| Min. Green:                          | 7           | 10   | 10   | 7           | 10   | 10    | 7          | 10   | 10    | 7          | 10   | 10   |
| Y+R:                                 | 4.0         | 4.0  | 4.0  | 4.0         | 4.0  | 4.0   | 4.0        | 4.0  | 4.0   | 4.0        | 4.0  | 4.0  |
| Volume Module: >> Count Date: 0 0 << |             |      |      |             |      |       |            |      |       |            |      |      |
| Base Vol:                            | 445         | 943  | 140  | 652         | 1316 | 336   | 214        | 928  | 412   | 484        | 861  | 366  |
| Growth Adj:                          | 1.00        | 1.00 | 1.00 | 1.00        | 1.00 | 1.00  | 1.00       | 1.00 | 1.00  | 1.00       | 1.00 | 1.00 |
| Initial Bse:                         | 445         | 943  | 140  | 652         | 1316 | 336   | 214        | 928  | 412   | 484        | 861  | 366  |
| Added Vol:                           | 0           | 0    | 0    | 0           | 0    | 0     | 0          | 0    | 0     | 0          | 0    | 0    |
| PasserByVol:                         | 0           | 0    | 0    | 0           | 0    | 0     | 0          | 0    | 0     | 0          | 0    | 0    |
| Initial Fut:                         | 445         | 943  | 140  | 652         | 1316 | 336   | 214        | 928  | 412   | 484        | 861  | 366  |
| User Adj:                            | 1.00        | 1.00 | 1.00 | 1.00        | 1.00 | 1.00  | 1.00       | 1.00 | 1.00  | 1.00       | 1.00 | 1.00 |
| PHF Adj:                             | 1.00        | 1.00 | 1.00 | 1.00        | 1.00 | 1.00  | 1.00       | 1.00 | 1.00  | 1.00       | 1.00 | 1.00 |
| PHF Volume:                          | 445         | 943  | 140  | 652         | 1316 | 336   | 214        | 928  | 412   | 484        | 861  | 366  |
| Reduct Vol:                          | 0           | 0    | 0    | 0           | 0    | 0     | 0          | 0    | 0     | 0          | 0    | 0    |
| Reduced Vol:                         | 445         | 943  | 140  | 652         | 1316 | 336   | 214        | 928  | 412   | 484        | 861  | 366  |
| PCE Adj:                             | 1.00        | 1.00 | 1.00 | 1.00        | 1.00 | 1.00  | 1.00       | 1.00 | 1.00  | 1.00       | 1.00 | 1.00 |
| MLF Adj:                             | 1.00        | 1.00 | 1.00 | 1.00        | 1.00 | 1.00  | 1.00       | 1.00 | 1.00  | 1.00       | 1.00 | 1.00 |
| Final Volume:                        | 445         | 943  | 140  | 652         | 1316 | 336   | 214        | 928  | 412   | 484        | 861  | 366  |
| Saturation Flow Module:              |             |      |      |             |      |       |            |      |       |            |      |      |
| Sat/Lane:                            | 1900        | 1900 | 1900 | 1900        | 1900 | 1900  | 1900       | 1900 | 1900  | 1900       | 1900 | 1900 |
| Adjustment:                          | 0.83        | 0.98 | 0.95 | 0.83        | 0.98 | 0.95  | 0.83       | 0.99 | 0.95  | 0.83       | 1.00 | 0.92 |
| Lanes:                               | 2.00        | 1.73 | 0.27 | 2.00        | 1.58 | 0.42  | 2.00       | 1.37 | 0.63  | 2.00       | 2.00 | 1.00 |
| Final Sat.:                          | 3150        | 3221 | 478  | 3150        | 2947 | 752   | 3150       | 2562 | 1137  | 3150       | 3800 | 1750 |
| Capacity Analysis Module:            |             |      |      |             |      |       |            |      |       |            |      |      |
| Vol/Sat:                             | 0.14        | 0.29 | 0.29 | 0.21        | 0.45 | 0.45  | 0.07       | 0.36 | 0.36  | 0.15       | 0.23 | 0.21 |
| Crit Moves:                          | ****        |      |      | ****        |      |       | ****       |      |       | ****       |      |      |
| Green Time:                          | 15.1        | 36.8 | 36.8 | 26.0        | 47.7 | 47.7  | 12.7       | 38.7 | 38.7  | 16.4       | 42.4 | 42.4 |
| Volume/Cap:                          | 1.22        | 1.03 | 1.03 | 1.03        | 1.22 | 1.22  | 0.69       | 1.22 | 1.22  | 1.22       | 0.69 | 0.64 |
| Delay/Veh:                           | 177.1       | 83.5 | 83.5 | 96.8        | 145  | 145.3 | 63.5       | 151  | 151.3 | 174.9      | 39.9 | 39.8 |
| User DelAdj:                         | 1.00        | 1.00 | 1.00 | 1.00        | 1.00 | 1.00  | 1.00       | 1.00 | 1.00  | 1.00       | 1.00 | 1.00 |
| AdjDel/Veh:                          | 177.1       | 83.5 | 83.5 | 96.8        | 145  | 145.3 | 63.5       | 151  | 151.3 | 174.9      | 39.9 | 39.8 |
| LOS by Move:                         | F           | F    | F    | F           | F    | F     | E          | F    | F     | F          | D    | D    |
| HCM2k95thQ:                          | 33          | 48   | 48   | 30          | 77   | 77    | 9          | 63   | 63    | 32         | 26   | 24   |

Note: Queue reported is the number of cars per lane.

BART

Level Of Service Computation Report  
 2000 HCM Operations (Future Volume Alternative)  
 AM - Cumulative No Project

Intersection #3596: JACKSON/McKEE [Study Int 8]

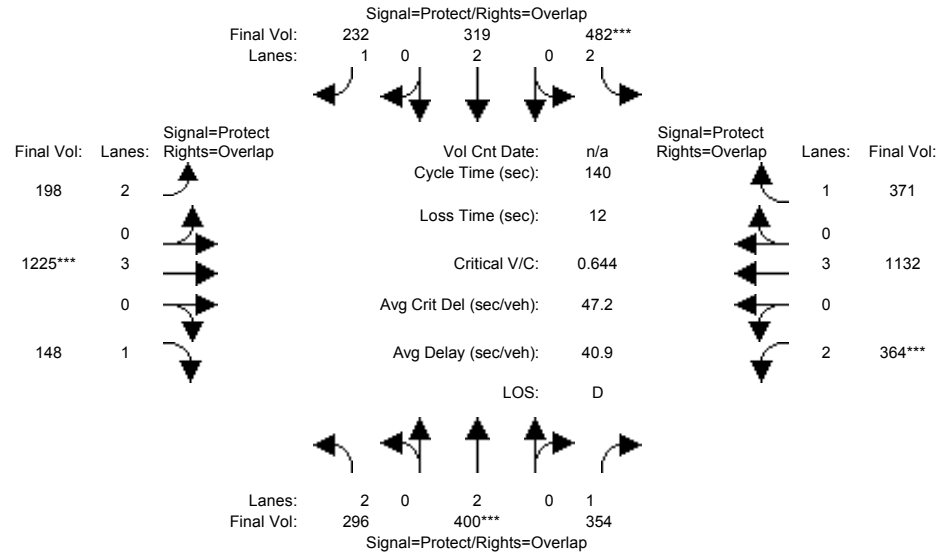

| Approach:                 | North Bound |      |      | South Bound |      |      | East Bound |      |      | West Bound |      |      |
|---------------------------|-------------|------|------|-------------|------|------|------------|------|------|------------|------|------|
| Movement:                 | L           | T    | R    | L           | T    | R    | L          | T    | R    | L          | T    | R    |
| Min. Green:               | 7           | 10   | 10   | 7           | 10   | 10   | 7          | 10   | 10   | 7          | 10   | 10   |
| Y+R:                      | 4.0         | 4.0  | 4.0  | 4.0         | 4.0  | 4.0  | 4.0        | 4.0  | 4.0  | 4.0        | 4.0  | 4.0  |
| Volume Module:            |             |      |      |             |      |      |            |      |      |            |      |      |
| Base Vol:                 | 296         | 400  | 354  | 482         | 319  | 232  | 198        | 1225 | 148  | 364        | 1132 | 371  |
| Growth Adj:               | 1.00        | 1.00 | 1.00 | 1.00        | 1.00 | 1.00 | 1.00       | 1.00 | 1.00 | 1.00       | 1.00 | 1.00 |
| Initial Bse:              | 296         | 400  | 354  | 482         | 319  | 232  | 198        | 1225 | 148  | 364        | 1132 | 371  |
| Added Vol:                | 0           | 0    | 0    | 0           | 0    | 0    | 0          | 0    | 0    | 0          | 0    | 0    |
| PasserByVol:              | 0           | 0    | 0    | 0           | 0    | 0    | 0          | 0    | 0    | 0          | 0    | 0    |
| Initial Fut:              | 296         | 400  | 354  | 482         | 319  | 232  | 198        | 1225 | 148  | 364        | 1132 | 371  |
| User Adj:                 | 1.00        | 1.00 | 1.00 | 1.00        | 1.00 | 1.00 | 1.00       | 1.00 | 1.00 | 1.00       | 1.00 | 1.00 |
| PHF Adj:                  | 1.00        | 1.00 | 1.00 | 1.00        | 1.00 | 1.00 | 1.00       | 1.00 | 1.00 | 1.00       | 1.00 | 1.00 |
| PHF Volume:               | 296         | 400  | 354  | 482         | 319  | 232  | 198        | 1225 | 148  | 364        | 1132 | 371  |
| Reduct Vol:               | 0           | 0    | 0    | 0           | 0    | 0    | 0          | 0    | 0    | 0          | 0    | 0    |
| Reduced Vol:              | 296         | 400  | 354  | 482         | 319  | 232  | 198        | 1225 | 148  | 364        | 1132 | 371  |
| PCE Adj:                  | 1.00        | 1.00 | 1.00 | 1.00        | 1.00 | 1.00 | 1.00       | 1.00 | 1.00 | 1.00       | 1.00 | 1.00 |
| MLF Adj:                  | 1.00        | 1.00 | 1.00 | 1.00        | 1.00 | 1.00 | 1.00       | 1.00 | 1.00 | 1.00       | 1.00 | 1.00 |
| FinalVolume:              | 296         | 400  | 354  | 482         | 319  | 232  | 198        | 1225 | 148  | 364        | 1132 | 371  |
| Saturation Flow Module:   |             |      |      |             |      |      |            |      |      |            |      |      |
| Sat/Lane:                 | 1900        | 1900 | 1900 | 1900        | 1900 | 1900 | 1900       | 1900 | 1900 | 1900       | 1900 | 1900 |
| Adjustment:               | 0.83        | 1.00 | 0.92 | 0.83        | 1.00 | 0.92 | 0.83       | 1.00 | 0.92 | 0.83       | 1.00 | 0.92 |
| Lanes:                    | 2.00        | 2.00 | 1.00 | 2.00        | 2.00 | 1.00 | 2.00       | 3.00 | 1.00 | 2.00       | 3.00 | 1.00 |
| Final Sat.:               | 3150        | 3800 | 1750 | 3150        | 3800 | 1750 | 3150       | 5700 | 1750 | 3150       | 5700 | 1750 |
| Capacity Analysis Module: |             |      |      |             |      |      |            |      |      |            |      |      |
| Vol/Sat:                  | 0.09        | 0.11 | 0.20 | 0.15        | 0.08 | 0.13 | 0.06       | 0.21 | 0.08 | 0.12       | 0.20 | 0.21 |
| Crit Moves:               | ****        | **** | **** | ****        | **** | **** | ****       | **** | **** | ****       | **** | **** |
| Green Time:               | 29.7        | 22.9 | 48.0 | 33.3        | 26.5 | 43.8 | 17.3       | 46.7 | 76.4 | 25.1       | 54.6 | 87.8 |
| Volume/Cap:               | 0.44        | 0.64 | 0.59 | 0.64        | 0.44 | 0.42 | 0.51       | 0.64 | 0.16 | 0.64       | 0.51 | 0.34 |
| Delay/Veh:                | 48.5        | 57.1 | 39.4 | 50.0        | 50.7 | 38.7 | 58.5       | 40.3 | 15.9 | 55.8       | 32.7 | 12.5 |
| User DelAdj:              | 1.00        | 1.00 | 1.00 | 1.00        | 1.00 | 1.00 | 1.00       | 1.00 | 1.00 | 1.00       | 1.00 | 1.00 |
| AdjDel/Veh:               | 48.5        | 57.1 | 39.4 | 50.0        | 50.7 | 38.7 | 58.5       | 40.3 | 15.9 | 55.8       | 32.7 | 12.5 |
| LOS by Move:              | D           | E    | D    | D           | D    | D    | E          | D    | B    | E          | C    | B    |
| HCM2k95thQ:               | 13          | 17   | 24   | 20          | 11   | 15   | 9          | 26   | 7    | 18         | 22   | 15   |

Note: Queue reported is the number of cars per lane.



BART

Level Of Service Computation Report  
2000 HCM Operations (Future Volume Alternative)  
PM - Cumulative No Project

Intersection #3596: JACKSON/McKEE [Study Int 8]

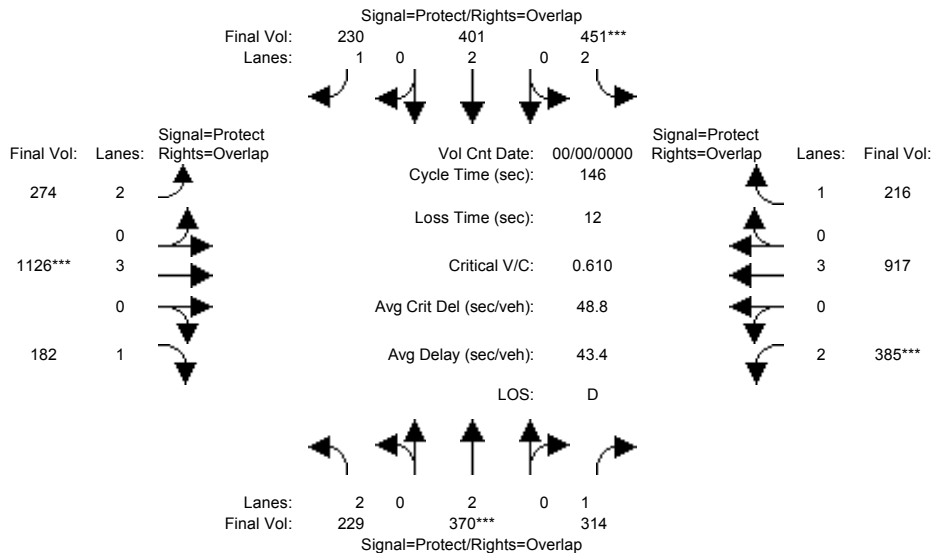

| Approach:                            | North Bound |      |      | South Bound |      |      | East Bound |      |      | West Bound |      |      |
|--------------------------------------|-------------|------|------|-------------|------|------|------------|------|------|------------|------|------|
| Movement:                            | L           | T    | R    | L           | T    | R    | L          | T    | R    | L          | T    | R    |
| Min. Green:                          | 7           | 10   | 10   | 7           | 10   | 10   | 7          | 10   | 10   | 7          | 10   | 10   |
| Y+R:                                 | 4.0         | 4.0  | 4.0  | 4.0         | 4.0  | 4.0  | 4.0        | 4.0  | 4.0  | 4.0        | 4.0  | 4.0  |
| Volume Module: >> Count Date: 0 0 << |             |      |      |             |      |      |            |      |      |            |      |      |
| Base Vol:                            | 229         | 370  | 314  | 451         | 401  | 230  | 274        | 1126 | 182  | 385        | 917  | 216  |
| Growth Adj:                          | 1.00        | 1.00 | 1.00 | 1.00        | 1.00 | 1.00 | 1.00       | 1.00 | 1.00 | 1.00       | 1.00 | 1.00 |
| Initial Bse:                         | 229         | 370  | 314  | 451         | 401  | 230  | 274        | 1126 | 182  | 385        | 917  | 216  |
| Added Vol:                           | 0           | 0    | 0    | 0           | 0    | 0    | 0          | 0    | 0    | 0          | 0    | 0    |
| PasserByVol:                         | 0           | 0    | 0    | 0           | 0    | 0    | 0          | 0    | 0    | 0          | 0    | 0    |
| Initial Fut:                         | 229         | 370  | 314  | 451         | 401  | 230  | 274        | 1126 | 182  | 385        | 917  | 216  |
| User Adj:                            | 1.00        | 1.00 | 1.00 | 1.00        | 1.00 | 1.00 | 1.00       | 1.00 | 1.00 | 1.00       | 1.00 | 1.00 |
| PHF Adj:                             | 1.00        | 1.00 | 1.00 | 1.00        | 1.00 | 1.00 | 1.00       | 1.00 | 1.00 | 1.00       | 1.00 | 1.00 |
| PHF Volume:                          | 229         | 370  | 314  | 451         | 401  | 230  | 274        | 1126 | 182  | 385        | 917  | 216  |
| Reduct Vol:                          | 0           | 0    | 0    | 0           | 0    | 0    | 0          | 0    | 0    | 0          | 0    | 0    |
| Reduced Vol:                         | 229         | 370  | 314  | 451         | 401  | 230  | 274        | 1126 | 182  | 385        | 917  | 216  |
| PCE Adj:                             | 1.00        | 1.00 | 1.00 | 1.00        | 1.00 | 1.00 | 1.00       | 1.00 | 1.00 | 1.00       | 1.00 | 1.00 |
| MLF Adj:                             | 1.00        | 1.00 | 1.00 | 1.00        | 1.00 | 1.00 | 1.00       | 1.00 | 1.00 | 1.00       | 1.00 | 1.00 |
| Final Volume:                        | 229         | 370  | 314  | 451         | 401  | 230  | 274        | 1126 | 182  | 385        | 917  | 216  |
| Saturation Flow Module:              |             |      |      |             |      |      |            |      |      |            |      |      |
| Sat/Lane:                            | 1900        | 1900 | 1900 | 1900        | 1900 | 1900 | 1900       | 1900 | 1900 | 1900       | 1900 | 1900 |
| Adjustment:                          | 0.83        | 1.00 | 0.92 | 0.83        | 1.00 | 0.92 | 0.83       | 1.00 | 0.92 | 0.83       | 1.00 | 0.92 |
| Lanes:                               | 2.00        | 2.00 | 1.00 | 2.00        | 2.00 | 1.00 | 2.00       | 3.00 | 1.00 | 2.00       | 3.00 | 1.00 |
| Final Sat.:                          | 3150        | 3800 | 1750 | 3150        | 3800 | 1750 | 3150       | 5700 | 1750 | 3150       | 5700 | 1750 |
| Capacity Analysis Module:            |             |      |      |             |      |      |            |      |      |            |      |      |
| Vol/Sat:                             | 0.07        | 0.10 | 0.18 | 0.14        | 0.11 | 0.13 | 0.09       | 0.20 | 0.10 | 0.12       | 0.16 | 0.12 |
| Crit Moves:                          | ****        | **** | **** | ****        | **** | **** | ****       | **** | **** | ****       | **** | **** |
| Green Time:                          | 23.5        | 23.3 | 52.5 | 34.2        | 34.1 | 60.9 | 26.8       | 47.2 | 70.7 | 29.2       | 49.6 | 83.9 |
| Volume/Cap:                          | 0.45        | 0.61 | 0.50 | 0.61        | 0.45 | 0.32 | 0.47       | 0.61 | 0.21 | 0.61       | 0.47 | 0.21 |
| Delay/Veh:                           | 56.1        | 59.0 | 37.1 | 51.4        | 48.3 | 28.8 | 53.9       | 42.2 | 21.8 | 55.0       | 38.1 | 15.2 |
| User DelAdj:                         | 1.00        | 1.00 | 1.00 | 1.00        | 1.00 | 1.00 | 1.00       | 1.00 | 1.00 | 1.00       | 1.00 | 1.00 |
| AdjDel/Veh:                          | 56.1        | 59.0 | 37.1 | 51.4        | 48.3 | 28.8 | 53.9       | 42.2 | 21.8 | 55.0       | 38.1 | 15.2 |
| LOS by Move:                         | E           | E    | D    | D           | D    | C    | D          | D    | C    | D          | D    | B    |
| HCM2k95thQ:                          | 11          | 16   | 21   | 20          | 14   | 14   | 12         | 25   | 10   | 18         | 19   | 10   |

Note: Queue reported is the number of cars per lane.

BART

Level Of Service Computation Report  
 2000 HCM Operations (Future Volume Alternative)  
 AM - Cumulative With Project

Intersection #3596: JACKSON/McKEE [Study Int 8]

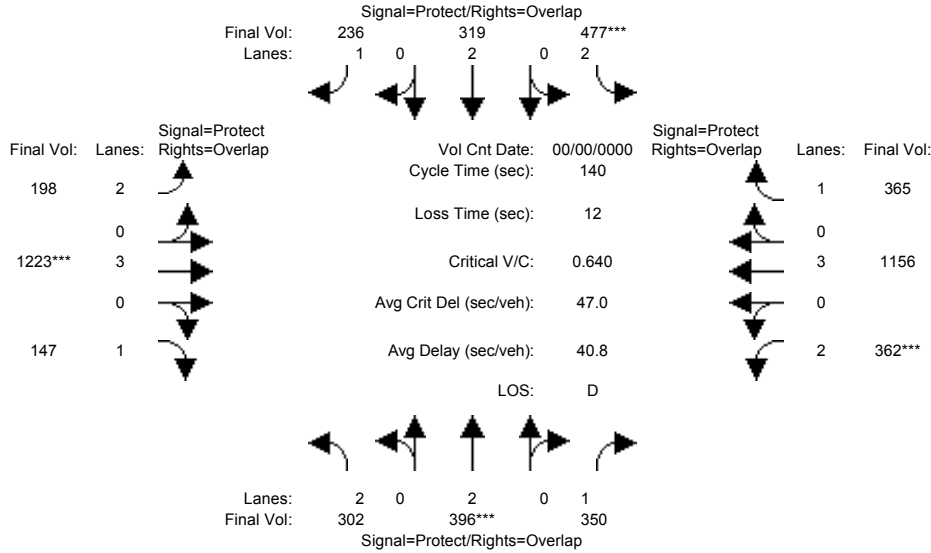

| Approach:                            | North Bound |      |      | South Bound |      |      | East Bound |      |      | West Bound |      |      |
|--------------------------------------|-------------|------|------|-------------|------|------|------------|------|------|------------|------|------|
| Movement:                            | L           | T    | R    | L           | T    | R    | L          | T    | R    | L          | T    | R    |
| Min. Green:                          | 7           | 10   | 10   | 7           | 10   | 10   | 7          | 10   | 10   | 7          | 10   | 10   |
| Y+R:                                 | 4.0         | 4.0  | 4.0  | 4.0         | 4.0  | 4.0  | 4.0        | 4.0  | 4.0  | 4.0        | 4.0  | 4.0  |
| Volume Module: >> Count Date: 0 0 << |             |      |      |             |      |      |            |      |      |            |      |      |
| Base Vol:                            | 302         | 396  | 350  | 477         | 319  | 236  | 198        | 1223 | 147  | 362        | 1156 | 365  |
| Growth Adj:                          | 1.00        | 1.00 | 1.00 | 1.00        | 1.00 | 1.00 | 1.00       | 1.00 | 1.00 | 1.00       | 1.00 | 1.00 |
| Initial Bse:                         | 302         | 396  | 350  | 477         | 319  | 236  | 198        | 1223 | 147  | 362        | 1156 | 365  |
| Added Vol:                           | 0           | 0    | 0    | 0           | 0    | 0    | 0          | 0    | 0    | 0          | 0    | 0    |
| PasserByVol:                         | 0           | 0    | 0    | 0           | 0    | 0    | 0          | 0    | 0    | 0          | 0    | 0    |
| Initial Fut:                         | 302         | 396  | 350  | 477         | 319  | 236  | 198        | 1223 | 147  | 362        | 1156 | 365  |
| User Adj:                            | 1.00        | 1.00 | 1.00 | 1.00        | 1.00 | 1.00 | 1.00       | 1.00 | 1.00 | 1.00       | 1.00 | 1.00 |
| PHF Adj:                             | 1.00        | 1.00 | 1.00 | 1.00        | 1.00 | 1.00 | 1.00       | 1.00 | 1.00 | 1.00       | 1.00 | 1.00 |
| PHF Volume:                          | 302         | 396  | 350  | 477         | 319  | 236  | 198        | 1223 | 147  | 362        | 1156 | 365  |
| Reduct Vol:                          | 0           | 0    | 0    | 0           | 0    | 0    | 0          | 0    | 0    | 0          | 0    | 0    |
| Reduced Vol:                         | 302         | 396  | 350  | 477         | 319  | 236  | 198        | 1223 | 147  | 362        | 1156 | 365  |
| PCE Adj:                             | 1.00        | 1.00 | 1.00 | 1.00        | 1.00 | 1.00 | 1.00       | 1.00 | 1.00 | 1.00       | 1.00 | 1.00 |
| MLF Adj:                             | 1.00        | 1.00 | 1.00 | 1.00        | 1.00 | 1.00 | 1.00       | 1.00 | 1.00 | 1.00       | 1.00 | 1.00 |
| Final Volume:                        | 302         | 396  | 350  | 477         | 319  | 236  | 198        | 1223 | 147  | 362        | 1156 | 365  |
| Saturation Flow Module:              |             |      |      |             |      |      |            |      |      |            |      |      |
| Sat/Lane:                            | 1900        | 1900 | 1900 | 1900        | 1900 | 1900 | 1900       | 1900 | 1900 | 1900       | 1900 | 1900 |
| Adjustment:                          | 0.83        | 1.00 | 0.92 | 0.83        | 1.00 | 0.92 | 0.83       | 1.00 | 0.92 | 0.83       | 1.00 | 0.92 |
| Lanes:                               | 2.00        | 2.00 | 1.00 | 2.00        | 2.00 | 1.00 | 2.00       | 3.00 | 1.00 | 2.00       | 3.00 | 1.00 |
| Final Sat.:                          | 3150        | 3800 | 1750 | 3150        | 3800 | 1750 | 3150       | 5700 | 1750 | 3150       | 5700 | 1750 |
| Capacity Analysis Module:            |             |      |      |             |      |      |            |      |      |            |      |      |
| Vol/Sat:                             | 0.10        | 0.10 | 0.20 | 0.15        | 0.08 | 0.13 | 0.06       | 0.21 | 0.08 | 0.11       | 0.20 | 0.21 |
| Crit Moves:                          | ****        | **** | **** | ****        | **** | **** | ****       | **** | **** | ****       | **** | **** |
| Green Time:                          | 29.8        | 22.8 | 47.9 | 33.1        | 26.1 | 43.2 | 17.1       | 46.9 | 76.8 | 25.1       | 55.0 | 88.1 |
| Volume/Cap:                          | 0.45        | 0.64 | 0.58 | 0.64        | 0.45 | 0.44 | 0.52       | 0.64 | 0.15 | 0.64       | 0.52 | 0.33 |
| Delay/Veh:                           | 48.4        | 57.0 | 39.3 | 50.0        | 51.0 | 39.3 | 58.8       | 40.1 | 15.7 | 55.7       | 32.6 | 12.3 |
| User DelAdj:                         | 1.00        | 1.00 | 1.00 | 1.00        | 1.00 | 1.00 | 1.00       | 1.00 | 1.00 | 1.00       | 1.00 | 1.00 |
| AdjDel/Veh:                          | 48.4        | 57.0 | 39.3 | 50.0        | 51.0 | 39.3 | 58.8       | 40.1 | 15.7 | 55.7       | 32.6 | 12.3 |
| LOS by Move:                         | D           | E    | D    | D           | D    | D    | E          | D    | B    | E          | C    | B    |
| HCM2k95thQ:                          | 13          | 16   | 24   | 20          | 11   | 16   | 9          | 26   | 6    | 18         | 22   | 15   |

Note: Queue reported is the number of cars per lane.

BART

Level Of Service Computation Report  
 2000 HCM Operations (Future Volume Alternative)  
 PM - Cumulative With Project

Intersection #3596: JACKSON/McKEE [Study Int 8]

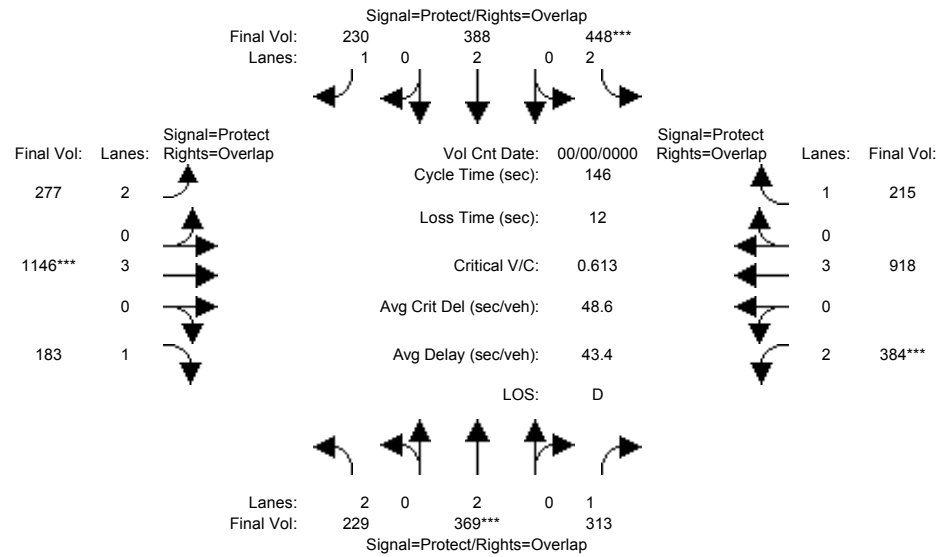

| Approach:                            | North Bound |      |      | South Bound |      |      | East Bound |      |      | West Bound |      |      |
|--------------------------------------|-------------|------|------|-------------|------|------|------------|------|------|------------|------|------|
| Movement:                            | L           | T    | R    | L           | T    | R    | L          | T    | R    | L          | T    | R    |
| Min. Green:                          | 7           | 10   | 10   | 7           | 10   | 10   | 7          | 10   | 10   | 7          | 10   | 10   |
| Y+R:                                 | 4.0         | 4.0  | 4.0  | 4.0         | 4.0  | 4.0  | 4.0        | 4.0  | 4.0  | 4.0        | 4.0  | 4.0  |
| Volume Module: >> Count Date: 0 0 << |             |      |      |             |      |      |            |      |      |            |      |      |
| Base Vol:                            | 229         | 369  | 313  | 448         | 388  | 230  | 277        | 1146 | 183  | 384        | 918  | 215  |
| Growth Adj:                          | 1.00        | 1.00 | 1.00 | 1.00        | 1.00 | 1.00 | 1.00       | 1.00 | 1.00 | 1.00       | 1.00 | 1.00 |
| Initial Bse:                         | 229         | 369  | 313  | 448         | 388  | 230  | 277        | 1146 | 183  | 384        | 918  | 215  |
| Added Vol:                           | 0           | 0    | 0    | 0           | 0    | 0    | 0          | 0    | 0    | 0          | 0    | 0    |
| PasserByVol:                         | 0           | 0    | 0    | 0           | 0    | 0    | 0          | 0    | 0    | 0          | 0    | 0    |
| Initial Fut:                         | 229         | 369  | 313  | 448         | 388  | 230  | 277        | 1146 | 183  | 384        | 918  | 215  |
| User Adj:                            | 1.00        | 1.00 | 1.00 | 1.00        | 1.00 | 1.00 | 1.00       | 1.00 | 1.00 | 1.00       | 1.00 | 1.00 |
| PHF Adj:                             | 1.00        | 1.00 | 1.00 | 1.00        | 1.00 | 1.00 | 1.00       | 1.00 | 1.00 | 1.00       | 1.00 | 1.00 |
| PHF Volume:                          | 229         | 369  | 313  | 448         | 388  | 230  | 277        | 1146 | 183  | 384        | 918  | 215  |
| Reduct Vol:                          | 0           | 0    | 0    | 0           | 0    | 0    | 0          | 0    | 0    | 0          | 0    | 0    |
| Reduced Vol:                         | 229         | 369  | 313  | 448         | 388  | 230  | 277        | 1146 | 183  | 384        | 918  | 215  |
| PCE Adj:                             | 1.00        | 1.00 | 1.00 | 1.00        | 1.00 | 1.00 | 1.00       | 1.00 | 1.00 | 1.00       | 1.00 | 1.00 |
| MLF Adj:                             | 1.00        | 1.00 | 1.00 | 1.00        | 1.00 | 1.00 | 1.00       | 1.00 | 1.00 | 1.00       | 1.00 | 1.00 |
| Final Volume:                        | 229         | 369  | 313  | 448         | 388  | 230  | 277        | 1146 | 183  | 384        | 918  | 215  |
| Saturation Flow Module:              |             |      |      |             |      |      |            |      |      |            |      |      |
| Sat/Lane:                            | 1900        | 1900 | 1900 | 1900        | 1900 | 1900 | 1900       | 1900 | 1900 | 1900       | 1900 | 1900 |
| Adjustment:                          | 0.83        | 1.00 | 0.92 | 0.83        | 1.00 | 0.92 | 0.83       | 1.00 | 0.92 | 0.83       | 1.00 | 0.92 |
| Lanes:                               | 2.00        | 2.00 | 1.00 | 2.00        | 2.00 | 1.00 | 2.00       | 3.00 | 1.00 | 2.00       | 3.00 | 1.00 |
| Final Sat.:                          | 3150        | 3800 | 1750 | 3150        | 3800 | 1750 | 3150       | 5700 | 1750 | 3150       | 5700 | 1750 |
| Capacity Analysis Module:            |             |      |      |             |      |      |            |      |      |            |      |      |
| Vol/Sat:                             | 0.07        | 0.10 | 0.18 | 0.14        | 0.10 | 0.13 | 0.09       | 0.20 | 0.10 | 0.12       | 0.16 | 0.12 |
| Crit Moves:                          | ****        | **** | **** | ****        | **** | **** | ****       | **** | **** | ****       | **** | **** |
| Green Time:                          | 23.7        | 23.1 | 52.2 | 33.9        | 33.3 | 60.5 | 27.2       | 47.9 | 71.6 | 29.1       | 49.8 | 83.7 |
| Volume/Cap:                          | 0.45        | 0.61 | 0.50 | 0.61        | 0.45 | 0.32 | 0.47       | 0.61 | 0.21 | 0.61       | 0.47 | 0.21 |
| Delay/Veh:                           | 55.8        | 59.1 | 37.3 | 51.7        | 48.8 | 29.1 | 53.6       | 41.8 | 21.3 | 55.1       | 38.0 | 15.3 |
| User DelAdj:                         | 1.00        | 1.00 | 1.00 | 1.00        | 1.00 | 1.00 | 1.00       | 1.00 | 1.00 | 1.00       | 1.00 | 1.00 |
| AdjDel/Veh:                          | 55.8        | 59.1 | 37.3 | 51.7        | 48.8 | 29.1 | 53.6       | 41.8 | 21.3 | 55.1       | 38.0 | 15.3 |
| LOS by Move:                         | E           | E    | D    | D           | D    | C    | D          | D    | C    | E          | D    | B    |
| HCM2k95thQ:                          | 11          | 16   | 21   | 20          | 14   | 14   | 12         | 25   | 9    | 18         | 19   | 10   |

Note: Queue reported is the number of cars per lane.

BART

Level Of Service Computation Report  
2000 HCM Operations (Future Volume Alternative)  
AM - Cumulative No Project

Intersection #3612: JULIAN/21ST [Study Int 1]

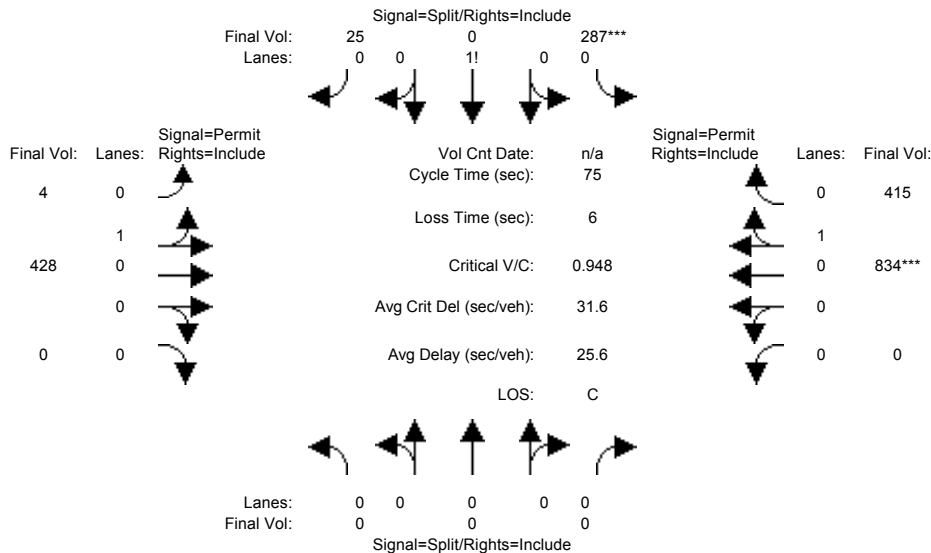

| Approach:                 | North Bound |      |      | South Bound |      |      | East Bound |      |      | West Bound |      |      |
|---------------------------|-------------|------|------|-------------|------|------|------------|------|------|------------|------|------|
| Movement:                 | L           | T    | R    | L           | T    | R    | L          | T    | R    | L          | T    | R    |
| Min. Green:               | 0           | 0    | 0    | 10          | 0    | 10   | 10         | 10   | 0    | 0          | 10   | 10   |
| Y+R:                      | 4.0         | 4.0  | 4.0  | 4.0         | 4.0  | 4.0  | 4.0        | 4.0  | 4.0  | 4.0        | 4.0  | 4.0  |
| Volume Module:            |             |      |      |             |      |      |            |      |      |            |      |      |
| Base Vol:                 | 0           | 0    | 0    | 287         | 0    | 25   | 4          | 428  | 0    | 0          | 834  | 415  |
| Growth Adj:               | 1.00        | 1.00 | 1.00 | 1.00        | 1.00 | 1.00 | 1.00       | 1.00 | 1.00 | 1.00       | 1.00 | 1.00 |
| Initial Bse:              | 0           | 0    | 0    | 287         | 0    | 25   | 4          | 428  | 0    | 0          | 834  | 415  |
| Added Vol:                | 0           | 0    | 0    | 0           | 0    | 0    | 0          | 0    | 0    | 0          | 0    | 0    |
| PasserByVol:              | 0           | 0    | 0    | 0           | 0    | 0    | 0          | 0    | 0    | 0          | 0    | 0    |
| Initial Fut:              | 0           | 0    | 0    | 287         | 0    | 25   | 4          | 428  | 0    | 0          | 834  | 415  |
| User Adj:                 | 1.00        | 1.00 | 1.00 | 1.00        | 1.00 | 1.00 | 1.00       | 1.00 | 1.00 | 1.00       | 1.00 | 1.00 |
| PHF Adj:                  | 1.00        | 1.00 | 1.00 | 1.00        | 1.00 | 1.00 | 1.00       | 1.00 | 1.00 | 1.00       | 1.00 | 1.00 |
| PHF Volume:               | 0           | 0    | 0    | 287         | 0    | 25   | 4          | 428  | 0    | 0          | 834  | 415  |
| Reduct Vol:               | 0           | 0    | 0    | 0           | 0    | 0    | 0          | 0    | 0    | 0          | 0    | 0    |
| Reduced Vol:              | 0           | 0    | 0    | 287         | 0    | 25   | 4          | 428  | 0    | 0          | 834  | 415  |
| PCE Adj:                  | 1.00        | 1.00 | 1.00 | 1.00        | 1.00 | 1.00 | 1.00       | 1.00 | 1.00 | 1.00       | 1.00 | 1.00 |
| MLF Adj:                  | 1.00        | 1.00 | 1.00 | 1.00        | 1.00 | 1.00 | 1.00       | 1.00 | 1.00 | 1.00       | 1.00 | 1.00 |
| Final Volume:             | 0           | 0    | 0    | 287         | 0    | 25   | 4          | 428  | 0    | 0          | 834  | 415  |
| Saturation Flow Module:   |             |      |      |             |      |      |            |      |      |            |      |      |
| Sat/Lane:                 | 1900        | 1900 | 1900 | 1900        | 1900 | 1900 | 1900       | 1900 | 1900 | 1900       | 1900 | 1900 |
| Adjustment:               | 0.92        | 1.00 | 0.92 | 0.92        | 0.92 | 0.92 | 0.95       | 0.95 | 0.92 | 0.92       | 0.95 | 0.95 |
| Lanes:                    | 0.00        | 0.00 | 0.00 | 0.92        | 0.00 | 0.08 | 0.01       | 0.99 | 0.00 | 0.00       | 0.67 | 0.33 |
| Final Sat.:               | 0           | 0    | 0    | 1610        | 0    | 140  | 17         | 1783 | 0    | 0          | 1202 | 598  |
| Capacity Analysis Module: |             |      |      |             |      |      |            |      |      |            |      |      |
| Vol/Sat:                  | 0.00        | 0.00 | 0.00 | 0.18        | 0.00 | 0.18 | 0.24       | 0.24 | 0.00 | 0.00       | 0.69 | 0.69 |
| Crit Moves:               |             |      |      | ****        |      |      |            |      |      | ****       |      |      |
| Green Time:               | 0.0         | 0.0  | 0.0  | 14.1        | 0.0  | 14.1 | 54.9       | 54.9 | 0.0  | 0.0        | 54.9 | 54.9 |
| Volume/Cap:               | 0.00        | 0.00 | 0.00 | 0.95        | 0.00 | 0.95 | 0.33       | 0.33 | 0.00 | 0.00       | 0.95 | 0.95 |
| Delay/Veh:                | 0.0         | 0.0  | 0.0  | 66.1        | 0.0  | 66.1 | 3.7        | 3.7  | 0.0  | 0.0        | 23.0 | 23.0 |
| User DelAdj:              | 1.00        | 1.00 | 1.00 | 1.00        | 1.00 | 1.00 | 1.00       | 1.00 | 1.00 | 1.00       | 1.00 | 1.00 |
| AdjDel/Veh:               | 0.0         | 0.0  | 0.0  | 66.1        | 0.0  | 66.1 | 3.7        | 3.7  | 0.0  | 0.0        | 23.0 | 23.0 |
| LOS by Move:              | A           | A    | A    | E           | A    | E    | A          | A    | A    | A          | C    | C    |
| HCM2k95thQ:               | 0           | 0    | 0    | 22          | 0    | 22   | 7          | 7    | 0    | 0          | 49   | 49   |

Note: Queue reported is the number of cars per lane.

BART

Level Of Service Computation Report  
 2000 HCM Operations (Future Volume Alternative)  
 PM - Cumulative No Project

Intersection #3612: JULIAN/21ST [Study Int 1]

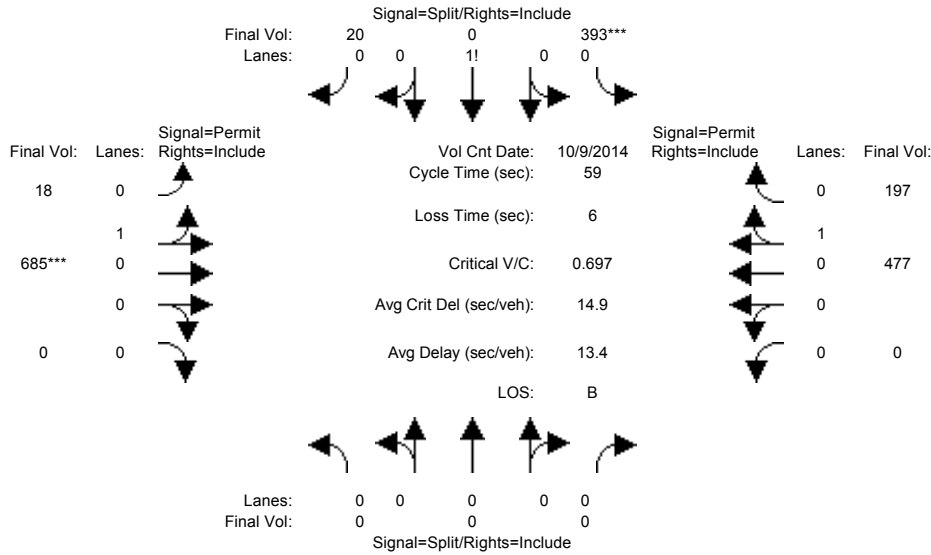

| Approach:                                   | North Bound |      |      | South Bound |      |      | East Bound |      |      | West Bound |      |      |
|---|-------------|------|------|-------------|------|------|------------|------|------|------------|------|------|
| Movement:                                   | L           | T    | R    | L           | T    | R    | L          | T    | R    | L          | T    | R    |
| Min. Green:                                 | 0           | 0    | 0    | 10          | 0    | 10   | 10         | 10   | 0    | 0          | 10   | 10   |
| Y+R:  | 4.0         | 4.0  | 4.0  | 4.0         | 4.0  | 4.0  | 4.0        | 4.0  | 4.0  | 4.0        | 4.0  | 4.0  |
| Volume Module: >> Count Date: 9 Oct 2014 << |             |      |      |             |      |      |            |      |      |            |      |      |
| Base Vol:                                   | 0           | 0    | 0    | 393         | 0    | 20   | 18         | 685  | 0    | 0          | 477  | 197  |
| Growth Adj:                                 | 1.00        | 1.00 | 1.00 | 1.00        | 1.00 | 1.00 | 1.00       | 1.00 | 1.00 | 1.00       | 1.00 | 1.00 |
| Initial Bse:                                | 0           | 0    | 0    | 393         | 0    | 20   | 18         | 685  | 0    | 0          | 477  | 197  |
| Added Vol:                                  | 0           | 0    | 0    | 0           | 0    | 0    | 0          | 0    | 0    | 0          | 0    | 0    |
| PasserByVol:                                | 0           | 0    | 0    | 0           | 0    | 0    | 0          | 0    | 0    | 0          | 0    | 0    |
| Initial Fut:                                | 0           | 0    | 0    | 393         | 0    | 20   | 18         | 685  | 0    | 0          | 477  | 197  |
| User Adj:                                   | 1.00        | 1.00 | 1.00 | 1.00        | 1.00 | 1.00 | 1.00       | 1.00 | 1.00 | 1.00       | 1.00 | 1.00 |
| PHF Adj:                                    | 1.00        | 1.00 | 1.00 | 1.00        | 1.00 | 1.00 | 1.00       | 1.00 | 1.00 | 1.00       | 1.00 | 1.00 |
| PHF Volume:                                 | 0           | 0    | 0    | 393         | 0    | 20   | 18         | 685  | 0    | 0          | 477  | 197  |
| Reduct Vol:                                 | 0           | 0    | 0    | 0           | 0    | 0    | 0          | 0    | 0    | 0          | 0    | 0    |
| Reduced Vol:                                | 0           | 0    | 0    | 393         | 0    | 20   | 18         | 685  | 0    | 0          | 477  | 197  |
| PCE Adj:                                    | 1.00        | 1.00 | 1.00 | 1.00        | 1.00 | 1.00 | 1.00       | 1.00 | 1.00 | 1.00       | 1.00 | 1.00 |
| MLF Adj:                                    | 1.00        | 1.00 | 1.00 | 1.00        | 1.00 | 1.00 | 1.00       | 1.00 | 1.00 | 1.00       | 1.00 | 1.00 |
| Final Volume:                               | 0           | 0    | 0    | 393         | 0    | 20   | 18         | 685  | 0    | 0          | 477  | 197  |
| Saturation Flow Module:                     |             |      |      |             |      |      |            |      |      |            |      |      |
| Sat/Lane:                                   | 1900        | 1900 | 1900 | 1900        | 1900 | 1900 | 1900       | 1900 | 1900 | 1900       | 1900 | 1900 |
| Adjustment:                                 | 0.92        | 1.00 | 0.92 | 0.92        | 0.92 | 0.92 | 0.95       | 0.95 | 0.92 | 0.92       | 0.95 | 0.95 |
| Lanes:                                      | 0.00        | 0.00 | 0.00 | 0.95        | 0.00 | 0.05 | 0.03       | 0.97 | 0.00 | 0.00       | 0.71 | 0.29 |
| Final Sat.:                                 | 0           | 0    | 0    | 1665        | 0    | 85   | 46         | 1754 | 0    | 0          | 1274 | 526  |
| Capacity Analysis Module:                   |             |      |      |             |      |      |            |      |      |            |      |      |
| Vol/Sat:                                    | 0.00        | 0.00 | 0.00 | 0.24        | 0.00 | 0.24 | 0.39       | 0.39 | 0.00 | 0.00       | 0.37 | 0.37 |
| Crit Moves:                                 |             |      |      | ****        |      |      | ****       |      |      |            |      |      |
| Green Time:                                 | 0.0         | 0.0  | 0.0  | 20.0        | 0.0  | 20.0 | 33.0       | 33.0 | 0.0  | 0.0        | 33.0 | 33.0 |
| Volume/Cap:                                 | 0.00        | 0.00 | 0.00 | 0.70        | 0.00 | 0.70 | 0.70       | 0.70 | 0.00 | 0.00       | 0.67 | 0.67 |
| Delay/Veh:                                  | 0.0         | 0.0  | 0.0  | 20.6        | 0.0  | 20.6 | 11.5       | 11.5 | 0.0  | 0.0        | 10.9 | 10.9 |
| User DelAdj:                                | 1.00        | 1.00 | 1.00 | 1.00        | 1.00 | 1.00 | 1.00       | 1.00 | 1.00 | 1.00       | 1.00 | 1.00 |
| AdjDel/Veh:                                 | 0.0         | 0.0  | 0.0  | 20.6        | 0.0  | 20.6 | 11.5       | 11.5 | 0.0  | 0.0        | 10.9 | 10.9 |
| LOS by Move:                                | A           | A    | A    | C           | A    | C    | B          | B    | A    | A          | B    | B    |
| HCM2k95thQ:                                 | 0           | 0    | 0    | 16          | 0    | 16   | 18         | 18   | 0    | 0          | 17   | 17   |

Note: Queue reported is the number of cars per lane.

BART

Level Of Service Computation Report  
 2000 HCM Operations (Future Volume Alternative)  
 AM - Cumulative With Project

Intersection #3612: JULIAN/21ST [Study Int 1]

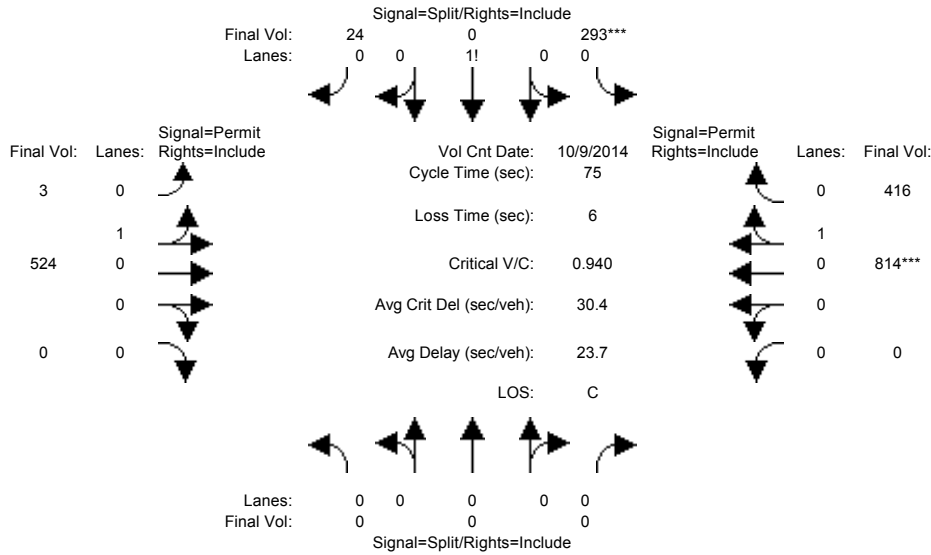

| Approach:                                   | North Bound |      |      | South Bound |      |      | East Bound |      |      | West Bound |      |      |
|---|-------------|------|------|-------------|------|------|------------|------|------|------------|------|------|
| Movement:                                   | L           | T    | R    | L           | T    | R    | L          | T    | R    | L          | T    | R    |
| Min. Green:                                 | 0           | 0    | 0    | 10          | 0    | 10   | 10         | 10   | 0    | 0          | 10   | 10   |
| Y+R:  | 4.0         | 4.0  | 4.0  | 4.0         | 4.0  | 4.0  | 4.0        | 4.0  | 4.0  | 4.0        | 4.0  | 4.0  |
| Volume Module: >> Count Date: 9 Oct 2014 << |             |      |      |             |      |      |            |      |      |            |      |      |
| Base Vol:                                   | 0           | 0    | 0    | 293         | 0    | 24   | 3          | 524  | 0    | 0          | 814  | 416  |
| Growth Adj:                                 | 1.00        | 1.00 | 1.00 | 1.00        | 1.00 | 1.00 | 1.00       | 1.00 | 1.00 | 1.00       | 1.00 | 1.00 |
| Initial Bse:                                | 0           | 0    | 0    | 293         | 0    | 24   | 3          | 524  | 0    | 0          | 814  | 416  |
| Added Vol:                                  | 0           | 0    | 0    | 0           | 0    | 0    | 0          | 0    | 0    | 0          | 0    | 0    |
| PasserByVol:                                | 0           | 0    | 0    | 0           | 0    | 0    | 0          | 0    | 0    | 0          | 0    | 0    |
| Initial Fut:                                | 0           | 0    | 0    | 293         | 0    | 24   | 3          | 524  | 0    | 0          | 814  | 416  |
| User Adj:                                   | 1.00        | 1.00 | 1.00 | 1.00        | 1.00 | 1.00 | 1.00       | 1.00 | 1.00 | 1.00       | 1.00 | 1.00 |
| PHF Adj:                                    | 1.00        | 1.00 | 1.00 | 1.00        | 1.00 | 1.00 | 1.00       | 1.00 | 1.00 | 1.00       | 1.00 | 1.00 |
| PHF Volume:                                 | 0           | 0    | 0    | 293         | 0    | 24   | 3          | 524  | 0    | 0          | 814  | 416  |
| Reduct Vol:                                 | 0           | 0    | 0    | 0           | 0    | 0    | 0          | 0    | 0    | 0          | 0    | 0    |
| Reduced Vol:                                | 0           | 0    | 0    | 293         | 0    | 24   | 3          | 524  | 0    | 0          | 814  | 416  |
| PCE Adj:                                    | 1.00        | 1.00 | 1.00 | 1.00        | 1.00 | 1.00 | 1.00       | 1.00 | 1.00 | 1.00       | 1.00 | 1.00 |
| MLF Adj:                                    | 1.00        | 1.00 | 1.00 | 1.00        | 1.00 | 1.00 | 1.00       | 1.00 | 1.00 | 1.00       | 1.00 | 1.00 |
| Final Volume:                               | 0           | 0    | 0    | 293         | 0    | 24   | 3          | 524  | 0    | 0          | 814  | 416  |
| Saturation Flow Module:                     |             |      |      |             |      |      |            |      |      |            |      |      |
| Sat/Lane:                                   | 1900        | 1900 | 1900 | 1900        | 1900 | 1900 | 1900       | 1900 | 1900 | 1900       | 1900 | 1900 |
| Adjustment:                                 | 0.92        | 1.00 | 0.92 | 0.92        | 0.92 | 0.92 | 0.95       | 0.95 | 0.92 | 0.92       | 0.95 | 0.95 |
| Lanes:                                      | 0.00        | 0.00 | 0.00 | 0.92        | 0.00 | 0.08 | 0.01       | 0.99 | 0.00 | 0.00       | 0.66 | 0.34 |
| Final Sat.:                                 | 0           | 0    | 0    | 1618        | 0    | 132  | 10         | 1790 | 0    | 0          | 1191 | 609  |
| Capacity Analysis Module:                   |             |      |      |             |      |      |            |      |      |            |      |      |
| Vol/Sat:                                    | 0.00        | 0.00 | 0.00 | 0.18        | 0.00 | 0.18 | 0.29       | 0.29 | 0.00 | 0.00       | 0.68 | 0.68 |
| Crit Moves:                                 | *****       |      |      |             |      |      |            |      |      |            |      |      |
| Green Time:                                 | 0.0         | 0.0  | 0.0  | 14.5        | 0.0  | 14.5 | 54.5       | 54.5 | 0.0  | 0.0        | 54.5 | 54.5 |
| Volume/Cap:                                 | 0.00        | 0.00 | 0.00 | 0.94        | 0.00 | 0.94 | 0.40       | 0.40 | 0.00 | 0.00       | 0.94 | 0.94 |
| Delay/Veh:                                  | 0.0         | 0.0  | 0.0  | 63.4        | 0.0  | 63.4 | 4.1        | 4.1  | 0.0  | 0.0        | 21.9 | 21.9 |
| User DelAdj:                                | 1.00        | 1.00 | 1.00 | 1.00        | 1.00 | 1.00 | 1.00       | 1.00 | 1.00 | 1.00       | 1.00 | 1.00 |
| AdjDel/Veh:                                 | 0.0         | 0.0  | 0.0  | 63.4        | 0.0  | 63.4 | 4.1        | 4.1  | 0.0  | 0.0        | 21.9 | 21.9 |
| LOS by Move:                                | A           | A    | A    | E           | A    | E    | A          | A    | A    | A          | C    | C    |
| HCM2k95thQ:                                 | 0           | 0    | 0    | 22          | 0    | 22   | 10         | 10   | 0    | 0          | 48   | 48   |

Note: Queue reported is the number of cars per lane.

BART

Level Of Service Computation Report  
2000 HCM Operations (Future Volume Alternative)  
PM - Cumulative With Project

Intersection #3612: JULIAN/21ST [Study Int 1]

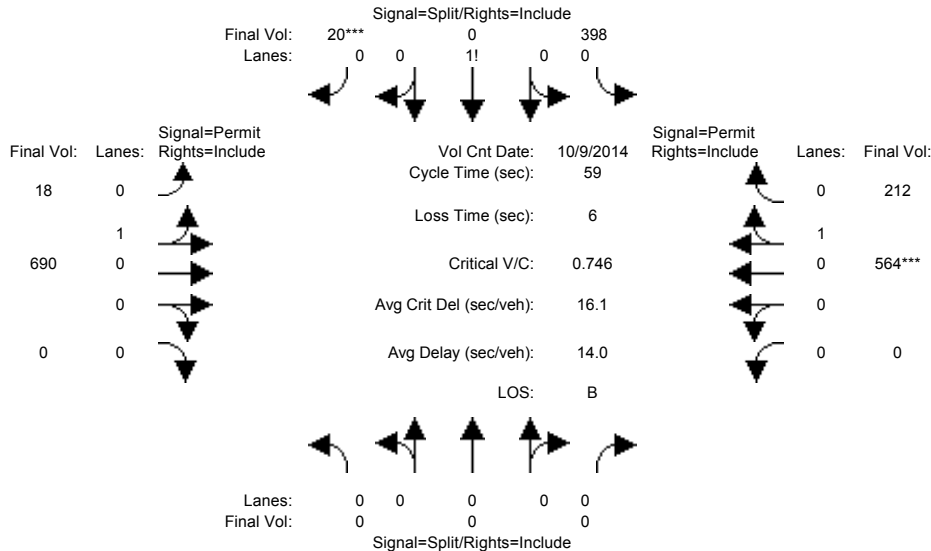

| Approach:                                   | North Bound |      |      | South Bound |      |      | East Bound |      |      | West Bound |      |      |
|---|-------------|------|------|-------------|------|------|------------|------|------|------------|------|------|
| Movement:                                   | L           | T    | R    | L           | T    | R    | L          | T    | R    | L          | T    | R    |
| Min. Green:                                 | 0           | 0    | 0    | 10          | 0    | 10   | 10         | 10   | 0    | 0          | 10   | 10   |
| Y+R:  | 4.0         | 4.0  | 4.0  | 4.0         | 4.0  | 4.0  | 4.0        | 4.0  | 4.0  | 4.0        | 4.0  | 4.0  |
| Volume Module: >> Count Date: 9 Oct 2014 << |             |      |      |             |      |      |            |      |      |            |      |      |
| Base Vol:                                   | 0           | 0    | 0    | 398         | 0    | 20   | 18         | 690  | 0    | 0          | 564  | 212  |
| Growth Adj:                                 | 1.00        | 1.00 | 1.00 | 1.00        | 1.00 | 1.00 | 1.00       | 1.00 | 1.00 | 1.00       | 1.00 | 1.00 |
| Initial Bse:                                | 0           | 0    | 0    | 398         | 0    | 20   | 18         | 690  | 0    | 0          | 564  | 212  |
| Added Vol:                                  | 0           | 0    | 0    | 0           | 0    | 0    | 0          | 0    | 0    | 0          | 0    | 0    |
| PasserByVol:                                | 0           | 0    | 0    | 0           | 0    | 0    | 0          | 0    | 0    | 0          | 0    | 0    |
| Initial Fut:                                | 0           | 0    | 0    | 398         | 0    | 20   | 18         | 690  | 0    | 0          | 564  | 212  |
| User Adj:                                   | 1.00        | 1.00 | 1.00 | 1.00        | 1.00 | 1.00 | 1.00       | 1.00 | 1.00 | 1.00       | 1.00 | 1.00 |
| PHF Adj:                                    | 1.00        | 1.00 | 1.00 | 1.00        | 1.00 | 1.00 | 1.00       | 1.00 | 1.00 | 1.00       | 1.00 | 1.00 |
| PHF Volume:                                 | 0           | 0    | 0    | 398         | 0    | 20   | 18         | 690  | 0    | 0          | 564  | 212  |
| Reduct Vol:                                 | 0           | 0    | 0    | 0           | 0    | 0    | 0          | 0    | 0    | 0          | 0    | 0    |
| Reduced Vol:                                | 0           | 0    | 0    | 398         | 0    | 20   | 18         | 690  | 0    | 0          | 564  | 212  |
| PCE Adj:                                    | 1.00        | 1.00 | 1.00 | 1.00        | 1.00 | 1.00 | 1.00       | 1.00 | 1.00 | 1.00       | 1.00 | 1.00 |
| MLF Adj:                                    | 1.00        | 1.00 | 1.00 | 1.00        | 1.00 | 1.00 | 1.00       | 1.00 | 1.00 | 1.00       | 1.00 | 1.00 |
| Final Volume:                               | 0           | 0    | 0    | 398         | 0    | 20   | 18         | 690  | 0    | 0          | 564  | 212  |
| Saturation Flow Module:                     |             |      |      |             |      |      |            |      |      |            |      |      |
| Sat/Lane:                                   | 1900        | 1900 | 1900 | 1900        | 1900 | 1900 | 1900       | 1900 | 1900 | 1900       | 1900 | 1900 |
| Adjustment:                                 | 0.92        | 1.00 | 0.92 | 0.92        | 0.92 | 0.92 | 0.95       | 0.95 | 0.92 | 0.92       | 0.95 | 0.95 |
| Lanes:                                      | 0.00        | 0.00 | 0.00 | 0.95        | 0.00 | 0.05 | 0.03       | 0.97 | 0.00 | 0.00       | 0.73 | 0.27 |
| Final Sat.:                                 | 0           | 0    | 0    | 1666        | 0    | 84   | 46         | 1754 | 0    | 0          | 1308 | 492  |
| Capacity Analysis Module:                   |             |      |      |             |      |      |            |      |      |            |      |      |
| Vol/Sat:                                    | 0.00        | 0.00 | 0.00 | 0.24        | 0.00 | 0.24 | 0.39       | 0.39 | 0.00 | 0.00       | 0.43 | 0.43 |
| Crit Moves:                                 | *****       |      |      |             |      |      |            |      |      |            |      |      |
| Green Time:                                 | 0.0         | 0.0  | 0.0  | 18.9        | 0.0  | 18.9 | 34.1       | 34.1 | 0.0  | 0.0        | 34.1 | 34.1 |
| Volume/Cap:                                 | 0.00        | 0.00 | 0.00 | 0.75        | 0.00 | 0.75 | 0.68       | 0.68 | 0.00 | 0.00       | 0.75 | 0.75 |
| Delay/Veh:                                  | 0.0         | 0.0  | 0.0  | 23.3        | 0.0  | 23.3 | 10.5       | 10.5 | 0.0  | 0.0        | 12.2 | 12.2 |
| User DelAdj:                                | 1.00        | 1.00 | 1.00 | 1.00        | 1.00 | 1.00 | 1.00       | 1.00 | 1.00 | 1.00       | 1.00 | 1.00 |
| AdjDel/Veh:                                 | 0.0         | 0.0  | 0.0  | 23.3        | 0.0  | 23.3 | 10.5       | 10.5 | 0.0  | 0.0        | 12.2 | 12.2 |
| LOS by Move:                                | A           | A    | A    | C           | A    | C    | B          | B    | A    | A          | B    | B    |
| HCM2k95thQ:                                 | 0           | 0    | 0    | 17          | 0    | 17   | 18         | 18   | 0    | 0          | 21   | 21   |

Note: Queue reported is the number of cars per lane.

BART

Level Of Service Computation Report  
 2000 HCM Operations (Future Volume Alternative)  
 AM - Cumulative No Project

Intersection #3613: JULIAN/24TH [Study Int 2]

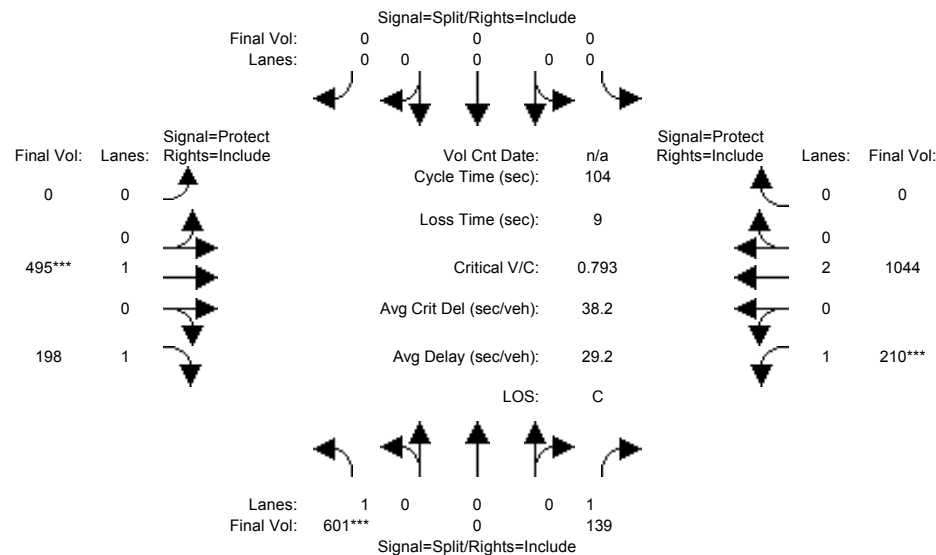

| Approach:                 | North Bound |      |      | South Bound |      |      | East Bound |      |      | West Bound |      |      |
|---------------------------|-------------|------|------|-------------|------|------|------------|------|------|------------|------|------|
| Movement:                 | L           | T    | R    | L           | T    | R    | L          | T    | R    | L          | T    | R    |
| Min. Green:               | 10          | 0    | 10   | 0           | 0    | 0    | 0          | 10   | 10   | 7          | 10   | 0    |
| Y+R:                      | 4.0         | 4.0  | 4.0  | 4.0         | 4.0  | 4.0  | 4.0        | 4.0  | 4.0  | 4.0        | 4.0  | 0    |
| Volume Module:            |             |      |      |             |      |      |            |      |      |            |      |      |
| Base Vol:                 | 601         | 0    | 139  | 0           | 0    | 0    | 0          | 495  | 198  | 210        | 1044 | 0    |
| Growth Adj:               | 1.00        | 1.00 | 1.00 | 1.00        | 1.00 | 1.00 | 1.00       | 1.00 | 1.00 | 1.00       | 1.00 | 1.00 |
| Initial Bse:              | 601         | 0    | 139  | 0           | 0    | 0    | 0          | 495  | 198  | 210        | 1044 | 0    |
| Added Vol:                | 0           | 0    | 0    | 0           | 0    | 0    | 0          | 0    | 0    | 0          | 0    | 0    |
| PasserByVol:              | 0           | 0    | 0    | 0           | 0    | 0    | 0          | 0    | 0    | 0          | 0    | 0    |
| Initial Fut:              | 601         | 0    | 139  | 0           | 0    | 0    | 0          | 495  | 198  | 210        | 1044 | 0    |
| User Adj:                 | 1.00        | 1.00 | 1.00 | 1.00        | 1.00 | 1.00 | 1.00       | 1.00 | 1.00 | 1.00       | 1.00 | 1.00 |
| PHF Adj:                  | 1.00        | 1.00 | 1.00 | 1.00        | 1.00 | 1.00 | 1.00       | 1.00 | 1.00 | 1.00       | 1.00 | 1.00 |
| PHF Volume:               | 601         | 0    | 139  | 0           | 0    | 0    | 0          | 495  | 198  | 210        | 1044 | 0    |
| Reduct Vol:               | 0           | 0    | 0    | 0           | 0    | 0    | 0          | 0    | 0    | 0          | 0    | 0    |
| Reduced Vol:              | 601         | 0    | 139  | 0           | 0    | 0    | 0          | 495  | 198  | 210        | 1044 | 0    |
| PCE Adj:                  | 1.00        | 1.00 | 1.00 | 1.00        | 1.00 | 1.00 | 1.00       | 1.00 | 1.00 | 1.00       | 1.00 | 1.00 |
| MLF Adj:                  | 1.00        | 1.00 | 1.00 | 1.00        | 1.00 | 1.00 | 1.00       | 1.00 | 1.00 | 1.00       | 1.00 | 1.00 |
| FinalVolume:              | 601         | 0    | 139  | 0           | 0    | 0    | 0          | 495  | 198  | 210        | 1044 | 0    |
| Saturation Flow Module:   |             |      |      |             |      |      |            |      |      |            |      |      |
| Sat/Lane:                 | 1900        | 1900 | 1900 | 1900        | 1900 | 1900 | 1900       | 1900 | 1900 | 1900       | 1900 | 1900 |
| Adjustment:               | 0.92        | 1.00 | 0.92 | 0.92        | 1.00 | 0.92 | 0.92       | 1.00 | 0.92 | 0.92       | 1.00 | 0.92 |
| Lanes:                    | 1.00        | 0.00 | 1.00 | 0.00        | 0.00 | 0.00 | 0.00       | 1.00 | 1.00 | 1.00       | 2.00 | 0.00 |
| Final Sat.:               | 1750        | 0    | 1750 | 0           | 0    | 0    | 0          | 1900 | 1750 | 1750       | 3800 | 0    |
| Capacity Analysis Module: |             |      |      |             |      |      |            |      |      |            |      |      |
| Vol/Sat:                  | 0.34        | 0.00 | 0.08 | 0.00        | 0.00 | 0.00 | 0.00       | 0.26 | 0.11 | 0.12       | 0.27 | 0.00 |
| Crit Moves:               | ****        |      |      |             |      |      |            | **** |      | ****       |      |      |
| Green Time:               | 45.1        | 0.0  | 45.1 | 0.0         | 0.0  | 0.0  | 0.0        | 34.2 | 34.2 | 15.7       | 49.9 | 0.0  |
| Volume/Cap:               | 0.79        | 0.00 | 0.18 | 0.00        | 0.00 | 0.00 | 0.00       | 0.79 | 0.34 | 0.79       | 0.57 | 0.00 |
| Delay/Veh:                | 31.2        | 0.0  | 18.3 | 0.0         | 0.0  | 0.0  | 0.0        | 38.6 | 26.8 | 57.5       | 19.8 | 0.0  |
| User DelAdj:              | 1.00        | 1.00 | 1.00 | 1.00        | 1.00 | 1.00 | 1.00       | 1.00 | 1.00 | 1.00       | 1.00 | 1.00 |
| AdjDel/Veh:               | 31.2        | 0.0  | 18.3 | 0.0         | 0.0  | 0.0  | 0.0        | 38.6 | 26.8 | 57.5       | 19.8 | 0.0  |
| LOS by Move:              | C           | A    | B    | A           | A    | A    | A          | D    | C    | E          | B    | A    |
| HCM2k95thQ:               | 33          | 0    | 6    | 0           | 0    | 0    | 0          | 26   | 10   | 17         | 22   | 0    |

Note: Queue reported is the number of cars per lane.



BART

Level Of Service Computation Report  
 2000 HCM Operations (Future Volume Alternative)  
 PM - Cumulative No Project

Intersection #3613: JULIAN/24TH [Study Int 2]

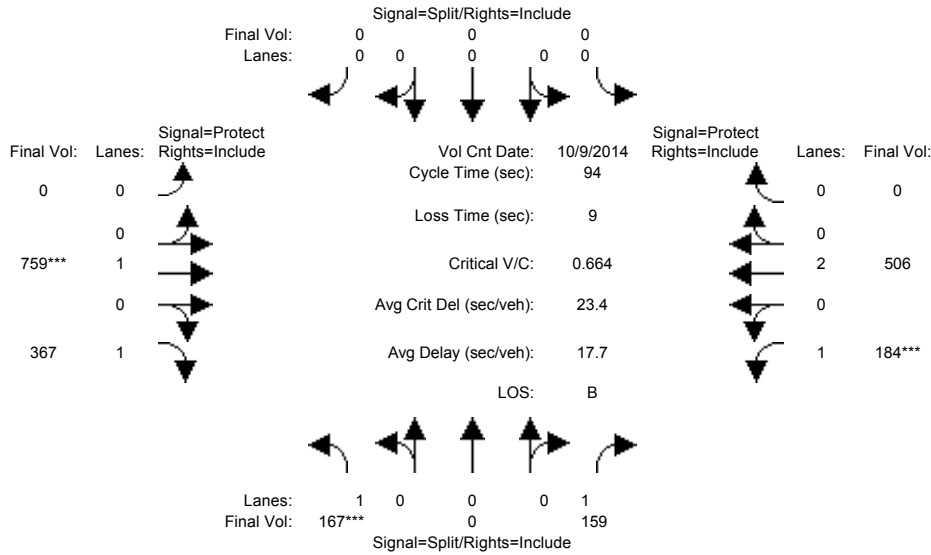

| Approach:                                   | North Bound |      |      | South Bound |      |      | East Bound |      |      | West Bound |      |      |
|---|-------------|------|------|-------------|------|------|------------|------|------|------------|------|------|
| Movement:                                   | L           | T    | R    | L           | T    | R    | L          | T    | R    | L          | T    | R    |
| Min. Green:                                 | 10          | 0    | 10   | 0           | 0    | 0    | 0          | 10   | 10   | 7          | 10   | 0    |
| Y+R:  | 4.0         | 4.0  | 4.0  | 4.0         | 4.0  | 4.0  | 4.0        | 4.0  | 4.0  | 4.0        | 4.0  | 0    |
| -----                                       |             |      |      |             |      |      |            |      |      |            |      |      |
| Volume Module: >> Count Date: 9 Oct 2014 << |             |      |      |             |      |      |            |      |      |            |      |      |
| Base Vol:                                   | 167         | 0    | 159  | 0           | 0    | 0    | 0          | 759  | 367  | 184        | 506  | 0    |
| Growth Adj:                                 | 1.00        | 1.00 | 1.00 | 1.00        | 1.00 | 1.00 | 1.00       | 1.00 | 1.00 | 1.00       | 1.00 | 1.00 |
| Initial Bse:                                | 167         | 0    | 159  | 0           | 0    | 0    | 0          | 759  | 367  | 184        | 506  | 0    |
| Added Vol:                                  | 0           | 0    | 0    | 0           | 0    | 0    | 0          | 0    | 0    | 0          | 0    | 0    |
| PasserByVol:                                | 0           | 0    | 0    | 0           | 0    | 0    | 0          | 0    | 0    | 0          | 0    | 0    |
| Initial Fut:                                | 167         | 0    | 159  | 0           | 0    | 0    | 0          | 759  | 367  | 184        | 506  | 0    |
| User Adj:                                   | 1.00        | 1.00 | 1.00 | 1.00        | 1.00 | 1.00 | 1.00       | 1.00 | 1.00 | 1.00       | 1.00 | 1.00 |
| PHF Adj:                                    | 1.00        | 1.00 | 1.00 | 1.00        | 1.00 | 1.00 | 1.00       | 1.00 | 1.00 | 1.00       | 1.00 | 1.00 |
| PHF Volume:                                 | 167         | 0    | 159  | 0           | 0    | 0    | 0          | 759  | 367  | 184        | 506  | 0    |
| Reduct Vol:                                 | 0           | 0    | 0    | 0           | 0    | 0    | 0          | 0    | 0    | 0          | 0    | 0    |
| Reduced Vol:                                | 167         | 0    | 159  | 0           | 0    | 0    | 0          | 759  | 367  | 184        | 506  | 0    |
| PCE Adj:                                    | 1.00        | 1.00 | 1.00 | 1.00        | 1.00 | 1.00 | 1.00       | 1.00 | 1.00 | 1.00       | 1.00 | 1.00 |
| MLF Adj:                                    | 1.00        | 1.00 | 1.00 | 1.00        | 1.00 | 1.00 | 1.00       | 1.00 | 1.00 | 1.00       | 1.00 | 1.00 |
| FinalVolume:                                | 167         | 0    | 159  | 0           | 0    | 0    | 0          | 759  | 367  | 184        | 506  | 0    |
| -----                                       |             |      |      |             |      |      |            |      |      |            |      |      |
| Saturation Flow Module:                     |             |      |      |             |      |      |            |      |      |            |      |      |
| Sat/Lane:                                   | 1900        | 1900 | 1900 | 1900        | 1900 | 1900 | 1900       | 1900 | 1900 | 1900       | 1900 | 1900 |
| Adjustment:                                 | 0.92        | 1.00 | 0.92 | 0.92        | 1.00 | 0.92 | 0.92       | 1.00 | 0.92 | 0.92       | 1.00 | 0.92 |
| Lanes:                                      | 1.00        | 0.00 | 1.00 | 0.00        | 0.00 | 0.00 | 0.00       | 1.00 | 1.00 | 1.00       | 2.00 | 0.00 |
| Final Sat.:                                 | 1750        | 0    | 1750 | 0           | 0    | 0    | 0          | 1900 | 1750 | 1750       | 3800 | 0    |
| -----                                       |             |      |      |             |      |      |            |      |      |            |      |      |
| Capacity Analysis Module:                   |             |      |      |             |      |      |            |      |      |            |      |      |
| Vol/Sat:                                    | 0.10        | 0.00 | 0.09 | 0.00        | 0.00 | 0.00 | 0.00       | 0.40 | 0.21 | 0.11       | 0.13 | 0.00 |
| Crit Moves:                                 | ****        |      |      |             |      |      | ****       |      |      | ****       |      |      |
| Green Time:                                 | 13.5        | 0.0  | 13.5 | 0.0         | 0.0  | 0.0  | 0.0        | 56.6 | 56.6 | 14.9       | 71.5 | 0.0  |
| Volume/Cap:                                 | 0.66        | 0.00 | 0.63 | 0.00        | 0.00 | 0.00 | 0.00       | 0.66 | 0.35 | 0.66       | 0.18 | 0.00 |
| Delay/Veh:                                  | 44.6        | 0.0  | 43.0 | 0.0         | 0.0  | 0.0  | 0.0        | 13.9 | 9.6  | 43.1       | 3.1  | 0.0  |
| User DelAdj:                                | 1.00        | 1.00 | 1.00 | 1.00        | 1.00 | 1.00 | 1.00       | 1.00 | 1.00 | 1.00       | 1.00 | 1.00 |
| AdjDel/Veh:                                 | 44.6        | 0.0  | 43.0 | 0.0         | 0.0  | 0.0  | 0.0        | 13.9 | 9.6  | 43.1       | 3.1  | 0.0  |
| LOS by Move:                                | D           | A    | D    | A           | A    | A    | A          | B    | A    | D          | A    | A    |
| HCM2k95thQ:                                 | 12          | 0    | 11   | 0           | 0    | 0    | 0          | 25   | 11   | 13         | 4    | 0    |

Note: Queue reported is the number of cars per lane.

BART

Level Of Service Computation Report  
2000 HCM Operations (Future Volume Alternative)  
AM - Cumulative With Project

Intersection #3613: JULIAN/24TH [Study Int 2]

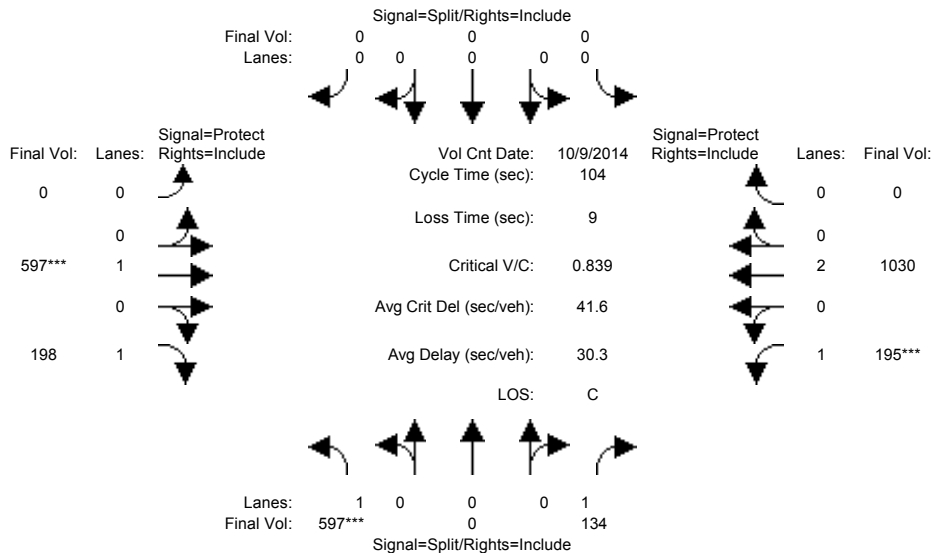

| Approach:                                   | North Bound |      |      | South Bound |      |      | East Bound |      |      | West Bound |      |      |
|---|-------------|------|------|-------------|------|------|------------|------|------|------------|------|------|
| Movement:                                   | L           | T    | R    | L           | T    | R    | L          | T    | R    | L          | T    | R    |
| Min. Green:                                 | 10          | 0    | 10   | 0           | 0    | 0    | 0          | 10   | 10   | 7          | 10   | 0    |
| Y+R:  | 4.0         | 4.0  | 4.0  | 4.0         | 4.0  | 4.0  | 4.0        | 4.0  | 4.0  | 4.0        | 4.0  | 4.0  |
| Volume Module: >> Count Date: 9 Oct 2014 << |             |      |      |             |      |      |            |      |      |            |      |      |
| Base Vol:                                   | 597         | 0    | 134  | 0           | 0    | 0    | 0          | 597  | 198  | 195        | 1030 | 0    |
| Growth Adj:                                 | 1.00        | 1.00 | 1.00 | 1.00        | 1.00 | 1.00 | 1.00       | 1.00 | 1.00 | 1.00       | 1.00 | 1.00 |
| Initial Bse:                                | 597         | 0    | 134  | 0           | 0    | 0    | 0          | 597  | 198  | 195        | 1030 | 0    |
| Added Vol:                                  | 0           | 0    | 0    | 0           | 0    | 0    | 0          | 0    | 0    | 0          | 0    | 0    |
| PasserByVol:                                | 0           | 0    | 0    | 0           | 0    | 0    | 0          | 0    | 0    | 0          | 0    | 0    |
| Initial Fut:                                | 597         | 0    | 134  | 0           | 0    | 0    | 0          | 597  | 198  | 195        | 1030 | 0    |
| User Adj:                                   | 1.00        | 1.00 | 1.00 | 1.00        | 1.00 | 1.00 | 1.00       | 1.00 | 1.00 | 1.00       | 1.00 | 1.00 |
| PHF Adj:                                    | 1.00        | 1.00 | 1.00 | 1.00        | 1.00 | 1.00 | 1.00       | 1.00 | 1.00 | 1.00       | 1.00 | 1.00 |
| PHF Volume:                                 | 597         | 0    | 134  | 0           | 0    | 0    | 0          | 597  | 198  | 195        | 1030 | 0    |
| Reduct Vol:                                 | 0           | 0    | 0    | 0           | 0    | 0    | 0          | 0    | 0    | 0          | 0    | 0    |
| Reduced Vol:                                | 597         | 0    | 134  | 0           | 0    | 0    | 0          | 597  | 198  | 195        | 1030 | 0    |
| PCE Adj:                                    | 1.00        | 1.00 | 1.00 | 1.00        | 1.00 | 1.00 | 1.00       | 1.00 | 1.00 | 1.00       | 1.00 | 1.00 |
| MLF Adj:                                    | 1.00        | 1.00 | 1.00 | 1.00        | 1.00 | 1.00 | 1.00       | 1.00 | 1.00 | 1.00       | 1.00 | 1.00 |
| FinalVolume:                                | 597         | 0    | 134  | 0           | 0    | 0    | 0          | 597  | 198  | 195        | 1030 | 0    |
| Saturation Flow Module:                     |             |      |      |             |      |      |            |      |      |            |      |      |
| Sat/Lane:                                   | 1900        | 1900 | 1900 | 1900        | 1900 | 1900 | 1900       | 1900 | 1900 | 1900       | 1900 | 1900 |
| Adjustment:                                 | 0.92        | 1.00 | 0.92 | 0.92        | 1.00 | 0.92 | 0.92       | 1.00 | 0.92 | 0.92       | 1.00 | 0.92 |
| Lanes:                                      | 1.00        | 0.00 | 1.00 | 0.00        | 0.00 | 0.00 | 0.00       | 1.00 | 1.00 | 1.00       | 2.00 | 0.00 |
| Final Sat.:                                 | 1750        | 0    | 1750 | 0           | 0    | 0    | 0          | 1900 | 1750 | 1750       | 3800 | 0    |
| Capacity Analysis Module:                   |             |      |      |             |      |      |            |      |      |            |      |      |
| Vol/Sat:                                    | 0.34        | 0.00 | 0.08 | 0.00        | 0.00 | 0.00 | 0.00       | 0.31 | 0.11 | 0.11       | 0.27 | 0.00 |
| Crit Moves:                                 | ****        |      |      |             |      |      | ****       |      |      | ****       |      |      |
| Green Time:                                 | 42.3        | 0.0  | 42.3 | 0.0         | 0.0  | 0.0  | 0.0        | 38.9 | 38.9 | 13.8       | 52.7 | 0.0  |
| Volume/Cap:                                 | 0.84        | 0.00 | 0.19 | 0.00        | 0.00 | 0.00 | 0.00       | 0.84 | 0.30 | 0.84       | 0.53 | 0.00 |
| Delay/Veh:                                  | 36.6        | 0.0  | 20.0 | 0.0         | 0.0  | 0.0  | 0.0        | 38.5 | 23.2 | 66.9       | 17.6 | 0.0  |
| User DelAdj:                                | 1.00        | 1.00 | 1.00 | 1.00        | 1.00 | 1.00 | 1.00       | 1.00 | 1.00 | 1.00       | 1.00 | 1.00 |
| AdjDel/Veh:                                 | 36.6        | 0.0  | 20.0 | 0.0         | 0.0  | 0.0  | 0.0        | 38.5 | 23.2 | 66.9       | 17.6 | 0.0  |
| LOS by Move:                                | D           | A    | B    | A           | A    | A    | A          | D    | C    | E          | B    | A    |
| HCM2k95thQ:                                 | 35          | 0    | 6    | 0           | 0    | 0    | 0          | 31   | 9    | 17         | 20   | 0    |

Note: Queue reported is the number of cars per lane.

BART

Level Of Service Computation Report  
 2000 HCM Operations (Future Volume Alternative)  
 PM - Cumulative With Project

Intersection #3613: JULIAN/24TH [Study Int 2]

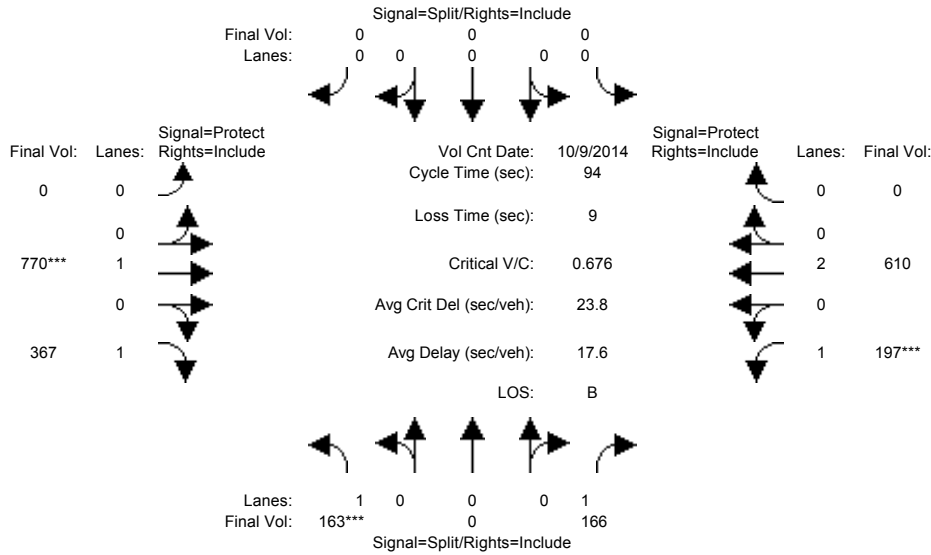

| Approach:                                   | North Bound |      |      | South Bound |      |      | East Bound |      |      | West Bound |      |      |
|---|-------------|------|------|-------------|------|------|------------|------|------|------------|------|------|
| Movement:                                   | L           | T    | R    | L           | T    | R    | L          | T    | R    | L          | T    | R    |
| Min. Green:                                 | 10          | 0    | 10   | 0           | 0    | 0    | 0          | 10   | 10   | 7          | 10   | 0    |
| Y+R:  | 4.0         | 4.0  | 4.0  | 4.0         | 4.0  | 4.0  | 4.0        | 4.0  | 4.0  | 4.0        | 4.0  | 4.0  |
| Volume Module: >> Count Date: 9 Oct 2014 << |             |      |      |             |      |      |            |      |      |            |      |      |
| Base Vol:                                   | 163         | 0    | 166  | 0           | 0    | 0    | 0          | 770  | 367  | 197        | 610  | 0    |
| Growth Adj:                                 | 1.00        | 1.00 | 1.00 | 1.00        | 1.00 | 1.00 | 1.00       | 1.00 | 1.00 | 1.00       | 1.00 | 1.00 |
| Initial Bse:                                | 163         | 0    | 166  | 0           | 0    | 0    | 0          | 770  | 367  | 197        | 610  | 0    |
| Added Vol:                                  | 0           | 0    | 0    | 0           | 0    | 0    | 0          | 0    | 0    | 0          | 0    | 0    |
| PasserByVol:                                | 0           | 0    | 0    | 0           | 0    | 0    | 0          | 0    | 0    | 0          | 0    | 0    |
| Initial Fut:                                | 163         | 0    | 166  | 0           | 0    | 0    | 0          | 770  | 367  | 197        | 610  | 0    |
| User Adj:                                   | 1.00        | 1.00 | 1.00 | 1.00        | 1.00 | 1.00 | 1.00       | 1.00 | 1.00 | 1.00       | 1.00 | 1.00 |
| PHF Adj:                                    | 1.00        | 1.00 | 1.00 | 1.00        | 1.00 | 1.00 | 1.00       | 1.00 | 1.00 | 1.00       | 1.00 | 1.00 |
| PHF Volume:                                 | 163         | 0    | 166  | 0           | 0    | 0    | 0          | 770  | 367  | 197        | 610  | 0    |
| Reduct Vol:                                 | 0           | 0    | 0    | 0           | 0    | 0    | 0          | 0    | 0    | 0          | 0    | 0    |
| Reduced Vol:                                | 163         | 0    | 166  | 0           | 0    | 0    | 0          | 770  | 367  | 197        | 610  | 0    |
| PCE Adj:                                    | 1.00        | 1.00 | 1.00 | 1.00        | 1.00 | 1.00 | 1.00       | 1.00 | 1.00 | 1.00       | 1.00 | 1.00 |
| MLF Adj:                                    | 1.00        | 1.00 | 1.00 | 1.00        | 1.00 | 1.00 | 1.00       | 1.00 | 1.00 | 1.00       | 1.00 | 1.00 |
| Final Volume:                               | 163         | 0    | 166  | 0           | 0    | 0    | 0          | 770  | 367  | 197        | 610  | 0    |
| Saturation Flow Module:                     |             |      |      |             |      |      |            |      |      |            |      |      |
| Sat/Lane:                                   | 1900        | 1900 | 1900 | 1900        | 1900 | 1900 | 1900       | 1900 | 1900 | 1900       | 1900 | 1900 |
| Adjustment:                                 | 0.92        | 1.00 | 0.92 | 0.92        | 1.00 | 0.92 | 0.92       | 1.00 | 0.92 | 0.92       | 1.00 | 0.92 |
| Lanes:                                      | 1.00        | 0.00 | 1.00 | 0.00        | 0.00 | 0.00 | 0.00       | 1.00 | 1.00 | 1.00       | 2.00 | 0.00 |
| Final Sat.:                                 | 1750        | 0    | 1750 | 0           | 0    | 0    | 0          | 1900 | 1750 | 1750       | 3800 | 0    |
| Capacity Analysis Module:                   |             |      |      |             |      |      |            |      |      |            |      |      |
| Vol/Sat:                                    | 0.09        | 0.00 | 0.09 | 0.00        | 0.00 | 0.00 | 0.00       | 0.41 | 0.21 | 0.11       | 0.16 | 0.00 |
| Crit Moves:                                 | ****        |      |      |             |      |      |            | **** |      | ****       |      |      |
| Green Time:                                 | 13.2        | 0.0  | 13.2 | 0.0         | 0.0  | 0.0  | 0.0        | 56.2 | 56.2 | 15.6       | 71.8 | 0.0  |
| Volume/Cap:                                 | 0.67        | 0.00 | 0.68 | 0.00        | 0.00 | 0.00 | 0.00       | 0.68 | 0.35 | 0.68       | 0.21 | 0.00 |
| Delay/Veh:                                  | 45.1        | 0.0  | 45.8 | 0.0         | 0.0  | 0.0  | 0.0        | 14.4 | 9.8  | 43.1       | 3.1  | 0.0  |
| User DelAdj:                                | 1.00        | 1.00 | 1.00 | 1.00        | 1.00 | 1.00 | 1.00       | 1.00 | 1.00 | 1.00       | 1.00 | 1.00 |
| AdjDel/Veh:                                 | 45.1        | 0.0  | 45.8 | 0.0         | 0.0  | 0.0  | 0.0        | 14.4 | 9.8  | 43.1       | 3.1  | 0.0  |
| LOS by Move:                                | D           | A    | D    | A           | A    | A    | A          | B    | A    | D          | A    | A    |
| HCM2k95thQ:                                 | 12          | 0    | 12   | 0           | 0    | 0    | 0          | 26   | 11   | 13         | 5    | 0    |

Note: Queue reported is the number of cars per lane.

BART

Level Of Service Computation Report  
 2000 HCM Operations (Future Volume Alternative)  
 AM - Cumulative No Project

Intersection #3623: KING/MABURY [Study Int 27]

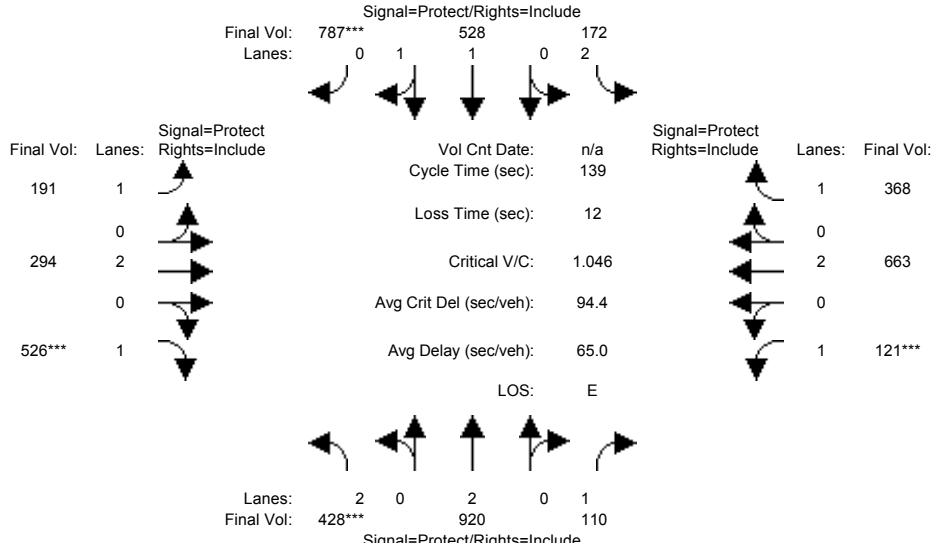

| Approach:                 | North Bound |      |      | South Bound |      |      | East Bound |      |       | West Bound |      |      |
|---------------------------|-------------|------|------|-------------|------|------|------------|------|-------|------------|------|------|
| Movement:                 | L           | T    | R    | L           | T    | R    | L          | T    | R     | L          | T    | R    |
| Min. Green:               | 7           | 10   | 10   | 7           | 10   | 10   | 7          | 10   | 10    | 7          | 10   | 10   |
| Y+R:                      | 4.0         | 4.0  | 4.0  | 4.0         | 4.0  | 4.0  | 4.0        | 4.0  | 4.0   | 4.0        | 4.0  | 4.0  |
| Volume Module:            |             |      |      |             |      |      |            |      |       |            |      |      |
| Base Vol:                 | 428         | 920  | 110  | 172         | 528  | 787  | 191        | 294  | 526   | 121        | 663  | 368  |
| Growth Adj:               | 1.00        | 1.00 | 1.00 | 1.00        | 1.00 | 1.00 | 1.00       | 1.00 | 1.00  | 1.00       | 1.00 | 1.00 |
| Initial Bse:              | 428         | 920  | 110  | 172         | 528  | 787  | 191        | 294  | 526   | 121        | 663  | 368  |
| Added Vol:                | 0           | 0    | 0    | 0           | 0    | 0    | 0          | 0    | 0     | 0          | 0    | 0    |
| PasserByVol:              | 0           | 0    | 0    | 0           | 0    | 0    | 0          | 0    | 0     | 0          | 0    | 0    |
| Initial Fut:              | 428         | 920  | 110  | 172         | 528  | 787  | 191        | 294  | 526   | 121        | 663  | 368  |
| User Adj:                 | 1.00        | 1.00 | 1.00 | 1.00        | 1.00 | 1.00 | 1.00       | 1.00 | 1.00  | 1.00       | 1.00 | 1.00 |
| PHF Adj:                  | 1.00        | 1.00 | 1.00 | 1.00        | 1.00 | 1.00 | 1.00       | 1.00 | 1.00  | 1.00       | 1.00 | 1.00 |
| PHF Volume:               | 428         | 920  | 110  | 172         | 528  | 787  | 191        | 294  | 526   | 121        | 663  | 368  |
| Reduct Vol:               | 0           | 0    | 0    | 0           | 0    | 0    | 0          | 0    | 0     | 0          | 0    | 0    |
| Reduced Vol:              | 428         | 920  | 110  | 172         | 528  | 787  | 191        | 294  | 526   | 121        | 663  | 368  |
| PCE Adj:                  | 1.00        | 1.00 | 1.00 | 1.00        | 1.00 | 1.00 | 1.00       | 1.00 | 1.00  | 1.00       | 1.00 | 1.00 |
| MLF Adj:                  | 1.00        | 1.00 | 1.00 | 1.00        | 1.00 | 1.00 | 1.00       | 1.00 | 1.00  | 1.00       | 1.00 | 1.00 |
| Final Volume:             | 428         | 920  | 110  | 172         | 528  | 787  | 191        | 294  | 526   | 121        | 663  | 368  |
| Saturation Flow Module:   |             |      |      |             |      |      |            |      |       |            |      |      |
| Sat/Lane:                 | 1900        | 1900 | 1900 | 1900        | 1900 | 1900 | 1900       | 1900 | 1900  | 1900       | 1900 | 1900 |
| Adjustment:               | 0.83        | 1.00 | 0.92 | 0.83        | 1.00 | 0.92 | 0.92       | 1.00 | 0.92  | 0.92       | 1.00 | 0.92 |
| Lanes:                    | 2.00        | 2.00 | 1.00 | 2.00        | 1.00 | 1.00 | 1.00       | 2.00 | 1.00  | 1.00       | 2.00 | 1.00 |
| Final Sat.:               | 3150        | 3800 | 1750 | 3150        | 1900 | 1750 | 1750       | 3800 | 1750  | 1750       | 3800 | 1750 |
| Capacity Analysis Module: |             |      |      |             |      |      |            |      |       |            |      |      |
| Vol/Sat:                  | 0.14        | 0.24 | 0.06 | 0.05        | 0.28 | 0.45 | 0.11       | 0.08 | 0.30  | 0.07       | 0.17 | 0.21 |
| Crit Moves:               | ****        |      |      | ****        |      |      | ****       |      | ****  | ****       |      |      |
| Green Time:               | 18.1        | 63.5 | 63.5 | 14.3        | 59.8 | 59.8 | 16.8       | 40.0 | 40.0  | 9.2        | 32.4 | 32.4 |
| Volume/Cap:               | 1.05        | 0.53 | 0.14 | 0.53        | 0.65 | 1.05 | 0.90       | 0.27 | 1.05  | 1.05       | 0.75 | 0.90 |
| Delay/Veh:                | 117.3       | 27.4 | 21.9 | 60.8        | 32.0 | 77.8 | 96.9       | 38.4 | 102.1 | 161.3      | 53.2 | 74.7 |
| User DelAdj:              | 1.00        | 1.00 | 1.00 | 1.00        | 1.00 | 1.00 | 1.00       | 1.00 | 1.00  | 1.00       | 1.00 | 1.00 |
| AdjDel/Veh:               | 117.3       | 27.4 | 21.9 | 60.8        | 32.0 | 77.8 | 96.9       | 38.4 | 102.1 | 161.3      | 53.2 | 74.7 |
| LOS by Move:              | F           | C    | C    | E           | C    | E    | F          | D    | F     | F          | D    | E    |
| HCM2k95thQ:               | 25          | 24   | 6    | 8           | 30   | 69   | 18         | 9    | 49    | 14         | 24   | 31   |

Note: Queue reported is the number of cars per lane.

BART

Level Of Service Computation Report  
 2000 HCM Operations (Future Volume Alternative)  
 PM - Cumulative No Project

Intersection #3623: KING/MABURY [Study Int 27]

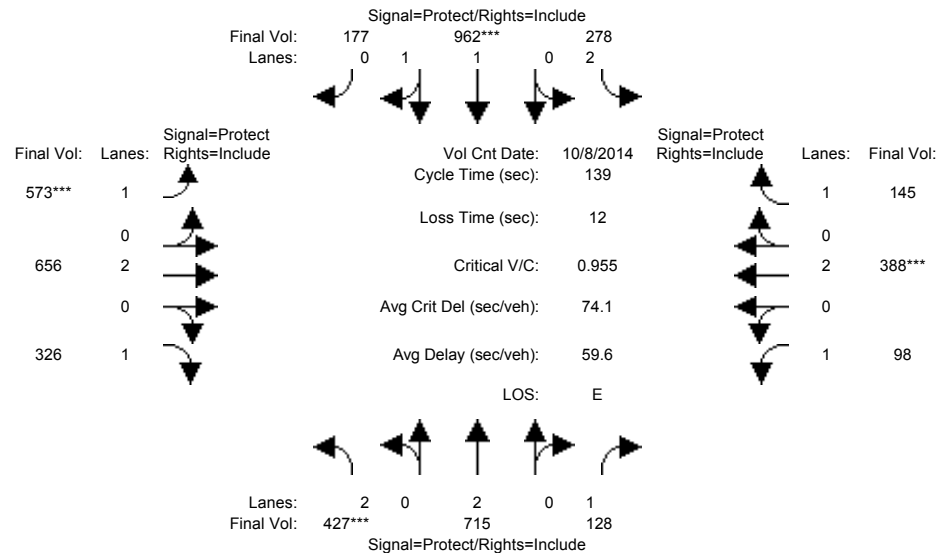

| Approach:                                   | North Bound |      |      | South Bound |      |      | East Bound |      |      | West Bound |      |      |
|---|-------------|------|------|-------------|------|------|------------|------|------|------------|------|------|
| Movement:                                   | L           | T    | R    | L           | T    | R    | L          | T    | R    | L          | T    | R    |
| Min. Green:                                 | 7           | 10   | 10   | 7           | 10   | 10   | 7          | 10   | 10   | 7          | 10   | 10   |
| Y+R:  | 4.0         | 4.0  | 4.0  | 4.0         | 4.0  | 4.0  | 4.0        | 4.0  | 4.0  | 4.0        | 4.0  | 4.0  |
| Volume Module: >> Count Date: 8 Oct 2014 << |             |      |      |             |      |      |            |      |      |            |      |      |
| Base Vol:                                   | 427         | 715  | 128  | 278         | 962  | 177  | 573        | 656  | 326  | 98         | 388  | 145  |
| Growth Adj:                                 | 1.00        | 1.00 | 1.00 | 1.00        | 1.00 | 1.00 | 1.00       | 1.00 | 1.00 | 1.00       | 1.00 | 1.00 |
| Initial Bse:                                | 427         | 715  | 128  | 278         | 962  | 177  | 573        | 656  | 326  | 98         | 388  | 145  |
| Added Vol:                                  | 0           | 0    | 0    | 0           | 0    | 0    | 0          | 0    | 0    | 0          | 0    | 0    |
| PasserByVol:                                | 0           | 0    | 0    | 0           | 0    | 0    | 0          | 0    | 0    | 0          | 0    | 0    |
| Initial Fut:                                | 427         | 715  | 128  | 278         | 962  | 177  | 573        | 656  | 326  | 98         | 388  | 145  |
| User Adj:                                   | 1.00        | 1.00 | 1.00 | 1.00        | 1.00 | 1.00 | 1.00       | 1.00 | 1.00 | 1.00       | 1.00 | 1.00 |
| PHF Adj:                                    | 1.00        | 1.00 | 1.00 | 1.00        | 1.00 | 1.00 | 1.00       | 1.00 | 1.00 | 1.00       | 1.00 | 1.00 |
| PHF Volume:                                 | 427         | 715  | 128  | 278         | 962  | 177  | 573        | 656  | 326  | 98         | 388  | 145  |
| Reduct Vol:                                 | 0           | 0    | 0    | 0           | 0    | 0    | 0          | 0    | 0    | 0          | 0    | 0    |
| Reduced Vol:                                | 427         | 715  | 128  | 278         | 962  | 177  | 573        | 656  | 326  | 98         | 388  | 145  |
| PCE Adj:                                    | 1.00        | 1.00 | 1.00 | 1.00        | 1.00 | 1.00 | 1.00       | 1.00 | 1.00 | 1.00       | 1.00 | 1.00 |
| MLF Adj:                                    | 1.00        | 1.00 | 1.00 | 1.00        | 1.00 | 1.00 | 1.00       | 1.00 | 1.00 | 1.00       | 1.00 | 1.00 |
| Final Volume:                               | 427         | 715  | 128  | 278         | 962  | 177  | 573        | 656  | 326  | 98         | 388  | 145  |
| Saturation Flow Module:                     |             |      |      |             |      |      |            |      |      |            |      |      |
| Sat/Lane:                                   | 1900        | 1900 | 1900 | 1900        | 1900 | 1900 | 1900       | 1900 | 1900 | 1900       | 1900 | 1900 |
| Adjustment:                                 | 0.83        | 1.00 | 0.92 | 0.83        | 0.98 | 0.95 | 0.92       | 1.00 | 0.92 | 0.92       | 1.00 | 0.92 |
| Lanes:                                      | 2.00        | 2.00 | 1.00 | 2.00        | 1.68 | 0.32 | 1.00       | 2.00 | 1.00 | 1.00       | 2.00 | 1.00 |
| Final Sat.:                                 | 3150        | 3800 | 1750 | 3150        | 3125 | 575  | 1750       | 3800 | 1750 | 1750       | 3800 | 1750 |
| Capacity Analysis Module:                   |             |      |      |             |      |      |            |      |      |            |      |      |
| Vol/Sat:                                    | 0.14        | 0.19 | 0.07 | 0.09        | 0.31 | 0.31 | 0.33       | 0.17 | 0.19 | 0.06       | 0.10 | 0.08 |
| Crit Moves:                                 | ****        |      |      | ****        |      |      | ****       |      |      | ****       |      |      |
| Green Time:                                 | 19.7        | 43.9 | 43.9 | 20.6        | 44.8 | 44.8 | 47.6       | 48.0 | 48.0 | 14.4       | 14.9 | 14.9 |
| Volume/Cap:                                 | 0.96        | 0.60 | 0.23 | 0.60        | 0.96 | 0.96 | 0.96       | 0.50 | 0.54 | 0.54       | 0.96 | 0.78 |
| Delay/Veh:                                  | 90.5        | 40.9 | 35.3 | 57.4        | 62.6 | 62.6 | 70.7       | 36.3 | 37.5 | 62.3       | 95.0 | 78.6 |
| User DelAdj:                                | 1.00        | 1.00 | 1.00 | 1.00        | 1.00 | 1.00 | 1.00       | 1.00 | 1.00 | 1.00       | 1.00 | 1.00 |
| AdjDel/Veh:                                 | 90.5        | 40.9 | 35.3 | 57.4        | 62.6 | 62.6 | 70.7       | 36.3 | 37.5 | 62.3       | 95.0 | 78.6 |
| LOS by Move:                                | F           | D    | D    | E           | E    | E    | E          | D    | D    | E          | F    | E    |
| HCM2k95thQ:                                 | 23          | 23   | 8    | 13          | 45   | 45   | 47         | 20   | 21   | 8          | 18   | 13   |

Note: Queue reported is the number of cars per lane.

BART

Level Of Service Computation Report  
2000 HCM Operations (Future Volume Alternative)  
AM - Cumulative With Project

Intersection #3623: KING/MABURY [Study Int 27]

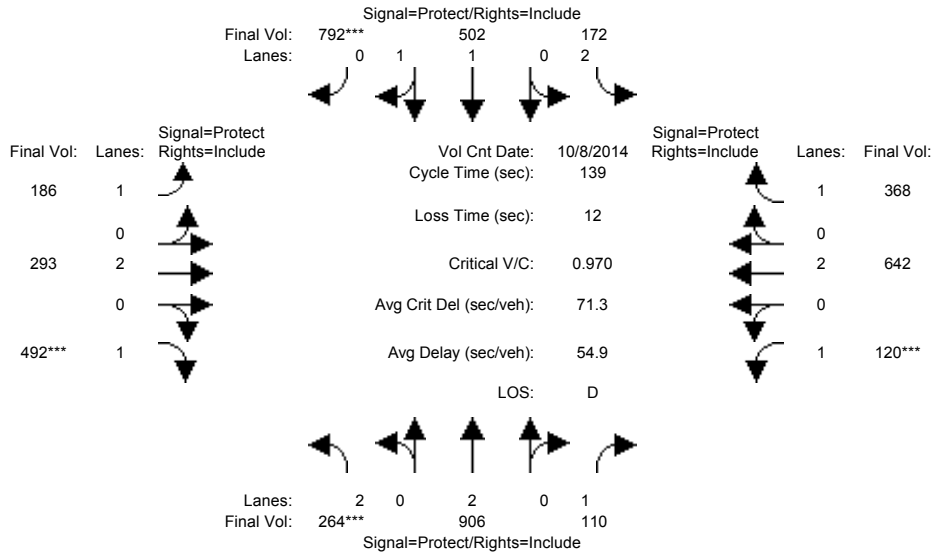

| Approach:                                   | North Bound |      |      | South Bound |      |      | East Bound |      |      | West Bound |      |      |
|---|-------------|------|------|-------------|------|------|------------|------|------|------------|------|------|
| Movement:                                   | L           | T    | R    | L           | T    | R    | L          | T    | R    | L          | T    | R    |
| Min. Green:                                 | 7           | 10   | 10   | 7           | 10   | 10   | 7          | 10   | 10   | 7          | 10   | 10   |
| Y+R:  | 4.0         | 4.0  | 4.0  | 4.0         | 4.0  | 4.0  | 4.0        | 4.0  | 4.0  | 4.0        | 4.0  | 4.0  |
| Volume Module: >> Count Date: 8 Oct 2014 << |             |      |      |             |      |      |            |      |      |            |      |      |
| Base Vol:                                   | 264         | 906  | 110  | 172         | 502  | 792  | 186        | 293  | 492  | 120        | 642  | 368  |
| Growth Adj:                                 | 1.00        | 1.00 | 1.00 | 1.00        | 1.00 | 1.00 | 1.00       | 1.00 | 1.00 | 1.00       | 1.00 | 1.00 |
| Initial Bse:                                | 264         | 906  | 110  | 172         | 502  | 792  | 186        | 293  | 492  | 120        | 642  | 368  |
| Added Vol:                                  | 0           | 0    | 0    | 0           | 0    | 0    | 0          | 0    | 0    | 0          | 0    | 0    |
| PasserByVol:                                | 0           | 0    | 0    | 0           | 0    | 0    | 0          | 0    | 0    | 0          | 0    | 0    |
| Initial Fut:                                | 264         | 906  | 110  | 172         | 502  | 792  | 186        | 293  | 492  | 120        | 642  | 368  |
| User Adj:                                   | 1.00        | 1.00 | 1.00 | 1.00        | 1.00 | 1.00 | 1.00       | 1.00 | 1.00 | 1.00       | 1.00 | 1.00 |
| PHF Adj:                                    | 1.00        | 1.00 | 1.00 | 1.00        | 1.00 | 1.00 | 1.00       | 1.00 | 1.00 | 1.00       | 1.00 | 1.00 |
| PHF Volume:                                 | 264         | 906  | 110  | 172         | 502  | 792  | 186        | 293  | 492  | 120        | 642  | 368  |
| Reduct Vol:                                 | 0           | 0    | 0    | 0           | 0    | 0    | 0          | 0    | 0    | 0          | 0    | 0    |
| Reduced Vol:                                | 264         | 906  | 110  | 172         | 502  | 792  | 186        | 293  | 492  | 120        | 642  | 368  |
| PCE Adj:                                    | 1.00        | 1.00 | 1.00 | 1.00        | 1.00 | 1.00 | 1.00       | 1.00 | 1.00 | 1.00       | 1.00 | 1.00 |
| MLF Adj:                                    | 1.00        | 1.00 | 1.00 | 1.00        | 1.00 | 1.00 | 1.00       | 1.00 | 1.00 | 1.00       | 1.00 | 1.00 |
| Final Volume:                               | 264         | 906  | 110  | 172         | 502  | 792  | 186        | 293  | 492  | 120        | 642  | 368  |
| Saturation Flow Module:                     |             |      |      |             |      |      |            |      |      |            |      |      |
| Sat/Lane:                                   | 1900        | 1900 | 1900 | 1900        | 1900 | 1900 | 1900       | 1900 | 1900 | 1900       | 1900 | 1900 |
| Adjustment:                                 | 0.83        | 1.00 | 0.92 | 0.83        | 1.00 | 0.92 | 0.92       | 1.00 | 0.92 | 0.92       | 1.00 | 0.92 |
| Lanes:                                      | 2.00        | 2.00 | 1.00 | 2.00        | 1.00 | 1.00 | 1.00       | 2.00 | 1.00 | 1.00       | 2.00 | 1.00 |
| Final Sat.:                                 | 3150        | 3800 | 1750 | 3150        | 1900 | 1750 | 1750       | 3800 | 1750 | 1750       | 3800 | 1750 |
| Capacity Analysis Module:                   |             |      |      |             |      |      |            |      |      |            |      |      |
| Vol/Sat:                                    | 0.08        | 0.24 | 0.06 | 0.05        | 0.26 | 0.45 | 0.11       | 0.08 | 0.28 | 0.07       | 0.17 | 0.21 |
| Crit Moves:                                 | ****        |      |      | ****        |      |      | ****       |      | **** | ****       |      |      |
| Green Time:                                 | 12.0        | 62.6 | 62.6 | 14.3        | 64.9 | 64.9 | 16.8       | 40.3 | 40.3 | 9.8        | 33.3 | 33.3 |
| Volume/Cap:                                 | 0.97        | 0.53 | 0.14 | 0.53        | 0.57 | 0.97 | 0.88       | 0.27 | 0.97 | 0.97       | 0.71 | 0.88 |
| Delay/Veh:                                  | 109.4       | 27.9 | 22.5 | 60.8        | 27.2 | 53.9 | 91.4       | 38.1 | 80.9 | 135.7      | 50.9 | 69.5 |
| User DelAdj:                                | 1.00        | 1.00 | 1.00 | 1.00        | 1.00 | 1.00 | 1.00       | 1.00 | 1.00 | 1.00       | 1.00 | 1.00 |
| AdjDel/Veh:                                 | 109.4       | 27.9 | 22.5 | 60.8        | 27.2 | 53.9 | 91.4       | 38.1 | 80.9 | 135.7      | 50.9 | 69.5 |
| LOS by Move:                                | F           | C    | C    | E           | C    | D    | F          | D    | F    | F          | D    | E    |
| HCM2k95thQ:                                 | 16          | 24   | 6    | 8           | 27   | 63   | 18         | 9    | 43   | 13         | 23   | 31   |

Note: Queue reported is the number of cars per lane.

BART

Level Of Service Computation Report  
2000 HCM Operations (Future Volume Alternative)  
PM - Cumulative With Project

Intersection #3623: KING/MABURY [Study Int 27]

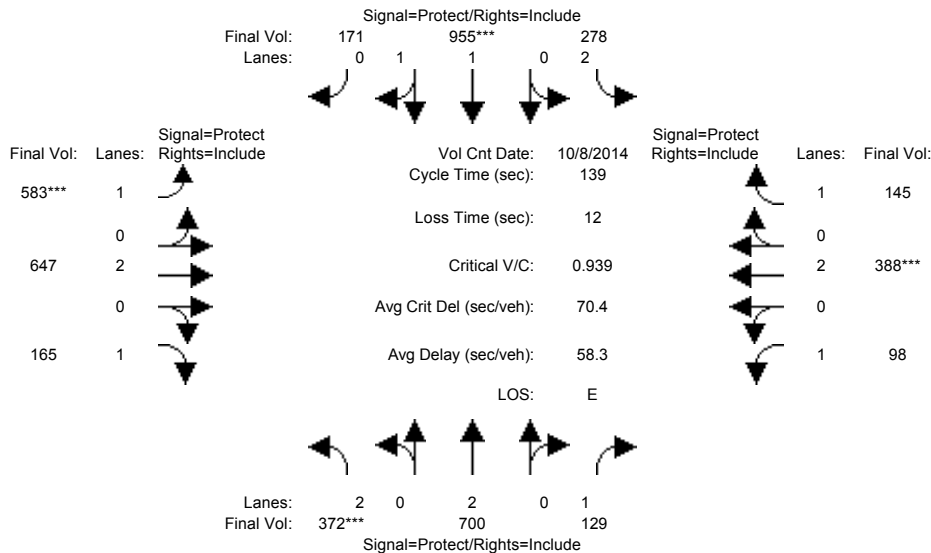

| Approach:                 | North Bound                  |      |      | South Bound |      |      | East Bound |      |      | West Bound |      |      |
|---------------------------|------------------------------|------|------|-------------|------|------|------------|------|------|------------|------|------|
| Movement:                 | L                            | T    | R    | L           | T    | R    | L          | T    | R    | L          | T    | R    |
| Min. Green:               | 7                            | 10   | 10   | 7           | 10   | 10   | 7          | 10   | 10   | 7          | 10   | 10   |
| Y+R:                      | 4.0                          | 4.0  | 4.0  | 4.0         | 4.0  | 4.0  | 4.0        | 4.0  | 4.0  | 4.0        | 4.0  | 4.0  |
| Volume Module:            | >> Count Date: 8 Oct 2014 << |      |      |             |      |      |            |      |      |            |      |      |
| Base Vol:                 | 372                          | 700  | 129  | 278         | 955  | 171  | 583        | 647  | 165  | 98         | 388  | 145  |
| Growth Adj:               | 1.00                         | 1.00 | 1.00 | 1.00        | 1.00 | 1.00 | 1.00       | 1.00 | 1.00 | 1.00       | 1.00 | 1.00 |
| Initial Bse:              | 372                          | 700  | 129  | 278         | 955  | 171  | 583        | 647  | 165  | 98         | 388  | 145  |
| Added Vol:                | 0                            | 0    | 0    | 0           | 0    | 0    | 0          | 0    | 0    | 0          | 0    | 0    |
| PasserByVol:              | 0                            | 0    | 0    | 0           | 0    | 0    | 0          | 0    | 0    | 0          | 0    | 0    |
| Initial Fut:              | 372                          | 700  | 129  | 278         | 955  | 171  | 583        | 647  | 165  | 98         | 388  | 145  |
| User Adj:                 | 1.00                         | 1.00 | 1.00 | 1.00        | 1.00 | 1.00 | 1.00       | 1.00 | 1.00 | 1.00       | 1.00 | 1.00 |
| PHF Adj:                  | 1.00                         | 1.00 | 1.00 | 1.00        | 1.00 | 1.00 | 1.00       | 1.00 | 1.00 | 1.00       | 1.00 | 1.00 |
| PHF Volume:               | 372                          | 700  | 129  | 278         | 955  | 171  | 583        | 647  | 165  | 98         | 388  | 145  |
| Reduct Vol:               | 0                            | 0    | 0    | 0           | 0    | 0    | 0          | 0    | 0    | 0          | 0    | 0    |
| Reduced Vol:              | 372                          | 700  | 129  | 278         | 955  | 171  | 583        | 647  | 165  | 98         | 388  | 145  |
| PCE Adj:                  | 1.00                         | 1.00 | 1.00 | 1.00        | 1.00 | 1.00 | 1.00       | 1.00 | 1.00 | 1.00       | 1.00 | 1.00 |
| MLF Adj:                  | 1.00                         | 1.00 | 1.00 | 1.00        | 1.00 | 1.00 | 1.00       | 1.00 | 1.00 | 1.00       | 1.00 | 1.00 |
| Final Volume:             | 372                          | 700  | 129  | 278         | 955  | 171  | 583        | 647  | 165  | 98         | 388  | 145  |
| Saturation Flow Module:   |                              |      |      |             |      |      |            |      |      |            |      |      |
| Sat/Lane:                 | 1900                         | 1900 | 1900 | 1900        | 1900 | 1900 | 1900       | 1900 | 1900 | 1900       | 1900 | 1900 |
| Adjustment:               | 0.83                         | 1.00 | 0.92 | 0.83        | 0.98 | 0.95 | 0.92       | 1.00 | 0.92 | 0.92       | 1.00 | 0.92 |
| Lanes:                    | 2.00                         | 2.00 | 1.00 | 2.00        | 1.69 | 0.31 | 1.00       | 2.00 | 1.00 | 1.00       | 2.00 | 1.00 |
| Final Sat.:               | 3150                         | 3800 | 1750 | 3150        | 3138 | 562  | 1750       | 3800 | 1750 | 1750       | 3800 | 1750 |
| Capacity Analysis Module: |                              |      |      |             |      |      |            |      |      |            |      |      |
| Vol/Sat:                  | 0.12                         | 0.18 | 0.07 | 0.09        | 0.30 | 0.30 | 0.33       | 0.17 | 0.09 | 0.06       | 0.10 | 0.08 |
| Crit Moves:               | ****                         |      |      |             |      |      |            |      |      |            |      |      |
| Green Time:               | 17.5                         | 42.3 | 42.3 | 20.3        | 45.1 | 45.1 | 49.3       | 48.5 | 48.5 | 16.0       | 15.1 | 15.1 |
| Volume/Cap:               | 0.94                         | 0.61 | 0.24 | 0.61        | 0.94 | 0.94 | 0.94       | 0.49 | 0.27 | 0.49       | 0.94 | 0.76 |
| Delay/Veh:                | 90.3                         | 42.2 | 36.6 | 57.9        | 59.4 | 59.4 | 65.6       | 35.8 | 32.8 | 59.6       | 90.7 | 76.6 |
| User DelAdj:              | 1.00                         | 1.00 | 1.00 | 1.00        | 1.00 | 1.00 | 1.00       | 1.00 | 1.00 | 1.00       | 1.00 | 1.00 |
| AdjDel/Veh:               | 90.3                         | 42.2 | 36.6 | 57.9        | 59.4 | 59.4 | 65.6       | 35.8 | 32.8 | 59.6       | 90.7 | 76.6 |
| LOS by Move:              | F                            | D    | D    | E           | E    | E    | E          | D    | C    | E          | F    | E    |
| HCM2k95thQ:               | 20                           | 22   | 8    | 13          | 44   | 44   | 47         | 19   | 10   | 8          | 18   | 13   |

Note: Queue reported is the number of cars per lane.

BART

Level Of Service Computation Report  
 2000 HCM Operations (Future Volume Alternative)  
 AM - Cumulative No Project

Intersection #3625: KING/McKEE [Study Int 7]

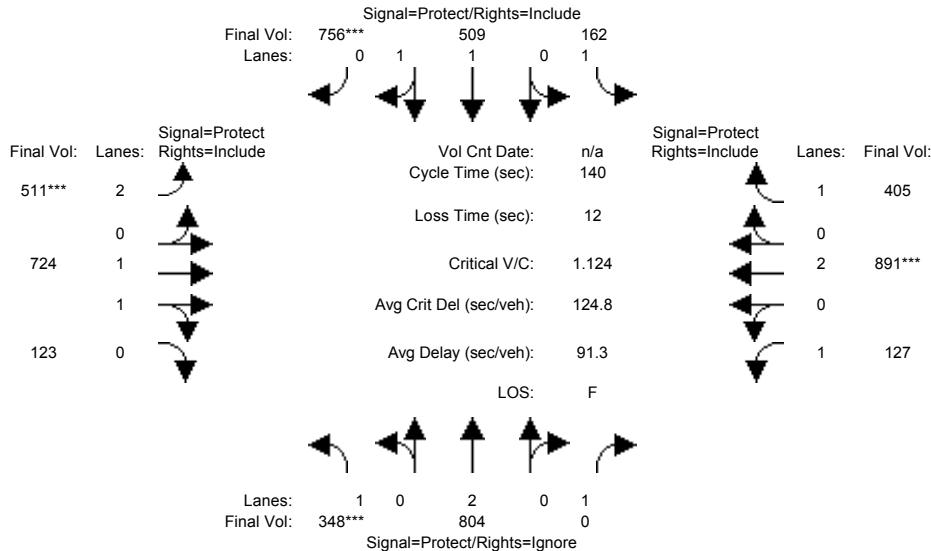

| Approach:                 | North Bound |      |      | South Bound |      |       | East Bound |      |      | West Bound |      |       |
|---------------------------|-------------|------|------|-------------|------|-------|------------|------|------|------------|------|-------|
| Movement:                 | L           | T    | R    | L           | T    | R     | L          | T    | R    | L          | T    | R     |
| Min. Green:               | 7           | 10   | 10   | 7           | 10   | 10    | 7          | 10   | 10   | 7          | 10   | 10    |
| Y+R:                      | 4.0         | 4.0  | 4.0  | 4.0         | 4.0  | 4.0   | 4.0        | 4.0  | 4.0  | 4.0        | 4.0  | 4.0   |
| Volume Module:            |             |      |      |             |      |       |            |      |      |            |      |       |
| Base Vol:                 | 348         | 804  | 172  | 162         | 509  | 756   | 511        | 724  | 123  | 127        | 891  | 405   |
| Growth Adj:               | 1.00        | 1.00 | 1.00 | 1.00        | 1.00 | 1.00  | 1.00       | 1.00 | 1.00 | 1.00       | 1.00 | 1.00  |
| Initial Bse:              | 348         | 804  | 172  | 162         | 509  | 756   | 511        | 724  | 123  | 127        | 891  | 405   |
| Added Vol:                | 0           | 0    | 0    | 0           | 0    | 0     | 0          | 0    | 0    | 0          | 0    | 0     |
| PasserByVol:              | 0           | 0    | 0    | 0           | 0    | 0     | 0          | 0    | 0    | 0          | 0    | 0     |
| Initial Fut:              | 348         | 804  | 172  | 162         | 509  | 756   | 511        | 724  | 123  | 127        | 891  | 405   |
| User Adj:                 | 1.00        | 1.00 | 0.00 | 1.00        | 1.00 | 1.00  | 1.00       | 1.00 | 1.00 | 1.00       | 1.00 | 1.00  |
| PHF Adj:                  | 1.00        | 1.00 | 0.00 | 1.00        | 1.00 | 1.00  | 1.00       | 1.00 | 1.00 | 1.00       | 1.00 | 1.00  |
| PHF Volume:               | 348         | 804  | 0    | 162         | 509  | 756   | 511        | 724  | 123  | 127        | 891  | 405   |
| Reduct Vol:               | 0           | 0    | 0    | 0           | 0    | 0     | 0          | 0    | 0    | 0          | 0    | 0     |
| Reduced Vol:              | 348         | 804  | 0    | 162         | 509  | 756   | 511        | 724  | 123  | 127        | 891  | 405   |
| PCE Adj:                  | 1.00        | 1.00 | 0.00 | 1.00        | 1.00 | 1.00  | 1.00       | 1.00 | 1.00 | 1.00       | 1.00 | 1.00  |
| MLF Adj:                  | 1.00        | 1.00 | 0.00 | 1.00        | 1.00 | 1.00  | 1.00       | 1.00 | 1.00 | 1.00       | 1.00 | 1.00  |
| Final Volume:             | 348         | 804  | 0    | 162         | 509  | 756   | 511        | 724  | 123  | 127        | 891  | 405   |
| Saturation Flow Module:   |             |      |      |             |      |       |            |      |      |            |      |       |
| Sat/Lane:                 | 1900        | 1900 | 1900 | 1900        | 1900 | 1900  | 1900       | 1900 | 1900 | 1900       | 1900 | 1900  |
| Adjustment:               | 0.92        | 1.00 | 0.92 | 0.92        | 1.00 | 0.92  | 0.83       | 0.98 | 0.95 | 0.92       | 1.00 | 0.92  |
| Lanes:                    | 1.00        | 2.00 | 1.00 | 1.00        | 1.00 | 1.00  | 2.00       | 1.70 | 0.30 | 1.00       | 2.00 | 1.00  |
| Final Sat.:               | 1750        | 3800 | 1750 | 1750        | 1900 | 1750  | 3150       | 3162 | 537  | 1750       | 3800 | 1750  |
| Capacity Analysis Module: |             |      |      |             |      |       |            |      |      |            |      |       |
| Vol/Sat:                  | 0.20        | 0.21 | 0.00 | 0.09        | 0.27 | 0.43  | 0.16       | 0.23 | 0.23 | 0.07       | 0.23 | 0.23  |
| Crit Moves:               | ****        |      |      | ****        | **** | ****  | ****       | **** | **** | ****       | **** | ****  |
| Green Time:               | 24.8        | 54.7 | 0.0  | 23.9        | 53.8 | 53.8  | 20.2       | 37.5 | 37.5 | 11.9       | 29.2 | 29.2  |
| Volume/Cap:               | 1.12        | 0.54 | 0.00 | 0.54        | 0.70 | 1.12  | 1.12       | 0.85 | 0.85 | 0.85       | 1.12 | 1.11  |
| Delay/Veh:                | 146.5       | 33.4 | 0.0  | 55.1        | 37.4 | 110.8 | 140.5      | 56.0 | 56.0 | 98.6       | 127  | 135.4 |
| User DelAdj:              | 1.00        | 1.00 | 1.00 | 1.00        | 1.00 | 1.00  | 1.00       | 1.00 | 1.00 | 1.00       | 1.00 | 1.00  |
| AdjDel/Veh:               | 146.5       | 33.4 | 0.0  | 55.1        | 37.4 | 110.8 | 140.5      | 56.0 | 56.0 | 98.6       | 127  | 135.4 |
| LOS by Move:              | F           | C    | A    | E           | D    | F     | F          | E    | E    | F          | F    | F     |
| HCM2k95thQ:               | 38          | 23   | 0    | 13          | 31   | 74    | 31         | 31   | 31   | 13         | 44   | 42    |

Note: Queue reported is the number of cars per lane.



BART

Level Of Service Computation Report  
 2000 HCM Operations (Future Volume Alternative)  
 PM - Cumulative No Project

Intersection #3625: KING/McKEE [Study Int 7]

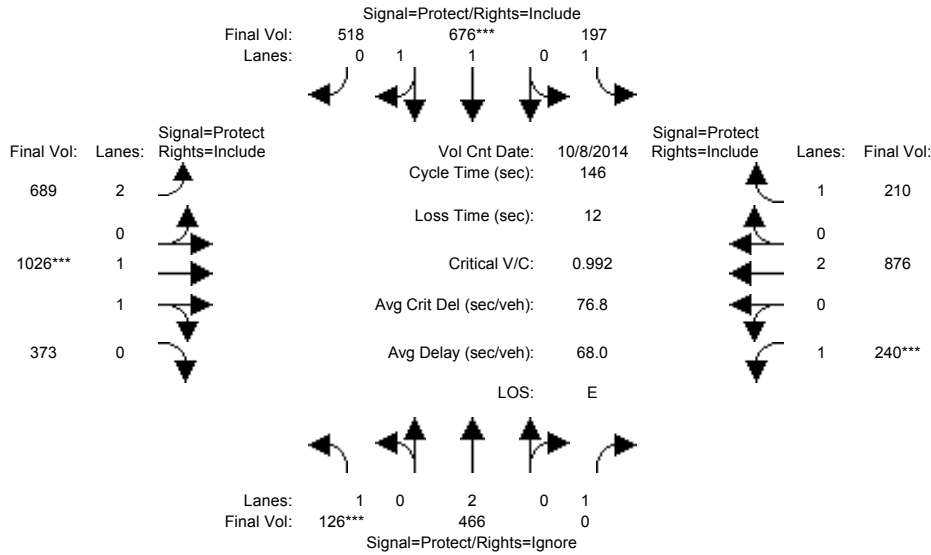

| Approach:                                   | North Bound |      |      | South Bound |      |      | East Bound |      |      | West Bound |      |      |
|---|-------------|------|------|-------------|------|------|------------|------|------|------------|------|------|
| Movement:                                   | L           | T    | R    | L           | T    | R    | L          | T    | R    | L          | T    | R    |
| Min. Green:                                 | 7           | 10   | 10   | 7           | 10   | 10   | 7          | 10   | 10   | 7          | 10   | 10   |
| Y+R:  | 4.0         | 4.0  | 4.0  | 4.0         | 4.0  | 4.0  | 4.0        | 4.0  | 4.0  | 4.0        | 4.0  | 4.0  |
| Volume Module: >> Count Date: 8 Oct 2014 << |             |      |      |             |      |      |            |      |      |            |      |      |
| Base Vol:                                   | 126         | 466  | 301  | 197         | 676  | 518  | 689        | 1026 | 373  | 240        | 876  | 210  |
| Growth Adj:                                 | 1.00        | 1.00 | 1.00 | 1.00        | 1.00 | 1.00 | 1.00       | 1.00 | 1.00 | 1.00       | 1.00 | 1.00 |
| Initial Bse:                                | 126         | 466  | 301  | 197         | 676  | 518  | 689        | 1026 | 373  | 240        | 876  | 210  |
| Added Vol:                                  | 0           | 0    | 0    | 0           | 0    | 0    | 0          | 0    | 0    | 0          | 0    | 0    |
| PasserByVol:                                | 0           | 0    | 0    | 0           | 0    | 0    | 0          | 0    | 0    | 0          | 0    | 0    |
| Initial Fut:                                | 126         | 466  | 301  | 197         | 676  | 518  | 689        | 1026 | 373  | 240        | 876  | 210  |
| User Adj:                                   | 1.00        | 1.00 | 0.00 | 1.00        | 1.00 | 1.00 | 1.00       | 1.00 | 1.00 | 1.00       | 1.00 | 1.00 |
| PHF Adj:                                    | 1.00        | 1.00 | 0.00 | 1.00        | 1.00 | 1.00 | 1.00       | 1.00 | 1.00 | 1.00       | 1.00 | 1.00 |
| PHF Volume:                                 | 126         | 466  | 0    | 197         | 676  | 518  | 689        | 1026 | 373  | 240        | 876  | 210  |
| Reduct Vol:                                 | 0           | 0    | 0    | 0           | 0    | 0    | 0          | 0    | 0    | 0          | 0    | 0    |
| Reduced Vol:                                | 126         | 466  | 0    | 197         | 676  | 518  | 689        | 1026 | 373  | 240        | 876  | 210  |
| PCE Adj:                                    | 1.00        | 1.00 | 0.00 | 1.00        | 1.00 | 1.00 | 1.00       | 1.00 | 1.00 | 1.00       | 1.00 | 1.00 |
| MLF Adj:                                    | 1.00        | 1.00 | 0.00 | 1.00        | 1.00 | 1.00 | 1.00       | 1.00 | 1.00 | 1.00       | 1.00 | 1.00 |
| Final Volume:                               | 126         | 466  | 0    | 197         | 676  | 518  | 689        | 1026 | 373  | 240        | 876  | 210  |
| Saturation Flow Module:                     |             |      |      |             |      |      |            |      |      |            |      |      |
| Sat/Lane:                                   | 1900        | 1900 | 1900 | 1900        | 1900 | 1900 | 1900       | 1900 | 1900 | 1900       | 1900 | 1900 |
| Adjustment:                                 | 0.92        | 1.00 | 0.92 | 0.92        | 0.99 | 0.95 | 0.83       | 0.98 | 0.95 | 0.92       | 1.00 | 0.92 |
| Lanes:                                      | 1.00        | 2.00 | 1.00 | 1.00        | 1.11 | 0.89 | 2.00       | 1.45 | 0.55 | 1.00       | 2.00 | 1.00 |
| Final Sat.:                                 | 1750        | 3800 | 1750 | 1750        | 2094 | 1604 | 3150       | 2713 | 986  | 1750       | 3800 | 1750 |
| Capacity Analysis Module:                   |             |      |      |             |      |      |            |      |      |            |      |      |
| Vol/Sat:                                    | 0.07        | 0.12 | 0.00 | 0.11        | 0.32 | 0.32 | 0.22       | 0.38 | 0.38 | 0.14       | 0.23 | 0.12 |
| Crit Moves:                                 | ****        |      |      | ****        |      |      | ****       |      |      | ****       |      |      |
| Green Time:                                 | 10.6        | 30.3 | 0.0  | 27.8        | 47.5 | 47.5 | 36.9       | 55.7 | 55.7 | 20.2       | 38.9 | 38.9 |
| Volume/Cap:                                 | 0.99        | 0.59 | 0.00 | 0.59        | 0.99 | 0.99 | 0.86       | 0.99 | 0.99 | 0.99       | 0.99 | 0.86 |
| Delay/Veh:                                  | 144.8       | 53.4 | 0.0  | 56.7        | 72.9 | 72.9 | 61.9       | 66.9 | 66.9 | 118.2      | 58.9 | 45.3 |
| User DelAdj:                                | 1.00        | 1.00 | 1.00 | 1.00        | 1.00 | 1.00 | 1.00       | 1.00 | 1.00 | 1.00       | 1.00 | 1.00 |
| AdjDel/Veh:                                 | 144.8       | 53.4 | 0.0  | 56.7        | 72.9 | 72.9 | 61.9       | 66.9 | 66.9 | 118.2      | 58.9 | 45.3 |
| LOS by Move:                                | F           | D    | A    | E           | E    | E    | E          | E    | E    | F          | E    | D    |
| HCM2k95thQ:                                 | 15          | 17   | 0    | 16          | 51   | 51   | 30         | 53   | 53   | 25         | 34   | 15   |

Note: Queue reported is the number of cars per lane.

BART

Level Of Service Computation Report  
2000 HCM Operations (Future Volume Alternative)  
AM - Cumulative With Project

Intersection #3625: KING/McKEE [Study Int 7]

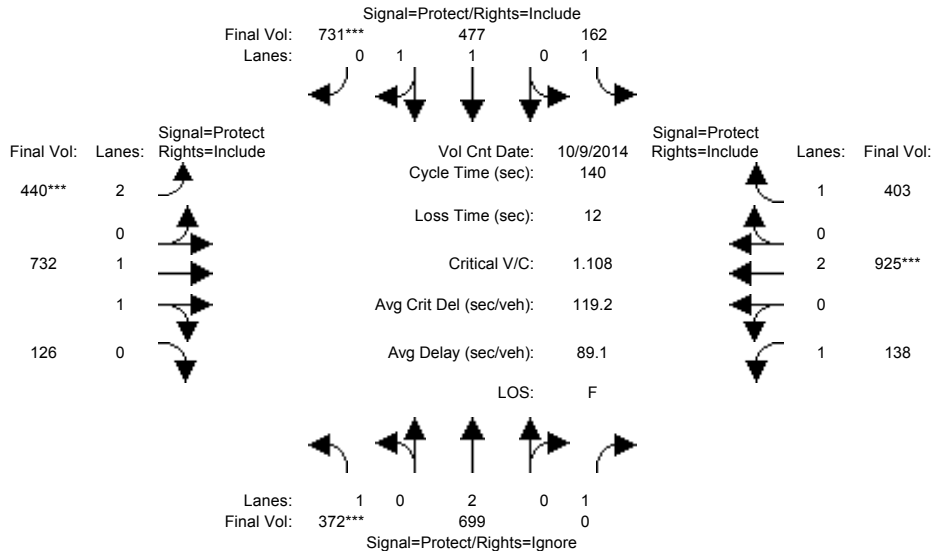

| Approach:                                   | North Bound |      |      | South Bound |      |       | East Bound |      |      | West Bound |      |       |
|---|-------------|------|------|-------------|------|-------|------------|------|------|------------|------|-------|
| Movement:                                   | L           | T    | R    | L           | T    | R     | L          | T    | R    | L          | T    | R     |
| Min. Green:                                 | 7           | 10   | 10   | 7           | 10   | 10    | 7          | 10   | 10   | 7          | 10   | 10    |
| Y+R:  | 4.0         | 4.0  | 4.0  | 4.0         | 4.0  | 4.0   | 4.0        | 4.0  | 4.0  | 4.0        | 4.0  | 4.0   |
| Volume Module: >> Count Date: 9 Oct 2014 << |             |      |      |             |      |       |            |      |      |            |      |       |
| Base Vol:                                   | 372         | 699  | 172  | 162         | 477  | 731   | 440        | 732  | 126  | 138        | 925  | 403   |
| Growth Adj:                                 | 1.00        | 1.00 | 1.00 | 1.00        | 1.00 | 1.00  | 1.00       | 1.00 | 1.00 | 1.00       | 1.00 | 1.00  |
| Initial Bse:                                | 372         | 699  | 172  | 162         | 477  | 731   | 440        | 732  | 126  | 138        | 925  | 403   |
| Added Vol:                                  | 0           | 0    | 0    | 0           | 0    | 0     | 0          | 0    | 0    | 0          | 0    | 0     |
| PasserByVol:                                | 0           | 0    | 0    | 0           | 0    | 0     | 0          | 0    | 0    | 0          | 0    | 0     |
| Initial Fut:                                | 372         | 699  | 172  | 162         | 477  | 731   | 440        | 732  | 126  | 138        | 925  | 403   |
| User Adj:                                   | 1.00        | 1.00 | 0.00 | 1.00        | 1.00 | 1.00  | 1.00       | 1.00 | 1.00 | 1.00       | 1.00 | 1.00  |
| PHF Adj:                                    | 1.00        | 1.00 | 0.00 | 1.00        | 1.00 | 1.00  | 1.00       | 1.00 | 1.00 | 1.00       | 1.00 | 1.00  |
| PHF Volume:                                 | 372         | 699  | 0    | 162         | 477  | 731   | 440        | 732  | 126  | 138        | 925  | 403   |
| Reduct Vol:                                 | 0           | 0    | 0    | 0           | 0    | 0     | 0          | 0    | 0    | 0          | 0    | 0     |
| Reduced Vol:                                | 372         | 699  | 0    | 162         | 477  | 731   | 440        | 732  | 126  | 138        | 925  | 403   |
| PCE Adj:                                    | 1.00        | 1.00 | 0.00 | 1.00        | 1.00 | 1.00  | 1.00       | 1.00 | 1.00 | 1.00       | 1.00 | 1.00  |
| MLF Adj:                                    | 1.00        | 1.00 | 0.00 | 1.00        | 1.00 | 1.00  | 1.00       | 1.00 | 1.00 | 1.00       | 1.00 | 1.00  |
| Final Volume:                               | 372         | 699  | 0    | 162         | 477  | 731   | 440        | 732  | 126  | 138        | 925  | 403   |
| Saturation Flow Module:                     |             |      |      |             |      |       |            |      |      |            |      |       |
| Sat/Lane:                                   | 1900        | 1900 | 1900 | 1900        | 1900 | 1900  | 1900       | 1900 | 1900 | 1900       | 1900 | 1900  |
| Adjustment:                                 | 0.92        | 1.00 | 0.92 | 0.92        | 1.00 | 0.92  | 0.83       | 0.98 | 0.95 | 0.92       | 1.00 | 0.92  |
| Lanes:                                      | 1.00        | 2.00 | 1.00 | 1.00        | 1.00 | 1.00  | 2.00       | 1.70 | 0.30 | 1.00       | 2.00 | 1.00  |
| Final Sat.:                                 | 1750        | 3800 | 1750 | 1750        | 1900 | 1750  | 3150       | 3156 | 543  | 1750       | 3800 | 1750  |
| Capacity Analysis Module:                   |             |      |      |             |      |       |            |      |      |            |      |       |
| Vol/Sat:                                    | 0.21        | 0.18 | 0.00 | 0.09        | 0.25 | 0.42  | 0.14       | 0.23 | 0.23 | 0.08       | 0.24 | 0.23  |
| Crit Moves:                                 | ****        |      |      | ****        | **** | ****  | ****       | **** | **** | ****       | **** | ****  |
| Green Time:                                 | 26.8        | 53.0 | 0.0  | 26.7        | 52.8 | 52.8  | 17.6       | 36.1 | 36.1 | 12.3       | 30.7 | 30.7  |
| Volume/Cap:                                 | 1.11        | 0.49 | 0.00 | 0.49        | 0.67 | 1.11  | 1.11       | 0.90 | 0.90 | 0.90       | 1.11 | 1.05  |
| Delay/Veh:                                  | 138.1       | 33.4 | 0.0  | 51.7        | 37.2 | 105.7 | 139.0      | 61.5 | 61.5 | 107.6      | 120  | 113.8 |
| User DelAdj:                                | 1.00        | 1.00 | 1.00 | 1.00        | 1.00 | 1.00  | 1.00       | 1.00 | 1.00 | 1.00       | 1.00 | 1.00  |
| AdjDel/Veh:                                 | 138.1       | 33.4 | 0.0  | 51.7        | 37.2 | 105.7 | 139.0      | 61.5 | 61.5 | 107.6      | 120  | 113.8 |
| LOS by Move:                                | F           | C    | A    | D           | D    | F     | F          | E    | E    | F          | F    | F     |
| HCM2k95thQ:                                 | 39          | 20   | 0    | 13          | 29   | 70    | 27         | 33   | 33   | 14         | 44   | 40    |

Note: Queue reported is the number of cars per lane.

BART

Level Of Service Computation Report  
 2000 HCM Operations (Future Volume Alternative)  
 PM - Cumulative With Project

Intersection #3625: KING/McKEE [Study Int 7]

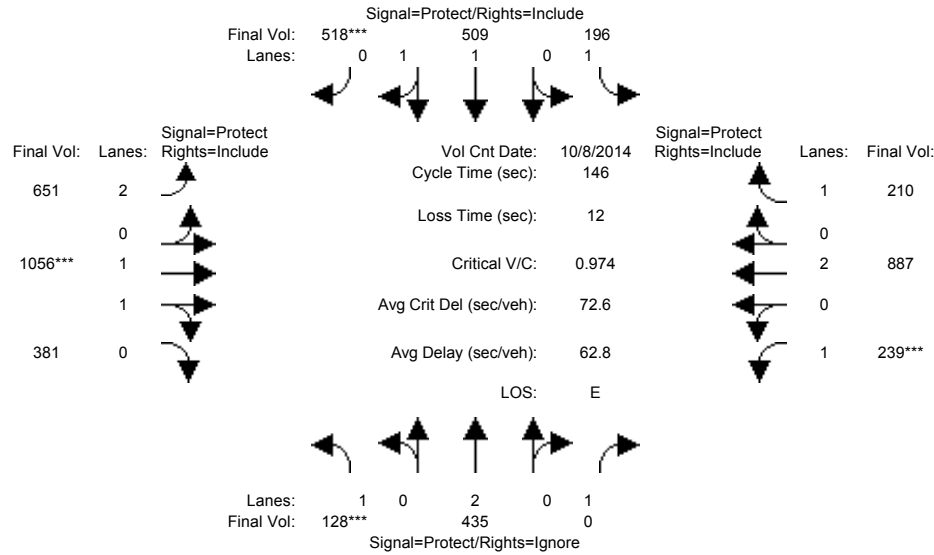

| Approach:                                   | North Bound |      |      | South Bound |      |      | East Bound |      |      | West Bound |      |      |
|---|-------------|------|------|-------------|------|------|------------|------|------|------------|------|------|
| Movement:                                   | L           | T    | R    | L           | T    | R    | L          | T    | R    | L          | T    | R    |
| Min. Green:                                 | 7           | 10   | 10   | 7           | 10   | 10   | 7          | 10   | 10   | 7          | 10   | 10   |
| Y+R:  | 4.0         | 4.0  | 4.0  | 4.0         | 4.0  | 4.0  | 4.0        | 4.0  | 4.0  | 4.0        | 4.0  | 4.0  |
| Volume Module: >> Count Date: 8 Oct 2014 << |             |      |      |             |      |      |            |      |      |            |      |      |
| Base Vol:                                   | 128         | 435  | 308  | 196         | 509  | 518  | 651        | 1056 | 381  | 239        | 887  | 210  |
| Growth Adj:                                 | 1.00        | 1.00 | 1.00 | 1.00        | 1.00 | 1.00 | 1.00       | 1.00 | 1.00 | 1.00       | 1.00 | 1.00 |
| Initial Bse:                                | 128         | 435  | 308  | 196         | 509  | 518  | 651        | 1056 | 381  | 239        | 887  | 210  |
| Added Vol:                                  | 0           | 0    | 0    | 0           | 0    | 0    | 0          | 0    | 0    | 0          | 0    | 0    |
| PasserByVol:                                | 0           | 0    | 0    | 0           | 0    | 0    | 0          | 0    | 0    | 0          | 0    | 0    |
| Initial Fut:                                | 128         | 435  | 308  | 196         | 509  | 518  | 651        | 1056 | 381  | 239        | 887  | 210  |
| User Adj:                                   | 1.00        | 1.00 | 0.00 | 1.00        | 1.00 | 1.00 | 1.00       | 1.00 | 1.00 | 1.00       | 1.00 | 1.00 |
| PHF Adj:                                    | 1.00        | 1.00 | 0.00 | 1.00        | 1.00 | 1.00 | 1.00       | 1.00 | 1.00 | 1.00       | 1.00 | 1.00 |
| PHF Volume:                                 | 128         | 435  | 0    | 196         | 509  | 518  | 651        | 1056 | 381  | 239        | 887  | 210  |
| Reduct Vol:                                 | 0           | 0    | 0    | 0           | 0    | 0    | 0          | 0    | 0    | 0          | 0    | 0    |
| Reduced Vol:                                | 128         | 435  | 0    | 196         | 509  | 518  | 651        | 1056 | 381  | 239        | 887  | 210  |
| PCE Adj:                                    | 1.00        | 1.00 | 0.00 | 1.00        | 1.00 | 1.00 | 1.00       | 1.00 | 1.00 | 1.00       | 1.00 | 1.00 |
| MLF Adj:                                    | 1.00        | 1.00 | 0.00 | 1.00        | 1.00 | 1.00 | 1.00       | 1.00 | 1.00 | 1.00       | 1.00 | 1.00 |
| Final Volume:                               | 128         | 435  | 0    | 196         | 509  | 518  | 651        | 1056 | 381  | 239        | 887  | 210  |
| Saturation Flow Module:                     |             |      |      |             |      |      |            |      |      |            |      |      |
| Sat/Lane:                                   | 1900        | 1900 | 1900 | 1900        | 1900 | 1900 | 1900       | 1900 | 1900 | 1900       | 1900 | 1900 |
| Adjustment:                                 | 0.92        | 1.00 | 0.92 | 0.92        | 1.00 | 0.92 | 0.83       | 0.98 | 0.95 | 0.92       | 1.00 | 0.92 |
| Lanes:                                      | 1.00        | 2.00 | 1.00 | 1.00        | 1.00 | 1.00 | 2.00       | 1.46 | 0.54 | 1.00       | 2.00 | 1.00 |
| Final Sat.:                                 | 1750        | 3800 | 1750 | 1750        | 1900 | 1750 | 3150       | 2718 | 981  | 1750       | 3800 | 1750 |
| Capacity Analysis Module:                   |             |      |      |             |      |      |            |      |      |            |      |      |
| Vol/Sat:                                    | 0.07        | 0.11 | 0.00 | 0.11        | 0.27 | 0.30 | 0.21       | 0.39 | 0.39 | 0.14       | 0.23 | 0.12 |
| Crit Moves:                                 | ****        |      |      | ****        |      | **** | ****       |      | **** | ****       |      | **** |
| Green Time:                                 | 11.0        | 28.0 | 0.0  | 27.4        | 44.4 | 44.4 | 36.9       | 58.2 | 58.2 | 20.5       | 41.7 | 41.7 |
| Volume/Cap:                                 | 0.97        | 0.60 | 0.00 | 0.60        | 0.88 | 0.97 | 0.82       | 0.97 | 0.97 | 0.97       | 0.82 | 0.42 |
| Delay/Veh:                                  | 137.7       | 55.3 | 0.0  | 57.3        | 56.4 | 71.9 | 57.9       | 60.7 | 60.7 | 112.6      | 53.5 | 42.9 |
| User DelAdj:                                | 1.00        | 1.00 | 1.00 | 1.00        | 1.00 | 1.00 | 1.00       | 1.00 | 1.00 | 1.00       | 1.00 | 1.00 |
| AdjDel/Veh:                                 | 137.7       | 55.3 | 0.0  | 57.3        | 56.4 | 71.9 | 57.9       | 60.7 | 60.7 | 112.6      | 53.5 | 42.9 |
| LOS by Move:                                | F           | E    | A    | E           | E    | E    | E          | E    | E    | F          | D    | D    |
| HCM2k95thQ:                                 | 14          | 16   | 0    | 16          | 39   | 46   | 28         | 53   | 53   | 24         | 33   | 15   |

Note: Queue reported is the number of cars per lane.

BART

Level Of Service Computation Report  
 2000 HCM Operations (Future Volume Alternative)  
 AM - Cumulative No Project

Intersection #3627: KING/SAN ANTONIO [Study Int 22]

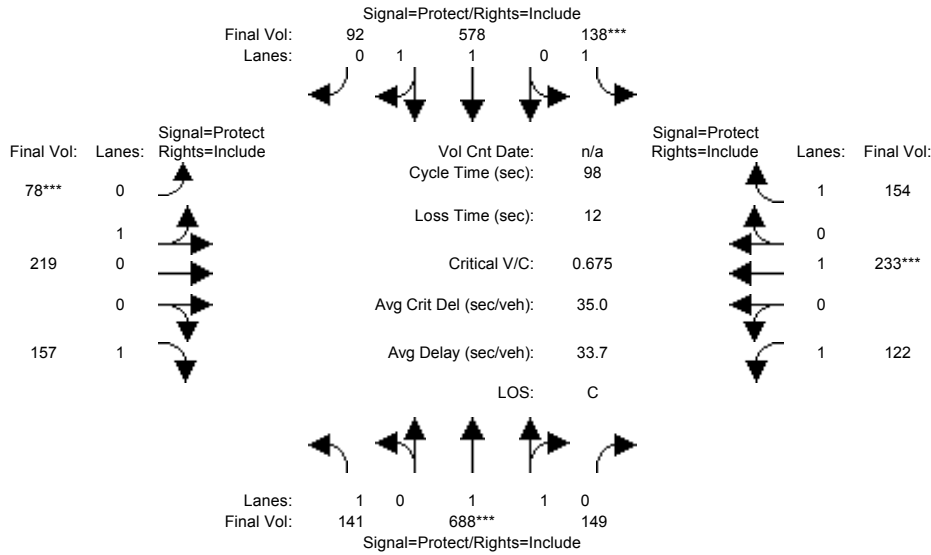

| Approach:                 | North Bound |      |      | South Bound |      |      | East Bound |      |      | West Bound |      |      |
|---------------------------|-------------|------|------|-------------|------|------|------------|------|------|------------|------|------|
| Movement:                 | L           | T    | R    | L           | T    | R    | L          | T    | R    | L          | T    | R    |
| Min. Green:               | 7           | 10   | 10   | 7           | 10   | 10   | 10         | 10   | 10   | 10         | 10   | 10   |
| Y+R:                      | 4.0         | 4.0  | 4.0  | 4.0         | 4.0  | 4.0  | 4.0        | 4.0  | 4.0  | 4.0        | 4.0  | 4.0  |
| Volume Module:            |             |      |      |             |      |      |            |      |      |            |      |      |
| Base Vol:                 | 141         | 688  | 149  | 138         | 578  | 92   | 78         | 219  | 157  | 122        | 233  | 154  |
| Growth Adj:               | 1.00        | 1.00 | 1.00 | 1.00        | 1.00 | 1.00 | 1.00       | 1.00 | 1.00 | 1.00       | 1.00 | 1.00 |
| Initial Bse:              | 141         | 688  | 149  | 138         | 578  | 92   | 78         | 219  | 157  | 122        | 233  | 154  |
| Added Vol:                | 0           | 0    | 0    | 0           | 0    | 0    | 0          | 0    | 0    | 0          | 0    | 0    |
| PasserByVol:              | 0           | 0    | 0    | 0           | 0    | 0    | 0          | 0    | 0    | 0          | 0    | 0    |
| Initial Fut:              | 141         | 688  | 149  | 138         | 578  | 92   | 78         | 219  | 157  | 122        | 233  | 154  |
| User Adj:                 | 1.00        | 1.00 | 1.00 | 1.00        | 1.00 | 1.00 | 1.00       | 1.00 | 1.00 | 1.00       | 1.00 | 1.00 |
| PHF Adj:                  | 1.00        | 1.00 | 1.00 | 1.00        | 1.00 | 1.00 | 1.00       | 1.00 | 1.00 | 1.00       | 1.00 | 1.00 |
| PHF Volume:               | 141         | 688  | 149  | 138         | 578  | 92   | 78         | 219  | 157  | 122        | 233  | 154  |
| Reduct Vol:               | 0           | 0    | 0    | 0           | 0    | 0    | 0          | 0    | 0    | 0          | 0    | 0    |
| Reduced Vol:              | 141         | 688  | 149  | 138         | 578  | 92   | 78         | 219  | 157  | 122        | 233  | 154  |
| PCE Adj:                  | 1.00        | 1.00 | 1.00 | 1.00        | 1.00 | 1.00 | 1.00       | 1.00 | 1.00 | 1.00       | 1.00 | 1.00 |
| MLF Adj:                  | 1.00        | 1.00 | 1.00 | 1.00        | 1.00 | 1.00 | 1.00       | 1.00 | 1.00 | 1.00       | 1.00 | 1.00 |
| Final Volume:             | 141         | 688  | 149  | 138         | 578  | 92   | 78         | 219  | 157  | 122        | 233  | 154  |
| Saturation Flow Module:   |             |      |      |             |      |      |            |      |      |            |      |      |
| Sat/Lane:                 | 1900        | 1900 | 1900 | 1900        | 1900 | 1900 | 1900       | 1900 | 1900 | 1900       | 1900 | 1900 |
| Adjustment:               | 0.92        | 0.98 | 0.95 | 0.92        | 0.98 | 0.95 | 0.95       | 0.95 | 0.92 | 0.92       | 1.00 | 0.92 |
| Lanes:                    | 1.00        | 1.63 | 0.37 | 1.00        | 1.72 | 0.28 | 0.26       | 0.74 | 1.00 | 1.00       | 1.00 | 1.00 |
| Final Sat.:               | 1750        | 3041 | 659  | 1750        | 3192 | 508  | 473        | 1327 | 1750 | 1750       | 1900 | 1750 |
| Capacity Analysis Module: |             |      |      |             |      |      |            |      |      |            |      |      |
| Vol/Sat:                  | 0.08        | 0.23 | 0.23 | 0.08        | 0.18 | 0.18 | 0.17       | 0.17 | 0.09 | 0.07       | 0.12 | 0.09 |
| Crit Moves:               | ****        | **** | **** | ****        | **** | **** | ****       | **** | **** | ****       | **** | **** |
| Green Time:               | 13.6        | 32.8 | 32.8 | 11.4        | 30.6 | 30.6 | 23.9       | 25.8 | 25.8 | 15.9       | 17.8 | 17.8 |
| Volume/Cap:               | 0.58        | 0.68 | 0.68 | 0.68        | 0.58 | 0.58 | 0.68       | 0.63 | 0.34 | 0.43       | 0.68 | 0.48 |
| Delay/Veh:                | 43.0        | 29.5 | 29.5 | 50.2        | 29.0 | 29.0 | 37.7       | 34.5 | 29.7 | 38.0       | 42.7 | 37.2 |
| User DelAdj:              | 1.00        | 1.00 | 1.00 | 1.00        | 1.00 | 1.00 | 1.00       | 1.00 | 1.00 | 1.00       | 1.00 | 1.00 |
| AdjDel/Veh:               | 43.0        | 29.5 | 29.5 | 50.2        | 29.0 | 29.0 | 37.7       | 34.5 | 29.7 | 38.0       | 42.7 | 37.2 |
| LOS by Move:              | D           | C    | C    | D           | C    | C    | D          | C    | C    | D          | D    | D    |
| HCM2k95thQ:               | 9           | 20   | 20   | 9           | 16   | 16   | 18         | 17   | 8    | 8          | 15   | 10   |

Note: Queue reported is the number of cars per lane.

BART

Level Of Service Computation Report  
2000 HCM Operations (Future Volume Alternative)  
PM - Cumulative No Project

Intersection #3627: KING/SAN ANTONIO [Study Int 22]

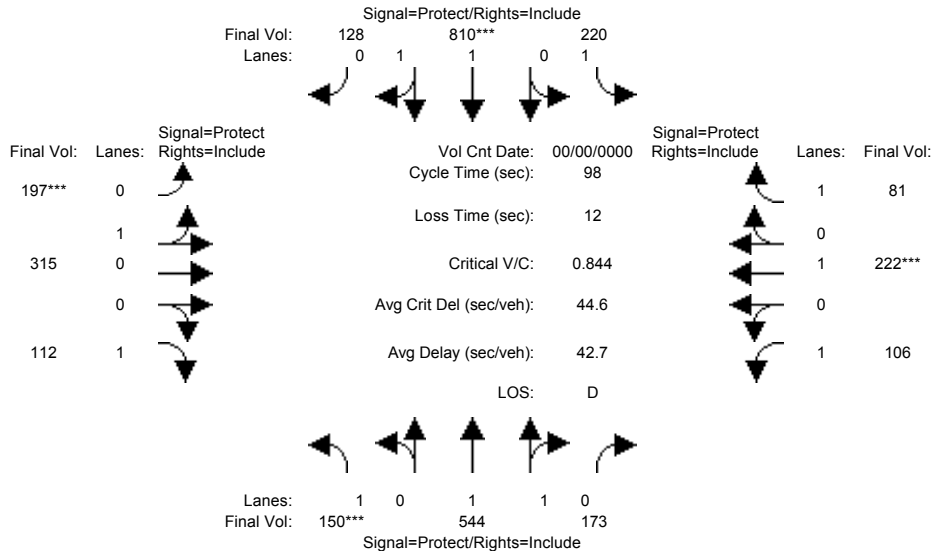

| Approach:                            | North Bound |      |      | South Bound |      |      | East Bound |      |      | West Bound |      |      |
|--------------------------------------|-------------|------|------|-------------|------|------|------------|------|------|------------|------|------|
| Movement:                            | L           | T    | R    | L           | T    | R    | L          | T    | R    | L          | T    | R    |
| Min. Green:                          | 7           | 10   | 10   | 7           | 10   | 10   | 10         | 10   | 10   | 10         | 10   | 10   |
| Y+R:                                 | 4.0         | 4.0  | 4.0  | 4.0         | 4.0  | 4.0  | 4.0        | 4.0  | 4.0  | 4.0        | 4.0  | 4.0  |
| Volume Module: >> Count Date: 0 0 << |             |      |      |             |      |      |            |      |      |            |      |      |
| Base Vol:                            | 150         | 544  | 173  | 220         | 810  | 128  | 197        | 315  | 112  | 106        | 222  | 81   |
| Growth Adj:                          | 1.00        | 1.00 | 1.00 | 1.00        | 1.00 | 1.00 | 1.00       | 1.00 | 1.00 | 1.00       | 1.00 | 1.00 |
| Initial Bse:                         | 150         | 544  | 173  | 220         | 810  | 128  | 197        | 315  | 112  | 106        | 222  | 81   |
| Added Vol:                           | 0           | 0    | 0    | 0           | 0    | 0    | 0          | 0    | 0    | 0          | 0    | 0    |
| PasserByVol:                         | 0           | 0    | 0    | 0           | 0    | 0    | 0          | 0    | 0    | 0          | 0    | 0    |
| Initial Fut:                         | 150         | 544  | 173  | 220         | 810  | 128  | 197        | 315  | 112  | 106        | 222  | 81   |
| User Adj:                            | 1.00        | 1.00 | 1.00 | 1.00        | 1.00 | 1.00 | 1.00       | 1.00 | 1.00 | 1.00       | 1.00 | 1.00 |
| PHF Adj:                             | 1.00        | 1.00 | 1.00 | 1.00        | 1.00 | 1.00 | 1.00       | 1.00 | 1.00 | 1.00       | 1.00 | 1.00 |
| PHF Volume:                          | 150         | 544  | 173  | 220         | 810  | 128  | 197        | 315  | 112  | 106        | 222  | 81   |
| Reduct Vol:                          | 0           | 0    | 0    | 0           | 0    | 0    | 0          | 0    | 0    | 0          | 0    | 0    |
| Reduced Vol:                         | 150         | 544  | 173  | 220         | 810  | 128  | 197        | 315  | 112  | 106        | 222  | 81   |
| PCE Adj:                             | 1.00        | 1.00 | 1.00 | 1.00        | 1.00 | 1.00 | 1.00       | 1.00 | 1.00 | 1.00       | 1.00 | 1.00 |
| MLF Adj:                             | 1.00        | 1.00 | 1.00 | 1.00        | 1.00 | 1.00 | 1.00       | 1.00 | 1.00 | 1.00       | 1.00 | 1.00 |
| Final Volume:                        | 150         | 544  | 173  | 220         | 810  | 128  | 197        | 315  | 112  | 106        | 222  | 81   |
| Saturation Flow Module:              |             |      |      |             |      |      |            |      |      |            |      |      |
| Sat/Lane:                            | 1900        | 1900 | 1900 | 1900        | 1900 | 1900 | 1900       | 1900 | 1900 | 1900       | 1900 | 1900 |
| Adjustment:                          | 0.92        | 0.98 | 0.95 | 0.92        | 0.98 | 0.95 | 0.95       | 0.95 | 0.92 | 0.92       | 1.00 | 0.92 |
| Lanes:                               | 1.00        | 1.50 | 0.50 | 1.00        | 1.72 | 0.28 | 0.38       | 0.62 | 1.00 | 1.00       | 1.00 | 1.00 |
| Final Sat.:                          | 1750        | 2807 | 893  | 1750        | 3195 | 505  | 693        | 1107 | 1750 | 1750       | 1900 | 1750 |
| Capacity Analysis Module:            |             |      |      |             |      |      |            |      |      |            |      |      |
| Vol/Sat:                             | 0.09        | 0.19 | 0.19 | 0.13        | 0.25 | 0.25 | 0.28       | 0.28 | 0.06 | 0.06       | 0.12 | 0.05 |
| Crit Moves:                          | ****        |      |      | ****        |      |      | ****       |      |      | ****       |      |      |
| Green Time:                          | 10.0        | 23.9 | 23.9 | 15.5        | 29.4 | 29.4 | 33.0       | 34.3 | 34.3 | 12.3       | 13.6 | 13.6 |
| Volume/Cap:                          | 0.84        | 0.79 | 0.79 | 0.79        | 0.84 | 0.84 | 0.84       | 0.81 | 0.18 | 0.48       | 0.84 | 0.33 |
| Delay/Veh:                           | 72.3        | 39.7 | 39.7 | 54.4        | 38.2 | 38.2 | 40.6       | 36.9 | 22.3 | 41.6       | 62.5 | 39.0 |
| User DelAdj:                         | 1.00        | 1.00 | 1.00 | 1.00        | 1.00 | 1.00 | 1.00       | 1.00 | 1.00 | 1.00       | 1.00 | 1.00 |
| AdjDel/Veh:                          | 72.3        | 39.7 | 39.7 | 54.4        | 38.2 | 38.2 | 40.6       | 36.9 | 22.3 | 41.6       | 62.5 | 39.0 |
| LOS by Move:                         | E           | D    | D    | D           | D    | D    | D          | D    | C    | D          | E    | D    |
| HCM2k95thQ:                          | 11          | 20   | 20   | 14          | 26   | 26   | 31         | 29   | 5    | 8          | 17   | 5    |

Note: Queue reported is the number of cars per lane.

BART

Level Of Service Computation Report  
2000 HCM Operations (Future Volume Alternative)  
AM - Cumulative With Project

Intersection #3627: KING/SAN ANTONIO [Study Int 22]

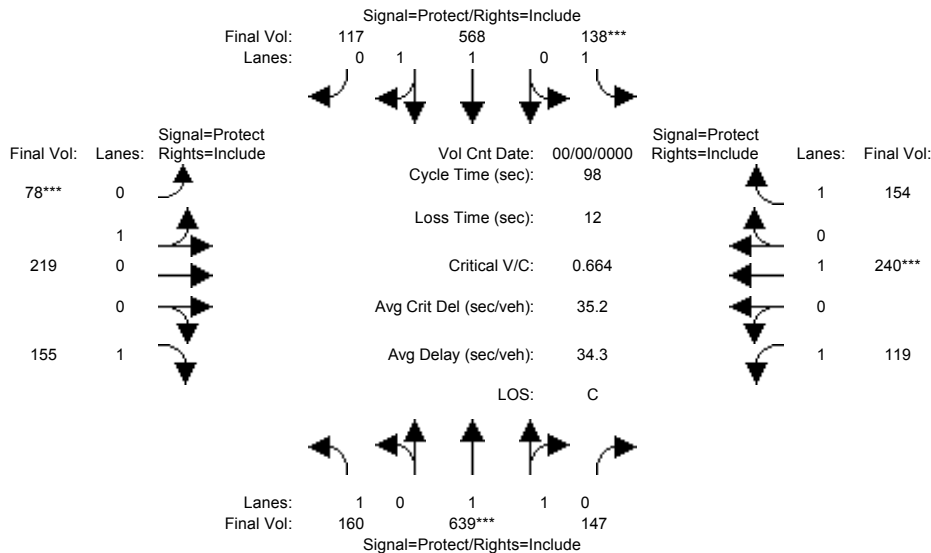

| Approach:                            | North Bound |      |      | South Bound |      |      | East Bound |      |      | West Bound |      |      |
|--------------------------------------|-------------|------|------|-------------|------|------|------------|------|------|------------|------|------|
| Movement:                            | L           | T    | R    | L           | T    | R    | L          | T    | R    | L          | T    | R    |
| Min. Green:                          | 7           | 10   | 10   | 7           | 10   | 10   | 10         | 10   | 10   | 10         | 10   | 10   |
| Y+R:                                 | 4.0         | 4.0  | 4.0  | 4.0         | 4.0  | 4.0  | 4.0        | 4.0  | 4.0  | 4.0        | 4.0  | 4.0  |
| Volume Module: >> Count Date: 0 0 << |             |      |      |             |      |      |            |      |      |            |      |      |
| Base Vol:                            | 160         | 639  | 147  | 138         | 568  | 117  | 78         | 219  | 155  | 119        | 240  | 154  |
| Growth Adj:                          | 1.00        | 1.00 | 1.00 | 1.00        | 1.00 | 1.00 | 1.00       | 1.00 | 1.00 | 1.00       | 1.00 | 1.00 |
| Initial Bse:                         | 160         | 639  | 147  | 138         | 568  | 117  | 78         | 219  | 155  | 119        | 240  | 154  |
| Added Vol:                           | 0           | 0    | 0    | 0           | 0    | 0    | 0          | 0    | 0    | 0          | 0    | 0    |
| PasserByVol:                         | 0           | 0    | 0    | 0           | 0    | 0    | 0          | 0    | 0    | 0          | 0    | 0    |
| Initial Fut:                         | 160         | 639  | 147  | 138         | 568  | 117  | 78         | 219  | 155  | 119        | 240  | 154  |
| User Adj:                            | 1.00        | 1.00 | 1.00 | 1.00        | 1.00 | 1.00 | 1.00       | 1.00 | 1.00 | 1.00       | 1.00 | 1.00 |
| PHF Adj:                             | 1.00        | 1.00 | 1.00 | 1.00        | 1.00 | 1.00 | 1.00       | 1.00 | 1.00 | 1.00       | 1.00 | 1.00 |
| PHF Volume:                          | 160         | 639  | 147  | 138         | 568  | 117  | 78         | 219  | 155  | 119        | 240  | 154  |
| Reduct Vol:                          | 0           | 0    | 0    | 0           | 0    | 0    | 0          | 0    | 0    | 0          | 0    | 0    |
| Reduced Vol:                         | 160         | 639  | 147  | 138         | 568  | 117  | 78         | 219  | 155  | 119        | 240  | 154  |
| PCE Adj:                             | 1.00        | 1.00 | 1.00 | 1.00        | 1.00 | 1.00 | 1.00       | 1.00 | 1.00 | 1.00       | 1.00 | 1.00 |
| MLF Adj:                             | 1.00        | 1.00 | 1.00 | 1.00        | 1.00 | 1.00 | 1.00       | 1.00 | 1.00 | 1.00       | 1.00 | 1.00 |
| Final Volume:                        | 160         | 639  | 147  | 138         | 568  | 117  | 78         | 219  | 155  | 119        | 240  | 154  |
| Saturation Flow Module:              |             |      |      |             |      |      |            |      |      |            |      |      |
| Sat/Lane:                            | 1900        | 1900 | 1900 | 1900        | 1900 | 1900 | 1900       | 1900 | 1900 | 1900       | 1900 | 1900 |
| Adjustment:                          | 0.92        | 0.98 | 0.95 | 0.92        | 0.98 | 0.95 | 0.95       | 0.95 | 0.92 | 0.92       | 1.00 | 0.92 |
| Lanes:                               | 1.00        | 1.62 | 0.38 | 1.00        | 1.65 | 0.35 | 0.26       | 0.74 | 1.00 | 1.00       | 1.00 | 1.00 |
| Final Sat.:                          | 1750        | 3007 | 692  | 1750        | 3068 | 632  | 473        | 1327 | 1750 | 1750       | 1900 | 1750 |
| Capacity Analysis Module:            |             |      |      |             |      |      |            |      |      |            |      |      |
| Vol/Sat:                             | 0.09        | 0.21 | 0.21 | 0.08        | 0.19 | 0.19 | 0.17       | 0.17 | 0.09 | 0.07       | 0.13 | 0.09 |
| Crit Moves:                          | ****        | **** | **** | ****        | **** | **** | ****       | **** | **** | ****       | **** | **** |
| Green Time:                          | 14.2        | 31.4 | 31.4 | 11.6        | 28.8 | 28.8 | 24.4       | 26.6 | 26.6 | 16.4       | 18.6 | 18.6 |
| Volume/Cap:                          | 0.63        | 0.66 | 0.66 | 0.66        | 0.63 | 0.63 | 0.66       | 0.61 | 0.33 | 0.41       | 0.66 | 0.46 |
| Delay/Veh:                           | 44.5        | 30.2 | 30.2 | 49.2        | 31.2 | 31.2 | 36.9       | 33.4 | 29.0 | 37.3       | 41.4 | 36.2 |
| User DelAdj:                         | 1.00        | 1.00 | 1.00 | 1.00        | 1.00 | 1.00 | 1.00       | 1.00 | 1.00 | 1.00       | 1.00 | 1.00 |
| AdjDel/Veh:                          | 44.5        | 30.2 | 30.2 | 49.2        | 31.2 | 31.2 | 36.9       | 33.4 | 29.0 | 37.3       | 41.4 | 36.2 |
| LOS by Move:                         | D           | C    | C    | D           | C    | C    | D          | C    | C    | D          | D    | D    |
| HCM2k95thQ:                          | 10          | 19   | 19   | 9           | 17   | 17   | 18         | 17   | 8    | 8          | 15   | 10   |

Note: Queue reported is the number of cars per lane.

BART

Level Of Service Computation Report  
2000 HCM Operations (Future Volume Alternative)  
PM - Cumulative With Project

Intersection #3627: KING/SAN ANTONIO [Study Int 22]

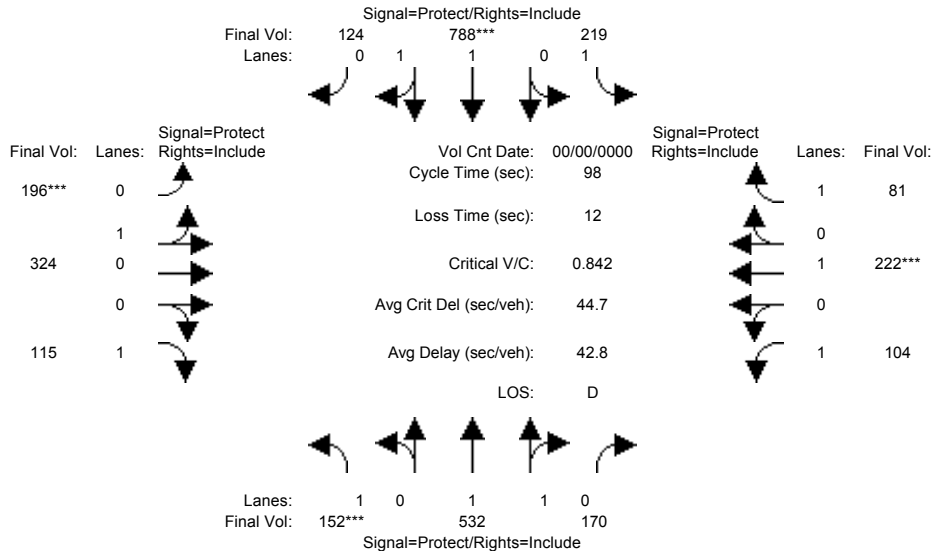

| Approach:                            | North Bound |      |      | South Bound |      |      | East Bound |      |      | West Bound |      |      |
|--------------------------------------|-------------|------|------|-------------|------|------|------------|------|------|------------|------|------|
| Movement:                            | L           | T    | R    | L           | T    | R    | L          | T    | R    | L          | T    | R    |
| Min. Green:                          | 7           | 10   | 10   | 7           | 10   | 10   | 10         | 10   | 10   | 10         | 10   | 10   |
| Y+R:                                 | 4.0         | 4.0  | 4.0  | 4.0         | 4.0  | 4.0  | 4.0        | 4.0  | 4.0  | 4.0        | 4.0  | 4.0  |
| Volume Module: >> Count Date: 0 0 << |             |      |      |             |      |      |            |      |      |            |      |      |
| Base Vol:                            | 152         | 532  | 170  | 219         | 788  | 124  | 196        | 324  | 115  | 104        | 222  | 81   |
| Growth Adj:                          | 1.00        | 1.00 | 1.00 | 1.00        | 1.00 | 1.00 | 1.00       | 1.00 | 1.00 | 1.00       | 1.00 | 1.00 |
| Initial Bse:                         | 152         | 532  | 170  | 219         | 788  | 124  | 196        | 324  | 115  | 104        | 222  | 81   |
| Added Vol:                           | 0           | 0    | 0    | 0           | 0    | 0    | 0          | 0    | 0    | 0          | 0    | 0    |
| PasserByVol:                         | 0           | 0    | 0    | 0           | 0    | 0    | 0          | 0    | 0    | 0          | 0    | 0    |
| Initial Fut:                         | 152         | 532  | 170  | 219         | 788  | 124  | 196        | 324  | 115  | 104        | 222  | 81   |
| User Adj:                            | 1.00        | 1.00 | 1.00 | 1.00        | 1.00 | 1.00 | 1.00       | 1.00 | 1.00 | 1.00       | 1.00 | 1.00 |
| PHF Adj:                             | 1.00        | 1.00 | 1.00 | 1.00        | 1.00 | 1.00 | 1.00       | 1.00 | 1.00 | 1.00       | 1.00 | 1.00 |
| PHF Volume:                          | 152         | 532  | 170  | 219         | 788  | 124  | 196        | 324  | 115  | 104        | 222  | 81   |
| Reduct Vol:                          | 0           | 0    | 0    | 0           | 0    | 0    | 0          | 0    | 0    | 0          | 0    | 0    |
| Reduced Vol:                         | 152         | 532  | 170  | 219         | 788  | 124  | 196        | 324  | 115  | 104        | 222  | 81   |
| PCE Adj:                             | 1.00        | 1.00 | 1.00 | 1.00        | 1.00 | 1.00 | 1.00       | 1.00 | 1.00 | 1.00       | 1.00 | 1.00 |
| MLF Adj:                             | 1.00        | 1.00 | 1.00 | 1.00        | 1.00 | 1.00 | 1.00       | 1.00 | 1.00 | 1.00       | 1.00 | 1.00 |
| Final Volume:                        | 152         | 532  | 170  | 219         | 788  | 124  | 196        | 324  | 115  | 104        | 222  | 81   |
| Saturation Flow Module:              |             |      |      |             |      |      |            |      |      |            |      |      |
| Sat/Lane:                            | 1900        | 1900 | 1900 | 1900        | 1900 | 1900 | 1900       | 1900 | 1900 | 1900       | 1900 | 1900 |
| Adjustment:                          | 0.92        | 0.98 | 0.95 | 0.92        | 0.98 | 0.95 | 0.95       | 0.95 | 0.92 | 0.92       | 1.00 | 0.92 |
| Lanes:                               | 1.00        | 1.50 | 0.50 | 1.00        | 1.72 | 0.28 | 0.38       | 0.62 | 1.00 | 1.00       | 1.00 | 1.00 |
| Final Sat.:                          | 1750        | 2803 | 896  | 1750        | 3197 | 503  | 678        | 1122 | 1750 | 1750       | 1900 | 1750 |
| Capacity Analysis Module:            |             |      |      |             |      |      |            |      |      |            |      |      |
| Vol/Sat:                             | 0.09        | 0.19 | 0.19 | 0.13        | 0.25 | 0.25 | 0.29       | 0.29 | 0.07 | 0.06       | 0.12 | 0.05 |
| Crit Moves:                          | ****        |      |      | ****        |      |      | ****       |      |      | ****       |      |      |
| Green Time:                          | 10.1        | 23.4 | 23.4 | 15.4        | 28.7 | 28.7 | 33.6       | 34.9 | 34.9 | 12.3       | 13.6 | 13.6 |
| Volume/Cap:                          | 0.84        | 0.80 | 0.80 | 0.80        | 0.84 | 0.84 | 0.84       | 0.81 | 0.18 | 0.47       | 0.84 | 0.33 |
| Delay/Veh:                           | 71.6        | 40.1 | 40.1 | 54.6        | 38.6 | 38.6 | 39.9       | 36.3 | 21.9 | 41.4       | 62.2 | 38.9 |
| User DelAdj:                         | 1.00        | 1.00 | 1.00 | 1.00        | 1.00 | 1.00 | 1.00       | 1.00 | 1.00 | 1.00       | 1.00 | 1.00 |
| AdjDel/Veh:                          | 71.6        | 40.1 | 40.1 | 54.6        | 38.6 | 38.6 | 39.9       | 36.3 | 21.9 | 41.4       | 62.2 | 38.9 |
| LOS by Move:                         | E           | D    | D    | D           | D    | D    | D          | D    | C    | D          | E    | D    |
| HCM2k95thQ:                          | 11          | 20   | 20   | 14          | 25   | 25   | 31         | 30   | 5    | 7          | 17   | 5    |

Note: Queue reported is the number of cars per lane.

BART

Level Of Service Computation Report  
2000 HCM Operations (Future Volume Alternative)  
AM - Cumulative No Project

Intersection #3678: MCKEE/33RD [Study Int 6]

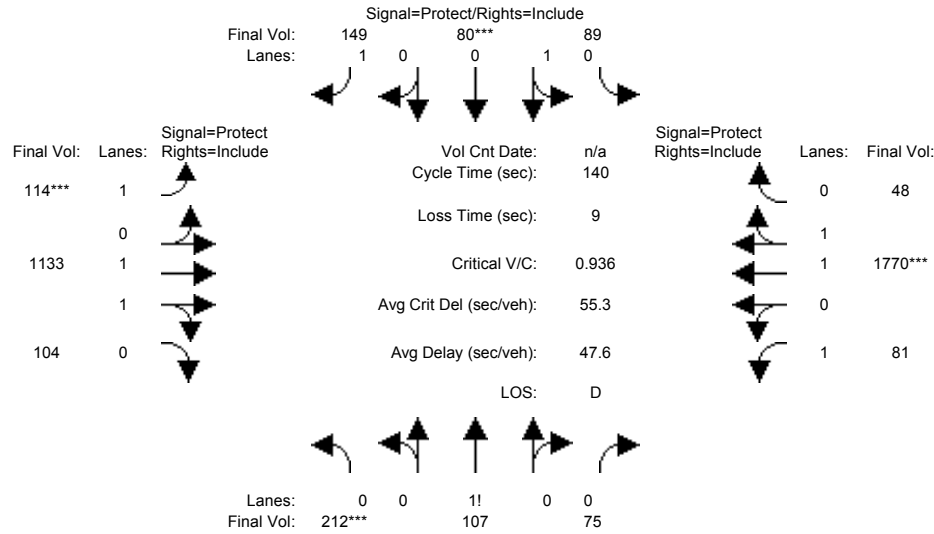

| Approach:                 | North Bound |      |      | South Bound |      |      | East Bound |      |      | West Bound |      |      |
|---------------------------|-------------|------|------|-------------|------|------|------------|------|------|------------|------|------|
| Movement:                 | L           | T    | R    | L           | T    | R    | L          | T    | R    | L          | T    | R    |
| Min. Green:               | 10          | 10   | 10   | 10          | 10   | 10   | 7          | 10   | 10   | 7          | 10   | 10   |
| Y+R:                      | 4.0         | 4.0  | 4.0  | 4.0         | 4.0  | 4.0  | 4.0        | 4.0  | 4.0  | 4.0        | 4.0  | 4.0  |
| Volume Module:            |             |      |      |             |      |      |            |      |      |            |      |      |
| Base Vol:                 | 212         | 107  | 75   | 89          | 80   | 149  | 114        | 1133 | 104  | 81         | 1770 | 48   |
| Growth Adj:               | 1.00        | 1.00 | 1.00 | 1.00        | 1.00 | 1.00 | 1.00       | 1.00 | 1.00 | 1.00       | 1.00 | 1.00 |
| Initial Bse:              | 212         | 107  | 75   | 89          | 80   | 149  | 114        | 1133 | 104  | 81         | 1770 | 48   |
| Added Vol:                | 0           | 0    | 0    | 0           | 0    | 0    | 0          | 0    | 0    | 0          | 0    | 0    |
| PasserByVol:              | 0           | 0    | 0    | 0           | 0    | 0    | 0          | 0    | 0    | 0          | 0    | 0    |
| Initial Fut:              | 212         | 107  | 75   | 89          | 80   | 149  | 114        | 1133 | 104  | 81         | 1770 | 48   |
| User Adj:                 | 1.00        | 1.00 | 1.00 | 1.00        | 1.00 | 1.00 | 1.00       | 1.00 | 1.00 | 1.00       | 1.00 | 1.00 |
| PHF Adj:                  | 1.00        | 1.00 | 1.00 | 1.00        | 1.00 | 1.00 | 1.00       | 1.00 | 1.00 | 1.00       | 1.00 | 1.00 |
| PHF Volume:               | 212         | 107  | 75   | 89          | 80   | 149  | 114        | 1133 | 104  | 81         | 1770 | 48   |
| Reduct Vol:               | 0           | 0    | 0    | 0           | 0    | 0    | 0          | 0    | 0    | 0          | 0    | 0    |
| Reduced Vol:              | 212         | 107  | 75   | 89          | 80   | 149  | 114        | 1133 | 104  | 81         | 1770 | 48   |
| PCE Adj:                  | 1.00        | 1.00 | 1.00 | 1.00        | 1.00 | 1.00 | 1.00       | 1.00 | 1.00 | 1.00       | 1.00 | 1.00 |
| MLF Adj:                  | 1.00        | 1.00 | 1.00 | 1.00        | 1.00 | 1.00 | 1.00       | 1.00 | 1.00 | 1.00       | 1.00 | 1.00 |
| FinalVolume:              | 212         | 107  | 75   | 89          | 80   | 149  | 114        | 1133 | 104  | 81         | 1770 | 48   |
| Saturation Flow Module:   |             |      |      |             |      |      |            |      |      |            |      |      |
| Sat/Lane:                 | 1900        | 1900 | 1900 | 1900        | 1900 | 1900 | 1900       | 1900 | 1900 | 1900       | 1900 | 1900 |
| Adjustment:               | 0.92        | 0.92 | 0.92 | 0.95        | 0.95 | 0.92 | 0.92       | 0.98 | 0.95 | 0.92       | 0.97 | 0.95 |
| Lanes:                    | 0.54        | 0.27 | 0.19 | 0.53        | 0.47 | 1.00 | 1.00       | 1.83 | 0.17 | 1.00       | 1.95 | 0.05 |
| Final Sat.:               | 942         | 475  | 333  | 948         | 852  | 1750 | 1750       | 3389 | 311  | 1750       | 3602 | 98   |
| Capacity Analysis Module: |             |      |      |             |      |      |            |      |      |            |      |      |
| Vol/Sat:                  | 0.23        | 0.23 | 0.23 | 0.09        | 0.09 | 0.09 | 0.07       | 0.33 | 0.33 | 0.05       | 0.49 | 0.49 |
| Crit Moves:               | ****        |      |      | ****        |      |      | ****       |      |      | ****       |      |      |
| Green Time:               | 33.7        | 33.7 | 33.7 | 14.0        | 14.0 | 14.0 | 9.7        | 72.4 | 72.4 | 10.8       | 73.5 | 73.5 |
| Volume/Cap:               | 0.94        | 0.94 | 0.94 | 0.94        | 0.94 | 0.85 | 0.94       | 0.65 | 0.65 | 0.60       | 0.94 | 0.94 |
| Delay/Veh:                | 80.3        | 80.3 | 80.3 | 111.1       | 111  | 92.1 | 126.4      | 25.3 | 25.3 | 69.7       | 40.2 | 40.2 |
| User DelAdj:              | 1.00        | 1.00 | 1.00 | 1.00        | 1.00 | 1.00 | 1.00       | 1.00 | 1.00 | 1.00       | 1.00 | 1.00 |
| AdjDel/Veh:               | 80.3        | 80.3 | 80.3 | 111.1       | 111  | 92.1 | 126.4      | 25.3 | 25.3 | 69.7       | 40.2 | 40.2 |
| LOS by Move:              | F           | F    | F    | F           | F    | F    | F          | C    | C    | E          | D    | D    |
| HCM2k95thQ:               | 34          | 34   | 34   | 20          | 20   | 17   | 12         | 33   | 33   | 7          | 55   | 55   |

Note: Queue reported is the number of cars per lane.



BART

Level Of Service Computation Report  
 2000 HCM Operations (Future Volume Alternative)  
 PM - Cumulative No Project

Intersection #3678: MCKEE/33RD [Study Int 6]

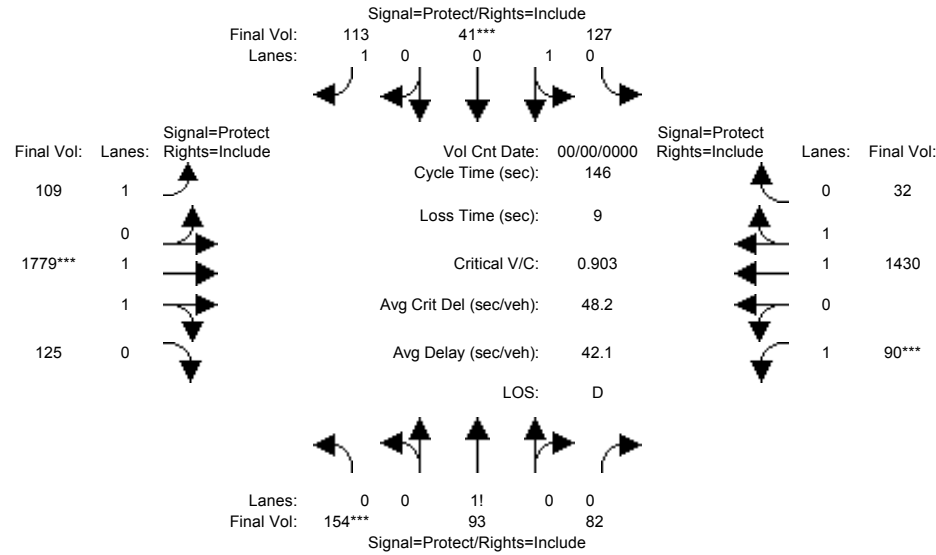

| Approach:                            | North Bound |      |      | South Bound |      |      | East Bound |      |      | West Bound |      |      |
|--------------------------------------|-------------|------|------|-------------|------|------|------------|------|------|------------|------|------|
| Movement:                            | L           | T    | R    | L           | T    | R    | L          | T    | R    | L          | T    | R    |
| Min. Green:                          | 10          | 10   | 10   | 10          | 10   | 10   | 7          | 10   | 10   | 7          | 10   | 10   |
| Y+R:                                 | 4.0         | 4.0  | 4.0  | 4.0         | 4.0  | 4.0  | 4.0        | 4.0  | 4.0  | 4.0        | 4.0  | 4.0  |
| Volume Module: >> Count Date: 0 0 << |             |      |      |             |      |      |            |      |      |            |      |      |
| Base Vol:                            | 154         | 93   | 82   | 127         | 41   | 113  | 109        | 1779 | 125  | 90         | 1430 | 32   |
| Growth Adj:                          | 1.00        | 1.00 | 1.00 | 1.00        | 1.00 | 1.00 | 1.00       | 1.00 | 1.00 | 1.00       | 1.00 | 1.00 |
| Initial Bse:                         | 154         | 93   | 82   | 127         | 41   | 113  | 109        | 1779 | 125  | 90         | 1430 | 32   |
| Added Vol:                           | 0           | 0    | 0    | 0           | 0    | 0    | 0          | 0    | 0    | 0          | 0    | 0    |
| PasserByVol:                         | 0           | 0    | 0    | 0           | 0    | 0    | 0          | 0    | 0    | 0          | 0    | 0    |
| Initial Fut:                         | 154         | 93   | 82   | 127         | 41   | 113  | 109        | 1779 | 125  | 90         | 1430 | 32   |
| User Adj:                            | 1.00        | 1.00 | 1.00 | 1.00        | 1.00 | 1.00 | 1.00       | 1.00 | 1.00 | 1.00       | 1.00 | 1.00 |
| PHF Adj:                             | 1.00        | 1.00 | 1.00 | 1.00        | 1.00 | 1.00 | 1.00       | 1.00 | 1.00 | 1.00       | 1.00 | 1.00 |
| PHF Volume:                          | 154         | 93   | 82   | 127         | 41   | 113  | 109        | 1779 | 125  | 90         | 1430 | 32   |
| Reduct Vol:                          | 0           | 0    | 0    | 0           | 0    | 0    | 0          | 0    | 0    | 0          | 0    | 0    |
| Reduced Vol:                         | 154         | 93   | 82   | 127         | 41   | 113  | 109        | 1779 | 125  | 90         | 1430 | 32   |
| PCE Adj:                             | 1.00        | 1.00 | 1.00 | 1.00        | 1.00 | 1.00 | 1.00       | 1.00 | 1.00 | 1.00       | 1.00 | 1.00 |
| MLF Adj:                             | 1.00        | 1.00 | 1.00 | 1.00        | 1.00 | 1.00 | 1.00       | 1.00 | 1.00 | 1.00       | 1.00 | 1.00 |
| Final Volume:                        | 154         | 93   | 82   | 127         | 41   | 113  | 109        | 1779 | 125  | 90         | 1430 | 32   |
| Saturation Flow Module:              |             |      |      |             |      |      |            |      |      |            |      |      |
| Sat/Lane:                            | 1900        | 1900 | 1900 | 1900        | 1900 | 1900 | 1900       | 1900 | 1900 | 1900       | 1900 | 1900 |
| Adjustment:                          | 0.92        | 0.92 | 0.92 | 0.95        | 0.95 | 0.92 | 0.92       | 0.98 | 0.95 | 0.92       | 0.97 | 0.95 |
| Lanes:                               | 0.47        | 0.28 | 0.25 | 0.76        | 0.24 | 1.00 | 1.00       | 1.87 | 0.13 | 1.00       | 1.96 | 0.04 |
| Final Sat.:                          | 819         | 495  | 436  | 1361        | 439  | 1750 | 1750       | 3457 | 243  | 1750       | 3619 | 81   |
| Capacity Analysis Module:            |             |      |      |             |      |      |            |      |      |            |      |      |
| Vol/Sat:                             | 0.19        | 0.19 | 0.19 | 0.09        | 0.09 | 0.06 | 0.06       | 0.51 | 0.51 | 0.05       | 0.40 | 0.40 |
| Crit Moves:                          | ****        |      |      | ****        |      |      | ****       |      |      | ****       |      |      |
| Green Time:                          | 30.4        | 30.4 | 30.4 | 15.1        | 15.1 | 15.1 | 12.5       | 83.2 | 83.2 | 8.3        | 79.1 | 79.1 |
| Volume/Cap:                          | 0.90        | 0.90 | 0.90 | 0.90        | 0.90 | 0.62 | 0.73       | 0.90 | 0.90 | 0.90       | 0.73 | 0.73 |
| Delay/Veh:                           | 81.2        | 81.2 | 81.2 | 104.5       | 105  | 69.4 | 81.8       | 33.7 | 33.7 | 128.3      | 26.8 | 26.8 |
| User DelAdj:                         | 1.00        | 1.00 | 1.00 | 1.00        | 1.00 | 1.00 | 1.00       | 1.00 | 1.00 | 1.00       | 1.00 | 1.00 |
| AdjDel/Veh:                          | 81.2        | 81.2 | 81.2 | 104.5       | 105  | 69.4 | 81.8       | 33.7 | 33.7 | 128.3      | 26.8 | 26.8 |
| LOS by Move:                         | F           | F    | F    | F           | F    | E    | F          | C    | C    | F          | C    | C    |
| HCM2k95thQ:                          | 29          | 29   | 29   | 20          | 20   | 12   | 10         | 62   | 62   | 9          | 40   | 40   |

Note: Queue reported is the number of cars per lane.

BART

Level Of Service Computation Report  
2000 HCM Operations (Future Volume Alternative)  
AM - Cumulative With Project

Intersection #3678: MCKEE/33RD [Study Int 6]

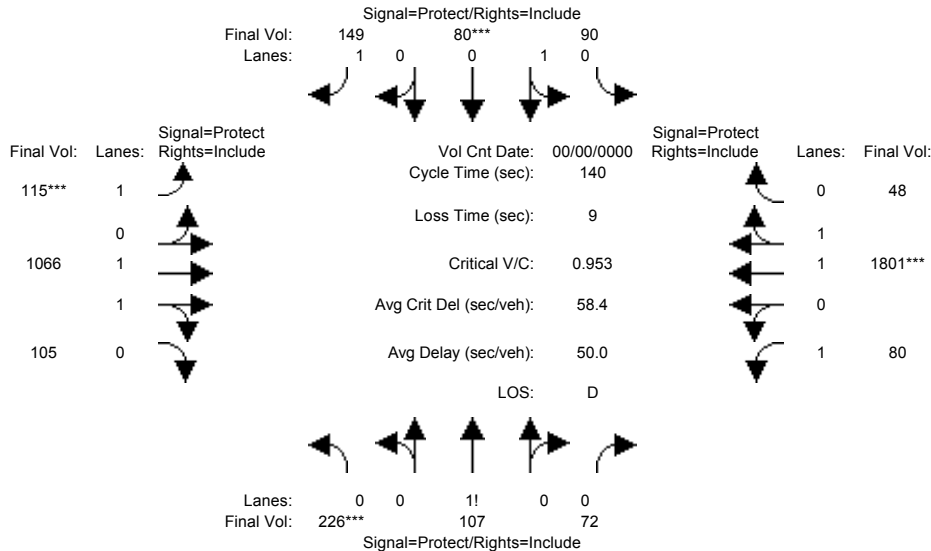

| Approach:                            | North Bound |      |      | South Bound |      |      | East Bound |      |      | West Bound |      |      |
|--------------------------------------|-------------|------|------|-------------|------|------|------------|------|------|------------|------|------|
| Movement:                            | L           | T    | R    | L           | T    | R    | L          | T    | R    | L          | T    | R    |
| Min. Green:                          | 10          | 10   | 10   | 10          | 10   | 10   | 7          | 10   | 10   | 7          | 10   | 10   |
| Y+R:                                 | 4.0         | 4.0  | 4.0  | 4.0         | 4.0  | 4.0  | 4.0        | 4.0  | 4.0  | 4.0        | 4.0  | 4.0  |
| Volume Module: >> Count Date: 0 0 << |             |      |      |             |      |      |            |      |      |            |      |      |
| Base Vol:                            | 226         | 107  | 72   | 90          | 80   | 149  | 115        | 1066 | 105  | 80         | 1801 | 48   |
| Growth Adj:                          | 1.00        | 1.00 | 1.00 | 1.00        | 1.00 | 1.00 | 1.00       | 1.00 | 1.00 | 1.00       | 1.00 | 1.00 |
| Initial Bse:                         | 226         | 107  | 72   | 90          | 80   | 149  | 115        | 1066 | 105  | 80         | 1801 | 48   |
| Added Vol:                           | 0           | 0    | 0    | 0           | 0    | 0    | 0          | 0    | 0    | 0          | 0    | 0    |
| PasserByVol:                         | 0           | 0    | 0    | 0           | 0    | 0    | 0          | 0    | 0    | 0          | 0    | 0    |
| Initial Fut:                         | 226         | 107  | 72   | 90          | 80   | 149  | 115        | 1066 | 105  | 80         | 1801 | 48   |
| User Adj:                            | 1.00        | 1.00 | 1.00 | 1.00        | 1.00 | 1.00 | 1.00       | 1.00 | 1.00 | 1.00       | 1.00 | 1.00 |
| PHF Adj:                             | 1.00        | 1.00 | 1.00 | 1.00        | 1.00 | 1.00 | 1.00       | 1.00 | 1.00 | 1.00       | 1.00 | 1.00 |
| PHF Volume:                          | 226         | 107  | 72   | 90          | 80   | 149  | 115        | 1066 | 105  | 80         | 1801 | 48   |
| Reduct Vol:                          | 0           | 0    | 0    | 0           | 0    | 0    | 0          | 0    | 0    | 0          | 0    | 0    |
| Reduced Vol:                         | 226         | 107  | 72   | 90          | 80   | 149  | 115        | 1066 | 105  | 80         | 1801 | 48   |
| PCE Adj:                             | 1.00        | 1.00 | 1.00 | 1.00        | 1.00 | 1.00 | 1.00       | 1.00 | 1.00 | 1.00       | 1.00 | 1.00 |
| MLF Adj:                             | 1.00        | 1.00 | 1.00 | 1.00        | 1.00 | 1.00 | 1.00       | 1.00 | 1.00 | 1.00       | 1.00 | 1.00 |
| Final Volume:                        | 226         | 107  | 72   | 90          | 80   | 149  | 115        | 1066 | 105  | 80         | 1801 | 48   |
| Saturation Flow Module:              |             |      |      |             |      |      |            |      |      |            |      |      |
| Sat/Lane:                            | 1900        | 1900 | 1900 | 1900        | 1900 | 1900 | 1900       | 1900 | 1900 | 1900       | 1900 | 1900 |
| Adjustment:                          | 0.92        | 0.92 | 0.92 | 0.95        | 0.95 | 0.92 | 0.92       | 0.98 | 0.95 | 0.92       | 0.97 | 0.95 |
| Lanes:                               | 0.56        | 0.26 | 0.18 | 0.53        | 0.47 | 1.00 | 1.00       | 1.82 | 0.18 | 1.00       | 1.95 | 0.05 |
| Final Sat.:                          | 977         | 462  | 311  | 953         | 847  | 1750 | 1750       | 3368 | 332  | 1750       | 3604 | 96   |
| Capacity Analysis Module:            |             |      |      |             |      |      |            |      |      |            |      |      |
| Vol/Sat:                             | 0.23        | 0.23 | 0.23 | 0.09        | 0.09 | 0.09 | 0.07       | 0.32 | 0.32 | 0.05       | 0.50 | 0.50 |
| Crit Moves:                          | ****        | **** | **** | ****        | **** | **** | ****       | **** | **** | ****       | **** | **** |
| Green Time:                          | 34.0        | 34.0 | 34.0 | 13.9        | 13.9 | 13.9 | 9.7        | 71.8 | 71.8 | 11.3       | 73.4 | 73.4 |
| Volume/Cap:                          | 0.95        | 0.95 | 0.95 | 0.95        | 0.95 | 0.86 | 0.95       | 0.62 | 0.62 | 0.56       | 0.95 | 0.95 |
| Delay/Veh:                           | 83.8        | 83.8 | 83.8 | 116.2       | 116  | 94.4 | 131.9      | 24.9 | 24.9 | 67.1       | 42.9 | 42.9 |
| User DelAdj:                         | 1.00        | 1.00 | 1.00 | 1.00        | 1.00 | 1.00 | 1.00       | 1.00 | 1.00 | 1.00       | 1.00 | 1.00 |
| AdjDel/Veh:                          | 83.8        | 83.8 | 83.8 | 116.2       | 116  | 94.4 | 131.9      | 24.9 | 24.9 | 67.1       | 42.9 | 42.9 |
| LOS by Move:                         | F           | F    | F    | F           | F    | F    | F          | C    | C    | E          | D    | D    |
| HCM2k95thQ:                          | 35          | 35   | 35   | 20          | 20   | 17   | 12         | 31   | 31   | 7          | 58   | 58   |

Note: Queue reported is the number of cars per lane.

BART

Level Of Service Computation Report  
2000 HCM Operations (Future Volume Alternative)  
PM - Cumulative With Project

Intersection #3678: MCKEE/33RD [Study Int 6]

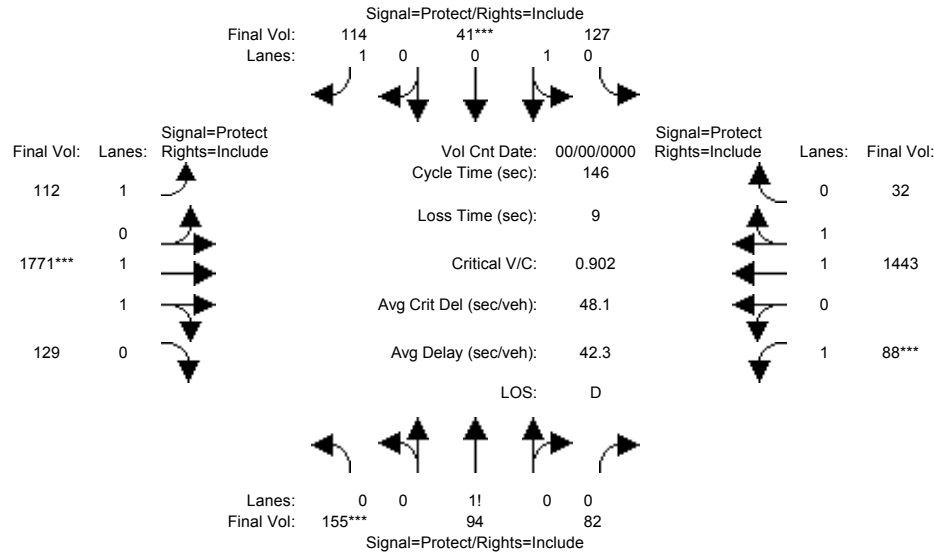

| Approach:                            | North Bound |      |      | South Bound |      |      | East Bound |      |      | West Bound |      |      |
|--------------------------------------|-------------|------|------|-------------|------|------|------------|------|------|------------|------|------|
| Movement:                            | L           | T    | R    | L           | T    | R    | L          | T    | R    | L          | T    | R    |
| Min. Green:                          | 10          | 10   | 10   | 10          | 10   | 10   | 7          | 10   | 10   | 7          | 10   | 10   |
| Y+R:                                 | 4.0         | 4.0  | 4.0  | 4.0         | 4.0  | 4.0  | 4.0        | 4.0  | 4.0  | 4.0        | 4.0  | 4.0  |
| Volume Module: >> Count Date: 0 0 << |             |      |      |             |      |      |            |      |      |            |      |      |
| Base Vol:                            | 155         | 94   | 82   | 127         | 41   | 114  | 112        | 1771 | 129  | 88         | 1443 | 32   |
| Growth Adj:                          | 1.00        | 1.00 | 1.00 | 1.00        | 1.00 | 1.00 | 1.00       | 1.00 | 1.00 | 1.00       | 1.00 | 1.00 |
| Initial Bse:                         | 155         | 94   | 82   | 127         | 41   | 114  | 112        | 1771 | 129  | 88         | 1443 | 32   |
| Added Vol:                           | 0           | 0    | 0    | 0           | 0    | 0    | 0          | 0    | 0    | 0          | 0    | 0    |
| PasserByVol:                         | 0           | 0    | 0    | 0           | 0    | 0    | 0          | 0    | 0    | 0          | 0    | 0    |
| Initial Fut:                         | 155         | 94   | 82   | 127         | 41   | 114  | 112        | 1771 | 129  | 88         | 1443 | 32   |
| User Adj:                            | 1.00        | 1.00 | 1.00 | 1.00        | 1.00 | 1.00 | 1.00       | 1.00 | 1.00 | 1.00       | 1.00 | 1.00 |
| PHF Adj:                             | 1.00        | 1.00 | 1.00 | 1.00        | 1.00 | 1.00 | 1.00       | 1.00 | 1.00 | 1.00       | 1.00 | 1.00 |
| PHF Volume:                          | 155         | 94   | 82   | 127         | 41   | 114  | 112        | 1771 | 129  | 88         | 1443 | 32   |
| Reduct Vol:                          | 0           | 0    | 0    | 0           | 0    | 0    | 0          | 0    | 0    | 0          | 0    | 0    |
| Reduced Vol:                         | 155         | 94   | 82   | 127         | 41   | 114  | 112        | 1771 | 129  | 88         | 1443 | 32   |
| PCE Adj:                             | 1.00        | 1.00 | 1.00 | 1.00        | 1.00 | 1.00 | 1.00       | 1.00 | 1.00 | 1.00       | 1.00 | 1.00 |
| MLF Adj:                             | 1.00        | 1.00 | 1.00 | 1.00        | 1.00 | 1.00 | 1.00       | 1.00 | 1.00 | 1.00       | 1.00 | 1.00 |
| FinalVolume:                         | 155         | 94   | 82   | 127         | 41   | 114  | 112        | 1771 | 129  | 88         | 1443 | 32   |
| Saturation Flow Module:              |             |      |      |             |      |      |            |      |      |            |      |      |
| Sat/Lane:                            | 1900        | 1900 | 1900 | 1900        | 1900 | 1900 | 1900       | 1900 | 1900 | 1900       | 1900 | 1900 |
| Adjustment:                          | 0.92        | 0.92 | 0.92 | 0.95        | 0.95 | 0.92 | 0.92       | 0.98 | 0.95 | 0.92       | 0.97 | 0.95 |
| Lanes:                               | 0.47        | 0.28 | 0.25 | 0.76        | 0.24 | 1.00 | 1.00       | 1.86 | 0.14 | 1.00       | 1.96 | 0.04 |
| Final Sat.:                          | 819         | 497  | 434  | 1361        | 439  | 1750 | 1750       | 3449 | 251  | 1750       | 3620 | 80   |
| Capacity Analysis Module:            |             |      |      |             |      |      |            |      |      |            |      |      |
| Vol/Sat:                             | 0.19        | 0.19 | 0.19 | 0.09        | 0.09 | 0.07 | 0.06       | 0.51 | 0.51 | 0.05       | 0.40 | 0.40 |
| Crit Moves:                          | ****        |      |      | ****        |      |      | ****       |      |      | ****       |      |      |
| Green Time:                          | 30.6        | 30.6 | 30.6 | 15.1        | 15.1 | 15.1 | 12.6       | 83.1 | 83.1 | 8.1        | 78.6 | 78.6 |
| Volume/Cap:                          | 0.90        | 0.90 | 0.90 | 0.90        | 0.90 | 0.63 | 0.74       | 0.90 | 0.90 | 0.90       | 0.74 | 0.74 |
| Delay/Veh:                           | 80.7        | 80.7 | 80.7 | 104.2       | 104  | 69.7 | 82.6       | 33.7 | 33.7 | 128.9      | 27.3 | 27.3 |
| User DelAdj:                         | 1.00        | 1.00 | 1.00 | 1.00        | 1.00 | 1.00 | 1.00       | 1.00 | 1.00 | 1.00       | 1.00 | 1.00 |
| AdjDel/Veh:                          | 80.7        | 80.7 | 80.7 | 104.2       | 104  | 69.7 | 82.6       | 33.7 | 33.7 | 128.9      | 27.3 | 27.3 |
| LOS by Move:                         | F           | F    | F    | F           | F    | E    | F          | C    | C    | F          | C    | C    |
| HCM2k95thQ:                          | 29          | 29   | 29   | 20          | 20   | 12   | 10         | 62   | 62   | 9          | 41   | 41   |

Note: Queue reported is the number of cars per lane.

BART

Level Of Service Computation Report  
2000 HCM Operations (Future Volume Alternative)  
AM - Cumulative No Project

Intersection #3683: McLAUGHLIN/STORY [Study Int 26]

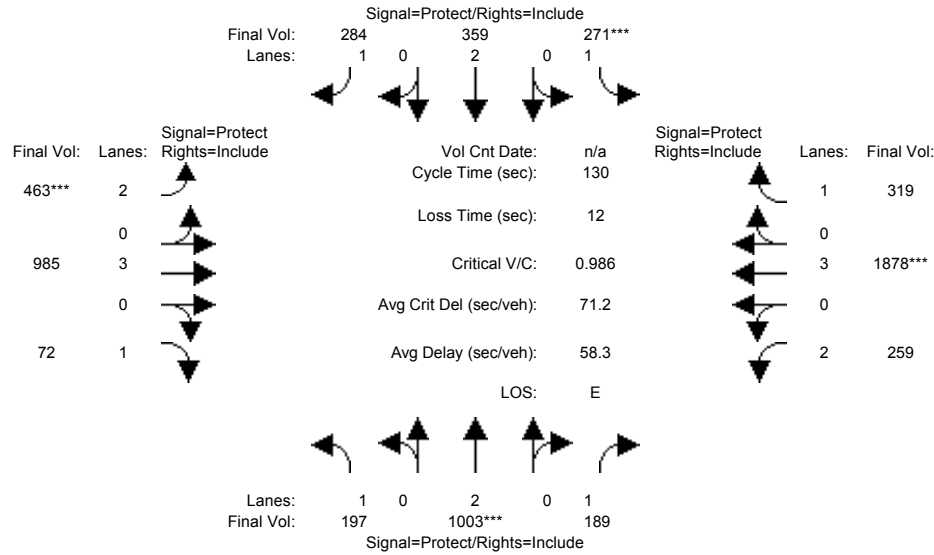

| Approach:                 | North Bound |      |      | South Bound |      |      | East Bound |      |      | West Bound |      |      |
|---------------------------|-------------|------|------|-------------|------|------|------------|------|------|------------|------|------|
| Movement:                 | L           | T    | R    | L           | T    | R    | L          | T    | R    | L          | T    | R    |
| Min. Green:               | 7           | 10   | 10   | 7           | 10   | 10   | 7          | 10   | 10   | 7          | 10   | 10   |
| Y+R:                      | 4.0         | 4.0  | 4.0  | 4.0         | 4.0  | 4.0  | 4.0        | 4.0  | 4.0  | 4.0        | 4.0  | 4.0  |
| Volume Module:            |             |      |      |             |      |      |            |      |      |            |      |      |
| Base Vol:                 | 197         | 1003 | 189  | 271         | 359  | 284  | 463        | 985  | 72   | 259        | 1878 | 319  |
| Growth Adj:               | 1.00        | 1.00 | 1.00 | 1.00        | 1.00 | 1.00 | 1.00       | 1.00 | 1.00 | 1.00       | 1.00 | 1.00 |
| Initial Bse:              | 197         | 1003 | 189  | 271         | 359  | 284  | 463        | 985  | 72   | 259        | 1878 | 319  |
| Added Vol:                | 0           | 0    | 0    | 0           | 0    | 0    | 0          | 0    | 0    | 0          | 0    | 0    |
| PasserByVol:              | 0           | 0    | 0    | 0           | 0    | 0    | 0          | 0    | 0    | 0          | 0    | 0    |
| Initial Fut:              | 197         | 1003 | 189  | 271         | 359  | 284  | 463        | 985  | 72   | 259        | 1878 | 319  |
| User Adj:                 | 1.00        | 1.00 | 1.00 | 1.00        | 1.00 | 1.00 | 1.00       | 1.00 | 1.00 | 1.00       | 1.00 | 1.00 |
| PHF Adj:                  | 1.00        | 1.00 | 1.00 | 1.00        | 1.00 | 1.00 | 1.00       | 1.00 | 1.00 | 1.00       | 1.00 | 1.00 |
| PHF Volume:               | 197         | 1003 | 189  | 271         | 359  | 284  | 463        | 985  | 72   | 259        | 1878 | 319  |
| Reduct Vol:               | 0           | 0    | 0    | 0           | 0    | 0    | 0          | 0    | 0    | 0          | 0    | 0    |
| Reduced Vol:              | 197         | 1003 | 189  | 271         | 359  | 284  | 463        | 985  | 72   | 259        | 1878 | 319  |
| PCE Adj:                  | 1.00        | 1.00 | 1.00 | 1.00        | 1.00 | 1.00 | 1.00       | 1.00 | 1.00 | 1.00       | 1.00 | 1.00 |
| MLF Adj:                  | 1.00        | 1.00 | 1.00 | 1.00        | 1.00 | 1.00 | 1.00       | 1.00 | 1.00 | 1.00       | 1.00 | 1.00 |
| Final Volume:             | 197         | 1003 | 189  | 271         | 359  | 284  | 463        | 985  | 72   | 259        | 1878 | 319  |
| Saturation Flow Module:   |             |      |      |             |      |      |            |      |      |            |      |      |
| Sat/Lane:                 | 1900        | 1900 | 1900 | 1900        | 1900 | 1900 | 1900       | 1900 | 1900 | 1900       | 1900 | 1900 |
| Adjustment:               | 0.92        | 1.00 | 0.92 | 0.92        | 1.00 | 0.92 | 0.83       | 1.00 | 0.92 | 0.83       | 1.00 | 0.92 |
| Lanes:                    | 1.00        | 2.00 | 1.00 | 1.00        | 2.00 | 1.00 | 2.00       | 3.00 | 1.00 | 2.00       | 3.00 | 1.00 |
| Final Sat.:               | 1750        | 3800 | 1750 | 1750        | 3800 | 1750 | 3150       | 5700 | 1750 | 3150       | 5700 | 1750 |
| Capacity Analysis Module: |             |      |      |             |      |      |            |      |      |            |      |      |
| Vol/Sat:                  | 0.11        | 0.26 | 0.11 | 0.15        | 0.09 | 0.16 | 0.15       | 0.17 | 0.04 | 0.08       | 0.33 | 0.18 |
| Crit Moves:               | ****        | **** | **** | ****        | **** | **** | ****       | **** | **** | ****       | **** | **** |
| Green Time:               | 22.6        | 34.8 | 34.8 | 20.4        | 32.6 | 32.6 | 19.4       | 42.6 | 42.6 | 20.2       | 43.4 | 43.4 |
| Volume/Cap:               | 0.65        | 0.99 | 0.40 | 0.99        | 0.38 | 0.65 | 0.99       | 0.53 | 0.13 | 0.53       | 0.99 | 0.55 |
| Delay/Veh:                | 54.8        | 72.2 | 39.7 | 105.0       | 40.6 | 46.9 | 93.0       | 35.8 | 30.8 | 51.6       | 60.4 | 36.3 |
| User DelAdj:              | 1.00        | 1.00 | 1.00 | 1.00        | 1.00 | 1.00 | 1.00       | 1.00 | 1.00 | 1.00       | 1.00 | 1.00 |
| AdjDel/Veh:               | 54.8        | 72.2 | 39.7 | 105.0       | 40.6 | 46.9 | 93.0       | 35.8 | 30.8 | 51.6       | 60.4 | 36.3 |
| LOS by Move:              | D           | E    | D    | F           | D    | D    | F          | D    | C    | D          | E    | D    |
| HCM2k95thQ:               | 17          | 42   | 13   | 25          | 11   | 20   | 28         | 20   | 4    | 11         | 47   | 20   |

Note: Queue reported is the number of cars per lane.

BART

Level Of Service Computation Report  
2000 HCM Operations (Future Volume Alternative)  
PM - Cumulative No Project

Intersection #3683: McLAUGHLIN/STORY [Study Int 26]

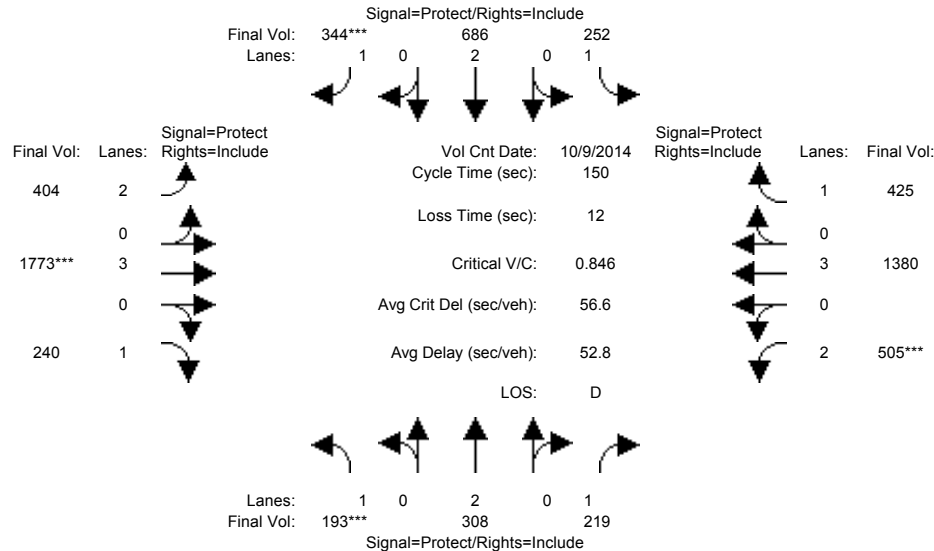

| Approach:                                   | North Bound |      |      | South Bound |      |      | East Bound |      |      | West Bound |      |      |
|---|-------------|------|------|-------------|------|------|------------|------|------|------------|------|------|
| Movement:                                   | L           | T    | R    | L           | T    | R    | L          | T    | R    | L          | T    | R    |
| Min. Green:                                 | 7           | 10   | 10   | 7           | 10   | 10   | 7          | 10   | 10   | 7          | 10   | 10   |
| Y+R:  | 4.0         | 4.0  | 4.0  | 4.0         | 4.0  | 4.0  | 4.0        | 4.0  | 4.0  | 4.0        | 4.0  | 4.0  |
| Volume Module: >> Count Date: 9 Oct 2014 << |             |      |      |             |      |      |            |      |      |            |      |      |
| Base Vol:                                   | 193         | 308  | 219  | 252         | 686  | 344  | 404        | 1773 | 240  | 505        | 1380 | 425  |
| Growth Adj:                                 | 1.00        | 1.00 | 1.00 | 1.00        | 1.00 | 1.00 | 1.00       | 1.00 | 1.00 | 1.00       | 1.00 | 1.00 |
| Initial Bse:                                | 193         | 308  | 219  | 252         | 686  | 344  | 404        | 1773 | 240  | 505        | 1380 | 425  |
| Added Vol:                                  | 0           | 0    | 0    | 0           | 0    | 0    | 0          | 0    | 0    | 0          | 0    | 0    |
| PasserByVol:                                | 0           | 0    | 0    | 0           | 0    | 0    | 0          | 0    | 0    | 0          | 0    | 0    |
| Initial Fut:                                | 193         | 308  | 219  | 252         | 686  | 344  | 404        | 1773 | 240  | 505        | 1380 | 425  |
| User Adj:                                   | 1.00        | 1.00 | 1.00 | 1.00        | 1.00 | 1.00 | 1.00       | 1.00 | 1.00 | 1.00       | 1.00 | 1.00 |
| PHF Adj:                                    | 1.00        | 1.00 | 1.00 | 1.00        | 1.00 | 1.00 | 1.00       | 1.00 | 1.00 | 1.00       | 1.00 | 1.00 |
| PHF Volume:                                 | 193         | 308  | 219  | 252         | 686  | 344  | 404        | 1773 | 240  | 505        | 1380 | 425  |
| Reduct Vol:                                 | 0           | 0    | 0    | 0           | 0    | 0    | 0          | 0    | 0    | 0          | 0    | 0    |
| Reduced Vol:                                | 193         | 308  | 219  | 252         | 686  | 344  | 404        | 1773 | 240  | 505        | 1380 | 425  |
| PCE Adj:                                    | 1.00        | 1.00 | 1.00 | 1.00        | 1.00 | 1.00 | 1.00       | 1.00 | 1.00 | 1.00       | 1.00 | 1.00 |
| MLF Adj:                                    | 1.00        | 1.00 | 1.00 | 1.00        | 1.00 | 1.00 | 1.00       | 1.00 | 1.00 | 1.00       | 1.00 | 1.00 |
| Final Volume:                               | 193         | 308  | 219  | 252         | 686  | 344  | 404        | 1773 | 240  | 505        | 1380 | 425  |
| Saturation Flow Module:                     |             |      |      |             |      |      |            |      |      |            |      |      |
| Sat/Lane:                                   | 1900        | 1900 | 1900 | 1900        | 1900 | 1900 | 1900       | 1900 | 1900 | 1900       | 1900 | 1900 |
| Adjustment:                                 | 0.92        | 1.00 | 0.92 | 0.92        | 1.00 | 0.92 | 0.83       | 1.00 | 0.92 | 0.83       | 1.00 | 0.92 |
| Lanes:                                      | 1.00        | 2.00 | 1.00 | 1.00        | 2.00 | 1.00 | 2.00       | 3.00 | 1.00 | 2.00       | 3.00 | 1.00 |
| Final Sat.:                                 | 1750        | 3800 | 1750 | 1750        | 3800 | 1750 | 3150       | 5700 | 1750 | 3150       | 5700 | 1750 |
| Capacity Analysis Module:                   |             |      |      |             |      |      |            |      |      |            |      |      |
| Vol/Sat:                                    | 0.11        | 0.08 | 0.13 | 0.14        | 0.18 | 0.20 | 0.13       | 0.31 | 0.14 | 0.16       | 0.24 | 0.24 |
| Crit Moves:                                 | ****        |      |      |             |      | **** | ****       |      |      | ****       |      |      |
| Green Time:                                 | 19.6        | 25.3 | 25.3 | 29.1        | 34.9 | 34.9 | 28.9       | 55.2 | 55.2 | 28.4       | 54.7 | 54.7 |
| Volume/Cap:                                 | 0.85        | 0.48 | 0.74 | 0.74        | 0.78 | 0.85 | 0.67       | 0.85 | 0.37 | 0.85       | 0.66 | 0.67 |
| Delay/Veh:                                  | 87.9        | 57.0 | 68.9 | 65.4        | 58.3 | 70.0 | 58.9       | 46.9 | 35.1 | 69.5       | 40.8 | 42.7 |
| User DelAdj:                                | 1.00        | 1.00 | 1.00 | 1.00        | 1.00 | 1.00 | 1.00       | 1.00 | 1.00 | 1.00       | 1.00 | 1.00 |
| AdjDel/Veh:                                 | 87.9        | 57.0 | 68.9 | 65.4        | 58.3 | 70.0 | 58.9       | 46.9 | 35.1 | 69.5       | 40.8 | 42.7 |
| LOS by Move:                                | F           | E    | E    | E           | E    | E    | E          | D    | D    | E          | D    | D    |
| HCM2k95thQ:                                 | 21          | 13   | 21   | 22          | 27   | 30   | 20         | 44   | 16   | 25         | 30   | 30   |

Note: Queue reported is the number of cars per lane.

BART

Level Of Service Computation Report  
2000 HCM Operations (Future Volume Alternative)  
AM - Cumulative With Project

Intersection #3683: McLAUGHLIN/STORY [Study Int 26]

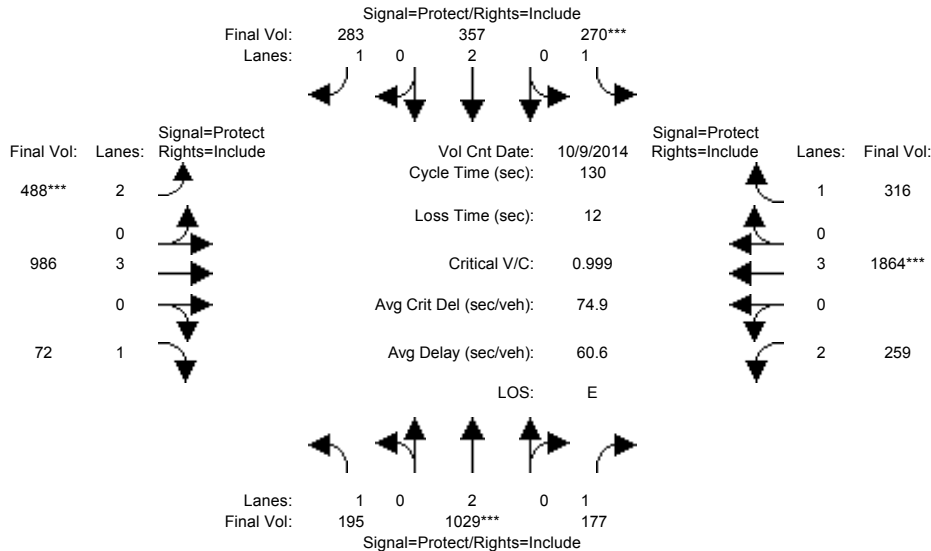

| Approach:                                   | North Bound |      |      | South Bound |      |      | East Bound |      |      | West Bound |      |      |
|---|-------------|------|------|-------------|------|------|------------|------|------|------------|------|------|
| Movement:                                   | L           | T    | R    | L           | T    | R    | L          | T    | R    | L          | T    | R    |
| Min. Green:                                 | 7           | 10   | 10   | 7           | 10   | 10   | 7          | 10   | 10   | 7          | 10   | 10   |
| Y+R:  | 4.0         | 4.0  | 4.0  | 4.0         | 4.0  | 4.0  | 4.0        | 4.0  | 4.0  | 4.0        | 4.0  | 4.0  |
| Volume Module: >> Count Date: 9 Oct 2014 << |             |      |      |             |      |      |            |      |      |            |      |      |
| Base Vol:                                   | 195         | 1029 | 177  | 270         | 357  | 283  | 488        | 986  | 72   | 259        | 1864 | 316  |
| Growth Adj:                                 | 1.00        | 1.00 | 1.00 | 1.00        | 1.00 | 1.00 | 1.00       | 1.00 | 1.00 | 1.00       | 1.00 | 1.00 |
| Initial Bse:                                | 195         | 1029 | 177  | 270         | 357  | 283  | 488        | 986  | 72   | 259        | 1864 | 316  |
| Added Vol:                                  | 0           | 0    | 0    | 0           | 0    | 0    | 0          | 0    | 0    | 0          | 0    | 0    |
| PasserByVol:                                | 0           | 0    | 0    | 0           | 0    | 0    | 0          | 0    | 0    | 0          | 0    | 0    |
| Initial Fut:                                | 195         | 1029 | 177  | 270         | 357  | 283  | 488        | 986  | 72   | 259        | 1864 | 316  |
| User Adj:                                   | 1.00        | 1.00 | 1.00 | 1.00        | 1.00 | 1.00 | 1.00       | 1.00 | 1.00 | 1.00       | 1.00 | 1.00 |
| PHF Adj:                                    | 1.00        | 1.00 | 1.00 | 1.00        | 1.00 | 1.00 | 1.00       | 1.00 | 1.00 | 1.00       | 1.00 | 1.00 |
| PHF Volume:                                 | 195         | 1029 | 177  | 270         | 357  | 283  | 488        | 986  | 72   | 259        | 1864 | 316  |
| Reduct Vol:                                 | 0           | 0    | 0    | 0           | 0    | 0    | 0          | 0    | 0    | 0          | 0    | 0    |
| Reduced Vol:                                | 195         | 1029 | 177  | 270         | 357  | 283  | 488        | 986  | 72   | 259        | 1864 | 316  |
| PCE Adj:                                    | 1.00        | 1.00 | 1.00 | 1.00        | 1.00 | 1.00 | 1.00       | 1.00 | 1.00 | 1.00       | 1.00 | 1.00 |
| MLF Adj:                                    | 1.00        | 1.00 | 1.00 | 1.00        | 1.00 | 1.00 | 1.00       | 1.00 | 1.00 | 1.00       | 1.00 | 1.00 |
| Final Volume:                               | 195         | 1029 | 177  | 270         | 357  | 283  | 488        | 986  | 72   | 259        | 1864 | 316  |
| Saturation Flow Module:                     |             |      |      |             |      |      |            |      |      |            |      |      |
| Sat/Lane:                                   | 1900        | 1900 | 1900 | 1900        | 1900 | 1900 | 1900       | 1900 | 1900 | 1900       | 1900 | 1900 |
| Adjustment:                                 | 0.92        | 1.00 | 0.92 | 0.92        | 1.00 | 0.92 | 0.83       | 1.00 | 0.92 | 0.83       | 1.00 | 0.92 |
| Lanes:                                      | 1.00        | 2.00 | 1.00 | 1.00        | 2.00 | 1.00 | 2.00       | 3.00 | 1.00 | 2.00       | 3.00 | 1.00 |
| Final Sat.:                                 | 1750        | 3800 | 1750 | 1750        | 3800 | 1750 | 3150       | 5700 | 1750 | 3150       | 5700 | 1750 |
| Capacity Analysis Module:                   |             |      |      |             |      |      |            |      |      |            |      |      |
| Vol/Sat:                                    | 0.11        | 0.27 | 0.10 | 0.15        | 0.09 | 0.16 | 0.15       | 0.17 | 0.04 | 0.08       | 0.33 | 0.18 |
| Crit Moves:                                 | ****        | **** | **** | ****        | **** | **** | ****       | **** | **** | ****       | **** | **** |
| Green Time:                                 | 22.6        | 35.2 | 35.2 | 20.1        | 32.7 | 32.7 | 20.2       | 42.5 | 42.5 | 20.2       | 42.5 | 42.5 |
| Volume/Cap:                                 | 0.64        | 1.00 | 0.37 | 1.00        | 0.37 | 0.64 | 1.00       | 0.53 | 0.13 | 0.53       | 1.00 | 0.55 |
| Delay/Veh:                                  | 54.6        | 75.2 | 38.9 | 109.5       | 40.4 | 46.6 | 95.4       | 35.9 | 30.8 | 51.6       | 64.4 | 37.1 |
| User DelAdj:                                | 1.00        | 1.00 | 1.00 | 1.00        | 1.00 | 1.00 | 1.00       | 1.00 | 1.00 | 1.00       | 1.00 | 1.00 |
| AdjDel/Veh:                                 | 54.6        | 75.2 | 38.9 | 109.5       | 40.4 | 46.6 | 95.4       | 35.9 | 30.8 | 51.6       | 64.4 | 37.1 |
| LOS by Move:                                | D           | E    | D    | F           | D    | D    | F          | D    | C    | D          | E    | D    |
| HCM2k95thQ:                                 | 16          | 43   | 12   | 26          | 11   | 20   | 29         | 20   | 4    | 11         | 48   | 20   |

Note: Queue reported is the number of cars per lane.

BART

Level Of Service Computation Report  
2000 HCM Operations (Future Volume Alternative)  
PM - Cumulative With Project

Intersection #3683: McLAUGHLIN/STORY [Study Int 26]

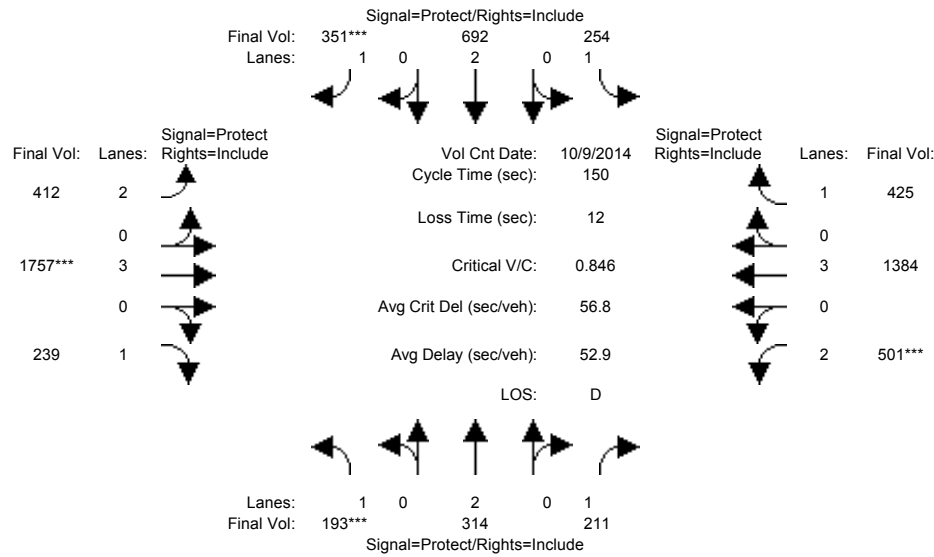

| Approach:                                   | North Bound |      |      | South Bound |      |      | East Bound |      |      | West Bound |      |      |
|---|-------------|------|------|-------------|------|------|------------|------|------|------------|------|------|
| Movement:                                   | L           | T    | R    | L           | T    | R    | L          | T    | R    | L          | T    | R    |
| Min. Green:                                 | 7           | 10   | 10   | 7           | 10   | 10   | 7          | 10   | 10   | 7          | 10   | 10   |
| Y+R:  | 4.0         | 4.0  | 4.0  | 4.0         | 4.0  | 4.0  | 4.0        | 4.0  | 4.0  | 4.0        | 4.0  | 4.0  |
| Volume Module: >> Count Date: 9 Oct 2014 << |             |      |      |             |      |      |            |      |      |            |      |      |
| Base Vol:                                   | 193         | 314  | 211  | 254         | 692  | 351  | 412        | 1757 | 239  | 501        | 1384 | 425  |
| Growth Adj:                                 | 1.00        | 1.00 | 1.00 | 1.00        | 1.00 | 1.00 | 1.00       | 1.00 | 1.00 | 1.00       | 1.00 | 1.00 |
| Initial Bse:                                | 193         | 314  | 211  | 254         | 692  | 351  | 412        | 1757 | 239  | 501        | 1384 | 425  |
| Added Vol:                                  | 0           | 0    | 0    | 0           | 0    | 0    | 0          | 0    | 0    | 0          | 0    | 0    |
| PasserByVol:                                | 0           | 0    | 0    | 0           | 0    | 0    | 0          | 0    | 0    | 0          | 0    | 0    |
| Initial Fut:                                | 193         | 314  | 211  | 254         | 692  | 351  | 412        | 1757 | 239  | 501        | 1384 | 425  |
| User Adj:                                   | 1.00        | 1.00 | 1.00 | 1.00        | 1.00 | 1.00 | 1.00       | 1.00 | 1.00 | 1.00       | 1.00 | 1.00 |
| PHF Adj:                                    | 1.00        | 1.00 | 1.00 | 1.00        | 1.00 | 1.00 | 1.00       | 1.00 | 1.00 | 1.00       | 1.00 | 1.00 |
| PHF Volume:                                 | 193         | 314  | 211  | 254         | 692  | 351  | 412        | 1757 | 239  | 501        | 1384 | 425  |
| Reduct Vol:                                 | 0           | 0    | 0    | 0           | 0    | 0    | 0          | 0    | 0    | 0          | 0    | 0    |
| Reduced Vol:                                | 193         | 314  | 211  | 254         | 692  | 351  | 412        | 1757 | 239  | 501        | 1384 | 425  |
| PCE Adj:                                    | 1.00        | 1.00 | 1.00 | 1.00        | 1.00 | 1.00 | 1.00       | 1.00 | 1.00 | 1.00       | 1.00 | 1.00 |
| MLF Adj:                                    | 1.00        | 1.00 | 1.00 | 1.00        | 1.00 | 1.00 | 1.00       | 1.00 | 1.00 | 1.00       | 1.00 | 1.00 |
| Final Volume:                               | 193         | 314  | 211  | 254         | 692  | 351  | 412        | 1757 | 239  | 501        | 1384 | 425  |
| Saturation Flow Module:                     |             |      |      |             |      |      |            |      |      |            |      |      |
| Sat/Lane:                                   | 1900        | 1900 | 1900 | 1900        | 1900 | 1900 | 1900       | 1900 | 1900 | 1900       | 1900 | 1900 |
| Adjustment:                                 | 0.92        | 1.00 | 0.92 | 0.92        | 1.00 | 0.92 | 0.83       | 1.00 | 0.92 | 0.83       | 1.00 | 0.92 |
| Lanes:                                      | 1.00        | 2.00 | 1.00 | 1.00        | 2.00 | 1.00 | 2.00       | 3.00 | 1.00 | 2.00       | 3.00 | 1.00 |
| Final Sat.:                                 | 1750        | 3800 | 1750 | 1750        | 3800 | 1750 | 3150       | 5700 | 1750 | 3150       | 5700 | 1750 |
| Capacity Analysis Module:                   |             |      |      |             |      |      |            |      |      |            |      |      |
| Vol/Sat:                                    | 0.11        | 0.08 | 0.12 | 0.15        | 0.18 | 0.20 | 0.13       | 0.31 | 0.14 | 0.16       | 0.24 | 0.24 |
| Crit Moves:                                 | ****        |      |      | ****        |      |      | ****       |      |      | ****       |      |      |
| Green Time:                                 | 19.6        | 25.0 | 25.0 | 30.1        | 35.6 | 35.6 | 29.0       | 54.7 | 54.7 | 28.2       | 53.9 | 53.9 |
| Volume/Cap:                                 | 0.85        | 0.50 | 0.72 | 0.72        | 0.77 | 0.85 | 0.68       | 0.85 | 0.37 | 0.85       | 0.68 | 0.68 |
| Delay/Veh:                                  | 87.9        | 57.4 | 67.8 | 63.3        | 57.4 | 69.4 | 59.2       | 47.2 | 35.5 | 69.7       | 41.6 | 43.6 |
| User DelAdj:                                | 1.00        | 1.00 | 1.00 | 1.00        | 1.00 | 1.00 | 1.00       | 1.00 | 1.00 | 1.00       | 1.00 | 1.00 |
| AdjDel/Veh:                                 | 87.9        | 57.4 | 67.8 | 63.3        | 57.4 | 69.4 | 59.2       | 47.2 | 35.5 | 69.7       | 41.6 | 43.6 |
| LOS by Move:                                | F           | E    | E    | E           | E    | E    | E          | D    | D    | E          | D    | D    |
| HCM2k95thQ:                                 | 21          | 13   | 20   | 22          | 27   | 30   | 21         | 44   | 16   | 25         | 31   | 31   |

Note: Queue reported is the number of cars per lane.

BART

Level Of Service Computation Report  
 2000 HCM Operations (Future Volume Alternative)  
 AM - Cumulative No Project

Intersection #3762: SAN ANTONIO/24TH [Study Int 21]

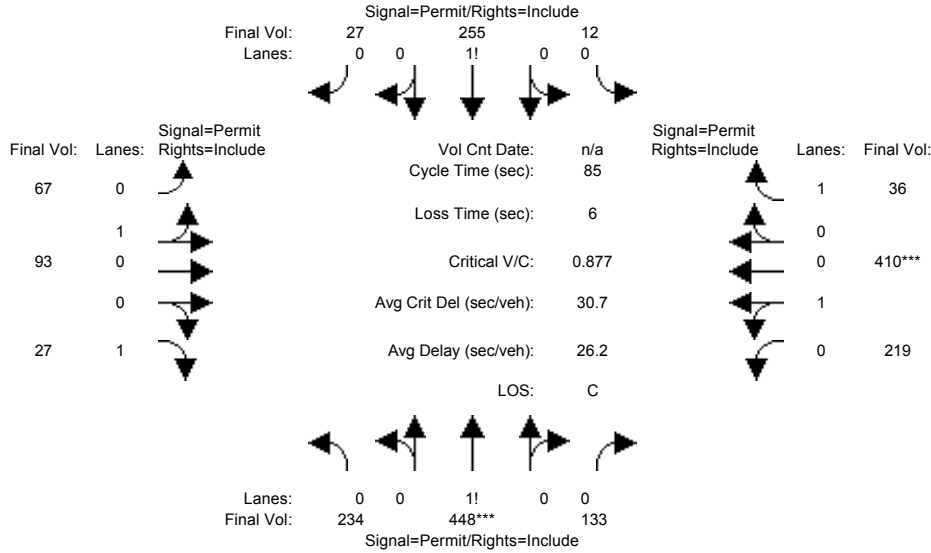

| Approach:                 | North Bound |      |      | South Bound |      |      | East Bound |      |      | West Bound |      |      |
|---------------------------|-------------|------|------|-------------|------|------|------------|------|------|------------|------|------|
| Movement:                 | L           | T    | R    | L           | T    | R    | L          | T    | R    | L          | T    | R    |
| Min. Green:               | 10          | 10   | 10   | 10          | 10   | 10   | 10         | 10   | 10   | 10         | 10   | 10   |
| Y+R:                      | 4.0         | 4.0  | 4.0  | 4.0         | 4.0  | 4.0  | 4.0        | 4.0  | 4.0  | 4.0        | 4.0  | 4.0  |
| Volume Module:            |             |      |      |             |      |      |            |      |      |            |      |      |
| Base Vol:                 | 234         | 448  | 133  | 12          | 255  | 27   | 67         | 93   | 27   | 219        | 410  | 36   |
| Growth Adj:               | 1.00        | 1.00 | 1.00 | 1.00        | 1.00 | 1.00 | 1.00       | 1.00 | 1.00 | 1.00       | 1.00 | 1.00 |
| Initial Bse:              | 234         | 448  | 133  | 12          | 255  | 27   | 67         | 93   | 27   | 219        | 410  | 36   |
| Added Vol:                | 0           | 0    | 0    | 0           | 0    | 0    | 0          | 0    | 0    | 0          | 0    | 0    |
| PasserByVol:              | 0           | 0    | 0    | 0           | 0    | 0    | 0          | 0    | 0    | 0          | 0    | 0    |
| Initial Fut:              | 234         | 448  | 133  | 12          | 255  | 27   | 67         | 93   | 27   | 219        | 410  | 36   |
| User Adj:                 | 1.00        | 1.00 | 1.00 | 1.00        | 1.00 | 1.00 | 1.00       | 1.00 | 1.00 | 1.00       | 1.00 | 1.00 |
| PHF Adj:                  | 1.00        | 1.00 | 1.00 | 1.00        | 1.00 | 1.00 | 1.00       | 1.00 | 1.00 | 1.00       | 1.00 | 1.00 |
| PHF Volume:               | 234         | 448  | 133  | 12          | 255  | 27   | 67         | 93   | 27   | 219        | 410  | 36   |
| Reduct Vol:               | 0           | 0    | 0    | 0           | 0    | 0    | 0          | 0    | 0    | 0          | 0    | 0    |
| Reduced Vol:              | 234         | 448  | 133  | 12          | 255  | 27   | 67         | 93   | 27   | 219        | 410  | 36   |
| PCE Adj:                  | 1.00        | 1.00 | 1.00 | 1.00        | 1.00 | 1.00 | 1.00       | 1.00 | 1.00 | 1.00       | 1.00 | 1.00 |
| MLF Adj:                  | 1.00        | 1.00 | 1.00 | 1.00        | 1.00 | 1.00 | 1.00       | 1.00 | 1.00 | 1.00       | 1.00 | 1.00 |
| FinalVolume:              | 234         | 448  | 133  | 12          | 255  | 27   | 67         | 93   | 27   | 219        | 410  | 36   |
| Saturation Flow Module:   |             |      |      |             |      |      |            |      |      |            |      |      |
| Sat/Lane:                 | 1900        | 1900 | 1900 | 1900        | 1900 | 1900 | 1900       | 1900 | 1900 | 1900       | 1900 | 1900 |
| Adjustment:               | 0.92        | 0.92 | 0.92 | 0.92        | 0.92 | 0.92 | 0.95       | 0.95 | 0.92 | 0.95       | 0.95 | 0.92 |
| Lanes:                    | 0.29        | 0.55 | 0.16 | 0.04        | 0.87 | 0.09 | 0.42       | 0.58 | 1.00 | 0.35       | 0.65 | 1.00 |
| Final Sat.:               | 502         | 962  | 286  | 71          | 1518 | 161  | 754        | 1046 | 1750 | 627        | 1173 | 1750 |
| Capacity Analysis Module: |             |      |      |             |      |      |            |      |      |            |      |      |
| Vol/Sat:                  | 0.47        | 0.47 | 0.47 | 0.17        | 0.17 | 0.17 | 0.09       | 0.09 | 0.02 | 0.35       | 0.35 | 0.02 |
| Crit Moves:               | ****        |      |      |             |      |      |            |      |      | ****       |      |      |
| Green Time:               | 45.1        | 45.1 | 45.1 | 45.1        | 45.1 | 45.1 | 33.9       | 33.9 | 33.9 | 33.9       | 33.9 | 33.9 |
| Volume/Cap:               | 0.88        | 0.88 | 0.88 | 0.32        | 0.32 | 0.32 | 0.22       | 0.22 | 0.04 | 0.88       | 0.88 | 0.05 |
| Delay/Veh:                | 27.0        | 27.0 | 27.0 | 11.4        | 11.4 | 11.4 | 17.0       | 17.0 | 15.6 | 35.5       | 35.5 | 15.7 |
| User DelAdj:              | 1.00        | 1.00 | 1.00 | 1.00        | 1.00 | 1.00 | 1.00       | 1.00 | 1.00 | 1.00       | 1.00 | 1.00 |
| AdjDel/Veh:               | 27.0        | 27.0 | 27.0 | 11.4        | 11.4 | 11.4 | 17.0       | 17.0 | 15.6 | 35.5       | 35.5 | 15.7 |
| LOS by Move:              | C           | C    | C    | B           | B    | B    | B          | B    | B    | D          | D    | B    |
| HCM2k95thQ:               | 36          | 36   | 36   | 9           | 9    | 9    | 6          | 6    | 1    | 30         | 30   | 1    |

Note: Queue reported is the number of cars per lane.



BART

Level Of Service Computation Report  
 2000 HCM Operations (Future Volume Alternative)  
 PM - Cumulative No Project

Intersection #3762: SAN ANTONIO/24TH [Study Int 21]

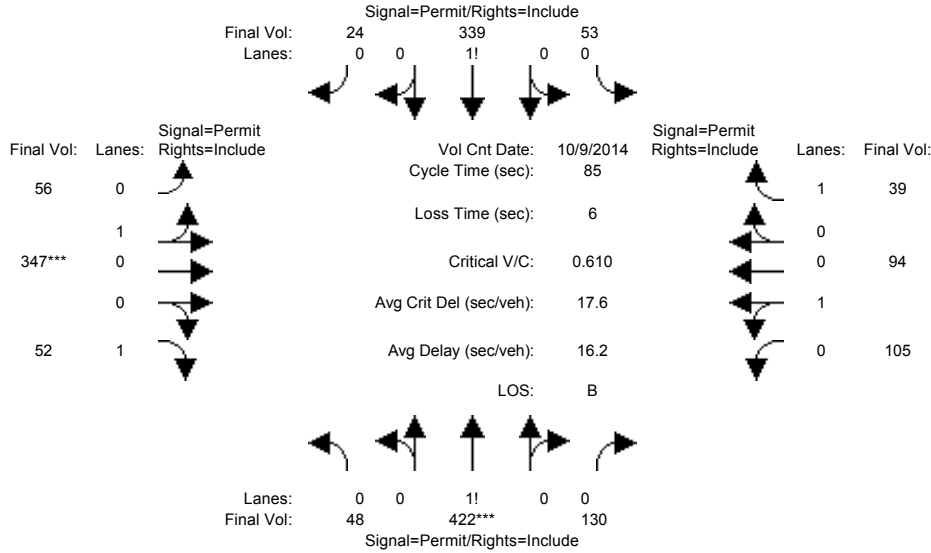

| Approach:                                   | North Bound |      |      | South Bound |      |      | East Bound |      |      | West Bound |      |      |
|---|-------------|------|------|-------------|------|------|------------|------|------|------------|------|------|
| Movement:                                   | L           | T    | R    | L           | T    | R    | L          | T    | R    | L          | T    | R    |
| Min. Green:                                 | 10          | 10   | 10   | 10          | 10   | 10   | 10         | 10   | 10   | 10         | 10   | 10   |
| Y+R:  | 4.0         | 4.0  | 4.0  | 4.0         | 4.0  | 4.0  | 4.0        | 4.0  | 4.0  | 4.0        | 4.0  | 4.0  |
| Volume Module: >> Count Date: 9 Oct 2014 << |             |      |      |             |      |      |            |      |      |            |      |      |
| Base Vol:                                   | 48          | 422  | 130  | 53          | 339  | 24   | 56         | 347  | 52   | 105        | 94   | 39   |
| Growth Adj:                                 | 1.00        | 1.00 | 1.00 | 1.00        | 1.00 | 1.00 | 1.00       | 1.00 | 1.00 | 1.00       | 1.00 | 1.00 |
| Initial Bse:                                | 48          | 422  | 130  | 53          | 339  | 24   | 56         | 347  | 52   | 105        | 94   | 39   |
| Added Vol:                                  | 0           | 0    | 0    | 0           | 0    | 0    | 0          | 0    | 0    | 0          | 0    | 0    |
| PasserByVol:                                | 0           | 0    | 0    | 0           | 0    | 0    | 0          | 0    | 0    | 0          | 0    | 0    |
| Initial Fut:                                | 48          | 422  | 130  | 53          | 339  | 24   | 56         | 347  | 52   | 105        | 94   | 39   |
| User Adj:                                   | 1.00        | 1.00 | 1.00 | 1.00        | 1.00 | 1.00 | 1.00       | 1.00 | 1.00 | 1.00       | 1.00 | 1.00 |
| PHF Adj:                                    | 1.00        | 1.00 | 1.00 | 1.00        | 1.00 | 1.00 | 1.00       | 1.00 | 1.00 | 1.00       | 1.00 | 1.00 |
| PHF Volume:                                 | 48          | 422  | 130  | 53          | 339  | 24   | 56         | 347  | 52   | 105        | 94   | 39   |
| Reduct Vol:                                 | 0           | 0    | 0    | 0           | 0    | 0    | 0          | 0    | 0    | 0          | 0    | 0    |
| Reduced Vol:                                | 48          | 422  | 130  | 53          | 339  | 24   | 56         | 347  | 52   | 105        | 94   | 39   |
| PCE Adj:                                    | 1.00        | 1.00 | 1.00 | 1.00        | 1.00 | 1.00 | 1.00       | 1.00 | 1.00 | 1.00       | 1.00 | 1.00 |
| MLF Adj:                                    | 1.00        | 1.00 | 1.00 | 1.00        | 1.00 | 1.00 | 1.00       | 1.00 | 1.00 | 1.00       | 1.00 | 1.00 |
| Final Volume:                               | 48          | 422  | 130  | 53          | 339  | 24   | 56         | 347  | 52   | 105        | 94   | 39   |
| Saturation Flow Module:                     |             |      |      |             |      |      |            |      |      |            |      |      |
| Sat/Lane:                                   | 1900        | 1900 | 1900 | 1900        | 1900 | 1900 | 1900       | 1900 | 1900 | 1900       | 1900 | 1900 |
| Adjustment:                                 | 0.92        | 0.92 | 0.92 | 0.92        | 0.92 | 0.92 | 0.95       | 0.95 | 0.92 | 0.95       | 0.95 | 0.92 |
| Lanes:                                      | 0.08        | 0.70 | 0.22 | 0.13        | 0.81 | 0.06 | 0.14       | 0.86 | 1.00 | 0.53       | 0.47 | 1.00 |
| Final Sat.:                                 | 140         | 1231 | 379  | 223         | 1426 | 101  | 250        | 1550 | 1750 | 950        | 850  | 1750 |
| Capacity Analysis Module:                   |             |      |      |             |      |      |            |      |      |            |      |      |
| Vol/Sat:                                    | 0.34        | 0.34 | 0.34 | 0.24        | 0.24 | 0.24 | 0.22       | 0.22 | 0.03 | 0.11       | 0.11 | 0.02 |
| Crit Moves:                                 | ****        |      |      | ****        |      |      | ****       |      |      | ****       |      |      |
| Green Time:                                 | 47.8        | 47.8 | 47.8 | 47.8        | 47.8 | 47.8 | 31.2       | 31.2 | 31.2 | 31.2       | 31.2 | 31.2 |
| Volume/Cap:                                 | 0.61        | 0.61 | 0.61 | 0.42        | 0.42 | 0.42 | 0.61       | 0.61 | 0.08 | 0.30       | 0.30 | 0.06 |
| Delay/Veh:                                  | 13.5        | 13.5 | 13.5 | 11.0        | 11.0 | 11.0 | 23.6       | 23.6 | 17.6 | 19.4       | 19.4 | 17.4 |
| User DelAdj:                                | 1.00        | 1.00 | 1.00 | 1.00        | 1.00 | 1.00 | 1.00       | 1.00 | 1.00 | 1.00       | 1.00 | 1.00 |
| AdjDel/Veh:                                 | 13.5        | 13.5 | 13.5 | 11.0        | 11.0 | 11.0 | 23.6       | 23.6 | 17.6 | 19.4       | 19.4 | 17.4 |
| LOS by Move:                                | B           | B    | B    | B           | B    | B    | C          | C    | B    | B          | B    | B    |
| HCM2k95thQ:                                 | 20          | 20   | 20   | 13          | 13   | 13   | 18         | 18   | 2    | 7          | 7    | 1    |

Note: Queue reported is the number of cars per lane.

BART

Level Of Service Computation Report  
 2000 HCM Operations (Future Volume Alternative)  
 AM - Cumulative With Project

Intersection #3762: SAN ANTONIO/24TH [Study Int 21]

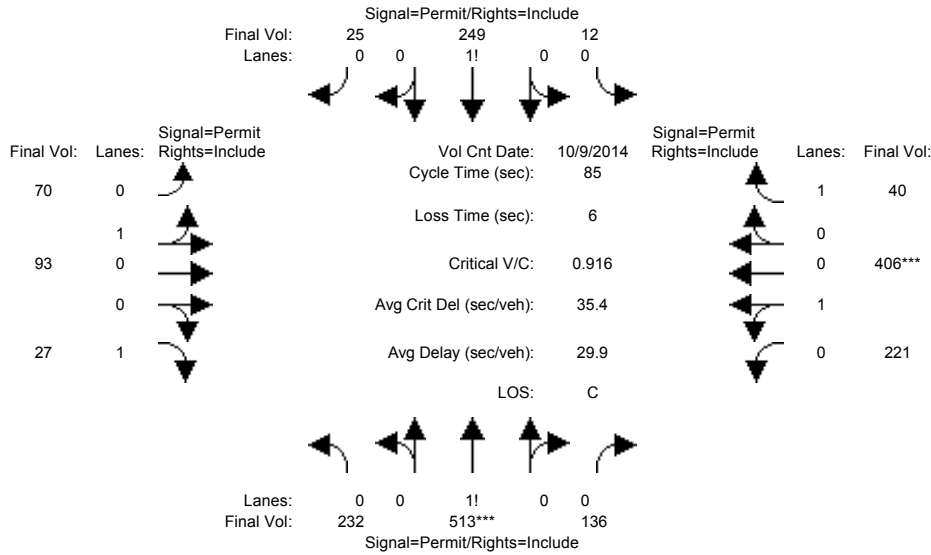

| Approach:                                   | North Bound |      |      | South Bound |      |      | East Bound |      |      | West Bound |      |      |
|---|-------------|------|------|-------------|------|------|------------|------|------|------------|------|------|
| Movement:                                   | L           | T    | R    | L           | T    | R    | L          | T    | R    | L          | T    | R    |
| Min. Green:                                 | 10          | 10   | 10   | 10          | 10   | 10   | 10         | 10   | 10   | 10         | 10   | 10   |
| Y+R:  | 4.0         | 4.0  | 4.0  | 4.0         | 4.0  | 4.0  | 4.0        | 4.0  | 4.0  | 4.0        | 4.0  | 4.0  |
| Volume Module: >> Count Date: 9 Oct 2014 << |             |      |      |             |      |      |            |      |      |            |      |      |
| Base Vol:                                   | 232         | 513  | 136  | 12          | 249  | 25   | 70         | 93   | 27   | 221        | 406  | 40   |
| Growth Adj:                                 | 1.00        | 1.00 | 1.00 | 1.00        | 1.00 | 1.00 | 1.00       | 1.00 | 1.00 | 1.00       | 1.00 | 1.00 |
| Initial Bse:                                | 232         | 513  | 136  | 12          | 249  | 25   | 70         | 93   | 27   | 221        | 406  | 40   |
| Added Vol:                                  | 0           | 0    | 0    | 0           | 0    | 0    | 0          | 0    | 0    | 0          | 0    | 0    |
| PasserByVol:                                | 0           | 0    | 0    | 0           | 0    | 0    | 0          | 0    | 0    | 0          | 0    | 0    |
| Initial Fut:                                | 232         | 513  | 136  | 12          | 249  | 25   | 70         | 93   | 27   | 221        | 406  | 40   |
| User Adj:                                   | 1.00        | 1.00 | 1.00 | 1.00        | 1.00 | 1.00 | 1.00       | 1.00 | 1.00 | 1.00       | 1.00 | 1.00 |
| PHF Adj:                                    | 1.00        | 1.00 | 1.00 | 1.00        | 1.00 | 1.00 | 1.00       | 1.00 | 1.00 | 1.00       | 1.00 | 1.00 |
| PHF Volume:                                 | 232         | 513  | 136  | 12          | 249  | 25   | 70         | 93   | 27   | 221        | 406  | 40   |
| Reduct Vol:                                 | 0           | 0    | 0    | 0           | 0    | 0    | 0          | 0    | 0    | 0          | 0    | 0    |
| Reduced Vol:                                | 232         | 513  | 136  | 12          | 249  | 25   | 70         | 93   | 27   | 221        | 406  | 40   |
| PCE Adj:                                    | 1.00        | 1.00 | 1.00 | 1.00        | 1.00 | 1.00 | 1.00       | 1.00 | 1.00 | 1.00       | 1.00 | 1.00 |
| MLF Adj:                                    | 1.00        | 1.00 | 1.00 | 1.00        | 1.00 | 1.00 | 1.00       | 1.00 | 1.00 | 1.00       | 1.00 | 1.00 |
| Final Volume:                               | 232         | 513  | 136  | 12          | 249  | 25   | 70         | 93   | 27   | 221        | 406  | 40   |
| Saturation Flow Module:                     |             |      |      |             |      |      |            |      |      |            |      |      |
| Sat/Lane:                                   | 1900        | 1900 | 1900 | 1900        | 1900 | 1900 | 1900       | 1900 | 1900 | 1900       | 1900 | 1900 |
| Adjustment:                                 | 0.92        | 0.92 | 0.92 | 0.92        | 0.92 | 0.92 | 0.95       | 0.95 | 0.92 | 0.95       | 0.95 | 0.92 |
| Lanes:                                      | 0.26        | 0.59 | 0.15 | 0.04        | 0.87 | 0.09 | 0.43       | 0.57 | 1.00 | 0.35       | 0.65 | 1.00 |
| Final Sat.:                                 | 461         | 1019 | 270  | 73          | 1524 | 153  | 773        | 1027 | 1750 | 634        | 1166 | 1750 |
| Capacity Analysis Module:                   |             |      |      |             |      |      |            |      |      |            |      |      |
| Vol/Sat:                                    | 0.50        | 0.50 | 0.50 | 0.16        | 0.16 | 0.16 | 0.09       | 0.09 | 0.02 | 0.35       | 0.35 | 0.02 |
| Crit Moves:                                 | ****        |      |      |             |      |      |            |      |      |            |      |      |
| Green Time:                                 | 46.7        | 46.7 | 46.7 | 46.7        | 46.7 | 46.7 | 32.3       | 32.3 | 32.3 | 32.3       | 32.3 | 32.3 |
| Volume/Cap:                                 | 0.92        | 0.92 | 0.92 | 0.30        | 0.30 | 0.30 | 0.24       | 0.24 | 0.04 | 0.92       | 0.92 | 0.06 |
| Delay/Veh:                                  | 30.6        | 30.6 | 30.6 | 10.5        | 10.5 | 10.5 | 18.1       | 18.1 | 16.6 | 42.2       | 42.2 | 16.8 |
| User DelAdj:                                | 1.00        | 1.00 | 1.00 | 1.00        | 1.00 | 1.00 | 1.00       | 1.00 | 1.00 | 1.00       | 1.00 | 1.00 |
| AdjDel/Veh:                                 | 30.6        | 30.6 | 30.6 | 10.5        | 10.5 | 10.5 | 18.1       | 18.1 | 16.6 | 42.2       | 42.2 | 16.8 |
| LOS by Move:                                | C           | C    | C    | B           | B    | B    | B          | B    | B    | D          | D    | B    |
| HCM2k95thQ:                                 | 41          | 41   | 41   | 9           | 9    | 9    | 6          | 6    | 1    | 32         | 32   | 1    |

Note: Queue reported is the number of cars per lane.

BART

Level Of Service Computation Report  
 2000 HCM Operations (Future Volume Alternative)  
 PM - Cumulative With Project

Intersection #3762: SAN ANTONIO/24TH [Study Int 21]

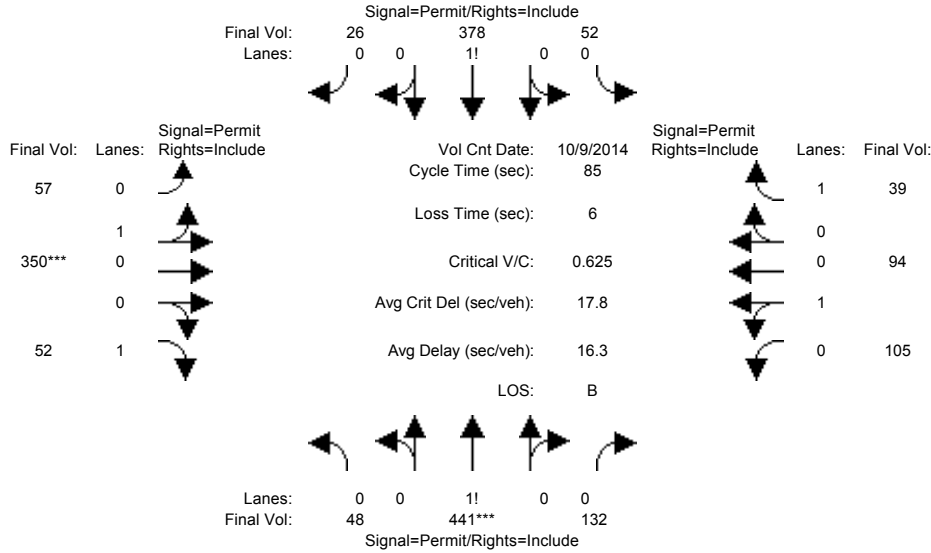

| Approach:                                   | North Bound |      |      | South Bound |      |      | East Bound |      |      | West Bound |      |      |
|---|-------------|------|------|-------------|------|------|------------|------|------|------------|------|------|
| Movement:                                   | L           | T    | R    | L           | T    | R    | L          | T    | R    | L          | T    | R    |
| Min. Green:                                 | 10          | 10   | 10   | 10          | 10   | 10   | 10         | 10   | 10   | 10         | 10   | 10   |
| Y+R:  | 4.0         | 4.0  | 4.0  | 4.0         | 4.0  | 4.0  | 4.0        | 4.0  | 4.0  | 4.0        | 4.0  | 4.0  |
| Volume Module: >> Count Date: 9 Oct 2014 << |             |      |      |             |      |      |            |      |      |            |      |      |
| Base Vol:                                   | 48          | 441  | 132  | 52          | 378  | 26   | 57         | 350  | 52   | 105        | 94   | 39   |
| Growth Adj:                                 | 1.00        | 1.00 | 1.00 | 1.00        | 1.00 | 1.00 | 1.00       | 1.00 | 1.00 | 1.00       | 1.00 | 1.00 |
| Initial Bse:                                | 48          | 441  | 132  | 52          | 378  | 26   | 57         | 350  | 52   | 105        | 94   | 39   |
| Added Vol:                                  | 0           | 0    | 0    | 0           | 0    | 0    | 0          | 0    | 0    | 0          | 0    | 0    |
| PasserByVol:                                | 0           | 0    | 0    | 0           | 0    | 0    | 0          | 0    | 0    | 0          | 0    | 0    |
| Initial Fut:                                | 48          | 441  | 132  | 52          | 378  | 26   | 57         | 350  | 52   | 105        | 94   | 39   |
| User Adj:                                   | 1.00        | 1.00 | 1.00 | 1.00        | 1.00 | 1.00 | 1.00       | 1.00 | 1.00 | 1.00       | 1.00 | 1.00 |
| PHF Adj:                                    | 1.00        | 1.00 | 1.00 | 1.00        | 1.00 | 1.00 | 1.00       | 1.00 | 1.00 | 1.00       | 1.00 | 1.00 |
| PHF Volume:                                 | 48          | 441  | 132  | 52          | 378  | 26   | 57         | 350  | 52   | 105        | 94   | 39   |
| Reduct Vol:                                 | 0           | 0    | 0    | 0           | 0    | 0    | 0          | 0    | 0    | 0          | 0    | 0    |
| Reduced Vol:                                | 48          | 441  | 132  | 52          | 378  | 26   | 57         | 350  | 52   | 105        | 94   | 39   |
| PCE Adj:                                    | 1.00        | 1.00 | 1.00 | 1.00        | 1.00 | 1.00 | 1.00       | 1.00 | 1.00 | 1.00       | 1.00 | 1.00 |
| MLF Adj:                                    | 1.00        | 1.00 | 1.00 | 1.00        | 1.00 | 1.00 | 1.00       | 1.00 | 1.00 | 1.00       | 1.00 | 1.00 |
| Final Volume:                               | 48          | 441  | 132  | 52          | 378  | 26   | 57         | 350  | 52   | 105        | 94   | 39   |
| Saturation Flow Module:                     |             |      |      |             |      |      |            |      |      |            |      |      |
| Sat/Lane:                                   | 1900        | 1900 | 1900 | 1900        | 1900 | 1900 | 1900       | 1900 | 1900 | 1900       | 1900 | 1900 |
| Adjustment:                                 | 0.92        | 0.92 | 0.92 | 0.92        | 0.92 | 0.92 | 0.95       | 0.95 | 0.92 | 0.95       | 0.95 | 0.92 |
| Lanes:                                      | 0.08        | 0.71 | 0.21 | 0.11        | 0.83 | 0.06 | 0.14       | 0.86 | 1.00 | 0.53       | 0.47 | 1.00 |
| Final Sat.:                                 | 135         | 1243 | 372  | 200         | 1451 | 100  | 252        | 1548 | 1750 | 950        | 850  | 1750 |
| Capacity Analysis Module:                   |             |      |      |             |      |      |            |      |      |            |      |      |
| Vol/Sat:                                    | 0.35        | 0.35 | 0.35 | 0.26        | 0.26 | 0.26 | 0.23       | 0.23 | 0.03 | 0.11       | 0.11 | 0.02 |
| Crit Moves:                                 | ****        |      |      | ****        |      |      | ****       |      |      | ****       |      |      |
| Green Time:                                 | 48.3        | 48.3 | 48.3 | 48.3        | 48.3 | 48.3 | 30.7       | 30.7 | 30.7 | 30.7       | 30.7 | 30.7 |
| Volume/Cap:                                 | 0.63        | 0.63 | 0.63 | 0.46        | 0.46 | 0.46 | 0.63       | 0.63 | 0.08 | 0.31       | 0.31 | 0.06 |
| Delay/Veh:                                  | 13.6        | 13.6 | 13.6 | 11.1        | 11.1 | 11.1 | 24.3       | 24.3 | 17.9 | 19.7       | 19.7 | 17.8 |
| User DelAdj:                                | 1.00        | 1.00 | 1.00 | 1.00        | 1.00 | 1.00 | 1.00       | 1.00 | 1.00 | 1.00       | 1.00 | 1.00 |
| AdjDel/Veh:                                 | 13.6        | 13.6 | 13.6 | 11.1        | 11.1 | 11.1 | 24.3       | 24.3 | 17.9 | 19.7       | 19.7 | 17.8 |
| LOS by Move:                                | B           | B    | B    | B           | B    | B    | C          | C    | B    | B          | B    | B    |
| HCM2k95thQ:                                 | 21          | 21   | 21   | 15          | 15   | 15   | 18         | 18   | 2    | 8          | 8    | 1    |

Note: Queue reported is the number of cars per lane.

BART

Level Of Service Computation Report  
 2000 HCM Operations (Future Volume Alternative)  
 AM - Cumulative No Project

Intersection #3783: SANTA CLARA/17TH [Study Int 9]

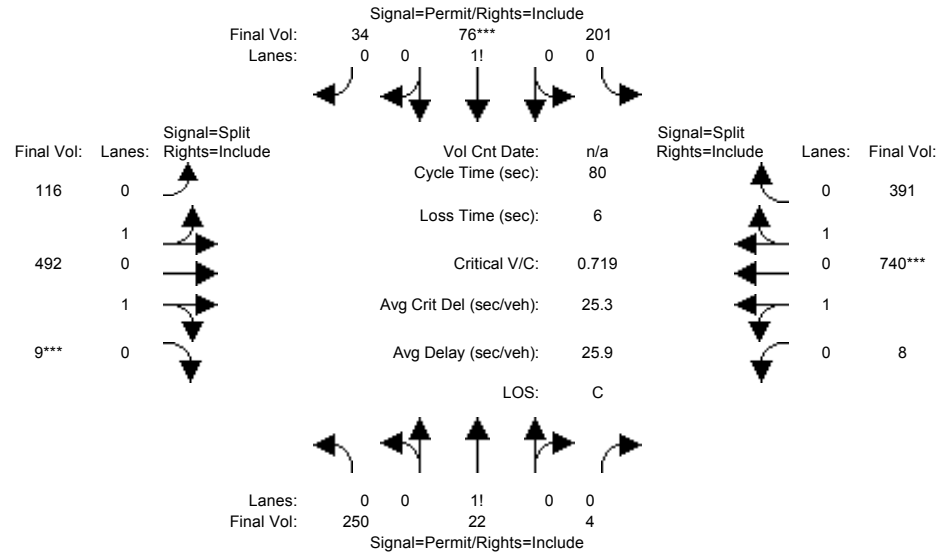

| Approach:                 | North Bound |      |      | South Bound |      |      | East Bound |      |      | West Bound |      |      |
|---------------------------|-------------|------|------|-------------|------|------|------------|------|------|------------|------|------|
| Movement:                 | L           | T    | R    | L           | T    | R    | L          | T    | R    | L          | T    | R    |
| Min. Green:               | 10          | 10   | 10   | 10          | 10   | 10   | 10         | 10   | 10   | 10         | 10   | 10   |
| Y+R:                      | 4.0         | 4.0  | 4.0  | 4.0         | 4.0  | 4.0  | 4.0        | 4.0  | 4.0  | 4.0        | 4.0  | 4.0  |
| Volume Module:            |             |      |      |             |      |      |            |      |      |            |      |      |
| Base Vol:                 | 250         | 22   | 4    | 201         | 76   | 34   | 116        | 492  | 9    | 8          | 740  | 391  |
| Growth Adj:               | 1.00        | 1.00 | 1.00 | 1.00        | 1.00 | 1.00 | 1.00       | 1.00 | 1.00 | 1.00       | 1.00 | 1.00 |
| Initial Bse:              | 250         | 22   | 4    | 201         | 76   | 34   | 116        | 492  | 9    | 8          | 740  | 391  |
| Added Vol:                | 0           | 0    | 0    | 0           | 0    | 0    | 0          | 0    | 0    | 0          | 0    | 0    |
| PasserByVol:              | 0           | 0    | 0    | 0           | 0    | 0    | 0          | 0    | 0    | 0          | 0    | 0    |
| Initial Fut:              | 250         | 22   | 4    | 201         | 76   | 34   | 116        | 492  | 9    | 8          | 740  | 391  |
| User Adj:                 | 1.00        | 1.00 | 1.00 | 1.00        | 1.00 | 1.00 | 1.00       | 1.00 | 1.00 | 1.00       | 1.00 | 1.00 |
| PHF Adj:                  | 1.00        | 1.00 | 1.00 | 1.00        | 1.00 | 1.00 | 1.00       | 1.00 | 1.00 | 1.00       | 1.00 | 1.00 |
| PHF Volume:               | 250         | 22   | 4    | 201         | 76   | 34   | 116        | 492  | 9    | 8          | 740  | 391  |
| Reduct Vol:               | 0           | 0    | 0    | 0           | 0    | 0    | 0          | 0    | 0    | 0          | 0    | 0    |
| Reduced Vol:              | 250         | 22   | 4    | 201         | 76   | 34   | 116        | 492  | 9    | 8          | 740  | 391  |
| PCE Adj:                  | 1.00        | 1.00 | 1.00 | 1.00        | 1.00 | 1.00 | 1.00       | 1.00 | 1.00 | 1.00       | 1.00 | 1.00 |
| MLF Adj:                  | 1.00        | 1.00 | 1.00 | 1.00        | 1.00 | 1.00 | 1.00       | 1.00 | 1.00 | 1.00       | 1.00 | 1.00 |
| Final Volume:             | 250         | 22   | 4    | 201         | 76   | 34   | 116        | 492  | 9    | 8          | 740  | 391  |
| Saturation Flow Module:   |             |      |      |             |      |      |            |      |      |            |      |      |
| Sat/Lane:                 | 1900        | 1900 | 1900 | 1900        | 1900 | 1900 | 1900       | 1900 | 1900 | 1900       | 1900 | 1900 |
| Adjustment:               | 0.92        | 0.92 | 0.92 | 0.92        | 0.92 | 0.92 | 0.95       | 0.95 | 0.95 | 0.95       | 0.95 | 0.95 |
| Lanes:                    | 0.91        | 0.08 | 0.01 | 0.65        | 0.24 | 0.11 | 0.38       | 1.59 | 0.03 | 0.01       | 1.30 | 0.69 |
| Final Sat.:               | 1585        | 139  | 25   | 1131        | 428  | 191  | 677        | 2871 | 53   | 25         | 2339 | 1236 |
| Capacity Analysis Module: |             |      |      |             |      |      |            |      |      |            |      |      |
| Vol/Sat:                  | 0.16        | 0.16 | 0.16 | 0.18        | 0.18 | 0.18 | 0.17       | 0.17 | 0.17 | 0.32       | 0.32 | 0.32 |
| Crit Moves:               | *****       |      |      | *****       |      |      | *****      |      |      | *****      |      |      |
| Green Time:               | 19.8        | 19.8 | 19.8 | 19.8        | 19.8 | 19.8 | 19.1       | 19.1 | 19.1 | 35.2       | 35.2 | 35.2 |
| Volume/Cap:               | 0.64        | 0.64 | 0.64 | 0.72        | 0.72 | 0.72 | 0.72       | 0.72 | 0.72 | 0.72       | 0.72 | 0.72 |
| Delay/Veh:                | 30.1        | 30.1 | 30.1 | 33.4        | 33.4 | 33.4 | 31.0       | 31.0 | 31.0 | 20.0       | 20.0 | 20.0 |
| User DelAdj:              | 1.00        | 1.00 | 1.00 | 1.00        | 1.00 | 1.00 | 1.00       | 1.00 | 1.00 | 1.00       | 1.00 | 1.00 |
| AdjDel/Veh:               | 30.1        | 30.1 | 30.1 | 33.4        | 33.4 | 33.4 | 31.0       | 31.0 | 31.0 | 20.0       | 20.0 | 20.0 |
| LOS by Move:              | C           | C    | C    | C           | C    | C    | C          | C    | C    | B          | B    | B    |
| HCM2k95thQ:               | 14          | 14   | 14   | 17          | 17   | 17   | 17         | 17   | 17   | 22         | 22   | 22   |

Note: Queue reported is the number of cars per lane.

BART

Level Of Service Computation Report  
2000 HCM Operations (Future Volume Alternative)  
PM - Cumulative No Project

Intersection #3783: SANTA CLARA/17TH [Study Int 9]

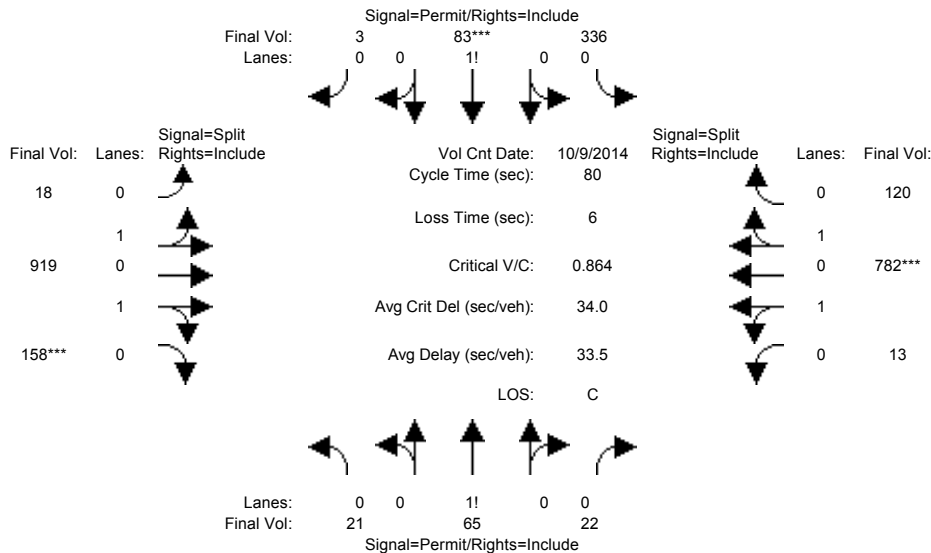

| Approach:                                   | North Bound |      |      | South Bound |      |      | East Bound |      |      | West Bound |      |      |
|---|-------------|------|------|-------------|------|------|------------|------|------|------------|------|------|
| Movement:                                   | L           | T    | R    | L           | T    | R    | L          | T    | R    | L          | T    | R    |
| Min. Green:                                 | 10          | 10   | 10   | 10          | 10   | 10   | 10         | 10   | 10   | 10         | 10   | 10   |
| Y+R:  | 4.0         | 4.0  | 4.0  | 4.0         | 4.0  | 4.0  | 4.0        | 4.0  | 4.0  | 4.0        | 4.0  | 4.0  |
| Volume Module: >> Count Date: 9 Oct 2014 << |             |      |      |             |      |      |            |      |      |            |      |      |
| Base Vol:                                   | 21          | 65   | 22   | 336         | 83   | 3    | 18         | 919  | 158  | 13         | 782  | 120  |
| Growth Adj:                                 | 1.00        | 1.00 | 1.00 | 1.00        | 1.00 | 1.00 | 1.00       | 1.00 | 1.00 | 1.00       | 1.00 | 1.00 |
| Initial Bse:                                | 21          | 65   | 22   | 336         | 83   | 3    | 18         | 919  | 158  | 13         | 782  | 120  |
| Added Vol:                                  | 0           | 0    | 0    | 0           | 0    | 0    | 0          | 0    | 0    | 0          | 0    | 0    |
| PasserByVol:                                | 0           | 0    | 0    | 0           | 0    | 0    | 0          | 0    | 0    | 0          | 0    | 0    |
| Initial Fut:                                | 21          | 65   | 22   | 336         | 83   | 3    | 18         | 919  | 158  | 13         | 782  | 120  |
| User Adj:                                   | 1.00        | 1.00 | 1.00 | 1.00        | 1.00 | 1.00 | 1.00       | 1.00 | 1.00 | 1.00       | 1.00 | 1.00 |
| PHF Adj:                                    | 1.00        | 1.00 | 1.00 | 1.00        | 1.00 | 1.00 | 1.00       | 1.00 | 1.00 | 1.00       | 1.00 | 1.00 |
| PHF Volume:                                 | 21          | 65   | 22   | 336         | 83   | 3    | 18         | 919  | 158  | 13         | 782  | 120  |
| Reduct Vol:                                 | 0           | 0    | 0    | 0           | 0    | 0    | 0          | 0    | 0    | 0          | 0    | 0    |
| Reduced Vol:                                | 21          | 65   | 22   | 336         | 83   | 3    | 18         | 919  | 158  | 13         | 782  | 120  |
| PCE Adj:                                    | 1.00        | 1.00 | 1.00 | 1.00        | 1.00 | 1.00 | 1.00       | 1.00 | 1.00 | 1.00       | 1.00 | 1.00 |
| MLF Adj:                                    | 1.00        | 1.00 | 1.00 | 1.00        | 1.00 | 1.00 | 1.00       | 1.00 | 1.00 | 1.00       | 1.00 | 1.00 |
| Final Volume:                               | 21          | 65   | 22   | 336         | 83   | 3    | 18         | 919  | 158  | 13         | 782  | 120  |
| Saturation Flow Module:                     |             |      |      |             |      |      |            |      |      |            |      |      |
| Sat/Lane:                                   | 1900        | 1900 | 1900 | 1900        | 1900 | 1900 | 1900       | 1900 | 1900 | 1900       | 1900 | 1900 |
| Adjustment:                                 | 0.92        | 0.92 | 0.92 | 0.92        | 0.92 | 0.92 | 0.95       | 0.95 | 0.95 | 0.95       | 0.95 | 0.95 |
| Lanes:                                      | 0.19        | 0.61 | 0.20 | 0.79        | 0.20 | 0.01 | 0.03       | 1.68 | 0.29 | 0.03       | 1.71 | 0.26 |
| Final Sat.:                                 | 340         | 1053 | 356  | 1393        | 344  | 12   | 59         | 3021 | 519  | 51         | 3077 | 472  |
| Capacity Analysis Module:                   |             |      |      |             |      |      |            |      |      |            |      |      |
| Vol/Sat:                                    | 0.06        | 0.06 | 0.06 | 0.24        | 0.24 | 0.24 | 0.30       | 0.30 | 0.30 | 0.25       | 0.25 | 0.25 |
| Crit Moves:                                 | *****       |      |      |             |      |      |            |      |      |            |      |      |
| Green Time:                                 | 22.3        | 22.3 | 22.3 | 22.3        | 22.3 | 22.3 | 28.2       | 28.2 | 28.2 | 23.5       | 23.5 | 23.5 |
| Volume/Cap:                                 | 0.22        | 0.22 | 0.22 | 0.86        | 0.86 | 0.86 | 0.86       | 0.86 | 0.86 | 0.86       | 0.86 | 0.86 |
| Delay/Veh:                                  | 22.4        | 22.4 | 22.4 | 42.2        | 42.2 | 42.2 | 30.6       | 30.6 | 30.6 | 34.3       | 34.3 | 34.3 |
| User DelAdj:                                | 1.00        | 1.00 | 1.00 | 1.00        | 1.00 | 1.00 | 1.00       | 1.00 | 1.00 | 1.00       | 1.00 | 1.00 |
| AdjDel/Veh:                                 | 22.4        | 22.4 | 22.4 | 42.2        | 42.2 | 42.2 | 30.6       | 30.6 | 30.6 | 34.3       | 34.3 | 34.3 |
| LOS by Move:                                | C           | C    | C    | D           | D    | D    | C          | C    | C    | C          | C    | C    |
| HCM2k95thQ:                                 | 5           | 5    | 5    | 25          | 25   | 25   | 29         | 29   | 29   | 22         | 22   | 22   |

Note: Queue reported is the number of cars per lane.

BART

Level Of Service Computation Report  
2000 HCM Operations (Future Volume Alternative)  
AM - Cumulative With Project

Intersection #3783: SANTA CLARA/17TH [Study Int 9]

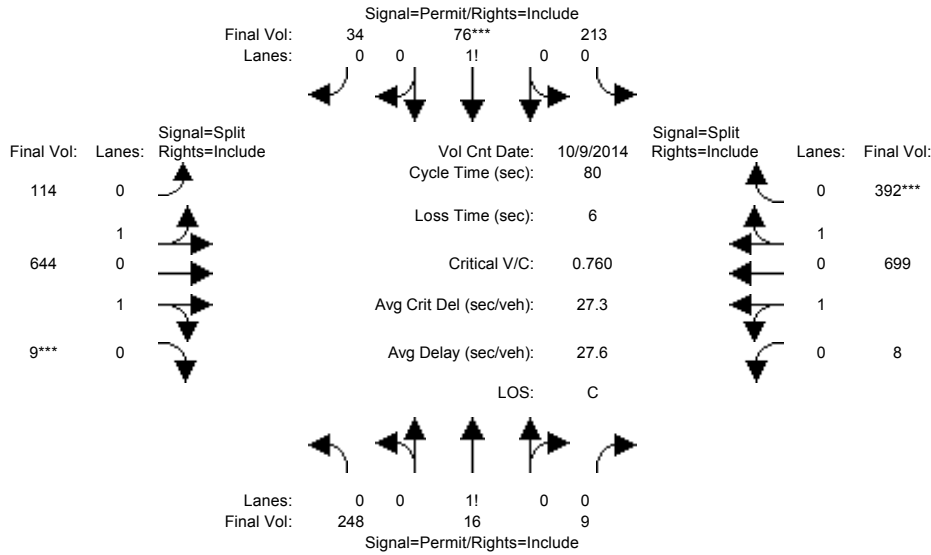

| Approach:                                   | North Bound |      |      | South Bound |      |      | East Bound |      |      | West Bound |      |      |
|---|-------------|------|------|-------------|------|------|------------|------|------|------------|------|------|
| Movement:                                   | L           | T    | R    | L           | T    | R    | L          | T    | R    | L          | T    | R    |
| Min. Green:                                 | 10          | 10   | 10   | 10          | 10   | 10   | 10         | 10   | 10   | 10         | 10   | 10   |
| Y+R:  | 4.0         | 4.0  | 4.0  | 4.0         | 4.0  | 4.0  | 4.0        | 4.0  | 4.0  | 4.0        | 4.0  | 4.0  |
| Volume Module: >> Count Date: 9 Oct 2014 << |             |      |      |             |      |      |            |      |      |            |      |      |
| Base Vol:                                   | 248         | 16   | 9    | 213         | 76   | 34   | 114        | 644  | 9    | 8          | 699  | 392  |
| Growth Adj:                                 | 1.00        | 1.00 | 1.00 | 1.00        | 1.00 | 1.00 | 1.00       | 1.00 | 1.00 | 1.00       | 1.00 | 1.00 |
| Initial Bse:                                | 248         | 16   | 9    | 213         | 76   | 34   | 114        | 644  | 9    | 8          | 699  | 392  |
| Added Vol:                                  | 0           | 0    | 0    | 0           | 0    | 0    | 0          | 0    | 0    | 0          | 0    | 0    |
| PasserByVol:                                | 0           | 0    | 0    | 0           | 0    | 0    | 0          | 0    | 0    | 0          | 0    | 0    |
| Initial Fut:                                | 248         | 16   | 9    | 213         | 76   | 34   | 114        | 644  | 9    | 8          | 699  | 392  |
| User Adj:                                   | 1.00        | 1.00 | 1.00 | 1.00        | 1.00 | 1.00 | 1.00       | 1.00 | 1.00 | 1.00       | 1.00 | 1.00 |
| PHF Adj:                                    | 1.00        | 1.00 | 1.00 | 1.00        | 1.00 | 1.00 | 1.00       | 1.00 | 1.00 | 1.00       | 1.00 | 1.00 |
| PHF Volume:                                 | 248         | 16   | 9    | 213         | 76   | 34   | 114        | 644  | 9    | 8          | 699  | 392  |
| Reduct Vol:                                 | 0           | 0    | 0    | 0           | 0    | 0    | 0          | 0    | 0    | 0          | 0    | 0    |
| Reduced Vol:                                | 248         | 16   | 9    | 213         | 76   | 34   | 114        | 644  | 9    | 8          | 699  | 392  |
| PCE Adj:                                    | 1.00        | 1.00 | 1.00 | 1.00        | 1.00 | 1.00 | 1.00       | 1.00 | 1.00 | 1.00       | 1.00 | 1.00 |
| MLF Adj:                                    | 1.00        | 1.00 | 1.00 | 1.00        | 1.00 | 1.00 | 1.00       | 1.00 | 1.00 | 1.00       | 1.00 | 1.00 |
| Final Volume:                               | 248         | 16   | 9    | 213         | 76   | 34   | 114        | 644  | 9    | 8          | 699  | 392  |
| Saturation Flow Module:                     |             |      |      |             |      |      |            |      |      |            |      |      |
| Sat/Lane:                                   | 1900        | 1900 | 1900 | 1900        | 1900 | 1900 | 1900       | 1900 | 1900 | 1900       | 1900 | 1900 |
| Adjustment:                                 | 0.92        | 0.92 | 0.92 | 0.92        | 0.92 | 0.92 | 0.95       | 0.95 | 0.95 | 0.95       | 0.95 | 0.95 |
| Lanes:                                      | 0.91        | 0.06 | 0.03 | 0.66        | 0.24 | 0.10 | 0.30       | 1.68 | 0.02 | 0.01       | 1.28 | 0.71 |
| Final Sat.:                                 | 1590        | 103  | 58   | 1154        | 412  | 184  | 535        | 3023 | 42   | 26         | 2290 | 1284 |
| Capacity Analysis Module:                   |             |      |      |             |      |      |            |      |      |            |      |      |
| Vol/Sat:                                    | 0.16        | 0.16 | 0.16 | 0.18        | 0.18 | 0.18 | 0.21       | 0.21 | 0.21 | 0.31       | 0.31 | 0.31 |
| Crit Moves:                                 | *****       |      |      |             |      |      |            |      |      |            |      |      |
| Green Time:                                 | 19.4        | 19.4 | 19.4 | 19.4        | 19.4 | 19.4 | 22.4       | 22.4 | 22.4 | 32.1       | 32.1 | 32.1 |
| Volume/Cap:                                 | 0.64        | 0.64 | 0.64 | 0.76        | 0.76 | 0.76 | 0.76       | 0.76 | 0.76 | 0.76       | 0.76 | 0.76 |
| Delay/Veh:                                  | 30.5        | 30.5 | 30.5 | 35.9        | 35.9 | 35.9 | 29.7       | 29.7 | 29.7 | 23.0       | 23.0 | 23.0 |
| User DelAdj:                                | 1.00        | 1.00 | 1.00 | 1.00        | 1.00 | 1.00 | 1.00       | 1.00 | 1.00 | 1.00       | 1.00 | 1.00 |
| AdjDel/Veh:                                 | 30.5        | 30.5 | 30.5 | 35.9        | 35.9 | 35.9 | 29.7       | 29.7 | 29.7 | 23.0       | 23.0 | 23.0 |
| LOS by Move:                                | C           | C    | C    | D           | D    | D    | C          | C    | C    | C          | C    | C    |
| HCM2k95thQ:                                 | 14          | 14   | 14   | 18          | 18   | 18   | 20         | 20   | 20   | 23         | 23   | 23   |

Note: Queue reported is the number of cars per lane.

BART

Level Of Service Computation Report  
 2000 HCM Operations (Future Volume Alternative)  
 PM - Cumulative With Project

Intersection #3783: SANTA CLARA/17TH [Study Int 9]

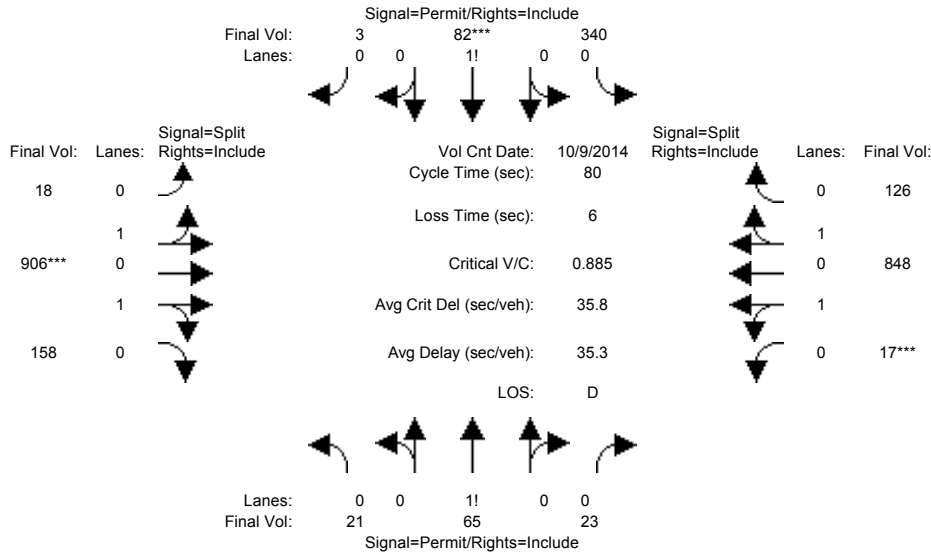

| Approach:                                   | North Bound |      |      | South Bound |      |      | East Bound |      |      | West Bound |      |      |
|---|-------------|------|------|-------------|------|------|------------|------|------|------------|------|------|
| Movement:                                   | L           | T    | R    | L           | T    | R    | L          | T    | R    | L          | T    | R    |
| Min. Green:                                 | 10          | 10   | 10   | 10          | 10   | 10   | 10         | 10   | 10   | 10         | 10   | 10   |
| Y+R:  | 4.0         | 4.0  | 4.0  | 4.0         | 4.0  | 4.0  | 4.0        | 4.0  | 4.0  | 4.0        | 4.0  | 4.0  |
| Volume Module: >> Count Date: 9 Oct 2014 << |             |      |      |             |      |      |            |      |      |            |      |      |
| Base Vol:                                   | 21          | 65   | 23   | 340         | 82   | 3    | 18         | 906  | 158  | 17         | 848  | 126  |
| Growth Adj:                                 | 1.00        | 1.00 | 1.00 | 1.00        | 1.00 | 1.00 | 1.00       | 1.00 | 1.00 | 1.00       | 1.00 | 1.00 |
| Initial Bse:                                | 21          | 65   | 23   | 340         | 82   | 3    | 18         | 906  | 158  | 17         | 848  | 126  |
| Added Vol:                                  | 0           | 0    | 0    | 0           | 0    | 0    | 0          | 0    | 0    | 0          | 0    | 0    |
| PasserByVol:                                | 0           | 0    | 0    | 0           | 0    | 0    | 0          | 0    | 0    | 0          | 0    | 0    |
| Initial Fut:                                | 21          | 65   | 23   | 340         | 82   | 3    | 18         | 906  | 158  | 17         | 848  | 126  |
| User Adj:                                   | 1.00        | 1.00 | 1.00 | 1.00        | 1.00 | 1.00 | 1.00       | 1.00 | 1.00 | 1.00       | 1.00 | 1.00 |
| PHF Adj:                                    | 1.00        | 1.00 | 1.00 | 1.00        | 1.00 | 1.00 | 1.00       | 1.00 | 1.00 | 1.00       | 1.00 | 1.00 |
| PHF Volume:                                 | 21          | 65   | 23   | 340         | 82   | 3    | 18         | 906  | 158  | 17         | 848  | 126  |
| Reduct Vol:                                 | 0           | 0    | 0    | 0           | 0    | 0    | 0          | 0    | 0    | 0          | 0    | 0    |
| Reduced Vol:                                | 21          | 65   | 23   | 340         | 82   | 3    | 18         | 906  | 158  | 17         | 848  | 126  |
| PCE Adj:                                    | 1.00        | 1.00 | 1.00 | 1.00        | 1.00 | 1.00 | 1.00       | 1.00 | 1.00 | 1.00       | 1.00 | 1.00 |
| MLF Adj:                                    | 1.00        | 1.00 | 1.00 | 1.00        | 1.00 | 1.00 | 1.00       | 1.00 | 1.00 | 1.00       | 1.00 | 1.00 |
| FinalVolume:                                | 21          | 65   | 23   | 340         | 82   | 3    | 18         | 906  | 158  | 17         | 848  | 126  |
| Saturation Flow Module:                     |             |      |      |             |      |      |            |      |      |            |      |      |
| Sat/Lane:                                   | 1900        | 1900 | 1900 | 1900        | 1900 | 1900 | 1900       | 1900 | 1900 | 1900       | 1900 | 1900 |
| Adjustment:                                 | 0.92        | 0.92 | 0.92 | 0.92        | 0.92 | 0.92 | 0.95       | 0.95 | 0.95 | 0.95       | 0.95 | 0.95 |
| Lanes:                                      | 0.19        | 0.60 | 0.21 | 0.80        | 0.19 | 0.01 | 0.03       | 1.68 | 0.29 | 0.03       | 1.72 | 0.25 |
| Final Sat.:                                 | 337         | 1044 | 369  | 1400        | 338  | 12   | 60         | 3014 | 526  | 62         | 3081 | 458  |
| Capacity Analysis Module:                   |             |      |      |             |      |      |            |      |      |            |      |      |
| Vol/Sat:                                    | 0.06        | 0.06 | 0.06 | 0.24        | 0.24 | 0.24 | 0.30       | 0.30 | 0.30 | 0.28       | 0.28 | 0.28 |
| Crit Moves:                                 |             |      |      | ****        |      |      |            | **** |      |            |      | **** |
| Green Time:                                 | 22.0        | 22.0 | 22.0 | 22.0        | 22.0 | 22.0 | 27.2       | 27.2 | 27.2 | 24.9       | 24.9 | 24.9 |
| Volume/Cap:                                 | 0.23        | 0.23 | 0.23 | 0.89        | 0.89 | 0.89 | 0.89       | 0.89 | 0.89 | 0.89       | 0.89 | 0.89 |
| Delay/Veh:                                  | 22.7        | 22.7 | 22.7 | 45.4        | 45.4 | 45.4 | 33.0       | 33.0 | 33.0 | 34.9       | 34.9 | 34.9 |
| User DelAdj:                                | 1.00        | 1.00 | 1.00 | 1.00        | 1.00 | 1.00 | 1.00       | 1.00 | 1.00 | 1.00       | 1.00 | 1.00 |
| AdjDel/Veh:                                 | 22.7        | 22.7 | 22.7 | 45.4        | 45.4 | 45.4 | 33.0       | 33.0 | 33.0 | 34.9       | 34.9 | 34.9 |
| LOS by Move:                                | C           | C    | C    | D           | D    | D    | C          | C    | C    | C          | C    | C    |
| HCM2k95thQ:                                 | 5           | 5    | 5    | 26          | 26   | 26   | 29         | 29   | 29   | 24         | 24   | 24   |

Note: Queue reported is the number of cars per lane.

BART

Level Of Service Computation Report  
 2000 HCM Operations (Future Volume Alternative)  
 AM - Cumulative No Project

Intersection #3788: SANTA CLARA/28TH [Study Int 13]

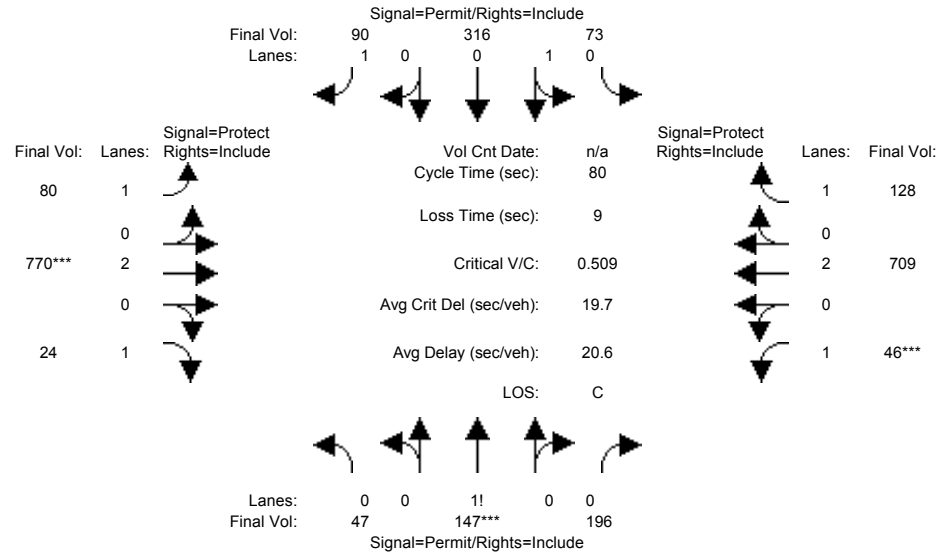

| Approach:                 | North Bound |      |      | South Bound |      |      | East Bound |      |      | West Bound |      |      |
|---------------------------|-------------|------|------|-------------|------|------|------------|------|------|------------|------|------|
| Movement:                 | L           | T    | R    | L           | T    | R    | L          | T    | R    | L          | T    | R    |
| Min. Green:               | 10          | 10   | 10   | 10          | 10   | 10   | 7          | 10   | 10   | 7          | 10   | 10   |
| Y+R:                      | 4.0         | 4.0  | 4.0  | 4.0         | 4.0  | 4.0  | 4.0        | 4.0  | 4.0  | 4.0        | 4.0  | 4.0  |
| Volume Module:            |             |      |      |             |      |      |            |      |      |            |      |      |
| Base Vol:                 | 47          | 147  | 196  | 73          | 316  | 90   | 80         | 770  | 24   | 46         | 709  | 128  |
| Growth Adj:               | 1.00        | 1.00 | 1.00 | 1.00        | 1.00 | 1.00 | 1.00       | 1.00 | 1.00 | 1.00       | 1.00 | 1.00 |
| Initial Bse:              | 47          | 147  | 196  | 73          | 316  | 90   | 80         | 770  | 24   | 46         | 709  | 128  |
| Added Vol:                | 0           | 0    | 0    | 0           | 0    | 0    | 0          | 0    | 0    | 0          | 0    | 0    |
| PasserByVol:              | 0           | 0    | 0    | 0           | 0    | 0    | 0          | 0    | 0    | 0          | 0    | 0    |
| Initial Fut:              | 47          | 147  | 196  | 73          | 316  | 90   | 80         | 770  | 24   | 46         | 709  | 128  |
| User Adj:                 | 1.00        | 1.00 | 1.00 | 1.00        | 1.00 | 1.00 | 1.00       | 1.00 | 1.00 | 1.00       | 1.00 | 1.00 |
| PHF Adj:                  | 1.00        | 1.00 | 1.00 | 1.00        | 1.00 | 1.00 | 1.00       | 1.00 | 1.00 | 1.00       | 1.00 | 1.00 |
| PHF Volume:               | 47          | 147  | 196  | 73          | 316  | 90   | 80         | 770  | 24   | 46         | 709  | 128  |
| Reduct Vol:               | 0           | 0    | 0    | 0           | 0    | 0    | 0          | 0    | 0    | 0          | 0    | 0    |
| Reduced Vol:              | 47          | 147  | 196  | 73          | 316  | 90   | 80         | 770  | 24   | 46         | 709  | 128  |
| PCE Adj:                  | 1.00        | 1.00 | 1.00 | 1.00        | 1.00 | 1.00 | 1.00       | 1.00 | 1.00 | 1.00       | 1.00 | 1.00 |
| MLF Adj:                  | 1.00        | 1.00 | 1.00 | 1.00        | 1.00 | 1.00 | 1.00       | 1.00 | 1.00 | 1.00       | 1.00 | 1.00 |
| Final Volume:             | 47          | 147  | 196  | 73          | 316  | 90   | 80         | 770  | 24   | 46         | 709  | 128  |
| Saturation Flow Module:   |             |      |      |             |      |      |            |      |      |            |      |      |
| Sat/Lane:                 | 1900        | 1900 | 1900 | 1900        | 1900 | 1900 | 1900       | 1900 | 1900 | 1900       | 1900 | 1900 |
| Adjustment:               | 0.92        | 0.92 | 0.92 | 0.95        | 0.95 | 0.92 | 0.92       | 1.00 | 0.92 | 0.92       | 1.00 | 0.92 |
| Lanes:                    | 0.12        | 0.38 | 0.50 | 0.19        | 0.81 | 1.00 | 1.00       | 2.00 | 1.00 | 1.00       | 2.00 | 1.00 |
| Final Sat.:               | 211         | 660  | 879  | 338         | 1462 | 1750 | 1750       | 3800 | 1750 | 1750       | 3800 | 1750 |
| Capacity Analysis Module: |             |      |      |             |      |      |            |      |      |            |      |      |
| Vol/Sat:                  | 0.22        | 0.22 | 0.22 | 0.22        | 0.22 | 0.05 | 0.05       | 0.20 | 0.01 | 0.03       | 0.19 | 0.07 |
| Crit Moves:               | ****        |      |      |             |      |      | ****       |      |      | ****       |      |      |
| Green Time:               | 33.5        | 33.5 | 33.5 | 33.5        | 33.5 | 33.5 | 12.0       | 30.5 | 30.5 | 7.0        | 25.5 | 25.5 |
| Volume/Cap:               | 0.53        | 0.53 | 0.53 | 0.52        | 0.52 | 0.12 | 0.31       | 0.53 | 0.04 | 0.30       | 0.59 | 0.23 |
| Delay/Veh:                | 18.1        | 18.1 | 18.1 | 17.8        | 17.8 | 14.3 | 31.0       | 19.6 | 15.6 | 35.3       | 23.6 | 20.2 |
| User DelAdj:              | 1.00        | 1.00 | 1.00 | 1.00        | 1.00 | 1.00 | 1.00       | 1.00 | 1.00 | 1.00       | 1.00 | 1.00 |
| AdjDel/Veh:               | 18.1        | 18.1 | 18.1 | 17.8        | 17.8 | 14.3 | 31.0       | 19.6 | 15.6 | 35.3       | 23.6 | 20.2 |
| LOS by Move:              | B           | B    | B    | B           | B    | B    | C          | B    | B    | D          | C    | C    |
| HCM2k95thQ:               | 14          | 14   | 14   | 14          | 14   | 3    | 4          | 14   | 1    | 2          | 14   | 5    |

Note: Queue reported is the number of cars per lane.



BART

Level Of Service Computation Report  
 2000 HCM Operations (Future Volume Alternative)  
 PM - Cumulative No Project

Intersection #3788: SANTA CLARA/28TH [Study Int 13]

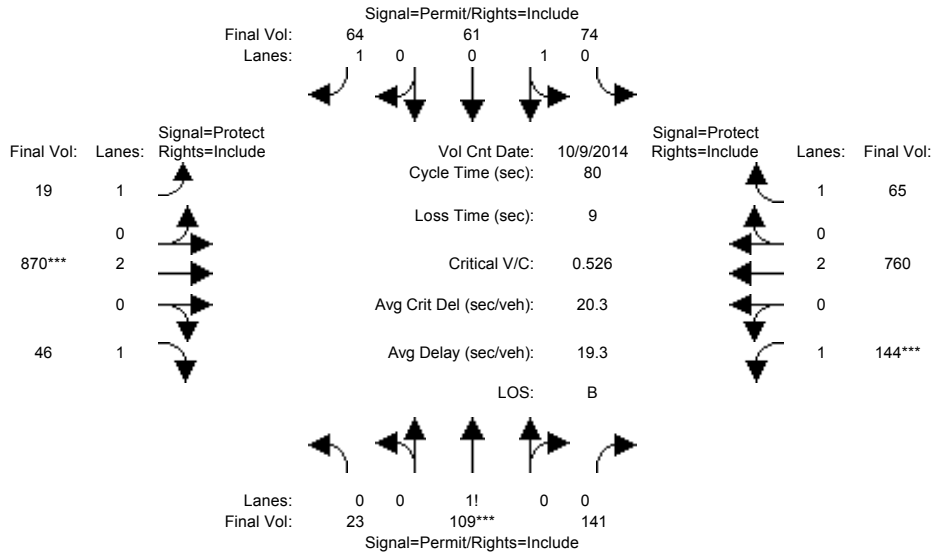

| Approach:                                   | North Bound |      |      | South Bound |      |      | East Bound |      |      | West Bound |      |      |
|---|-------------|------|------|-------------|------|------|------------|------|------|------------|------|------|
| Movement:                                   | L           | T    | R    | L           | T    | R    | L          | T    | R    | L          | T    | R    |
| Min. Green:                                 | 10          | 10   | 10   | 10          | 10   | 10   | 7          | 10   | 10   | 7          | 10   | 10   |
| Y+R:  | 4.0         | 4.0  | 4.0  | 4.0         | 4.0  | 4.0  | 4.0        | 4.0  | 4.0  | 4.0        | 4.0  | 4.0  |
| Volume Module: >> Count Date: 9 Oct 2014 << |             |      |      |             |      |      |            |      |      |            |      |      |
| Base Vol:                                   | 23          | 109  | 141  | 74          | 61   | 64   | 19         | 870  | 46   | 144        | 760  | 65   |
| Growth Adj:                                 | 1.00        | 1.00 | 1.00 | 1.00        | 1.00 | 1.00 | 1.00       | 1.00 | 1.00 | 1.00       | 1.00 | 1.00 |
| Initial Bse:                                | 23          | 109  | 141  | 74          | 61   | 64   | 19         | 870  | 46   | 144        | 760  | 65   |
| Added Vol:                                  | 0           | 0    | 0    | 0           | 0    | 0    | 0          | 0    | 0    | 0          | 0    | 0    |
| PasserByVol:                                | 0           | 0    | 0    | 0           | 0    | 0    | 0          | 0    | 0    | 0          | 0    | 0    |
| Initial Fut:                                | 23          | 109  | 141  | 74          | 61   | 64   | 19         | 870  | 46   | 144        | 760  | 65   |
| User Adj:                                   | 1.00        | 1.00 | 1.00 | 1.00        | 1.00 | 1.00 | 1.00       | 1.00 | 1.00 | 1.00       | 1.00 | 1.00 |
| PHF Adj:                                    | 1.00        | 1.00 | 1.00 | 1.00        | 1.00 | 1.00 | 1.00       | 1.00 | 1.00 | 1.00       | 1.00 | 1.00 |
| PHF Volume:                                 | 23          | 109  | 141  | 74          | 61   | 64   | 19         | 870  | 46   | 144        | 760  | 65   |
| Reduct Vol:                                 | 0           | 0    | 0    | 0           | 0    | 0    | 0          | 0    | 0    | 0          | 0    | 0    |
| Reduced Vol:                                | 23          | 109  | 141  | 74          | 61   | 64   | 19         | 870  | 46   | 144        | 760  | 65   |
| PCE Adj:                                    | 1.00        | 1.00 | 1.00 | 1.00        | 1.00 | 1.00 | 1.00       | 1.00 | 1.00 | 1.00       | 1.00 | 1.00 |
| MLF Adj:                                    | 1.00        | 1.00 | 1.00 | 1.00        | 1.00 | 1.00 | 1.00       | 1.00 | 1.00 | 1.00       | 1.00 | 1.00 |
| Final Volume:                               | 23          | 109  | 141  | 74          | 61   | 64   | 19         | 870  | 46   | 144        | 760  | 65   |
| Saturation Flow Module:                     |             |      |      |             |      |      |            |      |      |            |      |      |
| Sat/Lane:                                   | 1900        | 1900 | 1900 | 1900        | 1900 | 1900 | 1900       | 1900 | 1900 | 1900       | 1900 | 1900 |
| Adjustment:                                 | 0.92        | 0.92 | 0.92 | 0.95        | 0.95 | 0.92 | 0.92       | 1.00 | 0.92 | 0.92       | 1.00 | 0.92 |
| Lanes:                                      | 0.08        | 0.40 | 0.52 | 0.55        | 0.45 | 1.00 | 1.00       | 2.00 | 1.00 | 1.00       | 2.00 | 1.00 |
| Final Sat.:                                 | 147         | 699  | 904  | 987         | 813  | 1750 | 1750       | 3800 | 1750 | 1750       | 3800 | 1750 |
| Capacity Analysis Module:                   |             |      |      |             |      |      |            |      |      |            |      |      |
| Vol/Sat:                                    | 0.16        | 0.16 | 0.16 | 0.08        | 0.08 | 0.04 | 0.01       | 0.23 | 0.03 | 0.08       | 0.20 | 0.04 |
| Crit Moves:                                 | ****        |      |      | ****        |      |      | ****       |      |      | ****       |      |      |
| Green Time:                                 | 23.7        | 23.7 | 23.7 | 23.7        | 23.7 | 23.7 | 14.4       | 34.8 | 34.8 | 12.5       | 32.9 | 32.9 |
| Volume/Cap:                                 | 0.53        | 0.53 | 0.53 | 0.25        | 0.25 | 0.12 | 0.06       | 0.53 | 0.06 | 0.53       | 0.49 | 0.09 |
| Delay/Veh:                                  | 24.5        | 24.5 | 24.5 | 21.7        | 21.7 | 20.7 | 27.3       | 16.9 | 13.2 | 32.9       | 17.6 | 14.5 |
| User DelAdj:                                | 1.00        | 1.00 | 1.00 | 1.00        | 1.00 | 1.00 | 1.00       | 1.00 | 1.00 | 1.00       | 1.00 | 1.00 |
| AdjDel/Veh:                                 | 24.5        | 24.5 | 24.5 | 21.7        | 21.7 | 20.7 | 27.3       | 16.9 | 13.2 | 32.9       | 17.6 | 14.5 |
| LOS by Move:                                | C           | C    | C    | C           | C    | C    | C          | B    | B    | C          | B    | B    |
| HCM2k95thQ:                                 | 12          | 12   | 12   | 5           | 5    | 2    | 1          | 15   | 1    | 7          | 13   | 2    |

Note: Queue reported is the number of cars per lane.

BART

Level Of Service Computation Report  
 2000 HCM Operations (Future Volume Alternative)  
 AM - Cumulative With Project

Intersection #3788: SANTA CLARA/28TH [Study Int 13]

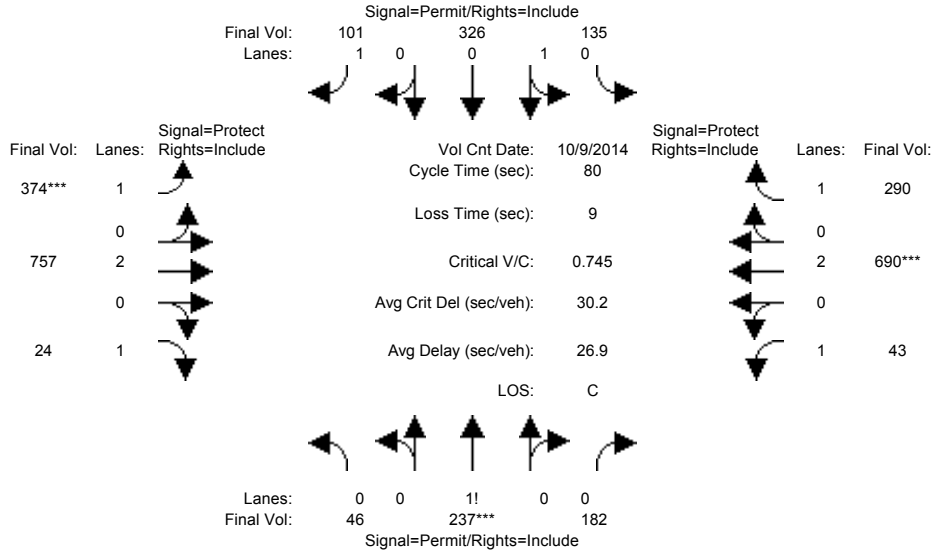

| Approach:                                   | North Bound |      |      | South Bound |      |      | East Bound |      |      | West Bound |      |      |
|---|-------------|------|------|-------------|------|------|------------|------|------|------------|------|------|
| Movement:                                   | L           | T    | R    | L           | T    | R    | L          | T    | R    | L          | T    | R    |
| Min. Green:                                 | 10          | 10   | 10   | 10          | 10   | 10   | 7          | 10   | 10   | 7          | 10   | 10   |
| Y+R:  | 4.0         | 4.0  | 4.0  | 4.0         | 4.0  | 4.0  | 4.0        | 4.0  | 4.0  | 4.0        | 4.0  | 4.0  |
| Volume Module: >> Count Date: 9 Oct 2014 << |             |      |      |             |      |      |            |      |      |            |      |      |
| Base Vol:                                   | 46          | 237  | 182  | 135         | 326  | 101  | 374        | 757  | 24   | 43         | 690  | 290  |
| Growth Adj:                                 | 1.00        | 1.00 | 1.00 | 1.00        | 1.00 | 1.00 | 1.00       | 1.00 | 1.00 | 1.00       | 1.00 | 1.00 |
| Initial Bse:                                | 46          | 237  | 182  | 135         | 326  | 101  | 374        | 757  | 24   | 43         | 690  | 290  |
| Added Vol:                                  | 0           | 0    | 0    | 0           | 0    | 0    | 0          | 0    | 0    | 0          | 0    | 0    |
| PasserByVol:                                | 0           | 0    | 0    | 0           | 0    | 0    | 0          | 0    | 0    | 0          | 0    | 0    |
| Initial Fut:                                | 46          | 237  | 182  | 135         | 326  | 101  | 374        | 757  | 24   | 43         | 690  | 290  |
| User Adj:                                   | 1.00        | 1.00 | 1.00 | 1.00        | 1.00 | 1.00 | 1.00       | 1.00 | 1.00 | 1.00       | 1.00 | 1.00 |
| PHF Adj:                                    | 1.00        | 1.00 | 1.00 | 1.00        | 1.00 | 1.00 | 1.00       | 1.00 | 1.00 | 1.00       | 1.00 | 1.00 |
| PHF Volume:                                 | 46          | 237  | 182  | 135         | 326  | 101  | 374        | 757  | 24   | 43         | 690  | 290  |
| Reduct Vol:                                 | 0           | 0    | 0    | 0           | 0    | 0    | 0          | 0    | 0    | 0          | 0    | 0    |
| Reduced Vol:                                | 46          | 237  | 182  | 135         | 326  | 101  | 374        | 757  | 24   | 43         | 690  | 290  |
| PCE Adj:                                    | 1.00        | 1.00 | 1.00 | 1.00        | 1.00 | 1.00 | 1.00       | 1.00 | 1.00 | 1.00       | 1.00 | 1.00 |
| MLF Adj:                                    | 1.00        | 1.00 | 1.00 | 1.00        | 1.00 | 1.00 | 1.00       | 1.00 | 1.00 | 1.00       | 1.00 | 1.00 |
| Final Volume:                               | 46          | 237  | 182  | 135         | 326  | 101  | 374        | 757  | 24   | 43         | 690  | 290  |
| Saturation Flow Module:                     |             |      |      |             |      |      |            |      |      |            |      |      |
| Sat/Lane:                                   | 1900        | 1900 | 1900 | 1900        | 1900 | 1900 | 1900       | 1900 | 1900 | 1900       | 1900 | 1900 |
| Adjustment:                                 | 0.92        | 0.92 | 0.92 | 0.95        | 0.95 | 0.92 | 0.92       | 1.00 | 0.92 | 0.92       | 1.00 | 0.92 |
| Lanes:                                      | 0.10        | 0.51 | 0.39 | 0.29        | 0.71 | 1.00 | 1.00       | 2.00 | 1.00 | 1.00       | 2.00 | 1.00 |
| Final Sat.:                                 | 173         | 892  | 685  | 527         | 1273 | 1750 | 1750       | 3800 | 1750 | 1750       | 3800 | 1750 |
| Capacity Analysis Module:                   |             |      |      |             |      |      |            |      |      |            |      |      |
| Vol/Sat:                                    | 0.27        | 0.27 | 0.27 | 0.26        | 0.26 | 0.06 | 0.21       | 0.20 | 0.01 | 0.02       | 0.18 | 0.17 |
| Crit Moves:                                 | ****        |      |      | ****        |      |      | ****       |      |      | ****       |      |      |
| Green Time:                                 | 28.5        | 28.5 | 28.5 | 28.5        | 28.5 | 28.5 | 23.0       | 29.5 | 29.5 | 13.0       | 19.5 | 19.5 |
| Volume/Cap:                                 | 0.74        | 0.74 | 0.74 | 0.72        | 0.72 | 0.16 | 0.74       | 0.54 | 0.04 | 0.15       | 0.74 | 0.68 |
| Delay/Veh:                                  | 27.4        | 27.4 | 27.4 | 26.2        | 26.2 | 17.7 | 31.9       | 20.3 | 16.2 | 29.0       | 31.3 | 31.8 |
| User DelAdj:                                | 1.00        | 1.00 | 1.00 | 1.00        | 1.00 | 1.00 | 1.00       | 1.00 | 1.00 | 1.00       | 1.00 | 1.00 |
| AdjDel/Veh:                                 | 27.4        | 27.4 | 27.4 | 26.2        | 26.2 | 17.7 | 31.9       | 20.3 | 16.2 | 29.0       | 31.3 | 31.8 |
| LOS by Move:                                | C           | C    | C    | C           | C    | B    | C          | C    | B    | C          | C    | C    |
| HCM2k95thQ:                                 | 20          | 20   | 20   | 19          | 19   | 4    | 17         | 14   | 1    | 2          | 15   | 14   |

Note: Queue reported is the number of cars per lane.

BART

Level Of Service Computation Report  
2000 HCM Operations (Future Volume Alternative)  
PM - Cumulative With Project

Intersection #3788: SANTA CLARA/28TH [Study Int 13]

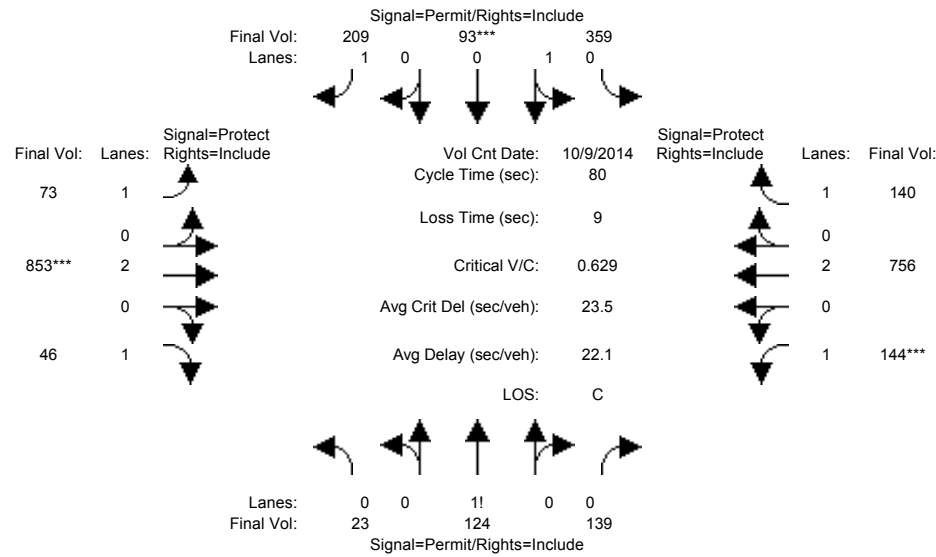

| Approach:                                   | North Bound |      |      | South Bound |      |      | East Bound |      |      | West Bound |      |      |
|---|-------------|------|------|-------------|------|------|------------|------|------|------------|------|------|
| Movement:                                   | L           | T    | R    | L           | T    | R    | L          | T    | R    | L          | T    | R    |
| Min. Green:                                 | 10          | 10   | 10   | 10          | 10   | 10   | 7          | 10   | 10   | 7          | 10   | 10   |
| Y+R:  | 4.0         | 4.0  | 4.0  | 4.0         | 4.0  | 4.0  | 4.0        | 4.0  | 4.0  | 4.0        | 4.0  | 4.0  |
| Volume Module: >> Count Date: 9 Oct 2014 << |             |      |      |             |      |      |            |      |      |            |      |      |
| Base Vol:                                   | 23          | 124  | 139  | 359         | 93   | 209  | 73         | 853  | 46   | 144        | 756  | 140  |
| Growth Adj:                                 | 1.00        | 1.00 | 1.00 | 1.00        | 1.00 | 1.00 | 1.00       | 1.00 | 1.00 | 1.00       | 1.00 | 1.00 |
| Initial Bse:                                | 23          | 124  | 139  | 359         | 93   | 209  | 73         | 853  | 46   | 144        | 756  | 140  |
| Added Vol:                                  | 0           | 0    | 0    | 0           | 0    | 0    | 0          | 0    | 0    | 0          | 0    | 0    |
| PasserByVol:                                | 0           | 0    | 0    | 0           | 0    | 0    | 0          | 0    | 0    | 0          | 0    | 0    |
| Initial Fut:                                | 23          | 124  | 139  | 359         | 93   | 209  | 73         | 853  | 46   | 144        | 756  | 140  |
| User Adj:                                   | 1.00        | 1.00 | 1.00 | 1.00        | 1.00 | 1.00 | 1.00       | 1.00 | 1.00 | 1.00       | 1.00 | 1.00 |
| PHF Adj:                                    | 1.00        | 1.00 | 1.00 | 1.00        | 1.00 | 1.00 | 1.00       | 1.00 | 1.00 | 1.00       | 1.00 | 1.00 |
| PHF Volume:                                 | 23          | 124  | 139  | 359         | 93   | 209  | 73         | 853  | 46   | 144        | 756  | 140  |
| Reduct Vol:                                 | 0           | 0    | 0    | 0           | 0    | 0    | 0          | 0    | 0    | 0          | 0    | 0    |
| Reduced Vol:                                | 23          | 124  | 139  | 359         | 93   | 209  | 73         | 853  | 46   | 144        | 756  | 140  |
| PCE Adj:                                    | 1.00        | 1.00 | 1.00 | 1.00        | 1.00 | 1.00 | 1.00       | 1.00 | 1.00 | 1.00       | 1.00 | 1.00 |
| MLF Adj:                                    | 1.00        | 1.00 | 1.00 | 1.00        | 1.00 | 1.00 | 1.00       | 1.00 | 1.00 | 1.00       | 1.00 | 1.00 |
| Final Volume:                               | 23          | 124  | 139  | 359         | 93   | 209  | 73         | 853  | 46   | 144        | 756  | 140  |
| Saturation Flow Module:                     |             |      |      |             |      |      |            |      |      |            |      |      |
| Sat/Lane:                                   | 1900        | 1900 | 1900 | 1900        | 1900 | 1900 | 1900       | 1900 | 1900 | 1900       | 1900 | 1900 |
| Adjustment:                                 | 0.92        | 0.92 | 0.92 | 0.95        | 0.95 | 0.92 | 0.92       | 1.00 | 0.92 | 0.92       | 1.00 | 0.92 |
| Lanes:                                      | 0.08        | 0.43 | 0.49 | 0.79        | 0.21 | 1.00 | 1.00       | 2.00 | 1.00 | 1.00       | 2.00 | 1.00 |
| Final Sat.:                                 | 141         | 759  | 851  | 1430        | 370  | 1750 | 1750       | 3800 | 1750 | 1750       | 3800 | 1750 |
| Capacity Analysis Module:                   |             |      |      |             |      |      |            |      |      |            |      |      |
| Vol/Sat:                                    | 0.16        | 0.16 | 0.16 | 0.25        | 0.25 | 0.12 | 0.04       | 0.22 | 0.03 | 0.08       | 0.20 | 0.08 |
| Crit Moves:                                 | *****       |      |      |             |      |      |            |      |      |            |      |      |
| Green Time:                                 | 32.0        | 32.0 | 32.0 | 32.0        | 32.0 | 32.0 | 11.9       | 28.6 | 28.6 | 10.5       | 27.1 | 27.1 |
| Volume/Cap:                                 | 0.41        | 0.41 | 0.41 | 0.63        | 0.63 | 0.30 | 0.28       | 0.63 | 0.07 | 0.63       | 0.59 | 0.24 |
| Delay/Veh:                                  | 17.6        | 17.6 | 17.6 | 21.0        | 21.0 | 16.6 | 30.8       | 22.3 | 17.0 | 38.4       | 22.5 | 19.2 |
| User DelAdj:                                | 1.00        | 1.00 | 1.00 | 1.00        | 1.00 | 1.00 | 1.00       | 1.00 | 1.00 | 1.00       | 1.00 | 1.00 |
| AdjDel/Veh:                                 | 17.6        | 17.6 | 17.6 | 21.0        | 21.0 | 16.6 | 30.8       | 22.3 | 17.0 | 38.4       | 22.5 | 19.2 |
| LOS by Move:                                | B           | B    | B    | C           | C    | B    | C          | C    | B    | D          | C    | B    |
| HCM2k95thQ:                                 | 10          | 10   | 10   | 17          | 17   | 7    | 3          | 16   | 2    | 7          | 14   | 5    |

Note: Queue reported is the number of cars per lane.

BART

Level Of Service Computation Report  
 2000 HCM Operations (Future Volume Alternative)  
 AM - Cumulative No Project

Intersection #3789: SANTA CLARA/21ST [Study Int 10]

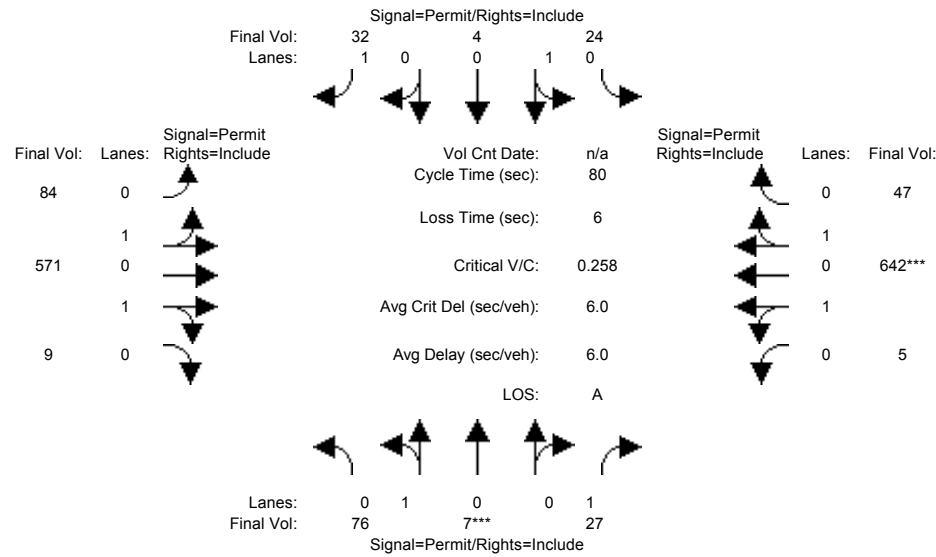

| Approach:                 | North Bound |      |      | South Bound |      |      | East Bound |      |      | West Bound |      |      |
|---------------------------|-------------|------|------|-------------|------|------|------------|------|------|------------|------|------|
| Movement:                 | L           | T    | R    | L           | T    | R    | L          | T    | R    | L          | T    | R    |
| Min. Green:               | 10          | 10   | 10   | 10          | 10   | 10   | 10         | 10   | 10   | 10         | 10   | 10   |
| Y+R:                      | 4.0         | 4.0  | 4.0  | 4.0         | 4.0  | 4.0  | 4.0        | 4.0  | 4.0  | 4.0        | 4.0  | 4.0  |
| Volume Module:            |             |      |      |             |      |      |            |      |      |            |      |      |
| Base Vol:                 | 76          | 7    | 27   | 24          | 4    | 32   | 84         | 571  | 9    | 5          | 642  | 47   |
| Growth Adj:               | 1.00        | 1.00 | 1.00 | 1.00        | 1.00 | 1.00 | 1.00       | 1.00 | 1.00 | 1.00       | 1.00 | 1.00 |
| Initial Bse:              | 76          | 7    | 27   | 24          | 4    | 32   | 84         | 571  | 9    | 5          | 642  | 47   |
| Added Vol:                | 0           | 0    | 0    | 0           | 0    | 0    | 0          | 0    | 0    | 0          | 0    | 0    |
| PasserByVol:              | 0           | 0    | 0    | 0           | 0    | 0    | 0          | 0    | 0    | 0          | 0    | 0    |
| Initial Fut:              | 76          | 7    | 27   | 24          | 4    | 32   | 84         | 571  | 9    | 5          | 642  | 47   |
| User Adj:                 | 1.00        | 1.00 | 1.00 | 1.00        | 1.00 | 1.00 | 1.00       | 1.00 | 1.00 | 1.00       | 1.00 | 1.00 |
| PHF Adj:                  | 1.00        | 1.00 | 1.00 | 1.00        | 1.00 | 1.00 | 1.00       | 1.00 | 1.00 | 1.00       | 1.00 | 1.00 |
| PHF Volume:               | 76          | 7    | 27   | 24          | 4    | 32   | 84         | 571  | 9    | 5          | 642  | 47   |
| Reduct Vol:               | 0           | 0    | 0    | 0           | 0    | 0    | 0          | 0    | 0    | 0          | 0    | 0    |
| Reduced Vol:              | 76          | 7    | 27   | 24          | 4    | 32   | 84         | 571  | 9    | 5          | 642  | 47   |
| PCE Adj:                  | 1.00        | 1.00 | 1.00 | 1.00        | 1.00 | 1.00 | 1.00       | 1.00 | 1.00 | 1.00       | 1.00 | 1.00 |
| MLF Adj:                  | 1.00        | 1.00 | 1.00 | 1.00        | 1.00 | 1.00 | 1.00       | 1.00 | 1.00 | 1.00       | 1.00 | 1.00 |
| Final Volume:             | 76          | 7    | 27   | 24          | 4    | 32   | 84         | 571  | 9    | 5          | 642  | 47   |
| Saturation Flow Module:   |             |      |      |             |      |      |            |      |      |            |      |      |
| Sat/Lane:                 | 1900        | 1900 | 1900 | 1900        | 1900 | 1900 | 1900       | 1900 | 1900 | 1900       | 1900 | 1900 |
| Adjustment:               | 0.95        | 0.95 | 0.92 | 0.95        | 0.95 | 0.92 | 0.95       | 0.95 | 0.95 | 0.95       | 0.95 | 0.95 |
| Lanes:                    | 0.92        | 0.08 | 1.00 | 0.86        | 0.14 | 1.00 | 0.25       | 1.72 | 0.03 | 0.01       | 1.85 | 0.14 |
| Final Sat.:               | 1648        | 152  | 1750 | 1543        | 257  | 1750 | 455        | 3096 | 49   | 26         | 3330 | 244  |
| Capacity Analysis Module: |             |      |      |             |      |      |            |      |      |            |      |      |
| Vol/Sat:                  | 0.05        | 0.05 | 0.02 | 0.02        | 0.02 | 0.02 | 0.18       | 0.18 | 0.18 | 0.19       | 0.19 | 0.19 |
| Crit Moves:               | ****        |      |      | ****        |      |      | ****       |      |      | ****       |      |      |
| Green Time:               | 14.3        | 14.3 | 14.3 | 14.3        | 14.3 | 14.3 | 59.7       | 59.7 | 59.7 | 59.7       | 59.7 | 59.7 |
| Volume/Cap:               | 0.26        | 0.26 | 0.09 | 0.09        | 0.09 | 0.10 | 0.25       | 0.25 | 0.25 | 0.26       | 0.26 | 0.26 |
| Delay/Veh:                | 28.7        | 28.7 | 27.5 | 27.5        | 27.5 | 27.6 | 3.2        | 3.2  | 3.2  | 3.2        | 3.2  | 3.2  |
| User DelAdj:              | 1.00        | 1.00 | 1.00 | 1.00        | 1.00 | 1.00 | 1.00       | 1.00 | 1.00 | 1.00       | 1.00 | 1.00 |
| AdjDel/Veh:               | 28.7        | 28.7 | 27.5 | 27.5        | 27.5 | 27.6 | 3.2        | 3.2  | 3.2  | 3.2        | 3.2  | 3.2  |
| LOS by Move:              | C           | C    | C    | C           | C    | C    | A          | A    | A    | A          | A    | A    |
| HCM2k95thQ:               | 4           | 4    | 1    | 1           | 1    | 2    | 5          | 5    | 5    | 5          | 5    | 5    |

Note: Queue reported is the number of cars per lane.

BART

Level Of Service Computation Report  
 2000 HCM Operations (Future Volume Alternative)  
 PM - Cumulative No Project

Intersection #3789: SANTA CLARA/21ST [Study Int 10]

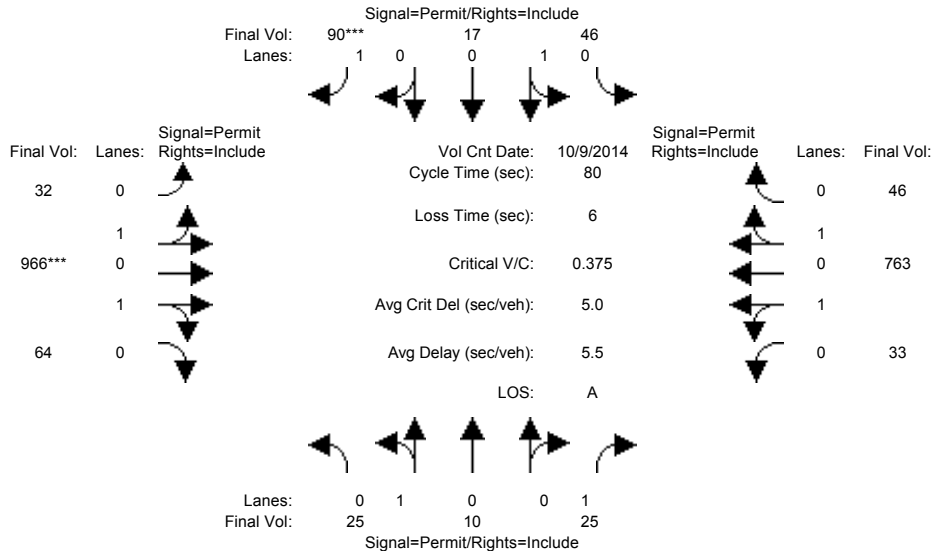

| Approach:                                   | North Bound |      |      | South Bound |      |      | East Bound |      |      | West Bound |      |      |
|---|-------------|------|------|-------------|------|------|------------|------|------|------------|------|------|
| Movement:                                   | L           | T    | R    | L           | T    | R    | L          | T    | R    | L          | T    | R    |
| Min. Green:                                 | 10          | 10   | 10   | 10          | 10   | 10   | 10         | 10   | 10   | 10         | 10   | 10   |
| Y+R:  | 4.0         | 4.0  | 4.0  | 4.0         | 4.0  | 4.0  | 4.0        | 4.0  | 4.0  | 4.0        | 4.0  | 4.0  |
| Volume Module: >> Count Date: 9 Oct 2014 << |             |      |      |             |      |      |            |      |      |            |      |      |
| Base Vol:                                   | 25          | 10   | 25   | 46          | 17   | 90   | 32         | 966  | 64   | 33         | 763  | 46   |
| Growth Adj:                                 | 1.00        | 1.00 | 1.00 | 1.00        | 1.00 | 1.00 | 1.00       | 1.00 | 1.00 | 1.00       | 1.00 | 1.00 |
| Initial Bse:                                | 25          | 10   | 25   | 46          | 17   | 90   | 32         | 966  | 64   | 33         | 763  | 46   |
| Added Vol:                                  | 0           | 0    | 0    | 0           | 0    | 0    | 0          | 0    | 0    | 0          | 0    | 0    |
| PasserByVol:                                | 0           | 0    | 0    | 0           | 0    | 0    | 0          | 0    | 0    | 0          | 0    | 0    |
| Initial Fut:                                | 25          | 10   | 25   | 46          | 17   | 90   | 32         | 966  | 64   | 33         | 763  | 46   |
| User Adj:                                   | 1.00        | 1.00 | 1.00 | 1.00        | 1.00 | 1.00 | 1.00       | 1.00 | 1.00 | 1.00       | 1.00 | 1.00 |
| PHF Adj:                                    | 1.00        | 1.00 | 1.00 | 1.00        | 1.00 | 1.00 | 1.00       | 1.00 | 1.00 | 1.00       | 1.00 | 1.00 |
| PHF Volume:                                 | 25          | 10   | 25   | 46          | 17   | 90   | 32         | 966  | 64   | 33         | 763  | 46   |
| Reduct Vol:                                 | 0           | 0    | 0    | 0           | 0    | 0    | 0          | 0    | 0    | 0          | 0    | 0    |
| Reduced Vol:                                | 25          | 10   | 25   | 46          | 17   | 90   | 32         | 966  | 64   | 33         | 763  | 46   |
| PCE Adj:                                    | 1.00        | 1.00 | 1.00 | 1.00        | 1.00 | 1.00 | 1.00       | 1.00 | 1.00 | 1.00       | 1.00 | 1.00 |
| MLF Adj:                                    | 1.00        | 1.00 | 1.00 | 1.00        | 1.00 | 1.00 | 1.00       | 1.00 | 1.00 | 1.00       | 1.00 | 1.00 |
| Final Volume:                               | 25          | 10   | 25   | 46          | 17   | 90   | 32         | 966  | 64   | 33         | 763  | 46   |
| Saturation Flow Module:                     |             |      |      |             |      |      |            |      |      |            |      |      |
| Sat/Lane:                                   | 1900        | 1900 | 1900 | 1900        | 1900 | 1900 | 1900       | 1900 | 1900 | 1900       | 1900 | 1900 |
| Adjustment:                                 | 0.95        | 0.95 | 0.92 | 0.95        | 0.95 | 0.92 | 0.95       | 0.95 | 0.95 | 0.95       | 0.95 | 0.95 |
| Lanes:                                      | 0.71        | 0.29 | 1.00 | 0.73        | 0.27 | 1.00 | 0.06       | 1.82 | 0.12 | 0.08       | 1.81 | 0.11 |
| Final Sat.:                                 | 1286        | 514  | 1750 | 1314        | 486  | 1750 | 108        | 3275 | 217  | 141        | 3262 | 197  |
| Capacity Analysis Module:                   |             |      |      |             |      |      |            |      |      |            |      |      |
| Vol/Sat:                                    | 0.02        | 0.02 | 0.01 | 0.04        | 0.04 | 0.05 | 0.30       | 0.30 | 0.30 | 0.23       | 0.23 | 0.23 |
| Crit Moves:                                 |             |      |      | ****        |      |      | ****       |      |      |            |      |      |
| Green Time:                                 | 11.0        | 11.0 | 11.0 | 11.0        | 11.0 | 11.0 | 63.0       | 63.0 | 63.0 | 63.0       | 63.0 | 63.0 |
| Volume/Cap:                                 | 0.14        | 0.14 | 0.10 | 0.25        | 0.25 | 0.37 | 0.37       | 0.37 | 0.37 | 0.30       | 0.30 | 0.30 |
| Delay/Veh:                                  | 30.6        | 30.6 | 30.4 | 31.4        | 31.4 | 32.4 | 2.6        | 2.6  | 2.6  | 2.4        | 2.4  | 2.4  |
| User DelAdj:                                | 1.00        | 1.00 | 1.00 | 1.00        | 1.00 | 1.00 | 1.00       | 1.00 | 1.00 | 1.00       | 1.00 | 1.00 |
| AdjDel/Veh:                                 | 30.6        | 30.6 | 30.4 | 31.4        | 31.4 | 32.4 | 2.6        | 2.6  | 2.6  | 2.4        | 2.4  | 2.4  |
| LOS by Move:                                | C           | C    | C    | C           | C    | C    | A          | A    | A    | A          | A    | A    |
| HCM2k95thQ:                                 | 2           | 2    | 1    | 3           | 3    | 5    | 8          | 8    | 8    | 6          | 6    | 6    |

Note: Queue reported is the number of cars per lane.

BART

Level Of Service Computation Report  
2000 HCM Operations (Future Volume Alternative)  
AM - Cumulative With Project

Intersection #3789: SANTA CLARA/21ST [Study Int 10]

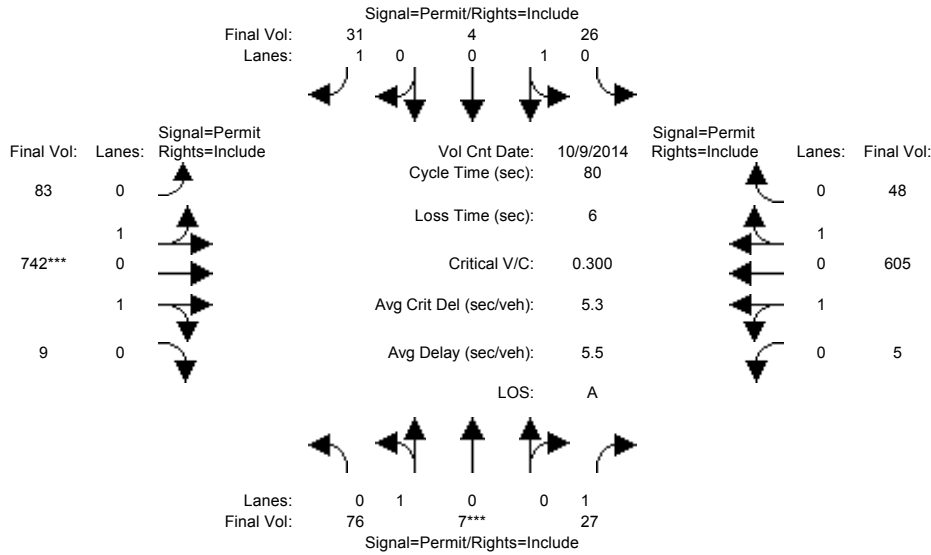

| Approach:                                   | North Bound |      |      | South Bound |      |      | East Bound |      |      | West Bound |      |      |
|---|-------------|------|------|-------------|------|------|------------|------|------|------------|------|------|
| Movement:                                   | L           | T    | R    | L           | T    | R    | L          | T    | R    | L          | T    | R    |
| Min. Green:                                 | 10          | 10   | 10   | 10          | 10   | 10   | 10         | 10   | 10   | 10         | 10   | 10   |
| Y+R:  | 4.0         | 4.0  | 4.0  | 4.0         | 4.0  | 4.0  | 4.0        | 4.0  | 4.0  | 4.0        | 4.0  | 4.0  |
| Volume Module: >> Count Date: 9 Oct 2014 << |             |      |      |             |      |      |            |      |      |            |      |      |
| Base Vol:                                   | 76          | 7    | 27   | 26          | 4    | 31   | 83         | 742  | 9    | 5          | 605  | 48   |
| Growth Adj:                                 | 1.00        | 1.00 | 1.00 | 1.00        | 1.00 | 1.00 | 1.00       | 1.00 | 1.00 | 1.00       | 1.00 | 1.00 |
| Initial Bse:                                | 76          | 7    | 27   | 26          | 4    | 31   | 83         | 742  | 9    | 5          | 605  | 48   |
| Added Vol:                                  | 0           | 0    | 0    | 0           | 0    | 0    | 0          | 0    | 0    | 0          | 0    | 0    |
| PasserByVol:                                | 0           | 0    | 0    | 0           | 0    | 0    | 0          | 0    | 0    | 0          | 0    | 0    |
| Initial Fut:                                | 76          | 7    | 27   | 26          | 4    | 31   | 83         | 742  | 9    | 5          | 605  | 48   |
| User Adj:                                   | 1.00        | 1.00 | 1.00 | 1.00        | 1.00 | 1.00 | 1.00       | 1.00 | 1.00 | 1.00       | 1.00 | 1.00 |
| PHF Adj:                                    | 1.00        | 1.00 | 1.00 | 1.00        | 1.00 | 1.00 | 1.00       | 1.00 | 1.00 | 1.00       | 1.00 | 1.00 |
| PHF Volume:                                 | 76          | 7    | 27   | 26          | 4    | 31   | 83         | 742  | 9    | 5          | 605  | 48   |
| Reduct Vol:                                 | 0           | 0    | 0    | 0           | 0    | 0    | 0          | 0    | 0    | 0          | 0    | 0    |
| Reduced Vol:                                | 76          | 7    | 27   | 26          | 4    | 31   | 83         | 742  | 9    | 5          | 605  | 48   |
| PCE Adj:                                    | 1.00        | 1.00 | 1.00 | 1.00        | 1.00 | 1.00 | 1.00       | 1.00 | 1.00 | 1.00       | 1.00 | 1.00 |
| MLF Adj:                                    | 1.00        | 1.00 | 1.00 | 1.00        | 1.00 | 1.00 | 1.00       | 1.00 | 1.00 | 1.00       | 1.00 | 1.00 |
| Final Volume:                               | 76          | 7    | 27   | 26          | 4    | 31   | 83         | 742  | 9    | 5          | 605  | 48   |
| Saturation Flow Module:                     |             |      |      |             |      |      |            |      |      |            |      |      |
| Sat/Lane:                                   | 1900        | 1900 | 1900 | 1900        | 1900 | 1900 | 1900       | 1900 | 1900 | 1900       | 1900 | 1900 |
| Adjustment:                                 | 0.95        | 0.95 | 0.92 | 0.95        | 0.95 | 0.92 | 0.95       | 0.95 | 0.95 | 0.95       | 0.95 | 0.95 |
| Lanes:                                      | 0.92        | 0.08 | 1.00 | 0.87        | 0.13 | 1.00 | 0.20       | 1.78 | 0.02 | 0.01       | 1.84 | 0.15 |
| Final Sat.:                                 | 1648        | 152  | 1750 | 1560        | 240  | 1750 | 358        | 3203 | 39   | 27         | 3310 | 263  |
| Capacity Analysis Module:                   |             |      |      |             |      |      |            |      |      |            |      |      |
| Vol/Sat:                                    | 0.05        | 0.05 | 0.02 | 0.02        | 0.02 | 0.02 | 0.23       | 0.23 | 0.23 | 0.18       | 0.18 | 0.18 |
| Crit Moves:                                 | ****        |      |      | ****        |      |      | ****       |      |      | ****       |      |      |
| Green Time:                                 | 12.3        | 12.3 | 12.3 | 12.3        | 12.3 | 12.3 | 61.7       | 61.7 | 61.7 | 61.7       | 61.7 | 61.7 |
| Volume/Cap:                                 | 0.30        | 0.30 | 0.10 | 0.11        | 0.11 | 0.12 | 0.30       | 0.30 | 0.30 | 0.24       | 0.24 | 0.24 |
| Delay/Veh:                                  | 30.7        | 30.7 | 29.3 | 29.3        | 29.3 | 29.4 | 2.8        | 2.8  | 2.8  | 2.6        | 2.6  | 2.6  |
| User DelAdj:                                | 1.00        | 1.00 | 1.00 | 1.00        | 1.00 | 1.00 | 1.00       | 1.00 | 1.00 | 1.00       | 1.00 | 1.00 |
| AdjDel/Veh:                                 | 30.7        | 30.7 | 29.3 | 29.3        | 29.3 | 29.4 | 2.8        | 2.8  | 2.8  | 2.6        | 2.6  | 2.6  |
| LOS by Move:                                | C           | C    | C    | C           | C    | C    | A          | A    | A    | A          | A    | A    |
| HCM2k95thQ:                                 | 4           | 4    | 1    | 2           | 2    | 2    | 6          | 6    | 6    | 5          | 5    | 5    |

Note: Queue reported is the number of cars per lane.

BART

Level Of Service Computation Report  
 2000 HCM Operations (Future Volume Alternative)  
 PM - Cumulative With Project

Intersection #3789: SANTA CLARA/21ST [Study Int 10]

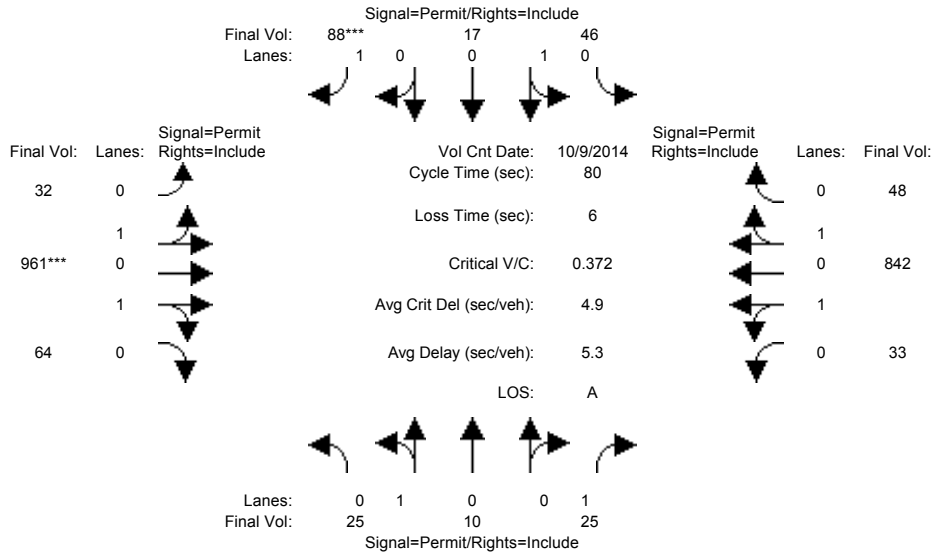

| Approach:                     | North Bound   |      |      | South Bound |      |      | East Bound |      |      | West Bound |      |      |
|-------------------------------|---------------|------|------|-------------|------|------|------------|------|------|------------|------|------|
| Movement:                     | L             | T    | R    | L           | T    | R    | L          | T    | R    | L          | T    | R    |
| Min. Green:                   | 10            | 10   | 10   | 10          | 10   | 10   | 10         | 10   | 10   | 10         | 10   | 10   |
| Y+R:                          | 4.0           | 4.0  | 4.0  | 4.0         | 4.0  | 4.0  | 4.0        | 4.0  | 4.0  | 4.0        | 4.0  | 4.0  |
| -----                         |               |      |      |             |      |      |            |      |      |            |      |      |
| Volume Module: >> Count Date: | 9 Oct 2014 << |      |      |             |      |      |            |      |      |            |      |      |
| Base Vol:                     | 25            | 10   | 25   | 46          | 17   | 88   | 32         | 961  | 64   | 33         | 842  | 48   |
| Growth Adj:                   | 1.00          | 1.00 | 1.00 | 1.00        | 1.00 | 1.00 | 1.00       | 1.00 | 1.00 | 1.00       | 1.00 | 1.00 |
| Initial Bse:                  | 25            | 10   | 25   | 46          | 17   | 88   | 32         | 961  | 64   | 33         | 842  | 48   |
| Added Vol:                    | 0             | 0    | 0    | 0           | 0    | 0    | 0          | 0    | 0    | 0          | 0    | 0    |
| PasserByVol:                  | 0             | 0    | 0    | 0           | 0    | 0    | 0          | 0    | 0    | 0          | 0    | 0    |
| Initial Fut:                  | 25            | 10   | 25   | 46          | 17   | 88   | 32         | 961  | 64   | 33         | 842  | 48   |
| User Adj:                     | 1.00          | 1.00 | 1.00 | 1.00        | 1.00 | 1.00 | 1.00       | 1.00 | 1.00 | 1.00       | 1.00 | 1.00 |
| PHF Adj:                      | 1.00          | 1.00 | 1.00 | 1.00        | 1.00 | 1.00 | 1.00       | 1.00 | 1.00 | 1.00       | 1.00 | 1.00 |
| PHF Volume:                   | 25            | 10   | 25   | 46          | 17   | 88   | 32         | 961  | 64   | 33         | 842  | 48   |
| Reduct Vol:                   | 0             | 0    | 0    | 0           | 0    | 0    | 0          | 0    | 0    | 0          | 0    | 0    |
| Reduced Vol:                  | 25            | 10   | 25   | 46          | 17   | 88   | 32         | 961  | 64   | 33         | 842  | 48   |
| PCE Adj:                      | 1.00          | 1.00 | 1.00 | 1.00        | 1.00 | 1.00 | 1.00       | 1.00 | 1.00 | 1.00       | 1.00 | 1.00 |
| MLF Adj:                      | 1.00          | 1.00 | 1.00 | 1.00        | 1.00 | 1.00 | 1.00       | 1.00 | 1.00 | 1.00       | 1.00 | 1.00 |
| Final Volume:                 | 25            | 10   | 25   | 46          | 17   | 88   | 32         | 961  | 64   | 33         | 842  | 48   |
| -----                         |               |      |      |             |      |      |            |      |      |            |      |      |
| Saturation Flow Module:       |               |      |      |             |      |      |            |      |      |            |      |      |
| Sat/Lane:                     | 1900          | 1900 | 1900 | 1900        | 1900 | 1900 | 1900       | 1900 | 1900 | 1900       | 1900 | 1900 |
| Adjustment:                   | 0.95          | 0.95 | 0.92 | 0.95        | 0.95 | 0.92 | 0.95       | 0.95 | 0.95 | 0.95       | 0.95 | 0.95 |
| Lanes:                        | 0.71          | 0.29 | 1.00 | 0.73        | 0.27 | 1.00 | 0.06       | 1.82 | 0.12 | 0.07       | 1.83 | 0.10 |
| Final Sat.:                   | 1286          | 514  | 1750 | 1314        | 486  | 1750 | 109        | 3273 | 218  | 129        | 3284 | 187  |
| -----                         |               |      |      |             |      |      |            |      |      |            |      |      |
| Capacity Analysis Module:     |               |      |      |             |      |      |            |      |      |            |      |      |
| Vol/Sat:                      | 0.02          | 0.02 | 0.01 | 0.04        | 0.04 | 0.05 | 0.29       | 0.29 | 0.29 | 0.26       | 0.26 | 0.26 |
| Crit Moves:                   | *****         |      |      |             |      |      |            |      |      |            |      |      |
| Green Time:                   | 10.8          | 10.8 | 10.8 | 10.8        | 10.8 | 10.8 | 63.2       | 63.2 | 63.2 | 63.2       | 63.2 | 63.2 |
| Volume/Cap:                   | 0.14          | 0.14 | 0.11 | 0.26        | 0.26 | 0.37 | 0.37       | 0.37 | 0.37 | 0.32       | 0.32 | 0.32 |
| Delay/Veh:                    | 30.8          | 30.8 | 30.5 | 31.6        | 31.6 | 32.5 | 2.6        | 2.6  | 2.6  | 2.4        | 2.4  | 2.4  |
| User DelAdj:                  | 1.00          | 1.00 | 1.00 | 1.00        | 1.00 | 1.00 | 1.00       | 1.00 | 1.00 | 1.00       | 1.00 | 1.00 |
| AdjDel/Veh:                   | 30.8          | 30.8 | 30.5 | 31.6        | 31.6 | 32.5 | 2.6        | 2.6  | 2.6  | 2.4        | 2.4  | 2.4  |
| LOS by Move:                  | C             | C    | C    | C           | C    | C    | A          | A    | A    | A          | A    | A    |
| HCM2k95thQ:                   | 2             | 2    | 1    | 3           | 3    | 5    | 8          | 8    | 8    | 7          | 7    | 7    |

Note: Queue reported is the number of cars per lane.

BART

Level Of Service Computation Report  
2000 HCM Operations (Future Volume Alternative)  
AM - Cumulative No Project

Intersection #3790: SANTA CLARA/24TH [Study Int 11]

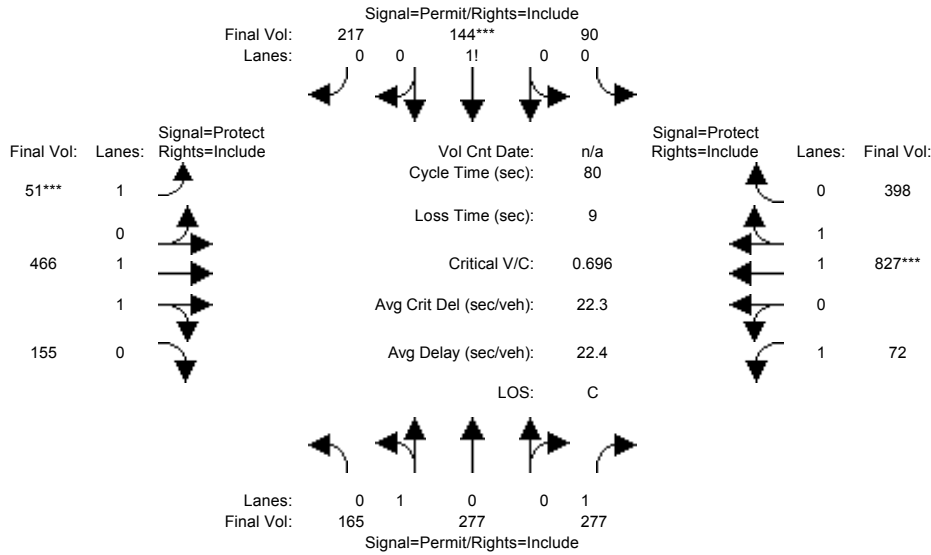

| Approach:                 | North Bound |      |      | South Bound |      |      | East Bound |      |      | West Bound |      |      |
|---------------------------|-------------|------|------|-------------|------|------|------------|------|------|------------|------|------|
| Movement:                 | L           | T    | R    | L           | T    | R    | L          | T    | R    | L          | T    | R    |
| Min. Green:               | 10          | 10   | 10   | 10          | 10   | 10   | 7          | 10   | 10   | 7          | 10   | 10   |
| Y+R:                      | 4.0         | 4.0  | 4.0  | 4.0         | 4.0  | 4.0  | 4.0        | 4.0  | 4.0  | 4.0        | 4.0  | 4.0  |
| Volume Module:            |             |      |      |             |      |      |            |      |      |            |      |      |
| Base Vol:                 | 165         | 277  | 277  | 90          | 144  | 217  | 51         | 466  | 155  | 72         | 827  | 398  |
| Growth Adj:               | 1.00        | 1.00 | 1.00 | 1.00        | 1.00 | 1.00 | 1.00       | 1.00 | 1.00 | 1.00       | 1.00 | 1.00 |
| Initial Bse:              | 165         | 277  | 277  | 90          | 144  | 217  | 51         | 466  | 155  | 72         | 827  | 398  |
| Added Vol:                | 0           | 0    | 0    | 0           | 0    | 0    | 0          | 0    | 0    | 0          | 0    | 0    |
| PasserByVol:              | 0           | 0    | 0    | 0           | 0    | 0    | 0          | 0    | 0    | 0          | 0    | 0    |
| Initial Fut:              | 165         | 277  | 277  | 90          | 144  | 217  | 51         | 466  | 155  | 72         | 827  | 398  |
| User Adj:                 | 1.00        | 1.00 | 1.00 | 1.00        | 1.00 | 1.00 | 1.00       | 1.00 | 1.00 | 1.00       | 1.00 | 1.00 |
| PHF Adj:                  | 1.00        | 1.00 | 1.00 | 1.00        | 1.00 | 1.00 | 1.00       | 1.00 | 1.00 | 1.00       | 1.00 | 1.00 |
| PHF Volume:               | 165         | 277  | 277  | 90          | 144  | 217  | 51         | 466  | 155  | 72         | 827  | 398  |
| Reduct Vol:               | 0           | 0    | 0    | 0           | 0    | 0    | 0          | 0    | 0    | 0          | 0    | 0    |
| Reduced Vol:              | 165         | 277  | 277  | 90          | 144  | 217  | 51         | 466  | 155  | 72         | 827  | 398  |
| PCE Adj:                  | 1.00        | 1.00 | 1.00 | 1.00        | 1.00 | 1.00 | 1.00       | 1.00 | 1.00 | 1.00       | 1.00 | 1.00 |
| MLF Adj:                  | 1.00        | 1.00 | 1.00 | 1.00        | 1.00 | 1.00 | 1.00       | 1.00 | 1.00 | 1.00       | 1.00 | 1.00 |
| Final Volume:             | 165         | 277  | 277  | 90          | 144  | 217  | 51         | 466  | 155  | 72         | 827  | 398  |
| Saturation Flow Module:   |             |      |      |             |      |      |            |      |      |            |      |      |
| Sat/Lane:                 | 1900        | 1900 | 1900 | 1900        | 1900 | 1900 | 1900       | 1900 | 1900 | 1900       | 1900 | 1900 |
| Adjustment:               | 0.95        | 0.95 | 0.92 | 0.92        | 0.92 | 0.92 | 0.92       | 0.98 | 0.95 | 0.92       | 0.99 | 0.95 |
| Lanes:                    | 0.37        | 0.63 | 1.00 | 0.20        | 0.32 | 0.48 | 1.00       | 1.49 | 0.51 | 1.00       | 1.33 | 0.67 |
| Final Sat.:               | 672         | 1128 | 1750 | 349         | 559  | 842  | 1750       | 2776 | 923  | 1750       | 2497 | 1202 |
| Capacity Analysis Module: |             |      |      |             |      |      |            |      |      |            |      |      |
| Vol/Sat:                  | 0.25        | 0.25 | 0.16 | 0.26        | 0.26 | 0.26 | 0.03       | 0.17 | 0.17 | 0.04       | 0.33 | 0.33 |
| Crit Moves:               |             |      |      | ****        | **** | **** | ****       | **** | **** | ****       | **** | **** |
| Green Time:               | 28.0        | 28.0 | 28.0 | 28.0        | 28.0 | 28.0 | 7.0        | 28.3 | 28.3 | 14.7       | 36.0 | 36.0 |
| Volume/Cap:               | 0.70        | 0.70 | 0.45 | 0.74        | 0.74 | 0.74 | 0.33       | 0.48 | 0.48 | 0.22       | 0.74 | 0.74 |
| Delay/Veh:                | 25.9        | 25.9 | 20.6 | 27.4        | 27.4 | 27.4 | 35.6       | 20.4 | 20.4 | 28.1       | 19.9 | 19.9 |
| User DelAdj:              | 1.00        | 1.00 | 1.00 | 1.00        | 1.00 | 1.00 | 1.00       | 1.00 | 1.00 | 1.00       | 1.00 | 1.00 |
| AdjDel/Veh:               | 25.9        | 25.9 | 20.6 | 27.4        | 27.4 | 27.4 | 35.6       | 20.4 | 20.4 | 28.1       | 19.9 | 19.9 |
| LOS by Move:              | C           | C    | C    | C           | C    | C    | D          | C    | C    | C          | B    | B    |
| HCM2k95thQ:               | 19          | 19   | 11   | 22          | 22   | 22   | 3          | 11   | 11   | 3          | 23   | 23   |

Note: Queue reported is the number of cars per lane.



BART

Level Of Service Computation Report  
2000 HCM Operations (Future Volume Alternative)  
PM - Cumulative No Project

Intersection #3790: SANTA CLARA/24TH [Study Int 11]

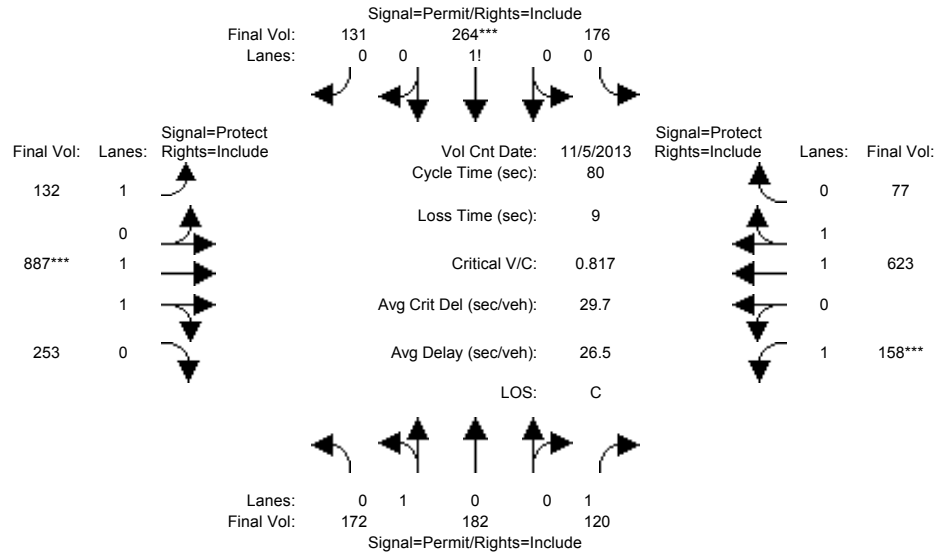

| Approach:                                   | North Bound |      |      | South Bound |      |      | East Bound |      |      | West Bound |      |      |
|---|-------------|------|------|-------------|------|------|------------|------|------|------------|------|------|
| Movement:                                   | L           | T    | R    | L           | T    | R    | L          | T    | R    | L          | T    | R    |
| Min. Green:                                 | 10          | 10   | 10   | 10          | 10   | 10   | 7          | 10   | 10   | 7          | 10   | 10   |
| Y+R:  | 4.0         | 4.0  | 4.0  | 4.0         | 4.0  | 4.0  | 4.0        | 4.0  | 4.0  | 4.0        | 4.0  | 4.0  |
| -----                                       |             |      |      |             |      |      |            |      |      |            |      |      |
| Volume Module: >> Count Date: 5 Nov 2013 << |             |      |      |             |      |      |            |      |      |            |      |      |
| Base Vol:                                   | 172         | 182  | 120  | 176         | 264  | 131  | 132        | 887  | 253  | 158        | 623  | 77   |
| Growth Adj:                                 | 1.00        | 1.00 | 1.00 | 1.00        | 1.00 | 1.00 | 1.00       | 1.00 | 1.00 | 1.00       | 1.00 | 1.00 |
| Initial Bse:                                | 172         | 182  | 120  | 176         | 264  | 131  | 132        | 887  | 253  | 158        | 623  | 77   |
| Added Vol:                                  | 0           | 0    | 0    | 0           | 0    | 0    | 0          | 0    | 0    | 0          | 0    | 0    |
| PasserByVol:                                | 0           | 0    | 0    | 0           | 0    | 0    | 0          | 0    | 0    | 0          | 0    | 0    |
| Initial Fut:                                | 172         | 182  | 120  | 176         | 264  | 131  | 132        | 887  | 253  | 158        | 623  | 77   |
| User Adj:                                   | 1.00        | 1.00 | 1.00 | 1.00        | 1.00 | 1.00 | 1.00       | 1.00 | 1.00 | 1.00       | 1.00 | 1.00 |
| PHF Adj:                                    | 1.00        | 1.00 | 1.00 | 1.00        | 1.00 | 1.00 | 1.00       | 1.00 | 1.00 | 1.00       | 1.00 | 1.00 |
| PHF Volume:                                 | 172         | 182  | 120  | 176         | 264  | 131  | 132        | 887  | 253  | 158        | 623  | 77   |
| Reduct Vol:                                 | 0           | 0    | 0    | 0           | 0    | 0    | 0          | 0    | 0    | 0          | 0    | 0    |
| Reduced Vol:                                | 172         | 182  | 120  | 176         | 264  | 131  | 132        | 887  | 253  | 158        | 623  | 77   |
| PCE Adj:                                    | 1.00        | 1.00 | 1.00 | 1.00        | 1.00 | 1.00 | 1.00       | 1.00 | 1.00 | 1.00       | 1.00 | 1.00 |
| MLF Adj:                                    | 1.00        | 1.00 | 1.00 | 1.00        | 1.00 | 1.00 | 1.00       | 1.00 | 1.00 | 1.00       | 1.00 | 1.00 |
| Final Volume:                               | 172         | 182  | 120  | 176         | 264  | 131  | 132        | 887  | 253  | 158        | 623  | 77   |
| -----                                       |             |      |      |             |      |      |            |      |      |            |      |      |
| Saturation Flow Module:                     |             |      |      |             |      |      |            |      |      |            |      |      |
| Sat/Lane:                                   | 1900        | 1900 | 1900 | 1900        | 1900 | 1900 | 1900       | 1900 | 1900 | 1900       | 1900 | 1900 |
| Adjustment:                                 | 0.95        | 0.95 | 0.92 | 0.92        | 0.92 | 0.92 | 0.92       | 0.98 | 0.95 | 0.92       | 0.98 | 0.95 |
| Lanes:                                      | 0.49        | 0.51 | 1.00 | 0.31        | 0.46 | 0.23 | 1.00       | 1.54 | 0.46 | 1.00       | 1.77 | 0.23 |
| Final Sat.:                                 | 875         | 925  | 1750 | 539         | 809  | 401  | 1750       | 2878 | 821  | 1750       | 3293 | 407  |
| -----                                       |             |      |      |             |      |      |            |      |      |            |      |      |
| Capacity Analysis Module:                   |             |      |      |             |      |      |            |      |      |            |      |      |
| Vol/Sat:                                    | 0.20        | 0.20 | 0.07 | 0.33        | 0.33 | 0.33 | 0.08       | 0.31 | 0.31 | 0.09       | 0.19 | 0.19 |
| Crit Moves:                                 | *****       |      |      |             |      |      |            |      |      |            |      |      |
| Green Time:                                 | 32.0        | 32.0 | 32.0 | 32.0        | 32.0 | 32.0 | 12.3       | 30.2 | 30.2 | 8.8        | 26.7 | 26.7 |
| Volume/Cap:                                 | 0.49        | 0.49 | 0.17 | 0.82        | 0.82 | 0.82 | 0.49       | 0.82 | 0.82 | 0.82       | 0.57 | 0.57 |
| Delay/Veh:                                  | 18.5        | 18.5 | 15.6 | 28.8        | 28.8 | 28.8 | 32.3       | 26.3 | 26.3 | 57.7       | 22.5 | 22.5 |
| User DelAdj:                                | 1.00        | 1.00 | 1.00 | 1.00        | 1.00 | 1.00 | 1.00       | 1.00 | 1.00 | 1.00       | 1.00 | 1.00 |
| AdjDel/Veh:                                 | 18.5        | 18.5 | 15.6 | 28.8        | 28.8 | 28.8 | 32.3       | 26.3 | 26.3 | 57.7       | 22.5 | 22.5 |
| LOS by Move:                                | B           | B    | B    | C           | C    | C    | C          | C    | C    | E          | C    | C    |
| HCM2k95thQ:                                 | 13          | 13   | 4    | 28          | 28   | 28   | 6          | 24   | 24   | 9          | 14   | 14   |

Note: Queue reported is the number of cars per lane.

BART

Level Of Service Computation Report  
2000 HCM Operations (Future Volume Alternative)  
AM - Cumulative With Project

Intersection #3790: SANTA CLARA/24TH [Study Int 11]

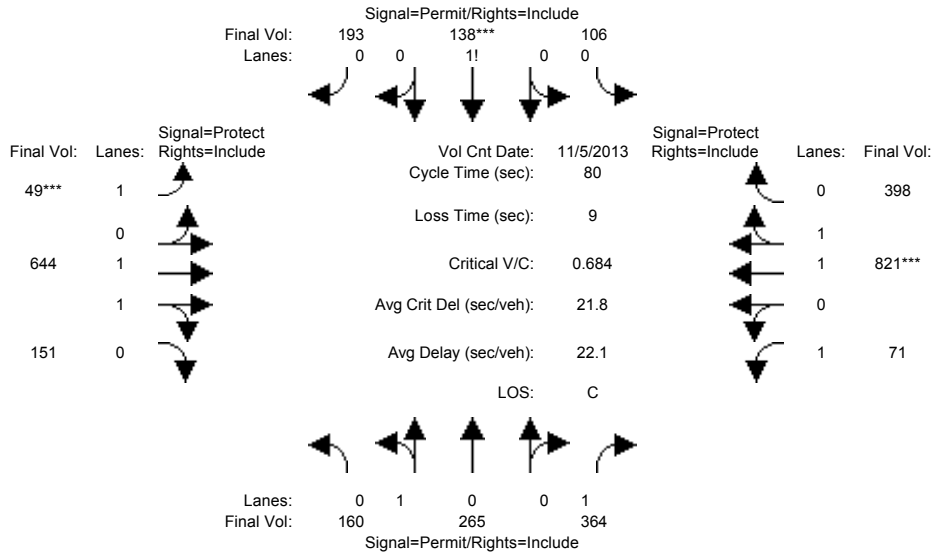

| Approach:                                   | North Bound |      |      | South Bound |      |      | East Bound |      |      | West Bound |      |      |
|---|-------------|------|------|-------------|------|------|------------|------|------|------------|------|------|
| Movement:                                   | L           | T    | R    | L           | T    | R    | L          | T    | R    | L          | T    | R    |
| Min. Green:                                 | 10          | 10   | 10   | 10          | 10   | 10   | 7          | 10   | 10   | 7          | 10   | 10   |
| Y+R:  | 4.0         | 4.0  | 4.0  | 4.0         | 4.0  | 4.0  | 4.0        | 4.0  | 4.0  | 4.0        | 4.0  | 4.0  |
| Volume Module: >> Count Date: 5 Nov 2013 << |             |      |      |             |      |      |            |      |      |            |      |      |
| Base Vol:                                   | 160         | 265  | 364  | 106         | 138  | 193  | 49         | 644  | 151  | 71         | 821  | 398  |
| Growth Adj:                                 | 1.00        | 1.00 | 1.00 | 1.00        | 1.00 | 1.00 | 1.00       | 1.00 | 1.00 | 1.00       | 1.00 | 1.00 |
| Initial Bse:                                | 160         | 265  | 364  | 106         | 138  | 193  | 49         | 644  | 151  | 71         | 821  | 398  |
| Added Vol:                                  | 0           | 0    | 0    | 0           | 0    | 0    | 0          | 0    | 0    | 0          | 0    | 0    |
| PasserByVol:                                | 0           | 0    | 0    | 0           | 0    | 0    | 0          | 0    | 0    | 0          | 0    | 0    |
| Initial Fut:                                | 160         | 265  | 364  | 106         | 138  | 193  | 49         | 644  | 151  | 71         | 821  | 398  |
| User Adj:                                   | 1.00        | 1.00 | 1.00 | 1.00        | 1.00 | 1.00 | 1.00       | 1.00 | 1.00 | 1.00       | 1.00 | 1.00 |
| PHF Adj:                                    | 1.00        | 1.00 | 1.00 | 1.00        | 1.00 | 1.00 | 1.00       | 1.00 | 1.00 | 1.00       | 1.00 | 1.00 |
| PHF Volume:                                 | 160         | 265  | 364  | 106         | 138  | 193  | 49         | 644  | 151  | 71         | 821  | 398  |
| Reduct Vol:                                 | 0           | 0    | 0    | 0           | 0    | 0    | 0          | 0    | 0    | 0          | 0    | 0    |
| Reduced Vol:                                | 160         | 265  | 364  | 106         | 138  | 193  | 49         | 644  | 151  | 71         | 821  | 398  |
| PCE Adj:                                    | 1.00        | 1.00 | 1.00 | 1.00        | 1.00 | 1.00 | 1.00       | 1.00 | 1.00 | 1.00       | 1.00 | 1.00 |
| MLF Adj:                                    | 1.00        | 1.00 | 1.00 | 1.00        | 1.00 | 1.00 | 1.00       | 1.00 | 1.00 | 1.00       | 1.00 | 1.00 |
| Final Volume:                               | 160         | 265  | 364  | 106         | 138  | 193  | 49         | 644  | 151  | 71         | 821  | 398  |
| Saturation Flow Module:                     |             |      |      |             |      |      |            |      |      |            |      |      |
| Sat/Lane:                                   | 1900        | 1900 | 1900 | 1900        | 1900 | 1900 | 1900       | 1900 | 1900 | 1900       | 1900 | 1900 |
| Adjustment:                                 | 0.95        | 0.95 | 0.92 | 0.92        | 0.92 | 0.92 | 0.92       | 0.98 | 0.95 | 0.92       | 0.99 | 0.95 |
| Lanes:                                      | 0.38        | 0.62 | 1.00 | 0.24        | 0.32 | 0.44 | 1.00       | 1.61 | 0.39 | 1.00       | 1.33 | 0.67 |
| Final Sat.:                                 | 678         | 1122 | 1750 | 424         | 553  | 773  | 1750       | 2997 | 703  | 1750       | 2491 | 1208 |
| Capacity Analysis Module:                   |             |      |      |             |      |      |            |      |      |            |      |      |
| Vol/Sat:                                    | 0.24        | 0.24 | 0.21 | 0.25        | 0.25 | 0.25 | 0.03       | 0.21 | 0.21 | 0.04       | 0.33 | 0.33 |
| Crit Moves:                                 | *****       |      |      |             |      |      |            |      |      |            |      |      |
| Green Time:                                 | 27.6        | 27.6 | 27.6 | 27.6        | 27.6 | 27.6 | 7.0        | 30.9 | 30.9 | 12.6       | 36.4 | 36.4 |
| Volume/Cap:                                 | 0.68        | 0.68 | 0.60 | 0.72        | 0.72 | 0.72 | 0.32       | 0.56 | 0.56 | 0.26       | 0.72 | 0.72 |
| Delay/Veh:                                  | 25.6        | 25.6 | 23.4 | 27.2        | 27.2 | 27.2 | 35.5       | 19.7 | 19.7 | 30.1       | 19.3 | 19.3 |
| User DelAdj:                                | 1.00        | 1.00 | 1.00 | 1.00        | 1.00 | 1.00 | 1.00       | 1.00 | 1.00 | 1.00       | 1.00 | 1.00 |
| AdjDel/Veh:                                 | 25.6        | 25.6 | 23.4 | 27.2        | 27.2 | 27.2 | 35.5       | 19.7 | 19.7 | 30.1       | 19.3 | 19.3 |
| LOS by Move:                                | C           | C    | C    | C           | C    | C    | D          | B    | B    | C          | B    | B    |
| HCM2k95thQ:                                 | 18          | 18   | 15   | 21          | 21   | 21   | 2          | 15   | 15   | 3          | 23   | 23   |

Note: Queue reported is the number of cars per lane.

BART

Level Of Service Computation Report  
 2000 HCM Operations (Future Volume Alternative)  
 PM - Cumulative With Project

Intersection #3790: SANTA CLARA/24TH [Study Int 11]

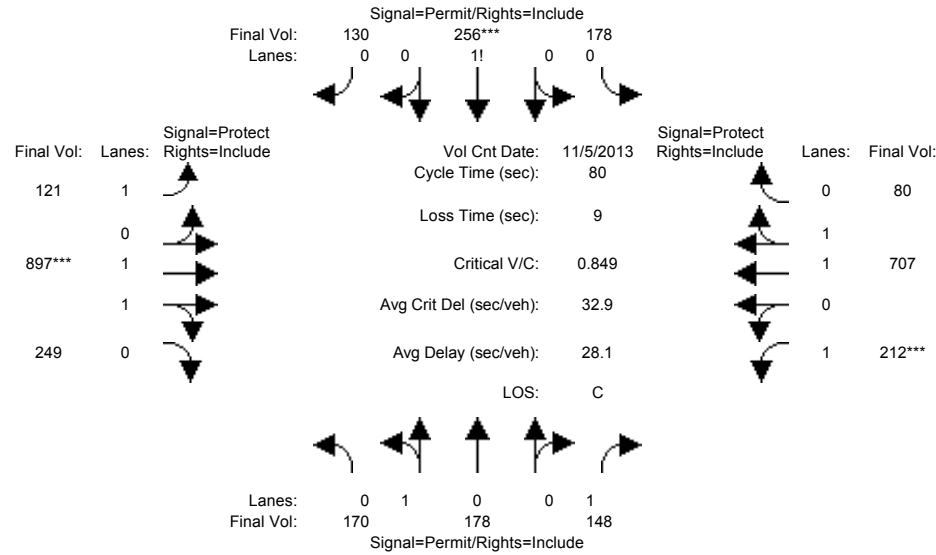

| Approach:                                   | North Bound |      |      | South Bound |      |      | East Bound |      |      | West Bound |      |      |
|---|-------------|------|------|-------------|------|------|------------|------|------|------------|------|------|
| Movement:                                   | L           | T    | R    | L           | T    | R    | L          | T    | R    | L          | T    | R    |
| Min. Green:                                 | 10          | 10   | 10   | 10          | 10   | 10   | 7          | 10   | 10   | 7          | 10   | 10   |
| Y+R:  | 4.0         | 4.0  | 4.0  | 4.0         | 4.0  | 4.0  | 4.0        | 4.0  | 4.0  | 4.0        | 4.0  | 4.0  |
| Volume Module: >> Count Date: 5 Nov 2013 << |             |      |      |             |      |      |            |      |      |            |      |      |
| Base Vol:                                   | 170         | 178  | 148  | 178         | 256  | 130  | 121        | 897  | 249  | 212        | 707  | 80   |
| Growth Adj:                                 | 1.00        | 1.00 | 1.00 | 1.00        | 1.00 | 1.00 | 1.00       | 1.00 | 1.00 | 1.00       | 1.00 | 1.00 |
| Initial Bse:                                | 170         | 178  | 148  | 178         | 256  | 130  | 121        | 897  | 249  | 212        | 707  | 80   |
| Added Vol:                                  | 0           | 0    | 0    | 0           | 0    | 0    | 0          | 0    | 0    | 0          | 0    | 0    |
| PasserByVol:                                | 0           | 0    | 0    | 0           | 0    | 0    | 0          | 0    | 0    | 0          | 0    | 0    |
| Initial Fut:                                | 170         | 178  | 148  | 178         | 256  | 130  | 121        | 897  | 249  | 212        | 707  | 80   |
| User Adj:                                   | 1.00        | 1.00 | 1.00 | 1.00        | 1.00 | 1.00 | 1.00       | 1.00 | 1.00 | 1.00       | 1.00 | 1.00 |
| PHF Adj:                                    | 1.00        | 1.00 | 1.00 | 1.00        | 1.00 | 1.00 | 1.00       | 1.00 | 1.00 | 1.00       | 1.00 | 1.00 |
| PHF Volume:                                 | 170         | 178  | 148  | 178         | 256  | 130  | 121        | 897  | 249  | 212        | 707  | 80   |
| Reduct Vol:                                 | 0           | 0    | 0    | 0           | 0    | 0    | 0          | 0    | 0    | 0          | 0    | 0    |
| Reduced Vol:                                | 170         | 178  | 148  | 178         | 256  | 130  | 121        | 897  | 249  | 212        | 707  | 80   |
| PCE Adj:                                    | 1.00        | 1.00 | 1.00 | 1.00        | 1.00 | 1.00 | 1.00       | 1.00 | 1.00 | 1.00       | 1.00 | 1.00 |
| MLF Adj:                                    | 1.00        | 1.00 | 1.00 | 1.00        | 1.00 | 1.00 | 1.00       | 1.00 | 1.00 | 1.00       | 1.00 | 1.00 |
| Final Volume:                               | 170         | 178  | 148  | 178         | 256  | 130  | 121        | 897  | 249  | 212        | 707  | 80   |
| Saturation Flow Module:                     |             |      |      |             |      |      |            |      |      |            |      |      |
| Sat/Lane:                                   | 1900        | 1900 | 1900 | 1900        | 1900 | 1900 | 1900       | 1900 | 1900 | 1900       | 1900 | 1900 |
| Adjustment:                                 | 0.95        | 0.95 | 0.92 | 0.92        | 0.92 | 0.92 | 0.92       | 0.98 | 0.95 | 0.92       | 0.98 | 0.95 |
| Lanes:                                      | 0.49        | 0.51 | 1.00 | 0.32        | 0.45 | 0.23 | 1.00       | 1.55 | 0.45 | 1.00       | 1.79 | 0.21 |
| Final Sat.:                                 | 879         | 921  | 1750 | 552         | 794  | 403  | 1750       | 2895 | 804  | 1750       | 3324 | 376  |
| Capacity Analysis Module:                   |             |      |      |             |      |      |            |      |      |            |      |      |
| Vol/Sat:                                    | 0.19        | 0.19 | 0.08 | 0.32        | 0.32 | 0.32 | 0.07       | 0.31 | 0.31 | 0.12       | 0.21 | 0.21 |
| Crit Moves:                                 |             |      |      | ****        |      |      | ****       |      |      | ****       |      |      |
| Green Time:                                 | 30.4        | 30.4 | 30.4 | 30.4        | 30.4 | 30.4 | 11.8       | 29.2 | 29.2 | 11.4       | 28.8 | 28.8 |
| Volume/Cap:                                 | 0.51        | 0.51 | 0.22 | 0.85        | 0.85 | 0.85 | 0.47       | 0.85 | 0.85 | 0.85       | 0.59 | 0.59 |
| Delay/Veh:                                  | 19.7        | 19.7 | 17.0 | 32.7        | 32.7 | 32.7 | 32.5       | 28.6 | 28.6 | 56.4       | 21.5 | 21.5 |
| User DelAdj:                                | 1.00        | 1.00 | 1.00 | 1.00        | 1.00 | 1.00 | 1.00       | 1.00 | 1.00 | 1.00       | 1.00 | 1.00 |
| AdjDel/Veh:                                 | 19.7        | 19.7 | 17.0 | 32.7        | 32.7 | 32.7 | 32.5       | 28.6 | 28.6 | 56.4       | 21.5 | 21.5 |
| LOS by Move:                                | B           | B    | B    | C           | C    | C    | C          | C    | C    | E          | C    | C    |
| HCM2k95thQ:                                 | 13          | 13   | 5    | 29          | 29   | 29   | 6          | 25   | 25   | 12         | 15   | 15   |

Note: Queue reported is the number of cars per lane.

BART

Level Of Service Computation Report  
2000 HCM Operations (Future Volume Alternative)  
AM - Cumulative No Project

Intersection #3832: 24TH/WILLIAM [Study Int 24]

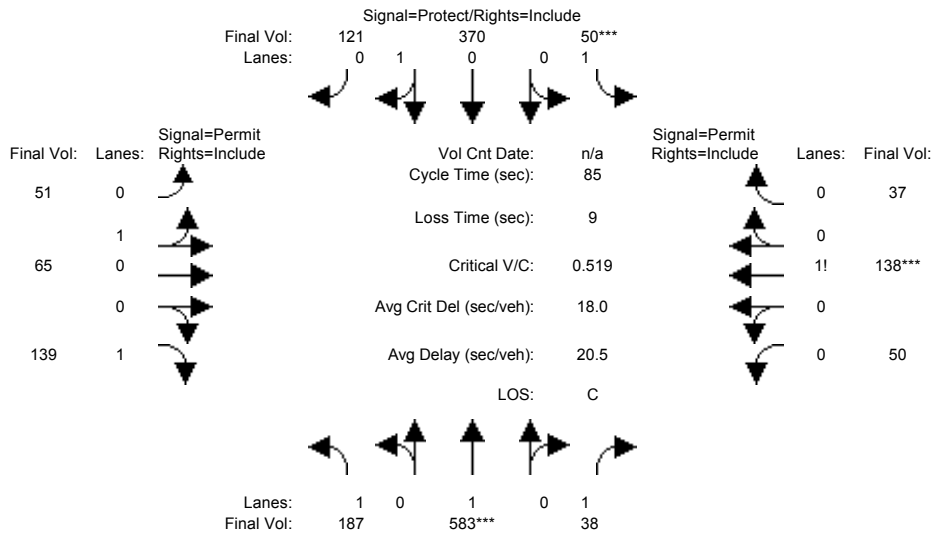

| Approach:                 | North Bound |      |      | South Bound |      |      | East Bound |      |      | West Bound |      |      |
|---------------------------|-------------|------|------|-------------|------|------|------------|------|------|------------|------|------|
| Movement:                 | L           | T    | R    | L           | T    | R    | L          | T    | R    | L          | T    | R    |
| Min. Green:               | 7           | 10   | 10   | 7           | 10   | 10   | 10         | 10   | 10   | 10         | 10   | 10   |
| Y+R:                      | 4.0         | 4.0  | 4.0  | 4.0         | 4.0  | 4.0  | 4.0        | 4.0  | 4.0  | 4.0        | 4.0  | 4.0  |
| Volume Module:            |             |      |      |             |      |      |            |      |      |            |      |      |
| Base Vol:                 | 187         | 583  | 38   | 50          | 370  | 121  | 51         | 65   | 139  | 50         | 138  | 37   |
| Growth Adj:               | 1.00        | 1.00 | 1.00 | 1.00        | 1.00 | 1.00 | 1.00       | 1.00 | 1.00 | 1.00       | 1.00 | 1.00 |
| Initial Bse:              | 187         | 583  | 38   | 50          | 370  | 121  | 51         | 65   | 139  | 50         | 138  | 37   |
| Added Vol:                | 0           | 0    | 0    | 0           | 0    | 0    | 0          | 0    | 0    | 0          | 0    | 0    |
| PasserByVol:              | 0           | 0    | 0    | 0           | 0    | 0    | 0          | 0    | 0    | 0          | 0    | 0    |
| Initial Fut:              | 187         | 583  | 38   | 50          | 370  | 121  | 51         | 65   | 139  | 50         | 138  | 37   |
| User Adj:                 | 1.00        | 1.00 | 1.00 | 1.00        | 1.00 | 1.00 | 1.00       | 1.00 | 1.00 | 1.00       | 1.00 | 1.00 |
| PHF Adj:                  | 1.00        | 1.00 | 1.00 | 1.00        | 1.00 | 1.00 | 1.00       | 1.00 | 1.00 | 1.00       | 1.00 | 1.00 |
| PHF Volume:               | 187         | 583  | 38   | 50          | 370  | 121  | 51         | 65   | 139  | 50         | 138  | 37   |
| Reduct Vol:               | 0           | 0    | 0    | 0           | 0    | 0    | 0          | 0    | 0    | 0          | 0    | 0    |
| Reduced Vol:              | 187         | 583  | 38   | 50          | 370  | 121  | 51         | 65   | 139  | 50         | 138  | 37   |
| PCE Adj:                  | 1.00        | 1.00 | 1.00 | 1.00        | 1.00 | 1.00 | 1.00       | 1.00 | 1.00 | 1.00       | 1.00 | 1.00 |
| MLF Adj:                  | 1.00        | 1.00 | 1.00 | 1.00        | 1.00 | 1.00 | 1.00       | 1.00 | 1.00 | 1.00       | 1.00 | 1.00 |
| Final Volume:             | 187         | 583  | 38   | 50          | 370  | 121  | 51         | 65   | 139  | 50         | 138  | 37   |
| Saturation Flow Module:   |             |      |      |             |      |      |            |      |      |            |      |      |
| Sat/Lane:                 | 1900        | 1900 | 1900 | 1900        | 1900 | 1900 | 1900       | 1900 | 1900 | 1900       | 1900 | 1900 |
| Adjustment:               | 0.92        | 1.00 | 0.92 | 0.92        | 0.95 | 0.95 | 0.95       | 0.95 | 0.92 | 0.92       | 0.92 | 0.92 |
| Lanes:                    | 1.00        | 1.00 | 1.00 | 1.00        | 0.75 | 0.25 | 0.44       | 0.56 | 1.00 | 0.22       | 0.62 | 0.16 |
| Final Sat.:               | 1750        | 1900 | 1750 | 1750        | 1356 | 444  | 791        | 1009 | 1750 | 389        | 1073 | 288  |
| Capacity Analysis Module: |             |      |      |             |      |      |            |      |      |            |      |      |
| Vol/Sat:                  | 0.11        | 0.31 | 0.02 | 0.03        | 0.27 | 0.27 | 0.06       | 0.06 | 0.08 | 0.13       | 0.13 | 0.13 |
| Crit Moves:               | ****        | **** | **** | ****        | **** | **** | ****       | **** | **** | ****       | **** | **** |
| Green Time:               | 15.7        | 48.6 | 48.6 | 7.0         | 40.0 | 40.0 | 20.4       | 20.4 | 20.4 | 20.4       | 20.4 | 20.4 |
| Volume/Cap:               | 0.58        | 0.54 | 0.04 | 0.35        | 0.58 | 0.58 | 0.27       | 0.27 | 0.33 | 0.54       | 0.54 | 0.54 |
| Delay/Veh:                | 34.3        | 11.8 | 8.0  | 38.3        | 17.4 | 17.4 | 26.6       | 26.6 | 27.2 | 29.6       | 29.6 | 29.6 |
| User DelAdj:              | 1.00        | 1.00 | 1.00 | 1.00        | 1.00 | 1.00 | 1.00       | 1.00 | 1.00 | 1.00       | 1.00 | 1.00 |
| AdjDel/Veh:               | 34.3        | 11.8 | 8.0  | 38.3        | 17.4 | 17.4 | 26.6       | 26.6 | 27.2 | 29.6       | 29.6 | 29.6 |
| LOS by Move:              | C           | B    | A    | D           | B    | B    | C          | C    | C    | C          | C    | C    |
| HCM2k95thQ:               | 10          | 17   | 1    | 3           | 18   | 18   | 5          | 5    | 7    | 12         | 12   | 12   |

Note: Queue reported is the number of cars per lane.

BART

Level Of Service Computation Report  
 2000 HCM Operations (Future Volume Alternative)  
 PM - Cumulative No Project

Intersection #3832: 24TH/WILLIAM [Study Int 24]

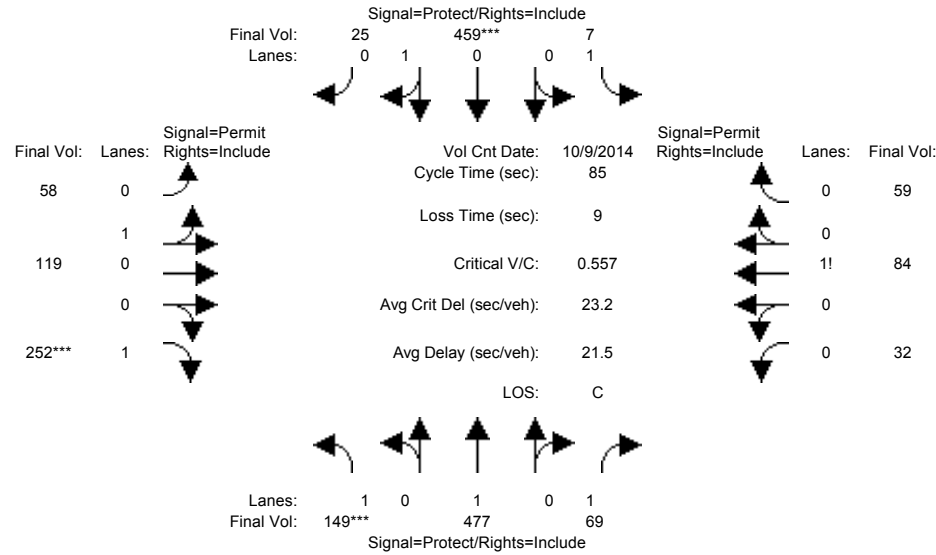

| Approach:                                   | North Bound |      |      | South Bound |      |      | East Bound |      |      | West Bound |      |      |
|---|-------------|------|------|-------------|------|------|------------|------|------|------------|------|------|
| Movement:                                   | L           | T    | R    | L           | T    | R    | L          | T    | R    | L          | T    | R    |
| Min. Green:                                 | 7           | 10   | 10   | 7           | 10   | 10   | 10         | 10   | 10   | 10         | 10   | 10   |
| Y+R:  | 4.0         | 4.0  | 4.0  | 4.0         | 4.0  | 4.0  | 4.0        | 4.0  | 4.0  | 4.0        | 4.0  | 4.0  |
| Volume Module: >> Count Date: 9 Oct 2014 << |             |      |      |             |      |      |            |      |      |            |      |      |
| Base Vol:                                   | 149         | 477  | 69   | 7           | 459  | 25   | 58         | 119  | 252  | 32         | 84   | 59   |
| Growth Adj:                                 | 1.00        | 1.00 | 1.00 | 1.00        | 1.00 | 1.00 | 1.00       | 1.00 | 1.00 | 1.00       | 1.00 | 1.00 |
| Initial Bse:                                | 149         | 477  | 69   | 7           | 459  | 25   | 58         | 119  | 252  | 32         | 84   | 59   |
| Added Vol:                                  | 0           | 0    | 0    | 0           | 0    | 0    | 0          | 0    | 0    | 0          | 0    | 0    |
| PasserByVol:                                | 0           | 0    | 0    | 0           | 0    | 0    | 0          | 0    | 0    | 0          | 0    | 0    |
| Initial Fut:                                | 149         | 477  | 69   | 7           | 459  | 25   | 58         | 119  | 252  | 32         | 84   | 59   |
| User Adj:                                   | 1.00        | 1.00 | 1.00 | 1.00        | 1.00 | 1.00 | 1.00       | 1.00 | 1.00 | 1.00       | 1.00 | 1.00 |
| PHF Adj:                                    | 1.00        | 1.00 | 1.00 | 1.00        | 1.00 | 1.00 | 1.00       | 1.00 | 1.00 | 1.00       | 1.00 | 1.00 |
| PHF Volume:                                 | 149         | 477  | 69   | 7           | 459  | 25   | 58         | 119  | 252  | 32         | 84   | 59   |
| Reduct Vol:                                 | 0           | 0    | 0    | 0           | 0    | 0    | 0          | 0    | 0    | 0          | 0    | 0    |
| Reduced Vol:                                | 149         | 477  | 69   | 7           | 459  | 25   | 58         | 119  | 252  | 32         | 84   | 59   |
| PCE Adj:                                    | 1.00        | 1.00 | 1.00 | 1.00        | 1.00 | 1.00 | 1.00       | 1.00 | 1.00 | 1.00       | 1.00 | 1.00 |
| MLF Adj:                                    | 1.00        | 1.00 | 1.00 | 1.00        | 1.00 | 1.00 | 1.00       | 1.00 | 1.00 | 1.00       | 1.00 | 1.00 |
| Final Volume:                               | 149         | 477  | 69   | 7           | 459  | 25   | 58         | 119  | 252  | 32         | 84   | 59   |
| Saturation Flow Module:                     |             |      |      |             |      |      |            |      |      |            |      |      |
| Sat/Lane:                                   | 1900        | 1900 | 1900 | 1900        | 1900 | 1900 | 1900       | 1900 | 1900 | 1900       | 1900 | 1900 |
| Adjustment:                                 | 0.92        | 1.00 | 0.92 | 0.92        | 0.95 | 0.95 | 0.95       | 0.95 | 0.92 | 0.92       | 0.92 | 0.92 |
| Lanes:                                      | 1.00        | 1.00 | 1.00 | 1.00        | 0.95 | 0.05 | 0.33       | 0.67 | 1.00 | 0.18       | 0.48 | 0.34 |
| Final Sat.:                                 | 1750        | 1900 | 1750 | 1750        | 1707 | 93   | 590        | 1210 | 1750 | 320        | 840  | 590  |
| Capacity Analysis Module:                   |             |      |      |             |      |      |            |      |      |            |      |      |
| Vol/Sat:                                    | 0.09        | 0.25 | 0.04 | 0.00        | 0.27 | 0.27 | 0.10       | 0.10 | 0.14 | 0.10       | 0.10 | 0.10 |
| Crit Moves:                                 | ****        |      |      | ****        |      |      | ****       |      |      | ****       |      |      |
| Green Time:                                 | 13.0        | 40.7 | 40.7 | 13.3        | 41.0 | 41.0 | 22.0       | 22.0 | 22.0 | 22.0       | 22.0 | 22.0 |
| Volume/Cap:                                 | 0.56        | 0.52 | 0.08 | 0.03        | 0.56 | 0.56 | 0.38       | 0.38 | 0.56 | 0.39       | 0.39 | 0.39 |
| Delay/Veh:                                  | 35.9        | 16.0 | 12.1 | 30.4        | 16.4 | 16.4 | 26.4       | 26.4 | 28.8 | 26.5       | 26.5 | 26.5 |
| User DelAdj:                                | 1.00        | 1.00 | 1.00 | 1.00        | 1.00 | 1.00 | 1.00       | 1.00 | 1.00 | 1.00       | 1.00 | 1.00 |
| AdjDel/Veh:                                 | 35.9        | 16.0 | 12.1 | 30.4        | 16.4 | 16.4 | 26.4       | 26.4 | 28.8 | 26.5       | 26.5 | 26.5 |
| LOS by Move:                                | D           | B    | B    | C           | B    | B    | C          | C    | C    | C          | C    | C    |
| HCM2k95thQ:                                 | 8           | 16   | 2    | 0           | 17   | 17   | 8          | 8    | 13   | 9          | 9    | 9    |

Note: Queue reported is the number of cars per lane.

BART

Level Of Service Computation Report  
 2000 HCM Operations (Future Volume Alternative)  
 AM - Cumulative With Project

Intersection #3832: 24TH/WILLIAM [Study Int 24]

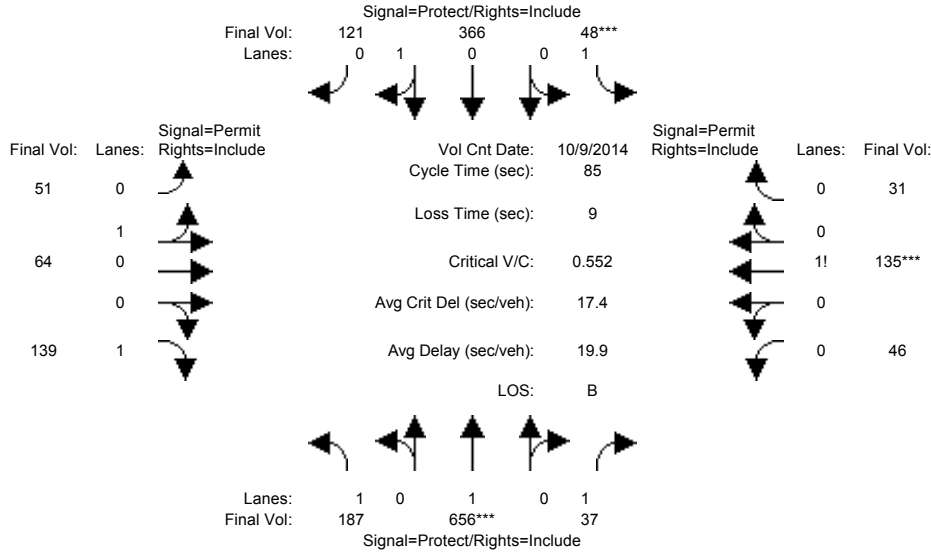

| Approach:                                   | North Bound |      |      | South Bound |      |      | East Bound |      |      | West Bound |      |      |
|---|-------------|------|------|-------------|------|------|------------|------|------|------------|------|------|
| Movement:                                   | L           | T    | R    | L           | T    | R    | L          | T    | R    | L          | T    | R    |
| Min. Green:                                 | 7           | 10   | 10   | 7           | 10   | 10   | 10         | 10   | 10   | 10         | 10   | 10   |
| Y+R:  | 4.0         | 4.0  | 4.0  | 4.0         | 4.0  | 4.0  | 4.0        | 4.0  | 4.0  | 4.0        | 4.0  | 4.0  |
| Volume Module: >> Count Date: 9 Oct 2014 << |             |      |      |             |      |      |            |      |      |            |      |      |
| Base Vol:                                   | 187         | 656  | 37   | 48          | 366  | 121  | 51         | 64   | 139  | 46         | 135  | 31   |
| Growth Adj:                                 | 1.00        | 1.00 | 1.00 | 1.00        | 1.00 | 1.00 | 1.00       | 1.00 | 1.00 | 1.00       | 1.00 | 1.00 |
| Initial Bse:                                | 187         | 656  | 37   | 48          | 366  | 121  | 51         | 64   | 139  | 46         | 135  | 31   |
| Added Vol:                                  | 0           | 0    | 0    | 0           | 0    | 0    | 0          | 0    | 0    | 0          | 0    | 0    |
| PasserByVol:                                | 0           | 0    | 0    | 0           | 0    | 0    | 0          | 0    | 0    | 0          | 0    | 0    |
| Initial Fut:                                | 187         | 656  | 37   | 48          | 366  | 121  | 51         | 64   | 139  | 46         | 135  | 31   |
| User Adj:                                   | 1.00        | 1.00 | 1.00 | 1.00        | 1.00 | 1.00 | 1.00       | 1.00 | 1.00 | 1.00       | 1.00 | 1.00 |
| PHF Adj:                                    | 1.00        | 1.00 | 1.00 | 1.00        | 1.00 | 1.00 | 1.00       | 1.00 | 1.00 | 1.00       | 1.00 | 1.00 |
| PHF Volume:                                 | 187         | 656  | 37   | 48          | 366  | 121  | 51         | 64   | 139  | 46         | 135  | 31   |
| Reduct Vol:                                 | 0           | 0    | 0    | 0           | 0    | 0    | 0          | 0    | 0    | 0          | 0    | 0    |
| Reduced Vol:                                | 187         | 656  | 37   | 48          | 366  | 121  | 51         | 64   | 139  | 46         | 135  | 31   |
| PCE Adj:                                    | 1.00        | 1.00 | 1.00 | 1.00        | 1.00 | 1.00 | 1.00       | 1.00 | 1.00 | 1.00       | 1.00 | 1.00 |
| MLF Adj:                                    | 1.00        | 1.00 | 1.00 | 1.00        | 1.00 | 1.00 | 1.00       | 1.00 | 1.00 | 1.00       | 1.00 | 1.00 |
| Final Volume:                               | 187         | 656  | 37   | 48          | 366  | 121  | 51         | 64   | 139  | 46         | 135  | 31   |
| Saturation Flow Module:                     |             |      |      |             |      |      |            |      |      |            |      |      |
| Sat/Lane:                                   | 1900        | 1900 | 1900 | 1900        | 1900 | 1900 | 1900       | 1900 | 1900 | 1900       | 1900 | 1900 |
| Adjustment:                                 | 0.92        | 1.00 | 0.92 | 0.92        | 0.95 | 0.95 | 0.95       | 0.95 | 0.92 | 0.92       | 0.92 | 0.92 |
| Lanes:                                      | 1.00        | 1.00 | 1.00 | 1.00        | 0.75 | 0.25 | 0.44       | 0.56 | 1.00 | 0.22       | 0.64 | 0.14 |
| Final Sat.:                                 | 1750        | 1900 | 1750 | 1750        | 1353 | 447  | 798        | 1002 | 1750 | 380        | 1114 | 256  |
| Capacity Analysis Module:                   |             |      |      |             |      |      |            |      |      |            |      |      |
| Vol/Sat:                                    | 0.11        | 0.35 | 0.02 | 0.03        | 0.27 | 0.27 | 0.06       | 0.06 | 0.08 | 0.12       | 0.12 | 0.12 |
| Crit Moves:                                 | ****        | **** | **** | ****        | **** | **** | ****       | **** | **** | ****       | **** | **** |
| Green Time:                                 | 16.4        | 51.1 | 51.1 | 7.0         | 41.6 | 41.6 | 17.9       | 17.9 | 17.9 | 17.9       | 17.9 | 17.9 |
| Volume/Cap:                                 | 0.55        | 0.57 | 0.04 | 0.33        | 0.55 | 0.55 | 0.30       | 0.30 | 0.38 | 0.57       | 0.57 | 0.57 |
| Delay/Veh:                                  | 32.9        | 11.1 | 6.9  | 38.2        | 15.9 | 15.9 | 28.7       | 28.7 | 29.4 | 32.3       | 32.3 | 32.3 |
| User DelAdj:                                | 1.00        | 1.00 | 1.00 | 1.00        | 1.00 | 1.00 | 1.00       | 1.00 | 1.00 | 1.00       | 1.00 | 1.00 |
| AdjDel/Veh:                                 | 32.9        | 11.1 | 6.9  | 38.2        | 15.9 | 15.9 | 28.7       | 28.7 | 29.4 | 32.3       | 32.3 | 32.3 |
| LOS by Move:                                | C           | B    | A    | D           | B    | B    | C          | C    | C    | C          | C    | C    |
| HCM2k95thQ:                                 | 9           | 19   | 1    | 3           | 17   | 17   | 6          | 6    | 7    | 12         | 12   | 12   |

Note: Queue reported is the number of cars per lane.

BART

Level Of Service Computation Report  
 2000 HCM Operations (Future Volume Alternative)  
 PM - Cumulative With Project

Intersection #3832: 24TH/WILLIAM [Study Int 24]

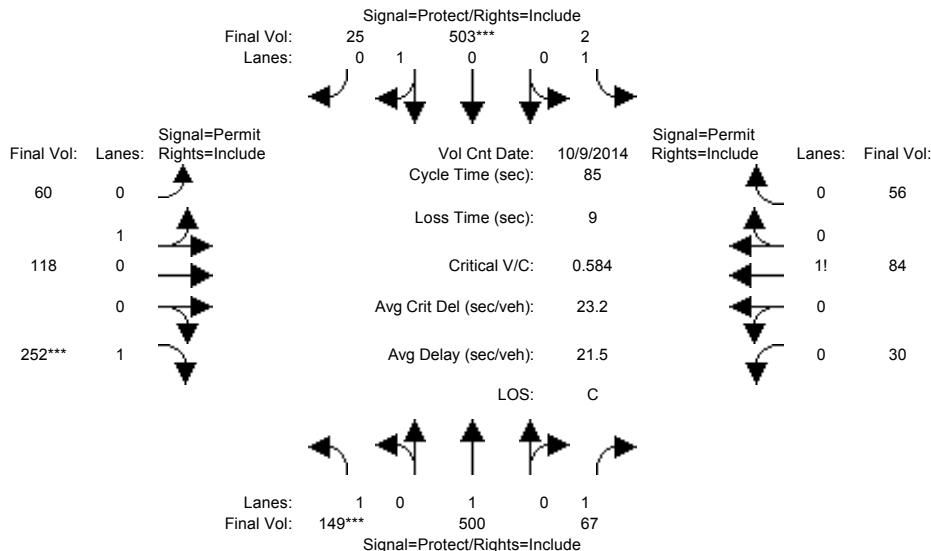

| Approach:   | North Bound |      |      | South Bound |      |      | East Bound |      |      | West Bound |      |      |
|---|-------------|------|------|-------------|------|------|------------|------|------|------------|------|------|
| Movement:   | L           | T    | R    | L           | T    | R    | L          | T    | R    | L          | T    | R    |
| Min. Green:   | 7           | 10   | 10   | 7           | 10   | 10   | 10         | 10   | 10   | 10         | 10   | 10   |
| Y+R:  | 4.0         | 4.0  | 4.0  | 4.0         | 4.0  | 4.0  | 4.0        | 4.0  | 4.0  | 4.0        | 4.0  | 4.0  |
| ----- ----- ----- ----- ----- ----- ----- ----- ----- ----- ----- ----- ----- |             |      |      |             |      |      |            |      |      |            |      |      |
| Volume Module: >> Count Date: 9 Oct 2014 <<                                   |             |      |      |             |      |      |            |      |      |            |      |      |
| Base Vol:   | 149         | 500  | 67   | 2           | 503  | 25   | 60         | 118  | 252  | 30         | 84   | 56   |
| Growth Adj:   | 1.00        | 1.00 | 1.00 | 1.00        | 1.00 | 1.00 | 1.00       | 1.00 | 1.00 | 1.00       | 1.00 | 1.00 |
| Initial Bse:  | 149         | 500  | 67   | 2           | 503  | 25   | 60         | 118  | 252  | 30         | 84   | 56   |
| Added Vol:  | 0           | 0    | 0    | 0           | 0    | 0    | 0          | 0    | 0    | 0          | 0    | 0    |
| PasserByVol:  | 0           | 0    | 0    | 0           | 0    | 0    | 0          | 0    | 0    | 0          | 0    | 0    |
| Initial Fut:  | 149         | 500  | 67   | 2           | 503  | 25   | 60         | 118  | 252  | 30         | 84   | 56   |
| User Adj:   | 1.00        | 1.00 | 1.00 | 1.00        | 1.00 | 1.00 | 1.00       | 1.00 | 1.00 | 1.00       | 1.00 | 1.00 |
| PHF Adj:  | 1.00        | 1.00 | 1.00 | 1.00        | 1.00 | 1.00 | 1.00       | 1.00 | 1.00 | 1.00       | 1.00 | 1.00 |
| PHF Volume:   | 149         | 500  | 67   | 2           | 503  | 25   | 60         | 118  | 252  | 30         | 84   | 56   |
| Reduct Vol:   | 0           | 0    | 0    | 0           | 0    | 0    | 0          | 0    | 0    | 0          | 0    | 0    |
| Reduced Vol:  | 149         | 500  | 67   | 2           | 503  | 25   | 60         | 118  | 252  | 30         | 84   | 56   |
| PCE Adj:  | 1.00        | 1.00 | 1.00 | 1.00        | 1.00 | 1.00 | 1.00       | 1.00 | 1.00 | 1.00       | 1.00 | 1.00 |
| MLF Adj:  | 1.00        | 1.00 | 1.00 | 1.00        | 1.00 | 1.00 | 1.00       | 1.00 | 1.00 | 1.00       | 1.00 | 1.00 |
| Final Volume:   | 149         | 500  | 67   | 2           | 503  | 25   | 60         | 118  | 252  | 30         | 84   | 56   |
| ----- ----- ----- ----- ----- ----- ----- ----- ----- ----- ----- -----       |             |      |      |             |      |      |            |      |      |            |      |      |
| Saturation Flow Module:   |             |      |      |             |      |      |            |      |      |            |      |      |
| Sat/Lane:   | 1900        | 1900 | 1900 | 1900        | 1900 | 1900 | 1900       | 1900 | 1900 | 1900       | 1900 | 1900 |
| Adjustment:   | 0.92        | 1.00 | 0.92 | 0.92        | 0.95 | 0.95 | 0.95       | 0.95 | 0.92 | 0.92       | 0.92 | 0.92 |
| Lanes:  | 1.00        | 1.00 | 1.00 | 1.00        | 0.95 | 0.05 | 0.34       | 0.66 | 1.00 | 0.18       | 0.49 | 0.33 |
| Final Sat.:   | 1750        | 1900 | 1750 | 1750        | 1715 | 85   | 607        | 1193 | 1750 | 309        | 865  | 576  |
| ----- ----- ----- ----- ----- ----- ----- ----- ----- ----- ----- -----       |             |      |      |             |      |      |            |      |      |            |      |      |
| Capacity Analysis Module:   |             |      |      |             |      |      |            |      |      |            |      |      |
| Vol/Sat:  | 0.09        | 0.26 | 0.04 | 0.00        | 0.29 | 0.29 | 0.10       | 0.10 | 0.14 | 0.10       | 0.10 | 0.10 |
| Crit Moves:   | ****        |      |      | ****        |      |      | ****       |      |      | ****       |      |      |
| Green Time:   | 12.4        | 41.9 | 41.9 | 13.1        | 42.7 | 42.7 | 20.9       | 20.9 | 20.9 | 20.9       | 20.9 | 20.9 |
| Volume/Cap:   | 0.58        | 0.53 | 0.08 | 0.01        | 0.58 | 0.58 | 0.40       | 0.40 | 0.58 | 0.39       | 0.39 | 0.39 |
| Delay/Veh:  | 37.4        | 15.4 | 11.4 | 30.4        | 15.9 | 15.9 | 27.4       | 27.4 | 30.3 | 27.3       | 27.3 | 27.3 |
| User DelAdj:  | 1.00        | 1.00 | 1.00 | 1.00        | 1.00 | 1.00 | 1.00       | 1.00 | 1.00 | 1.00       | 1.00 | 1.00 |
| AdjDel/Veh:   | 37.4        | 15.4 | 11.4 | 30.4        | 15.9 | 15.9 | 27.4       | 27.4 | 30.3 | 27.3       | 27.3 | 27.3 |
| LOS by Move:  | D           | B    | B    | C           | B    | B    | C          | C    | C    | C          | C    | C    |
| HCM2k95thQ:   | 8           | 17   | 2    | 0           | 19   | 19   | 9          | 9    | 13   | 8          | 8    | 8    |

Note: Queue reported is the number of cars per lane.

BART

Level Of Service Computation Report  
 2000 HCM Operations (Future Volume Alternative)  
 AM - Cumulative No Project

Intersection #4005: JULIAN/28TH [Study Int 3]

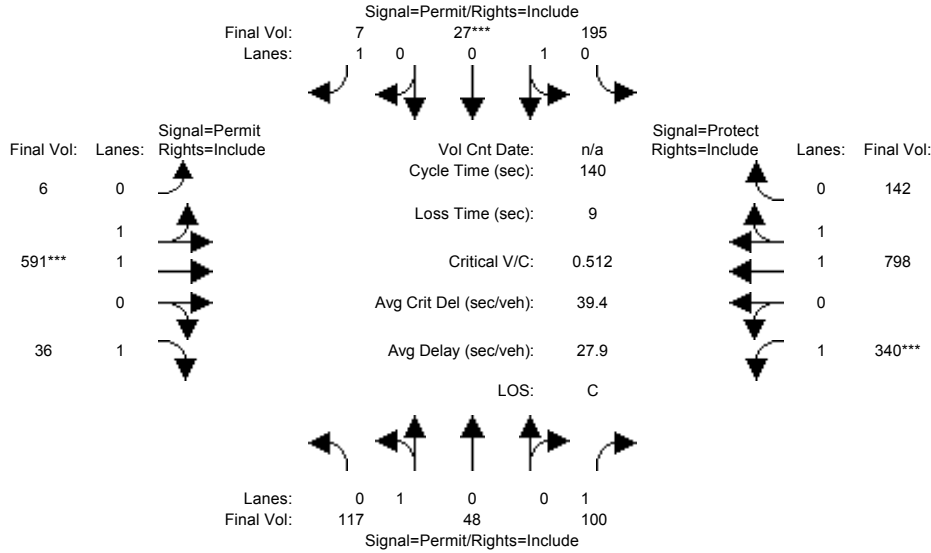

| Approach:                 | North Bound |      |      | South Bound |      |      | East Bound |      |      | West Bound |      |      |
|---------------------------|-------------|------|------|-------------|------|------|------------|------|------|------------|------|------|
| Movement:                 | L           | T    | R    | L           | T    | R    | L          | T    | R    | L          | T    | R    |
| Min. Green:               | 10          | 10   | 10   | 10          | 10   | 10   | 10         | 10   | 10   | 7          | 10   | 10   |
| Y+R:                      | 4.0         | 4.0  | 4.0  | 4.0         | 4.0  | 4.0  | 4.0        | 4.0  | 4.0  | 4.0        | 4.0  | 4.0  |
| Volume Module:            |             |      |      |             |      |      |            |      |      |            |      |      |
| Base Vol:                 | 117         | 48   | 100  | 195         | 27   | 7    | 6          | 591  | 36   | 340        | 798  | 142  |
| Growth Adj:               | 1.00        | 1.00 | 1.00 | 1.00        | 1.00 | 1.00 | 1.00       | 1.00 | 1.00 | 1.00       | 1.00 | 1.00 |
| Initial Bse:              | 117         | 48   | 100  | 195         | 27   | 7    | 6          | 591  | 36   | 340        | 798  | 142  |
| Added Vol:                | 0           | 0    | 0    | 0           | 0    | 0    | 0          | 0    | 0    | 0          | 0    | 0    |
| PasserByVol:              | 0           | 0    | 0    | 0           | 0    | 0    | 0          | 0    | 0    | 0          | 0    | 0    |
| Initial Fut:              | 117         | 48   | 100  | 195         | 27   | 7    | 6          | 591  | 36   | 340        | 798  | 142  |
| User Adj:                 | 1.00        | 1.00 | 1.00 | 1.00        | 1.00 | 1.00 | 1.00       | 1.00 | 1.00 | 1.00       | 1.00 | 1.00 |
| PHF Adj:                  | 1.00        | 1.00 | 1.00 | 1.00        | 1.00 | 1.00 | 1.00       | 1.00 | 1.00 | 1.00       | 1.00 | 1.00 |
| PHF Volume:               | 117         | 48   | 100  | 195         | 27   | 7    | 6          | 591  | 36   | 340        | 798  | 142  |
| Reduct Vol:               | 0           | 0    | 0    | 0           | 0    | 0    | 0          | 0    | 0    | 0          | 0    | 0    |
| Reduced Vol:              | 117         | 48   | 100  | 195         | 27   | 7    | 6          | 591  | 36   | 340        | 798  | 142  |
| PCE Adj:                  | 1.00        | 1.00 | 1.00 | 1.00        | 1.00 | 1.00 | 1.00       | 1.00 | 1.00 | 1.00       | 1.00 | 1.00 |
| MLF Adj:                  | 1.00        | 1.00 | 1.00 | 1.00        | 1.00 | 1.00 | 1.00       | 1.00 | 1.00 | 1.00       | 1.00 | 1.00 |
| Final Volume:             | 117         | 48   | 100  | 195         | 27   | 7    | 6          | 591  | 36   | 340        | 798  | 142  |
| Saturation Flow Module:   |             |      |      |             |      |      |            |      |      |            |      |      |
| Sat/Lane:                 | 1900        | 1900 | 1900 | 1900        | 1900 | 1900 | 1900       | 1900 | 1900 | 1900       | 1900 | 1900 |
| Adjustment:               | 0.95        | 0.95 | 0.92 | 0.95        | 0.95 | 0.92 | 0.95       | 0.97 | 0.92 | 0.92       | 0.98 | 0.95 |
| Lanes:                    | 0.71        | 0.29 | 1.00 | 0.88        | 0.12 | 1.00 | 0.02       | 1.98 | 1.00 | 1.00       | 1.69 | 0.31 |
| Final Sat.:               | 1276        | 524  | 1750 | 1581        | 219  | 1750 | 37         | 3663 | 1750 | 1750       | 3141 | 559  |
| Capacity Analysis Module: |             |      |      |             |      |      |            |      |      |            |      |      |
| Vol/Sat:                  | 0.09        | 0.09 | 0.06 | 0.12        | 0.12 | 0.00 | 0.16       | 0.16 | 0.02 | 0.19       | 0.25 | 0.25 |
| Crit Moves:               |             |      |      | ****        |      |      | ****       |      |      | ****       |      |      |
| Green Time:               | 33.7        | 33.7 | 33.7 | 33.7        | 33.7 | 33.7 | 44.1       | 44.1 | 44.1 | 53.1       | 97.3 | 97.3 |
| Volume/Cap:               | 0.38        | 0.38 | 0.24 | 0.51        | 0.51 | 0.02 | 0.51       | 0.51 | 0.07 | 0.51       | 0.37 | 0.37 |
| Delay/Veh:                | 45.0        | 45.0 | 43.1 | 47.0        | 47.0 | 40.5 | 39.5       | 39.5 | 33.6 | 34.1       | 8.8  | 8.8  |
| User DelAdj:              | 1.00        | 1.00 | 1.00 | 1.00        | 1.00 | 1.00 | 1.00       | 1.00 | 1.00 | 1.00       | 1.00 | 1.00 |
| AdjDel/Veh:               | 45.0        | 45.0 | 43.1 | 47.0        | 47.0 | 40.5 | 39.5       | 39.5 | 33.6 | 34.1       | 8.8  | 8.8  |
| LOS by Move:              | D           | D    | D    | D           | D    | D    | D          | D    | C    | C          | A    | A    |
| HCM2k95thQ:               | 12          | 12   | 7    | 17          | 17   | 1    | 19         | 19   | 2    | 21         | 16   | 16   |

Note: Queue reported is the number of cars per lane.



BART

Level Of Service Computation Report  
 2000 HCM Operations (Future Volume Alternative)  
 PM - Cumulative No Project

Intersection #4005: JULIAN/28TH [Study Int 3]

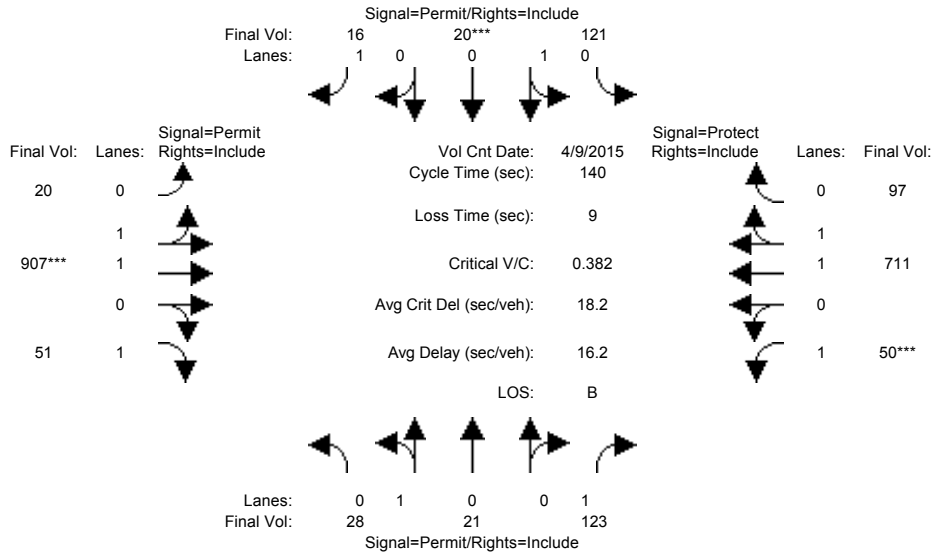

| Approach:                 | North Bound                  |      |      | South Bound |      |      | East Bound |      |      | West Bound |      |       |
|---------------------------|------------------------------|------|------|-------------|------|------|------------|------|------|------------|------|-------|
| Movement:                 | L                            | T    | R    | L           | T    | R    | L          | T    | R    | L          | T    | R     |
| Min. Green:               | 10                           | 10   | 10   | 10          | 10   | 10   | 10         | 10   | 10   | 7          | 10   | 10    |
| Y+R:                      | 4.0                          | 4.0  | 4.0  | 4.0         | 4.0  | 4.0  | 4.0        | 4.0  | 4.0  | 4.0        | 4.0  | 4.0   |
| -----                     |                              |      |      |             |      |      |            |      |      |            |      |       |
| Volume Module:            | >> Count Date: 9 Apr 2015 << |      |      |             |      |      |            |      |      |            |      |       |
| Base Vol:                 | 28                           | 21   | 123  | 121         | 20   | 16   | 20         | 907  | 51   | 50         | 711  | 97    |
| Growth Adj:               | 1.00                         | 1.00 | 1.00 | 1.00        | 1.00 | 1.00 | 1.00       | 1.00 | 1.00 | 1.00       | 1.00 | 1.00  |
| Initial Bse:              | 28                           | 21   | 123  | 121         | 20   | 16   | 20         | 907  | 51   | 50         | 711  | 97    |
| Added Vol:                | 0                            | 0    | 0    | 0           | 0    | 0    | 0          | 0    | 0    | 0          | 0    | 0     |
| PasserByVol:              | 0                            | 0    | 0    | 0           | 0    | 0    | 0          | 0    | 0    | 0          | 0    | 0     |
| Initial Fut:              | 28                           | 21   | 123  | 121         | 20   | 16   | 20         | 907  | 51   | 50         | 711  | 97    |
| User Adj:                 | 1.00                         | 1.00 | 1.00 | 1.00        | 1.00 | 1.00 | 1.00       | 1.00 | 1.00 | 1.00       | 1.00 | 1.00  |
| PHF Adj:                  | 1.00                         | 1.00 | 1.00 | 1.00        | 1.00 | 1.00 | 1.00       | 1.00 | 1.00 | 1.00       | 1.00 | 1.00  |
| PHF Volume:               | 28                           | 21   | 123  | 121         | 20   | 16   | 20         | 907  | 51   | 50         | 711  | 97    |
| Reduct Vol:               | 0                            | 0    | 0    | 0           | 0    | 0    | 0          | 0    | 0    | 0          | 0    | 0     |
| Reduced Vol:              | 28                           | 21   | 123  | 121         | 20   | 16   | 20         | 907  | 51   | 50         | 711  | 97    |
| PCE Adj:                  | 1.00                         | 1.00 | 1.00 | 1.00        | 1.00 | 1.00 | 1.00       | 1.00 | 1.00 | 1.00       | 1.00 | 1.00  |
| MLF Adj:                  | 1.00                         | 1.00 | 1.00 | 1.00        | 1.00 | 1.00 | 1.00       | 1.00 | 1.00 | 1.00       | 1.00 | 1.00  |
| Final Volume:             | 28                           | 21   | 123  | 121         | 20   | 16   | 20         | 907  | 51   | 50         | 711  | 97    |
| -----                     |                              |      |      |             |      |      |            |      |      |            |      |       |
| Saturation Flow Module:   |                              |      |      |             |      |      |            |      |      |            |      |       |
| Sat/Lane:                 | 1900                         | 1900 | 1900 | 1900        | 1900 | 1900 | 1900       | 1900 | 1900 | 1900       | 1900 | 1900  |
| Adjustment:               | 0.95                         | 0.95 | 0.92 | 0.95        | 0.95 | 0.92 | 0.95       | 0.97 | 0.92 | 0.92       | 0.98 | 0.95  |
| Lanes:                    | 0.57                         | 0.43 | 1.00 | 0.86        | 0.14 | 1.00 | 0.04       | 1.96 | 1.00 | 1.00       | 1.75 | 0.25  |
| Final Sat.:               | 1029                         | 771  | 1750 | 1545        | 255  | 1750 | 80         | 3620 | 1750 | 1750       | 3255 | 444   |
| -----                     |                              |      |      |             |      |      |            |      |      |            |      |       |
| Capacity Analysis Module: |                              |      |      |             |      |      |            |      |      |            |      |       |
| Vol/Sat:                  | 0.03                         | 0.03 | 0.07 | 0.08        | 0.08 | 0.01 | 0.25       | 0.25 | 0.03 | 0.03       | 0.22 | 0.22  |
| Crit Moves:               | *****                        |      |      |             |      |      |            |      |      |            |      |       |
| Green Time:               | 28.7                         | 28.7 | 28.7 | 28.7        | 28.7 | 28.7 | 91.8       | 91.8 | 91.8 | 10.5       | 102  | 102.3 |
| Volume/Cap:               | 0.13                         | 0.13 | 0.34 | 0.38        | 0.38 | 0.04 | 0.38       | 0.38 | 0.04 | 0.38       | 0.30 | 0.30  |
| Delay/Veh:                | 45.6                         | 45.6 | 48.2 | 48.7        | 48.7 | 44.7 | 11.2       | 11.2 | 8.6  | 63.5       | 6.6  | 6.6   |
| User DelAdj:              | 1.00                         | 1.00 | 1.00 | 1.00        | 1.00 | 1.00 | 1.00       | 1.00 | 1.00 | 1.00       | 1.00 | 1.00  |
| AdjDel/Veh:               | 45.6                         | 45.6 | 48.2 | 48.7        | 48.7 | 44.7 | 11.2       | 11.2 | 8.6  | 63.5       | 6.6  | 6.6   |
| LOS by Move:              | D                            | D    | D    | D           | D    | D    | B          | B    | A    | E          | A    | A     |
| HCM2k95thQ:               | 4                            | 4    | 9    | 11          | 11   | 1    | 17         | 17   | 2    | 4          | 12   | 12    |

Note: Queue reported is the number of cars per lane.

BART

Level Of Service Computation Report  
2000 HCM Operations (Future Volume Alternative)  
AM - Cumulative With Project

Intersection #4005: JULIAN/28TH [Study Int 3]

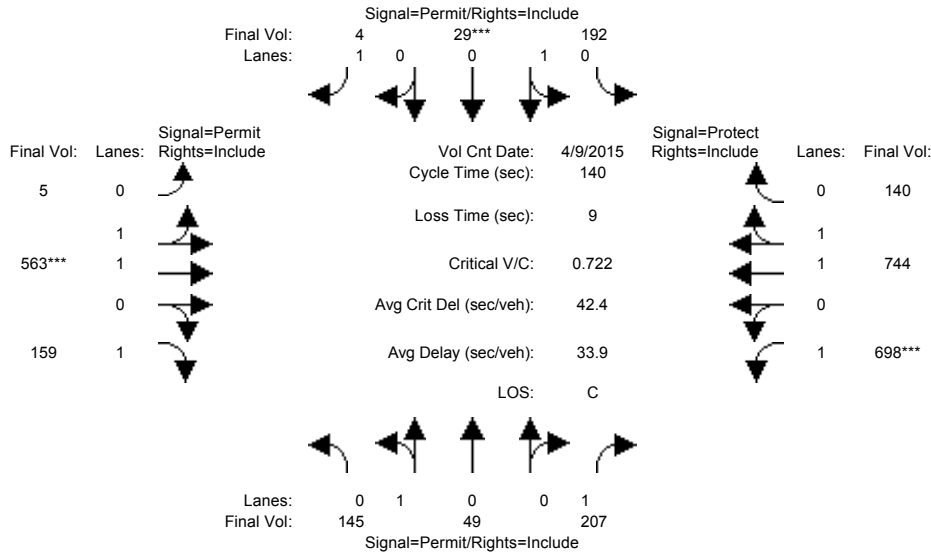

| Approach:                                   | North Bound |      |      | South Bound |      |      | East Bound |      |      | West Bound |      |       |
|---|-------------|------|------|-------------|------|------|------------|------|------|------------|------|-------|
| Movement:                                   | L           | T    | R    | L           | T    | R    | L          | T    | R    | L          | T    | R     |
| Min. Green:                                 | 10          | 10   | 10   | 10          | 10   | 10   | 10         | 10   | 10   | 7          | 10   | 10    |
| Y+R:  | 4.0         | 4.0  | 4.0  | 4.0         | 4.0  | 4.0  | 4.0        | 4.0  | 4.0  | 4.0        | 4.0  | 4.0   |
| Volume Module: >> Count Date: 9 Apr 2015 << |             |      |      |             |      |      |            |      |      |            |      |       |
| Base Vol:                                   | 145         | 49   | 207  | 192         | 29   | 4    | 5          | 563  | 159  | 698        | 744  | 140   |
| Growth Adj:                                 | 1.00        | 1.00 | 1.00 | 1.00        | 1.00 | 1.00 | 1.00       | 1.00 | 1.00 | 1.00       | 1.00 | 1.00  |
| Initial Bse:                                | 145         | 49   | 207  | 192         | 29   | 4    | 5          | 563  | 159  | 698        | 744  | 140   |
| Added Vol:                                  | 0           | 0    | 0    | 0           | 0    | 0    | 0          | 0    | 0    | 0          | 0    | 0     |
| PasserByVol:                                | 0           | 0    | 0    | 0           | 0    | 0    | 0          | 0    | 0    | 0          | 0    | 0     |
| Initial Fut:                                | 145         | 49   | 207  | 192         | 29   | 4    | 5          | 563  | 159  | 698        | 744  | 140   |
| User Adj:                                   | 1.00        | 1.00 | 1.00 | 1.00        | 1.00 | 1.00 | 1.00       | 1.00 | 1.00 | 1.00       | 1.00 | 1.00  |
| PHF Adj:                                    | 1.00        | 1.00 | 1.00 | 1.00        | 1.00 | 1.00 | 1.00       | 1.00 | 1.00 | 1.00       | 1.00 | 1.00  |
| PHF Volume:                                 | 145         | 49   | 207  | 192         | 29   | 4    | 5          | 563  | 159  | 698        | 744  | 140   |
| Reduct Vol:                                 | 0           | 0    | 0    | 0           | 0    | 0    | 0          | 0    | 0    | 0          | 0    | 0     |
| Reduced Vol:                                | 145         | 49   | 207  | 192         | 29   | 4    | 5          | 563  | 159  | 698        | 744  | 140   |
| PCE Adj:                                    | 1.00        | 1.00 | 1.00 | 1.00        | 1.00 | 1.00 | 1.00       | 1.00 | 1.00 | 1.00       | 1.00 | 1.00  |
| MLF Adj:                                    | 1.00        | 1.00 | 1.00 | 1.00        | 1.00 | 1.00 | 1.00       | 1.00 | 1.00 | 1.00       | 1.00 | 1.00  |
| Final Volume:                               | 145         | 49   | 207  | 192         | 29   | 4    | 5          | 563  | 159  | 698        | 744  | 140   |
| Saturation Flow Module:                     |             |      |      |             |      |      |            |      |      |            |      |       |
| Sat/Lane:                                   | 1900        | 1900 | 1900 | 1900        | 1900 | 1900 | 1900       | 1900 | 1900 | 1900       | 1900 | 1900  |
| Adjustment:                                 | 0.95        | 0.95 | 0.92 | 0.95        | 0.95 | 0.92 | 0.95       | 0.97 | 0.92 | 0.92       | 0.98 | 0.95  |
| Lanes:                                      | 0.75        | 0.25 | 1.00 | 0.87        | 0.13 | 1.00 | 0.02       | 1.98 | 1.00 | 1.00       | 1.67 | 0.33  |
| Final Sat.:                                 | 1345        | 455  | 1750 | 1564        | 236  | 1750 | 33         | 3667 | 1750 | 1750       | 3114 | 586   |
| Capacity Analysis Module:                   |             |      |      |             |      |      |            |      |      |            |      |       |
| Vol/Sat:                                    | 0.11        | 0.11 | 0.12 | 0.12        | 0.12 | 0.00 | 0.15       | 0.15 | 0.09 | 0.40       | 0.24 | 0.24  |
| Crit Moves:                                 |             |      |      | ****        |      |      |            | **** |      |            |      | ****  |
| Green Time:                                 | 23.8        | 23.8 | 23.8 | 23.8        | 23.8 | 23.8 | 29.8       | 29.8 | 29.8 | 77.4       | 107  | 107.2 |
| Volume/Cap:                                 | 0.63        | 0.63 | 0.70 | 0.72        | 0.72 | 0.01 | 0.72       | 0.72 | 0.43 | 0.72       | 0.31 | 0.31  |
| Delay/Veh:                                  | 58.3        | 58.3 | 61.7 | 63.1        | 63.1 | 48.3 | 54.5       | 54.5 | 48.5 | 26.0       | 5.1  | 5.1   |
| User DelAdj:                                | 1.00        | 1.00 | 1.00 | 1.00        | 1.00 | 1.00 | 1.00       | 1.00 | 1.00 | 1.00       | 1.00 | 1.00  |
| AdjDel/Veh:                                 | 58.3        | 58.3 | 61.7 | 63.1        | 63.1 | 48.3 | 54.5       | 54.5 | 48.5 | 26.0       | 5.1  | 5.1   |
| LOS by Move:                                | E           | E    | E    | E           | E    | D    | D          | D    | D    | C          | A    | A     |
| HCM2k95thQ:                                 | 15          | 15   | 17   | 20          | 20   | 0    | 21         | 21   | 12   | 40         | 10   | 4     |

Note: Queue reported is the number of cars per lane.

BART

Level Of Service Computation Report  
 2000 HCM Operations (Future Volume Alternative)  
 PM - Cumulative With Project

Intersection #4005: JULIAN/28TH [Study Int 3]

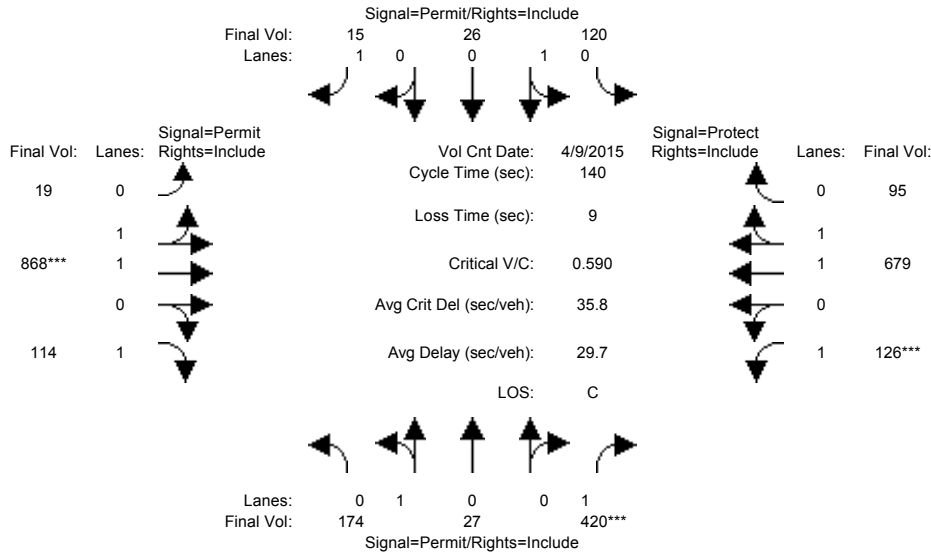

| Approach:                                   | North Bound |      |      | South Bound |      |      | East Bound |      |      | West Bound |      |      |
|---|-------------|------|------|-------------|------|------|------------|------|------|------------|------|------|
| Movement:                                   | L           | T    | R    | L           | T    | R    | L          | T    | R    | L          | T    | R    |
| Min. Green:                                 | 10          | 10   | 10   | 10          | 10   | 10   | 10         | 10   | 10   | 7          | 10   | 10   |
| Y+R:  | 4.0         | 4.0  | 4.0  | 4.0         | 4.0  | 4.0  | 4.0        | 4.0  | 4.0  | 4.0        | 4.0  | 4.0  |
| Volume Module: >> Count Date: 9 Apr 2015 << |             |      |      |             |      |      |            |      |      |            |      |      |
| Base Vol:                                   | 174         | 27   | 420  | 120         | 26   | 15   | 19         | 868  | 114  | 126        | 679  | 95   |
| Growth Adj:                                 | 1.00        | 1.00 | 1.00 | 1.00        | 1.00 | 1.00 | 1.00       | 1.00 | 1.00 | 1.00       | 1.00 | 1.00 |
| Initial Bse:                                | 174         | 27   | 420  | 120         | 26   | 15   | 19         | 868  | 114  | 126        | 679  | 95   |
| Added Vol:                                  | 0           | 0    | 0    | 0           | 0    | 0    | 0          | 0    | 0    | 0          | 0    | 0    |
| PasserByVol:                                | 0           | 0    | 0    | 0           | 0    | 0    | 0          | 0    | 0    | 0          | 0    | 0    |
| Initial Fut:                                | 174         | 27   | 420  | 120         | 26   | 15   | 19         | 868  | 114  | 126        | 679  | 95   |
| User Adj:                                   | 1.00        | 1.00 | 1.00 | 1.00        | 1.00 | 1.00 | 1.00       | 1.00 | 1.00 | 1.00       | 1.00 | 1.00 |
| PHF Adj:                                    | 1.00        | 1.00 | 1.00 | 1.00        | 1.00 | 1.00 | 1.00       | 1.00 | 1.00 | 1.00       | 1.00 | 1.00 |
| PHF Volume:                                 | 174         | 27   | 420  | 120         | 26   | 15   | 19         | 868  | 114  | 126        | 679  | 95   |
| Reduct Vol:                                 | 0           | 0    | 0    | 0           | 0    | 0    | 0          | 0    | 0    | 0          | 0    | 0    |
| Reduced Vol:                                | 174         | 27   | 420  | 120         | 26   | 15   | 19         | 868  | 114  | 126        | 679  | 95   |
| PCE Adj:                                    | 1.00        | 1.00 | 1.00 | 1.00        | 1.00 | 1.00 | 1.00       | 1.00 | 1.00 | 1.00       | 1.00 | 1.00 |
| MLF Adj:                                    | 1.00        | 1.00 | 1.00 | 1.00        | 1.00 | 1.00 | 1.00       | 1.00 | 1.00 | 1.00       | 1.00 | 1.00 |
| FinalVolume:                                | 174         | 27   | 420  | 120         | 26   | 15   | 19         | 868  | 114  | 126        | 679  | 95   |
| Saturation Flow Module:                     |             |      |      |             |      |      |            |      |      |            |      |      |
| Sat/Lane:                                   | 1900        | 1900 | 1900 | 1900        | 1900 | 1900 | 1900       | 1900 | 1900 | 1900       | 1900 | 1900 |
| Adjustment:                                 | 0.95        | 0.95 | 0.92 | 0.95        | 0.95 | 0.92 | 0.95       | 0.97 | 0.92 | 0.92       | 0.98 | 0.95 |
| Lanes:                                      | 0.87        | 0.13 | 1.00 | 0.82        | 0.18 | 1.00 | 0.04       | 1.96 | 1.00 | 1.00       | 1.75 | 0.25 |
| Final Sat.:                                 | 1558        | 242  | 1750 | 1479        | 321  | 1750 | 79         | 3621 | 1750 | 1750       | 3246 | 454  |
| Capacity Analysis Module:                   |             |      |      |             |      |      |            |      |      |            |      |      |
| Vol/Sat:                                    | 0.11        | 0.11 | 0.24 | 0.08        | 0.08 | 0.01 | 0.24       | 0.24 | 0.07 | 0.07       | 0.21 | 0.21 |
| Crit Moves:                                 | ****        |      |      | ****        |      |      | ****       |      |      | ****       |      |      |
| Green Time:                                 | 57.0        | 57.0 | 57.0 | 57.0        | 57.0 | 57.0 | 56.9       | 56.9 | 56.9 | 17.1       | 74.0 | 74.0 |
| Volume/Cap:                                 | 0.27        | 0.27 | 0.59 | 0.20        | 0.20 | 0.02 | 0.59       | 0.59 | 0.16 | 0.59       | 0.40 | 0.40 |
| Delay/Veh:                                  | 27.9        | 27.9 | 33.7 | 26.9        | 26.9 | 24.8 | 33.0       | 33.0 | 26.5 | 62.4       | 19.8 | 19.8 |
| User DelAdj:                                | 1.00        | 1.00 | 1.00 | 1.00        | 1.00 | 1.00 | 1.00       | 1.00 | 1.00 | 1.00       | 1.00 | 1.00 |
| AdjDel/Veh:                                 | 27.9        | 27.9 | 33.7 | 26.9        | 26.9 | 24.8 | 33.0       | 33.0 | 26.5 | 62.4       | 19.8 | 19.8 |
| LOS by Move:                                | C           | C    | C    | C           | C    | C    | C          | C    | C    | E          | B    | B    |
| HCM2k95thQ:                                 | 11          | 11   | 26   | 8           | 8    | 1    | 26         | 26   | 6    | 11         | 18   | 18   |

Note: Queue reported is the number of cars per lane.

BART

Level Of Service Computation Report  
 2000 HCM Operations (Future Volume Alternative)  
 AM - Cumulative No Project

Intersection #4022: SANTA CLARA/26TH [Study Int 12]

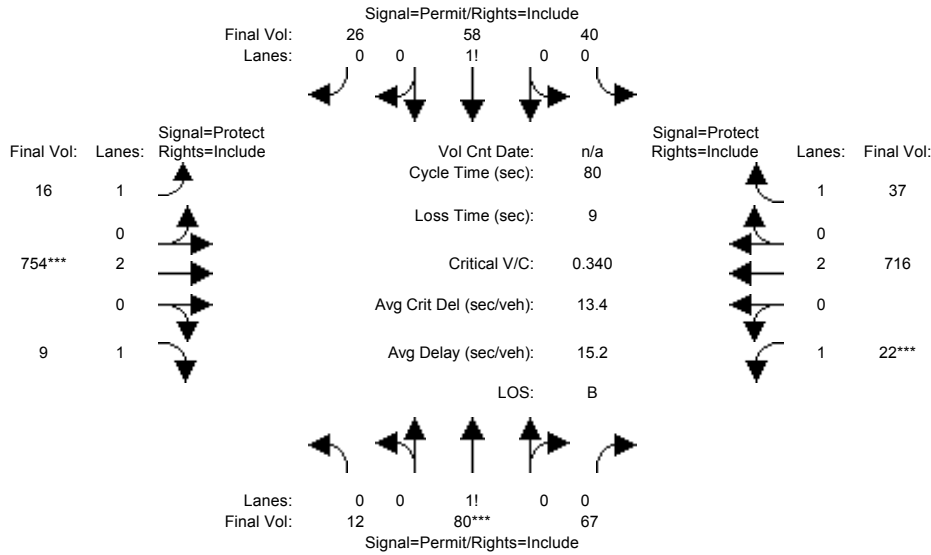

| Approach:                 | North Bound |      |      | South Bound |      |      | East Bound |      |      | West Bound |      |      |
|---------------------------|-------------|------|------|-------------|------|------|------------|------|------|------------|------|------|
| Movement:                 | L           | T    | R    | L           | T    | R    | L          | T    | R    | L          | T    | R    |
| Min. Green:               | 10          | 10   | 10   | 10          | 10   | 10   | 7          | 10   | 10   | 7          | 10   | 10   |
| Y+R:                      | 4.0         | 4.0  | 4.0  | 4.0         | 4.0  | 4.0  | 4.0        | 4.0  | 4.0  | 4.0        | 4.0  | 4.0  |
| Volume Module:            |             |      |      |             |      |      |            |      |      |            |      |      |
| Base Vol:                 | 12          | 80   | 67   | 40          | 58   | 26   | 16         | 754  | 9    | 22         | 716  | 37   |
| Growth Adj:               | 1.00        | 1.00 | 1.00 | 1.00        | 1.00 | 1.00 | 1.00       | 1.00 | 1.00 | 1.00       | 1.00 | 1.00 |
| Initial Bse:              | 12          | 80   | 67   | 40          | 58   | 26   | 16         | 754  | 9    | 22         | 716  | 37   |
| Added Vol:                | 0           | 0    | 0    | 0           | 0    | 0    | 0          | 0    | 0    | 0          | 0    | 0    |
| PasserByVol:              | 0           | 0    | 0    | 0           | 0    | 0    | 0          | 0    | 0    | 0          | 0    | 0    |
| Initial Fut:              | 12          | 80   | 67   | 40          | 58   | 26   | 16         | 754  | 9    | 22         | 716  | 37   |
| User Adj:                 | 1.00        | 1.00 | 1.00 | 1.00        | 1.00 | 1.00 | 1.00       | 1.00 | 1.00 | 1.00       | 1.00 | 1.00 |
| PHF Adj:                  | 1.00        | 1.00 | 1.00 | 1.00        | 1.00 | 1.00 | 1.00       | 1.00 | 1.00 | 1.00       | 1.00 | 1.00 |
| PHF Volume:               | 12          | 80   | 67   | 40          | 58   | 26   | 16         | 754  | 9    | 22         | 716  | 37   |
| Reduct Vol:               | 0           | 0    | 0    | 0           | 0    | 0    | 0          | 0    | 0    | 0          | 0    | 0    |
| Reduced Vol:              | 12          | 80   | 67   | 40          | 58   | 26   | 16         | 754  | 9    | 22         | 716  | 37   |
| PCE Adj:                  | 1.00        | 1.00 | 1.00 | 1.00        | 1.00 | 1.00 | 1.00       | 1.00 | 1.00 | 1.00       | 1.00 | 1.00 |
| MLF Adj:                  | 1.00        | 1.00 | 1.00 | 1.00        | 1.00 | 1.00 | 1.00       | 1.00 | 1.00 | 1.00       | 1.00 | 1.00 |
| Final Volume:             | 12          | 80   | 67   | 40          | 58   | 26   | 16         | 754  | 9    | 22         | 716  | 37   |
| Saturation Flow Module:   |             |      |      |             |      |      |            |      |      |            |      |      |
| Sat/Lane:                 | 1900        | 1900 | 1900 | 1900        | 1900 | 1900 | 1900       | 1900 | 1900 | 1900       | 1900 | 1900 |
| Adjustment:               | 0.92        | 0.92 | 0.92 | 0.92        | 0.92 | 0.92 | 0.92       | 1.00 | 0.92 | 0.92       | 1.00 | 0.92 |
| Lanes:                    | 0.08        | 0.50 | 0.42 | 0.32        | 0.47 | 0.21 | 1.00       | 2.00 | 1.00 | 1.00       | 2.00 | 1.00 |
| Final Sat.:               | 132         | 881  | 737  | 565         | 819  | 367  | 1750       | 3800 | 1750 | 1750       | 3800 | 1750 |
| Capacity Analysis Module: |             |      |      |             |      |      |            |      |      |            |      |      |
| Vol/Sat:                  | 0.09        | 0.09 | 0.09 | 0.07        | 0.07 | 0.07 | 0.01       | 0.20 | 0.01 | 0.01       | 0.19 | 0.02 |
| Crit Moves:               | ****        |      |      | ****        |      |      | ****       |      |      | ****       |      |      |
| Green Time:               | 20.1        | 20.1 | 20.1 | 20.1        | 20.1 | 20.1 | 16.1       | 43.9 | 43.9 | 7.0        | 34.8 | 34.8 |
| Volume/Cap:               | 0.36        | 0.36 | 0.36 | 0.28        | 0.28 | 0.28 | 0.05       | 0.36 | 0.01 | 0.14       | 0.43 | 0.05 |
| Delay/Veh:                | 25.2        | 25.2 | 25.2 | 24.5        | 24.5 | 24.5 | 25.8       | 10.3 | 8.2  | 34.2       | 15.9 | 13.1 |
| User DelAdj:              | 1.00        | 1.00 | 1.00 | 1.00        | 1.00 | 1.00 | 1.00       | 1.00 | 1.00 | 1.00       | 1.00 | 1.00 |
| AdjDel/Veh:               | 25.2        | 25.2 | 25.2 | 24.5        | 24.5 | 24.5 | 25.8       | 10.3 | 8.2  | 34.2       | 15.9 | 13.1 |
| LOS by Move:              | C           | C    | C    | C           | C    | C    | C          | B    | A    | C          | B    | B    |
| HCM2k95thQ:               | 7           | 7    | 7    | 6           | 6    | 6    | 1          | 10   | 0    | 1          | 11   | 1    |

Note: Queue reported is the number of cars per lane.

BART

Level Of Service Computation Report  
 2000 HCM Operations (Future Volume Alternative)  
 PM - Cumulative No Project

Intersection #4022: SANTA CLARA/26TH [Study Int 12]

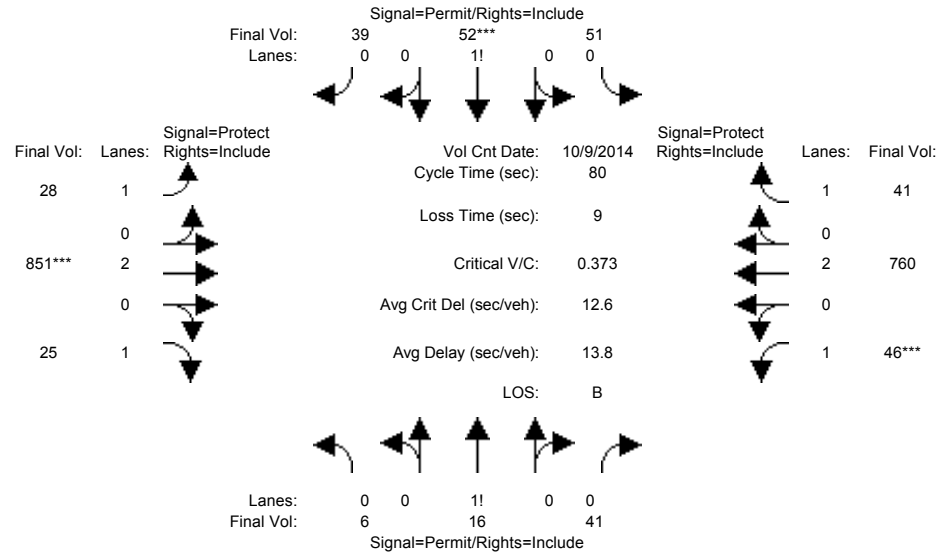

| Approach:                                   | North Bound |      |      | South Bound |      |      | East Bound |      |      | West Bound |      |      |
|---|-------------|------|------|-------------|------|------|------------|------|------|------------|------|------|
| Movement:                                   | L           | T    | R    | L           | T    | R    | L          | T    | R    | L          | T    | R    |
| Min. Green:                                 | 10          | 10   | 10   | 10          | 10   | 10   | 7          | 10   | 10   | 7          | 10   | 10   |
| Y+R:  | 4.0         | 4.0  | 4.0  | 4.0         | 4.0  | 4.0  | 4.0        | 4.0  | 4.0  | 4.0        | 4.0  | 4.0  |
| Volume Module: >> Count Date: 9 Oct 2014 << |             |      |      |             |      |      |            |      |      |            |      |      |
| Base Vol:                                   | 6           | 16   | 41   | 51          | 52   | 39   | 28         | 851  | 25   | 46         | 760  | 41   |
| Growth Adj:                                 | 1.00        | 1.00 | 1.00 | 1.00        | 1.00 | 1.00 | 1.00       | 1.00 | 1.00 | 1.00       | 1.00 | 1.00 |
| Initial Bse:                                | 6           | 16   | 41   | 51          | 52   | 39   | 28         | 851  | 25   | 46         | 760  | 41   |
| Added Vol:                                  | 0           | 0    | 0    | 0           | 0    | 0    | 0          | 0    | 0    | 0          | 0    | 0    |
| PasserByVol:                                | 0           | 0    | 0    | 0           | 0    | 0    | 0          | 0    | 0    | 0          | 0    | 0    |
| Initial Fut:                                | 6           | 16   | 41   | 51          | 52   | 39   | 28         | 851  | 25   | 46         | 760  | 41   |
| User Adj:                                   | 1.00        | 1.00 | 1.00 | 1.00        | 1.00 | 1.00 | 1.00       | 1.00 | 1.00 | 1.00       | 1.00 | 1.00 |
| PHF Adj:                                    | 1.00        | 1.00 | 1.00 | 1.00        | 1.00 | 1.00 | 1.00       | 1.00 | 1.00 | 1.00       | 1.00 | 1.00 |
| PHF Volume:                                 | 6           | 16   | 41   | 51          | 52   | 39   | 28         | 851  | 25   | 46         | 760  | 41   |
| Reduct Vol:                                 | 0           | 0    | 0    | 0           | 0    | 0    | 0          | 0    | 0    | 0          | 0    | 0    |
| Reduced Vol:                                | 6           | 16   | 41   | 51          | 52   | 39   | 28         | 851  | 25   | 46         | 760  | 41   |
| PCE Adj:                                    | 1.00        | 1.00 | 1.00 | 1.00        | 1.00 | 1.00 | 1.00       | 1.00 | 1.00 | 1.00       | 1.00 | 1.00 |
| MLF Adj:                                    | 1.00        | 1.00 | 1.00 | 1.00        | 1.00 | 1.00 | 1.00       | 1.00 | 1.00 | 1.00       | 1.00 | 1.00 |
| Final Volume:                               | 6           | 16   | 41   | 51          | 52   | 39   | 28         | 851  | 25   | 46         | 760  | 41   |
| Saturation Flow Module:                     |             |      |      |             |      |      |            |      |      |            |      |      |
| Sat/Lane:                                   | 1900        | 1900 | 1900 | 1900        | 1900 | 1900 | 1900       | 1900 | 1900 | 1900       | 1900 | 1900 |
| Adjustment:                                 | 0.92        | 0.92 | 0.92 | 0.92        | 0.92 | 0.92 | 0.92       | 1.00 | 0.92 | 0.92       | 1.00 | 0.92 |
| Lanes:                                      | 0.10        | 0.25 | 0.65 | 0.36        | 0.37 | 0.27 | 1.00       | 2.00 | 1.00 | 1.00       | 2.00 | 1.00 |
| Final Sat.:                                 | 167         | 444  | 1139 | 629         | 641  | 481  | 1750       | 3800 | 1750 | 1750       | 3800 | 1750 |
| Capacity Analysis Module:                   |             |      |      |             |      |      |            |      |      |            |      |      |
| Vol/Sat:                                    | 0.04        | 0.04 | 0.04 | 0.08        | 0.08 | 0.08 | 0.02       | 0.22 | 0.01 | 0.03       | 0.20 | 0.02 |
| Crit Moves:                                 |             |      |      | ****        |      |      | ****       |      |      | ****       |      |      |
| Green Time:                                 | 17.0        | 17.0 | 17.0 | 17.0        | 17.0 | 17.0 | 16.4       | 47.0 | 47.0 | 7.0        | 37.6 | 37.6 |
| Volume/Cap:                                 | 0.17        | 0.17 | 0.17 | 0.38        | 0.38 | 0.38 | 0.08       | 0.38 | 0.02 | 0.30       | 0.43 | 0.05 |
| Delay/Veh:                                  | 25.9        | 25.9 | 25.9 | 27.6        | 27.6 | 27.6 | 25.8       | 8.9  | 6.9  | 35.3       | 14.2 | 11.6 |
| User DelAdj:                                | 1.00        | 1.00 | 1.00 | 1.00        | 1.00 | 1.00 | 1.00       | 1.00 | 1.00 | 1.00       | 1.00 | 1.00 |
| AdjDel/Veh:                                 | 25.9        | 25.9 | 25.9 | 27.6        | 27.6 | 27.6 | 25.8       | 8.9  | 6.9  | 35.3       | 14.2 | 11.6 |
| LOS by Move:                                | C           | C    | C    | C           | C    | C    | C          | A    | A    | D          | B    | B    |
| HCM2k95thQ:                                 | 3           | 3    | 3    | 7           | 7    | 7    | 1          | 11   | 1    | 2          | 12   | 1    |

Note: Queue reported is the number of cars per lane.

BART

Level Of Service Computation Report  
2000 HCM Operations (Future Volume Alternative)  
AM - Cumulative With Project

Intersection #4022: SANTA CLARA/26TH [Study Int 12]

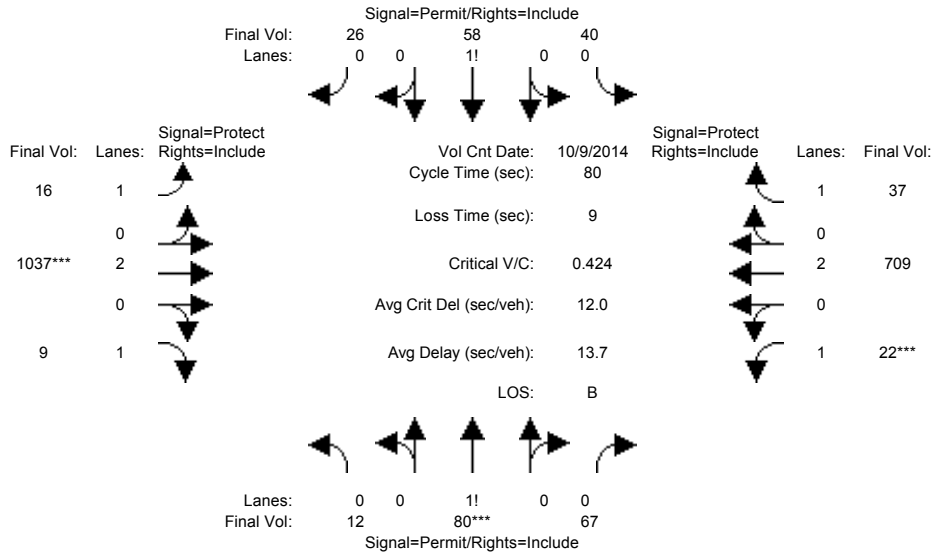

| Approach:                                   | North Bound |      |      | South Bound |      |      | East Bound |      |      | West Bound |      |      |
|---|-------------|------|------|-------------|------|------|------------|------|------|------------|------|------|
| Movement:                                   | L           | T    | R    | L           | T    | R    | L          | T    | R    | L          | T    | R    |
| Min. Green:                                 | 10          | 10   | 10   | 10          | 10   | 10   | 7          | 10   | 10   | 7          | 10   | 10   |
| Y+R:  | 4.0         | 4.0  | 4.0  | 4.0         | 4.0  | 4.0  | 4.0        | 4.0  | 4.0  | 4.0        | 4.0  | 4.0  |
| Volume Module: >> Count Date: 9 Oct 2014 << |             |      |      |             |      |      |            |      |      |            |      |      |
| Base Vol:                                   | 12          | 80   | 67   | 40          | 58   | 26   | 16         | 1037 | 9    | 22         | 709  | 37   |
| Growth Adj:                                 | 1.00        | 1.00 | 1.00 | 1.00        | 1.00 | 1.00 | 1.00       | 1.00 | 1.00 | 1.00       | 1.00 | 1.00 |
| Initial Bse:                                | 12          | 80   | 67   | 40          | 58   | 26   | 16         | 1037 | 9    | 22         | 709  | 37   |
| Added Vol:                                  | 0           | 0    | 0    | 0           | 0    | 0    | 0          | 0    | 0    | 0          | 0    | 0    |
| PasserByVol:                                | 0           | 0    | 0    | 0           | 0    | 0    | 0          | 0    | 0    | 0          | 0    | 0    |
| Initial Fut:                                | 12          | 80   | 67   | 40          | 58   | 26   | 16         | 1037 | 9    | 22         | 709  | 37   |
| User Adj:                                   | 1.00        | 1.00 | 1.00 | 1.00        | 1.00 | 1.00 | 1.00       | 1.00 | 1.00 | 1.00       | 1.00 | 1.00 |
| PHF Adj:                                    | 1.00        | 1.00 | 1.00 | 1.00        | 1.00 | 1.00 | 1.00       | 1.00 | 1.00 | 1.00       | 1.00 | 1.00 |
| PHF Volume:                                 | 12          | 80   | 67   | 40          | 58   | 26   | 16         | 1037 | 9    | 22         | 709  | 37   |
| Reduct Vol:                                 | 0           | 0    | 0    | 0           | 0    | 0    | 0          | 0    | 0    | 0          | 0    | 0    |
| Reduced Vol:                                | 12          | 80   | 67   | 40          | 58   | 26   | 16         | 1037 | 9    | 22         | 709  | 37   |
| PCE Adj:                                    | 1.00        | 1.00 | 1.00 | 1.00        | 1.00 | 1.00 | 1.00       | 1.00 | 1.00 | 1.00       | 1.00 | 1.00 |
| MLF Adj:                                    | 1.00        | 1.00 | 1.00 | 1.00        | 1.00 | 1.00 | 1.00       | 1.00 | 1.00 | 1.00       | 1.00 | 1.00 |
| Final Volume:                               | 12          | 80   | 67   | 40          | 58   | 26   | 16         | 1037 | 9    | 22         | 709  | 37   |
| Saturation Flow Module:                     |             |      |      |             |      |      |            |      |      |            |      |      |
| Sat/Lane:                                   | 1900        | 1900 | 1900 | 1900        | 1900 | 1900 | 1900       | 1900 | 1900 | 1900       | 1900 | 1900 |
| Adjustment:                                 | 0.92        | 0.92 | 0.92 | 0.92        | 0.92 | 0.92 | 0.92       | 1.00 | 0.92 | 0.92       | 1.00 | 0.92 |
| Lanes:                                      | 0.08        | 0.50 | 0.42 | 0.32        | 0.47 | 0.21 | 1.00       | 2.00 | 1.00 | 1.00       | 2.00 | 1.00 |
| Final Sat.:                                 | 132         | 881  | 737  | 565         | 819  | 367  | 1750       | 3800 | 1750 | 1750       | 3800 | 1750 |
| Capacity Analysis Module:                   |             |      |      |             |      |      |            |      |      |            |      |      |
| Vol/Sat:                                    | 0.09        | 0.09 | 0.09 | 0.07        | 0.07 | 0.07 | 0.01       | 0.27 | 0.01 | 0.01       | 0.19 | 0.02 |
| Crit Moves:                                 | ****        |      |      |             |      |      | ****       |      |      | ****       |      |      |
| Green Time:                                 | 16.0        | 16.0 | 16.0 | 16.0        | 16.0 | 16.0 | 17.6       | 48.0 | 48.0 | 7.0        | 37.5 | 37.5 |
| Volume/Cap:                                 | 0.45        | 0.45 | 0.45 | 0.35        | 0.35 | 0.35 | 0.04       | 0.45 | 0.01 | 0.14       | 0.40 | 0.05 |
| Delay/Veh:                                  | 29.1        | 29.1 | 29.1 | 28.2        | 28.2 | 28.2 | 24.6       | 8.9  | 6.4  | 34.2       | 14.1 | 11.6 |
| User DelAdj:                                | 1.00        | 1.00 | 1.00 | 1.00        | 1.00 | 1.00 | 1.00       | 1.00 | 1.00 | 1.00       | 1.00 | 1.00 |
| AdjDel/Veh:                                 | 29.1        | 29.1 | 29.1 | 28.2        | 28.2 | 28.2 | 24.6       | 8.9  | 6.4  | 34.2       | 14.1 | 11.6 |
| LOS by Move:                                | C           | C    | C    | C           | C    | C    | C          | A    | A    | C          | B    | B    |
| HCM2k95thQ:                                 | 8           | 8    | 8    | 6           | 6    | 6    | 1          | 13   | 0    | 1          | 10   | 1    |

Note: Queue reported is the number of cars per lane.

BART

Level Of Service Computation Report  
 2000 HCM Operations (Future Volume Alternative)  
 PM - Cumulative With Project

Intersection #4022: SANTA CLARA/26TH [Study Int 12]

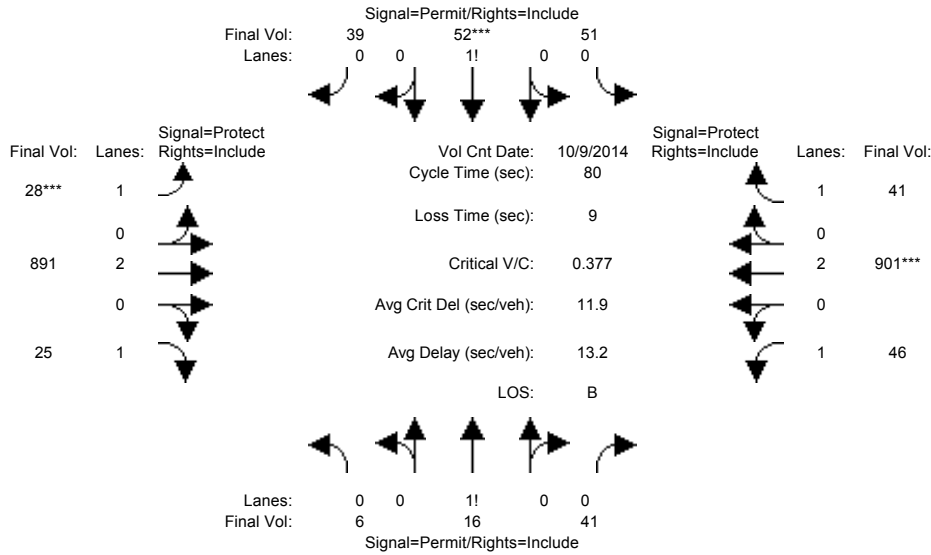

| Approach:                                   | North Bound |      |      | South Bound |      |      | East Bound |      |      | West Bound |      |      |
|---|-------------|------|------|-------------|------|------|------------|------|------|------------|------|------|
| Movement:                                   | L           | T    | R    | L           | T    | R    | L          | T    | R    | L          | T    | R    |
| Min. Green:                                 | 10          | 10   | 10   | 10          | 10   | 10   | 7          | 10   | 10   | 7          | 10   | 10   |
| Y+R:  | 4.0         | 4.0  | 4.0  | 4.0         | 4.0  | 4.0  | 4.0        | 4.0  | 4.0  | 4.0        | 4.0  | 4.0  |
| -----                                       |             |      |      |             |      |      |            |      |      |            |      |      |
| Volume Module: >> Count Date: 9 Oct 2014 << |             |      |      |             |      |      |            |      |      |            |      |      |
| Base Vol:                                   | 6           | 16   | 41   | 51          | 52   | 39   | 28         | 891  | 25   | 46         | 901  | 41   |
| Growth Adj:                                 | 1.00        | 1.00 | 1.00 | 1.00        | 1.00 | 1.00 | 1.00       | 1.00 | 1.00 | 1.00       | 1.00 | 1.00 |
| Initial Bse:                                | 6           | 16   | 41   | 51          | 52   | 39   | 28         | 891  | 25   | 46         | 901  | 41   |
| Added Vol:                                  | 0           | 0    | 0    | 0           | 0    | 0    | 0          | 0    | 0    | 0          | 0    | 0    |
| PasserByVol:                                | 0           | 0    | 0    | 0           | 0    | 0    | 0          | 0    | 0    | 0          | 0    | 0    |
| Initial Fut:                                | 6           | 16   | 41   | 51          | 52   | 39   | 28         | 891  | 25   | 46         | 901  | 41   |
| User Adj:                                   | 1.00        | 1.00 | 1.00 | 1.00        | 1.00 | 1.00 | 1.00       | 1.00 | 1.00 | 1.00       | 1.00 | 1.00 |
| PHF Adj:                                    | 1.00        | 1.00 | 1.00 | 1.00        | 1.00 | 1.00 | 1.00       | 1.00 | 1.00 | 1.00       | 1.00 | 1.00 |
| PHF Volume:                                 | 6           | 16   | 41   | 51          | 52   | 39   | 28         | 891  | 25   | 46         | 901  | 41   |
| Reduct Vol:                                 | 0           | 0    | 0    | 0           | 0    | 0    | 0          | 0    | 0    | 0          | 0    | 0    |
| Reduced Vol:                                | 6           | 16   | 41   | 51          | 52   | 39   | 28         | 891  | 25   | 46         | 901  | 41   |
| PCE Adj:                                    | 1.00        | 1.00 | 1.00 | 1.00        | 1.00 | 1.00 | 1.00       | 1.00 | 1.00 | 1.00       | 1.00 | 1.00 |
| MLF Adj:                                    | 1.00        | 1.00 | 1.00 | 1.00        | 1.00 | 1.00 | 1.00       | 1.00 | 1.00 | 1.00       | 1.00 | 1.00 |
| Final Volume:                               | 6           | 16   | 41   | 51          | 52   | 39   | 28         | 891  | 25   | 46         | 901  | 41   |
| -----                                       |             |      |      |             |      |      |            |      |      |            |      |      |
| Saturation Flow Module:                     |             |      |      |             |      |      |            |      |      |            |      |      |
| Sat/Lane:                                   | 1900        | 1900 | 1900 | 1900        | 1900 | 1900 | 1900       | 1900 | 1900 | 1900       | 1900 | 1900 |
| Adjustment:                                 | 0.92        | 0.92 | 0.92 | 0.92        | 0.92 | 0.92 | 0.92       | 1.00 | 0.92 | 0.92       | 1.00 | 0.92 |
| Lanes:                                      | 0.10        | 0.25 | 0.65 | 0.36        | 0.37 | 0.27 | 1.00       | 2.00 | 1.00 | 1.00       | 2.00 | 1.00 |
| Final Sat.:                                 | 167         | 444  | 1139 | 629         | 641  | 481  | 1750       | 3800 | 1750 | 1750       | 3800 | 1750 |
| -----                                       |             |      |      |             |      |      |            |      |      |            |      |      |
| Capacity Analysis Module:                   |             |      |      |             |      |      |            |      |      |            |      |      |
| Vol/Sat:                                    | 0.04        | 0.04 | 0.04 | 0.08        | 0.08 | 0.08 | 0.02       | 0.23 | 0.01 | 0.03       | 0.24 | 0.02 |
| Crit Moves:                                 | *****       |      |      | *****       |      |      | *****      |      |      | *****      |      |      |
| Green Time:                                 | 16.3        | 16.3 | 16.3 | 16.3        | 16.3 | 16.3 | 7.0        | 39.8 | 39.8 | 14.9       | 47.7 | 47.7 |
| Volume/Cap:                                 | 0.18        | 0.18 | 0.18 | 0.40        | 0.40 | 0.40 | 0.18       | 0.47 | 0.03 | 0.14       | 0.40 | 0.04 |
| Delay/Veh:                                  | 26.5        | 26.5 | 26.5 | 28.3        | 28.3 | 28.3 | 34.4       | 13.4 | 10.2 | 27.4       | 8.7  | 6.7  |
| User DelAdj:                                | 1.00        | 1.00 | 1.00 | 1.00        | 1.00 | 1.00 | 1.00       | 1.00 | 1.00 | 1.00       | 1.00 | 1.00 |
| AdjDel/Veh:                                 | 26.5        | 26.5 | 26.5 | 28.3        | 28.3 | 28.3 | 34.4       | 13.4 | 10.2 | 27.4       | 8.7  | 6.7  |
| LOS by Move:                                | C           | C    | C    | C           | C    | C    | C          | B    | B    | C          | A    | A    |
| HCM2k95thQ:                                 | 3           | 3    | 3    | 7           | 7    | 7    | 1          | 13   | 1    | 2          | 11   | 1    |

Note: Queue reported is the number of cars per lane.

BART

Level Of Service Computation Report  
 2000 HCM Operations (Future Volume Alternative)  
 AM - Cumulative No Project

Intersection #4038: 87/Taylor [Study Int 40]

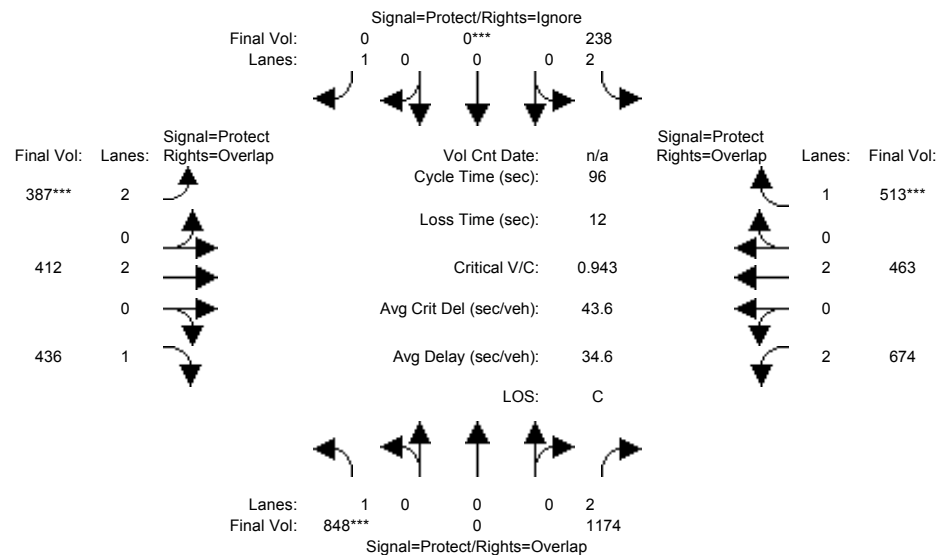

| Approach:                 | North Bound |      |      | South Bound |      |      | East Bound |      |      | West Bound |      |      |
|---------------------------|-------------|------|------|-------------|------|------|------------|------|------|------------|------|------|
| Movement:                 | L           | T    | R    | L           | T    | R    | L          | T    | R    | L          | T    | R    |
| Min. Green:               | 7           | 0    | 10   | 7           | 0    | 10   | 7          | 10   | 10   | 7          | 10   | 10   |
| Y+R:                      | 4.0         | 4.0  | 4.0  | 4.0         | 4.0  | 4.0  | 4.0        | 4.0  | 4.0  | 4.0        | 4.0  | 4.0  |
| Volume Module:            |             |      |      |             |      |      |            |      |      |            |      |      |
| Base Vol:                 | 848         | 0    | 1174 | 238         | 0    | 319  | 387        | 412  | 436  | 674        | 463  | 513  |
| Growth Adj:               | 1.00        | 1.00 | 1.00 | 1.00        | 1.00 | 1.00 | 1.00       | 1.00 | 1.00 | 1.00       | 1.00 | 1.00 |
| Initial Bse:              | 848         | 0    | 1174 | 238         | 0    | 319  | 387        | 412  | 436  | 674        | 463  | 513  |
| Added Vol:                | 0           | 0    | 0    | 0           | 0    | 0    | 0          | 0    | 0    | 0          | 0    | 0    |
| PasserByVol:              | 0           | 0    | 0    | 0           | 0    | 0    | 0          | 0    | 0    | 0          | 0    | 0    |
| Initial Fut:              | 848         | 0    | 1174 | 238         | 0    | 319  | 387        | 412  | 436  | 674        | 463  | 513  |
| User Adj:                 | 1.00        | 1.00 | 1.00 | 1.00        | 1.00 | 0.00 | 1.00       | 1.00 | 1.00 | 1.00       | 1.00 | 1.00 |
| PHF Adj:                  | 1.00        | 1.00 | 1.00 | 1.00        | 1.00 | 0.00 | 1.00       | 1.00 | 1.00 | 1.00       | 1.00 | 1.00 |
| PHF Volume:               | 848         | 0    | 1174 | 238         | 0    | 0    | 387        | 412  | 436  | 674        | 463  | 513  |
| Reduct Vol:               | 0           | 0    | 0    | 0           | 0    | 0    | 0          | 0    | 0    | 0          | 0    | 0    |
| Reduced Vol:              | 848         | 0    | 1174 | 238         | 0    | 0    | 387        | 412  | 436  | 674        | 463  | 513  |
| PCE Adj:                  | 1.00        | 1.00 | 1.00 | 1.00        | 1.00 | 0.00 | 1.00       | 1.00 | 1.00 | 1.00       | 1.00 | 1.00 |
| MLF Adj:                  | 1.00        | 1.00 | 1.00 | 1.00        | 1.00 | 0.00 | 1.00       | 1.00 | 1.00 | 1.00       | 1.00 | 1.00 |
| Final Volume:             | 848         | 0    | 1174 | 238         | 0    | 0    | 387        | 412  | 436  | 674        | 463  | 513  |
| Saturation Flow Module:   |             |      |      |             |      |      |            |      |      |            |      |      |
| Sat/Lane:                 | 1900        | 1900 | 1900 | 1900        | 1900 | 1900 | 1900       | 1900 | 1900 | 1900       | 1900 | 1900 |
| Adjustment:               | 0.92        | 1.00 | 0.83 | 0.83        | 1.00 | 0.92 | 0.83       | 1.00 | 0.92 | 0.83       | 1.00 | 0.92 |
| Lanes:                    | 1.00        | 0.00 | 2.00 | 2.00        | 0.00 | 1.00 | 2.00       | 2.00 | 1.00 | 2.00       | 2.00 | 1.00 |
| Final Sat.:               | 1750        | 0    | 3150 | 3150        | 0    | 1750 | 3150       | 3800 | 1750 | 3150       | 3800 | 1750 |
| Capacity Analysis Module: |             |      |      |             |      |      |            |      |      |            |      |      |
| Vol/Sat:                  | 0.48        | 0.00 | 0.37 | 0.08        | 0.00 | 0.00 | 0.12       | 0.11 | 0.25 | 0.21       | 0.12 | 0.29 |
| Crit Moves:               | ****        |      |      | ****        |      |      | ****       |      |      | ****       |      |      |
| Green Time:               | 49.3        | 0.0  | 56.4 | 15.9        | 0.0  | 0.0  | 12.5       | 11.7 | 61.0 | 23.0       | 22.2 | 38.1 |
| Volume/Cap:               | 0.94        | 0.00 | 0.63 | 0.46        | 0.00 | 0.00 | 0.94       | 0.89 | 0.39 | 0.89       | 0.53 | 0.74 |
| Delay/Veh:                | 39.8        | 0.0  | 13.7 | 36.8        | 0.0  | 0.0  | 71.6       | 60.8 | 8.7  | 48.3       | 32.9 | 29.0 |
| User DelAdj:              | 1.00        | 1.00 | 1.00 | 1.00        | 1.00 | 1.00 | 1.00       | 1.00 | 1.00 | 1.00       | 1.00 | 1.00 |
| AdjDel/Veh:               | 39.8        | 0.0  | 13.7 | 36.8        | 0.0  | 0.0  | 71.6       | 60.8 | 8.7  | 48.3       | 32.9 | 29.0 |
| LOS by Move:              | D           | A    | B    | D           | A    | A    | E          | E    | A    | D          | C    | C    |
| HCM2k95thQ:               | 50          | 0    | 25   | 8           | 0    | 0    | 14         | 12   | 12   | 27         | 12   | 27   |

Note: Queue reported is the number of cars per lane.



BART

Level Of Service Computation Report  
 2000 HCM Operations (Future Volume Alternative)  
 PM - Cumulative No Project

Intersection #4038: 87/Taylor [Study Int 40]

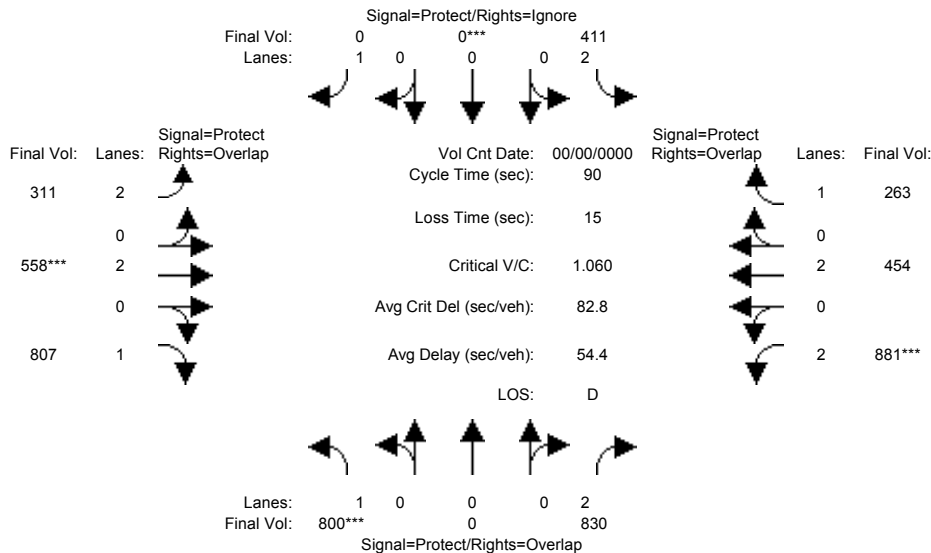

| Approach:                            | North Bound |      |      | South Bound |      |      | East Bound |      |      | West Bound |      |      |
|--------------------------------------|-------------|------|------|-------------|------|------|------------|------|------|------------|------|------|
| Movement:                            | L           | T    | R    | L           | T    | R    | L          | T    | R    | L          | T    | R    |
| Min. Green:                          | 7           | 0    | 10   | 7           | 0    | 10   | 7          | 10   | 10   | 7          | 10   | 10   |
| Y+R:                                 | 4.0         | 4.0  | 4.0  | 4.0         | 4.0  | 4.0  | 4.0        | 4.0  | 4.0  | 4.0        | 4.0  | 4.0  |
| Volume Module: >> Count Date: 0 0 << |             |      |      |             |      |      |            |      |      |            |      |      |
| Base Vol:                            | 800         | 0    | 830  | 411         | 0    | 520  | 311        | 558  | 807  | 881        | 454  | 263  |
| Growth Adj:                          | 1.00        | 1.00 | 1.00 | 1.00        | 1.00 | 1.00 | 1.00       | 1.00 | 1.00 | 1.00       | 1.00 | 1.00 |
| Initial Bse:                         | 800         | 0    | 830  | 411         | 0    | 520  | 311        | 558  | 807  | 881        | 454  | 263  |
| Added Vol:                           | 0           | 0    | 0    | 0           | 0    | 0    | 0          | 0    | 0    | 0          | 0    | 0    |
| PasserByVol:                         | 0           | 0    | 0    | 0           | 0    | 0    | 0          | 0    | 0    | 0          | 0    | 0    |
| Initial Fut:                         | 800         | 0    | 830  | 411         | 0    | 520  | 311        | 558  | 807  | 881        | 454  | 263  |
| User Adj:                            | 1.00        | 1.00 | 1.00 | 1.00        | 1.00 | 0.00 | 1.00       | 1.00 | 1.00 | 1.00       | 1.00 | 1.00 |
| PHF Adj:                             | 1.00        | 1.00 | 1.00 | 1.00        | 1.00 | 0.00 | 1.00       | 1.00 | 1.00 | 1.00       | 1.00 | 1.00 |
| PHF Volume:                          | 800         | 0    | 830  | 411         | 0    | 0    | 311        | 558  | 807  | 881        | 454  | 263  |
| Reduct Vol:                          | 0           | 0    | 0    | 0           | 0    | 0    | 0          | 0    | 0    | 0          | 0    | 0    |
| Reduced Vol:                         | 800         | 0    | 830  | 411         | 0    | 0    | 311        | 558  | 807  | 881        | 454  | 263  |
| PCE Adj:                             | 1.00        | 1.00 | 1.00 | 1.00        | 1.00 | 0.00 | 1.00       | 1.00 | 1.00 | 1.00       | 1.00 | 1.00 |
| MLF Adj:                             | 1.00        | 1.00 | 1.00 | 1.00        | 1.00 | 0.00 | 1.00       | 1.00 | 1.00 | 1.00       | 1.00 | 1.00 |
| FinalVolume:                         | 800         | 0    | 830  | 411         | 0    | 0    | 311        | 558  | 807  | 881        | 454  | 263  |
| Saturation Flow Module:              |             |      |      |             |      |      |            |      |      |            |      |      |
| Sat/Lane:                            | 1900        | 1900 | 1900 | 1900        | 1900 | 1900 | 1900       | 1900 | 1900 | 1900       | 1900 | 1900 |
| Adjustment:                          | 0.92        | 1.00 | 0.83 | 0.83        | 1.00 | 0.92 | 0.83       | 1.00 | 0.92 | 0.83       | 1.00 | 0.92 |
| Lanes:                               | 1.00        | 0.00 | 2.00 | 2.00        | 0.00 | 1.00 | 2.00       | 2.00 | 1.00 | 2.00       | 2.00 | 1.00 |
| Final Sat.:                          | 1750        | 0    | 3150 | 3150        | 0    | 1750 | 3150       | 3800 | 1750 | 3150       | 3800 | 1750 |
| Capacity Analysis Module:            |             |      |      |             |      |      |            |      |      |            |      |      |
| Vol/Sat:                             | 0.46        | 0.00 | 0.26 | 0.13        | 0.00 | 0.00 | 0.10       | 0.15 | 0.46 | 0.28       | 0.12 | 0.15 |
| Crit Moves:                          | ****        |      |      | ****        |      |      | ****       |      | **** | ****       |      |      |
| Green Time:                          | 38.8        | 0.0  | 23.7 | 38.8        | 0.0  | 0.0  | 16.4       | 12.5 | 51.3 | 23.7       | 19.8 | 58.6 |
| Volume/Cap:                          | 1.06        | 0.00 | 1.00 | 0.30        | 0.00 | 0.00 | 0.54       | 1.06 | 0.81 | 1.06       | 0.54 | 0.23 |
| Delay/Veh:                           | 75.6        | 0.0  | 64.1 | 16.9        | 0.0  | 0.0  | 34.5       | 95.0 | 20.5 | 81.6       | 31.8 | 6.5  |
| User DelAdj:                         | 1.00        | 1.00 | 1.00 | 1.00        | 1.00 | 1.00 | 1.00       | 1.00 | 1.00 | 1.00       | 1.00 | 1.00 |
| AdjDel/Veh:                          | 75.6        | 0.0  | 64.1 | 16.9        | 0.0  | 0.0  | 34.5       | 95.0 | 20.5 | 81.6       | 31.8 | 6.5  |
| LOS by Move:                         | E           | A    | E    | B           | A    | A    | C          | F    | C    | F          | C    | A    |
| HCM2k95thQ:                          | 56          | 0    | 35   | 9           | 0    | 0    | 8          | 17   | 31   | 39         | 12   | 6    |

Note: Queue reported is the number of cars per lane.

BART

Level Of Service Computation Report  
2000 HCM Operations (Future Volume Alternative)  
AM - Cumulative With Project

Intersection #4038: 87/Taylor [Study Int 40]

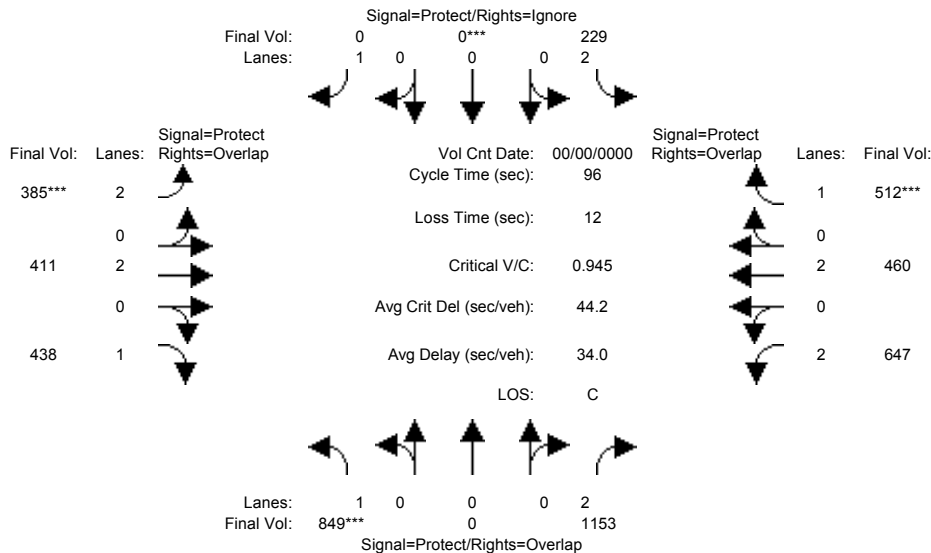

| Approach:                            | North Bound |      |      | South Bound |      |      | East Bound |      |      | West Bound |      |      |
|--------------------------------------|-------------|------|------|-------------|------|------|------------|------|------|------------|------|------|
| Movement:                            | L           | T    | R    | L           | T    | R    | L          | T    | R    | L          | T    | R    |
| Min. Green:                          | 7           | 0    | 10   | 7           | 0    | 10   | 7          | 10   | 10   | 7          | 10   | 10   |
| Y+R:                                 | 4.0         | 4.0  | 4.0  | 4.0         | 4.0  | 4.0  | 4.0        | 4.0  | 4.0  | 4.0        | 4.0  | 4.0  |
| Volume Module: >> Count Date: 0 0 << |             |      |      |             |      |      |            |      |      |            |      |      |
| Base Vol:                            | 849         | 0    | 1153 | 229         | 0    | 312  | 385        | 411  | 438  | 647        | 460  | 512  |
| Growth Adj:                          | 1.00        | 1.00 | 1.00 | 1.00        | 1.00 | 1.00 | 1.00       | 1.00 | 1.00 | 1.00       | 1.00 | 1.00 |
| Initial Bse:                         | 849         | 0    | 1153 | 229         | 0    | 312  | 385        | 411  | 438  | 647        | 460  | 512  |
| Added Vol:                           | 0           | 0    | 0    | 0           | 0    | 0    | 0          | 0    | 0    | 0          | 0    | 0    |
| PasserByVol:                         | 0           | 0    | 0    | 0           | 0    | 0    | 0          | 0    | 0    | 0          | 0    | 0    |
| Initial Fut:                         | 849         | 0    | 1153 | 229         | 0    | 312  | 385        | 411  | 438  | 647        | 460  | 512  |
| User Adj:                            | 1.00        | 1.00 | 1.00 | 1.00        | 1.00 | 0.00 | 1.00       | 1.00 | 1.00 | 1.00       | 1.00 | 1.00 |
| PHF Adj:                             | 1.00        | 1.00 | 1.00 | 1.00        | 1.00 | 0.00 | 1.00       | 1.00 | 1.00 | 1.00       | 1.00 | 1.00 |
| PHF Volume:                          | 849         | 0    | 1153 | 229         | 0    | 0    | 385        | 411  | 438  | 647        | 460  | 512  |
| Reduct Vol:                          | 0           | 0    | 0    | 0           | 0    | 0    | 0          | 0    | 0    | 0          | 0    | 0    |
| Reduced Vol:                         | 849         | 0    | 1153 | 229         | 0    | 0    | 385        | 411  | 438  | 647        | 460  | 512  |
| PCE Adj:                             | 1.00        | 1.00 | 1.00 | 1.00        | 1.00 | 0.00 | 1.00       | 1.00 | 1.00 | 1.00       | 1.00 | 1.00 |
| MLF Adj:                             | 1.00        | 1.00 | 1.00 | 1.00        | 1.00 | 0.00 | 1.00       | 1.00 | 1.00 | 1.00       | 1.00 | 1.00 |
| Final Volume:                        | 849         | 0    | 1153 | 229         | 0    | 0    | 385        | 411  | 438  | 647        | 460  | 512  |
| Saturation Flow Module:              |             |      |      |             |      |      |            |      |      |            |      |      |
| Sat/Lane:                            | 1900        | 1900 | 1900 | 1900        | 1900 | 1900 | 1900       | 1900 | 1900 | 1900       | 1900 | 1900 |
| Adjustment:                          | 0.92        | 1.00 | 0.83 | 0.83        | 1.00 | 0.92 | 0.83       | 1.00 | 0.92 | 0.83       | 1.00 | 0.92 |
| Lanes:                               | 1.00        | 0.00 | 2.00 | 2.00        | 0.00 | 1.00 | 2.00       | 2.00 | 1.00 | 2.00       | 2.00 | 1.00 |
| Final Sat.:                          | 1750        | 0    | 3150 | 3150        | 0    | 1750 | 3150       | 3800 | 1750 | 3150       | 3800 | 1750 |
| Capacity Analysis Module:            |             |      |      |             |      |      |            |      |      |            |      |      |
| Vol/Sat:                             | 0.49        | 0.00 | 0.37 | 0.07        | 0.00 | 0.00 | 0.12       | 0.11 | 0.25 | 0.21       | 0.12 | 0.29 |
| Crit Moves:                          | ****        |      |      | ****        |      |      | ****       |      |      | ****       |      |      |
| Green Time:                          | 49.3        | 0.0  | 56.6 | 15.4        | 0.0  | 0.0  | 12.4       | 12.0 | 61.3 | 22.7       | 22.3 | 37.7 |
| Volume/Cap:                          | 0.95        | 0.00 | 0.62 | 0.45        | 0.00 | 0.00 | 0.95       | 0.87 | 0.39 | 0.87       | 0.52 | 0.75 |
| Delay/Veh:                           | 40.2        | 0.0  | 13.4 | 37.2        | 0.0  | 0.0  | 72.3       | 56.7 | 8.6  | 45.7       | 32.7 | 29.5 |
| User DelAdj:                         | 1.00        | 1.00 | 1.00 | 1.00        | 1.00 | 1.00 | 1.00       | 1.00 | 1.00 | 1.00       | 1.00 | 1.00 |
| AdjDel/Veh:                          | 40.2        | 0.0  | 13.4 | 37.2        | 0.0  | 0.0  | 72.3       | 56.7 | 8.6  | 45.7       | 32.7 | 29.5 |
| LOS by Move:                         | D           | A    | B    | D           | A    | A    | E          | E    | A    | D          | C    | C    |
| HCM2k95thQ:                          | 50          | 0    | 24   | 8           | 0    | 0    | 14         | 12   | 12   | 25         | 12   | 27   |

Note: Queue reported is the number of cars per lane.

BART

Level Of Service Computation Report  
2000 HCM Operations (Future Volume Alternative)  
PM - Cumulative With Project

Intersection #4038: 87/Taylor [Study Int 40]

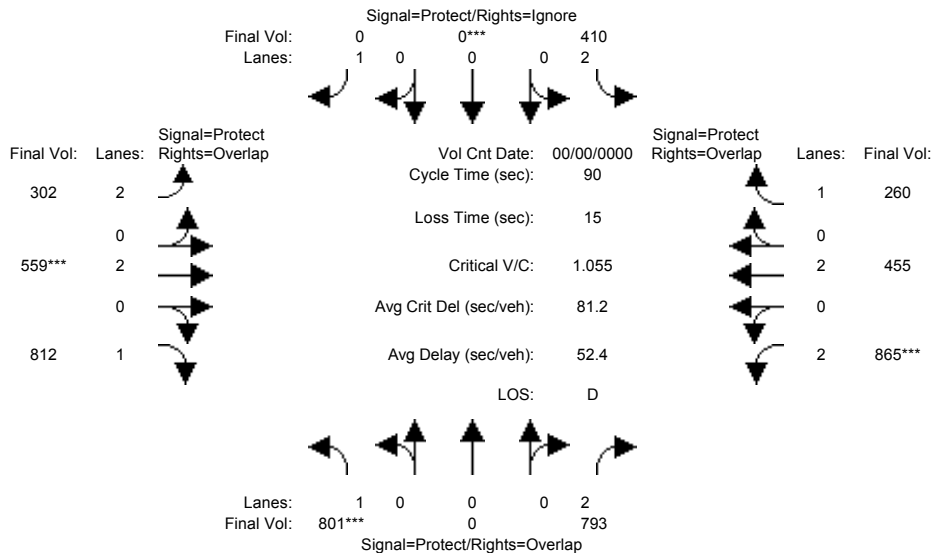

| Approach:                            | North Bound |      |      | South Bound |      |      | East Bound |      |      | West Bound |      |      |
|--------------------------------------|-------------|------|------|-------------|------|------|------------|------|------|------------|------|------|
| Movement:                            | L           | T    | R    | L           | T    | R    | L          | T    | R    | L          | T    | R    |
| Min. Green:                          | 7           | 0    | 10   | 7           | 0    | 10   | 7          | 10   | 10   | 7          | 10   | 10   |
| Y+R:                                 | 4.0         | 4.0  | 4.0  | 4.0         | 4.0  | 4.0  | 4.0        | 4.0  | 4.0  | 4.0        | 4.0  | 4.0  |
| Volume Module: >> Count Date: 0 0 << |             |      |      |             |      |      |            |      |      |            |      |      |
| Base Vol:                            | 801         | 0    | 793  | 410         | 0    | 517  | 302        | 559  | 812  | 865        | 455  | 260  |
| Growth Adj:                          | 1.00        | 1.00 | 1.00 | 1.00        | 1.00 | 1.00 | 1.00       | 1.00 | 1.00 | 1.00       | 1.00 | 1.00 |
| Initial Bse:                         | 801         | 0    | 793  | 410         | 0    | 517  | 302        | 559  | 812  | 865        | 455  | 260  |
| Added Vol:                           | 0           | 0    | 0    | 0           | 0    | 0    | 0          | 0    | 0    | 0          | 0    | 0    |
| PasserByVol:                         | 0           | 0    | 0    | 0           | 0    | 0    | 0          | 0    | 0    | 0          | 0    | 0    |
| Initial Fut:                         | 801         | 0    | 793  | 410         | 0    | 517  | 302        | 559  | 812  | 865        | 455  | 260  |
| User Adj:                            | 1.00        | 1.00 | 1.00 | 1.00        | 1.00 | 0.00 | 1.00       | 1.00 | 1.00 | 1.00       | 1.00 | 1.00 |
| PHF Adj:                             | 1.00        | 1.00 | 1.00 | 1.00        | 1.00 | 0.00 | 1.00       | 1.00 | 1.00 | 1.00       | 1.00 | 1.00 |
| PHF Volume:                          | 801         | 0    | 793  | 410         | 0    | 0    | 302        | 559  | 812  | 865        | 455  | 260  |
| Reduct Vol:                          | 0           | 0    | 0    | 0           | 0    | 0    | 0          | 0    | 0    | 0          | 0    | 0    |
| Reduced Vol:                         | 801         | 0    | 793  | 410         | 0    | 0    | 302        | 559  | 812  | 865        | 455  | 260  |
| PCE Adj:                             | 1.00        | 1.00 | 1.00 | 1.00        | 1.00 | 0.00 | 1.00       | 1.00 | 1.00 | 1.00       | 1.00 | 1.00 |
| MLF Adj:                             | 1.00        | 1.00 | 1.00 | 1.00        | 1.00 | 0.00 | 1.00       | 1.00 | 1.00 | 1.00       | 1.00 | 1.00 |
| Final Volume:                        | 801         | 0    | 793  | 410         | 0    | 0    | 302        | 559  | 812  | 865        | 455  | 260  |
| Saturation Flow Module:              |             |      |      |             |      |      |            |      |      |            |      |      |
| Sat/Lane:                            | 1900        | 1900 | 1900 | 1900        | 1900 | 1900 | 1900       | 1900 | 1900 | 1900       | 1900 | 1900 |
| Adjustment:                          | 0.92        | 1.00 | 0.83 | 0.83        | 1.00 | 0.92 | 0.83       | 1.00 | 0.92 | 0.83       | 1.00 | 0.92 |
| Lanes:                               | 1.00        | 0.00 | 2.00 | 2.00        | 0.00 | 1.00 | 2.00       | 2.00 | 1.00 | 2.00       | 2.00 | 1.00 |
| Final Sat.:                          | 1750        | 0    | 3150 | 3150        | 0    | 1750 | 3150       | 3800 | 1750 | 3150       | 3800 | 1750 |
| Capacity Analysis Module:            |             |      |      |             |      |      |            |      |      |            |      |      |
| Vol/Sat:                             | 0.46        | 0.00 | 0.25 | 0.13        | 0.00 | 0.00 | 0.10       | 0.15 | 0.46 | 0.27       | 0.12 | 0.15 |
| Crit Moves:                          | ****        |      |      | ****        |      |      | ****       |      | **** | ****       |      |      |
| Green Time:                          | 39.0        | 0.0  | 23.4 | 39.0        | 0.0  | 0.0  | 16.0       | 12.5 | 51.6 | 23.4       | 20.0 | 59.0 |
| Volume/Cap:                          | 1.06        | 0.00 | 0.97 | 0.30        | 0.00 | 0.00 | 0.54       | 1.06 | 0.81 | 1.06       | 0.54 | 0.23 |
| Delay/Veh:                           | 73.7        | 0.0  | 56.6 | 16.7        | 0.0  | 0.0  | 34.7       | 93.2 | 20.3 | 80.3       | 31.7 | 6.4  |
| User DelAdj:                         | 1.00        | 1.00 | 1.00 | 1.00        | 1.00 | 1.00 | 1.00       | 1.00 | 1.00 | 1.00       | 1.00 | 1.00 |
| AdjDel/Veh:                          | 73.7        | 0.0  | 56.6 | 16.7        | 0.0  | 0.0  | 34.7       | 93.2 | 20.3 | 80.3       | 31.7 | 6.4  |
| LOS by Move:                         | E           | A    | E    | B           | A    | A    | C          | F    | C    | F          | C    | A    |
| HCM2k95thQ:                          | 56          | 0    | 32   | 9           | 0    | 0    | 8          | 17   | 31   | 38         | 12   | 6    |

Note: Queue reported is the number of cars per lane.

BART

Level Of Service Computation Report  
 2000 HCM Operations (Future Volume Alternative)  
 AM - Cumulative No Project

Intersection #4047: COLEMAN/NEWHALL [Study Int 35]

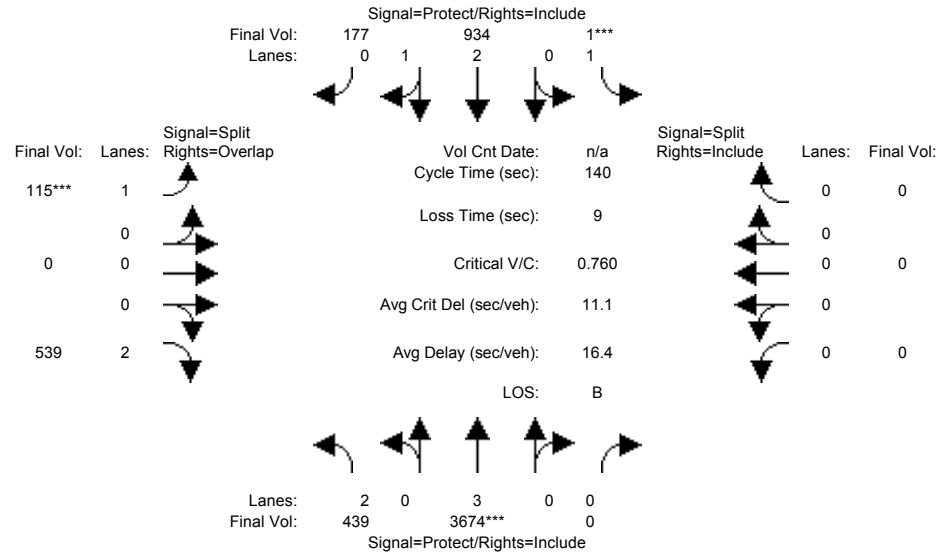

| Approach:                 | North Bound |      |      | South Bound |      |      | East Bound |      |      | West Bound |      |      |
|---------------------------|-------------|------|------|-------------|------|------|------------|------|------|------------|------|------|
| Movement:                 | L           | T    | R    | L           | T    | R    | L          | T    | R    | L          | T    | R    |
| Min. Green:               | 7           | 10   | 0    | 7           | 10   | 10   | 10         | 0    | 10   | 0          | 0    | 0    |
| Y+R:                      | 4.0         | 4.0  | 4.0  | 4.0         | 4.0  | 4.0  | 4.0        | 4.0  | 4.0  | 4.0        | 4.0  | 4.0  |
| Volume Module:            |             |      |      |             |      |      |            |      |      |            |      |      |
| Base Vol:                 | 439         | 3674 | 0    | 1           | 934  | 177  | 115        | 0    | 539  | 0          | 0    | 0    |
| Growth Adj:               | 1.00        | 1.00 | 1.00 | 1.00        | 1.00 | 1.00 | 1.00       | 1.00 | 1.00 | 1.00       | 1.00 | 1.00 |
| Initial Bse:              | 439         | 3674 | 0    | 1           | 934  | 177  | 115        | 0    | 539  | 0          | 0    | 0    |
| Added Vol:                | 0           | 0    | 0    | 0           | 0    | 0    | 0          | 0    | 0    | 0          | 0    | 0    |
| PasserByVol:              | 0           | 0    | 0    | 0           | 0    | 0    | 0          | 0    | 0    | 0          | 0    | 0    |
| Initial Fut:              | 439         | 3674 | 0    | 1           | 934  | 177  | 115        | 0    | 539  | 0          | 0    | 0    |
| User Adj:                 | 1.00        | 1.00 | 1.00 | 1.00        | 1.00 | 1.00 | 1.00       | 1.00 | 1.00 | 1.00       | 1.00 | 1.00 |
| PHF Adj:                  | 1.00        | 1.00 | 1.00 | 1.00        | 1.00 | 1.00 | 1.00       | 1.00 | 1.00 | 1.00       | 1.00 | 1.00 |
| PHF Volume:               | 439         | 3674 | 0    | 1           | 934  | 177  | 115        | 0    | 539  | 0          | 0    | 0    |
| Reduct Vol:               | 0           | 0    | 0    | 0           | 0    | 0    | 0          | 0    | 0    | 0          | 0    | 0    |
| Reduced Vol:              | 439         | 3674 | 0    | 1           | 934  | 177  | 115        | 0    | 539  | 0          | 0    | 0    |
| PCE Adj:                  | 1.00        | 1.00 | 1.00 | 1.00        | 1.00 | 1.00 | 1.00       | 1.00 | 1.00 | 1.00       | 1.00 | 1.00 |
| MLF Adj:                  | 1.00        | 1.00 | 1.00 | 1.00        | 1.00 | 1.00 | 1.00       | 1.00 | 1.00 | 1.00       | 1.00 | 1.00 |
| FinalVolume:              | 439         | 3674 | 0    | 1           | 934  | 177  | 115        | 0    | 539  | 0          | 0    | 0    |
| Saturation Flow Module:   |             |      |      |             |      |      |            |      |      |            |      |      |
| Sat/Lane:                 | 1900        | 1900 | 1900 | 1900        | 1900 | 1900 | 1900       | 1900 | 1900 | 1900       | 1900 | 1900 |
| Adjustment:               | 0.83        | 1.00 | 0.92 | 0.92        | 0.99 | 0.95 | 0.92       | 1.00 | 0.83 | 0.92       | 1.00 | 0.92 |
| Lanes:                    | 2.00        | 3.00 | 0.00 | 1.00        | 2.50 | 0.50 | 1.00       | 0.00 | 2.00 | 0.00       | 0.00 | 0.00 |
| Final Sat.:               | 3150        | 5700 | 0    | 1750        | 4707 | 892  | 1750       | 0    | 3150 | 0          | 0    | 0    |
| Capacity Analysis Module: |             |      |      |             |      |      |            |      |      |            |      |      |
| Vol/Sat:                  | 0.14        | 0.64 | 0.00 | 0.00        | 0.20 | 0.20 | 0.07       | 0.00 | 0.17 | 0.00       | 0.00 | 0.00 |
| Crit Moves:               | ****        | **** | **** | ****        | **** | **** | ****       | **** | **** | ****       | **** | **** |
| Green Time:               | 49.3        | 113  | 0.0  | 7.0         | 70.2 | 70.2 | 11.5       | 0.0  | 60.8 | 0.0        | 0.0  | 0.0  |
| Volume/Cap:               | 0.40        | 0.80 | 0.00 | 0.01        | 0.40 | 0.40 | 0.80       | 0.00 | 0.39 | 0.00       | 0.00 | 0.00 |
| Delay/Veh:                | 34.4        | 8.7  | 0.0  | 63.3        | 21.8 | 21.8 | 89.9       | 0.0  | 27.2 | 0.0        | 0.0  | 0.0  |
| User DelAdj:              | 1.00        | 1.00 | 1.00 | 1.00        | 1.00 | 1.00 | 1.00       | 1.00 | 1.00 | 1.00       | 1.00 | 1.00 |
| AdjDel/Veh:               | 34.4        | 8.7  | 0.0  | 63.3        | 21.8 | 21.8 | 89.9       | 0.0  | 27.2 | 0.0        | 0.0  | 0.0  |
| LOS by Move:              | C           | A    | A    | E           | C    | C    | F          | A    | C    | A          | A    | A    |
| HCM2k95thQ:               | 16          | 48   | 0    | 0           | 18   | 18   | 14         | 0    | 17   | 0          | 0    | 0    |

Note: Queue reported is the number of cars per lane.

BART

Level Of Service Computation Report  
 2000 HCM Operations (Future Volume Alternative)  
 PM - Cumulative No Project

Intersection #4047: COLEMAN/NEWHALL [Study Int 35]

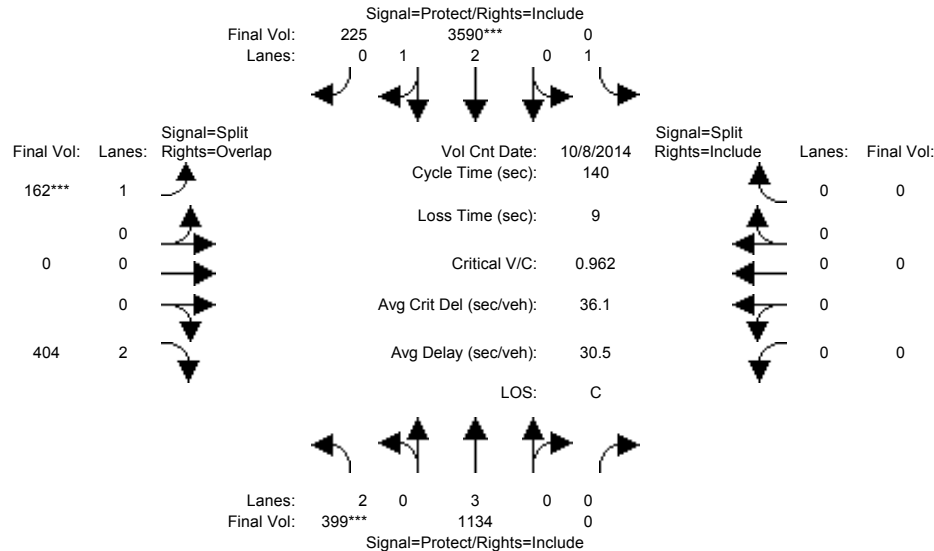

| Approach:                                   | North Bound |      |      | South Bound |      |      | East Bound |      |      | West Bound |      |      |
|---|-------------|------|------|-------------|------|------|------------|------|------|------------|------|------|
| Movement:                                   | L           | T    | R    | L           | T    | R    | L          | T    | R    | L          | T    | R    |
| Min. Green:                                 | 7           | 10   | 0    | 7           | 10   | 10   | 10         | 0    | 10   | 0          | 0    | 0    |
| Y+R:  | 4.0         | 4.0  | 4.0  | 4.0         | 4.0  | 4.0  | 4.0        | 4.0  | 4.0  | 4.0        | 4.0  | 4.0  |
| Volume Module: >> Count Date: 8 Oct 2014 << |             |      |      |             |      |      |            |      |      |            |      |      |
| Base Vol:                                   | 399         | 1134 | 0    | 0           | 3590 | 225  | 162        | 0    | 404  | 0          | 0    | 0    |
| Growth Adj:                                 | 1.00        | 1.00 | 1.00 | 1.00        | 1.00 | 1.00 | 1.00       | 1.00 | 1.00 | 1.00       | 1.00 | 1.00 |
| Initial Bse:                                | 399         | 1134 | 0    | 0           | 3590 | 225  | 162        | 0    | 404  | 0          | 0    | 0    |
| Added Vol:                                  | 0           | 0    | 0    | 0           | 0    | 0    | 0          | 0    | 0    | 0          | 0    | 0    |
| PasserByVol:                                | 0           | 0    | 0    | 0           | 0    | 0    | 0          | 0    | 0    | 0          | 0    | 0    |
| Initial Fut:                                | 399         | 1134 | 0    | 0           | 3590 | 225  | 162        | 0    | 404  | 0          | 0    | 0    |
| User Adj:                                   | 1.00        | 1.00 | 1.00 | 1.00        | 1.00 | 1.00 | 1.00       | 1.00 | 1.00 | 1.00       | 1.00 | 1.00 |
| PHF Adj:                                    | 1.00        | 1.00 | 1.00 | 1.00        | 1.00 | 1.00 | 1.00       | 1.00 | 1.00 | 1.00       | 1.00 | 1.00 |
| PHF Volume:                                 | 399         | 1134 | 0    | 0           | 3590 | 225  | 162        | 0    | 404  | 0          | 0    | 0    |
| Reduct Vol:                                 | 0           | 0    | 0    | 0           | 0    | 0    | 0          | 0    | 0    | 0          | 0    | 0    |
| Reduced Vol:                                | 399         | 1134 | 0    | 0           | 3590 | 225  | 162        | 0    | 404  | 0          | 0    | 0    |
| PCE Adj:                                    | 1.00        | 1.00 | 1.00 | 1.00        | 1.00 | 1.00 | 1.00       | 1.00 | 1.00 | 1.00       | 1.00 | 1.00 |
| MLF Adj:                                    | 1.00        | 1.00 | 1.00 | 1.00        | 1.00 | 1.00 | 1.00       | 1.00 | 1.00 | 1.00       | 1.00 | 1.00 |
| Final Volume:                               | 399         | 1134 | 0    | 0           | 3590 | 225  | 162        | 0    | 404  | 0          | 0    | 0    |
| Saturation Flow Module:                     |             |      |      |             |      |      |            |      |      |            |      |      |
| Sat/Lane:                                   | 1900        | 1900 | 1900 | 1900        | 1900 | 1900 | 1900       | 1900 | 1900 | 1900       | 1900 | 1900 |
| Adjustment:                                 | 0.83        | 1.00 | 0.92 | 0.92        | 0.98 | 0.95 | 0.92       | 1.00 | 0.83 | 0.92       | 1.00 | 0.92 |
| Lanes:                                      | 2.00        | 3.00 | 0.00 | 1.00        | 2.82 | 0.18 | 1.00       | 0.00 | 2.00 | 0.00       | 0.00 | 0.00 |
| Final Sat.:                                 | 3150        | 5700 | 0    | 1750        | 5269 | 330  | 1750       | 0    | 3150 | 0          | 0    | 0    |
| Capacity Analysis Module:                   |             |      |      |             |      |      |            |      |      |            |      |      |
| Vol/Sat:                                    | 0.13        | 0.20 | 0.00 | 0.00        | 0.68 | 0.68 | 0.09       | 0.00 | 0.13 | 0.00       | 0.00 | 0.00 |
| Crit Moves:                                 | ****        |      |      | ****        |      | **** | ****       |      |      |            |      |      |
| Green Time:                                 | 18.4        | 118  | 0.0  | 0.0         | 99.1 | 99.1 | 13.5       | 0.0  | 31.9 | 0.0        | 0.0  | 0.0  |
| Volume/Cap:                                 | 0.96        | 0.24 | 0.00 | 0.00        | 0.96 | 0.96 | 0.96       | 0.00 | 0.56 | 0.00       | 0.00 | 0.00 |
| Delay/Veh:                                  | 94.9        | 2.3  | 0.0  | 0.0         | 26.3 | 26.3 | 121.1      | 0.0  | 48.9 | 0.0        | 0.0  | 0.0  |
| User DelAdj:                                | 1.00        | 1.00 | 1.00 | 1.00        | 1.00 | 1.00 | 1.00       | 1.00 | 1.00 | 1.00       | 1.00 | 1.00 |
| AdjDel/Veh:                                 | 94.9        | 2.3  | 0.0  | 0.0         | 26.3 | 26.3 | 121.1      | 0.0  | 48.9 | 0.0        | 0.0  | 0.0  |
| LOS by Move:                                | F           | A    | A    | A           | C    | C    | F          | A    | D    | A          | A    | A    |
| HCM2k95thQ:                                 | 25          | 7    | 0    | 0           | 81   | 81   | 20         | 0    | 18   | 0          | 0    | 0    |

Note: Queue reported is the number of cars per lane.

BART

Level Of Service Computation Report  
 2000 HCM Operations (Future Volume Alternative)  
 AM - Cumulative With Project

Intersection #4047: COLEMAN/NEWHALL [Study Int 35]

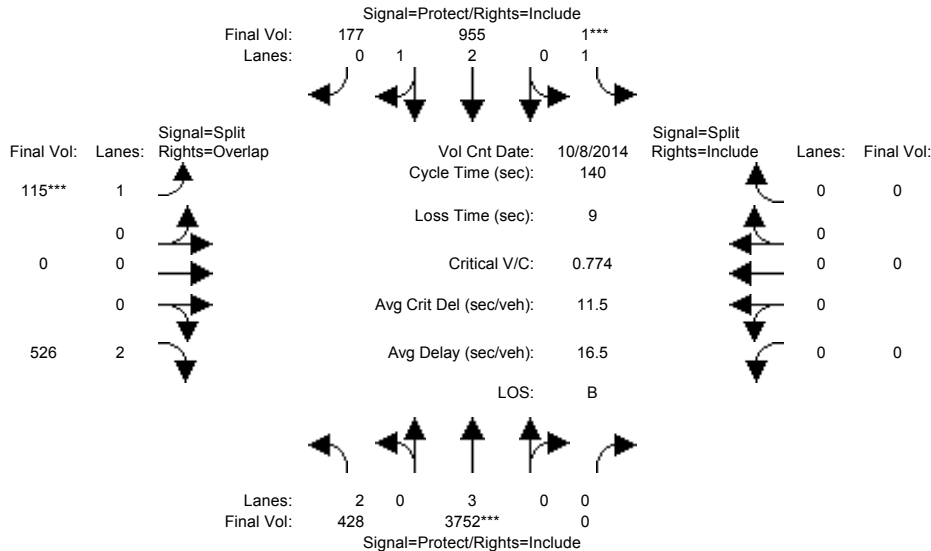

| Approach:                                   | North Bound |      |      | South Bound |      |      | East Bound |      |      | West Bound |      |      |
|---|-------------|------|------|-------------|------|------|------------|------|------|------------|------|------|
| Movement:                                   | L           | T    | R    | L           | T    | R    | L          | T    | R    | L          | T    | R    |
| Min. Green:                                 | 7           | 10   | 0    | 7           | 10   | 10   | 10         | 0    | 10   | 0          | 0    | 0    |
| Y+R:  | 4.0         | 4.0  | 4.0  | 4.0         | 4.0  | 4.0  | 4.0        | 4.0  | 4.0  | 4.0        | 4.0  | 4.0  |
| Volume Module: >> Count Date: 8 Oct 2014 << |             |      |      |             |      |      |            |      |      |            |      |      |
| Base Vol:                                   | 428         | 3752 | 0    | 1           | 955  | 177  | 115        | 0    | 526  | 0          | 0    | 0    |
| Growth Adj:                                 | 1.00        | 1.00 | 1.00 | 1.00        | 1.00 | 1.00 | 1.00       | 1.00 | 1.00 | 1.00       | 1.00 | 1.00 |
| Initial Bse:                                | 428         | 3752 | 0    | 1           | 955  | 177  | 115        | 0    | 526  | 0          | 0    | 0    |
| Added Vol:                                  | 0           | 0    | 0    | 0           | 0    | 0    | 0          | 0    | 0    | 0          | 0    | 0    |
| PasserByVol:                                | 0           | 0    | 0    | 0           | 0    | 0    | 0          | 0    | 0    | 0          | 0    | 0    |
| Initial Fut:                                | 428         | 3752 | 0    | 1           | 955  | 177  | 115        | 0    | 526  | 0          | 0    | 0    |
| User Adj:                                   | 1.00        | 1.00 | 1.00 | 1.00        | 1.00 | 1.00 | 1.00       | 1.00 | 1.00 | 1.00       | 1.00 | 1.00 |
| PHF Adj:                                    | 1.00        | 1.00 | 1.00 | 1.00        | 1.00 | 1.00 | 1.00       | 1.00 | 1.00 | 1.00       | 1.00 | 1.00 |
| PHF Volume:                                 | 428         | 3752 | 0    | 1           | 955  | 177  | 115        | 0    | 526  | 0          | 0    | 0    |
| Reduct Vol:                                 | 0           | 0    | 0    | 0           | 0    | 0    | 0          | 0    | 0    | 0          | 0    | 0    |
| Reduced Vol:                                | 428         | 3752 | 0    | 1           | 955  | 177  | 115        | 0    | 526  | 0          | 0    | 0    |
| PCE Adj:                                    | 1.00        | 1.00 | 1.00 | 1.00        | 1.00 | 1.00 | 1.00       | 1.00 | 1.00 | 1.00       | 1.00 | 1.00 |
| MLF Adj:                                    | 1.00        | 1.00 | 1.00 | 1.00        | 1.00 | 1.00 | 1.00       | 1.00 | 1.00 | 1.00       | 1.00 | 1.00 |
| Final Volume:                               | 428         | 3752 | 0    | 1           | 955  | 177  | 115        | 0    | 526  | 0          | 0    | 0    |
| Saturation Flow Module:                     |             |      |      |             |      |      |            |      |      |            |      |      |
| Sat/Lane:                                   | 1900        | 1900 | 1900 | 1900        | 1900 | 1900 | 1900       | 1900 | 1900 | 1900       | 1900 | 1900 |
| Adjustment:                                 | 0.83        | 1.00 | 0.92 | 0.92        | 0.99 | 0.95 | 0.92       | 1.00 | 0.83 | 0.92       | 1.00 | 0.92 |
| Lanes:                                      | 2.00        | 3.00 | 0.00 | 1.00        | 2.51 | 0.49 | 1.00       | 0.00 | 2.00 | 0.00       | 0.00 | 0.00 |
| Final Sat.:                                 | 3150        | 5700 | 0    | 1750        | 4723 | 875  | 1750       | 0    | 3150 | 0          | 0    | 0    |
| Capacity Analysis Module:                   |             |      |      |             |      |      |            |      |      |            |      |      |
| Vol/Sat:                                    | 0.14        | 0.66 | 0.00 | 0.00        | 0.20 | 0.20 | 0.07       | 0.00 | 0.17 | 0.00       | 0.00 | 0.00 |
| Crit Moves:                                 | ****        | **** | **** | ****        | **** | **** | ****       | **** | **** | ****       | **** | **** |
| Green Time:                                 | 48.1        | 113  | 0.0  | 7.0         | 71.6 | 71.6 | 11.3       | 0.0  | 59.4 | 0.0        | 0.0  | 0.0  |
| Volume/Cap:                                 | 0.40        | 0.82 | 0.00 | 0.01        | 0.40 | 0.40 | 0.82       | 0.00 | 0.39 | 0.00       | 0.00 | 0.00 |
| Delay/Veh:                                  | 35.1        | 9.0  | 0.0  | 63.3        | 21.0 | 21.0 | 93.1       | 0.0  | 28.1 | 0.0        | 0.0  | 0.0  |
| User DelAdj:                                | 1.00        | 1.00 | 1.00 | 1.00        | 1.00 | 1.00 | 1.00       | 1.00 | 1.00 | 1.00       | 1.00 | 1.00 |
| AdjDel/Veh:                                 | 35.1        | 9.0  | 0.0  | 63.3        | 21.0 | 21.0 | 93.1       | 0.0  | 28.1 | 0.0        | 0.0  | 0.0  |
| LOS by Move:                                | D           | A    | A    | E           | C    | C    | F          | A    | C    | A          | A    | A    |
| HCM2k95thQ:                                 | 16          | 51   | 0    | 0           | 18   | 18   | 14         | 0    | 17   | 0          | 0    | 0    |

Note: Queue reported is the number of cars per lane.

BART

Level Of Service Computation Report  
2000 HCM Operations (Future Volume Alternative)  
PM - Cumulative With Project

Intersection #4047: COLEMAN/NEWHALL [Study Int 35]

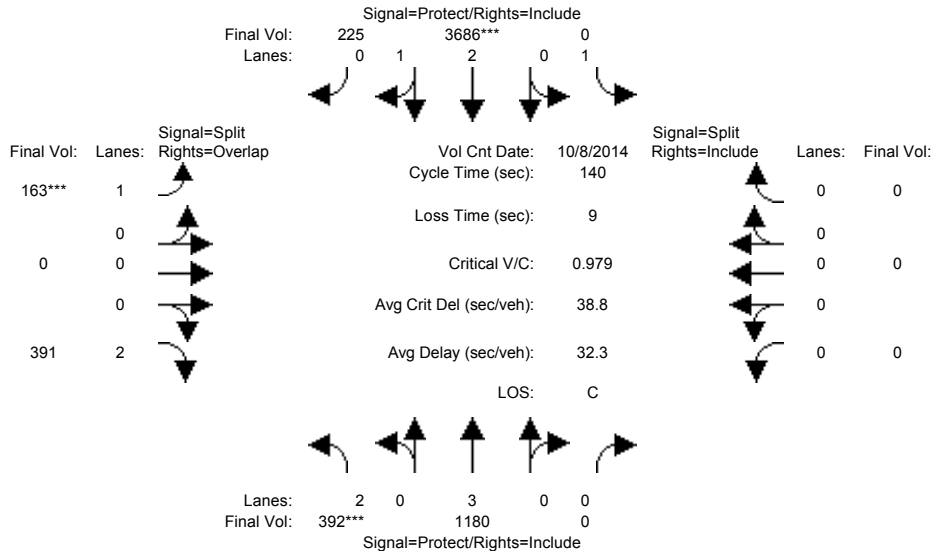

| Approach:                                   | North Bound |      |      | South Bound |      |      | East Bound |      |      | West Bound |      |      |
|---|-------------|------|------|-------------|------|------|------------|------|------|------------|------|------|
| Movement:                                   | L           | T    | R    | L           | T    | R    | L          | T    | R    | L          | T    | R    |
| Min. Green:                                 | 7           | 10   | 0    | 7           | 10   | 10   | 10         | 0    | 10   | 0          | 0    | 0    |
| Y+R:  | 4.0         | 4.0  | 4.0  | 4.0         | 4.0  | 4.0  | 4.0        | 4.0  | 4.0  | 4.0        | 4.0  | 4.0  |
| Volume Module: >> Count Date: 8 Oct 2014 << |             |      |      |             |      |      |            |      |      |            |      |      |
| Base Vol:                                   | 392         | 1180 | 0    | 0           | 3686 | 225  | 163        | 0    | 391  | 0          | 0    | 0    |
| Growth Adj:                                 | 1.00        | 1.00 | 1.00 | 1.00        | 1.00 | 1.00 | 1.00       | 1.00 | 1.00 | 1.00       | 1.00 | 1.00 |
| Initial Bse:                                | 392         | 1180 | 0    | 0           | 3686 | 225  | 163        | 0    | 391  | 0          | 0    | 0    |
| Added Vol:                                  | 0           | 0    | 0    | 0           | 0    | 0    | 0          | 0    | 0    | 0          | 0    | 0    |
| PasserByVol:                                | 0           | 0    | 0    | 0           | 0    | 0    | 0          | 0    | 0    | 0          | 0    | 0    |
| Initial Fut:                                | 392         | 1180 | 0    | 0           | 3686 | 225  | 163        | 0    | 391  | 0          | 0    | 0    |
| User Adj:                                   | 1.00        | 1.00 | 1.00 | 1.00        | 1.00 | 1.00 | 1.00       | 1.00 | 1.00 | 1.00       | 1.00 | 1.00 |
| PHF Adj:                                    | 1.00        | 1.00 | 1.00 | 1.00        | 1.00 | 1.00 | 1.00       | 1.00 | 1.00 | 1.00       | 1.00 | 1.00 |
| PHF Volume:                                 | 392         | 1180 | 0    | 0           | 3686 | 225  | 163        | 0    | 391  | 0          | 0    | 0    |
| Reduct Vol:                                 | 0           | 0    | 0    | 0           | 0    | 0    | 0          | 0    | 0    | 0          | 0    | 0    |
| Reduced Vol:                                | 392         | 1180 | 0    | 0           | 3686 | 225  | 163        | 0    | 391  | 0          | 0    | 0    |
| PCE Adj:                                    | 1.00        | 1.00 | 1.00 | 1.00        | 1.00 | 1.00 | 1.00       | 1.00 | 1.00 | 1.00       | 1.00 | 1.00 |
| MLF Adj:                                    | 1.00        | 1.00 | 1.00 | 1.00        | 1.00 | 1.00 | 1.00       | 1.00 | 1.00 | 1.00       | 1.00 | 1.00 |
| Final Volume:                               | 392         | 1180 | 0    | 0           | 3686 | 225  | 163        | 0    | 391  | 0          | 0    | 0    |
| Saturation Flow Module:                     |             |      |      |             |      |      |            |      |      |            |      |      |
| Sat/Lane:                                   | 1900        | 1900 | 1900 | 1900        | 1900 | 1900 | 1900       | 1900 | 1900 | 1900       | 1900 | 1900 |
| Adjustment:                                 | 0.83        | 1.00 | 0.92 | 0.92        | 0.98 | 0.95 | 0.92       | 1.00 | 0.83 | 0.92       | 1.00 | 0.92 |
| Lanes:                                      | 2.00        | 3.00 | 0.00 | 1.00        | 2.82 | 0.18 | 1.00       | 0.00 | 2.00 | 0.00       | 0.00 | 0.00 |
| Final Sat.:                                 | 3150        | 5700 | 0    | 1750        | 5277 | 322  | 1750       | 0    | 3150 | 0          | 0    | 0    |
| Capacity Analysis Module:                   |             |      |      |             |      |      |            |      |      |            |      |      |
| Vol/Sat:                                    | 0.12        | 0.21 | 0.00 | 0.00        | 0.70 | 0.70 | 0.09       | 0.00 | 0.12 | 0.00       | 0.00 | 0.00 |
| Crit Moves:                                 | ****        | **** | **** | ****        | **** | **** | ****       | **** | **** | ****       | **** | **** |
| Green Time:                                 | 17.8        | 118  | 0.0  | 0.0         | 99.9 | 99.9 | 13.3       | 0.0  | 31.1 | 0.0        | 0.0  | 0.0  |
| Volume/Cap:                                 | 0.98        | 0.25 | 0.00 | 0.00        | 0.98 | 0.98 | 0.98       | 0.00 | 0.56 | 0.00       | 0.00 | 0.00 |
| Delay/Veh:                                  | 100.2       | 2.3  | 0.0  | 0.0         | 29.0 | 29.0 | 126.5      | 0.0  | 49.4 | 0.0        | 0.0  | 0.0  |
| User DelAdj:                                | 1.00        | 1.00 | 1.00 | 1.00        | 1.00 | 1.00 | 1.00       | 1.00 | 1.00 | 1.00       | 1.00 | 1.00 |
| AdjDel/Veh:                                 | 100.2       | 2.3  | 0.0  | 0.0         | 29.0 | 29.0 | 126.5      | 0.0  | 49.4 | 0.0        | 0.0  | 0.0  |
| LOS by Move:                                | F           | A    | A    | A           | C    | C    | F          | A    | D    | A          | A    | A    |
| HCM2k95thQ:                                 | 25          | 7    | 0    | 0           | 86   | 86   | 21         | 0    | 17   | 0          | 0    | 0    |

Note: Queue reported is the number of cars per lane.

BART

Level Of Service Computation Report  
2000 HCM Operations (Future Volume Alternative)  
AM - Cumulative No Project

Intersection #4069: 101/Trimble [Study Int 62]

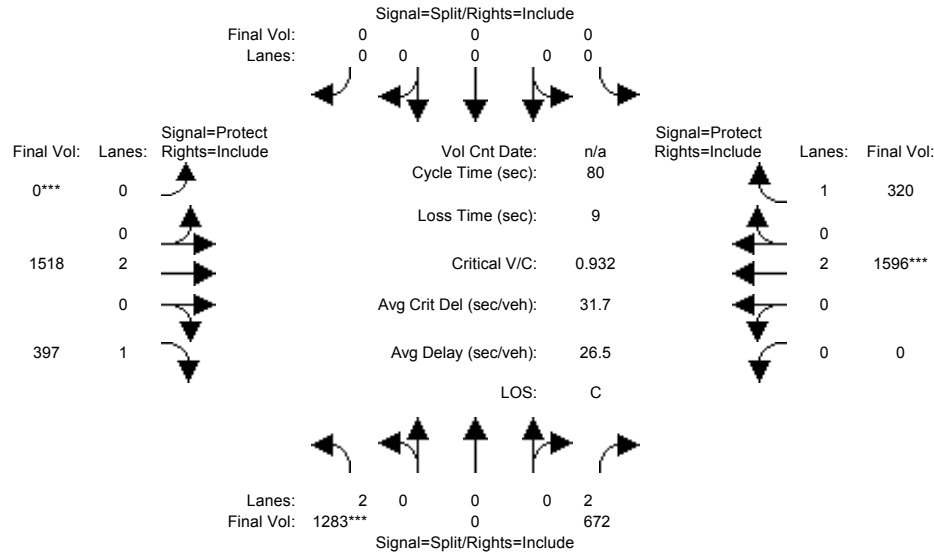

| Approach:                 | North Bound |      |      | South Bound |      |      | East Bound |      |      | West Bound |      |      |
|---------------------------|-------------|------|------|-------------|------|------|------------|------|------|------------|------|------|
| Movement:                 | L           | T    | R    | L           | T    | R    | L          | T    | R    | L          | T    | R    |
| Min. Green:               | 10          | 0    | 10   | 0           | 0    | 0    | 0          | 10   | 10   | 0          | 10   | 10   |
| Y+R:                      | 4.0         | 4.0  | 4.0  | 4.0         | 4.0  | 4.0  | 4.0        | 4.0  | 4.0  | 4.0        | 4.0  | 4.0  |
| Volume Module:            |             |      |      |             |      |      |            |      |      |            |      |      |
| Base Vol:                 | 1283        | 0    | 672  | 0           | 0    | 0    | 0          | 1518 | 397  | 0          | 1596 | 320  |
| Growth Adj:               | 1.00        | 1.00 | 1.00 | 1.00        | 1.00 | 1.00 | 1.00       | 1.00 | 1.00 | 1.00       | 1.00 | 1.00 |
| Initial Bse:              | 1283        | 0    | 672  | 0           | 0    | 0    | 0          | 1518 | 397  | 0          | 1596 | 320  |
| Added Vol:                | 0           | 0    | 0    | 0           | 0    | 0    | 0          | 0    | 0    | 0          | 0    | 0    |
| PasserByVol:              | 0           | 0    | 0    | 0           | 0    | 0    | 0          | 0    | 0    | 0          | 0    | 0    |
| Initial Fut:              | 1283        | 0    | 672  | 0           | 0    | 0    | 0          | 1518 | 397  | 0          | 1596 | 320  |
| User Adj:                 | 1.00        | 1.00 | 1.00 | 1.00        | 1.00 | 1.00 | 1.00       | 1.00 | 1.00 | 1.00       | 1.00 | 1.00 |
| PHF Adj:                  | 1.00        | 1.00 | 1.00 | 1.00        | 1.00 | 1.00 | 1.00       | 1.00 | 1.00 | 1.00       | 1.00 | 1.00 |
| PHF Volume:               | 1283        | 0    | 672  | 0           | 0    | 0    | 0          | 1518 | 397  | 0          | 1596 | 320  |
| Reduct Vol:               | 0           | 0    | 0    | 0           | 0    | 0    | 0          | 0    | 0    | 0          | 0    | 0    |
| Reduced Vol:              | 1283        | 0    | 672  | 0           | 0    | 0    | 0          | 1518 | 397  | 0          | 1596 | 320  |
| PCE Adj:                  | 1.00        | 1.00 | 1.00 | 1.00        | 1.00 | 1.00 | 1.00       | 1.00 | 1.00 | 1.00       | 1.00 | 1.00 |
| MLF Adj:                  | 1.00        | 1.00 | 1.00 | 1.00        | 1.00 | 1.00 | 1.00       | 1.00 | 1.00 | 1.00       | 1.00 | 1.00 |
| FinalVolume:              | 1283        | 0    | 672  | 0           | 0    | 0    | 0          | 1518 | 397  | 0          | 1596 | 320  |
| Saturation Flow Module:   |             |      |      |             |      |      |            |      |      |            |      |      |
| Sat/Lane:                 | 1900        | 1900 | 1900 | 1900        | 1900 | 1900 | 1900       | 1900 | 1900 | 1900       | 1900 | 1900 |
| Adjustment:               | 0.83        | 1.00 | 0.83 | 0.92        | 1.00 | 0.92 | 0.92       | 1.00 | 0.92 | 0.92       | 1.00 | 0.92 |
| Lanes:                    | 2.00        | 0.00 | 2.00 | 0.00        | 0.00 | 0.00 | 0.00       | 2.00 | 1.00 | 0.00       | 2.00 | 1.00 |
| Final Sat.:               | 3150        | 0    | 3150 | 0           | 0    | 0    | 0          | 3800 | 1750 | 0          | 3800 | 1750 |
| Capacity Analysis Module: |             |      |      |             |      |      |            |      |      |            |      |      |
| Vol/Sat:                  | 0.41        | 0.00 | 0.21 | 0.00        | 0.00 | 0.00 | 0.00       | 0.40 | 0.23 | 0.00       | 0.42 | 0.18 |
| Crit Moves:               | ****        |      |      |             |      |      | ****       |      |      | ****       |      |      |
| Green Time:               | 35.0        | 0.0  | 35.0 | 0.0         | 0.0  | 0.0  | 0.0        | 36.0 | 36.0 | 0.0        | 36.0 | 36.0 |
| Volume/Cap:               | 0.93        | 0.00 | 0.49 | 0.00        | 0.00 | 0.00 | 0.00       | 0.89 | 0.50 | 0.00       | 0.93 | 0.41 |
| Delay/Veh:                | 33.0        | 0.0  | 16.4 | 0.0         | 0.0  | 0.0  | 0.0        | 26.1 | 16.1 | 0.0        | 30.6 | 15.1 |
| User DelAdj:              | 1.00        | 1.00 | 1.00 | 1.00        | 1.00 | 1.00 | 1.00       | 1.00 | 1.00 | 1.00       | 1.00 | 1.00 |
| AdjDel/Veh:               | 33.0        | 0.0  | 16.4 | 0.0         | 0.0  | 0.0  | 0.0        | 26.1 | 16.1 | 0.0        | 30.6 | 15.1 |
| LOS by Move:              | C           | A    | B    | A           | A    | A    | A          | C    | B    | A          | C    | B    |
| HCM2k95thQ:               | 39          | 0    | 14   | 0           | 0    | 0    | 0          | 32   | 14   | 0          | 40   | 11   |

Note: Queue reported is the number of cars per lane.



BART

Level Of Service Computation Report  
2000 HCM Operations (Future Volume Alternative)  
PM - Cumulative No Project

Intersection #4069: 101/Trimble [Study Int 62]

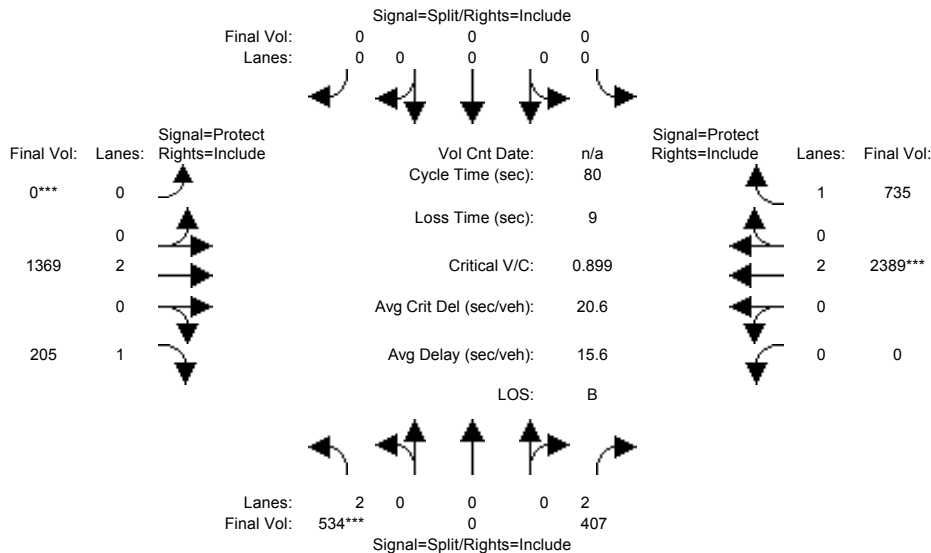

| Approach:                 | North Bound |      |      | South Bound |      |      | East Bound |      |      | West Bound |      |      |
|---------------------------|-------------|------|------|-------------|------|------|------------|------|------|------------|------|------|
| Movement:                 | L           | T    | R    | L           | T    | R    | L          | T    | R    | L          | T    | R    |
| Min. Green:               | 10          | 0    | 10   | 0           | 0    | 0    | 0          | 10   | 10   | 0          | 10   | 10   |
| Y+R:                      | 4.0         | 4.0  | 4.0  | 4.0         | 4.0  | 4.0  | 4.0        | 4.0  | 4.0  | 4.0        | 4.0  | 4.0  |
| Volume Module:            |             |      |      |             |      |      |            |      |      |            |      |      |
| Base Vol:                 | 534         | 0    | 407  | 0           | 0    | 0    | 0          | 1369 | 205  | 0          | 2389 | 735  |
| Growth Adj:               | 1.00        | 1.00 | 1.00 | 1.00        | 1.00 | 1.00 | 1.00       | 1.00 | 1.00 | 1.00       | 1.00 | 1.00 |
| Initial Bse:              | 534         | 0    | 407  | 0           | 0    | 0    | 0          | 1369 | 205  | 0          | 2389 | 735  |
| Added Vol:                | 0           | 0    | 0    | 0           | 0    | 0    | 0          | 0    | 0    | 0          | 0    | 0    |
| PasserByVol:              | 0           | 0    | 0    | 0           | 0    | 0    | 0          | 0    | 0    | 0          | 0    | 0    |
| Initial Fut:              | 534         | 0    | 407  | 0           | 0    | 0    | 0          | 1369 | 205  | 0          | 2389 | 735  |
| User Adj:                 | 1.00        | 1.00 | 1.00 | 1.00        | 1.00 | 1.00 | 1.00       | 1.00 | 1.00 | 1.00       | 1.00 | 1.00 |
| PHF Adj:                  | 1.00        | 1.00 | 1.00 | 1.00        | 1.00 | 1.00 | 1.00       | 1.00 | 1.00 | 1.00       | 1.00 | 1.00 |
| PHF Volume:               | 534         | 0    | 407  | 0           | 0    | 0    | 0          | 1369 | 205  | 0          | 2389 | 735  |
| Reduct Vol:               | 0           | 0    | 0    | 0           | 0    | 0    | 0          | 0    | 0    | 0          | 0    | 0    |
| Reduced Vol:              | 534         | 0    | 407  | 0           | 0    | 0    | 0          | 1369 | 205  | 0          | 2389 | 735  |
| PCE Adj:                  | 1.00        | 1.00 | 1.00 | 1.00        | 1.00 | 1.00 | 1.00       | 1.00 | 1.00 | 1.00       | 1.00 | 1.00 |
| MLF Adj:                  | 1.00        | 1.00 | 1.00 | 1.00        | 1.00 | 1.00 | 1.00       | 1.00 | 1.00 | 1.00       | 1.00 | 1.00 |
| FinalVolume:              | 534         | 0    | 407  | 0           | 0    | 0    | 0          | 1369 | 205  | 0          | 2389 | 735  |
| Saturation Flow Module:   |             |      |      |             |      |      |            |      |      |            |      |      |
| Sat/Lane:                 | 1900        | 1900 | 1900 | 1900        | 1900 | 1900 | 1900       | 1900 | 1900 | 1900       | 1900 | 1900 |
| Adjustment:               | 0.83        | 1.00 | 0.83 | 0.92        | 1.00 | 0.92 | 0.92       | 1.00 | 0.92 | 0.92       | 1.00 | 0.92 |
| Lanes:                    | 2.00        | 0.00 | 2.00 | 0.00        | 0.00 | 0.00 | 0.00       | 2.00 | 1.00 | 0.00       | 2.00 | 1.00 |
| Final Sat.:               | 3150        | 0    | 3150 | 0           | 0    | 0    | 0          | 3800 | 1750 | 0          | 3800 | 1750 |
| Capacity Analysis Module: |             |      |      |             |      |      |            |      |      |            |      |      |
| Vol/Sat:                  | 0.17        | 0.00 | 0.13 | 0.00        | 0.00 | 0.00 | 0.00       | 0.36 | 0.12 | 0.00       | 0.63 | 0.42 |
| Crit Moves:               | ****        |      |      |             |      |      | ****       |      |      | ****       |      |      |
| Green Time:               | 15.1        | 0.0  | 15.1 | 0.0         | 0.0  | 0.0  | 0.0        | 55.9 | 55.9 | 0.0        | 55.9 | 55.9 |
| Volume/Cap:               | 0.90        | 0.00 | 0.69 | 0.00        | 0.00 | 0.00 | 0.00       | 0.52 | 0.17 | 0.00       | 0.90 | 0.60 |
| Delay/Veh:                | 48.3        | 0.0  | 33.6 | 0.0         | 0.0  | 0.0  | 0.0        | 5.8  | 4.2  | 0.0        | 14.4 | 7.1  |
| User DelAdj:              | 1.00        | 1.00 | 1.00 | 1.00        | 1.00 | 1.00 | 1.00       | 1.00 | 1.00 | 1.00       | 1.00 | 1.00 |
| AdjDel/Veh:               | 48.3        | 0.0  | 33.6 | 0.0         | 0.0  | 0.0  | 0.0        | 5.8  | 4.2  | 0.0        | 14.4 | 7.1  |
| LOS by Move:              | D           | A    | C    | A           | A    | A    | A          | A    | A    | A          | B    | A    |
| HCM2k95thQ:               | 21          | 0    | 13   | 0           | 0    | 0    | 0          | 15   | 4    | 0          | 45   | 20   |

Note: Queue reported is the number of cars per lane.

BART

Level Of Service Computation Report  
 2000 HCM Operations (Future Volume Alternative)  
 AM - Cumulative With Project

Intersection #4069: 101/Trimble [Study Int 62]

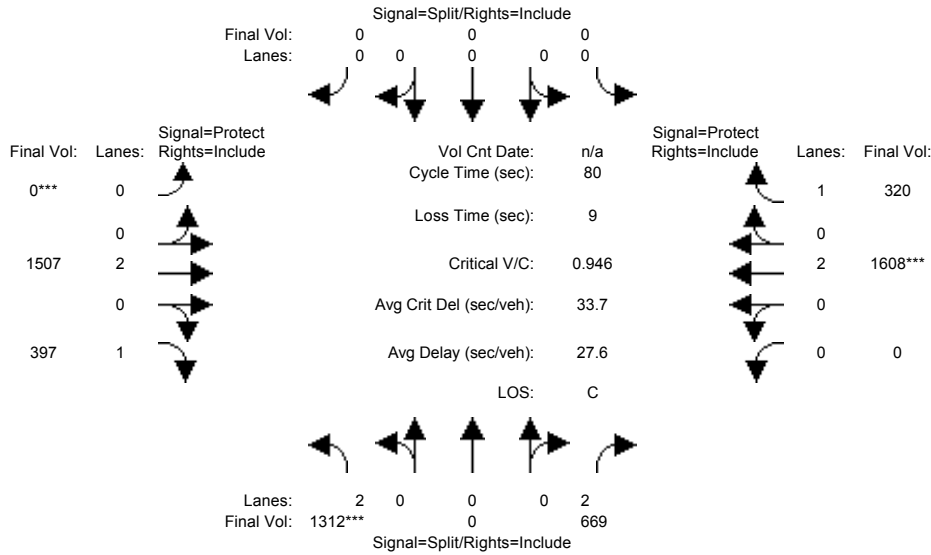

| Approach:                 | North Bound |      |      | South Bound |      |      | East Bound |      |      | West Bound |      |      |
|---------------------------|-------------|------|------|-------------|------|------|------------|------|------|------------|------|------|
| Movement:                 | L           | T    | R    | L           | T    | R    | L          | T    | R    | L          | T    | R    |
| Min. Green:               | 10          | 0    | 10   | 0           | 0    | 0    | 0          | 10   | 10   | 0          | 10   | 10   |
| Y+R:                      | 4.0         | 4.0  | 4.0  | 4.0         | 4.0  | 4.0  | 4.0        | 4.0  | 4.0  | 4.0        | 4.0  | 4.0  |
| Volume Module:            |             |      |      |             |      |      |            |      |      |            |      |      |
| Base Vol:                 | 1312        | 0    | 669  | 0           | 0    | 0    | 0          | 1507 | 397  | 0          | 1608 | 320  |
| Growth Adj:               | 1.00        | 1.00 | 1.00 | 1.00        | 1.00 | 1.00 | 1.00       | 1.00 | 1.00 | 1.00       | 1.00 | 1.00 |
| Initial Bse:              | 1312        | 0    | 669  | 0           | 0    | 0    | 0          | 1507 | 397  | 0          | 1608 | 320  |
| Added Vol:                | 0           | 0    | 0    | 0           | 0    | 0    | 0          | 0    | 0    | 0          | 0    | 0    |
| PasserByVol:              | 0           | 0    | 0    | 0           | 0    | 0    | 0          | 0    | 0    | 0          | 0    | 0    |
| Initial Fut:              | 1312        | 0    | 669  | 0           | 0    | 0    | 0          | 1507 | 397  | 0          | 1608 | 320  |
| User Adj:                 | 1.00        | 1.00 | 1.00 | 1.00        | 1.00 | 1.00 | 1.00       | 1.00 | 1.00 | 1.00       | 1.00 | 1.00 |
| PHF Adj:                  | 1.00        | 1.00 | 1.00 | 1.00        | 1.00 | 1.00 | 1.00       | 1.00 | 1.00 | 1.00       | 1.00 | 1.00 |
| PHF Volume:               | 1312        | 0    | 669  | 0           | 0    | 0    | 0          | 1507 | 397  | 0          | 1608 | 320  |
| Reduct Vol:               | 0           | 0    | 0    | 0           | 0    | 0    | 0          | 0    | 0    | 0          | 0    | 0    |
| Reduced Vol:              | 1312        | 0    | 669  | 0           | 0    | 0    | 0          | 1507 | 397  | 0          | 1608 | 320  |
| PCE Adj:                  | 1.00        | 1.00 | 1.00 | 1.00        | 1.00 | 1.00 | 1.00       | 1.00 | 1.00 | 1.00       | 1.00 | 1.00 |
| MLF Adj:                  | 1.00        | 1.00 | 1.00 | 1.00        | 1.00 | 1.00 | 1.00       | 1.00 | 1.00 | 1.00       | 1.00 | 1.00 |
| FinalVolume:              | 1312        | 0    | 669  | 0           | 0    | 0    | 0          | 1507 | 397  | 0          | 1608 | 320  |
| Saturation Flow Module:   |             |      |      |             |      |      |            |      |      |            |      |      |
| Sat/Lane:                 | 1900        | 1900 | 1900 | 1900        | 1900 | 1900 | 1900       | 1900 | 1900 | 1900       | 1900 | 1900 |
| Adjustment:               | 0.83        | 1.00 | 0.83 | 0.92        | 1.00 | 0.92 | 0.92       | 1.00 | 0.92 | 0.92       | 1.00 | 0.92 |
| Lanes:                    | 2.00        | 0.00 | 2.00 | 0.00        | 0.00 | 0.00 | 0.00       | 2.00 | 1.00 | 0.00       | 2.00 | 1.00 |
| Final Sat.:               | 3150        | 0    | 3150 | 0           | 0    | 0    | 0          | 3800 | 1750 | 0          | 3800 | 1750 |
| Capacity Analysis Module: |             |      |      |             |      |      |            |      |      |            |      |      |
| Vol/Sat:                  | 0.42        | 0.00 | 0.21 | 0.00        | 0.00 | 0.00 | 0.00       | 0.40 | 0.23 | 0.00       | 0.42 | 0.18 |
| Crit Moves:               | ****        |      |      |             |      |      | ****       |      |      | ****       |      |      |
| Green Time:               | 35.2        | 0.0  | 35.2 | 0.0         | 0.0  | 0.0  | 0.0        | 35.8 | 35.8 | 0.0        | 35.8 | 35.8 |
| Volume/Cap:               | 0.95        | 0.00 | 0.48 | 0.00        | 0.00 | 0.00 | 0.00       | 0.89 | 0.51 | 0.00       | 0.95 | 0.41 |
| Delay/Veh:                | 34.9        | 0.0  | 16.2 | 0.0         | 0.0  | 0.0  | 0.0        | 26.3 | 16.4 | 0.0        | 32.7 | 15.3 |
| User DelAdj:              | 1.00        | 1.00 | 1.00 | 1.00        | 1.00 | 1.00 | 1.00       | 1.00 | 1.00 | 1.00       | 1.00 | 1.00 |
| AdjDel/Veh:               | 34.9        | 0.0  | 16.2 | 0.0         | 0.0  | 0.0  | 0.0        | 26.3 | 16.4 | 0.0        | 32.7 | 15.3 |
| LOS by Move:              | C           | A    | B    | A           | A    | A    | A          | C    | B    | A          | C    | B    |
| HCM2k95thQ:               | 40          | 0    | 14   | 0           | 0    | 0    | 0          | 32   | 14   | 0          | 41   | 11   |

Note: Queue reported is the number of cars per lane.

BART

Level Of Service Computation Report  
 2000 HCM Operations (Future Volume Alternative)  
 PM - Cumulative With Project

Intersection #4069: 101/Trimble [Study Int 62]

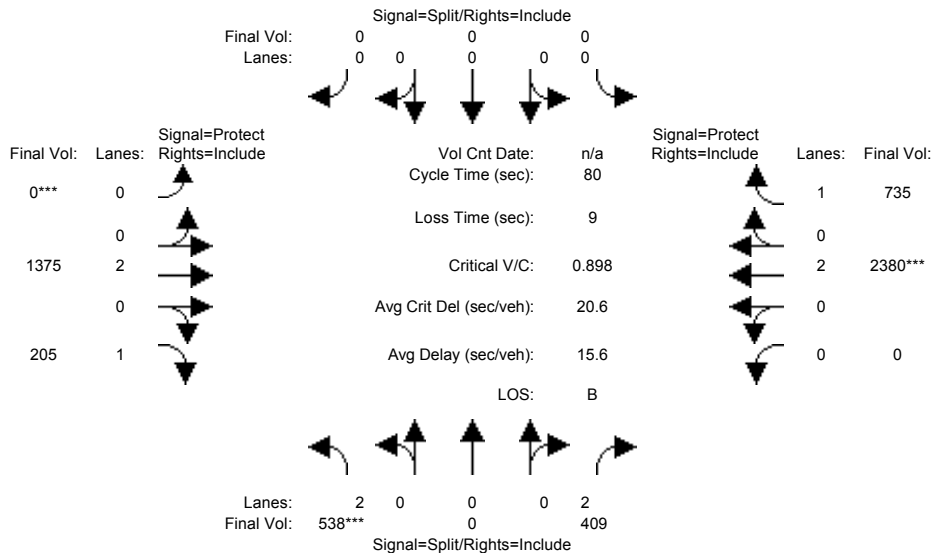

| Approach:                 | North Bound |      |      | South Bound |      |      | East Bound |      |      | West Bound |      |      |
|---------------------------|-------------|------|------|-------------|------|------|------------|------|------|------------|------|------|
| Movement:                 | L           | T    | R    | L           | T    | R    | L          | T    | R    | L          | T    | R    |
| Min. Green:               | 10          | 0    | 10   | 0           | 0    | 0    | 0          | 10   | 10   | 0          | 10   | 10   |
| Y+R:                      | 4.0         | 4.0  | 4.0  | 4.0         | 4.0  | 4.0  | 4.0        | 4.0  | 4.0  | 4.0        | 4.0  | 4.0  |
| Volume Module:            |             |      |      |             |      |      |            |      |      |            |      |      |
| Base Vol:                 | 538         | 0    | 409  | 0           | 0    | 0    | 0          | 1375 | 205  | 0          | 2380 | 735  |
| Growth Adj:               | 1.00        | 1.00 | 1.00 | 1.00        | 1.00 | 1.00 | 1.00       | 1.00 | 1.00 | 1.00       | 1.00 | 1.00 |
| Initial Bse:              | 538         | 0    | 409  | 0           | 0    | 0    | 0          | 1375 | 205  | 0          | 2380 | 735  |
| Added Vol:                | 0           | 0    | 0    | 0           | 0    | 0    | 0          | 0    | 0    | 0          | 0    | 0    |
| PasserByVol:              | 0           | 0    | 0    | 0           | 0    | 0    | 0          | 0    | 0    | 0          | 0    | 0    |
| Initial Fut:              | 538         | 0    | 409  | 0           | 0    | 0    | 0          | 1375 | 205  | 0          | 2380 | 735  |
| User Adj:                 | 1.00        | 1.00 | 1.00 | 1.00        | 1.00 | 1.00 | 1.00       | 1.00 | 1.00 | 1.00       | 1.00 | 1.00 |
| PHF Adj:                  | 1.00        | 1.00 | 1.00 | 1.00        | 1.00 | 1.00 | 1.00       | 1.00 | 1.00 | 1.00       | 1.00 | 1.00 |
| PHF Volume:               | 538         | 0    | 409  | 0           | 0    | 0    | 0          | 1375 | 205  | 0          | 2380 | 735  |
| Reduct Vol:               | 0           | 0    | 0    | 0           | 0    | 0    | 0          | 0    | 0    | 0          | 0    | 0    |
| Reduced Vol:              | 538         | 0    | 409  | 0           | 0    | 0    | 0          | 1375 | 205  | 0          | 2380 | 735  |
| PCE Adj:                  | 1.00        | 1.00 | 1.00 | 1.00        | 1.00 | 1.00 | 1.00       | 1.00 | 1.00 | 1.00       | 1.00 | 1.00 |
| MLF Adj:                  | 1.00        | 1.00 | 1.00 | 1.00        | 1.00 | 1.00 | 1.00       | 1.00 | 1.00 | 1.00       | 1.00 | 1.00 |
| FinalVolume:              | 538         | 0    | 409  | 0           | 0    | 0    | 0          | 1375 | 205  | 0          | 2380 | 735  |
| Saturation Flow Module:   |             |      |      |             |      |      |            |      |      |            |      |      |
| Sat/Lane:                 | 1900        | 1900 | 1900 | 1900        | 1900 | 1900 | 1900       | 1900 | 1900 | 1900       | 1900 | 1900 |
| Adjustment:               | 0.83        | 1.00 | 0.83 | 0.92        | 1.00 | 0.92 | 0.92       | 1.00 | 0.92 | 0.92       | 1.00 | 0.92 |
| Lanes:                    | 2.00        | 0.00 | 2.00 | 0.00        | 0.00 | 0.00 | 0.00       | 2.00 | 1.00 | 0.00       | 2.00 | 1.00 |
| Final Sat.:               | 3150        | 0    | 3150 | 0           | 0    | 0    | 0          | 3800 | 1750 | 0          | 3800 | 1750 |
| Capacity Analysis Module: |             |      |      |             |      |      |            |      |      |            |      |      |
| Vol/Sat:                  | 0.17        | 0.00 | 0.13 | 0.00        | 0.00 | 0.00 | 0.00       | 0.36 | 0.12 | 0.00       | 0.63 | 0.42 |
| Crit Moves:               | ****        |      |      |             |      |      | ****       |      |      | ****       |      |      |
| Green Time:               | 15.2        | 0.0  | 15.2 | 0.0         | 0.0  | 0.0  | 0.0        | 55.8 | 55.8 | 0.0        | 55.8 | 55.8 |
| Volume/Cap:               | 0.90        | 0.00 | 0.68 | 0.00        | 0.00 | 0.00 | 0.00       | 0.52 | 0.17 | 0.00       | 0.90 | 0.60 |
| Delay/Veh:                | 48.0        | 0.0  | 33.4 | 0.0         | 0.0  | 0.0  | 0.0        | 5.9  | 4.2  | 0.0        | 14.4 | 7.2  |
| User DelAdj:              | 1.00        | 1.00 | 1.00 | 1.00        | 1.00 | 1.00 | 1.00       | 1.00 | 1.00 | 1.00       | 1.00 | 1.00 |
| AdjDel/Veh:               | 48.0        | 0.0  | 33.4 | 0.0         | 0.0  | 0.0  | 0.0        | 5.9  | 4.2  | 0.0        | 14.4 | 7.2  |
| LOS by Move:              | D           | A    | C    | A           | A    | A    | A          | A    | A    | A          | B    | A    |
| HCM2k95thQ:               | 21          | 0    | 13   | 0           | 0    | 0    | 0          | 15   | 4    | 0          | 45   | 20   |

Note: Queue reported is the number of cars per lane.

BART

Level Of Service Computation Report  
 2000 HCM Operations (Future Volume Alternative)  
 AM - Cumulative No Project

Intersection #5332: CENTRAL EXPWY/SCOTT BLVD [Study Int 28]

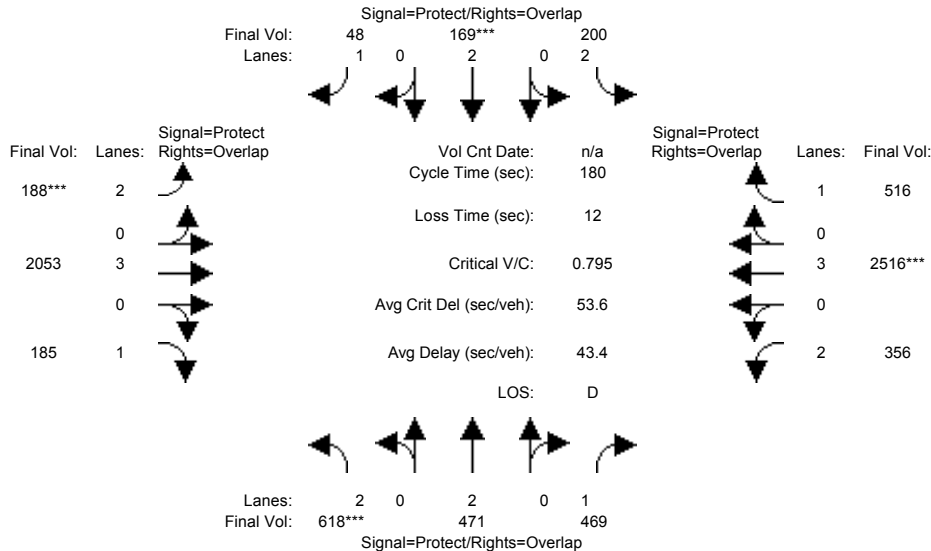

| Approach:                 | North Bound |      |      | South Bound |      |      | East Bound |      |       | West Bound |      |       |
|---------------------------|-------------|------|------|-------------|------|------|------------|------|-------|------------|------|-------|
| Movement:                 | L           | T    | R    | L           | T    | R    | L          | T    | R     | L          | T    | R     |
| Min. Green:               | 14          | 10   | 10   | 14          | 10   | 10   | 14         | 10   | 10    | 14         | 90   | 10    |
| Y+R:                      | 4.0         | 4.0  | 4.0  | 4.0         | 4.0  | 4.0  | 4.0        | 4.0  | 4.0   | 4.0        | 4.0  | 4.0   |
| Volume Module:            |             |      |      |             |      |      |            |      |       |            |      |       |
| Base Vol:                 | 618         | 471  | 469  | 200         | 169  | 48   | 188        | 2053 | 185   | 356        | 2516 | 516   |
| Growth Adj:               | 1.00        | 1.00 | 1.00 | 1.00        | 1.00 | 1.00 | 1.00       | 1.00 | 1.00  | 1.00       | 1.00 | 1.00  |
| Initial Bse:              | 618         | 471  | 469  | 200         | 169  | 48   | 188        | 2053 | 185   | 356        | 2516 | 516   |
| Added Vol:                | 0           | 0    | 0    | 0           | 0    | 0    | 0          | 0    | 0     | 0          | 0    | 0     |
| PasserByVol:              | 0           | 0    | 0    | 0           | 0    | 0    | 0          | 0    | 0     | 0          | 0    | 0     |
| Initial Fut:              | 618         | 471  | 469  | 200         | 169  | 48   | 188        | 2053 | 185   | 356        | 2516 | 516   |
| User Adj:                 | 1.00        | 1.00 | 1.00 | 1.00        | 1.00 | 1.00 | 1.00       | 1.00 | 1.00  | 1.00       | 1.00 | 1.00  |
| PHF Adj:                  | 1.00        | 1.00 | 1.00 | 1.00        | 1.00 | 1.00 | 1.00       | 1.00 | 1.00  | 1.00       | 1.00 | 1.00  |
| PHF Volume:               | 618         | 471  | 469  | 200         | 169  | 48   | 188        | 2053 | 185   | 356        | 2516 | 516   |
| Reduct Vol:               | 0           | 0    | 0    | 0           | 0    | 0    | 0          | 0    | 0     | 0          | 0    | 0     |
| Reduced Vol:              | 618         | 471  | 469  | 200         | 169  | 48   | 188        | 2053 | 185   | 356        | 2516 | 516   |
| PCE Adj:                  | 1.00        | 1.00 | 1.00 | 1.00        | 1.00 | 1.00 | 1.00       | 1.00 | 1.00  | 1.00       | 1.00 | 1.00  |
| MLF Adj:                  | 1.00        | 1.00 | 1.00 | 1.00        | 1.00 | 1.00 | 1.00       | 1.00 | 1.00  | 1.00       | 1.00 | 1.00  |
| Final Volume:             | 618         | 471  | 469  | 200         | 169  | 48   | 188        | 2053 | 185   | 356        | 2516 | 516   |
| Saturation Flow Module:   |             |      |      |             |      |      |            |      |       |            |      |       |
| Sat/Lane:                 | 1900        | 1900 | 1900 | 1900        | 1900 | 1900 | 1900       | 1900 | 1900  | 1900       | 1900 | 1900  |
| Adjustment:               | 0.83        | 1.00 | 0.92 | 0.83        | 1.00 | 0.92 | 0.83       | 1.00 | 0.92  | 0.83       | 1.00 | 0.92  |
| Lanes:                    | 2.00        | 2.00 | 1.00 | 2.00        | 2.00 | 1.00 | 2.00       | 3.00 | 1.00  | 2.00       | 3.00 | 1.00  |
| Final Sat.:               | 3150        | 3800 | 1750 | 3150        | 3800 | 1750 | 3150       | 5700 | 1750  | 3150       | 5700 | 1750  |
| Capacity Analysis Module: |             |      |      |             |      |      |            |      |       |            |      |       |
| Vol/Sat:                  | 0.20        | 0.12 | 0.27 | 0.06        | 0.04 | 0.03 | 0.06       | 0.36 | 0.11  | 0.11       | 0.44 | 0.29  |
| Crit Moves:               | ****        |      |      | ****        |      |      | ****       |      |       | ****       |      |       |
| Green Time:               | 44.3        | 36.2 | 63.3 | 18.2        | 10.0 | 24.0 | 14.0       | 86.5 | 130.8 | 27.1       | 99.7 | 117.8 |
| Volume/Cap:               | 0.80        | 0.62 | 0.76 | 0.63        | 0.80 | 0.21 | 0.77       | 0.75 | 0.15  | 0.75       | 0.80 | 0.45  |
| Delay/Veh:                | 69.4        | 67.1 | 57.2 | 81.7        | 103  | 69.9 | 90.4       | 15.7 | 0.1   | 79.7       | 43.7 | 23.4  |
| User DelAdj:              | 1.00        | 1.00 | 1.00 | 1.00        | 1.00 | 1.00 | 1.00       | 1.00 | 1.00  | 1.00       | 1.00 | 1.00  |
| AdjDel/Veh:               | 69.4        | 67.1 | 57.2 | 81.7        | 103  | 69.9 | 90.4       | 15.7 | 0.1   | 79.7       | 43.7 | 23.4  |
| LOS by Move:              | E           | E    | E    | F           | F    | E    | F          | B    | A     | E          | D    | C     |
| HCM2k95thQ:               | 34          | 22   | 43   | 12          | 10   | 5    | 15         | 34   | 0     | 20         | 61   | 34    |

Note: Queue reported is the number of cars per lane.

BART

Level Of Service Computation Report  
2000 HCM Operations (Future Volume Alternative)  
PM - Cumulative No Project

Intersection #5332: CENTRAL EXPWY/SCOTT BLVD [Study Int 28]

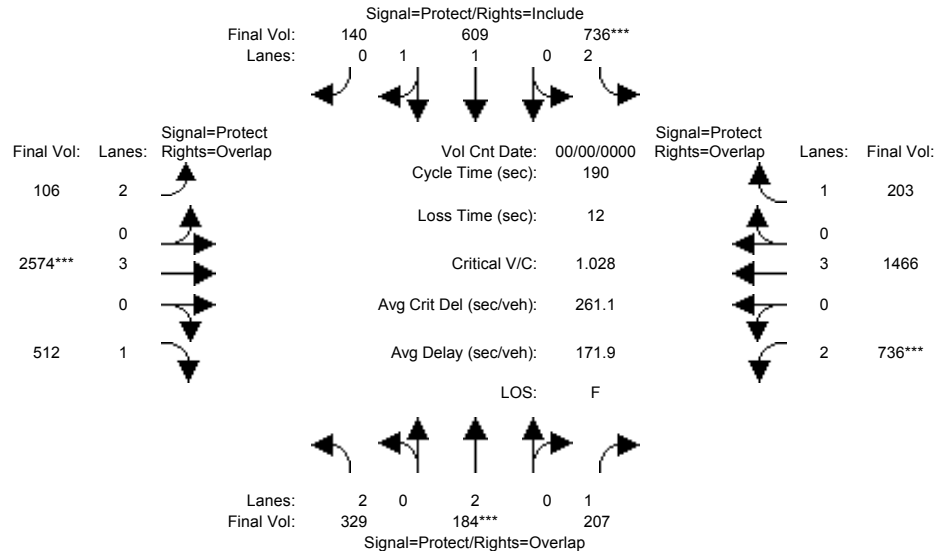

| Approach:  | North Bound |      |      | South Bound |      |       | East Bound |      |       | West Bound |      |       |
|--|-------------|------|------|-------------|------|-------|------------|------|-------|------------|------|-------|
| Movement:  | L           | T    | R    | L           | T    | R     | L          | T    | R     | L          | T    | R     |
| Min. Green:                                      | 28          | 42   | 42   | 20          | 34   | 34    | 19         | 105  | 105   | 23         | 109  | 109   |
| Y+R:   | 4.0         | 4.0  | 4.0  | 4.0         | 4.0  | 4.0   | 4.0        | 4.0  | 4.0   | 4.0        | 4.0  | 4.0   |
| Volume Module: >> Count Date: 0 0 << 5:00-6:00PM |             |      |      |             |      |       |            |      |       |            |      |       |
| Base Vol:  | 329         | 184  | 207  | 736         | 609  | 140   | 106        | 2574 | 512   | 736        | 1466 | 203   |
| Growth Adj:                                      | 1.00        | 1.00 | 1.00 | 1.00        | 1.00 | 1.00  | 1.00       | 1.00 | 1.00  | 1.00       | 1.00 | 1.00  |
| Initial Bse:                                     | 329         | 184  | 207  | 736         | 609  | 140   | 106        | 2574 | 512   | 736        | 1466 | 203   |
| Added Vol:                                       | 0           | 0    | 0    | 0           | 0    | 0     | 0          | 0    | 0     | 0          | 0    | 0     |
| PasserByVol:                                     | 0           | 0    | 0    | 0           | 0    | 0     | 0          | 0    | 0     | 0          | 0    | 0     |
| Initial Fut:                                     | 329         | 184  | 207  | 736         | 609  | 140   | 106        | 2574 | 512   | 736        | 1466 | 203   |
| User Adj:  | 1.00        | 1.00 | 1.00 | 1.00        | 1.00 | 1.00  | 1.00       | 1.00 | 1.00  | 1.00       | 1.00 | 1.00  |
| PHF Adj:   | 1.00        | 1.00 | 1.00 | 1.00        | 1.00 | 1.00  | 1.00       | 1.00 | 1.00  | 1.00       | 1.00 | 1.00  |
| PHF Volume:                                      | 329         | 184  | 207  | 736         | 609  | 140   | 106        | 2574 | 512   | 736        | 1466 | 203   |
| Reduct Vol:                                      | 0           | 0    | 0    | 0           | 0    | 0     | 0          | 0    | 0     | 0          | 0    | 0     |
| Reduced Vol:                                     | 329         | 184  | 207  | 736         | 609  | 140   | 106        | 2574 | 512   | 736        | 1466 | 203   |
| PCE Adj:   | 1.00        | 1.00 | 1.00 | 1.00        | 1.00 | 1.00  | 1.00       | 1.00 | 1.00  | 1.00       | 1.00 | 1.00  |
| MLF Adj:   | 1.00        | 1.00 | 1.00 | 1.00        | 1.00 | 1.00  | 1.00       | 1.00 | 1.00  | 1.00       | 1.00 | 1.00  |
| Final Volume:                                    | 329         | 184  | 207  | 736         | 609  | 140   | 106        | 2574 | 512   | 736        | 1466 | 203   |
| Saturation Flow Module:                          |             |      |      |             |      |       |            |      |       |            |      |       |
| Sat/Lane:  | 1900        | 1900 | 1900 | 1900        | 1900 | 1900  | 1900       | 1900 | 1900  | 1900       | 1900 | 1900  |
| Adjustment:                                      | 0.83        | 1.00 | 0.92 | 0.83        | 0.98 | 0.95  | 0.83       | 1.00 | 0.92  | 0.83       | 1.00 | 0.92  |
| Lanes:   | 2.00        | 2.00 | 1.00 | 2.00        | 1.62 | 0.38  | 2.00       | 3.00 | 1.00  | 2.00       | 3.00 | 1.00  |
| Final Sat.:                                      | 3150        | 3800 | 1750 | 3150        | 3008 | 691   | 3150       | 5700 | 1750  | 3150       | 5700 | 1750  |
| Capacity Analysis Module:                        |             |      |      |             |      |       |            |      |       |            |      |       |
| Vol/Sat:   | 0.10        | 0.05 | 0.12 | 0.23        | 0.20 | 0.20  | 0.03       | 0.45 | 0.29  | 0.23       | 0.26 | 0.12  |
| Crit Moves:                                      | ****        | **** | **** | ****        | **** | ****  | ****       | **** | ****  | ****       | **** | ****  |
| Green Time:                                      | 26.3        | 39.5 | 61.1 | 18.8        | 32.0 | 32.0  | 17.9       | 98.8 | 125.1 | 21.6       | 103  | 121.3 |
| Volume/Cap:                                      | 0.75        | 0.23 | 0.37 | 2.36        | 1.20 | 1.20  | 0.36       | 0.87 | 0.44  | 2.05       | 0.48 | 0.18  |
| Delay/Veh:                                       | 91.0        | 66.7 | 53.1 | 712.8       | 190  | 190.1 | 86.5       | 56.8 | 25.7  | 572.5      | 20.3 | 7.1   |
| User DelAdj:                                     | 1.00        | 1.00 | 1.00 | 1.00        | 1.00 | 1.00  | 1.00       | 1.00 | 1.00  | 1.00       | 1.00 | 1.00  |
| AdjDel/Veh:                                      | 91.0        | 66.7 | 53.1 | 712.8       | 190  | 190.1 | 86.5       | 56.8 | 25.7  | 572.5      | 20.3 | 7.1   |
| LOS by Move:                                     | F           | E    | D    | F           | F    | F     | F          | E    | C     | F          | C    | A     |
| HCM2k95thQ:                                      | 22          | 9    | 19   | 88          | 52   | 52    | 8          | 77   | 38    | 83         | 23   | 5     |

Note: Queue reported is the number of cars per lane.

BART

Level Of Service Computation Report  
2000 HCM Operations (Future Volume Alternative)  
AM - Cumulative With Project

Intersection #5332: CENTRAL EXPWY/SCOTT BLVD [Study Int 28]

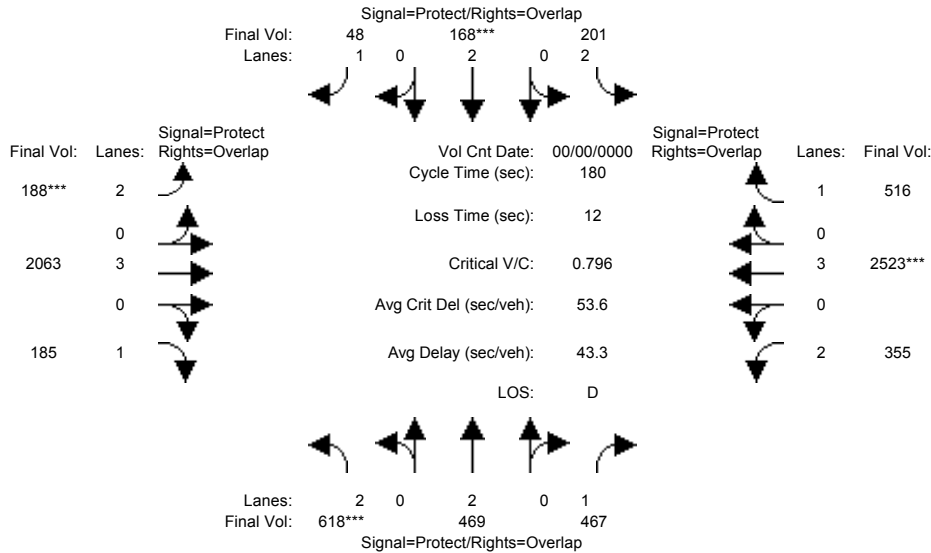

| Approach:  | North Bound |      |      | South Bound |      |      | East Bound |      |       | West Bound |      |       |
|--|-------------|------|------|-------------|------|------|------------|------|-------|------------|------|-------|
| Movement:  | L           | T    | R    | L           | T    | R    | L          | T    | R     | L          | T    | R     |
| Min. Green:                                      | 14          | 10   | 10   | 14          | 10   | 10   | 14         | 10   | 10    | 14         | 90   | 10    |
| Y+R:   | 4.0         | 4.0  | 4.0  | 4.0         | 4.0  | 4.0  | 4.0        | 4.0  | 4.0   | 4.0        | 4.0  | 4.0   |
| Volume Module: >> Count Date: 0 0 << 5:00-6:00PM |             |      |      |             |      |      |            |      |       |            |      |       |
| Base Vol:  | 618         | 469  | 467  | 201         | 168  | 48   | 188        | 2063 | 185   | 355        | 2523 | 516   |
| Growth Adj:                                      | 1.00        | 1.00 | 1.00 | 1.00        | 1.00 | 1.00 | 1.00       | 1.00 | 1.00  | 1.00       | 1.00 | 1.00  |
| Initial Bse:                                     | 618         | 469  | 467  | 201         | 168  | 48   | 188        | 2063 | 185   | 355        | 2523 | 516   |
| Added Vol:                                       | 0           | 0    | 0    | 0           | 0    | 0    | 0          | 0    | 0     | 0          | 0    | 0     |
| PasserByVol:                                     | 0           | 0    | 0    | 0           | 0    | 0    | 0          | 0    | 0     | 0          | 0    | 0     |
| Initial Fut:                                     | 618         | 469  | 467  | 201         | 168  | 48   | 188        | 2063 | 185   | 355        | 2523 | 516   |
| User Adj:  | 1.00        | 1.00 | 1.00 | 1.00        | 1.00 | 1.00 | 1.00       | 1.00 | 1.00  | 1.00       | 1.00 | 1.00  |
| PHF Adj:   | 1.00        | 1.00 | 1.00 | 1.00        | 1.00 | 1.00 | 1.00       | 1.00 | 1.00  | 1.00       | 1.00 | 1.00  |
| PHF Volume:                                      | 618         | 469  | 467  | 201         | 168  | 48   | 188        | 2063 | 185   | 355        | 2523 | 516   |
| Reduct Vol:                                      | 0           | 0    | 0    | 0           | 0    | 0    | 0          | 0    | 0     | 0          | 0    | 0     |
| Reduced Vol:                                     | 618         | 469  | 467  | 201         | 168  | 48   | 188        | 2063 | 185   | 355        | 2523 | 516   |
| PCE Adj:   | 1.00        | 1.00 | 1.00 | 1.00        | 1.00 | 1.00 | 1.00       | 1.00 | 1.00  | 1.00       | 1.00 | 1.00  |
| MLF Adj:   | 1.00        | 1.00 | 1.00 | 1.00        | 1.00 | 1.00 | 1.00       | 1.00 | 1.00  | 1.00       | 1.00 | 1.00  |
| Final Volume:                                    | 618         | 469  | 467  | 201         | 168  | 48   | 188        | 2063 | 185   | 355        | 2523 | 516   |
| Saturation Flow Module:                          |             |      |      |             |      |      |            |      |       |            |      |       |
| Sat/Lane:  | 1900        | 1900 | 1900 | 1900        | 1900 | 1900 | 1900       | 1900 | 1900  | 1900       | 1900 | 1900  |
| Adjustment:                                      | 0.83        | 1.00 | 0.92 | 0.83        | 1.00 | 0.92 | 0.83       | 1.00 | 0.92  | 0.83       | 1.00 | 0.92  |
| Lanes:   | 2.00        | 2.00 | 1.00 | 2.00        | 2.00 | 1.00 | 2.00       | 3.00 | 1.00  | 2.00       | 3.00 | 1.00  |
| Final Sat.:                                      | 3150        | 3800 | 1750 | 3150        | 3800 | 1750 | 3150       | 5700 | 1750  | 3150       | 5700 | 1750  |
| Capacity Analysis Module:                        |             |      |      |             |      |      |            |      |       |            |      |       |
| Vol/Sat:   | 0.20        | 0.12 | 0.27 | 0.06        | 0.04 | 0.03 | 0.06       | 0.36 | 0.11  | 0.11       | 0.44 | 0.29  |
| Crit Moves:                                      | ****        |      |      | ****        |      |      | ****       |      |       | ****       |      |       |
| Green Time:                                      | 44.2        | 36.0 | 63.1 | 18.2        | 10.0 | 24.0 | 14.0       | 86.8 | 131.0 | 27.0       | 99.8 | 118.0 |
| Volume/Cap:                                      | 0.80        | 0.62 | 0.76 | 0.63        | 0.80 | 0.21 | 0.77       | 0.75 | 0.15  | 0.75       | 0.80 | 0.45  |
| Delay/Veh:                                       | 69.6        | 67.2 | 57.4 | 81.8        | 103  | 69.9 | 90.4       | 15.6 | 0.1   | 79.9       | 43.7 | 23.3  |
| User DelAdj:                                     | 1.00        | 1.00 | 1.00 | 1.00        | 1.00 | 1.00 | 1.00       | 1.00 | 1.00  | 1.00       | 1.00 | 1.00  |
| AdjDel/Veh:                                      | 69.6        | 67.2 | 57.4 | 81.8        | 103  | 69.9 | 90.4       | 15.6 | 0.1   | 79.9       | 43.7 | 23.3  |
| LOS by Move:                                     | E           | E    | E    | F           | F    | E    | F          | B    | A     | E          | D    | C     |
| HCM2k95thQ:                                      | 34          | 22   | 43   | 12          | 10   | 5    | 15         | 34   | 0     | 20         | 62   | 34    |

Note: Queue reported is the number of cars per lane.

BART

Level Of Service Computation Report  
2000 HCM Operations (Future Volume Alternative)  
PM - Cumulative With Project

Intersection #5332: CENTRAL EXPWY/SCOTT BLVD [Study Int 28]

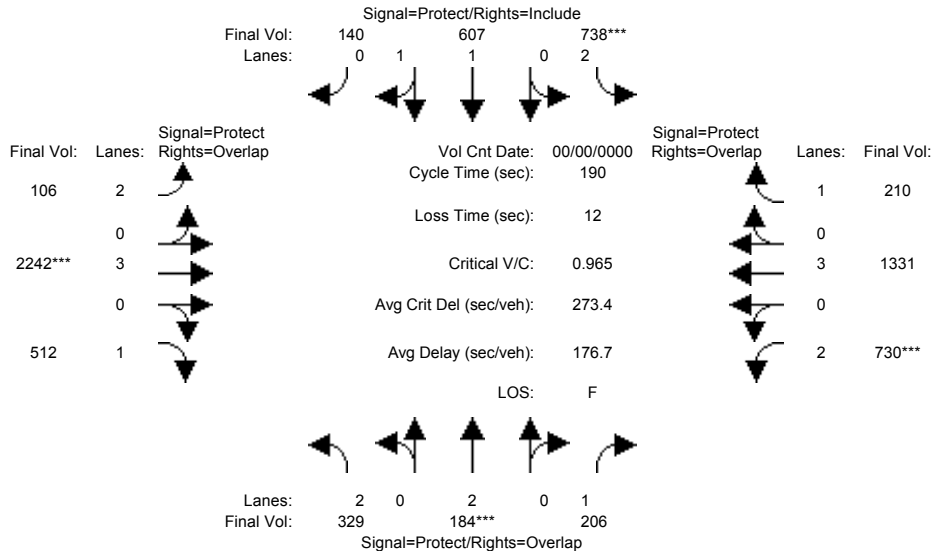

| Approach:  | North Bound |      |      | South Bound |      |       | East Bound |      |       | West Bound |      |       |
|--|-------------|------|------|-------------|------|-------|------------|------|-------|------------|------|-------|
| Movement:  | L           | T    | R    | L           | T    | R     | L          | T    | R     | L          | T    | R     |
| Min. Green:                                      | 28          | 42   | 42   | 20          | 34   | 34    | 19         | 105  | 105   | 23         | 109  | 109   |
| Y+R:   | 4.0         | 4.0  | 4.0  | 4.0         | 4.0  | 4.0   | 4.0        | 4.0  | 4.0   | 4.0        | 4.0  | 4.0   |
| Volume Module: >> Count Date: 0 0 << 5:00-6:00PM |             |      |      |             |      |       |            |      |       |            |      |       |
| Base Vol:  | 329         | 184  | 206  | 738         | 607  | 140   | 106        | 2577 | 512   | 730        | 1496 | 210   |
| Growth Adj:                                      | 1.00        | 1.00 | 1.00 | 1.00        | 1.00 | 1.00  | 1.00       | 1.00 | 1.00  | 1.00       | 1.00 | 1.00  |
| Initial Bse:                                     | 329         | 184  | 206  | 738         | 607  | 140   | 106        | 2577 | 512   | 730        | 1496 | 210   |
| Added Vol:                                       | 0           | 0    | 0    | 0           | 0    | 0     | 0          | 0    | 0     | 0          | 0    | 0     |
| PasserByVol:                                     | 0           | 0    | 0    | 0           | 0    | 0     | 0          | 0    | 0     | 0          | 0    | 0     |
| Initial Fut:                                     | 329         | 184  | 206  | 738         | 607  | 140   | 106        | 2577 | 512   | 730        | 1496 | 210   |
| User Adj:  | 1.00        | 1.00 | 1.00 | 1.00        | 1.00 | 1.00  | 1.00       | 0.87 | 1.00  | 1.00       | 0.89 | 1.00  |
| PHF Adj:   | 1.00        | 1.00 | 1.00 | 1.00        | 1.00 | 1.00  | 1.00       | 1.00 | 1.00  | 1.00       | 1.00 | 1.00  |
| PHF Volume:                                      | 329         | 184  | 206  | 738         | 607  | 140   | 106        | 2242 | 512   | 730        | 1331 | 210   |
| Reduct Vol:                                      | 0           | 0    | 0    | 0           | 0    | 0     | 0          | 0    | 0     | 0          | 0    | 0     |
| Reduced Vol:                                     | 329         | 184  | 206  | 738         | 607  | 140   | 106        | 2242 | 512   | 730        | 1331 | 210   |
| PCE Adj:   | 1.00        | 1.00 | 1.00 | 1.00        | 1.00 | 1.00  | 1.00       | 1.00 | 1.00  | 1.00       | 1.00 | 1.00  |
| MLF Adj:   | 1.00        | 1.00 | 1.00 | 1.00        | 1.00 | 1.00  | 1.00       | 1.00 | 1.00  | 1.00       | 1.00 | 1.00  |
| Final Volume:                                    | 329         | 184  | 206  | 738         | 607  | 140   | 106        | 2242 | 512   | 730        | 1331 | 210   |
| Saturation Flow Module:                          |             |      |      |             |      |       |            |      |       |            |      |       |
| Sat/Lane:  | 1900        | 1900 | 1900 | 1900        | 1900 | 1900  | 1900       | 1900 | 1900  | 1900       | 1900 | 1900  |
| Adjustment:                                      | 0.83        | 1.00 | 0.92 | 0.83        | 0.98 | 0.95  | 0.83       | 1.00 | 0.92  | 0.83       | 1.00 | 0.92  |
| Lanes:   | 2.00        | 2.00 | 1.00 | 2.00        | 1.61 | 0.39  | 2.00       | 3.00 | 1.00  | 2.00       | 3.00 | 1.00  |
| Final Sat.:                                      | 3150        | 3800 | 1750 | 3150        | 3006 | 693   | 3150       | 5700 | 1750  | 3150       | 5700 | 1750  |
| Capacity Analysis Module:                        |             |      |      |             |      |       |            |      |       |            |      |       |
| Vol/Sat:   | 0.10        | 0.05 | 0.12 | 0.23        | 0.20 | 0.20  | 0.03       | 0.39 | 0.29  | 0.23       | 0.23 | 0.12  |
| Crit Moves:                                      | ****        | **** | **** | ****        | **** | ****  | ****       | **** | ****  | ****       | **** | ****  |
| Green Time:                                      | 26.3        | 39.5 | 61.1 | 18.8        | 32.0 | 32.0  | 17.9       | 98.8 | 125.1 | 21.6       | 103  | 121.3 |
| Volume/Cap:                                      | 0.75        | 0.23 | 0.37 | 2.37        | 1.20 | 1.20  | 0.36       | 0.76 | 0.44  | 2.04       | 0.43 | 0.19  |
| Delay/Veh:                                       | 91.0        | 66.7 | 53.1 | 715.7       | 189  | 188.8 | 86.5       | 49.7 | 25.7  | 565.1      | 19.7 | 7.2   |
| User DelAdj:                                     | 1.00        | 1.00 | 1.00 | 1.00        | 1.00 | 1.00  | 1.00       | 1.00 | 1.00  | 1.00       | 1.00 | 1.00  |
| AdjDel/Veh:                                      | 91.0        | 66.7 | 53.1 | 715.7       | 189  | 188.8 | 86.5       | 49.7 | 25.7  | 565.1      | 19.7 | 7.2   |
| LOS by Move:                                     | F           | E    | D    | F           | F    | F     | F          | D    | C     | F          | B    | A     |
| HCM2k95thQ:                                      | 22          | 9    | 19   | 88          | 51   | 51    | 8          | 63   | 38    | 82         | 20   | 5     |

Note: Queue reported is the number of cars per lane.

BART

Level Of Service Computation Report  
2000 HCM Operations (Future Volume Alternative)  
AM - Cumulative No Project

Intersection #5334: CENTRAL EXPWY/LAFAYETTE ST [Study Int 29]

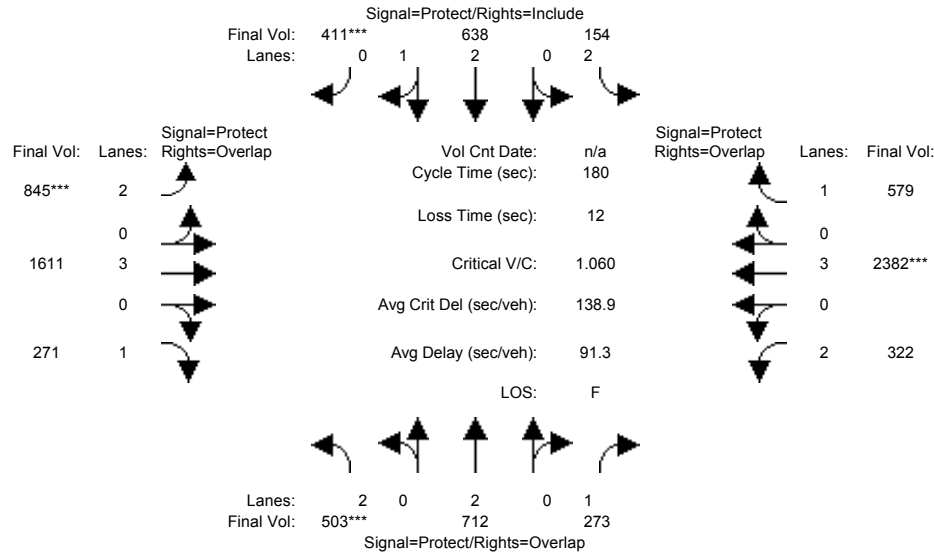

| Approach:                 | North Bound |      |      | South Bound |      |       | East Bound |      |       | West Bound |      |       |
|---------------------------|-------------|------|------|-------------|------|-------|------------|------|-------|------------|------|-------|
| Movement:                 | L           | T    | R    | L           | T    | R     | L          | T    | R     | L          | T    | R     |
| Min. Green:               | 14          | 10   | 10   | 14          | 10   | 10    | 14         | 10   | 10    | 14         | 90   | 10    |
| Y+R:                      | 4.0         | 4.0  | 4.0  | 4.0         | 4.0  | 4.0   | 4.0        | 4.0  | 4.0   | 4.0        | 4.0  | 4.0   |
| Volume Module:            |             |      |      |             |      |       |            |      |       |            |      |       |
| Base Vol:                 | 503         | 712  | 273  | 154         | 638  | 411   | 845        | 1611 | 271   | 322        | 2382 | 579   |
| Growth Adj:               | 1.00        | 1.00 | 1.00 | 1.00        | 1.00 | 1.00  | 1.00       | 1.00 | 1.00  | 1.00       | 1.00 | 1.00  |
| Initial Bse:              | 503         | 712  | 273  | 154         | 638  | 411   | 845        | 1611 | 271   | 322        | 2382 | 579   |
| Added Vol:                | 0           | 0    | 0    | 0           | 0    | 0     | 0          | 0    | 0     | 0          | 0    | 0     |
| PasserByVol:              | 0           | 0    | 0    | 0           | 0    | 0     | 0          | 0    | 0     | 0          | 0    | 0     |
| Initial Fut:              | 503         | 712  | 273  | 154         | 638  | 411   | 845        | 1611 | 271   | 322        | 2382 | 579   |
| User Adj:                 | 1.00        | 1.00 | 1.00 | 1.00        | 1.00 | 1.00  | 1.00       | 1.00 | 1.00  | 1.00       | 1.00 | 1.00  |
| PHF Adj:                  | 1.00        | 1.00 | 1.00 | 1.00        | 1.00 | 1.00  | 1.00       | 1.00 | 1.00  | 1.00       | 1.00 | 1.00  |
| PHF Volume:               | 503         | 712  | 273  | 154         | 638  | 411   | 845        | 1611 | 271   | 322        | 2382 | 579   |
| Reduct Vol:               | 0           | 0    | 0    | 0           | 0    | 0     | 0          | 0    | 0     | 0          | 0    | 0     |
| Reduced Vol:              | 503         | 712  | 273  | 154         | 638  | 411   | 845        | 1611 | 271   | 322        | 2382 | 579   |
| PCE Adj:                  | 1.00        | 1.00 | 1.00 | 1.00        | 1.00 | 1.00  | 1.00       | 1.00 | 1.00  | 1.00       | 1.00 | 1.00  |
| MLF Adj:                  | 1.00        | 1.00 | 1.00 | 1.00        | 1.00 | 1.00  | 1.00       | 1.00 | 1.00  | 1.00       | 1.00 | 1.00  |
| Final Volume:             | 503         | 712  | 273  | 154         | 638  | 411   | 845        | 1611 | 271   | 322        | 2382 | 579   |
| Saturation Flow Module:   |             |      |      |             |      |       |            |      |       |            |      |       |
| Sat/Lane:                 | 1900        | 1900 | 1900 | 1900        | 1900 | 1900  | 1900       | 1900 | 1900  | 1900       | 1900 | 1900  |
| Adjustment:               | 1.00        | 1.00 | 1.00 | 1.00        | 1.00 | 1.00  | 1.00       | 0.85 | 1.00  | 1.00       | 1.00 | 1.00  |
| Lanes:                    | 2.00        | 2.00 | 1.00 | 2.00        | 2.00 | 1.00  | 2.00       | 3.00 | 1.00  | 2.00       | 3.00 | 1.00  |
| Final Sat.:               | 3800        | 3800 | 1900 | 3800        | 3800 | 1900  | 3800       | 4845 | 1900  | 3800       | 5700 | 1900  |
| Capacity Analysis Module: |             |      |      |             |      |       |            |      |       |            |      |       |
| Vol/Sat:                  | 0.13        | 0.19 | 0.14 | 0.04        | 0.17 | 0.22  | 0.22       | 0.33 | 0.14  | 0.08       | 0.42 | 0.30  |
| Crit Moves:               | ****        |      |      |             |      | ****  | ****       |      |       | ****       |      |       |
| Green Time:               | 18.1        | 33.6 | 58.1 | 14.0        | 29.5 | 29.5  | 30.4       | 95.9 | 114.0 | 24.4       | 90.0 | 104.0 |
| Volume/Cap:               | 1.32        | 1.00 | 0.45 | 0.52        | 1.02 | 1.32  | 1.32       | 0.62 | 0.23  | 0.62       | 0.84 | 0.53  |
| Delay/Veh:                | 247.4       | 119  | 64.1 | 85.9        | 119  | 236.9 | 228.7      | 29.9 | 14.2  | 75.8       | 41.0 | 23.6  |
| User DelAdj:              | 1.00        | 1.00 | 1.00 | 1.00        | 1.00 | 1.00  | 1.00       | 1.00 | 1.00  | 1.00       | 1.00 | 1.00  |
| AdjDel/Veh:               | 247.4       | 119  | 64.1 | 85.9        | 119  | 236.9 | 228.7      | 29.9 | 14.2  | 75.8       | 41.0 | 23.6  |
| LOS by Move:              | F           | F    | E    | F           | F    | F     | F          | C    | B     | E          | D    | C     |
| HCM2k95thQ:               | 36          | 38   | 24   | 8           | 35   | 55    | 56         | 33   | 12    | 16         | 64   | 39    |

Note: Queue reported is the number of cars per lane.



BART

Level Of Service Computation Report  
2000 HCM Operations (Future Volume Alternative)  
PM - Cumulative No Project

Intersection #5334: CENTRAL EXPWY/LAFAYETTE ST [Study Int 29]

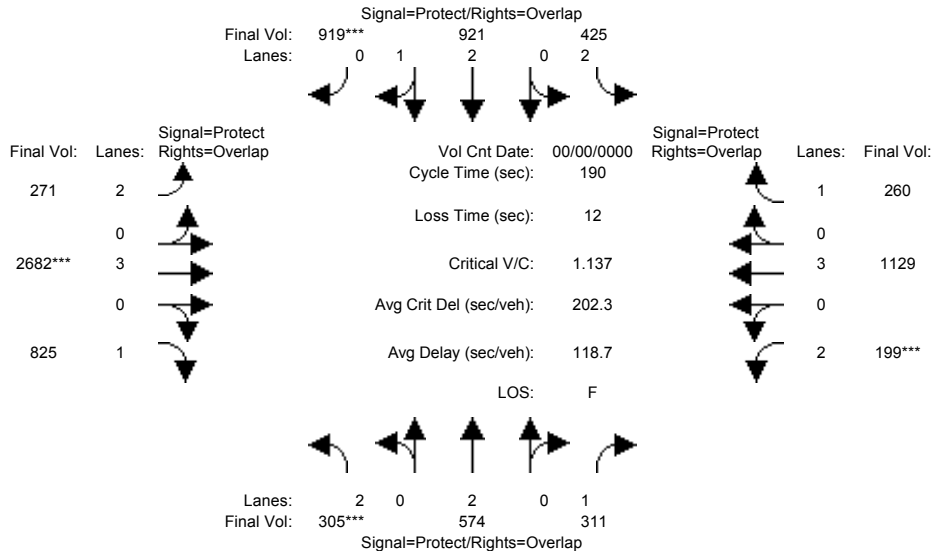

| Approach:                                      | North Bound |      |      | South Bound |      |       | East Bound |      |       | West Bound |      |       |
|--|-------------|------|------|-------------|------|-------|------------|------|-------|------------|------|-------|
| Movement:                                      | L           | T    | R    | L           | T    | R     | L          | T    | R     | L          | T    | R     |
| Min. Green:                                    | 18          | 35   | 35   | 23          | 39   | 39    | 19         | 112  | 112   | 21         | 113  | 113   |
| Y+R:   | 4.0         | 4.0  | 4.0  | 4.0         | 4.0  | 4.0   | 4.0        | 4.0  | 4.0   | 4.0        | 4.0  | 4.0   |
| Volume Module: >> Count Date: 0 0 << 7:00-9:00 |             |      |      |             |      |       |            |      |       |            |      |       |
| Base Vol:                                      | 305         | 574  | 311  | 425         | 921  | 919   | 271        | 3083 | 825   | 199        | 1269 | 260   |
| Growth Adj:                                    | 1.00        | 1.00 | 1.00 | 1.00        | 1.00 | 1.00  | 1.00       | 1.00 | 1.00  | 1.00       | 1.00 | 1.00  |
| Initial Bse:                                   | 305         | 574  | 311  | 425         | 921  | 919   | 271        | 3083 | 825   | 199        | 1269 | 260   |
| Added Vol:                                     | 0           | 0    | 0    | 0           | 0    | 0     | 0          | 0    | 0     | 0          | 0    | 0     |
| PasserByVol:                                   | 0           | 0    | 0    | 0           | 0    | 0     | 0          | 0    | 0     | 0          | 0    | 0     |
| Initial Fut:                                   | 305         | 574  | 311  | 425         | 921  | 919   | 271        | 3083 | 825   | 199        | 1269 | 260   |
| User Adj:                                      | 1.00        | 1.00 | 1.00 | 1.00        | 1.00 | 1.00  | 1.00       | 0.87 | 1.00  | 1.00       | 0.89 | 1.00  |
| PHF Adj:                                       | 1.00        | 1.00 | 1.00 | 1.00        | 1.00 | 1.00  | 1.00       | 1.00 | 1.00  | 1.00       | 1.00 | 1.00  |
| PHF Volume:                                    | 305         | 574  | 311  | 425         | 921  | 919   | 271        | 2682 | 825   | 199        | 1129 | 260   |
| Reduct Vol:                                    | 0           | 0    | 0    | 0           | 0    | 0     | 0          | 0    | 0     | 0          | 0    | 0     |
| Reduced Vol:                                   | 305         | 574  | 311  | 425         | 921  | 919   | 271        | 2682 | 825   | 199        | 1129 | 260   |
| PCE Adj:                                       | 1.00        | 1.00 | 1.00 | 1.00        | 1.00 | 1.00  | 1.00       | 1.00 | 1.00  | 1.00       | 1.00 | 1.00  |
| MLF Adj:                                       | 1.00        | 1.00 | 1.00 | 1.00        | 1.00 | 1.00  | 1.00       | 1.00 | 1.00  | 1.00       | 1.00 | 1.00  |
| Final Volume:                                  | 305         | 574  | 311  | 425         | 921  | 919   | 271        | 2682 | 825   | 199        | 1129 | 260   |
| Saturation Flow Module:                        |             |      |      |             |      |       |            |      |       |            |      |       |
| Sat/Lane:                                      | 1900        | 1900 | 1900 | 1900        | 1900 | 1900  | 1900       | 1900 | 1900  | 1900       | 1900 | 1900  |
| Adjustment:                                    | 0.83        | 1.00 | 0.92 | 0.83        | 1.00 | 0.92  | 0.83       | 1.00 | 0.92  | 0.83       | 1.00 | 0.92  |
| Lanes:   | 2.00        | 2.00 | 1.00 | 2.00        | 2.00 | 1.00  | 2.00       | 3.00 | 1.00  | 2.00       | 3.00 | 1.00  |
| Final Sat.:                                    | 3150        | 3800 | 1750 | 3150        | 3800 | 1750  | 3150       | 5700 | 1750  | 3150       | 5700 | 1750  |
| Capacity Analysis Module:                      |             |      |      |             |      |       |            |      |       |            |      |       |
| Vol/Sat:                                       | 0.10        | 0.15 | 0.18 | 0.13        | 0.24 | 0.53  | 0.09       | 0.47 | 0.47  | 0.06       | 0.20 | 0.15  |
| Crit Moves:                                    | ****        |      |      | ****        |      |       | ****       |      |       | ****       |      |       |
| Green Time:                                    | 16.8        | 32.8 | 52.4 | 21.5        | 37.4 | 55.4  | 17.9       | 105  | 121.7 | 19.7       | 107  | 128.1 |
| Volume/Cap:                                    | 1.09        | 0.88 | 0.64 | 1.19        | 1.23 | 1.80  | 0.91       | 0.85 | 0.74  | 0.61       | 0.35 | 0.22  |
| Delay/Veh:                                     | 173.2       | 94.6 | 67.7 | 200.4       | 191  | 436.9 | 121.6      | 53.0 | 39.4  | 90.5       | 24.5 | 12.8  |
| User DelAdj:                                   | 1.00        | 1.00 | 1.00 | 1.00        | 1.00 | 1.00  | 1.00       | 1.00 | 1.00  | 1.00       | 1.00 | 1.00  |
| AdjDel/Veh:                                    | 173.2       | 94.6 | 67.7 | 200.4       | 191  | 436.9 | 121.6      | 53.0 | 39.4  | 90.5       | 24.5 | 12.8  |
| LOS by Move:                                   | F           | F    | E    | F           | F    | F     | F          | D    | D     | F          | C    | B     |
| HCM2k95thQ:                                    | 25          | 31   | 31   | 36          | 62   | 170   | 19         | 75   | 68    | 14         | 22   | 12    |

Note: Queue reported is the number of cars per lane.

BART

Level Of Service Computation Report  
 2000 HCM Operations (Future Volume Alternative)  
 AM - Cumulative With Project

Intersection #5334: CENTRAL EXPWY/LAFAYETTE ST [Study Int 29]

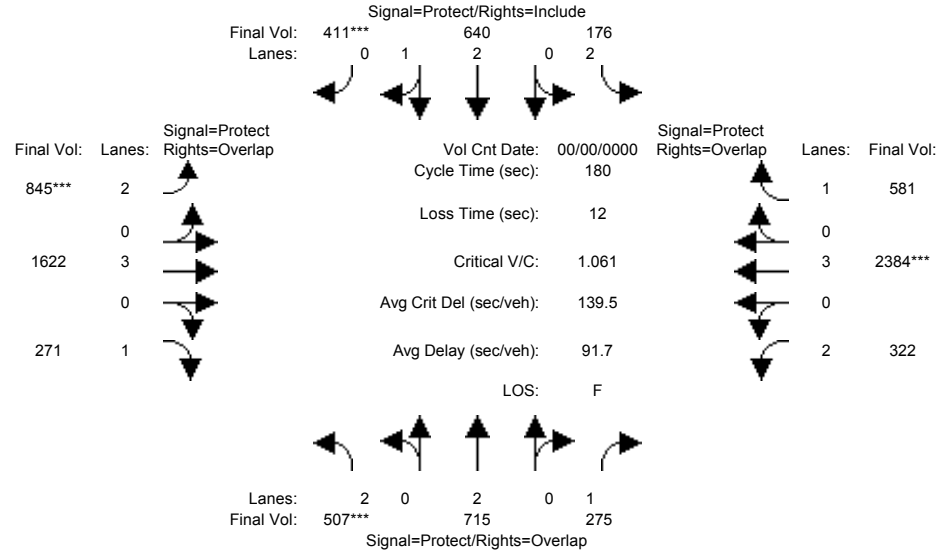

| Approach:                     | North Bound      |      |      | South Bound |      |       | East Bound |      |       | West Bound |      |       |
|-------------------------------|------------------|------|------|-------------|------|-------|------------|------|-------|------------|------|-------|
| Movement:                     | L                | T    | R    | L           | T    | R     | L          | T    | R     | L          | T    | R     |
| Min. Green:                   | 14               | 10   | 10   | 14          | 10   | 10    | 14         | 10   | 10    | 14         | 90   | 10    |
| Y+R:                          | 4.0              | 4.0  | 4.0  | 4.0         | 4.0  | 4.0   | 4.0        | 4.0  | 4.0   | 4.0        | 4.0  | 4.0   |
| Volume Module: >> Count Date: | 0 0 << 7:00-9:00 |      |      |             |      |       |            |      |       |            |      |       |
| Base Vol:                     | 507              | 715  | 275  | 176         | 640  | 411   | 845        | 1622 | 271   | 322        | 2384 | 581   |
| Growth Adj:                   | 1.00             | 1.00 | 1.00 | 1.00        | 1.00 | 1.00  | 1.00       | 1.00 | 1.00  | 1.00       | 1.00 | 1.00  |
| Initial Bse:                  | 507              | 715  | 275  | 176         | 640  | 411   | 845        | 1622 | 271   | 322        | 2384 | 581   |
| Added Vol:                    | 0                | 0    | 0    | 0           | 0    | 0     | 0          | 0    | 0     | 0          | 0    | 0     |
| PasserByVol:                  | 0                | 0    | 0    | 0           | 0    | 0     | 0          | 0    | 0     | 0          | 0    | 0     |
| Initial Fut:                  | 507              | 715  | 275  | 176         | 640  | 411   | 845        | 1622 | 271   | 322        | 2384 | 581   |
| User Adj:                     | 1.00             | 1.00 | 1.00 | 1.00        | 1.00 | 1.00  | 1.00       | 1.00 | 1.00  | 1.00       | 1.00 | 1.00  |
| PHF Adj:                      | 1.00             | 1.00 | 1.00 | 1.00        | 1.00 | 1.00  | 1.00       | 1.00 | 1.00  | 1.00       | 1.00 | 1.00  |
| PHF Volume:                   | 507              | 715  | 275  | 176         | 640  | 411   | 845        | 1622 | 271   | 322        | 2384 | 581   |
| Reduct Vol:                   | 0                | 0    | 0    | 0           | 0    | 0     | 0          | 0    | 0     | 0          | 0    | 0     |
| Reduced Vol:                  | 507              | 715  | 275  | 176         | 640  | 411   | 845        | 1622 | 271   | 322        | 2384 | 581   |
| PCE Adj:                      | 1.00             | 1.00 | 1.00 | 1.00        | 1.00 | 1.00  | 1.00       | 1.00 | 1.00  | 1.00       | 1.00 | 1.00  |
| MLF Adj:                      | 1.00             | 1.00 | 1.00 | 1.00        | 1.00 | 1.00  | 1.00       | 1.00 | 1.00  | 1.00       | 1.00 | 1.00  |
| Final Volume:                 | 507              | 715  | 275  | 176         | 640  | 411   | 845        | 1622 | 271   | 322        | 2384 | 581   |
| Saturation Flow Module:       |                  |      |      |             |      |       |            |      |       |            |      |       |
| Sat/Lane:                     | 1900             | 1900 | 1900 | 1900        | 1900 | 1900  | 1900       | 1900 | 1900  | 1900       | 1900 | 1900  |
| Adjustment:                   | 1.00             | 1.00 | 1.00 | 1.00        | 1.00 | 1.00  | 1.00       | 0.85 | 1.00  | 1.00       | 1.00 | 1.00  |
| Lanes:                        | 2.00             | 2.00 | 1.00 | 2.00        | 2.00 | 1.00  | 2.00       | 3.00 | 1.00  | 2.00       | 3.00 | 1.00  |
| Final Sat.:                   | 3800             | 3800 | 1900 | 3800        | 3800 | 1900  | 3800       | 4845 | 1900  | 3800       | 5700 | 1900  |
| Capacity Analysis Module:     |                  |      |      |             |      |       |            |      |       |            |      |       |
| Vol/Sat:                      | 0.13             | 0.19 | 0.14 | 0.05        | 0.17 | 0.22  | 0.22       | 0.33 | 0.14  | 0.08       | 0.42 | 0.31  |
| Crit Moves:                   | ****             |      |      |             |      |       |            |      |       |            |      |       |
| Green Time:                   | 18.2             | 33.7 | 58.0 | 14.0        | 29.5 | 29.5  | 30.3       | 96.0 | 114.2 | 24.3       | 90.0 | 104.0 |
| Volume/Cap:                   | 1.32             | 1.01 | 0.45 | 0.60        | 1.03 | 1.32  | 1.32       | 0.63 | 0.22  | 0.63       | 0.84 | 0.53  |
| Delay/Veh:                    | 248.3            | 119  | 64.2 | 88.1        | 121  | 238.0 | 229.7      | 29.9 | 14.1  | 76.0       | 41.0 | 23.6  |
| User DelAdj:                  | 1.00             | 1.00 | 1.00 | 1.00        | 1.00 | 1.00  | 1.00       | 1.00 | 1.00  | 1.00       | 1.00 | 1.00  |
| AdjDel/Veh:                   | 248.3            | 119  | 64.2 | 88.1        | 121  | 238.0 | 229.7      | 29.9 | 14.1  | 76.0       | 41.0 | 23.6  |
| LOS by Move:                  | F                | F    | E    | F           | F    | F     | F          | C    | B     | E          | D    | C     |
| HCM2k95thQ:                   | 36               | 38   | 24   | 9           | 36   | 55    | 56         | 34   | 12    | 16         | 64   | 39    |

Note: Queue reported is the number of cars per lane.

BART

Level Of Service Computation Report  
 2000 HCM Operations (Future Volume Alternative)  
 PM - Cumulative With Project

Intersection #5334: CENTRAL EXPWY/LAFAYETTE ST [Study Int 29]

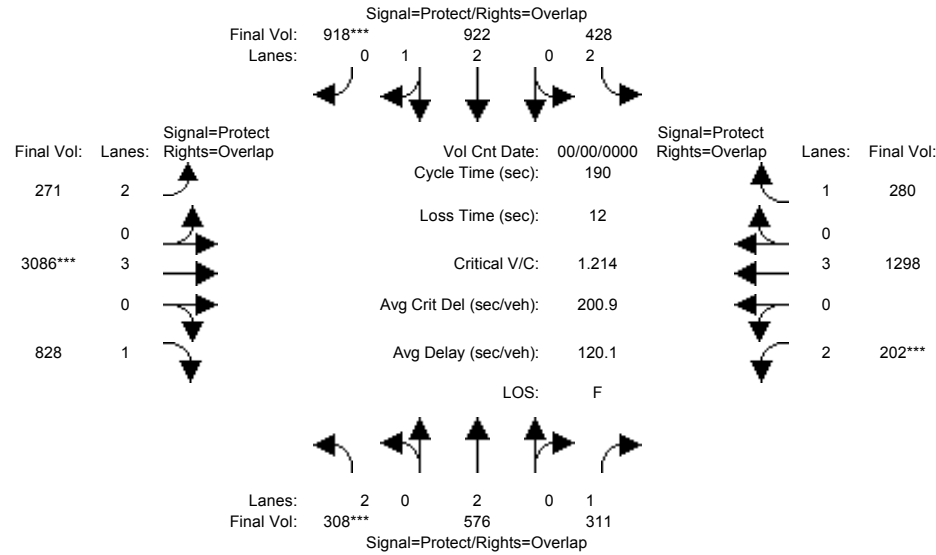

| Approach:                                      | North Bound |      |      | South Bound |      |       | East Bound |      |       | West Bound |      |       |
|--|-------------|------|------|-------------|------|-------|------------|------|-------|------------|------|-------|
| Movement:                                      | L           | T    | R    | L           | T    | R     | L          | T    | R     | L          | T    | R     |
| Min. Green:                                    | 18          | 35   | 35   | 23          | 39   | 39    | 19         | 112  | 112   | 21         | 113  | 113   |
| Y+R:   | 4.0         | 4.0  | 4.0  | 4.0         | 4.0  | 4.0   | 4.0        | 4.0  | 4.0   | 4.0        | 4.0  | 4.0   |
| Volume Module: >> Count Date: 0 0 << 7:00-9:00 |             |      |      |             |      |       |            |      |       |            |      |       |
| Base Vol:                                      | 308         | 576  | 311  | 428         | 922  | 918   | 271        | 3086 | 828   | 202        | 1298 | 280   |
| Growth Adj:                                    | 1.00        | 1.00 | 1.00 | 1.00        | 1.00 | 1.00  | 1.00       | 1.00 | 1.00  | 1.00       | 1.00 | 1.00  |
| Initial Bse:                                   | 308         | 576  | 311  | 428         | 922  | 918   | 271        | 3086 | 828   | 202        | 1298 | 280   |
| Added Vol:                                     | 0           | 0    | 0    | 0           | 0    | 0     | 0          | 0    | 0     | 0          | 0    | 0     |
| PasserByVol:                                   | 0           | 0    | 0    | 0           | 0    | 0     | 0          | 0    | 0     | 0          | 0    | 0     |
| Initial Fut:                                   | 308         | 576  | 311  | 428         | 922  | 918   | 271        | 3086 | 828   | 202        | 1298 | 280   |
| User Adj:                                      | 1.00        | 1.00 | 1.00 | 1.00        | 1.00 | 1.00  | 1.00       | 1.00 | 1.00  | 1.00       | 1.00 | 1.00  |
| PHF Adj:                                       | 1.00        | 1.00 | 1.00 | 1.00        | 1.00 | 1.00  | 1.00       | 1.00 | 1.00  | 1.00       | 1.00 | 1.00  |
| PHF Volume:                                    | 308         | 576  | 311  | 428         | 922  | 918   | 271        | 3086 | 828   | 202        | 1298 | 280   |
| Reduct Vol:                                    | 0           | 0    | 0    | 0           | 0    | 0     | 0          | 0    | 0     | 0          | 0    | 0     |
| Reduced Vol:                                   | 308         | 576  | 311  | 428         | 922  | 918   | 271        | 3086 | 828   | 202        | 1298 | 280   |
| PCE Adj:                                       | 1.00        | 1.00 | 1.00 | 1.00        | 1.00 | 1.00  | 1.00       | 1.00 | 1.00  | 1.00       | 1.00 | 1.00  |
| MLF Adj:                                       | 1.00        | 1.00 | 1.00 | 1.00        | 1.00 | 1.00  | 1.00       | 1.00 | 1.00  | 1.00       | 1.00 | 1.00  |
| Final Volume:                                  | 308         | 576  | 311  | 428         | 922  | 918   | 271        | 3086 | 828   | 202        | 1298 | 280   |
| Saturation Flow Module:                        |             |      |      |             |      |       |            |      |       |            |      |       |
| Sat/Lane:                                      | 1900        | 1900 | 1900 | 1900        | 1900 | 1900  | 1900       | 1900 | 1900  | 1900       | 1900 | 1900  |
| Adjustment:                                    | 0.83        | 1.00 | 0.92 | 0.83        | 1.00 | 0.92  | 0.83       | 1.00 | 0.92  | 0.83       | 1.00 | 0.92  |
| Lanes:   | 2.00        | 2.00 | 1.00 | 2.00        | 2.00 | 1.00  | 2.00       | 3.00 | 1.00  | 2.00       | 3.00 | 1.00  |
| Final Sat.:                                    | 3150        | 3800 | 1750 | 3150        | 3800 | 1750  | 3150       | 5700 | 1750  | 3150       | 5700 | 1750  |
| Capacity Analysis Module:                      |             |      |      |             |      |       |            |      |       |            |      |       |
| Vol/Sat:                                       | 0.10        | 0.15 | 0.18 | 0.14        | 0.24 | 0.52  | 0.09       | 0.54 | 0.47  | 0.06       | 0.23 | 0.16  |
| Crit Moves:                                    | ****        |      |      | ****        |      |       | ****       |      |       | ****       |      |       |
| Green Time:                                    | 16.8        | 32.8 | 52.4 | 21.5        | 37.4 | 55.4  | 17.9       | 105  | 121.7 | 19.7       | 107  | 128.1 |
| Volume/Cap:                                    | 1.10        | 0.88 | 0.64 | 1.20        | 1.23 | 1.80  | 0.91       | 0.98 | 0.74  | 0.62       | 0.41 | 0.24  |
| Delay/Veh:                                     | 176.7       | 94.9 | 67.7 | 203.6       | 192  | 436.1 | 121.6      | 70.3 | 39.6  | 90.8       | 25.4 | 12.9  |
| User DelAdj:                                   | 1.00        | 1.00 | 1.00 | 1.00        | 1.00 | 1.00  | 1.00       | 1.00 | 1.00  | 1.00       | 1.00 | 1.00  |
| AdjDel/Veh:                                    | 176.7       | 94.9 | 67.7 | 203.6       | 192  | 436.1 | 121.6      | 70.3 | 39.6  | 90.8       | 25.4 | 12.9  |
| LOS by Move:                                   | F           | F    | E    | F           | F    | F     | F          | E    | D     | F          | C    | B     |
| HCM2k95thQ:                                    | 26          | 31   | 31   | 37          | 62   | 170   | 19         | 99   | 69    | 14         | 26   | 13    |

Note: Queue reported is the number of cars per lane.

BART

Level Of Service Computation Report  
 2000 HCM Operations (Future Volume Alternative)  
 AM - Cumulative No Project

Intersection #5335: CENTRAL EXPWY/DE LA CRUZ BLVD [Study Int 30]

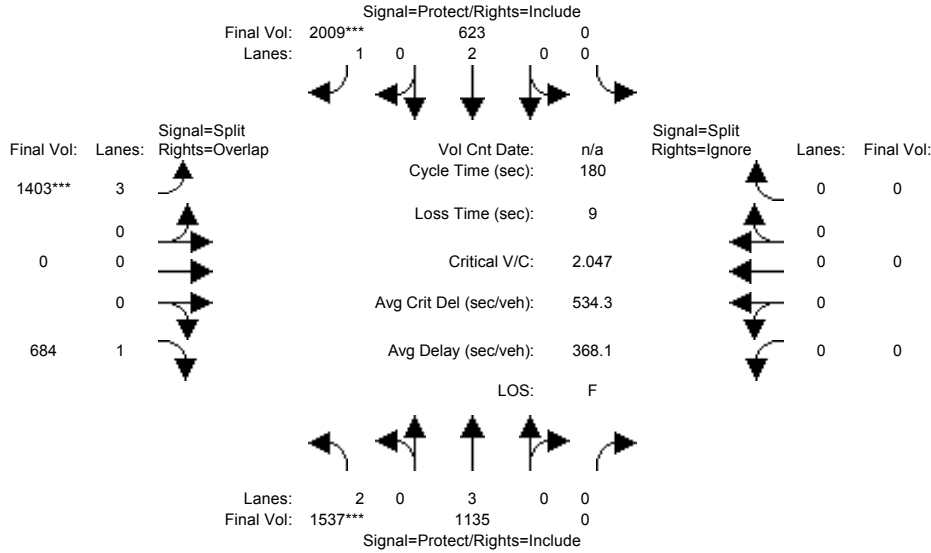

| Approach:                 | North Bound |      |      | South Bound |      |       | East Bound |      |      | West Bound |      |      |
|---------------------------|-------------|------|------|-------------|------|-------|------------|------|------|------------|------|------|
| Movement:                 | L           | T    | R    | L           | T    | R     | L          | T    | R    | L          | T    | R    |
| Min. Green:               | 7           | 10   | 0    | 0           | 10   | 10    | 10         | 0    | 10   | 0          | 0    | 0    |
| Y+R:                      | 4.0         | 4.0  | 4.0  | 4.0         | 4.0  | 4.0   | 4.0        | 4.0  | 4.0  | 4.0        | 4.0  | 4.0  |
| Volume Module:            |             |      |      |             |      |       |            |      |      |            |      |      |
| Base Vol:                 | 1537        | 1135 | 0    | 0           | 623  | 2009  | 1403       | 0    | 684  | 0          | 0    | 0    |
| Growth Adj:               | 1.00        | 1.00 | 1.00 | 1.00        | 1.00 | 1.00  | 1.00       | 1.00 | 1.00 | 1.00       | 1.00 | 1.00 |
| Initial Bse:              | 1537        | 1135 | 0    | 0           | 623  | 2009  | 1403       | 0    | 684  | 0          | 0    | 0    |
| Added Vol:                | 0           | 0    | 0    | 0           | 0    | 0     | 0          | 0    | 0    | 0          | 0    | 0    |
| PasserByVol:              | 0           | 0    | 0    | 0           | 0    | 0     | 0          | 0    | 0    | 0          | 0    | 0    |
| Initial Fut:              | 1537        | 1135 | 0    | 0           | 623  | 2009  | 1403       | 0    | 684  | 0          | 0    | 0    |
| User Adj:                 | 1.00        | 1.00 | 1.00 | 1.00        | 1.00 | 1.00  | 1.00       | 1.00 | 1.00 | 1.00       | 1.00 | 0.00 |
| PHF Adj:                  | 1.00        | 1.00 | 1.00 | 1.00        | 1.00 | 1.00  | 1.00       | 1.00 | 1.00 | 1.00       | 1.00 | 0.00 |
| PHF Volume:               | 1537        | 1135 | 0    | 0           | 623  | 2009  | 1403       | 0    | 684  | 0          | 0    | 0    |
| Reduct Vol:               | 0           | 0    | 0    | 0           | 0    | 0     | 0          | 0    | 0    | 0          | 0    | 0    |
| Reduced Vol:              | 1537        | 1135 | 0    | 0           | 623  | 2009  | 1403       | 0    | 684  | 0          | 0    | 0    |
| PCE Adj:                  | 1.00        | 1.00 | 1.00 | 1.00        | 1.00 | 1.00  | 1.00       | 1.00 | 1.00 | 1.00       | 1.00 | 0.00 |
| MLF Adj:                  | 1.00        | 1.00 | 1.00 | 1.00        | 1.00 | 1.00  | 1.00       | 1.00 | 1.00 | 1.00       | 1.00 | 0.00 |
| Final Volume:             | 1537        | 1135 | 0    | 0           | 623  | 2009  | 1403       | 0    | 684  | 0          | 0    | 0    |
| Saturation Flow Module:   |             |      |      |             |      |       |            |      |      |            |      |      |
| Sat/Lane:                 | 1900        | 1900 | 1900 | 1900        | 1900 | 1900  | 1900       | 1900 | 1900 | 1900       | 1900 | 1900 |
| Adjustment:               | 0.83        | 1.00 | 0.92 | 0.92        | 1.00 | 0.92  | 0.80       | 1.00 | 0.92 | 0.92       | 1.00 | 0.92 |
| Lanes:                    | 2.00        | 3.00 | 0.00 | 0.00        | 2.00 | 1.00  | 3.00       | 0.00 | 1.00 | 0.00       | 0.00 | 0.00 |
| Final Sat.:               | 3150        | 5700 | 0    | 0           | 3800 | 1750  | 4551       | 0    | 1750 | 0          | 0    | 0    |
| Capacity Analysis Module: |             |      |      |             |      |       |            |      |      |            |      |      |
| Vol/Sat:                  | 0.49        | 0.20 | 0.00 | 0.00        | 0.16 | 1.15  | 0.31       | 0.00 | 0.39 | 0.00       | 0.00 | 0.00 |
| Crit Moves:               | ****        |      |      |             |      | ****  | ****       |      |      |            |      |      |
| Green Time:               | 42.9        | 144  | 0.0  | 0.0         | 101  | 101.0 | 27.1       | 0.0  | 70.0 | 0.0        | 0.0  | 0.0  |
| Volume/Cap:               | 2.05        | 0.25 | 0.00 | 0.00        | 0.29 | 2.05  | 2.05       | 0.00 | 1.00 | 0.00       | 0.00 | 0.00 |
| Delay/Veh:                | 544.1       | 4.6  | 0.0  | 0.0         | 20.8 | 514.0 | 552.5      | 0.0  | 85.4 | 0.0        | 0.0  | 0.0  |
| User DelAdj:              | 1.00        | 1.00 | 1.00 | 1.00        | 1.00 | 1.00  | 1.00       | 1.00 | 1.00 | 1.00       | 1.00 | 1.00 |
| AdjDel/Veh:               | 544.1       | 4.6  | 0.0  | 0.0         | 20.8 | 514.0 | 552.5      | 0.0  | 85.4 | 0.0        | 0.0  | 0.0  |
| LOS by Move:              | F           | A    | A    | A           | C    | F     | F          | A    | F    | A          | A    | A    |
| HCM2k95thQ:               | 160         | 10   | 0    | 0           | 16   | 376   | 102        | 0    | 70   | 0          | 0    | 0    |

Note: Queue reported is the number of cars per lane.

BART

Level Of Service Computation Report  
 2000 HCM Operations (Future Volume Alternative)  
 PM - Cumulative No Project

Intersection #5335: CENTRAL EXPWY/DE LA CRUZ BLVD [Study Int 30]

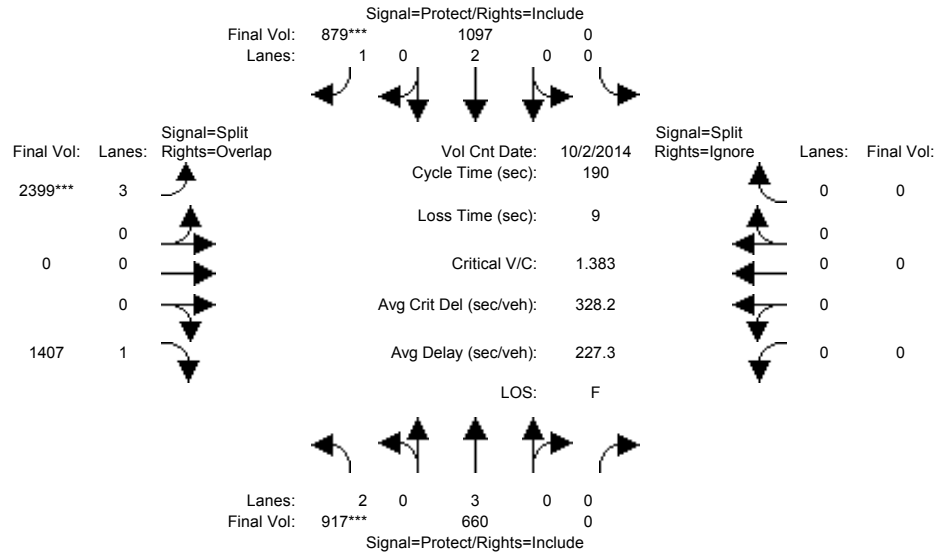

| Approach:   | North Bound                  |      |      | South Bound |      |       | East Bound |      |       | West Bound |      |      |
|---|------------------------------|------|------|-------------|------|-------|------------|------|-------|------------|------|------|
| Movement:   | L                            | T    | R    | L           | T    | R     | L          | T    | R     | L          | T    | R    |
| Min. Green:   | 19                           | 76   | 0    | 0           | 57   | 57    | 114        | 0    | 114   | 0          | 0    | 0    |
| Y+R:  | 4.0                          | 4.0  | 4.0  | 4.0         | 4.0  | 4.0   | 4.0        | 4.0  | 4.0   | 4.0        | 4.0  | 4.0  |
| ----- ----- ----- ----- ----- ----- ----- ----- ----- ----- ----- ----- ----- |                              |      |      |             |      |       |            |      |       |            |      |      |
| Volume Module:  | >> Count Date: 2 Oct 2014 << |      |      |             |      |       |            |      |       |            |      |      |
| Base Vol:   | 917                          | 660  | 0    | 0           | 1097 | 879   | 2399       | 0    | 1407  | 0          | 0    | 0    |
| Growth Adj:   | 1.00                         | 1.00 | 1.00 | 1.00        | 1.00 | 1.00  | 1.00       | 1.00 | 1.00  | 1.00       | 1.00 | 1.00 |
| Initial Bse:  | 917                          | 660  | 0    | 0           | 1097 | 879   | 2399       | 0    | 1407  | 0          | 0    | 0    |
| Added Vol:  | 0                            | 0    | 0    | 0           | 0    | 0     | 0          | 0    | 0     | 0          | 0    | 0    |
| PasserByVol:  | 0                            | 0    | 0    | 0           | 0    | 0     | 0          | 0    | 0     | 0          | 0    | 0    |
| Initial Fut:  | 917                          | 660  | 0    | 0           | 1097 | 879   | 2399       | 0    | 1407  | 0          | 0    | 0    |
| User Adj:   | 1.00                         | 1.00 | 1.00 | 1.00        | 1.00 | 1.00  | 1.00       | 1.00 | 1.00  | 1.00       | 1.00 | 0.00 |
| PHF Adj:  | 1.00                         | 1.00 | 1.00 | 1.00        | 1.00 | 1.00  | 1.00       | 1.00 | 1.00  | 1.00       | 1.00 | 0.00 |
| PHF Volume:   | 917                          | 660  | 0    | 0           | 1097 | 879   | 2399       | 0    | 1407  | 0          | 0    | 0    |
| Reduct Vol:   | 0                            | 0    | 0    | 0           | 0    | 0     | 0          | 0    | 0     | 0          | 0    | 0    |
| Reduced Vol:  | 917                          | 660  | 0    | 0           | 1097 | 879   | 2399       | 0    | 1407  | 0          | 0    | 0    |
| PCE Adj:  | 1.00                         | 1.00 | 1.00 | 1.00        | 1.00 | 1.00  | 1.00       | 1.00 | 1.00  | 1.00       | 1.00 | 0.00 |
| MLF Adj:  | 1.00                         | 1.00 | 1.00 | 1.00        | 1.00 | 1.00  | 1.00       | 1.00 | 1.00  | 1.00       | 1.00 | 0.00 |
| Final Volume:   | 917                          | 660  | 0    | 0           | 1097 | 879   | 2399       | 0    | 1407  | 0          | 0    | 0    |
| ----- ----- ----- ----- ----- ----- ----- ----- ----- ----- ----- -----       |                              |      |      |             |      |       |            |      |       |            |      |      |
| Saturation Flow Module:   |                              |      |      |             |      |       |            |      |       |            |      |      |
| Sat/Lane:   | 1900                         | 1900 | 1900 | 1900        | 1900 | 1900  | 1900       | 1900 | 1900  | 1900       | 1900 | 1900 |
| Adjustment:   | 0.83                         | 1.00 | 0.92 | 0.92        | 1.00 | 0.92  | 0.80       | 1.00 | 0.92  | 0.92       | 1.00 | 0.92 |
| Lanes:  | 2.00                         | 3.00 | 0.00 | 0.00        | 2.00 | 1.00  | 3.00       | 0.00 | 1.00  | 0.00       | 0.00 | 0.00 |
| Final Sat.:   | 3150                         | 5700 | 0    | 0           | 3800 | 1750  | 4551       | 0    | 1750  | 0          | 0    | 0    |
| ----- ----- ----- ----- ----- ----- ----- ----- ----- ----- ----- -----       |                              |      |      |             |      |       |            |      |       |            |      |      |
| Capacity Analysis Module:   |                              |      |      |             |      |       |            |      |       |            |      |      |
| Vol/Sat:  | 0.29                         | 0.12 | 0.00 | 0.00        | 0.29 | 0.50  | 0.53       | 0.00 | 0.80  | 0.00       | 0.00 | 0.00 |
| Crit Moves:   | ****                         |      |      |             | **** | ****  |            |      |       |            |      |      |
| Green Time:   | 18.1                         | 72.6 | 0.0  | 0.0         | 54.4 | 54.4  | 108.8      | 0.0  | 127.0 | 0.0        | 0.0  | 0.0  |
| Volume/Cap:   | 3.05                         | 0.30 | 0.00 | 0.00        | 1.01 | 1.75  | 0.92       | 0.00 | 1.20  | 0.00       | 0.00 | 0.00 |
| Delay/Veh:  | 1021                         | 43.1 | 0.0  | 0.0         | 100  | 418.3 | 30.4       | 0.0  | 112.2 | 0.0        | 0.0  | 0.0  |
| User DelAdj:  | 1.00                         | 1.00 | 1.00 | 1.00        | 1.00 | 1.00  | 1.00       | 1.00 | 1.00  | 1.00       | 1.00 | 1.00 |
| AdjDel/Veh:   | 1021                         | 43.1 | 0.0  | 0.0         | 100  | 418.3 | 30.4       | 0.0  | 112.2 | 0.0        | 0.0  | 0.0  |
| LOS by Move:  | F                            | D    | A    | A           | F    | F     | C          | A    | F     | A          | A    | A    |
| HCM2k95thQ:   | 117                          | 17   | 0    | 0           | 60   | 159   | 74         | 0    | 179   | 0          | 0    | 0    |

Note: Queue reported is the number of cars per lane.

BART

Level Of Service Computation Report  
 2000 HCM Operations (Future Volume Alternative)  
 AM - Cumulative With Project

Intersection #5335: CENTRAL EXPWY/DE LA CRUZ BLVD [Study Int 30]

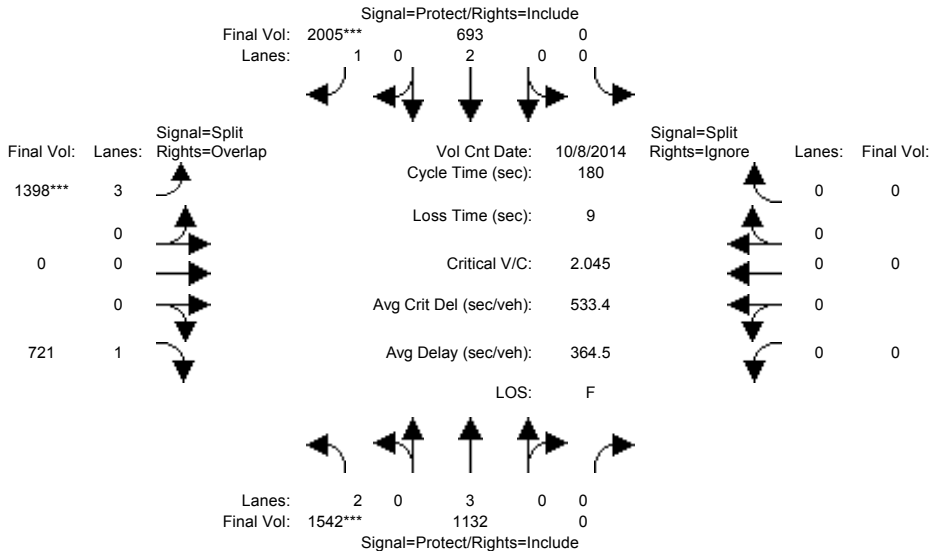

| Approach:                                   | North Bound |      |      | South Bound |      |       | East Bound |      |       | West Bound |      |      |
|---|-------------|------|------|-------------|------|-------|------------|------|-------|------------|------|------|
| Movement:                                   | L           | T    | R    | L           | T    | R     | L          | T    | R     | L          | T    | R    |
| Min. Green:                                 | 7           | 10   | 0    | 0           | 10   | 10    | 10         | 0    | 10    | 0          | 0    | 0    |
| Y+R:  | 4.0         | 4.0  | 4.0  | 4.0         | 4.0  | 4.0   | 4.0        | 4.0  | 4.0   | 4.0        | 4.0  | 4.0  |
| Volume Module: >> Count Date: 8 Oct 2014 << |             |      |      |             |      |       |            |      |       |            |      |      |
| Base Vol:                                   | 1542        | 1132 | 0    | 0           | 693  | 2005  | 1398       | 0    | 721   | 0          | 0    | 0    |
| Growth Adj:                                 | 1.00        | 1.00 | 1.00 | 1.00        | 1.00 | 1.00  | 1.00       | 1.00 | 1.00  | 1.00       | 1.00 | 1.00 |
| Initial Bse:                                | 1542        | 1132 | 0    | 0           | 693  | 2005  | 1398       | 0    | 721   | 0          | 0    | 0    |
| Added Vol:                                  | 0           | 0    | 0    | 0           | 0    | 0     | 0          | 0    | 0     | 0          | 0    | 0    |
| PasserByVol:                                | 0           | 0    | 0    | 0           | 0    | 0     | 0          | 0    | 0     | 0          | 0    | 0    |
| Initial Fut:                                | 1542        | 1132 | 0    | 0           | 693  | 2005  | 1398       | 0    | 721   | 0          | 0    | 0    |
| User Adj:                                   | 1.00        | 1.00 | 1.00 | 1.00        | 1.00 | 1.00  | 1.00       | 1.00 | 1.00  | 1.00       | 1.00 | 0.00 |
| PHF Adj:                                    | 1.00        | 1.00 | 1.00 | 1.00        | 1.00 | 1.00  | 1.00       | 1.00 | 1.00  | 1.00       | 1.00 | 0.00 |
| PHF Volume:                                 | 1542        | 1132 | 0    | 0           | 693  | 2005  | 1398       | 0    | 721   | 0          | 0    | 0    |
| Reduct Vol:                                 | 0           | 0    | 0    | 0           | 0    | 0     | 0          | 0    | 0     | 0          | 0    | 0    |
| Reduced Vol:                                | 1542        | 1132 | 0    | 0           | 693  | 2005  | 1398       | 0    | 721   | 0          | 0    | 0    |
| PCE Adj:                                    | 1.00        | 1.00 | 1.00 | 1.00        | 1.00 | 1.00  | 1.00       | 1.00 | 1.00  | 1.00       | 1.00 | 0.00 |
| MLF Adj:                                    | 1.00        | 1.00 | 1.00 | 1.00        | 1.00 | 1.00  | 1.00       | 1.00 | 1.00  | 1.00       | 1.00 | 0.00 |
| Final Volume:                               | 1542        | 1132 | 0    | 0           | 693  | 2005  | 1398       | 0    | 721   | 0          | 0    | 0    |
| Saturation Flow Module:                     |             |      |      |             |      |       |            |      |       |            |      |      |
| Sat/Lane:                                   | 1900        | 1900 | 1900 | 1900        | 1900 | 1900  | 1900       | 1900 | 1900  | 1900       | 1900 | 1900 |
| Adjustment:                                 | 0.83        | 1.00 | 0.92 | 0.92        | 1.00 | 0.92  | 0.80       | 1.00 | 0.92  | 0.92       | 1.00 | 0.92 |
| Lanes:                                      | 2.00        | 3.00 | 0.00 | 0.00        | 2.00 | 1.00  | 3.00       | 0.00 | 1.00  | 0.00       | 0.00 | 0.00 |
| Final Sat.:                                 | 3150        | 5700 | 0    | 0           | 3800 | 1750  | 4551       | 0    | 1750  | 0          | 0    | 0    |
| Capacity Analysis Module:                   |             |      |      |             |      |       |            |      |       |            |      |      |
| Vol/Sat:                                    | 0.49        | 0.20 | 0.00 | 0.00        | 0.18 | 1.15  | 0.31       | 0.00 | 0.41  | 0.00       | 0.00 | 0.00 |
| Crit Moves:                                 | ****        |      |      |             |      | ****  | ****       |      |       |            |      |      |
| Green Time:                                 | 43.1        | 144  | 0.0  | 0.0         | 101  | 100.9 | 27.0       | 0.0  | 70.1  | 0.0        | 0.0  | 0.0  |
| Volume/Cap:                                 | 2.04        | 0.25 | 0.00 | 0.00        | 0.33 | 2.04  | 2.04       | 0.00 | 1.06  | 0.00       | 0.00 | 0.00 |
| Delay/Veh:                                  | 543.2       | 4.5  | 0.0  | 0.0         | 21.4 | 513.2 | 551.7      | 0.0  | 100.3 | 0.0        | 0.0  | 0.0  |
| User DelAdj:                                | 1.00        | 1.00 | 1.00 | 1.00        | 1.00 | 1.00  | 1.00       | 1.00 | 1.00  | 1.00       | 1.00 | 1.00 |
| AdjDel/Veh:                                 | 543.2       | 4.5  | 0.0  | 0.0         | 21.4 | 513.2 | 551.7      | 0.0  | 100.3 | 0.0        | 0.0  | 0.0  |
| LOS by Move:                                | F           | A    | A    | A           | C    | F     | F          | A    | F     | A          | A    | A    |
| HCM2k95thQ:                                 | 161         | 10   | 0    | 0           | 18   | 375   | 102        | 0    | 77    | 0          | 0    | 0    |

Note: Queue reported is the number of cars per lane.

BART

Level Of Service Computation Report  
 2000 HCM Operations (Future Volume Alternative)  
 PM - Cumulative With Project

Intersection #5335: CENTRAL EXPWY/DE LA CRUZ BLVD [Study Int 30]

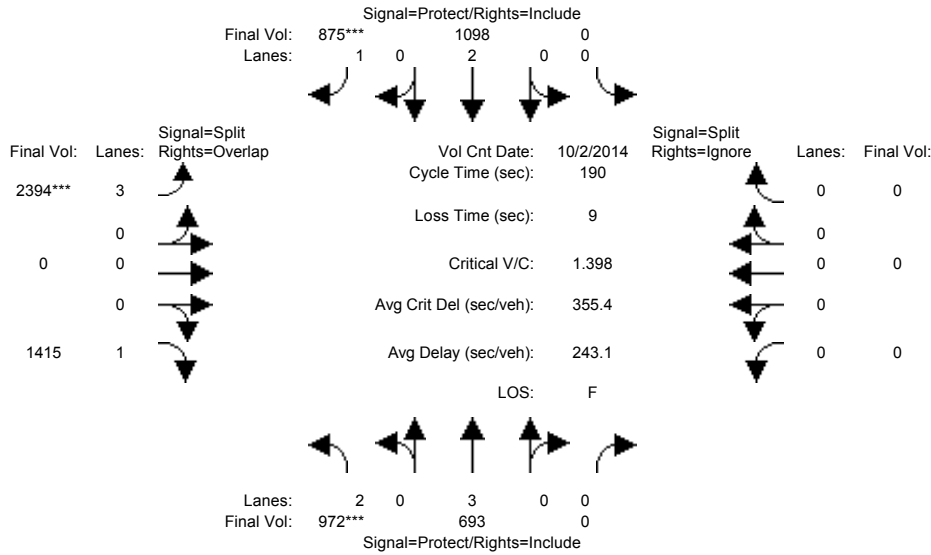

| Approach:                                   | North Bound |      |      | South Bound |      |       | East Bound |      |       | West Bound |      |      |
|---|-------------|------|------|-------------|------|-------|------------|------|-------|------------|------|------|
| Movement:                                   | L           | T    | R    | L           | T    | R     | L          | T    | R     | L          | T    | R    |
| Min. Green:                                 | 19          | 76   | 0    | 0           | 57   | 57    | 114        | 0    | 114   | 0          | 0    | 0    |
| Y+R:  | 4.0         | 4.0  | 4.0  | 4.0         | 4.0  | 4.0   | 4.0        | 4.0  | 4.0   | 4.0        | 4.0  | 4.0  |
| Volume Module: >> Count Date: 2 Oct 2014 << |             |      |      |             |      |       |            |      |       |            |      |      |
| Base Vol:                                   | 972         | 693  | 0    | 0           | 1098 | 875   | 2394       | 0    | 1415  | 0          | 0    | 0    |
| Growth Adj:                                 | 1.00        | 1.00 | 1.00 | 1.00        | 1.00 | 1.00  | 1.00       | 1.00 | 1.00  | 1.00       | 1.00 | 1.00 |
| Initial Bse:                                | 972         | 693  | 0    | 0           | 1098 | 875   | 2394       | 0    | 1415  | 0          | 0    | 0    |
| Added Vol:                                  | 0           | 0    | 0    | 0           | 0    | 0     | 0          | 0    | 0     | 0          | 0    | 0    |
| PasserByVol:                                | 0           | 0    | 0    | 0           | 0    | 0     | 0          | 0    | 0     | 0          | 0    | 0    |
| Initial Fut:                                | 972         | 693  | 0    | 0           | 1098 | 875   | 2394       | 0    | 1415  | 0          | 0    | 0    |
| User Adj:                                   | 1.00        | 1.00 | 1.00 | 1.00        | 1.00 | 1.00  | 1.00       | 1.00 | 1.00  | 1.00       | 1.00 | 0.00 |
| PHF Adj:                                    | 1.00        | 1.00 | 1.00 | 1.00        | 1.00 | 1.00  | 1.00       | 1.00 | 1.00  | 1.00       | 1.00 | 0.00 |
| PHF Volume:                                 | 972         | 693  | 0    | 0           | 1098 | 875   | 2394       | 0    | 1415  | 0          | 0    | 0    |
| Reduct Vol:                                 | 0           | 0    | 0    | 0           | 0    | 0     | 0          | 0    | 0     | 0          | 0    | 0    |
| Reduced Vol:                                | 972         | 693  | 0    | 0           | 1098 | 875   | 2394       | 0    | 1415  | 0          | 0    | 0    |
| PCE Adj:                                    | 1.00        | 1.00 | 1.00 | 1.00        | 1.00 | 1.00  | 1.00       | 1.00 | 1.00  | 1.00       | 1.00 | 0.00 |
| MLF Adj:                                    | 1.00        | 1.00 | 1.00 | 1.00        | 1.00 | 1.00  | 1.00       | 1.00 | 1.00  | 1.00       | 1.00 | 0.00 |
| Final Volume:                               | 972         | 693  | 0    | 0           | 1098 | 875   | 2394       | 0    | 1415  | 0          | 0    | 0    |
| Saturation Flow Module:                     |             |      |      |             |      |       |            |      |       |            |      |      |
| Sat/Lane:                                   | 1900        | 1900 | 1900 | 1900        | 1900 | 1900  | 1900       | 1900 | 1900  | 1900       | 1900 | 1900 |
| Adjustment:                                 | 0.83        | 1.00 | 0.92 | 0.92        | 1.00 | 0.92  | 0.80       | 1.00 | 0.92  | 0.92       | 1.00 | 0.92 |
| Lanes:                                      | 2.00        | 3.00 | 0.00 | 0.00        | 2.00 | 1.00  | 3.00       | 0.00 | 1.00  | 0.00       | 0.00 | 0.00 |
| Final Sat.:                                 | 3150        | 5700 | 0    | 0           | 3800 | 1750  | 4551       | 0    | 1750  | 0          | 0    | 0    |
| Capacity Analysis Module:                   |             |      |      |             |      |       |            |      |       |            |      |      |
| Vol/Sat:                                    | 0.31        | 0.12 | 0.00 | 0.00        | 0.29 | 0.50  | 0.53       | 0.00 | 0.81  | 0.00       | 0.00 | 0.00 |
| Crit Moves:                                 | ****        |      |      |             | **** | ****  |            |      |       |            |      |      |
| Green Time:                                 | 18.1        | 72.6 | 0.0  | 0.0         | 54.4 | 54.4  | 108.8      | 0.0  | 127.0 | 0.0        | 0.0  | 0.0  |
| Volume/Cap:                                 | 3.23        | 0.32 | 0.00 | 0.00        | 1.01 | 1.75  | 0.92       | 0.00 | 1.21  | 0.00       | 0.00 | 0.00 |
| Delay/Veh:                                  | 1103        | 43.4 | 0.0  | 0.0         | 100  | 414.7 | 30.2       | 0.0  | 115.0 | 0.0        | 0.0  | 0.0  |
| User DelAdj:                                | 1.00        | 1.00 | 1.00 | 1.00        | 1.00 | 1.00  | 1.00       | 1.00 | 1.00  | 1.00       | 1.00 | 1.00 |
| AdjDel/Veh:                                 | 1103        | 43.4 | 0.0  | 0.0         | 100  | 414.7 | 30.2       | 0.0  | 115.0 | 0.0        | 0.0  | 0.0  |
| LOS by Move:                                | F           | D    | A    | A           | F    | F     | C          | A    | F     | A          | A    | A    |
| HCM2k95thQ:                                 | 126         | 17   | 0    | 0           | 60   | 158   | 70         | 0    | 179   | 0          | 0    | 0    |

Note: Queue reported is the number of cars per lane.

BART

Level Of Service Computation Report  
 2000 HCM Operations (Future Volume Alternative)  
 AM - Cumulative No Project

Intersection #5416: SAN TOMAS EXPWY/EL CAMINO REAL [Study Int 41]

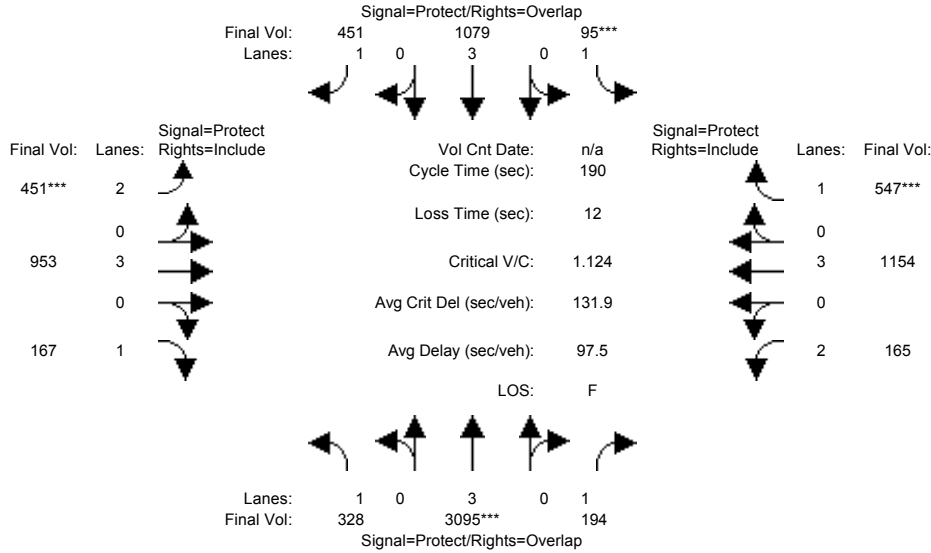

| Approach:                 | North Bound |      |       | South Bound |      |      | East Bound |      |      | West Bound |      |       |
|---------------------------|-------------|------|-------|-------------|------|------|------------|------|------|------------|------|-------|
| Movement:                 | L           | T    | R     | L           | T    | R    | L          | T    | R    | L          | T    | R     |
| Min. Green:               | 7           | 10   | 10    | 7           | 10   | 10   | 7          | 10   | 10   | 7          | 10   | 10    |
| Y+R:                      | 4.0         | 4.0  | 4.0   | 4.0         | 4.0  | 4.0  | 4.0        | 4.0  | 4.0  | 4.0        | 4.0  | 4.0   |
| Volume Module:            |             |      |       |             |      |      |            |      |      |            |      |       |
| Base Vol:                 | 328         | 3684 | 194   | 95          | 1284 | 451  | 451        | 953  | 167  | 165        | 1154 | 547   |
| Growth Adj:               | 1.00        | 1.00 | 1.00  | 1.00        | 1.00 | 1.00 | 1.00       | 1.00 | 1.00 | 1.00       | 1.00 | 1.00  |
| Initial Bse:              | 328         | 3684 | 194   | 95          | 1284 | 451  | 451        | 953  | 167  | 165        | 1154 | 547   |
| Added Vol:                | 0           | 0    | 0     | 0           | 0    | 0    | 0          | 0    | 0    | 0          | 0    | 0     |
| PasserByVol:              | 0           | 0    | 0     | 0           | 0    | 0    | 0          | 0    | 0    | 0          | 0    | 0     |
| Initial Fut:              | 328         | 3684 | 194   | 95          | 1284 | 451  | 451        | 953  | 167  | 165        | 1154 | 547   |
| User Adj:                 | 1.00        | 0.84 | 1.00  | 1.00        | 0.84 | 1.00 | 1.00       | 1.00 | 1.00 | 1.00       | 1.00 | 1.00  |
| PHF Adj:                  | 1.00        | 1.00 | 1.00  | 1.00        | 1.00 | 1.00 | 1.00       | 1.00 | 1.00 | 1.00       | 1.00 | 1.00  |
| PHF Volume:               | 328         | 3095 | 194   | 95          | 1079 | 451  | 451        | 953  | 167  | 165        | 1154 | 547   |
| Reduct Vol:               | 0           | 0    | 0     | 0           | 0    | 0    | 0          | 0    | 0    | 0          | 0    | 0     |
| Reduced Vol:              | 328         | 3095 | 194   | 95          | 1079 | 451  | 451        | 953  | 167  | 165        | 1154 | 547   |
| PCE Adj:                  | 1.00        | 1.00 | 1.00  | 1.00        | 1.00 | 1.00 | 1.00       | 1.00 | 1.00 | 1.00       | 1.00 | 1.00  |
| MLF Adj:                  | 1.00        | 1.00 | 1.00  | 1.00        | 1.00 | 1.00 | 1.00       | 1.00 | 1.00 | 1.00       | 1.00 | 1.00  |
| Final Volume:             | 328         | 3095 | 194   | 95          | 1079 | 451  | 451        | 953  | 167  | 165        | 1154 | 547   |
| Saturation Flow Module:   |             |      |       |             |      |      |            |      |      |            |      |       |
| Sat/Lane:                 | 1900        | 1900 | 1900  | 1900        | 1900 | 1900 | 1900       | 1900 | 1900 | 1900       | 1900 | 1900  |
| Adjustment:               | 0.92        | 1.00 | 0.92  | 0.92        | 1.00 | 0.92 | 0.83       | 1.00 | 0.92 | 0.83       | 1.00 | 0.92  |
| Lanes:                    | 1.00        | 3.00 | 1.00  | 1.00        | 3.00 | 1.00 | 2.00       | 3.00 | 1.00 | 2.00       | 3.00 | 1.00  |
| Final Sat.:               | 1750        | 5700 | 1750  | 1750        | 5700 | 1750 | 3150       | 5700 | 1750 | 3150       | 5700 | 1750  |
| Capacity Analysis Module: |             |      |       |             |      |      |            |      |      |            |      |       |
| Vol/Sat:                  | 0.19        | 0.54 | 0.11  | 0.05        | 0.19 | 0.26 | 0.14       | 0.17 | 0.10 | 0.05       | 0.20 | 0.31  |
| Crit Moves:               | ****        | **** | ****  | ****        | **** | **** | ****       | **** | **** | ****       | **** | ****  |
| Green Time:               | 50.2        | 91.8 | 110.2 | 9.2         | 50.7 | 74.9 | 24.2       | 58.7 | 58.7 | 18.4       | 52.8 | 52.8  |
| Volume/Cap:               | 0.71        | 1.12 | 0.19  | 1.12        | 0.71 | 0.65 | 1.12       | 0.54 | 0.31 | 0.54       | 0.73 | 1.12  |
| Delay/Veh:                | 70.9        | 121  | 25.7  | 228.8       | 79.8 | 69.6 | 166.0      | 54.9 | 50.5 | 83.8       | 63.8 | 147.9 |
| User DelAdj:              | 1.00        | 1.00 | 1.00  | 1.00        | 1.00 | 1.00 | 1.00       | 1.00 | 1.00 | 1.00       | 1.00 | 1.00  |
| AdjDel/Veh:               | 70.9        | 121  | 25.7  | 228.8       | 79.8 | 69.6 | 166.0      | 54.9 | 50.5 | 83.8       | 63.8 | 147.9 |
| LOS by Move:              | E           | F    | C     | F           | E    | E    | F          | D    | D    | F          | E    | F     |
| HCM2k95thQ:               | 33          | 113  | 14    | 15          | 34   | 43   | 37         | 27   | 15   | 11         | 34   | 68    |

Note: Queue reported is the number of cars per lane.



BART

Level Of Service Computation Report  
 2000 HCM Operations (Future Volume Alternative)  
 PM - Cumulative No Project

Intersection #5416: SAN TOMAS EXPWY/EL CAMINO REAL [Study Int 41]

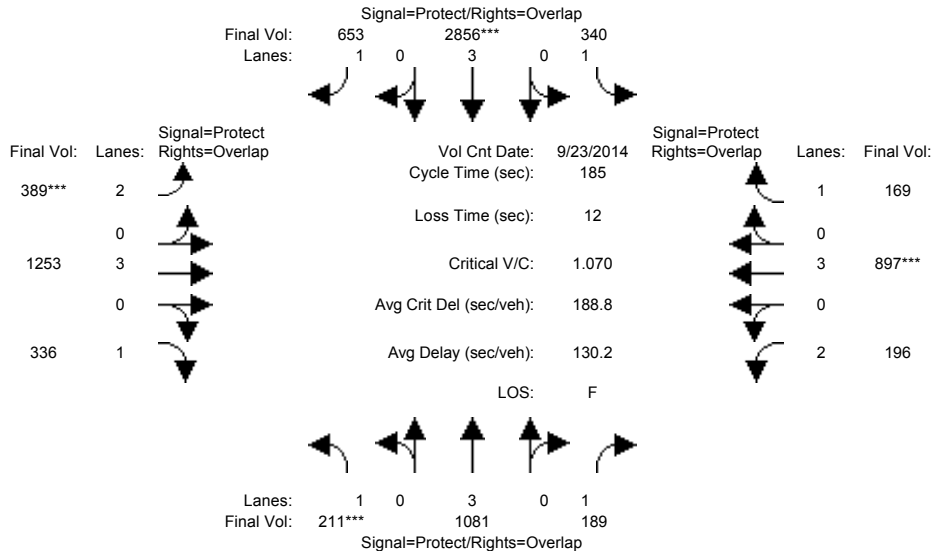

| Approach:                                    | North Bound |      |      | South Bound |      |       | East Bound |      |      | West Bound |      |      |
|--|-------------|------|------|-------------|------|-------|------------|------|------|------------|------|------|
| Movement:                                    | L           | T    | R    | L           | T    | R     | L          | T    | R    | L          | T    | R    |
| Min. Green:                                  | 12          | 72   | 72   | 33          | 93   | 93    | 39         | 50   | 50   | 29         | 41   | 41   |
| Y+R:   | 4.0         | 4.0  | 4.0  | 4.0         | 4.0  | 4.0   | 4.0        | 4.0  | 4.0  | 4.0        | 4.0  | 4.0  |
| Volume Module: >> Count Date: 23 Sep 2014 << |             |      |      |             |      |       |            |      |      |            |      |      |
| Base Vol:                                    | 211         | 1422 | 189  | 340         | 3709 | 653   | 389        | 1253 | 336  | 196        | 897  | 169  |
| Growth Adj:                                  | 1.00        | 1.00 | 1.00 | 1.00        | 1.00 | 1.00  | 1.00       | 1.00 | 1.00 | 1.00       | 1.00 | 1.00 |
| Initial Bse:                                 | 211         | 1422 | 189  | 340         | 3709 | 653   | 389        | 1253 | 336  | 196        | 897  | 169  |
| Added Vol:                                   | 0           | 0    | 0    | 0           | 0    | 0     | 0          | 0    | 0    | 0          | 0    | 0    |
| PasserByVol:                                 | 0           | 0    | 0    | 0           | 0    | 0     | 0          | 0    | 0    | 0          | 0    | 0    |
| Initial Fut:                                 | 211         | 1422 | 189  | 340         | 3709 | 653   | 389        | 1253 | 336  | 196        | 897  | 169  |
| User Adj:                                    | 1.00        | 0.76 | 1.00 | 1.00        | 0.77 | 1.00  | 1.00       | 1.00 | 1.00 | 1.00       | 1.00 | 1.00 |
| PHF Adj:                                     | 1.00        | 1.00 | 1.00 | 1.00        | 1.00 | 1.00  | 1.00       | 1.00 | 1.00 | 1.00       | 1.00 | 1.00 |
| PHF Volume:                                  | 211         | 1081 | 189  | 340         | 2856 | 653   | 389        | 1253 | 336  | 196        | 897  | 169  |
| Reduct Vol:                                  | 0           | 0    | 0    | 0           | 0    | 0     | 0          | 0    | 0    | 0          | 0    | 0    |
| Reduced Vol:                                 | 211         | 1081 | 189  | 340         | 2856 | 653   | 389        | 1253 | 336  | 196        | 897  | 169  |
| PCE Adj:                                     | 1.00        | 1.00 | 1.00 | 1.00        | 1.00 | 1.00  | 1.00       | 1.00 | 1.00 | 1.00       | 1.00 | 1.00 |
| MLF Adj:                                     | 1.00        | 1.00 | 1.00 | 1.00        | 1.00 | 1.00  | 1.00       | 1.00 | 1.00 | 1.00       | 1.00 | 1.00 |
| Final Volume:                                | 211         | 1081 | 189  | 340         | 2856 | 653   | 389        | 1253 | 336  | 196        | 897  | 169  |
| Saturation Flow Module:                      |             |      |      |             |      |       |            |      |      |            |      |      |
| Sat/Lane:                                    | 1900        | 1900 | 1900 | 1900        | 1900 | 1900  | 1900       | 1900 | 1900 | 1900       | 1900 | 1900 |
| Adjustment:                                  | 0.92        | 1.00 | 0.92 | 0.92        | 0.83 | 0.92  | 0.83       | 1.00 | 0.92 | 0.83       | 1.00 | 0.92 |
| Lanes:                                       | 1.00        | 3.00 | 1.00 | 1.00        | 3.00 | 1.00  | 2.00       | 3.00 | 1.00 | 2.00       | 3.00 | 1.00 |
| Final Sat.:                                  | 1750        | 5700 | 1750 | 1750        | 4731 | 1750  | 3150       | 5700 | 1750 | 3150       | 5700 | 1750 |
| Capacity Analysis Module:                    |             |      |      |             |      |       |            |      |      |            |      |      |
| Vol/Sat:                                     | 0.12        | 0.19 | 0.11 | 0.19        | 0.60 | 0.37  | 0.12       | 0.22 | 0.19 | 0.06       | 0.16 | 0.10 |
| Crit Moves:                                  | ****        |      |      | ****        |      |       | ****       |      |      | ****       |      |      |
| Green Time:                                  | 11.3        | 67.6 | 95.2 | 31.0        | 87.3 | 124.0 | 36.6       | 47.5 | 58.8 | 27.6       | 38.5 | 69.5 |
| Volume/Cap:                                  | 1.98        | 0.52 | 0.21 | 1.16        | 1.28 | 0.56  | 0.62       | 0.86 | 0.60 | 0.42       | 0.76 | 0.26 |
| Delay/Veh:                                   | 565.0       | 54.5 | 32.9 | 196.0       | 212  | 40.9  | 74.3       | 74.9 | 58.6 | 76.7       | 76.1 | 42.7 |
| User DelAdj:                                 | 1.00        | 1.00 | 1.00 | 1.00        | 1.00 | 1.00  | 1.00       | 1.00 | 1.00 | 1.00       | 1.00 | 1.00 |
| AdjDel/Veh:                                  | 565.0       | 54.5 | 32.9 | 196.0       | 212  | 40.9  | 74.3       | 74.9 | 58.6 | 76.7       | 76.1 | 42.7 |
| LOS by Move:                                 | F           | D    | C    | F           | F    | D     | E          | E    | E    | E          | E    | D    |
| HCM2k95thQ:                                  | 45          | 31   | 15   | 47          | 123  | 57    | 24         | 42   | 31   | 12         | 30   | 14   |

Note: Queue reported is the number of cars per lane.

BART

Level Of Service Computation Report  
 2000 HCM Operations (Future Volume Alternative)  
 AM - Cumulative With Project

Intersection #5416: SAN TOMAS EXPWY/EL CAMINO REAL [Study Int 41]

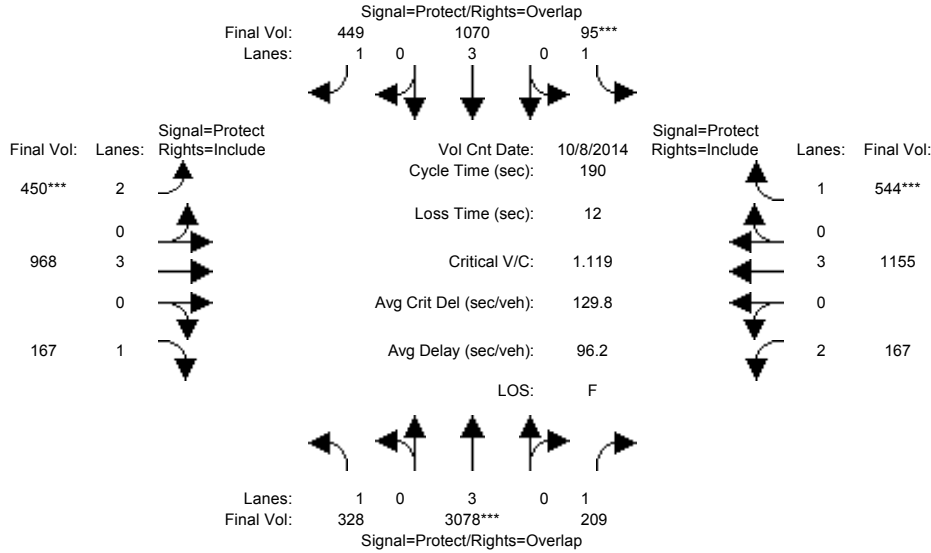

| Approach:                                   | North Bound |      |       | South Bound |      |      | East Bound |      |      | West Bound |      |       |
|---|-------------|------|-------|-------------|------|------|------------|------|------|------------|------|-------|
| Movement:                                   | L           | T    | R     | L           | T    | R    | L          | T    | R    | L          | T    | R     |
| Min. Green:                                 | 7           | 10   | 10    | 7           | 10   | 10   | 7          | 10   | 10   | 7          | 10   | 10    |
| Y+R:  | 4.0         | 4.0  | 4.0   | 4.0         | 4.0  | 4.0  | 4.0        | 4.0  | 4.0  | 4.0        | 4.0  | 4.0   |
| Volume Module: >> Count Date: 8 Oct 2014 << |             |      |       |             |      |      |            |      |      |            |      |       |
| Base Vol:                                   | 328         | 3664 | 209   | 95          | 1274 | 449  | 450        | 968  | 167  | 167        | 1155 | 544   |
| Growth Adj:                                 | 1.00        | 1.00 | 1.00  | 1.00        | 1.00 | 1.00 | 1.00       | 1.00 | 1.00 | 1.00       | 1.00 | 1.00  |
| Initial Bse:                                | 328         | 3664 | 209   | 95          | 1274 | 449  | 450        | 968  | 167  | 167        | 1155 | 544   |
| Added Vol:                                  | 0           | 0    | 0     | 0           | 0    | 0    | 0          | 0    | 0    | 0          | 0    | 0     |
| PasserByVol:                                | 0           | 0    | 0     | 0           | 0    | 0    | 0          | 0    | 0    | 0          | 0    | 0     |
| Initial Fut:                                | 328         | 3664 | 209   | 95          | 1274 | 449  | 450        | 968  | 167  | 167        | 1155 | 544   |
| User Adj:                                   | 1.00        | 0.84 | 1.00  | 1.00        | 0.84 | 1.00 | 1.00       | 1.00 | 1.00 | 1.00       | 1.00 | 1.00  |
| PHF Adj:                                    | 1.00        | 1.00 | 1.00  | 1.00        | 1.00 | 1.00 | 1.00       | 1.00 | 1.00 | 1.00       | 1.00 | 1.00  |
| PHF Volume:                                 | 328         | 3078 | 209   | 95          | 1070 | 449  | 450        | 968  | 167  | 167        | 1155 | 544   |
| Reduct Vol:                                 | 0           | 0    | 0     | 0           | 0    | 0    | 0          | 0    | 0    | 0          | 0    | 0     |
| Reduced Vol:                                | 328         | 3078 | 209   | 95          | 1070 | 449  | 450        | 968  | 167  | 167        | 1155 | 544   |
| PCE Adj:                                    | 1.00        | 1.00 | 1.00  | 1.00        | 1.00 | 1.00 | 1.00       | 1.00 | 1.00 | 1.00       | 1.00 | 1.00  |
| MLF Adj:                                    | 1.00        | 1.00 | 1.00  | 1.00        | 1.00 | 1.00 | 1.00       | 1.00 | 1.00 | 1.00       | 1.00 | 1.00  |
| Final Volume:                               | 328         | 3078 | 209   | 95          | 1070 | 449  | 450        | 968  | 167  | 167        | 1155 | 544   |
| Saturation Flow Module:                     |             |      |       |             |      |      |            |      |      |            |      |       |
| Sat/Lane:                                   | 1900        | 1900 | 1900  | 1900        | 1900 | 1900 | 1900       | 1900 | 1900 | 1900       | 1900 | 1900  |
| Adjustment:                                 | 0.92        | 1.00 | 0.92  | 0.92        | 1.00 | 0.92 | 0.83       | 1.00 | 0.92 | 0.83       | 1.00 | 0.92  |
| Lanes:                                      | 1.00        | 3.00 | 1.00  | 1.00        | 3.00 | 1.00 | 2.00       | 3.00 | 1.00 | 2.00       | 3.00 | 1.00  |
| Final Sat.:                                 | 1750        | 5700 | 1750  | 1750        | 5700 | 1750 | 3150       | 5700 | 1750 | 3150       | 5700 | 1750  |
| Capacity Analysis Module:                   |             |      |       |             |      |      |            |      |      |            |      |       |
| Vol/Sat:                                    | 0.19        | 0.54 | 0.12  | 0.05        | 0.19 | 0.26 | 0.14       | 0.17 | 0.10 | 0.05       | 0.20 | 0.31  |
| Crit Moves:                                 | ****        | **** | ****  | ****        | **** | **** | ****       | **** | **** | ****       | **** | ****  |
| Green Time:                                 | 50.4        | 91.7 | 110.0 | 9.2         | 50.5 | 74.8 | 24.3       | 58.7 | 58.7 | 18.3       | 52.8 | 52.8  |
| Volume/Cap:                                 | 0.71        | 1.12 | 0.21  | 1.12        | 0.71 | 0.65 | 1.12       | 0.55 | 0.31 | 0.55       | 0.73 | 1.12  |
| Delay/Veh:                                  | 70.7        | 119  | 26.0  | 226.8       | 79.8 | 69.6 | 164.0      | 55.0 | 50.5 | 84.0       | 63.9 | 146.0 |
| User DelAdj:                                | 1.00        | 1.00 | 1.00  | 1.00        | 1.00 | 1.00 | 1.00       | 1.00 | 1.00 | 1.00       | 1.00 | 1.00  |
| AdjDel/Veh:                                 | 70.7        | 119  | 26.0  | 226.8       | 79.8 | 69.6 | 164.0      | 55.0 | 50.5 | 84.0       | 63.9 | 146.0 |
| LOS by Move:                                | E           | F    | C     | F           | E    | E    | F          | D    | D    | F          | E    | F     |
| HCM2k95thQ:                                 | 33          | 112  | 16    | 15          | 34   | 43   | 37         | 27   | 15   | 11         | 34   | 67    |

Note: Queue reported is the number of cars per lane.

BART

Level Of Service Computation Report  
 2000 HCM Operations (Future Volume Alternative)  
 PM - Cumulative With Project

Intersection #5416: SAN TOMAS EXPWY/EL CAMINO REAL [Study Int 41]

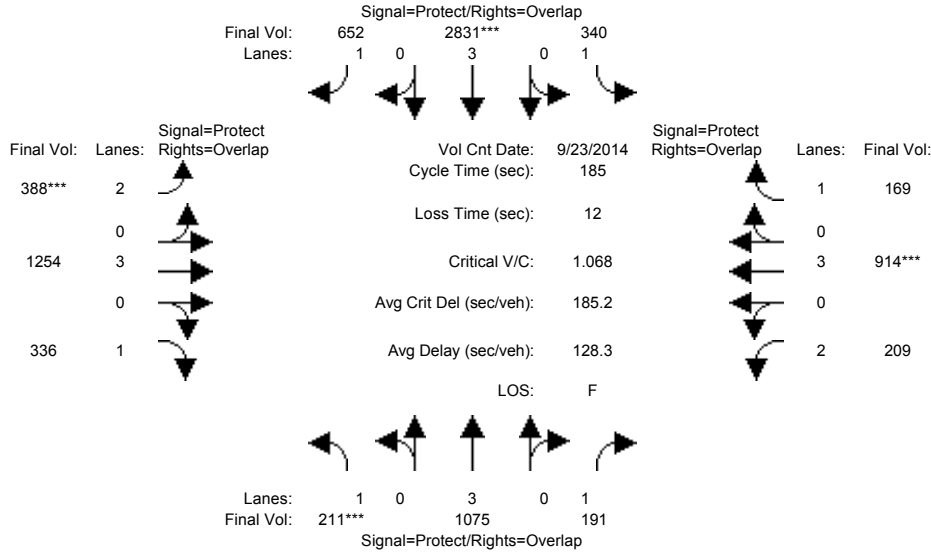

| Approach:                                    | North Bound |      |      | South Bound |      |       | East Bound |      |      | West Bound |      |      |
|--|-------------|------|------|-------------|------|-------|------------|------|------|------------|------|------|
| Movement:                                    | L           | T    | R    | L           | T    | R     | L          | T    | R    | L          | T    | R    |
| Min. Green:                                  | 12          | 72   | 72   | 33          | 93   | 93    | 39         | 50   | 50   | 29         | 41   | 41   |
| Y+R:   | 4.0         | 4.0  | 4.0  | 4.0         | 4.0  | 4.0   | 4.0        | 4.0  | 4.0  | 4.0        | 4.0  | 4.0  |
| Volume Module: >> Count Date: 23 Sep 2014 << |             |      |      |             |      |       |            |      |      |            |      |      |
| Base Vol:                                    | 211         | 1414 | 191  | 340         | 3677 | 652   | 388        | 1254 | 336  | 209        | 914  | 169  |
| Growth Adj:                                  | 1.00        | 1.00 | 1.00 | 1.00        | 1.00 | 1.00  | 1.00       | 1.00 | 1.00 | 1.00       | 1.00 | 1.00 |
| Initial Bse:                                 | 211         | 1414 | 191  | 340         | 3677 | 652   | 388        | 1254 | 336  | 209        | 914  | 169  |
| Added Vol:                                   | 0           | 0    | 0    | 0           | 0    | 0     | 0          | 0    | 0    | 0          | 0    | 0    |
| PasserByVol:                                 | 0           | 0    | 0    | 0           | 0    | 0     | 0          | 0    | 0    | 0          | 0    | 0    |
| Initial Fut:                                 | 211         | 1414 | 191  | 340         | 3677 | 652   | 388        | 1254 | 336  | 209        | 914  | 169  |
| User Adj:                                    | 1.00        | 0.76 | 1.00 | 1.00        | 0.77 | 1.00  | 1.00       | 1.00 | 1.00 | 1.00       | 1.00 | 1.00 |
| PHF Adj:                                     | 1.00        | 1.00 | 1.00 | 1.00        | 1.00 | 1.00  | 1.00       | 1.00 | 1.00 | 1.00       | 1.00 | 1.00 |
| PHF Volume:                                  | 211         | 1075 | 191  | 340         | 2831 | 652   | 388        | 1254 | 336  | 209        | 914  | 169  |
| Reduct Vol:                                  | 0           | 0    | 0    | 0           | 0    | 0     | 0          | 0    | 0    | 0          | 0    | 0    |
| Reduced Vol:                                 | 211         | 1075 | 191  | 340         | 2831 | 652   | 388        | 1254 | 336  | 209        | 914  | 169  |
| PCE Adj:                                     | 1.00        | 1.00 | 1.00 | 1.00        | 1.00 | 1.00  | 1.00       | 1.00 | 1.00 | 1.00       | 1.00 | 1.00 |
| MLF Adj:                                     | 1.00        | 1.00 | 1.00 | 1.00        | 1.00 | 1.00  | 1.00       | 1.00 | 1.00 | 1.00       | 1.00 | 1.00 |
| Final Volume:                                | 211         | 1075 | 191  | 340         | 2831 | 652   | 388        | 1254 | 336  | 209        | 914  | 169  |
| Saturation Flow Module:                      |             |      |      |             |      |       |            |      |      |            |      |      |
| Sat/Lane:                                    | 1900        | 1900 | 1900 | 1900        | 1900 | 1900  | 1900       | 1900 | 1900 | 1900       | 1900 | 1900 |
| Adjustment:                                  | 0.92        | 1.00 | 0.92 | 0.92        | 0.83 | 0.92  | 0.83       | 1.00 | 0.92 | 0.83       | 1.00 | 0.92 |
| Lanes:                                       | 1.00        | 3.00 | 1.00 | 1.00        | 3.00 | 1.00  | 2.00       | 3.00 | 1.00 | 2.00       | 3.00 | 1.00 |
| Final Sat.:                                  | 1750        | 5700 | 1750 | 1750        | 4731 | 1750  | 3150       | 5700 | 1750 | 3150       | 5700 | 1750 |
| Capacity Analysis Module:                    |             |      |      |             |      |       |            |      |      |            |      |      |
| Vol/Sat:                                     | 0.12        | 0.19 | 0.11 | 0.19        | 0.60 | 0.37  | 0.12       | 0.22 | 0.19 | 0.07       | 0.16 | 0.10 |
| Crit Moves:                                  | ****        |      |      | ****        |      |       | ****       |      |      | ****       |      |      |
| Green Time:                                  | 11.3        | 67.6 | 95.2 | 31.0        | 87.3 | 124.0 | 36.6       | 47.5 | 58.8 | 27.6       | 38.5 | 69.5 |
| Volume/Cap:                                  | 1.98        | 0.52 | 0.21 | 1.16        | 1.27 | 0.56  | 0.62       | 0.86 | 0.60 | 0.45       | 0.77 | 0.26 |
| Delay/Veh:                                   | 565.0       | 54.4 | 32.9 | 196.0       | 207  | 40.8  | 74.2       | 74.9 | 58.6 | 77.1       | 76.7 | 42.7 |
| User DelAdj:                                 | 1.00        | 1.00 | 1.00 | 1.00        | 1.00 | 1.00  | 1.00       | 1.00 | 1.00 | 1.00       | 1.00 | 1.00 |
| AdjDel/Veh:                                  | 565.0       | 54.4 | 32.9 | 196.0       | 207  | 40.8  | 74.2       | 74.9 | 58.6 | 77.1       | 76.7 | 42.7 |
| LOS by Move:                                 | F           | D    | C    | F           | F    | D     | E          | E    | E    | E          | E    | D    |
| HCM2k95thQ:                                  | 45          | 31   | 16   | 47          | 121  | 57    | 24         | 42   | 31   | 13         | 30   | 14   |

Note: Queue reported is the number of cars per lane.

BART

Level Of Service Computation Report  
 2000 HCM Operations (Future Volume Alternative)  
 AM - Cumulative No Project

Intersection #5444: Lafayette/Lewis [Study Int 47]

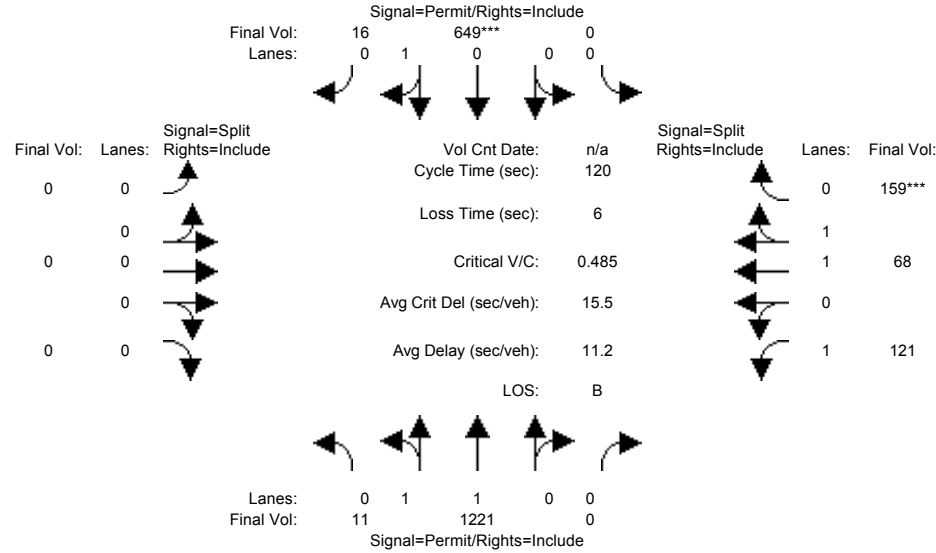

| Approach:                 | North Bound |      |      | South Bound |      |      | East Bound |      |      | West Bound |      |      |
|---------------------------|-------------|------|------|-------------|------|------|------------|------|------|------------|------|------|
| Movement:                 | L           | T    | R    | L           | T    | R    | L          | T    | R    | L          | T    | R    |
| Min. Green:               | 10          | 10   | 0    | 0           | 10   | 10   | 0          | 0    | 0    | 10         | 10   | 10   |
| Y+R:                      | 4.0         | 4.0  | 4.0  | 4.0         | 4.0  | 4.0  | 4.0        | 4.0  | 4.0  | 4.0        | 4.0  | 4.0  |
| Volume Module:            |             |      |      |             |      |      |            |      |      |            |      |      |
| Base Vol:                 | 11          | 1221 | 0    | 0           | 649  | 16   | 0          | 0    | 0    | 121        | 68   | 159  |
| Growth Adj:               | 1.00        | 1.00 | 1.00 | 1.00        | 1.00 | 1.00 | 1.00       | 1.00 | 1.00 | 1.00       | 1.00 | 1.00 |
| Initial Bse:              | 11          | 1221 | 0    | 0           | 649  | 16   | 0          | 0    | 0    | 121        | 68   | 159  |
| Added Vol:                | 0           | 0    | 0    | 0           | 0    | 0    | 0          | 0    | 0    | 0          | 0    | 0    |
| PasserByVol:              | 0           | 0    | 0    | 0           | 0    | 0    | 0          | 0    | 0    | 0          | 0    | 0    |
| Initial Fut:              | 11          | 1221 | 0    | 0           | 649  | 16   | 0          | 0    | 0    | 121        | 68   | 159  |
| User Adj:                 | 1.00        | 1.00 | 1.00 | 1.00        | 1.00 | 1.00 | 1.00       | 1.00 | 1.00 | 1.00       | 1.00 | 1.00 |
| PHF Adj:                  | 1.00        | 1.00 | 1.00 | 1.00        | 1.00 | 1.00 | 1.00       | 1.00 | 1.00 | 1.00       | 1.00 | 1.00 |
| PHF Volume:               | 11          | 1221 | 0    | 0           | 649  | 16   | 0          | 0    | 0    | 121        | 68   | 159  |
| Reduct Vol:               | 0           | 0    | 0    | 0           | 0    | 0    | 0          | 0    | 0    | 0          | 0    | 0    |
| Reduced Vol:              | 11          | 1221 | 0    | 0           | 649  | 16   | 0          | 0    | 0    | 121        | 68   | 159  |
| PCE Adj:                  | 1.00        | 1.00 | 1.00 | 1.00        | 1.00 | 1.00 | 1.00       | 1.00 | 1.00 | 1.00       | 1.00 | 1.00 |
| MLF Adj:                  | 1.00        | 1.00 | 1.00 | 1.00        | 1.00 | 1.00 | 1.00       | 1.00 | 1.00 | 1.00       | 1.00 | 1.00 |
| Final Volume:             | 11          | 1221 | 0    | 0           | 649  | 16   | 0          | 0    | 0    | 121        | 68   | 159  |
| Saturation Flow Module:   |             |      |      |             |      |      |            |      |      |            |      |      |
| Sat/Lane:                 | 1900        | 1900 | 1900 | 1900        | 1900 | 1900 | 1900       | 1900 | 1900 | 1900       | 1900 | 1900 |
| Adjustment:               | 0.95        | 0.97 | 0.92 | 0.92        | 0.95 | 0.95 | 0.92       | 1.00 | 0.92 | 0.92       | 1.00 | 0.92 |
| Lanes:                    | 0.02        | 1.98 | 0.00 | 0.00        | 0.98 | 0.02 | 0.00       | 0.00 | 0.00 | 1.00       | 1.00 | 1.00 |
| Final Sat.:               | 33          | 3667 | 0    | 0           | 1757 | 43   | 0          | 0    | 0    | 1750       | 1900 | 1750 |
| Capacity Analysis Module: |             |      |      |             |      |      |            |      |      |            |      |      |
| Vol/Sat:                  | 0.33        | 0.33 | 0.00 | 0.00        | 0.37 | 0.37 | 0.00       | 0.00 | 0.00 | 0.07       | 0.04 | 0.09 |
| Crit Moves:               | ****        |      |      |             |      |      |            |      |      |            |      |      |
| Green Time:               | 91.5        | 91.5 | 0.0  | 0.0         | 91.5 | 91.5 | 0.0        | 0.0  | 0.0  | 22.5       | 22.5 | 22.5 |
| Volume/Cap:               | 0.44        | 0.44 | 0.00 | 0.00        | 0.48 | 0.48 | 0.00       | 0.00 | 0.00 | 0.37       | 0.19 | 0.48 |
| Delay/Veh:                | 5.2         | 5.2  | 0.0  | 0.0         | 5.6  | 5.6  | 0.0        | 0.0  | 0.0  | 43.3       | 41.2 | 44.4 |
| User DelAdj:              | 1.00        | 1.00 | 1.00 | 1.00        | 1.00 | 1.00 | 1.00       | 1.00 | 1.00 | 1.00       | 1.00 | 1.00 |
| AdjDel/Veh:               | 5.2         | 5.2  | 0.0  | 0.0         | 5.6  | 5.6  | 0.0        | 0.0  | 0.0  | 43.3       | 41.2 | 44.4 |
| LOS by Move:              | A           | A    | A    | A           | A    | A    | A          | A    | A    | D          | D    | D    |
| HCM2k95thQ:               | 15          | 15   | 0    | 0           | 17   | 17   | 0          | 0    | 0    | 9          | 4    | 12   |

Note: Queue reported is the number of cars per lane.

BART

Level Of Service Computation Report  
 2000 HCM Operations (Future Volume Alternative)  
 PM - Cumulative No Project

Intersection #5444: Lafayette/Lewis [Study Int 47]

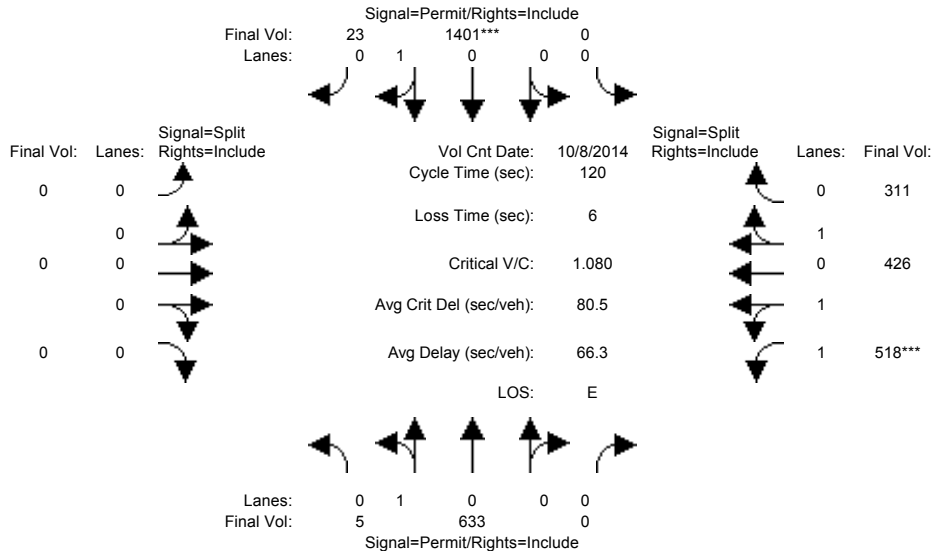

| Approach:                                   | North Bound |      |      | South Bound |      |      | East Bound |      |      | West Bound |      |      |
|---|-------------|------|------|-------------|------|------|------------|------|------|------------|------|------|
| Movement:                                   | L           | T    | R    | L           | T    | R    | L          | T    | R    | L          | T    | R    |
| Min. Green:                                 | 10          | 10   | 0    | 0           | 10   | 10   | 0          | 0    | 0    | 10         | 10   | 10   |
| Y+R:  | 4.0         | 4.0  | 4.0  | 4.0         | 4.0  | 4.0  | 4.0        | 4.0  | 4.0  | 4.0        | 4.0  | 4.0  |
| Volume Module: >> Count Date: 8 Oct 2014 << |             |      |      |             |      |      |            |      |      |            |      |      |
| Base Vol:                                   | 5           | 633  | 0    | 0           | 1401 | 23   | 0          | 0    | 0    | 518        | 426  | 311  |
| Growth Adj:                                 | 1.00        | 1.00 | 1.00 | 1.00        | 1.00 | 1.00 | 1.00       | 1.00 | 1.00 | 1.00       | 1.00 | 1.00 |
| Initial Bse:                                | 5           | 633  | 0    | 0           | 1401 | 23   | 0          | 0    | 0    | 518        | 426  | 311  |
| Added Vol:                                  | 0           | 0    | 0    | 0           | 0    | 0    | 0          | 0    | 0    | 0          | 0    | 0    |
| PasserByVol:                                | 0           | 0    | 0    | 0           | 0    | 0    | 0          | 0    | 0    | 0          | 0    | 0    |
| Initial Fut:                                | 5           | 633  | 0    | 0           | 1401 | 23   | 0          | 0    | 0    | 518        | 426  | 311  |
| User Adj:                                   | 1.00        | 1.00 | 1.00 | 1.00        | 1.00 | 1.00 | 1.00       | 1.00 | 1.00 | 1.00       | 1.00 | 1.00 |
| PHF Adj:                                    | 1.00        | 1.00 | 1.00 | 1.00        | 1.00 | 1.00 | 1.00       | 1.00 | 1.00 | 1.00       | 1.00 | 1.00 |
| PHF Volume:                                 | 5           | 633  | 0    | 0           | 1401 | 23   | 0          | 0    | 0    | 518        | 426  | 311  |
| Reduct Vol:                                 | 0           | 0    | 0    | 0           | 0    | 0    | 0          | 0    | 0    | 0          | 0    | 0    |
| Reduced Vol:                                | 5           | 633  | 0    | 0           | 1401 | 23   | 0          | 0    | 0    | 518        | 426  | 311  |
| PCE Adj:                                    | 1.00        | 1.00 | 1.00 | 1.00        | 1.00 | 1.00 | 1.00       | 1.00 | 1.00 | 1.00       | 1.00 | 1.00 |
| MLF Adj:                                    | 1.00        | 1.00 | 1.00 | 1.00        | 1.00 | 1.00 | 1.00       | 1.00 | 1.00 | 1.00       | 1.00 | 1.00 |
| Final Volume:                               | 5           | 633  | 0    | 0           | 1401 | 23   | 0          | 0    | 0    | 518        | 426  | 311  |
| Saturation Flow Module:                     |             |      |      |             |      |      |            |      |      |            |      |      |
| Sat/Lane:                                   | 1900        | 1900 | 1900 | 1900        | 1900 | 1900 | 1900       | 1900 | 1900 | 1900       | 1900 | 1900 |
| Adjustment:                                 | 0.95        | 0.95 | 0.92 | 0.92        | 0.95 | 0.95 | 0.92       | 1.00 | 0.92 | 0.93       | 0.95 | 0.95 |
| Lanes:                                      | 0.01        | 0.99 | 0.00 | 0.00        | 0.98 | 0.02 | 0.00       | 0.00 | 0.00 | 1.25       | 1.01 | 0.74 |
| Final Sat.:                                 | 14          | 1786 | 0    | 0           | 1771 | 29   | 0          | 0    | 0    | 2208       | 1816 | 1326 |
| Capacity Analysis Module:                   |             |      |      |             |      |      |            |      |      |            |      |      |
| Vol/Sat:                                    | 0.35        | 0.35 | 0.00 | 0.00        | 0.79 | 0.79 | 0.00       | 0.00 | 0.00 | 0.23       | 0.23 | 0.23 |
| Crit Moves:                                 | *****       |      |      |             |      |      |            |      |      |            |      |      |
| Green Time:                                 | 87.9        | 87.9 | 0.0  | 0.0         | 87.9 | 87.9 | 0.0        | 0.0  | 0.0  | 26.1       | 26.1 | 26.1 |
| Volume/Cap:                                 | 0.48        | 0.48 | 0.00 | 0.00        | 1.08 | 1.08 | 0.00       | 0.00 | 0.00 | 1.08       | 1.08 | 1.08 |
| Delay/Veh:                                  | 6.9         | 6.9  | 0.0  | 0.0         | 65.4 | 65.4 | 0.0        | 0.0  | 0.0  | 97.7       | 97.7 | 97.7 |
| User DelAdj:                                | 1.00        | 1.00 | 1.00 | 1.00        | 1.00 | 1.00 | 1.00       | 1.00 | 1.00 | 1.00       | 1.00 | 1.00 |
| AdjDel/Veh:                                 | 6.9         | 6.9  | 0.0  | 0.0         | 65.4 | 65.4 | 0.0        | 0.0  | 0.0  | 97.7       | 97.7 | 97.7 |
| LOS by Move:                                | A           | A    | A    | A           | E    | E    | A          | A    | A    | F          | F    | F    |
| HCM2k95thQ:                                 | 18          | 18   | 0    | 0           | 104  | 104  | 0          | 0    | 0    | 41         | 41   | 41   |

Note: Queue reported is the number of cars per lane.

BART

Level Of Service Computation Report  
2000 HCM Operations (Future Volume Alternative)  
AM - Cumulative With Project

Intersection #5444: Lafayette/Lewis [Study Int 47]

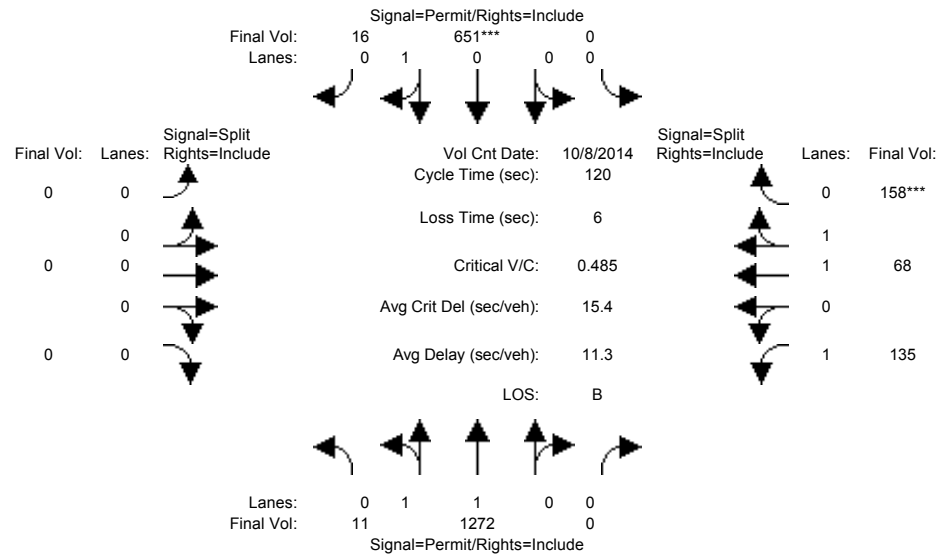

| Approach:                 | North Bound                  |      |      | South Bound |      |      | East Bound |      |      | West Bound |      |      |
|---------------------------|------------------------------|------|------|-------------|------|------|------------|------|------|------------|------|------|
| Movement:                 | L                            | T    | R    | L           | T    | R    | L          | T    | R    | L          | T    | R    |
| Min. Green:               | 10                           | 10   | 0    | 0           | 10   | 10   | 0          | 0    | 0    | 10         | 10   | 10   |
| Y+R:                      | 4.0                          | 4.0  | 4.0  | 4.0         | 4.0  | 4.0  | 4.0        | 4.0  | 4.0  | 4.0        | 4.0  | 4.0  |
| -----                     |                              |      |      |             |      |      |            |      |      |            |      |      |
| Volume Module:            | >> Count Date: 8 Oct 2014 << |      |      |             |      |      |            |      |      |            |      |      |
| Base Vol:                 | 11                           | 1272 | 0    | 0           | 651  | 16   | 0          | 0    | 0    | 135        | 68   | 158  |
| Growth Adj:               | 1.00                         | 1.00 | 1.00 | 1.00        | 1.00 | 1.00 | 1.00       | 1.00 | 1.00 | 1.00       | 1.00 | 1.00 |
| Initial Bse:              | 11                           | 1272 | 0    | 0           | 651  | 16   | 0          | 0    | 0    | 135        | 68   | 158  |
| Added Vol:                | 0                            | 0    | 0    | 0           | 0    | 0    | 0          | 0    | 0    | 0          | 0    | 0    |
| PasserByVol:              | 0                            | 0    | 0    | 0           | 0    | 0    | 0          | 0    | 0    | 0          | 0    | 0    |
| Initial Fut:              | 11                           | 1272 | 0    | 0           | 651  | 16   | 0          | 0    | 0    | 135        | 68   | 158  |
| User Adj:                 | 1.00                         | 1.00 | 1.00 | 1.00        | 1.00 | 1.00 | 1.00       | 1.00 | 1.00 | 1.00       | 1.00 | 1.00 |
| PHF Adj:                  | 1.00                         | 1.00 | 1.00 | 1.00        | 1.00 | 1.00 | 1.00       | 1.00 | 1.00 | 1.00       | 1.00 | 1.00 |
| PHF Volume:               | 11                           | 1272 | 0    | 0           | 651  | 16   | 0          | 0    | 0    | 135        | 68   | 158  |
| Reduct Vol:               | 0                            | 0    | 0    | 0           | 0    | 0    | 0          | 0    | 0    | 0          | 0    | 0    |
| Reduced Vol:              | 11                           | 1272 | 0    | 0           | 651  | 16   | 0          | 0    | 0    | 135        | 68   | 158  |
| PCE Adj:                  | 1.00                         | 1.00 | 1.00 | 1.00        | 1.00 | 1.00 | 1.00       | 1.00 | 1.00 | 1.00       | 1.00 | 1.00 |
| MLF Adj:                  | 1.00                         | 1.00 | 1.00 | 1.00        | 1.00 | 1.00 | 1.00       | 1.00 | 1.00 | 1.00       | 1.00 | 1.00 |
| Final Volume:             | 11                           | 1272 | 0    | 0           | 651  | 16   | 0          | 0    | 0    | 135        | 68   | 158  |
| -----                     |                              |      |      |             |      |      |            |      |      |            |      |      |
| Saturation Flow Module:   |                              |      |      |             |      |      |            |      |      |            |      |      |
| Sat/Lane:                 | 1900                         | 1900 | 1900 | 1900        | 1900 | 1900 | 1900       | 1900 | 1900 | 1900       | 1900 | 1900 |
| Adjustment:               | 0.95                         | 0.97 | 0.92 | 0.92        | 0.95 | 0.95 | 0.92       | 1.00 | 0.92 | 0.92       | 1.00 | 0.92 |
| Lanes:                    | 0.02                         | 1.98 | 0.00 | 0.00        | 0.98 | 0.02 | 0.00       | 0.00 | 0.00 | 1.00       | 1.00 | 1.00 |
| Final Sat.:               | 32                           | 3668 | 0    | 0           | 1757 | 43   | 0          | 0    | 0    | 1750       | 1900 | 1750 |
| -----                     |                              |      |      |             |      |      |            |      |      |            |      |      |
| Capacity Analysis Module: |                              |      |      |             |      |      |            |      |      |            |      |      |
| Vol/Sat:                  | 0.35                         | 0.35 | 0.00 | 0.00        | 0.37 | 0.37 | 0.00       | 0.00 | 0.00 | 0.08       | 0.04 | 0.09 |
| Crit Moves:               | *****                        |      |      |             |      |      |            |      |      |            |      |      |
| Green Time:               | 91.7                         | 91.7 | 0.0  | 0.0         | 91.7 | 91.7 | 0.0        | 0.0  | 0.0  | 22.3       | 22.3 | 22.3 |
| Volume/Cap:               | 0.45                         | 0.45 | 0.00 | 0.00        | 0.49 | 0.49 | 0.00       | 0.00 | 0.00 | 0.41       | 0.19 | 0.49 |
| Delay/Veh:                | 5.2                          | 5.2  | 0.0  | 0.0         | 5.6  | 5.6  | 0.0        | 0.0  | 0.0  | 43.9       | 41.3 | 44.5 |
| User DelAdj:              | 1.00                         | 1.00 | 1.00 | 1.00        | 1.00 | 1.00 | 1.00       | 1.00 | 1.00 | 1.00       | 1.00 | 1.00 |
| AdjDel/Veh:               | 5.2                          | 5.2  | 0.0  | 0.0         | 5.6  | 5.6  | 0.0        | 0.0  | 0.0  | 43.9       | 41.3 | 44.5 |
| LOS by Move:              | A                            | A    | A    | A           | A    | A    | A          | A    | A    | D          | D    | D    |
| HCM2k95thQ:               | 16                           | 16   | 0    | 0           | 17   | 17   | 0          | 0    | 0    | 10         | 4    | 12   |

Note: Queue reported is the number of cars per lane.

BART

Level Of Service Computation Report  
 2000 HCM Operations (Future Volume Alternative)  
 PM - Cumulative With Project

Intersection #5444: Lafayette/Lewis [Study Int 47]

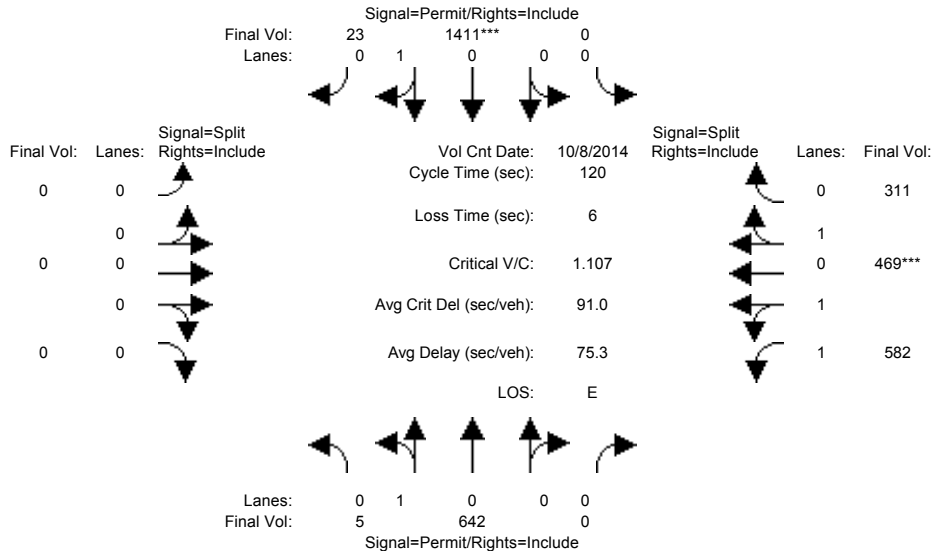

| Approach:                 | North Bound                  |      |      | South Bound |      |      | East Bound |      |      | West Bound |      |       |
|---------------------------|------------------------------|------|------|-------------|------|------|------------|------|------|------------|------|-------|
| Movement:                 | L                            | T    | R    | L           | T    | R    | L          | T    | R    | L          | T    | R     |
| Min. Green:               | 10                           | 10   | 0    | 0           | 10   | 10   | 0          | 0    | 0    | 10         | 10   | 10    |
| Y+R:                      | 4.0                          | 4.0  | 4.0  | 4.0         | 4.0  | 4.0  | 4.0        | 4.0  | 4.0  | 4.0        | 4.0  | 4.0   |
| -----                     |                              |      |      |             |      |      |            |      |      |            |      |       |
| Volume Module:            | >> Count Date: 8 Oct 2014 << |      |      |             |      |      |            |      |      |            |      |       |
| Base Vol:                 | 5                            | 642  | 0    | 0           | 1411 | 23   | 0          | 0    | 0    | 582        | 469  | 311   |
| Growth Adj:               | 1.00                         | 1.00 | 1.00 | 1.00        | 1.00 | 1.00 | 1.00       | 1.00 | 1.00 | 1.00       | 1.00 | 1.00  |
| Initial Bse:              | 5                            | 642  | 0    | 0           | 1411 | 23   | 0          | 0    | 0    | 582        | 469  | 311   |
| Added Vol:                | 0                            | 0    | 0    | 0           | 0    | 0    | 0          | 0    | 0    | 0          | 0    | 0     |
| PasserByVol:              | 0                            | 0    | 0    | 0           | 0    | 0    | 0          | 0    | 0    | 0          | 0    | 0     |
| Initial Fut:              | 5                            | 642  | 0    | 0           | 1411 | 23   | 0          | 0    | 0    | 582        | 469  | 311   |
| User Adj:                 | 1.00                         | 1.00 | 1.00 | 1.00        | 1.00 | 1.00 | 1.00       | 1.00 | 1.00 | 1.00       | 1.00 | 1.00  |
| PHF Adj:                  | 1.00                         | 1.00 | 1.00 | 1.00        | 1.00 | 1.00 | 1.00       | 1.00 | 1.00 | 1.00       | 1.00 | 1.00  |
| PHF Volume:               | 5                            | 642  | 0    | 0           | 1411 | 23   | 0          | 0    | 0    | 582        | 469  | 311   |
| Reduct Vol:               | 0                            | 0    | 0    | 0           | 0    | 0    | 0          | 0    | 0    | 0          | 0    | 0     |
| Reduced Vol:              | 5                            | 642  | 0    | 0           | 1411 | 23   | 0          | 0    | 0    | 582        | 469  | 311   |
| PCE Adj:                  | 1.00                         | 1.00 | 1.00 | 1.00        | 1.00 | 1.00 | 1.00       | 1.00 | 1.00 | 1.00       | 1.00 | 1.00  |
| MLF Adj:                  | 1.00                         | 1.00 | 1.00 | 1.00        | 1.00 | 1.00 | 1.00       | 1.00 | 1.00 | 1.00       | 1.00 | 1.00  |
| Final Volume:             | 5                            | 642  | 0    | 0           | 1411 | 23   | 0          | 0    | 0    | 582        | 469  | 311   |
| -----                     |                              |      |      |             |      |      |            |      |      |            |      |       |
| Saturation Flow Module:   |                              |      |      |             |      |      |            |      |      |            |      |       |
| Sat/Lane:                 | 1900                         | 1900 | 1900 | 1900        | 1900 | 1900 | 1900       | 1900 | 1900 | 1900       | 1900 | 1900  |
| Adjustment:               | 0.95                         | 0.95 | 0.92 | 0.92        | 0.95 | 0.95 | 0.92       | 1.00 | 0.92 | 0.93       | 0.95 | 0.95  |
| Lanes:                    | 0.01                         | 0.99 | 0.00 | 0.00        | 0.98 | 0.02 | 0.00       | 0.00 | 0.00 | 1.30       | 1.02 | 0.68  |
| Final Sat.:               | 14                           | 1786 | 0    | 0           | 1771 | 29   | 0          | 0    | 0    | 2286       | 1842 | 1221  |
| -----                     |                              |      |      |             |      |      |            |      |      |            |      |       |
| Capacity Analysis Module: |                              |      |      |             |      |      |            |      |      |            |      |       |
| Vol/Sat:                  | 0.36                         | 0.36 | 0.00 | 0.00        | 0.80 | 0.80 | 0.00       | 0.00 | 0.00 | 0.25       | 0.25 | 0.25  |
| Crit Moves:               | *****                        |      |      |             |      |      |            |      |      |            |      |       |
| Green Time:               | 86.4                         | 86.4 | 0.0  | 0.0         | 86.4 | 86.4 | 0.0        | 0.0  | 0.0  | 27.6       | 27.6 | 27.6  |
| Volume/Cap:               | 0.50                         | 0.50 | 0.00 | 0.00        | 1.11 | 1.11 | 0.00       | 0.00 | 0.00 | 1.11       | 1.11 | 1.11  |
| Delay/Veh:                | 7.7                          | 7.7  | 0.0  | 0.0         | 76.4 | 76.4 | 0.0        | 0.0  | 0.0  | 106.3      | 106  | 106.3 |
| User DelAdj:              | 1.00                         | 1.00 | 1.00 | 1.00        | 1.00 | 1.00 | 1.00       | 1.00 | 1.00 | 1.00       | 1.00 | 1.00  |
| AdjDel/Veh:               | 7.7                          | 7.7  | 0.0  | 0.0         | 76.4 | 76.4 | 0.0        | 0.0  | 0.0  | 106.3      | 106  | 106.3 |
| LOS by Move:              | A                            | A    | A    | A           | E    | E    | A          | A    | A    | F          | F    | F     |
| HCM2k95thQ:               | 19                           | 19   | 0    | 0           | 109  | 109  | 0          | 0    | 0    | 45         | 45   | 45    |

Note: Queue reported is the number of cars per lane.

BART

Level Of Service Computation Report  
 2000 HCM Operations (Future Volume Alternative)  
 AM - Mitigated Bkgrd + Proj

Intersection #9: Coleman/Brokaw [Study Int 33]

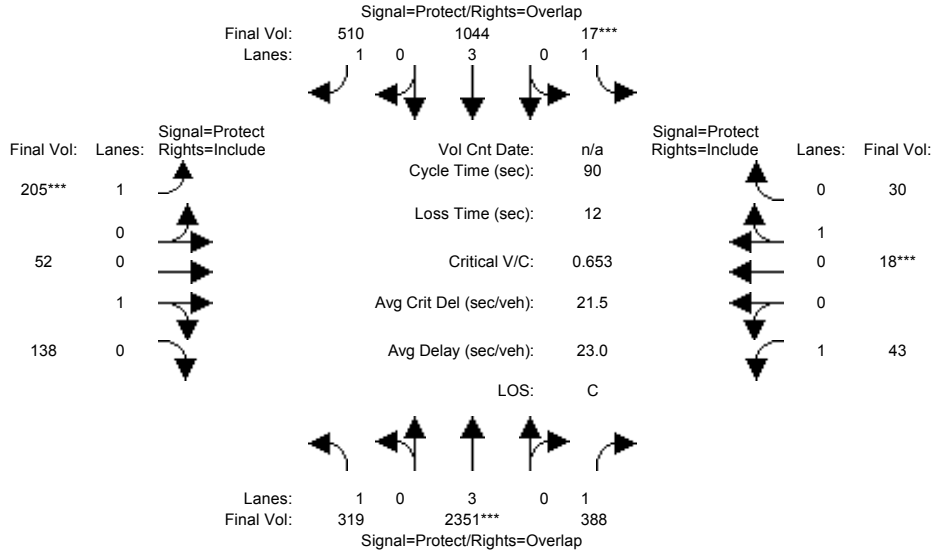

| Approach:                 | North Bound |      |      | South Bound |      |      | East Bound |      |      | West Bound |      |      |
|---------------------------|-------------|------|------|-------------|------|------|------------|------|------|------------|------|------|
|                           | L           | T    | R    | L           | T    | R    | L          | T    | R    | L          | T    | R    |
| Min. Green:               | 7           | 10   | 10   | 7           | 10   | 10   | 7          | 10   | 10   | 7          | 10   | 10   |
| Y+R:                      | 4.0         | 4.0  | 4.0  | 4.0         | 4.0  | 4.0  | 4.0        | 4.0  | 4.0  | 4.0        | 4.0  | 4.0  |
| Volume Module:            |             |      |      |             |      |      |            |      |      |            |      |      |
| Base Vol:                 | 319         | 2351 | 388  | 17          | 1044 | 510  | 205        | 52   | 138  | 43         | 18   | 30   |
| Growth Adj:               | 1.00        | 1.00 | 1.00 | 1.00        | 1.00 | 1.00 | 1.00       | 1.00 | 1.00 | 1.00       | 1.00 | 1.00 |
| Initial Bse:              | 319         | 2351 | 388  | 17          | 1044 | 510  | 205        | 52   | 138  | 43         | 18   | 30   |
| Added Vol:                | 0           | 0    | 0    | 0           | 0    | 0    | 0          | 0    | 0    | 0          | 0    | 0    |
| PasserByVol:              | 0           | 0    | 0    | 0           | 0    | 0    | 0          | 0    | 0    | 0          | 0    | 0    |
| Initial Fut:              | 319         | 2351 | 388  | 17          | 1044 | 510  | 205        | 52   | 138  | 43         | 18   | 30   |
| User Adj:                 | 1.00        | 1.00 | 1.00 | 1.00        | 1.00 | 1.00 | 1.00       | 1.00 | 1.00 | 1.00       | 1.00 | 1.00 |
| PHF Adj:                  | 1.00        | 1.00 | 1.00 | 1.00        | 1.00 | 1.00 | 1.00       | 1.00 | 1.00 | 1.00       | 1.00 | 1.00 |
| PHF Volume:               | 319         | 2351 | 388  | 17          | 1044 | 510  | 205        | 52   | 138  | 43         | 18   | 30   |
| Reduct Vol:               | 0           | 0    | 0    | 0           | 0    | 0    | 0          | 0    | 0    | 0          | 0    | 0    |
| Reduced Vol:              | 319         | 2351 | 388  | 17          | 1044 | 510  | 205        | 52   | 138  | 43         | 18   | 30   |
| PCE Adj:                  | 1.00        | 1.00 | 1.00 | 1.00        | 1.00 | 1.00 | 1.00       | 1.00 | 1.00 | 1.00       | 1.00 | 1.00 |
| MLF Adj:                  | 1.00        | 1.00 | 1.00 | 1.00        | 1.00 | 1.00 | 1.00       | 1.00 | 1.00 | 1.00       | 1.00 | 1.00 |
| FinalVolume:              | 319         | 2351 | 388  | 17          | 1044 | 510  | 205        | 52   | 138  | 43         | 18   | 30   |
| Saturation Flow Module:   |             |      |      |             |      |      |            |      |      |            |      |      |
| Sat/Lane:                 | 1900        | 1900 | 1900 | 1900        | 1900 | 1900 | 1900       | 1900 | 1900 | 1900       | 1900 | 1900 |
| Adjustment:               | 0.92        | 1.00 | 0.92 | 0.92        | 1.00 | 0.92 | 0.92       | 0.95 | 0.95 | 0.92       | 0.95 | 0.95 |
| Lanes:                    | 1.00        | 3.00 | 1.00 | 1.00        | 3.00 | 1.00 | 1.00       | 0.27 | 0.73 | 1.00       | 0.37 | 0.63 |
| Final Sat.:               | 1750        | 5700 | 1750 | 1750        | 5700 | 1750 | 1750       | 493  | 1307 | 1750       | 675  | 1125 |
| Capacity Analysis Module: |             |      |      |             |      |      |            |      |      |            |      |      |
| Vol/Sat:                  | 0.18        | 0.41 | 0.22 | 0.01        | 0.18 | 0.29 | 0.12       | 0.11 | 0.11 | 0.02       | 0.03 | 0.03 |
| Crit Moves:               | ****        | **** | **** | ****        | **** | **** | ****       | **** | **** | ****       | **** | **** |
| Green Time:               | 27.2        | 47.5 | 57.2 | 7.0         | 27.3 | 40.8 | 13.5       | 13.8 | 13.8 | 9.7        | 10.0 | 10.0 |
| Volume/Cap:               | 0.60        | 0.78 | 0.35 | 0.12        | 0.60 | 0.64 | 0.78       | 0.69 | 0.69 | 0.23       | 0.24 | 0.24 |
| Delay/Veh:                | 28.8        | 18.5 | 7.9  | 39.1        | 27.3 | 20.8 | 50.9       | 43.1 | 43.1 | 37.4       | 37.2 | 37.2 |
| User DelAdj:              | 1.00        | 1.00 | 1.00 | 1.00        | 1.00 | 1.00 | 1.00       | 1.00 | 1.00 | 1.00       | 1.00 | 1.00 |
| AdjDel/Veh:               | 28.8        | 18.5 | 7.9  | 39.1        | 27.3 | 20.8 | 50.9       | 43.1 | 43.1 | 37.4       | 37.2 | 37.2 |
| LOS by Move:              | C           | B    | A    | D           | C    | C    | D          | D    | D    | D          | D    | D    |
| HCM2k95hQ:                | 14          | 28   | 10   | 1           | 15   | 21   | 15         | 13   | 13   | 2          | 3    | 3    |

Note: Queue reported is the number of cars per lane.



BART

Level Of Service Computation Report  
 2000 HCM Operations (Future Volume Alternative)  
 PM - Mitigated Bkgrd + Proj

Intersection #9: Coleman/Brokaw [Study Int 33]

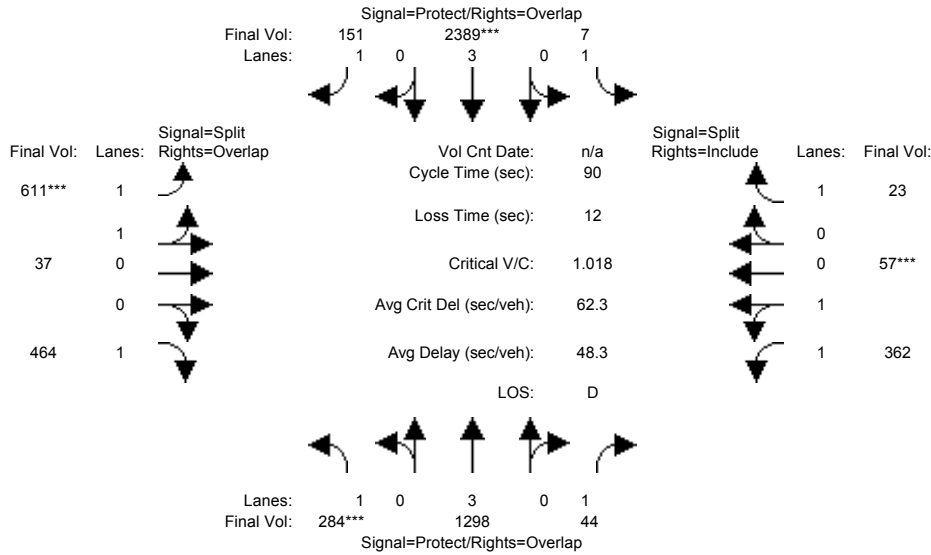

| Approach:                 | North Bound |      |      | South Bound |      |      | East Bound |      |      | West Bound |      |      |
|---------------------------|-------------|------|------|-------------|------|------|------------|------|------|------------|------|------|
| Movement:                 | L           | T    | R    | L           | T    | R    | L          | T    | R    | L          | T    | R    |
| Min. Green:               | 7           | 10   | 10   | 7           | 10   | 10   | 7          | 10   | 10   | 7          | 10   | 10   |
| Y+R:                      | 4.0         | 4.0  | 4.0  | 4.0         | 4.0  | 4.0  | 4.0        | 4.0  | 4.0  | 4.0        | 4.0  | 4.0  |
| Volume Module:            |             |      |      |             |      |      |            |      |      |            |      |      |
| Base Vol:                 | 284         | 1298 | 44   | 7           | 2389 | 151  | 611        | 37   | 464  | 362        | 57   | 23   |
| Growth Adj:               | 1.00        | 1.00 | 1.00 | 1.00        | 1.00 | 1.00 | 1.00       | 1.00 | 1.00 | 1.00       | 1.00 | 1.00 |
| Initial Bse:              | 284         | 1298 | 44   | 7           | 2389 | 151  | 611        | 37   | 464  | 362        | 57   | 23   |
| Added Vol:                | 0           | 0    | 0    | 0           | 0    | 0    | 0          | 0    | 0    | 0          | 0    | 0    |
| PasserByVol:              | 0           | 0    | 0    | 0           | 0    | 0    | 0          | 0    | 0    | 0          | 0    | 0    |
| Initial Fut:              | 284         | 1298 | 44   | 7           | 2389 | 151  | 611        | 37   | 464  | 362        | 57   | 23   |
| User Adj:                 | 1.00        | 1.00 | 1.00 | 1.00        | 1.00 | 1.00 | 1.00       | 1.00 | 1.00 | 1.00       | 1.00 | 1.00 |
| PHF Adj:                  | 1.00        | 1.00 | 1.00 | 1.00        | 1.00 | 1.00 | 1.00       | 1.00 | 1.00 | 1.00       | 1.00 | 1.00 |
| PHF Volume:               | 284         | 1298 | 44   | 7           | 2389 | 151  | 611        | 37   | 464  | 362        | 57   | 23   |
| Reduct Vol:               | 0           | 0    | 0    | 0           | 0    | 0    | 0          | 0    | 0    | 0          | 0    | 0    |
| Reduced Vol:              | 284         | 1298 | 44   | 7           | 2389 | 151  | 611        | 37   | 464  | 362        | 57   | 23   |
| PCE Adj:                  | 1.00        | 1.00 | 1.00 | 1.00        | 1.00 | 1.00 | 1.00       | 1.00 | 1.00 | 1.00       | 1.00 | 1.00 |
| MLF Adj:                  | 1.00        | 1.00 | 1.00 | 1.00        | 1.00 | 1.00 | 1.00       | 1.00 | 1.00 | 1.00       | 1.00 | 1.00 |
| Final Volume:             | 284         | 1298 | 44   | 7           | 2389 | 151  | 611        | 37   | 464  | 362        | 57   | 23   |
| Saturation Flow Module:   |             |      |      |             |      |      |            |      |      |            |      |      |
| Sat/Lane:                 | 1900        | 1900 | 1900 | 1900        | 1900 | 1900 | 1900       | 1900 | 1900 | 1900       | 1900 | 1900 |
| Adjustment:               | 0.92        | 1.00 | 0.92 | 0.92        | 1.00 | 0.92 | 0.93       | 0.95 | 0.92 | 0.93       | 0.95 | 0.92 |
| Lanes:                    | 1.00        | 3.00 | 1.00 | 1.00        | 3.00 | 1.00 | 1.89       | 0.11 | 1.00 | 1.73       | 0.27 | 1.00 |
| Final Sat.:               | 1750        | 5700 | 1750 | 1750        | 5700 | 1750 | 3347       | 203  | 1750 | 3067       | 483  | 1750 |
| Capacity Analysis Module: |             |      |      |             |      |      |            |      |      |            |      |      |
| Vol/Sat:                  | 0.16        | 0.23 | 0.03 | 0.00        | 0.42 | 0.09 | 0.18       | 0.18 | 0.27 | 0.12       | 0.12 | 0.01 |
| Crit Moves:               | ****        |      |      | ****        |      |      | ****       |      |      | ****       |      |      |
| Green Time:               | 14.4        | 38.3 | 48.8 | 13.1        | 37.1 | 53.2 | 16.1       | 16.1 | 30.5 | 10.4       | 10.4 | 10.4 |
| Volume/Cap:               | 1.02        | 0.53 | 0.05 | 0.03        | 1.02 | 0.15 | 1.02       | 1.02 | 0.78 | 1.02       | 1.02 | 0.11 |
| Delay/Veh:                | 96.3        | 19.4 | 9.7  | 33.0        | 49.6 | 8.3  | 77.1       | 77.1 | 33.5 | 88.7       | 88.7 | 35.9 |
| User DelAdj:              | 1.00        | 1.00 | 1.00 | 1.00        | 1.00 | 1.00 | 1.00       | 1.00 | 1.00 | 1.00       | 1.00 | 1.00 |
| AdjDel/Veh:               | 96.3        | 19.4 | 9.7  | 33.0        | 49.6 | 8.3  | 77.1       | 77.1 | 33.5 | 88.7       | 88.7 | 35.9 |
| LOS by Move:              | F           | B    | A    | C           | D    | A    | E          | E    | C    | F          | F    | D    |
| HCM2k95thQ:               | 21          | 16   | 1    | 0           | 46   | 4    | 27         | 27   | 25   | 16         | 16   | 1    |

Note: Queue reported is the number of cars per lane.

BART

Level Of Service Computation Report  
2000 HCM Operations (Future Volume Alternative)  
AM - Mitigated Cumulative Proj

Intersection #9: Coleman/Brokaw [Study Int 33]

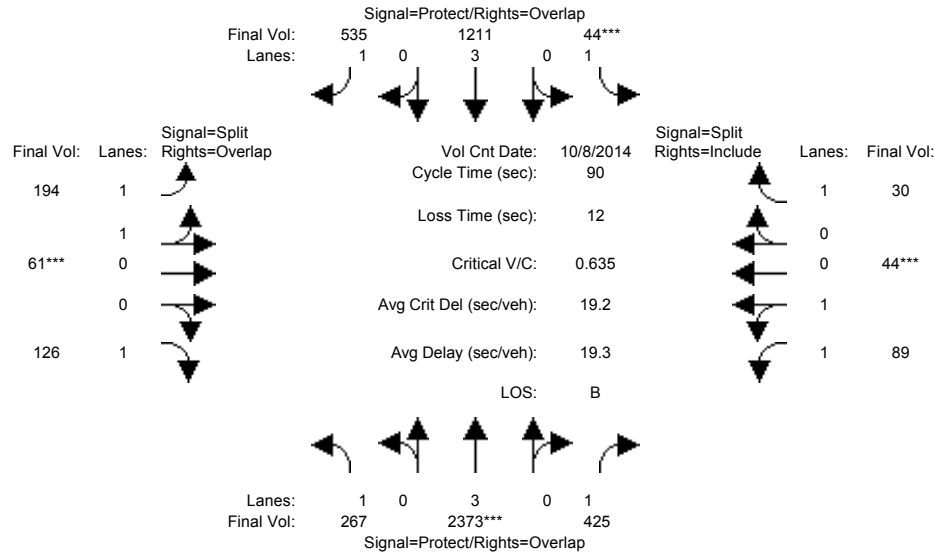

| Approach:                                   | North Bound |      |      | South Bound |      |      | East Bound |      |      | West Bound |      |      |
|---|-------------|------|------|-------------|------|------|------------|------|------|------------|------|------|
| Movement:                                   | L           | T    | R    | L           | T    | R    | L          | T    | R    | L          | T    | R    |
| Min. Green:                                 | 7           | 10   | 10   | 7           | 10   | 10   | 7          | 10   | 10   | 7          | 10   | 10   |
| Y+R:  | 4.0         | 4.0  | 4.0  | 4.0         | 4.0  | 4.0  | 4.0        | 4.0  | 4.0  | 4.0        | 4.0  | 4.0  |
| Volume Module: >> Count Date: 8 Oct 2014 << |             |      |      |             |      |      |            |      |      |            |      |      |
| Base Vol:                                   | 267         | 2373 | 425  | 44          | 1211 | 535  | 194        | 61   | 126  | 89         | 44   | 30   |
| Growth Adj:                                 | 1.00        | 1.00 | 1.00 | 1.00        | 1.00 | 1.00 | 1.00       | 1.00 | 1.00 | 1.00       | 1.00 | 1.00 |
| Initial Bse:                                | 267         | 2373 | 425  | 44          | 1211 | 535  | 194        | 61   | 126  | 89         | 44   | 30   |
| Added Vol:                                  | 0           | 0    | 0    | 0           | 0    | 0    | 0          | 0    | 0    | 0          | 0    | 0    |
| PasserByVol:                                | 0           | 0    | 0    | 0           | 0    | 0    | 0          | 0    | 0    | 0          | 0    | 0    |
| Initial Fut:                                | 267         | 2373 | 425  | 44          | 1211 | 535  | 194        | 61   | 126  | 89         | 44   | 30   |
| User Adj:                                   | 1.00        | 1.00 | 1.00 | 1.00        | 1.00 | 1.00 | 1.00       | 1.00 | 1.00 | 1.00       | 1.00 | 1.00 |
| PHF Adj:                                    | 1.00        | 1.00 | 1.00 | 1.00        | 1.00 | 1.00 | 1.00       | 1.00 | 1.00 | 1.00       | 1.00 | 1.00 |
| PHF Volume:                                 | 267         | 2373 | 425  | 44          | 1211 | 535  | 194        | 61   | 126  | 89         | 44   | 30   |
| Reduct Vol:                                 | 0           | 0    | 0    | 0           | 0    | 0    | 0          | 0    | 0    | 0          | 0    | 0    |
| Reduced Vol:                                | 267         | 2373 | 425  | 44          | 1211 | 535  | 194        | 61   | 126  | 89         | 44   | 30   |
| PCE Adj:                                    | 1.00        | 1.00 | 1.00 | 1.00        | 1.00 | 1.00 | 1.00       | 1.00 | 1.00 | 1.00       | 1.00 | 1.00 |
| MLF Adj:                                    | 1.00        | 1.00 | 1.00 | 1.00        | 1.00 | 1.00 | 1.00       | 1.00 | 1.00 | 1.00       | 1.00 | 1.00 |
| Final Volume:                               | 267         | 2373 | 425  | 44          | 1211 | 535  | 194        | 61   | 126  | 89         | 44   | 30   |
| Saturation Flow Module:                     |             |      |      |             |      |      |            |      |      |            |      |      |
| Sat/Lane:                                   | 1900        | 1900 | 1900 | 1900        | 1900 | 1900 | 1900       | 1900 | 1900 | 1900       | 1900 | 1900 |
| Adjustment:                                 | 0.92        | 1.00 | 0.92 | 0.92        | 1.00 | 0.92 | 0.93       | 0.95 | 0.92 | 0.93       | 0.95 | 0.92 |
| Lanes:                                      | 1.00        | 3.00 | 1.00 | 1.00        | 3.00 | 1.00 | 1.53       | 0.47 | 1.00 | 1.35       | 0.65 | 1.00 |
| Final Sat.:                                 | 1750        | 5700 | 1750 | 1750        | 5700 | 1750 | 2701       | 849  | 1750 | 2375       | 1174 | 1750 |
| Capacity Analysis Module:                   |             |      |      |             |      |      |            |      |      |            |      |      |
| Vol/Sat:                                    | 0.15        | 0.42 | 0.24 | 0.03        | 0.21 | 0.31 | 0.07       | 0.07 | 0.07 | 0.04       | 0.04 | 0.02 |
| Crit Moves:                                 | ****        | **** | **** | ****        | **** | **** | ****       | **** | **** | ****       | **** | **** |
| Green Time:                                 | 22.9        | 51.0 | 61.0 | 7.0         | 35.1 | 45.1 | 10.0       | 10.0 | 32.9 | 10.0       | 10.0 | 10.0 |
| Volume/Cap:                                 | 0.60        | 0.73 | 0.36 | 0.32        | 0.54 | 0.61 | 0.65       | 0.65 | 0.20 | 0.34       | 0.34 | 0.15 |
| Delay/Veh:                                  | 31.8        | 15.4 | 6.4  | 40.6        | 21.5 | 17.4 | 42.0       | 42.0 | 19.7 | 37.4       | 37.4 | 36.5 |
| User DelAdj:                                | 1.00        | 1.00 | 1.00 | 1.00        | 1.00 | 1.00 | 1.00       | 1.00 | 1.00 | 1.00       | 1.00 | 1.00 |
| AdjDel/Veh:                                 | 31.8        | 15.4 | 6.4  | 40.6        | 21.5 | 17.4 | 42.0       | 42.0 | 19.7 | 37.4       | 37.4 | 36.5 |
| LOS by Move:                                | C           | B    | A    | D           | C    | B    | D          | D    | B    | D          | D    | D    |
| HCM2k95thQ:                                 | 12          | 26   | 10   | 3           | 16   | 21   | 9          | 9    | 5    | 4          | 4    | 2    |

Note: Queue reported is the number of cars per lane.

BART

Level Of Service Computation Report  
2000 HCM Operations (Future Volume Alternative)  
PM - Mitigated Cumulative Proj

Intersection #9: Coleman/Brokaw [Study Int 33]

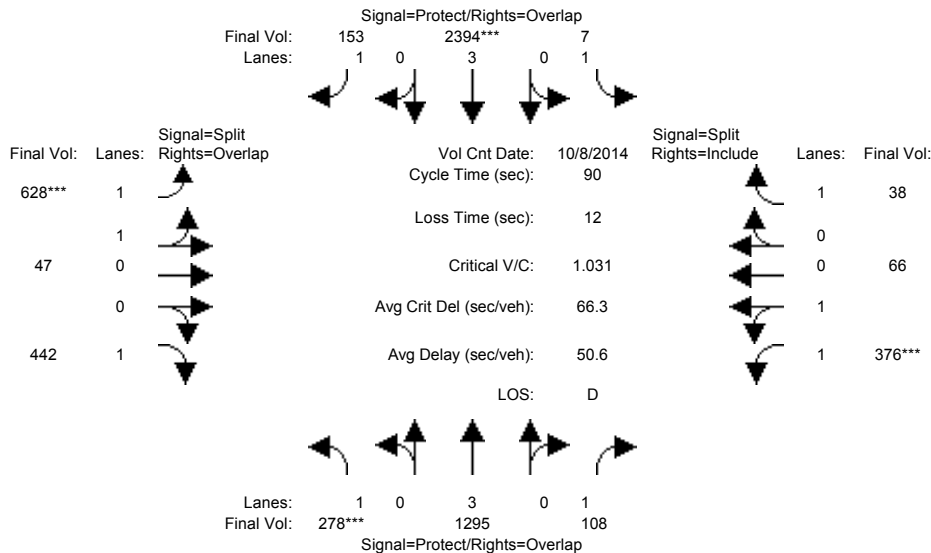

| Approach:                                   | North Bound |      |      | South Bound |      |      | East Bound |      |      | West Bound |      |      |
|---|-------------|------|------|-------------|------|------|------------|------|------|------------|------|------|
| Movement:                                   | L           | T    | R    | L           | T    | R    | L          | T    | R    | L          | T    | R    |
| Min. Green:                                 | 7           | 10   | 10   | 7           | 10   | 10   | 7          | 10   | 10   | 7          | 10   | 10   |
| Y+R:  | 4.0         | 4.0  | 4.0  | 4.0         | 4.0  | 4.0  | 4.0        | 4.0  | 4.0  | 4.0        | 4.0  | 4.0  |
| Volume Module: >> Count Date: 8 Oct 2014 << |             |      |      |             |      |      |            |      |      |            |      |      |
| Base Vol:                                   | 278         | 1295 | 108  | 7           | 2394 | 153  | 628        | 47   | 442  | 376        | 66   | 38   |
| Growth Adj:                                 | 1.00        | 1.00 | 1.00 | 1.00        | 1.00 | 1.00 | 1.00       | 1.00 | 1.00 | 1.00       | 1.00 | 1.00 |
| Initial Bse:                                | 278         | 1295 | 108  | 7           | 2394 | 153  | 628        | 47   | 442  | 376        | 66   | 38   |
| Added Vol:                                  | 0           | 0    | 0    | 0           | 0    | 0    | 0          | 0    | 0    | 0          | 0    | 0    |
| PasserByVol:                                | 0           | 0    | 0    | 0           | 0    | 0    | 0          | 0    | 0    | 0          | 0    | 0    |
| Initial Fut:                                | 278         | 1295 | 108  | 7           | 2394 | 153  | 628        | 47   | 442  | 376        | 66   | 38   |
| User Adj:                                   | 1.00        | 1.00 | 1.00 | 1.00        | 1.00 | 1.00 | 1.00       | 1.00 | 1.00 | 1.00       | 1.00 | 1.00 |
| PHF Adj:                                    | 1.00        | 1.00 | 1.00 | 1.00        | 1.00 | 1.00 | 1.00       | 1.00 | 1.00 | 1.00       | 1.00 | 1.00 |
| PHF Volume:                                 | 278         | 1295 | 108  | 7           | 2394 | 153  | 628        | 47   | 442  | 376        | 66   | 38   |
| Reduct Vol:                                 | 0           | 0    | 0    | 0           | 0    | 0    | 0          | 0    | 0    | 0          | 0    | 0    |
| Reduced Vol:                                | 278         | 1295 | 108  | 7           | 2394 | 153  | 628        | 47   | 442  | 376        | 66   | 38   |
| PCE Adj:                                    | 1.00        | 1.00 | 1.00 | 1.00        | 1.00 | 1.00 | 1.00       | 1.00 | 1.00 | 1.00       | 1.00 | 1.00 |
| MLF Adj:                                    | 1.00        | 1.00 | 1.00 | 1.00        | 1.00 | 1.00 | 1.00       | 1.00 | 1.00 | 1.00       | 1.00 | 1.00 |
| Final Volume:                               | 278         | 1295 | 108  | 7           | 2394 | 153  | 628        | 47   | 442  | 376        | 66   | 38   |
| Saturation Flow Module:                     |             |      |      |             |      |      |            |      |      |            |      |      |
| Sat/Lane:                                   | 1900        | 1900 | 1900 | 1900        | 1900 | 1900 | 1900       | 1900 | 1900 | 1900       | 1900 | 1900 |
| Adjustment:                                 | 0.92        | 1.00 | 0.92 | 0.92        | 1.00 | 0.92 | 0.93       | 0.95 | 0.92 | 0.93       | 0.95 | 0.92 |
| Lanes:                                      | 1.00        | 3.00 | 1.00 | 1.00        | 3.00 | 1.00 | 1.86       | 0.14 | 1.00 | 1.71       | 0.29 | 1.00 |
| Final Sat.:                                 | 1750        | 5700 | 1750 | 1750        | 5700 | 1750 | 3303       | 247  | 1750 | 3020       | 530  | 1750 |
| Capacity Analysis Module:                   |             |      |      |             |      |      |            |      |      |            |      |      |
| Vol/Sat:                                    | 0.16        | 0.23 | 0.06 | 0.00        | 0.42 | 0.09 | 0.19       | 0.19 | 0.25 | 0.12       | 0.12 | 0.02 |
| Crit Moves:                                 | ****        |      |      | ****        |      |      | ****       |      |      | ****       |      |      |
| Green Time:                                 | 13.9        | 37.6 | 48.5 | 12.9        | 36.7 | 53.3 | 16.6       | 16.6 | 30.5 | 10.9       | 10.9 | 10.9 |
| Volume/Cap:                                 | 1.03        | 0.54 | 0.11 | 0.03        | 1.03 | 0.15 | 1.03       | 1.03 | 0.75 | 1.03       | 1.03 | 0.18 |
| Delay/Veh:                                  | 101.1       | 20.0 | 10.2 | 33.2        | 53.8 | 8.3  | 80.1       | 80.1 | 31.5 | 91.2       | 91.2 | 36.0 |
| User DelAdj:                                | 1.00        | 1.00 | 1.00 | 1.00        | 1.00 | 1.00 | 1.00       | 1.00 | 1.00 | 1.00       | 1.00 | 1.00 |
| AdjDel/Veh:                                 | 101.1       | 20.0 | 10.2 | 33.2        | 53.8 | 8.3  | 80.1       | 80.1 | 31.5 | 91.2       | 91.2 | 36.0 |
| LOS by Move:                                | F           | B    | B    | C           | D    | A    | F          | F    | C    | F          | F    | D    |
| HCM2k95thQ:                                 | 21          | 16   | 3    | 0           | 47   | 4    | 29         | 29   | 24   | 17         | 17   | 2    |

Note: Queue reported is the number of cars per lane.

BART

Level Of Service Computation Report  
 2000 HCM Operations (Future Volume Alternative)  
 AM - Mitigated Bkgrd + Proj

Intersection #3052: 880 SB Ramps/Coleman [Study Int 36]

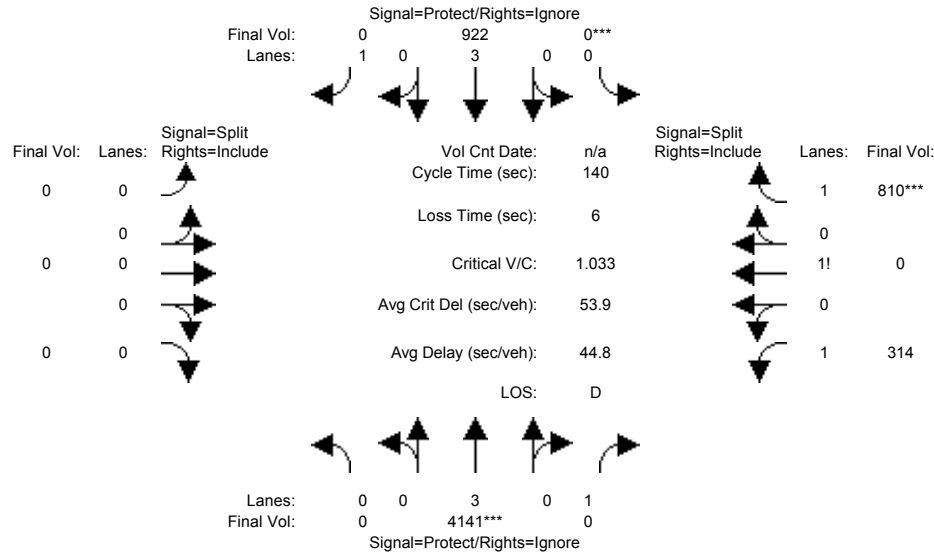

| Approach:                 | North Bound |      |      | South Bound |      |      | East Bound |      |      | West Bound |      |      |
|---------------------------|-------------|------|------|-------------|------|------|------------|------|------|------------|------|------|
| Movement:                 | L           | T    | R    | L           | T    | R    | L          | T    | R    | L          | T    | R    |
| Min. Green:               | 0           | 10   | 10   | 0           | 10   | 10   | 0          | 0    | 0    | 10         | 0    | 10   |
| Y+R:                      | 4.0         | 4.0  | 4.0  | 4.0         | 4.0  | 4.0  | 4.0        | 4.0  | 4.0  | 4.0        | 4.0  | 4.0  |
| Volume Module:            |             |      |      |             |      |      |            |      |      |            |      |      |
| Base Vol:                 | 0           | 4141 | 179  | 0           | 922  | 193  | 0          | 0    | 0    | 314        | 0    | 810  |
| Growth Adj:               | 1.00        | 1.00 | 1.00 | 1.00        | 1.00 | 1.00 | 1.00       | 1.00 | 1.00 | 1.00       | 1.00 | 1.00 |
| Initial Bse:              | 0           | 4141 | 179  | 0           | 922  | 193  | 0          | 0    | 0    | 314        | 0    | 810  |
| Added Vol:                | 0           | 0    | 0    | 0           | 0    | 0    | 0          | 0    | 0    | 0          | 0    | 0    |
| PasserByVol:              | 0           | 0    | 0    | 0           | 0    | 0    | 0          | 0    | 0    | 0          | 0    | 0    |
| Initial Fut:              | 0           | 4141 | 179  | 0           | 922  | 193  | 0          | 0    | 0    | 314        | 0    | 810  |
| User Adj:                 | 1.00        | 1.00 | 0.00 | 1.00        | 1.00 | 0.00 | 1.00       | 1.00 | 1.00 | 1.00       | 1.00 | 1.00 |
| PHF Adj:                  | 1.00        | 1.00 | 0.00 | 1.00        | 1.00 | 0.00 | 1.00       | 1.00 | 1.00 | 1.00       | 1.00 | 1.00 |
| PHF Volume:               | 0           | 4141 | 0    | 0           | 922  | 0    | 0          | 0    | 0    | 314        | 0    | 810  |
| Reduct Vol:               | 0           | 0    | 0    | 0           | 0    | 0    | 0          | 0    | 0    | 0          | 0    | 0    |
| Reduced Vol:              | 0           | 4141 | 0    | 0           | 922  | 0    | 0          | 0    | 0    | 314        | 0    | 810  |
| PCE Adj:                  | 1.00        | 1.00 | 0.00 | 1.00        | 1.00 | 0.00 | 1.00       | 1.00 | 1.00 | 1.00       | 1.00 | 1.00 |
| MLF Adj:                  | 1.00        | 1.00 | 0.00 | 1.00        | 1.00 | 0.00 | 1.00       | 1.00 | 1.00 | 1.00       | 1.00 | 1.00 |
| Final Volume:             | 0           | 4141 | 0    | 0           | 922  | 0    | 0          | 0    | 0    | 314        | 0    | 810  |
| Saturation Flow Module:   |             |      |      |             |      |      |            |      |      |            |      |      |
| Sat/Lane:                 | 1900        | 1900 | 1900 | 1900        | 1900 | 1900 | 1900       | 1900 | 1900 | 1900       | 1900 | 1900 |
| Adjustment:               | 0.92        | 1.00 | 0.92 | 0.92        | 1.00 | 0.92 | 0.92       | 1.00 | 0.92 | 0.92       | 1.00 | 0.95 |
| Lanes:                    | 0.00        | 3.00 | 1.00 | 0.00        | 3.00 | 1.00 | 0.00       | 0.00 | 0.00 | 1.29       | 0.00 | 1.71 |
| Final Sat.:               | 0           | 5700 | 1750 | 0           | 5700 | 1750 | 0          | 0    | 0    | 2249       | 0    | 3087 |
| Capacity Analysis Module: |             |      |      |             |      |      |            |      |      |            |      |      |
| Vol/Sat:                  | 0.00        | 0.73 | 0.00 | 0.00        | 0.16 | 0.00 | 0.00       | 0.00 | 0.00 | 0.14       | 0.00 | 0.26 |
| Crit Moves:               | ****        | **** | **** | ****        | **** | **** | ****       | **** | **** | ****       | **** | **** |
| Green Time:               | 0.0         | 98.4 | 0.0  | 0.0         | 98.4 | 0.0  | 0.0        | 0.0  | 0.0  | 35.6       | 0.0  | 35.6 |
| Volume/Cap:               | 0.00        | 1.03 | 0.00 | 0.00        | 0.23 | 0.00 | 0.00       | 0.00 | 0.00 | 0.55       | 0.00 | 1.03 |
| Delay/Veh:                | 0.0         | 44.5 | 0.0  | 0.0         | 7.4  | 0.0  | 0.0        | 0.0  | 0.0  | 45.6       | 0.0  | 88.4 |
| User DelAdj:              | 1.00        | 1.00 | 1.00 | 1.00        | 1.00 | 1.00 | 1.00       | 1.00 | 1.00 | 1.00       | 1.00 | 1.00 |
| AdjDel/Veh:               | 0.0         | 44.5 | 0.0  | 0.0         | 7.4  | 0.0  | 0.0        | 0.0  | 0.0  | 45.6       | 0.0  | 88.4 |
| LOS by Move:              | A           | D    | A    | A           | A    | A    | A          | A    | A    | D          | A    | F    |
| HCM2k95thQ:               | 0           | 106  | 0    | 0           | 9    | 0    | 0          | 0    | 0    | 19         | 0    | 46   |

Note: Queue reported is the number of cars per lane.

BART

Level Of Service Computation Report  
 2000 HCM Operations (Future Volume Alternative)  
 PM - Mitigated Bkgrd + Proj

Intersection #3052: 880 SB Ramps/Coleman [Study Int 36]

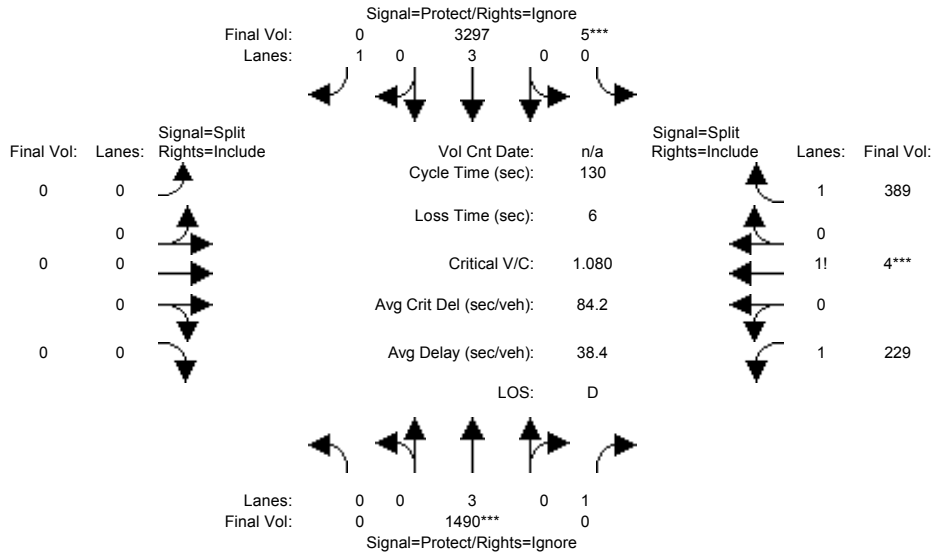

| Approach:                 | North Bound |      |      | South Bound |      |      | East Bound |      |      | West Bound |      |      |
|---------------------------|-------------|------|------|-------------|------|------|------------|------|------|------------|------|------|
| Movement:                 | L           | T    | R    | L           | T    | R    | L          | T    | R    | L          | T    | R    |
| Min. Green:               | 0           | 10   | 10   | 0           | 10   | 10   | 0          | 0    | 0    | 10         | 0    | 10   |
| Y+R:                      | 4.0         | 4.0  | 4.0  | 4.0         | 4.0  | 4.0  | 4.0        | 4.0  | 4.0  | 4.0        | 4.0  | 4.0  |
| Volume Module:            |             |      |      |             |      |      |            |      |      |            |      |      |
| Base Vol:                 | 0           | 1490 | 301  | 5           | 3297 | 773  | 0          | 0    | 0    | 229        | 4    | 389  |
| Growth Adj:               | 1.00        | 1.00 | 1.00 | 1.00        | 1.00 | 1.00 | 1.00       | 1.00 | 1.00 | 1.00       | 1.00 | 1.00 |
| Initial Bse:              | 0           | 1490 | 301  | 5           | 3297 | 773  | 0          | 0    | 0    | 229        | 4    | 389  |
| Added Vol:                | 0           | 0    | 0    | 0           | 0    | 0    | 0          | 0    | 0    | 0          | 0    | 0    |
| PasserByVol:              | 0           | 0    | 0    | 0           | 0    | 0    | 0          | 0    | 0    | 0          | 0    | 0    |
| Initial Fut:              | 0           | 1490 | 301  | 5           | 3297 | 773  | 0          | 0    | 0    | 229        | 4    | 389  |
| User Adj:                 | 1.00        | 1.00 | 0.00 | 1.00        | 1.00 | 0.00 | 1.00       | 1.00 | 1.00 | 1.00       | 1.00 | 1.00 |
| PHF Adj:                  | 1.00        | 1.00 | 0.00 | 1.00        | 1.00 | 0.00 | 1.00       | 1.00 | 1.00 | 1.00       | 1.00 | 1.00 |
| PHF Volume:               | 0           | 1490 | 0    | 5           | 3297 | 0    | 0          | 0    | 0    | 229        | 4    | 389  |
| Reduct Vol:               | 0           | 0    | 0    | 0           | 0    | 0    | 0          | 0    | 0    | 0          | 0    | 0    |
| Reduced Vol:              | 0           | 1490 | 0    | 5           | 3297 | 0    | 0          | 0    | 0    | 229        | 4    | 389  |
| PCE Adj:                  | 1.00        | 1.00 | 0.00 | 1.00        | 1.00 | 0.00 | 1.00       | 1.00 | 1.00 | 1.00       | 1.00 | 1.00 |
| MLF Adj:                  | 1.00        | 1.00 | 0.00 | 1.00        | 1.00 | 0.00 | 1.00       | 1.00 | 1.00 | 1.00       | 1.00 | 1.00 |
| FinalVolume:              | 0           | 1490 | 0    | 5           | 3297 | 0    | 0          | 0    | 0    | 229        | 4    | 389  |
| Saturation Flow Module:   |             |      |      |             |      |      |            |      |      |            |      |      |
| Sat/Lane:                 | 1900        | 1900 | 1900 | 1900        | 1900 | 1900 | 1900       | 1900 | 1900 | 1900       | 1900 | 1900 |
| Adjustment:               | 0.92        | 1.00 | 0.92 | 0.95        | 0.98 | 0.92 | 0.92       | 1.00 | 0.92 | 0.92       | 0.92 | 0.92 |
| Lanes:                    | 0.00        | 3.00 | 1.00 | 0.01        | 2.99 | 1.00 | 0.00       | 0.00 | 0.00 | 1.37       | 0.01 | 1.62 |
| Final Sat.:               | 0           | 5700 | 1750 | 8           | 5592 | 1750 | 0          | 0    | 0    | 2390       | 22   | 2837 |
| Capacity Analysis Module: |             |      |      |             |      |      |            |      |      |            |      |      |
| Vol/Sat:                  | 0.00        | 0.26 | 0.00 | 0.59        | 0.59 | 0.00 | 0.00       | 0.00 | 0.00 | 0.10       | 0.18 | 0.14 |
| Crit Moves:               | ****        | **** | **** | ****        | **** | **** | ****       | **** | **** | ****       | **** | **** |
| Green Time:               | 0.0         | 31.5 | 0.0  | 71.0        | 102  | 0.0  | 0.0        | 0.0  | 0.0  | 21.5       | 21.5 | 21.5 |
| Volume/Cap:               | 0.00        | 1.08 | 0.00 | 1.08        | 0.75 | 0.00 | 0.00       | 0.00 | 0.00 | 0.58       | 1.08 | 0.83 |
| Delay/Veh:                | 0.0         | 98.1 | 0.0  | 72.1        | 7.8  | 0.0  | 0.0        | 0.0  | 0.0  | 50.8       | 115  | 60.0 |
| User DelAdj:              | 1.00        | 1.00 | 1.00 | 1.00        | 1.00 | 1.00 | 1.00       | 1.00 | 1.00 | 1.00       | 1.00 | 1.00 |
| AdjDel/Veh:               | 0.0         | 98.1 | 0.0  | 72.1        | 7.8  | 0.0  | 0.0        | 0.0  | 0.0  | 50.8       | 115  | 60.0 |
| LOS by Move:              | A           | F    | A    | E           | A    | A    | A          | A    | A    | D          | F    | E    |
| HCM2k95thQ:               | 0           | 46   | 0    | 88          | 40   | 0    | 0          | 0    | 0    | 14         | 35   | 22   |

Note: Queue reported is the number of cars per lane.

BART

Level Of Service Computation Report  
 2000 HCM Operations (Future Volume Alternative)  
 AM - Mitigated Cumulative Proj

Intersection #3052: 880 SB Ramps/Coleman [Study Int 36]

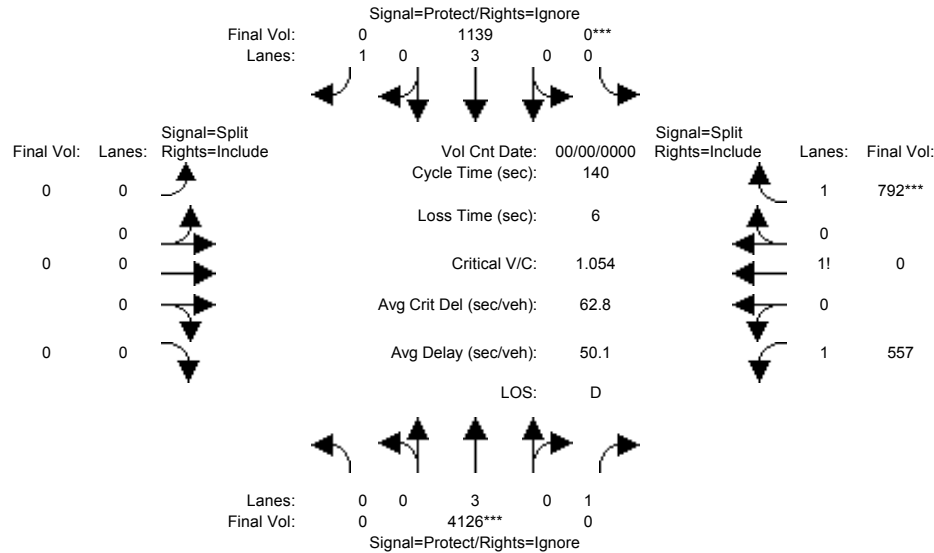

| Approach:                     | North Bound        |      |      | South Bound |      |      | East Bound |      |      | West Bound |      |      |
|-------------------------------|--------------------|------|------|-------------|------|------|------------|------|------|------------|------|------|
| Movement:                     | L                  | T    | R    | L           | T    | R    | L          | T    | R    | L          | T    | R    |
| Min. Green:                   | 0                  | 10   | 10   | 0           | 10   | 10   | 0          | 0    | 0    | 10         | 0    | 10   |
| Y+R:                          | 4.0                | 4.0  | 4.0  | 4.0         | 4.0  | 4.0  | 4.0        | 4.0  | 4.0  | 4.0        | 4.0  | 4.0  |
| Volume Module: >> Count Date: | 0 0 << 7:30-8:30AM |      |      |             |      |      |            |      |      |            |      |      |
| Base Vol:                     | 0                  | 4126 | 179  | 0           | 1139 | 193  | 0          | 0    | 0    | 557        | 0    | 792  |
| Growth Adj:                   | 1.00               | 1.00 | 1.00 | 1.00        | 1.00 | 1.00 | 1.00       | 1.00 | 1.00 | 1.00       | 1.00 | 1.00 |
| Initial Bse:                  | 0                  | 4126 | 179  | 0           | 1139 | 193  | 0          | 0    | 0    | 557        | 0    | 792  |
| Added Vol:                    | 0                  | 0    | 0    | 0           | 0    | 0    | 0          | 0    | 0    | 0          | 0    | 0    |
| PasserByVol:                  | 0                  | 0    | 0    | 0           | 0    | 0    | 0          | 0    | 0    | 0          | 0    | 0    |
| Initial Fut:                  | 0                  | 4126 | 179  | 0           | 1139 | 193  | 0          | 0    | 0    | 557        | 0    | 792  |
| User Adj:                     | 1.00               | 1.00 | 0.00 | 1.00        | 1.00 | 0.00 | 1.00       | 1.00 | 1.00 | 1.00       | 1.00 | 1.00 |
| PHF Adj:                      | 1.00               | 1.00 | 0.00 | 1.00        | 1.00 | 0.00 | 1.00       | 1.00 | 1.00 | 1.00       | 1.00 | 1.00 |
| PHF Volume:                   | 0                  | 4126 | 0    | 0           | 1139 | 0    | 0          | 0    | 0    | 557        | 0    | 792  |
| Reduct Vol:                   | 0                  | 0    | 0    | 0           | 0    | 0    | 0          | 0    | 0    | 0          | 0    | 0    |
| Reduced Vol:                  | 0                  | 4126 | 0    | 0           | 1139 | 0    | 0          | 0    | 0    | 557        | 0    | 792  |
| PCE Adj:                      | 1.00               | 1.00 | 0.00 | 1.00        | 1.00 | 0.00 | 1.00       | 1.00 | 1.00 | 1.00       | 1.00 | 1.00 |
| MLF Adj:                      | 1.00               | 1.00 | 0.00 | 1.00        | 1.00 | 0.00 | 1.00       | 1.00 | 1.00 | 1.00       | 1.00 | 1.00 |
| Final Volume:                 | 0                  | 4126 | 0    | 0           | 1139 | 0    | 0          | 0    | 0    | 557        | 0    | 792  |
| Saturation Flow Module:       |                    |      |      |             |      |      |            |      |      |            |      |      |
| Sat/Lane:                     | 1900               | 1900 | 1900 | 1900        | 1900 | 1900 | 1900       | 1900 | 1900 | 1900       | 1900 | 1900 |
| Adjustment:                   | 0.92               | 1.00 | 0.92 | 0.92        | 1.00 | 0.92 | 0.92       | 1.00 | 0.92 | 0.92       | 1.00 | 0.92 |
| Lanes:                        | 0.00               | 3.00 | 1.00 | 0.00        | 3.00 | 1.00 | 0.00       | 0.00 | 0.00 | 1.41       | 0.00 | 1.59 |
| Final Sat.:                   | 0                  | 5700 | 1750 | 0           | 5700 | 1750 | 0          | 0    | 0    | 2473       | 0    | 2777 |
| Capacity Analysis Module:     |                    |      |      |             |      |      |            |      |      |            |      |      |
| Vol/Sat:                      | 0.00               | 0.72 | 0.00 | 0.00        | 0.20 | 0.00 | 0.00       | 0.00 | 0.00 | 0.23       | 0.00 | 0.29 |
| Crit Moves:                   | ****               |      |      |             |      |      |            |      |      |            |      |      |
| Green Time:                   | 0.0                | 96.1 | 0.0  | 0.0         | 96.1 | 0.0  | 0.0        | 0.0  | 0.0  | 37.9       | 0.0  | 37.9 |
| Volume/Cap:                   | 0.00               | 1.05 | 0.00 | 0.00        | 0.29 | 0.00 | 0.00       | 0.00 | 0.00 | 0.83       | 0.00 | 1.05 |
| Delay/Veh:                    | 0.0                | 53.3 | 0.0  | 0.0         | 8.6  | 0.0  | 0.0        | 0.0  | 0.0  | 51.9       | 0.0  | 91.8 |
| User DelAdj:                  | 1.00               | 1.00 | 1.00 | 1.00        | 1.00 | 1.00 | 1.00       | 1.00 | 1.00 | 1.00       | 1.00 | 1.00 |
| AdjDel/Veh:                   | 0.0                | 53.3 | 0.0  | 0.0         | 8.6  | 0.0  | 0.0        | 0.0  | 0.0  | 51.9       | 0.0  | 91.8 |
| LOS by Move:                  | A                  | D    | A    | A           | A    | A    | A          | A    | A    | D          | A    | F    |
| HCM2k95thQ:                   | 0                  | 108  | 0    | 0           | 12   | 0    | 0          | 0    | 0    | 33         | 0    | 50   |

Note: Queue reported is the number of cars per lane.

BART

Level Of Service Computation Report  
 2000 HCM Operations (Future Volume Alternative)  
 PM - Mitigated Cumulative Proj

Intersection #3052: 880 SB Ramps/Coleman [Study Int 36]

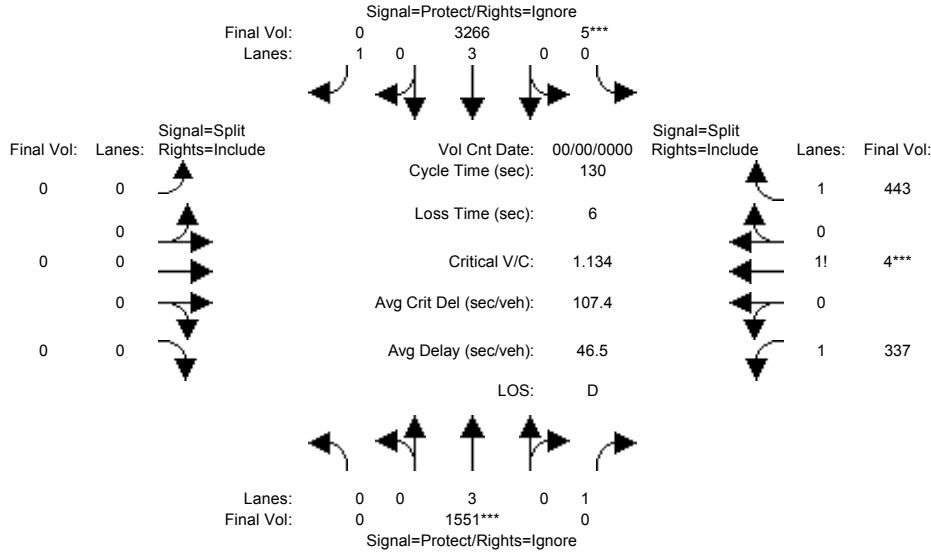

| Approach:                     | North Bound        |      |      | South Bound |      |      | East Bound |      |      | West Bound |      |      |
|-------------------------------|--------------------|------|------|-------------|------|------|------------|------|------|------------|------|------|
| Movement:                     | L                  | T    | R    | L           | T    | R    | L          | T    | R    | L          | T    | R    |
| Min. Green:                   | 0                  | 10   | 10   | 0           | 10   | 10   | 0          | 0    | 0    | 10         | 0    | 10   |
| Y+R:                          | 4.0                | 4.0  | 4.0  | 4.0         | 4.0  | 4.0  | 4.0        | 4.0  | 4.0  | 4.0        | 4.0  | 4.0  |
| Volume Module: >> Count Date: | 0 0 << 7:30-8:30AM |      |      |             |      |      |            |      |      |            |      |      |
| Base Vol:                     | 0                  | 1551 | 301  | 5           | 3266 | 773  | 0          | 0    | 0    | 337        | 4    | 443  |
| Growth Adj:                   | 1.00               | 1.00 | 1.00 | 1.00        | 1.00 | 1.00 | 1.00       | 1.00 | 1.00 | 1.00       | 1.00 | 1.00 |
| Initial Bse:                  | 0                  | 1551 | 301  | 5           | 3266 | 773  | 0          | 0    | 0    | 337        | 4    | 443  |
| Added Vol:                    | 0                  | 0    | 0    | 0           | 0    | 0    | 0          | 0    | 0    | 0          | 0    | 0    |
| PasserByVol:                  | 0                  | 0    | 0    | 0           | 0    | 0    | 0          | 0    | 0    | 0          | 0    | 0    |
| Initial Fut:                  | 0                  | 1551 | 301  | 5           | 3266 | 773  | 0          | 0    | 0    | 337        | 4    | 443  |
| User Adj:                     | 1.00               | 1.00 | 0.00 | 1.00        | 1.00 | 0.00 | 1.00       | 1.00 | 1.00 | 1.00       | 1.00 | 1.00 |
| PHF Adj:                      | 1.00               | 1.00 | 0.00 | 1.00        | 1.00 | 0.00 | 1.00       | 1.00 | 1.00 | 1.00       | 1.00 | 1.00 |
| PHF Volume:                   | 0                  | 1551 | 0    | 5           | 3266 | 0    | 0          | 0    | 0    | 337        | 4    | 443  |
| Reduct Vol:                   | 0                  | 0    | 0    | 0           | 0    | 0    | 0          | 0    | 0    | 0          | 0    | 0    |
| Reduced Vol:                  | 0                  | 1551 | 0    | 5           | 3266 | 0    | 0          | 0    | 0    | 337        | 4    | 443  |
| PCE Adj:                      | 1.00               | 1.00 | 0.00 | 1.00        | 1.00 | 0.00 | 1.00       | 1.00 | 1.00 | 1.00       | 1.00 | 1.00 |
| MLF Adj:                      | 1.00               | 1.00 | 0.00 | 1.00        | 1.00 | 0.00 | 1.00       | 1.00 | 1.00 | 1.00       | 1.00 | 1.00 |
| Final Volume:                 | 0                  | 1551 | 0    | 5           | 3266 | 0    | 0          | 0    | 0    | 337        | 4    | 443  |
| Saturation Flow Module:       |                    |      |      |             |      |      |            |      |      |            |      |      |
| Sat/Lane:                     | 1900               | 1900 | 1900 | 1900        | 1900 | 1900 | 1900       | 1900 | 1900 | 1900       | 1900 | 1900 |
| Adjustment:                   | 0.92               | 1.00 | 0.92 | 0.95        | 0.98 | 0.92 | 0.92       | 1.00 | 0.92 | 0.92       | 0.92 | 0.92 |
| Lanes:                        | 0.00               | 3.00 | 1.00 | 0.01        | 2.99 | 1.00 | 0.00       | 0.00 | 0.00 | 1.43       | 0.01 | 1.56 |
| Final Sat.:                   | 0                  | 5700 | 1750 | 9           | 5591 | 1750 | 0          | 0    | 0    | 2498       | 18   | 2734 |
| Capacity Analysis Module:     |                    |      |      |             |      |      |            |      |      |            |      |      |
| Vol/Sat:                      | 0.00               | 0.27 | 0.00 | 0.58        | 0.58 | 0.00 | 0.00       | 0.00 | 0.00 | 0.13       | 0.23 | 0.16 |
| Crit Moves:                   | *****              |      |      |             |      |      |            |      |      |            |      |      |
| Green Time:                   | 0.0                | 31.2 | 0.0  | 67.0        | 98.2 | 0.0  | 0.0        | 0.0  | 0.0  | 25.8       | 25.8 | 25.8 |
| Volume/Cap:                   | 0.00               | 1.13 | 0.00 | 1.13        | 0.77 | 0.00 | 0.00       | 0.00 | 0.00 | 0.68       | 1.13 | 0.82 |
| Delay/Veh:                    | 0.0                | 119  | 0.0  | 96.6        | 10.3 | 0.0  | 0.0        | 0.0  | 0.0  | 49.9       | 129  | 55.3 |
| User DelAdj:                  | 1.00               | 1.00 | 1.00 | 1.00        | 1.00 | 1.00 | 1.00       | 1.00 | 1.00 | 1.00       | 1.00 | 1.00 |
| AdjDel/Veh:                   | 0.0                | 119  | 0.0  | 96.6        | 10.3 | 0.0  | 0.0        | 0.0  | 0.0  | 49.9       | 129  | 55.3 |
| LOS by Move:                  | A                  | F    | A    | F           | B    | A    | A          | A    | A    | D          | F    | E    |
| HCM2k95thQ:                   | 0                  | 50   | 0    | 94          | 44   | 0    | 0          | 0    | 0    | 19         | 43   | 25   |

Note: Queue reported is the number of cars per lane.

BART

Level Of Service Computation Report  
 2000 HCM Operations (Future Volume Alternative)  
 AM - Mitigated Bkgrd + Proj

Intersection #5444: Lafayette/Lewis [Study Int 47]

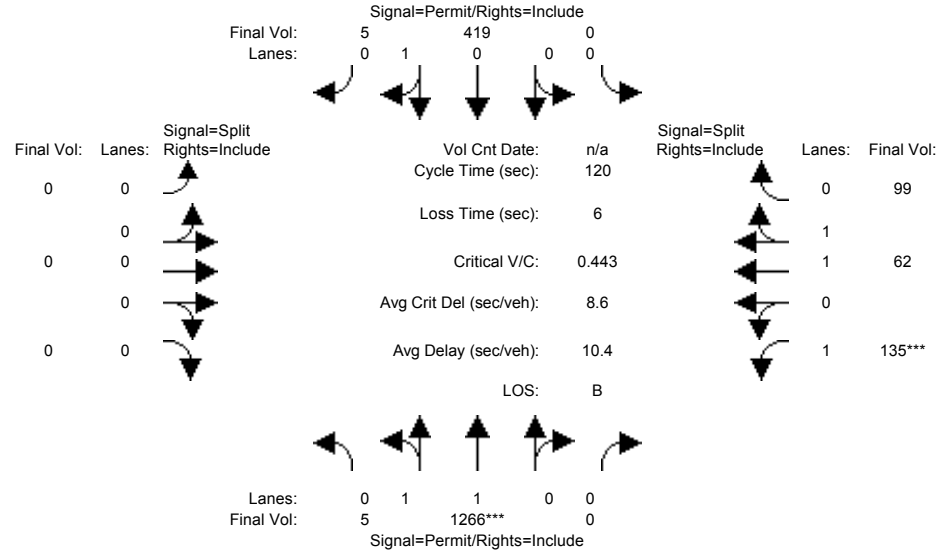

| Approach:                 | North Bound |      |      | South Bound |      |      | East Bound |      |      | West Bound |      |      |
|---------------------------|-------------|------|------|-------------|------|------|------------|------|------|------------|------|------|
| Movement:                 | L           | T    | R    | L           | T    | R    | L          | T    | R    | L          | T    | R    |
| Min. Green:               | 10          | 10   | 0    | 0           | 10   | 10   | 0          | 0    | 0    | 10         | 10   | 10   |
| Y+R:                      | 4.0         | 4.0  | 4.0  | 4.0         | 4.0  | 4.0  | 4.0        | 4.0  | 4.0  | 4.0        | 4.0  | 4.0  |
| Volume Module:            |             |      |      |             |      |      |            |      |      |            |      |      |
| Base Vol:                 | 5           | 1266 | 0    | 0           | 0    | 419  | 5          | 0    | 0    | 0          | 135  | 62   |
| Growth Adj:               | 1.00        | 1.00 | 1.00 | 1.00        | 1.00 | 1.00 | 1.00       | 1.00 | 1.00 | 1.00       | 1.00 | 1.00 |
| Initial Bse:              | 5           | 1266 | 0    | 0           | 0    | 419  | 5          | 0    | 0    | 0          | 135  | 62   |
| Added Vol:                | 0           | 0    | 0    | 0           | 0    | 0    | 0          | 0    | 0    | 0          | 0    | 0    |
| PasserByVol:              | 0           | 0    | 0    | 0           | 0    | 0    | 0          | 0    | 0    | 0          | 0    | 0    |
| Initial Fut:              | 5           | 1266 | 0    | 0           | 0    | 419  | 5          | 0    | 0    | 0          | 135  | 62   |
| User Adj:                 | 1.00        | 1.00 | 1.00 | 1.00        | 1.00 | 1.00 | 1.00       | 1.00 | 1.00 | 1.00       | 1.00 | 1.00 |
| PHF Adj:                  | 1.00        | 1.00 | 1.00 | 1.00        | 1.00 | 1.00 | 1.00       | 1.00 | 1.00 | 1.00       | 1.00 | 1.00 |
| PHF Volume:               | 5           | 1266 | 0    | 0           | 0    | 419  | 5          | 0    | 0    | 0          | 135  | 62   |
| Reduct Vol:               | 0           | 0    | 0    | 0           | 0    | 0    | 0          | 0    | 0    | 0          | 0    | 0    |
| Reduced Vol:              | 5           | 1266 | 0    | 0           | 0    | 419  | 5          | 0    | 0    | 0          | 135  | 62   |
| PCE Adj:                  | 1.00        | 1.00 | 1.00 | 1.00        | 1.00 | 1.00 | 1.00       | 1.00 | 1.00 | 1.00       | 1.00 | 1.00 |
| MLF Adj:                  | 1.00        | 1.00 | 1.00 | 1.00        | 1.00 | 1.00 | 1.00       | 1.00 | 1.00 | 1.00       | 1.00 | 1.00 |
| FinalVolume:              | 5           | 1266 | 0    | 0           | 0    | 419  | 5          | 0    | 0    | 0          | 135  | 62   |
| Saturation Flow Module:   |             |      |      |             |      |      |            |      |      |            |      |      |
| Sat/Lane:                 | 1900        | 1900 | 1900 | 1900        | 1900 | 1900 | 1900       | 1900 | 1900 | 1900       | 1900 | 1900 |
| Adjustment:               | 0.95        | 0.97 | 0.92 | 0.92        | 0.95 | 0.95 | 0.92       | 1.00 | 0.92 | 0.92       | 1.00 | 0.92 |
| Lanes:                    | 0.01        | 1.99 | 0.00 | 0.00        | 0.99 | 0.01 | 0.00       | 0.00 | 0.00 | 1.00       | 1.00 | 1.00 |
| Final Sat.:               | 15          | 3685 | 0    | 0           | 1779 | 21   | 0          | 0    | 0    | 1750       | 1900 | 1750 |
| Capacity Analysis Module: |             |      |      |             |      |      |            |      |      |            |      |      |
| Vol/Sat:                  | 0.34        | 0.34 | 0.00 | 0.00        | 0.24 | 0.24 | 0.00       | 0.00 | 0.00 | 0.08       | 0.03 | 0.06 |
| Crit Moves:               | ****        |      |      | ****        |      |      | ****       |      |      | ****       |      |      |
| Green Time:               | 93.1        | 93.1 | 0.0  | 0.0         | 93.1 | 93.1 | 0.0        | 0.0  | 0.0  | 20.9       | 20.9 | 20.9 |
| Volume/Cap:               | 0.44        | 0.44 | 0.00 | 0.00        | 0.30 | 0.30 | 0.00       | 0.00 | 0.00 | 0.44       | 0.19 | 0.32 |
| Delay/Veh:                | 4.7         | 4.7  | 0.0  | 0.0         | 4.1  | 4.1  | 0.0        | 0.0  | 0.0  | 45.4       | 42.4 | 43.8 |
| User DelAdj:              | 1.00        | 1.00 | 1.00 | 1.00        | 1.00 | 1.00 | 1.00       | 1.00 | 1.00 | 1.00       | 1.00 | 1.00 |
| AdjDel/Veh:               | 4.7         | 4.7  | 0.0  | 0.0         | 4.1  | 4.1  | 0.0        | 0.0  | 0.0  | 45.4       | 42.4 | 43.8 |
| LOS by Move:              | A           | A    | A    | A           | A    | A    | A          | A    | A    | D          | D    | D    |
| HCM2k95thQ:               | 15          | 15   | 0    | 0           | 9    | 9    | 0          | 0    | 0    | 10         | 4    | 7    |

Note: Queue reported is the number of cars per lane.



BART

Level Of Service Computation Report  
 2000 HCM Operations (Future Volume Alternative)  
 PM - Mitigated Bkgrd + Proj

Intersection #5444: Lafayette/Lewis [Study Int 47]

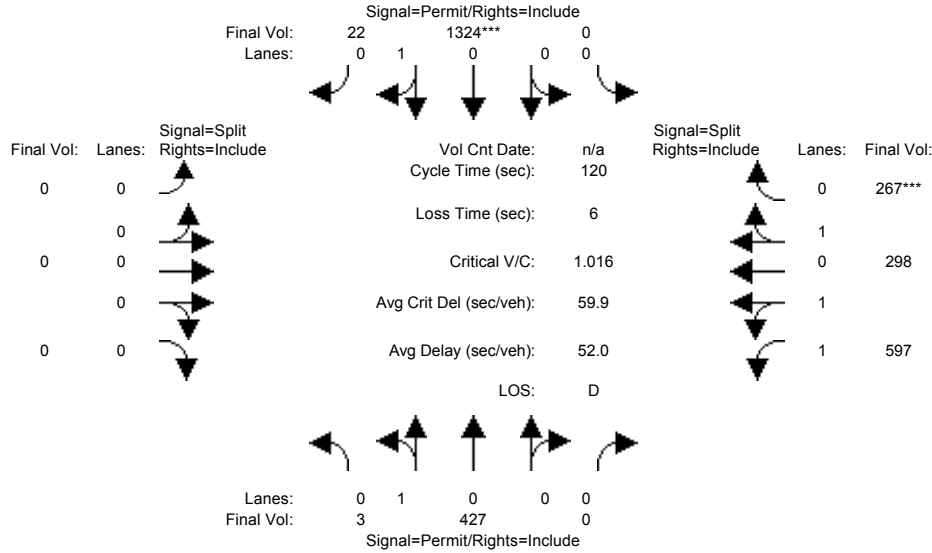

| Approach:                 | North Bound |      |      | South Bound |      |      | East Bound |      |      | West Bound |      |      |
|---------------------------|-------------|------|------|-------------|------|------|------------|------|------|------------|------|------|
| Movement:                 | L           | T    | R    | L           | T    | R    | L          | T    | R    | L          | T    | R    |
| Min. Green:               | 10          | 10   | 0    | 0           | 10   | 10   | 0          | 0    | 0    | 10         | 10   | 10   |
| Y+R:                      | 4.0         | 4.0  | 4.0  | 4.0         | 4.0  | 4.0  | 4.0        | 4.0  | 4.0  | 4.0        | 4.0  | 4.0  |
| Volume Module:            |             |      |      |             |      |      |            |      |      |            |      |      |
| Base Vol:                 | 3           | 427  | 0    | 0           | 1324 | 22   | 0          | 0    | 0    | 597        | 298  | 267  |
| Growth Adj:               | 1.00        | 1.00 | 1.00 | 1.00        | 1.00 | 1.00 | 1.00       | 1.00 | 1.00 | 1.00       | 1.00 | 1.00 |
| Initial Bse:              | 3           | 427  | 0    | 0           | 1324 | 22   | 0          | 0    | 0    | 597        | 298  | 267  |
| Added Vol:                | 0           | 0    | 0    | 0           | 0    | 0    | 0          | 0    | 0    | 0          | 0    | 0    |
| PasserByVol:              | 0           | 0    | 0    | 0           | 0    | 0    | 0          | 0    | 0    | 0          | 0    | 0    |
| Initial Fut:              | 3           | 427  | 0    | 0           | 1324 | 22   | 0          | 0    | 0    | 597        | 298  | 267  |
| User Adj:                 | 1.00        | 1.00 | 1.00 | 1.00        | 1.00 | 1.00 | 1.00       | 1.00 | 1.00 | 1.00       | 1.00 | 1.00 |
| PHF Adj:                  | 1.00        | 1.00 | 1.00 | 1.00        | 1.00 | 1.00 | 1.00       | 1.00 | 1.00 | 1.00       | 1.00 | 1.00 |
| PHF Volume:               | 3           | 427  | 0    | 0           | 1324 | 22   | 0          | 0    | 0    | 597        | 298  | 267  |
| Reduct Vol:               | 0           | 0    | 0    | 0           | 0    | 0    | 0          | 0    | 0    | 0          | 0    | 0    |
| Reduced Vol:              | 3           | 427  | 0    | 0           | 1324 | 22   | 0          | 0    | 0    | 597        | 298  | 267  |
| PCE Adj:                  | 1.00        | 1.00 | 1.00 | 1.00        | 1.00 | 1.00 | 1.00       | 1.00 | 1.00 | 1.00       | 1.00 | 1.00 |
| MLF Adj:                  | 1.00        | 1.00 | 1.00 | 1.00        | 1.00 | 1.00 | 1.00       | 1.00 | 1.00 | 1.00       | 1.00 | 1.00 |
| FinalVolume:              | 3           | 427  | 0    | 0           | 1324 | 22   | 0          | 0    | 0    | 597        | 298  | 267  |
| Saturation Flow Module:   |             |      |      |             |      |      |            |      |      |            |      |      |
| Sat/Lane:                 | 1900        | 1900 | 1900 | 1900        | 1900 | 1900 | 1900       | 1900 | 1900 | 1900       | 1900 | 1900 |
| Adjustment:               | 0.95        | 0.95 | 0.92 | 0.92        | 0.95 | 0.95 | 0.92       | 1.00 | 0.92 | 0.93       | 0.95 | 0.95 |
| Lanes:                    | 0.01        | 0.99 | 0.00 | 0.00        | 0.98 | 0.02 | 0.00       | 0.00 | 0.00 | 1.56       | 0.76 | 0.68 |
| Final Sat.:               | 13          | 1787 | 0    | 0           | 1771 | 29   | 0          | 0    | 0    | 2748       | 1372 | 1229 |
| Capacity Analysis Module: |             |      |      |             |      |      |            |      |      |            |      |      |
| Vol/Sat:                  | 0.24        | 0.24 | 0.00 | 0.00        | 0.75 | 0.75 | 0.00       | 0.00 | 0.00 | 0.22       | 0.22 | 0.22 |
| Crit Moves:               | *****       |      |      |             |      |      |            |      |      |            |      |      |
| Green Time:               | 88.3        | 88.3 | 0.0  | 0.0         | 88.3 | 88.3 | 0.0        | 0.0  | 0.0  | 25.7       | 25.7 | 25.7 |
| Volume/Cap:               | 0.32        | 0.32 | 0.00 | 0.00        | 1.02 | 1.02 | 0.00       | 0.00 | 0.00 | 1.02       | 1.02 | 1.02 |
| Delay/Veh:                | 5.6         | 5.6  | 0.0  | 0.0         | 44.6 | 44.6 | 0.0        | 0.0  | 0.0  | 77.8       | 77.8 | 77.8 |
| User DelAdj:              | 1.00        | 1.00 | 1.00 | 1.00        | 1.00 | 1.00 | 1.00       | 1.00 | 1.00 | 1.00       | 1.00 | 1.00 |
| AdjDel/Veh:               | 5.6         | 5.6  | 0.0  | 0.0         | 44.6 | 44.6 | 0.0        | 0.0  | 0.0  | 77.8       | 77.8 | 77.8 |
| LOS by Move:              | A           | A    | A    | A           | D    | D    | A          | A    | A    | E          | E    | E    |
| HCM2k95thQ:               | 11          | 11   | 0    | 0           | 89   | 89   | 0          | 0    | 0    | 36         | 36   | 36   |

Note: Queue reported is the number of cars per lane.

BART

Level Of Service Computation Report  
2000 HCM Operations (Future Volume Alternative)  
AM - Mitigated Cumulative Proj

Intersection #5444: Lafayette/Lewis [Study Int 47]

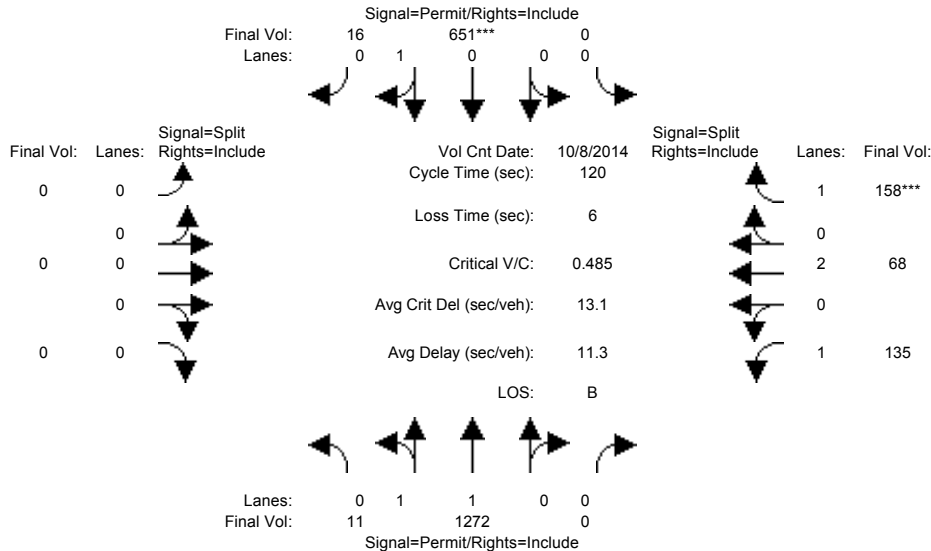

| Approach:                                   | North Bound |      |      | South Bound |      |      | East Bound |      |      | West Bound |      |      |
|---|-------------|------|------|-------------|------|------|------------|------|------|------------|------|------|
| Movement:                                   | L           | T    | R    | L           | T    | R    | L          | T    | R    | L          | T    | R    |
| Min. Green:                                 | 10          | 10   | 0    | 0           | 10   | 10   | 0          | 0    | 0    | 10         | 10   | 10   |
| Y+R:  | 4.0         | 4.0  | 4.0  | 4.0         | 4.0  | 4.0  | 4.0        | 4.0  | 4.0  | 4.0        | 4.0  | 4.0  |
| Volume Module: >> Count Date: 8 Oct 2014 << |             |      |      |             |      |      |            |      |      |            |      |      |
| Base Vol:                                   | 11          | 1272 | 0    | 0           | 651  | 16   | 0          | 0    | 0    | 135        | 68   | 158  |
| Growth Adj:                                 | 1.00        | 1.00 | 1.00 | 1.00        | 1.00 | 1.00 | 1.00       | 1.00 | 1.00 | 1.00       | 1.00 | 1.00 |
| Initial Bse:                                | 11          | 1272 | 0    | 0           | 651  | 16   | 0          | 0    | 0    | 135        | 68   | 158  |
| Added Vol:                                  | 0           | 0    | 0    | 0           | 0    | 0    | 0          | 0    | 0    | 0          | 0    | 0    |
| PasserByVol:                                | 0           | 0    | 0    | 0           | 0    | 0    | 0          | 0    | 0    | 0          | 0    | 0    |
| Initial Fut:                                | 11          | 1272 | 0    | 0           | 651  | 16   | 0          | 0    | 0    | 135        | 68   | 158  |
| User Adj:                                   | 1.00        | 1.00 | 1.00 | 1.00        | 1.00 | 1.00 | 1.00       | 1.00 | 1.00 | 1.00       | 1.00 | 1.00 |
| PHF Adj:                                    | 1.00        | 1.00 | 1.00 | 1.00        | 1.00 | 1.00 | 1.00       | 1.00 | 1.00 | 1.00       | 1.00 | 1.00 |
| PHF Volume:                                 | 11          | 1272 | 0    | 0           | 651  | 16   | 0          | 0    | 0    | 135        | 68   | 158  |
| Reduct Vol:                                 | 0           | 0    | 0    | 0           | 0    | 0    | 0          | 0    | 0    | 0          | 0    | 0    |
| Reduced Vol:                                | 11          | 1272 | 0    | 0           | 651  | 16   | 0          | 0    | 0    | 135        | 68   | 158  |
| PCE Adj:                                    | 1.00        | 1.00 | 1.00 | 1.00        | 1.00 | 1.00 | 1.00       | 1.00 | 1.00 | 1.00       | 1.00 | 1.00 |
| MLF Adj:                                    | 1.00        | 1.00 | 1.00 | 1.00        | 1.00 | 1.00 | 1.00       | 1.00 | 1.00 | 1.00       | 1.00 | 1.00 |
| Final Volume:                               | 11          | 1272 | 0    | 0           | 651  | 16   | 0          | 0    | 0    | 135        | 68   | 158  |
| Saturation Flow Module:                     |             |      |      |             |      |      |            |      |      |            |      |      |
| Sat/Lane:                                   | 1900        | 1900 | 1900 | 1900        | 1900 | 1900 | 1900       | 1900 | 1900 | 1900       | 1900 | 1900 |
| Adjustment:                                 | 0.95        | 0.97 | 0.92 | 0.92        | 0.95 | 0.95 | 0.92       | 1.00 | 0.92 | 0.92       | 1.00 | 0.92 |
| Lanes:                                      | 0.02        | 1.98 | 0.00 | 0.00        | 0.98 | 0.02 | 0.00       | 0.00 | 0.00 | 1.00       | 2.00 | 1.00 |
| Final Sat.:                                 | 32          | 3668 | 0    | 0           | 1757 | 43   | 0          | 0    | 0    | 1750       | 3800 | 1750 |
| Capacity Analysis Module:                   |             |      |      |             |      |      |            |      |      |            |      |      |
| Vol/Sat:                                    | 0.35        | 0.35 | 0.00 | 0.00        | 0.37 | 0.37 | 0.00       | 0.00 | 0.00 | 0.08       | 0.02 | 0.09 |
| Crit Moves:                                 | ****        |      |      |             |      |      |            |      |      |            |      |      |
| Green Time:                                 | 91.7        | 91.7 | 0.0  | 0.0         | 91.7 | 91.7 | 0.0        | 0.0  | 0.0  | 22.3       | 22.3 | 22.3 |
| Volume/Cap:                                 | 0.45        | 0.45 | 0.00 | 0.00        | 0.49 | 0.49 | 0.00       | 0.00 | 0.00 | 0.41       | 0.10 | 0.49 |
| Delay/Veh:                                  | 5.2         | 5.2  | 0.0  | 0.0         | 5.6  | 5.6  | 0.0        | 0.0  | 0.0  | 43.9       | 40.5 | 44.8 |
| User DelAdj:                                | 1.00        | 1.00 | 1.00 | 1.00        | 1.00 | 1.00 | 1.00       | 1.00 | 1.00 | 1.00       | 1.00 | 1.00 |
| AdjDel/Veh:                                 | 5.2         | 5.2  | 0.0  | 0.0         | 5.6  | 5.6  | 0.0        | 0.0  | 0.0  | 43.9       | 40.5 | 44.8 |
| LOS by Move:                                | A           | A    | A    | A           | A    | A    | A          | A    | A    | D          | D    | D    |
| HCM2k95thQ:                                 | 16          | 16   | 0    | 0           | 17   | 17   | 0          | 0    | 0    | 10         | 2    | 12   |

Note: Queue reported is the number of cars per lane.

BART

Level Of Service Computation Report  
 2000 HCM Operations (Future Volume Alternative)  
 PM - Mitigated Cumulative Proj

Intersection #5444: Lafayette/Lewis [Study Int 47]

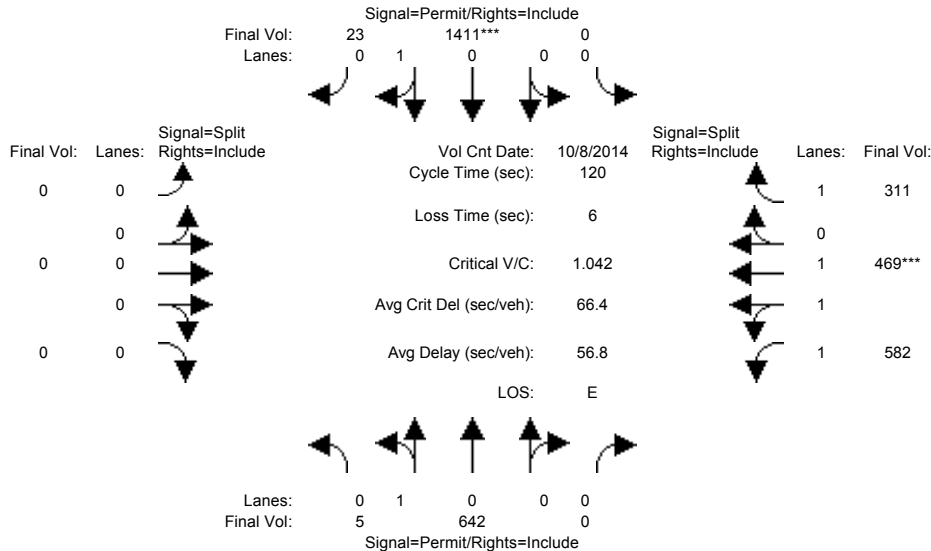

| Approach:                 | North Bound                  |      |      | South Bound |      |      | East Bound |      |      | West Bound |      |      |
|---------------------------|------------------------------|------|------|-------------|------|------|------------|------|------|------------|------|------|
| Movement:                 | L                            | T    | R    | L           | T    | R    | L          | T    | R    | L          | T    | R    |
| Min. Green:               | 10                           | 10   | 0    | 0           | 10   | 10   | 0          | 0    | 0    | 10         | 10   | 10   |
| Y+R:                      | 4.0                          | 4.0  | 4.0  | 4.0         | 4.0  | 4.0  | 4.0        | 4.0  | 4.0  | 4.0        | 4.0  | 4.0  |
| -----                     |                              |      |      |             |      |      |            |      |      |            |      |      |
| Volume Module:            | >> Count Date: 8 Oct 2014 << |      |      |             |      |      |            |      |      |            |      |      |
| Base Vol:                 | 5                            | 642  | 0    | 0           | 1411 | 23   | 0          | 0    | 0    | 582        | 469  | 311  |
| Growth Adj:               | 1.00                         | 1.00 | 1.00 | 1.00        | 1.00 | 1.00 | 1.00       | 1.00 | 1.00 | 1.00       | 1.00 | 1.00 |
| Initial Bse:              | 5                            | 642  | 0    | 0           | 1411 | 23   | 0          | 0    | 0    | 582        | 469  | 311  |
| Added Vol:                | 0                            | 0    | 0    | 0           | 0    | 0    | 0          | 0    | 0    | 0          | 0    | 0    |
| PasserByVol:              | 0                            | 0    | 0    | 0           | 0    | 0    | 0          | 0    | 0    | 0          | 0    | 0    |
| Initial Fut:              | 5                            | 642  | 0    | 0           | 1411 | 23   | 0          | 0    | 0    | 582        | 469  | 311  |
| User Adj:                 | 1.00                         | 1.00 | 1.00 | 1.00        | 1.00 | 1.00 | 1.00       | 1.00 | 1.00 | 1.00       | 1.00 | 1.00 |
| PHF Adj:                  | 1.00                         | 1.00 | 1.00 | 1.00        | 1.00 | 1.00 | 1.00       | 1.00 | 1.00 | 1.00       | 1.00 | 1.00 |
| PHF Volume:               | 5                            | 642  | 0    | 0           | 1411 | 23   | 0          | 0    | 0    | 582        | 469  | 311  |
| Reduct Vol:               | 0                            | 0    | 0    | 0           | 0    | 0    | 0          | 0    | 0    | 0          | 0    | 0    |
| Reduced Vol:              | 5                            | 642  | 0    | 0           | 1411 | 23   | 0          | 0    | 0    | 582        | 469  | 311  |
| PCE Adj:                  | 1.00                         | 1.00 | 1.00 | 1.00        | 1.00 | 1.00 | 1.00       | 1.00 | 1.00 | 1.00       | 1.00 | 1.00 |
| MLF Adj:                  | 1.00                         | 1.00 | 1.00 | 1.00        | 1.00 | 1.00 | 1.00       | 1.00 | 1.00 | 1.00       | 1.00 | 1.00 |
| Final Volume:             | 5                            | 642  | 0    | 0           | 1411 | 23   | 0          | 0    | 0    | 582        | 469  | 311  |
| -----                     |                              |      |      |             |      |      |            |      |      |            |      |      |
| Saturation Flow Module:   |                              |      |      |             |      |      |            |      |      |            |      |      |
| Sat/Lane:                 | 1900                         | 1900 | 1900 | 1900        | 1900 | 1900 | 1900       | 1900 | 1900 | 1900       | 1900 | 1900 |
| Adjustment:               | 0.95                         | 0.95 | 0.92 | 0.92        | 0.95 | 0.95 | 0.92       | 1.00 | 0.92 | 0.93       | 0.99 | 0.92 |
| Lanes:                    | 0.01                         | 0.99 | 0.00 | 0.00        | 0.98 | 0.02 | 0.00       | 0.00 | 0.00 | 1.70       | 1.30 | 1.00 |
| Final Sat.:               | 14                           | 1786 | 0    | 0           | 1771 | 29   | 0          | 0    | 0    | 3016       | 2430 | 1750 |
| -----                     |                              |      |      |             |      |      |            |      |      |            |      |      |
| Capacity Analysis Module: |                              |      |      |             |      |      |            |      |      |            |      |      |
| Vol/Sat:                  | 0.36                         | 0.36 | 0.00 | 0.00        | 0.80 | 0.80 | 0.00       | 0.00 | 0.00 | 0.19       | 0.19 | 0.18 |
| Crit Moves:               | *****                        |      |      |             |      |      |            |      |      |            |      |      |
| Green Time:               | 91.8                         | 91.8 | 0.0  | 0.0         | 91.8 | 91.8 | 0.0        | 0.0  | 0.0  | 22.2       | 22.2 | 22.2 |
| Volume/Cap:               | 0.47                         | 0.47 | 0.00 | 0.00        | 1.04 | 1.04 | 0.00       | 0.00 | 0.00 | 1.04       | 1.04 | 0.96 |
| Delay/Veh:                | 5.4                          | 5.4  | 0.0  | 0.0         | 50.0 | 50.0 | 0.0        | 0.0  | 0.0  | 88.7       | 88.7 | 87.5 |
| User DelAdj:              | 1.00                         | 1.00 | 1.00 | 1.00        | 1.00 | 1.00 | 1.00       | 1.00 | 1.00 | 1.00       | 1.00 | 1.00 |
| AdjDel/Veh:               | 5.4                          | 5.4  | 0.0  | 0.0         | 50.0 | 50.0 | 0.0        | 0.0  | 0.0  | 88.7       | 88.7 | 87.5 |
| LOS by Move:              | A                            | A    | A    | A           | D    | D    | A          | A    | A    | F          | F    | F    |
| HCM2k95thQ:               | 17                           | 17   | 0    | 0           | 97   | 97   | 0          | 0    | 0    | 34         | 34   | 29   |

Note: Queue reported is the number of cars per lane.

**Appendix F**  
**Signal Warrant Worksheets**

**BART Extension Phase II**

**48 . Lafayette Street and Harrison Street**

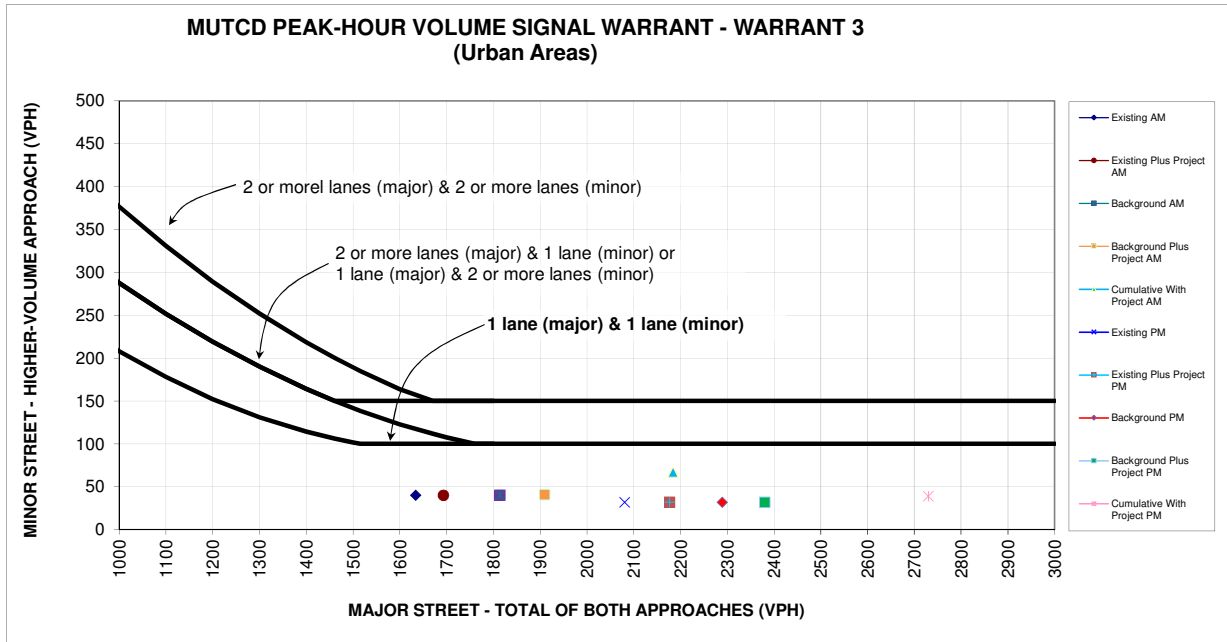

Source: Figure 4C-3 of the Manual on Uniform Traffic Control and Devices (MUTCD) 2014 Edition from California Department of Transportation (Caltrans).  
 \* 150 vph applies as the lower threshold volume for a minor-street approach with two or more lanes and 100 vph applies as the lower threshold volume for a minor-street approach with one lane.

|  |                  | AM Peak Hour            |      |             |                          |               |                            |                            |
|--|------------------|-------------------------|------|-------------|--------------------------|---------------|----------------------------|----------------------------|
|  |                  | Existing Approach Lanes |      | Existing AM | Existing Plus Project AM | Background AM | Background Plus Project AM | Cumulative With Project AM |
|  |                  | 2 or One                | More |             |                          |               |                            |                            |
| Major Street - Both Approaches                             | Lafayette Street | X                       |      | 1634        | 1693                     | 1814          | 1909                       | 2184                       |
| Minor Street - Highest Approach                            | Harrison Street  | X                       |      | 40          | 40                       | 40            | 41                         | 67                         |
| Maximum warrant threshold for minor street volume          |                  |                         |      | 100         | 100                      | 100           | 100                        | 100                        |
| Difference between warrant threshold & minor street volume |                  |                         |      | 60          | 60                       | 60            | 59                         | 33                         |
| Warrant Met?   |                  | No                      |      | No          | No                       | No            | No                         | No                         |

|  |                  | PM Peak Hour            |      |             |                          |               |                            |                            |
|--|------------------|-------------------------|------|-------------|--------------------------|---------------|----------------------------|----------------------------|
|  |                  | Existing Approach Lanes |      | Existing PM | Existing Plus Project PM | Background PM | Background Plus Project PM | Cumulative With Project PM |
|  |                  | 2 or One                | More |             |                          |               |                            |                            |
| Major Street - Both Approaches                             | Lafayette Street | X                       |      | 2081        | 2177                     | 2290          | 2380                       | 2730                       |
| Minor Street - Highest Approach                            | Harrison Street  | X                       |      | 32          | 32                       | 32            | 32                         | 39                         |
| Maximum warrant threshold for minor street volume          |                  |                         |      | 100         | 100                      | 100           | 100                        | 100                        |
| Difference between warrant threshold & minor street volume |                  |                         |      | 68          | 68                       | 68            | 68                         | 61                         |
| Warrant Met?   |                  | No                      |      | No          | No                       | No            | No                         | No                         |

## **Appendix G**

### **Transportation Impact Analysis For the BART Extension Only**

## **Appendix H**

### **Project Worksopce**

**Approved by City of San Jose**

October 10, 2015

Mr. At van den Hout & Mr. Brian Jackson  
Hexagon Transportation Consultants, Inc.  
4 North Second Street, Suite 400  
San Jose, CA 95113

Dear Mr. van den Hout & Mr. Jackson:

SUBJECT: TRAFFIC IMPACT ANALYSIS WORKSCOPE FOR BART PHASE II AND MIXED-USE DEVELOPMENT (3-22032)

This scope of work supersedes the scope of work provided on **9/14/2015**.

Enclosed is the information necessary to complete the traffic impact analysis for the proposed BART Phase II and mixed-use development within three station areas in San Jose including Alum Rock BART station, Downtown BART stations, Diridon BART Station, and associated mixed-use developments.

## PROJECT DESCRIPTION

1. The proposed **Alum Rock BART station** and mixed-use development is bounded by East St. James Street, North 30<sup>th</sup> Street, 5 Wounds Lane, and North 28<sup>th</sup> Street. The project proposes replacing currently operating industrial uses with a BART station, 500,000 square feet of office space, 275 apartment units, and 20,000 square feet of retail. The analysis must demonstrate conformance to Council Policy 5-3, City of San Jose's Transportation Level of Service Policy and the VTA's Congestion Management Program requirements.
2. The **Downtown BART station** is proposing three (3) project sites. The sites are located within the City of San Jose's Downtown Core and must conform to the Downtown Strategy 2000 Plan. Conformance to the Strategy Plan does not require any level-of-service analysis since an area-wide EIR was completed which approved development levels in the downtown.
  - Southeast corner of Sixth Street/Santa Clara Street - Sixth Street proposes replacing a 38,000 square-foot retail store with a BART station, 222,230 square feet of office space and 121,530 square feet of retail space
  - Northwest corner of Fourth Street/ Santa Clara Street - Fourth Street proposes a BART station, 47,530 square feet of office space and 30,490 square feet of retail space.



- Northwest corner of Third Street/Santa Clara Street - Third Street proposes a BART station, 35,880 square feet of office space, and 10,250 square feet of retail space.

These project sites would replace existing commercial uses with a BART station and associated mixed-uses.

3. **The Diridon BART station** and mixed-use development is located within the Diridon Station Area Plan and is bounded by Santa Clara Street, Autumn Street, Stover Street and Cahill Street. The project proposes replacing an existing parking lot with a BART station, 640,000 square feet of office space, and 72,000 square feet of retail.

On June 17, 2014 San Jose City Council approved the Diridon Station Area Plan and certified the EIR. The goals of the Plan anticipate maximum possible build-out of new transit-related development in a half-mile, 250 acre, radius around the Diridon Station. Level of Service analysis was already completed in the Diridon Station Plan and the Downtown Strategy 2000 plan; therefore, no further project LOS would be required.

In order to assist you in completing the traffic impact analysis, we are forwarding the following data and requirements to be included within the traffic analysis.

## PROJECT ASSUMPTIONS

- Trip generation rates are approved as provided.
- Because the project sites are not fully developed, ingress/egress, traffic signal operations, queuing, loading docks, truck accommodations cannot be analyzed. Upon development of a detailed site, additional operational analysis would be required to address site specific issues.
- The trip distributions show retail traffic in excess of the office traffic. Based on the size of the proposed retail, and the downtown traffic and parking conditions, downtown retail is typically local serving or linked trips especially during peak travel. Please review traffic characteristics of retail site in the downtown.

## TRIP CREDITS

- Trip credits can be applied to individual sites where there are occupied active uses

## TRIP REDUCTIONS

- Pass-by/Diverted Link Trips
- Mixed Use Development
- Along LRT or Major Bus Line

### **PROJECT TRAFFIC SCENARIOS (Alum Rock Station Only)**

- Existing Level of Service (Environmental Baseline)
- Existing + Project
- Background Scenario: Existing + Approved Projects
- Project Scenario: Existing + Approved Projects + Project

### **LEVEL OF SERVICE ANALYSIS (Alum Rock Station Only)**

- Analyze twenty-five (25) signalized intersections (7 of them **CMP** intersections) for the AM and PM peak hours using TRAFFIX and conform to the City of San Jose LOS Council Policy 5-3, and the Congestion Management Program requirements (See Attachment A).
- Traffic counts submitted July 14, 2015 and September 17, 2015 are approved except for Santa Clara Street / 24<sup>th</sup> Street. Please use counts dated 11/05/2015 for that intersection.
- No new counts are required for level-of-service or CMP analyses (See Attachment A).

### **FREEWAY ANALYSIS (Alum Rock Station Only)**

- Conform to the requirements of the VTA Congestion Management Program's requirements for freeway analysis for the Alum Rock Station.
- Analyze the freeway segments affected by project traffic along I-280, I-680, US-101.
- Perform queuing analysis at US-101 / Story Road ramps and identify any existing operational deficiency due to ramp metering or other downstream conditions. Identify the added projects and increase in delay, queue, if any.
- Perform queuing analysis at I-680 / King Road ramps and identify any existing operational deficiency due to ramp metering or other downstream conditions. Identify the added projects and increase in delay, queue, if any.
- Perform queuing analyses at I-680 / McKee Road ramps and identify any existing operational deficiency due to ramp metering or other downstream conditions. Identify the added projects and increase in delay, queue, if any.

### **CUMMULATIVE ANALYSIS**

- Perform cumulative analysis for the Alum Rock Station. Contact the City of San Jose for the complete list of pending projects or use GP2040 buildout conditions.

### **BICYCLE, PEDESTRIAN, AND TRANSIT FACILITIES (All sites)**

- Provide an evaluation of transit services, bicycle facilities, and pedestrian facilities near the future BART stations including circulation, recommendations and identified improvements.
- Analyze pedestrian and bicycle connections to nearby commercial services, employment centers and residential areas to be used by BART riders. Gaps in pedestrian and bicycle connectivity and challenges crossing intersections, especially given the proximity to US 101, should be identified and addressed.

**OPERATIONAL ANALYSIS** – In absence of a detailed site plan, the following operations should be addressed unless the project's lack the information required addressing:

#### **Alum Rock BART Station & Mixed-Use Development**

- Perform left-turn storage analysis at the following intersections:
  - Project Entrances
  - 28<sup>th</sup> Street/St. James Street
  - 28<sup>th</sup> Street/5 Wounds Lane
  - Santa Clara Street/28<sup>th</sup> Street
  - Any other left-turn pockets where stacking from the project will be significant.
- Perform operation analysis at the project entrance.

#### **Downtown BART Stations & Mixed-Use Development (3 Project Sites)**

- Include a discussion on the project's conformance to the Downtown Strategy and the any proposed mitigations identified for traffic impacts in Downtown.

#### **Diridon BART Station & Mixed-Use Development**

- Include a discussion of on-site circulation, truck (garbage, moving, delivery, and emergency vehicle) access and circulation; access to site and any proposed limited access driveways along the project frontages.
- Include a discussion on the operations relative to the SAP center.
- Include a discussion on how the project conforms to the Downtown Strategy 2000 and the Diridon Station Area Plan.



### **NEIGHBORHOOD INTERFACE (all sites)**

Include a discussion on pedestrian and bicycle circulation (especially relative to the proximity of schools (Five Wounds School, Horace Mann Elementary), and residential neighborhoods).

### **MITIGATIONS (Alum Rock site)**

All proposed mitigation must include a feasibility analysis, which includes an aerial photo print overlaid with the proposed mitigation. All buildings and right-of-way lines should be shown. When aerial photos are not available, a drawing may be submitted that is based on accurate topography, striping plans, or improvement plans. Confer with the Project Engineer for an alternate type of submittal.

### **FIELD OBSERVATION**

- The report must include field observations documenting existing field conditions. The following list is a guideline of items to be considered in collecting new count data, evaluating the Level-of-Service, evaluating proposed mitigation, and evaluating operational impacts:
  - Upstream, downstream conditions
  - Queuing at intersection
  - Affects of ramp meters
  - Coordination of signal, use of green time, signal timing
  - Any unusual problem
  - Construction affecting new count data
  - Qualitatively describe overall intersection performance
  - Possible causes of congestion, recommend solutions
  
- The report must include field observations documenting existing field conditions with regard to transit, LRT, existing pedestrian, and bicycle routes. The following list is a guideline of items to be considered in collecting new count data, evaluating the Level-of-Service, evaluating proposed mitigation, and evaluating operational impacts:
  - Modification or elimination of bicycle or pedestrian facilities
  - Effects on future bicycle plans
  - Bicycle and pedestrian facilities proposed by the project
  - Demand for transit service
  - Improvements to provide better access to transit

### **COORDINATION WITH OTHER AGENCIES**

- Caltrans
- VTA

## GENERAL

- The base conditions for the Traffic and CSJ LOS intersections have been determined by Public Works staff. If any changes need to be made to the calculation sheets, contact Public Works staff prior to modifying.
- The Approved Trips Inventory (ATI), Traffic LOS calcs for existing and background conditions and list of ATI projects have been forwarded.
- The project traffic assignments and new traffic counts must be submitted for review and approval prior to preparation of the traffic report. Adhere to the City of San Jose's "Traffic Impact Analysis Handbook Volume I (2009) Methodologies & Requirements" and "Volume II (2011) Policy & Guidelines," and the Santa Clara Valley Transportation Authority "Transportation Impact Analysis Guidelines" for the preparation of the report.

## TRAFFIC REPORT FEES

Fees totaling \$14,998.00 are due. This includes the Traffic Report Workscope Fee in the amount of \$3,892.00 and the Traffic Report Review Fee in the amount of \$9,383.00 based on 2806 P.M. peak-hour trips generated by the project prior to any credits or deductions, as well as a \$786.00 DOT Geometric Design Fee, and a Record Retention Fee of \$937.00. These fees must be paid to the Department of Public Works when the draft traffic impact analysis is submitted for review.

If you have any questions, please contact me at [Karen.Mack@sanjoseca.gov](mailto:Karen.Mack@sanjoseca.gov) or (408) 535-6816. You may also reach the Senior Engineer overseeing the project, Jeff Lee at [Jeff.Lee@sanjoseca.gov](mailto:Jeff.Lee@sanjoseca.gov) or (408) 535-6829.

Sincerely,



Karen Mack  
Traffic Manager  
Development Services Division  
Department of Public Works

KM:aw  
Enclosures  
Workscope

C: Tom Fitzwater, VTA  
David Kobayashi, VTA  
Jessica Zenk, CSJ DOT