

VTA's BART Silicon Valley Phase II Extension Project

Downtown/Diridon Community Working Group

April 4, 2017



Agenda

- Follow-up Items
- June Phase I Tour Details
- Federal Involvement & Financial Update
- Draft SEIS/SEIR Public Circulation Update
- Single-Bore Technical Study Summary
- Single-Bore & Twin-Bore Comparative Analysis Update
- Diridon Transportation Facilities Master Plan Update
- Next Steps



Role of the CWG

- Be project liaisons
- Receive briefings on technical areas
- Receive project updates
- Build an understanding of the project
- Collaborate with VTA
- Contribute to the successful delivery of the project



Your Role as a CWG Member

- Attend CWG meetings
 - Bring your own binder (BYOB)
- Be honest
- Provide feedback
- Get informed
- Disseminate accurate information
- Act as conduits for information to community at large



Role of the CWG Team

CWG Team Member	Role
Eileen Goodwin	Facilitator
Alex Shoor	Primary Outreach Contact
Leyla Hedayat	Phase II Project Manager
Jill Gibson	Technical Lead
Rosalynn Hughey	City of San Jose – Planning Liaison
Jessica Zenk	City of San Jose – DOT Liaison
Ahmad Qayoumi	City of San Jose – DOT Liaison



Upcoming Meetings

VTA Board of Directors

- April 6, 2017 at 5:30 PM
- April 21, 2017 at 9:00 AM Workshop
- May 4, 2017 at 5:30 PM
- June 1, 2017 at 5:30 PM

VTA's BART Silicon Valley Program Ad Hoc Committee

- May 15, 2017 at 10:00 AM

Diridon Station Joint Policy Advisory Board

- June 16, 2017 at 3:00 PM



Follow-Up Items



Solutions that move you 7

Follow-Up Items

- We are working with the parking software vendor to determine availability of parking data request. Once Phase I is operational an open data request can be made.
- June Phase I Tour location details will be provided today offline.
- Dates for BART Silicon Valley Ad Hoc Committee meetings were provided in email with meeting notes.
- Federal funding status has been added as a regular agenda item.
- The status of interagency transfer policy discussion was included in the meeting notes.



Solutions that move you 8

June Phase I Tour

Brandi Childress, VTA



9

Phase I Tour Details

- June 13, 2017 – 12:30-3:30 PM on VTA community bus
- Meet at the VTA Block parking lot (64 North Market Street, San Jose)
- VTA will provide hard hat, glasses, gloves, vest, boots
- Need to RSVP to Eventbrite, space is limited – will include RSVP link with meeting notes
- No food allowed on the bus, bottled water will be provided



Solutions that move you 10

Federal Involvement & Financial Update

Kurt Evans, VTA
Mike Smith, VTA



Phase II Funding Strategy

Phase II Project Cost: \$4.69 Billion¹

Funding Status	Source	Target Value
Expended	Measure A Sales Tax & TCRP	\$160 Million
Approved	Existing Measure A Sales Tax	\$1 Billion
Projected	FTA New Starts	\$1.5 Billion
Approved	2016 Sales Tax Measure B	\$1.5 Billion
Projected	State Transit & Intercity Rail Capital Program	\$750 Million ³
Total		\$4.91 Billion²

¹As part of the Federal New Starts review process, FTA will conduct a risk evaluation and establish with VTA the contingency levels for the project.

² The amount included in the funding strategy assumes a level of additional contingency resulting from the future risk assessment results.

³ VTA is targeting the maximum State Transit and Intercity Rail Capital Program amount of \$750 million. The current program is competitive and any allocation awarded to VTA could be less than the target amount.



Cap and Trade

- Cap and Trade funding is an important component of the local match revenues.
- Auction revenues have been significantly below projections
 - Program termination in 2020
 - Litigation challenge as illegal tax
- Two bills have been introduced to resolve both concerns
 - AB 151 (Burke) and AB 378 (Garcia)
 - A 2/3 vote of Legislature would approve as tax



Solutions that move you

13

Other Potential Revenue

- State transportation funding package
 - Could provide additional funding for Transit & Intercity Rail Capital Program
- Regional Measure 3 (RM 3) toll bridge increase
 - MTC will begin developing expenditure plan once state transportation funding package is resolved
 - State legislation required – SB 594 (Beall)
 - MTC looking at putting RM 3 on ballot in 2018



Solutions that move you

14

Draft SEIS/SEIR Public Circulation Update

Tom Fitzwater, VTA



Draft SEIS/SEIR Update

Public Review Period

December 28, 2016 through March 6, 2017

Public Hearings (approximately 170 total attendees)

- 1/25 Mexican Heritage Plaza
- 1/26 Santa Clara Senior Center
- 1/30 San Jose City Hall

Summary of Commenters

- Approximately 110 Commenters
- Approximately 860 Individual Comments Received



Draft SEIS/SEIR Update

Summary of Comments Received

- Support for the project or support for various options
- Comments on the Project Description
 - Alternatives
 - Station locations
 - Ventilation structures
- Comments on Project Impacts
 - Traffic and circulation impacts during construction
 - Parking loss during and after construction in the Diridon Station area
 - Noise and vibration impacts during construction and operation



Single-Bore Technical Study Summary

Krishna Davey, VTA
Leyla Hedayat, VTA

Why VTA Considered Single-Bore

Renewed Planning Efforts (2014-2015)

- Impacts to street level activities and underground utilities
- Advances in the tunneling industry since 2008
- Feasibility of alternate tunneling methodologies
- Cost effective project delivery with minimal construction impact to the community

Preliminary Analysis of Single-Bore Methodology (2015)

- Determined feasible
- Reviewed with BART and FTA
- Included as option in environmental document

Single-Bore Tunnel Technical Studies (2016)

- HNTB awarded contract
- BART participation



Solutions that move you 19

Scope of Study

- Design Criteria and Key Assumptions
- Tunnel Diameter
- Tunnel Depth
- Track Alignment
- Operational Aspects
- Station Configuration
- Passenger Circulation
- Station and Tunnel Ventilation
- Emergency Egress
- Cost and Schedule



Solutions that move you 20

BART Phase II Single-Bore Tunnel Features

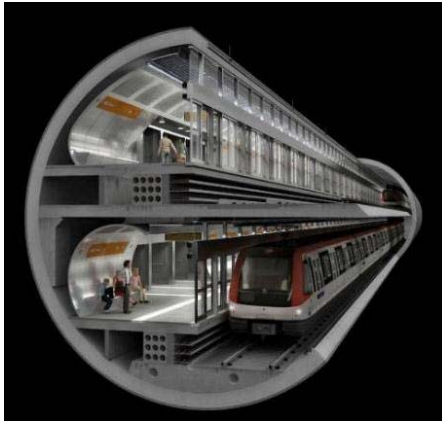

- Stacked platforms within tunnel
- Minimized surface construction impacts in public right-of-way
 - Cut-and-cover required at off-street station vertical circulation elements
 - Station entrances connect to tunnel via passageway
 - 76 cross passages within tunnel



Downtown San Jose Station Cross Section – Single-Bore

West Entrance Section

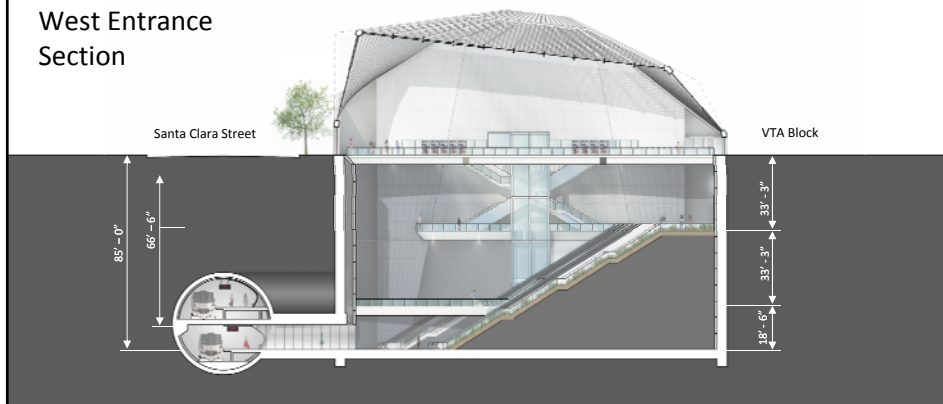

Single-Bore Tunnel Alignment



- LEGEND**
- STATION
 - STACKED
 - SIDE-BY-SIDE
 - CROSSOVER
 - TRANSITION



Tunnel Typical Sections

Side-By-Side Configuration

Tunnel Inner Diameter: 41 ft.
Tunnel Outer Diameter: 45 ft.

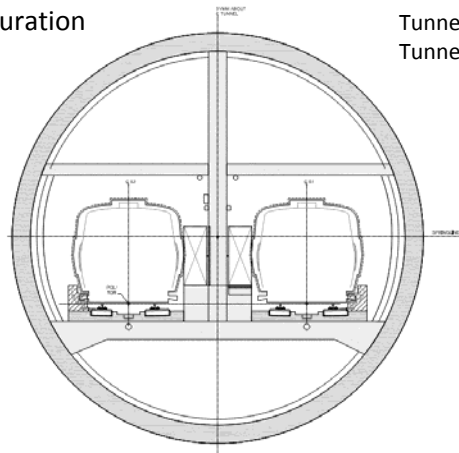

Tunnel Typical Sections

Stacked Configuration at Stations

- Unobstructed 15'-6" platform
- Exceeds BFS requirements:
 - 8-foot minimum unobstructed platform
 - 7 sf/person min. (LOS C)

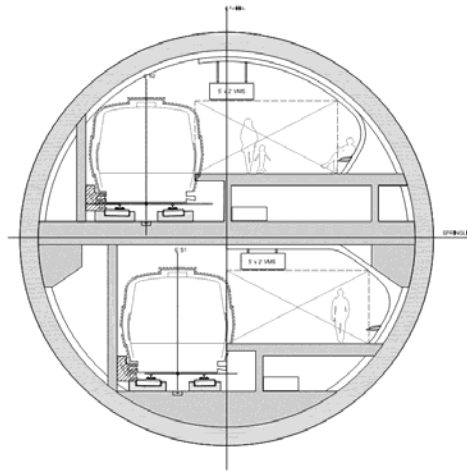

Station Interior

West Entrance Rendering- Concept



Results of Study

Draft final report completed indicating single-bore method under study meets industry standards for the following:

- Safe application in construction
- Accommodates critical functional, operational and maintenance requirements for underground stations and running tracks
- Complies with BART and industry safety standards.



Code and Standard Compliance

	National Fire Protection Association (NFPA) 130	BART Facility Standards (BFS) 3.0	California Building Code (CBC) 443	California Building Code (CBC) 903
Station Self Evacuation Timing	X			
Station Self Evacuation Spacing		X		
Mechanical Ventilation		X	X	
Fire Protection – Manual Standpipe	X	X		X
Fire Protection – Under Car Deluge				X
Fire Protection – Station Sprinklers				X



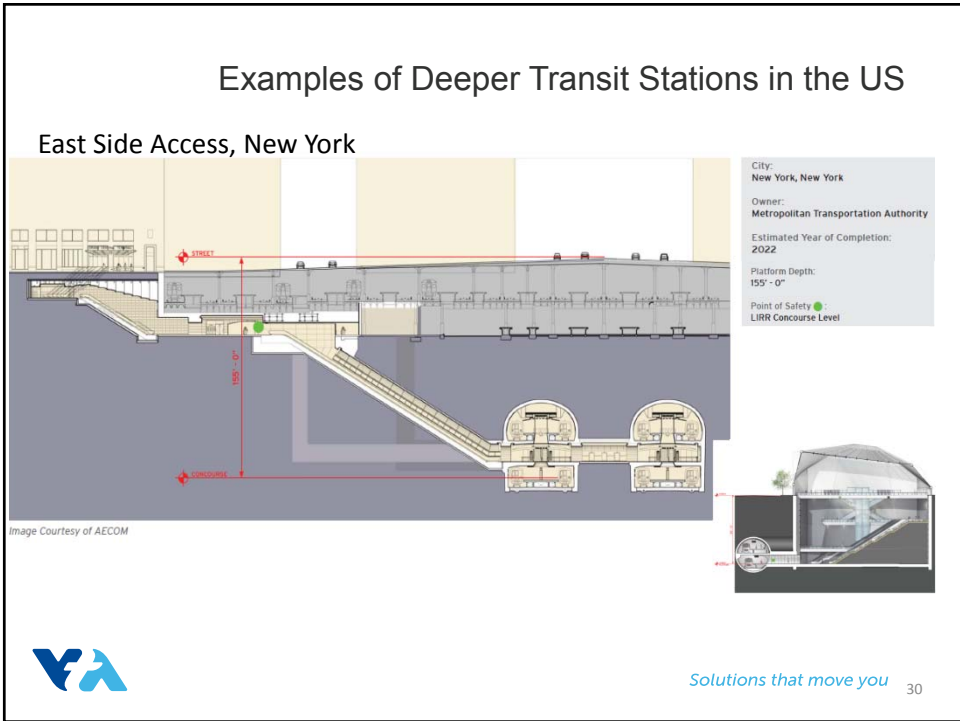
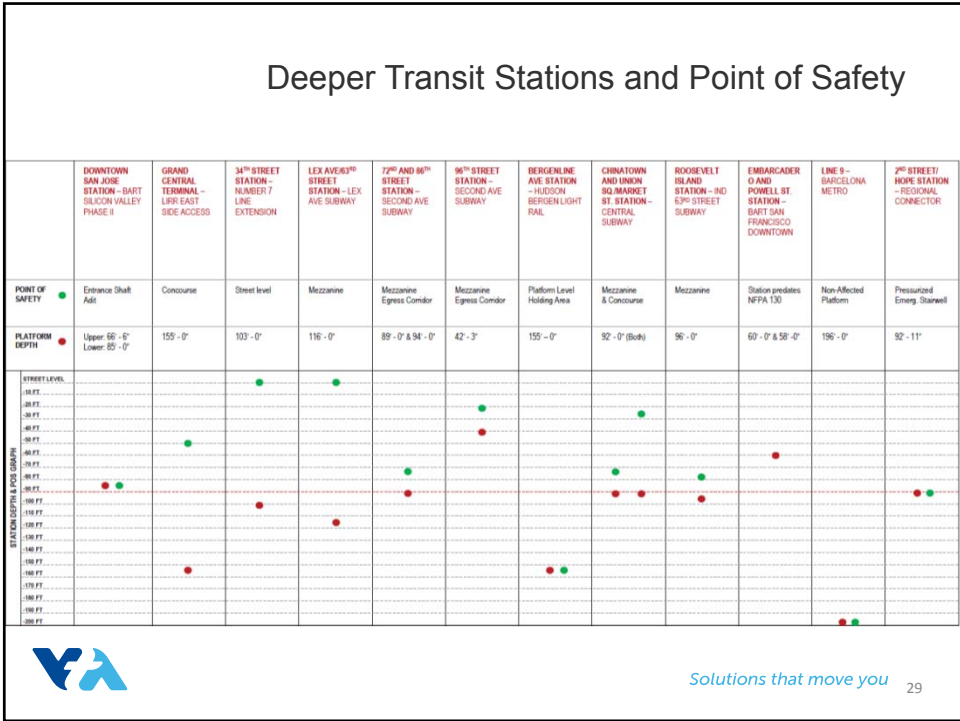

Examples of Deeper Transit Stations in the US

Second Avenue Subway 72nd Street Station, New York



Image Courtesy of AECOM

City:
New York, New York
Owner:
Metropolitan Transportation Authority,
New York City Transit
Year Completed:
2017
Platform Depth:
89' - 0"

Point of Safety ●
The concept includes back of the house
egress corridor at Mezzanine Level



Examples of Deeper Transit Stations in the US

Central Subway- Chinatown Station, San Francisco

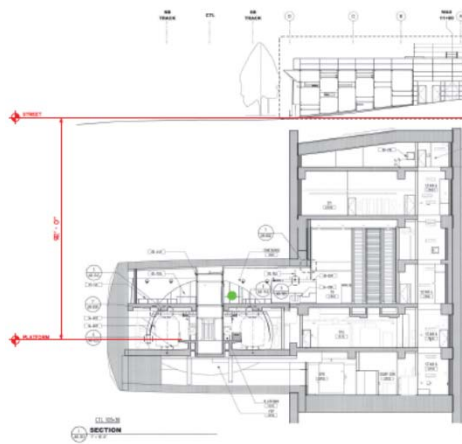

CL 50.5
SECTION
1:1/2"

City:
San Francisco, California
Owner:
San Francisco Municipal Transportation
Agency
Estimated Year of Completion:
2018
Platform Depth:
92' - 0"

Point of Safety ● :
Mezzanine



Single-Bore & Twin-Bore Comparative Analysis Update

Krishna Davey, VTA



33

Tunneling Methodology Comparative Analysis

- Independent comparative analysis of tunneling alternatives under consideration
- Analysis to evaluate risks (cost, schedule, performance) associated with tunneling alternatives
- Scope of work includes:
 - Interviews with technical experts and stakeholders
 - Qualitative & quantitative assessment
 - Development of risk profiles and report
- Consultant selected by a joint VTA/ BART review panel
- Contract awarded to Aldea Services LLC, Maryland
- Study underway and anticipated to be completed in June 2017



Solutions that move you 34

Diridon Transportation Facilities Master Plan Update

Leyla Hedayat, VTA



Study Context



- Develop a functional and operational program for the Diridon Station
- Ensure that transportation investments are optimized through seamless intermodal connectivity
- Continue a collaborative process with transit operators to build a functional facility that enhances and integrates with future development



Project Goals



Transportation Performance

- A station that works
- A plan that fits
- Flexible, adaptable concepts



Passenger Experience

- Convenient, comfortable
- energetic, inspiring



A Good Neighbor & Civic Gateway

- Compatible with existing neighborhoods and future development
- Respect an historic setting
- A new landmark

37

Technical Guidance

- Transit operators and city engaged on a monthly basis.
- Provided data, service plans, facility and operational needs, and technical criteria.
- Ensure that the facility design will function properly, and is integrated with current and future plans.
- Review, identify, and resolve conflicts among technical requirements.



Primary Activities: Master Plan Study

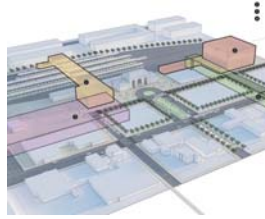
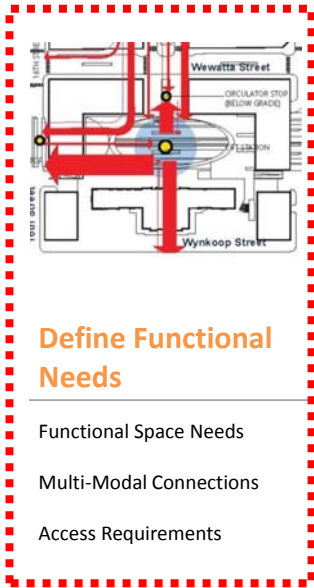

- Pedestrian Connections**
- Walking Distances
 - Level changes
 - Weather protection
 - Roadway Crossings
 - Wayfinding/Clarity

Define Functional Needs

- Functional Space Needs
- Multi-Modal Connections
- Access Requirements

Develop Scenarios

- Fit the required program elements to the site
- Accommodate wide range of outcomes

Evaluate the Scenarios

- Develop transparent, measurable criteria
- Determine strengths and weaknesses

Existing and Future Transit Levels



Existing vs. Future Boardings and Alightings at Diridon Station

	Existing (2016)	Future (2040)
Daily Boardings	8,733	69,070
Daily Alightings	8,733	69,070
Daily Boardings and Alightings	17,466	138,140



Solutions that move you 41

Transit Levels

Diridon Station Boardings by Mode by Year

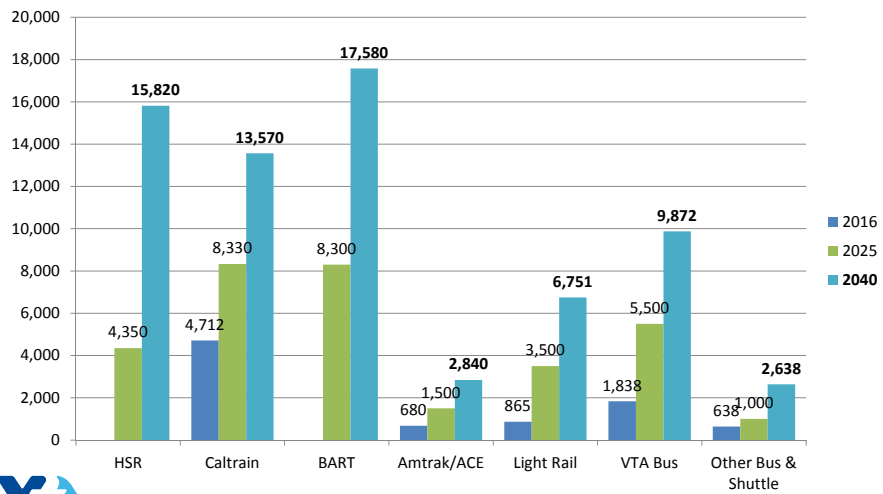

Solutions that move you 42

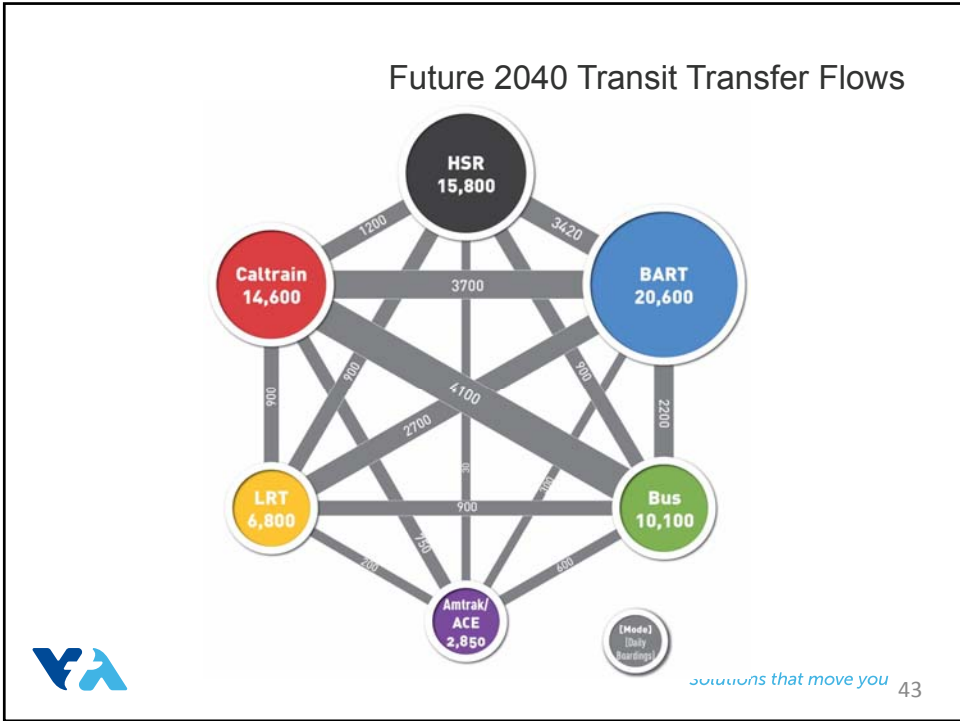

Multi-Modal Access Framework



Solutions that move you 44

Multi-Modal Access Planning

- **Multi-Modal Service Needs:** transit ridership, service plans, mode of access and egress, intermodal transfers
- **Access Study:** auto, bicycle, pedestrian, drop off/pick up, transit buses, shuttles, special event circulation paths
- **Parking Policy:** joint development and station based vehicular uses (zipcars, future autonomous vehicles, public spaces, rental cars)



Solutions that move you 45

Objectives of the Parking Policy Study



- Present **alternative policies** regarding new and replacement parking quantities
- Consider **nationwide precedents**
- **Calculate new parking needs** resulting from the Master Plan



Solutions that move you 46

What Does the Parking Policy Cover?



Potential station-related joint development sites:

- Transit Center
- (H) Station East
- (G) Station South



Parking Program Variables

Pedestrian / Bike / Transit Focus

Automobile Focus



Complementary Uses High Sharing

No Sharing



Large offsite capacity

No offsite capacity



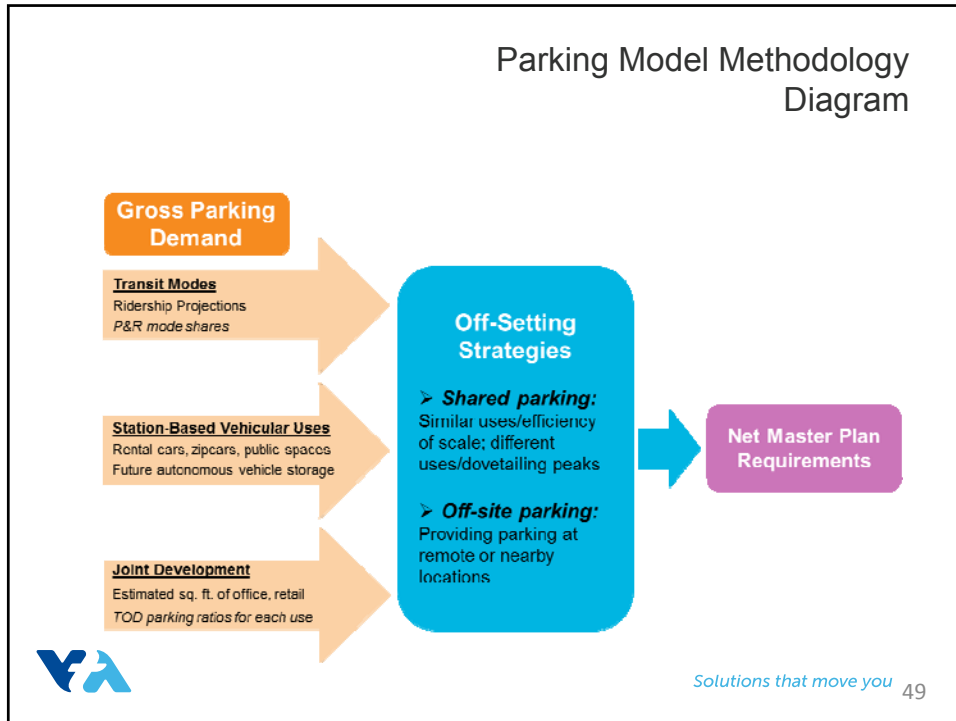

Functional Space Program & Identification of Scenarios

 Solutions that move you 50

Functional Program Overview

Functional Category	Net Sq. Feet (NSF)	Building Gross Sq. Feet (BGSF)
Transit Operations	136,469	166,468
Passenger Services	74,551	82,992
Station Management	14,774	26,788
Building Infrastructure	8,928	13,346
Retail	11,152	13,661
Bicycle Facilities	8,000	11,960
Police	1,037	1,773
Total - Transit Facilities (sq ft)	254,911	316,988
Potential Joint Development	TBD	TBD
Potential Additional Retail	TBD	TBD
Potential Parking	TBD	TBD
Potential Total - All Facilities (sq ft)	TBD	TBD



Identification and Evaluation of Scenarios

- Develop Screening Criteria
- Develop Transportation Facility and Access Scenarios
- Evaluate Scenarios
- Refine Final Scenarios(s)



Evaluation Criteria

Transportation Performance	Passenger Experience	Great Civic Asset
“A Station That Works”	“A Superior Passenger Experience”	“Community and Context”



Solutions that move you 53

Two-tiered Evaluation

Comparison of Components

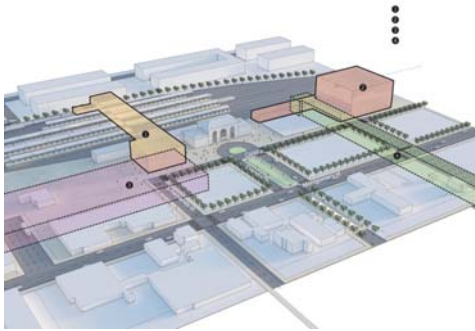

- Evaluation of four scenarios

HSR Alignment	Aerial	At-grade	
BART Alignment	North	South	
BART Tunnel	Single Bore	Twin Bore	
LRT Alignment	Existing	Depressed	Relocated
ACS (APM) Alignment	West of SAP	East of SAP	
Transit Bus Center	Structured	Below-grade	
Coach Bus Center	Structured	Below-grade	
Parking Program	Lower	Higher	
Primary Entrance	Southeast	Existing Sta	Northeast
Access from West	Existing Property	Add Property	BART Concourse
Historic Station Use	Transit	Retail/Other	
Intermodal Integration	“Stacked”	Moderate	“District”
PG&E Substation	Existing	Relo/Recon	
Street Network	Cahill Ext		
Other	Consolidate Substations	Major Retail	



ou 54

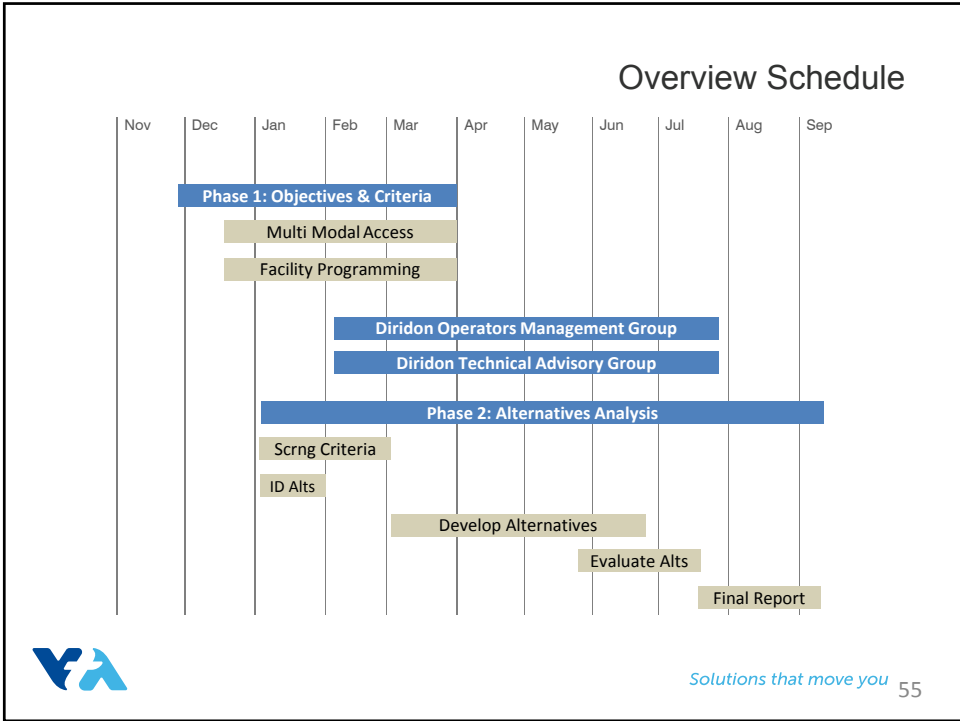

Questions?



Santa Clara Valley
Transportation
Authority

Solutions that move you

Next Steps

Eileen Goodwin, Facilitator



Next Steps

- Next CWG meeting: Tuesday, June 13, 2017 ~ 12:30-3:30 PM, meet at The VTA Block parking lot, 64 North Market Street, San Jose~ BYOB
 - Phase I Tour
 - Construction Outreach Plan
 - Lessons Learned from Phase I and BRT
- Parking Lot Items
- Action Items

