



## Appendix A: CAD Base Maps



# Tasman Corridor

## COMPLETE STREETS STUDY

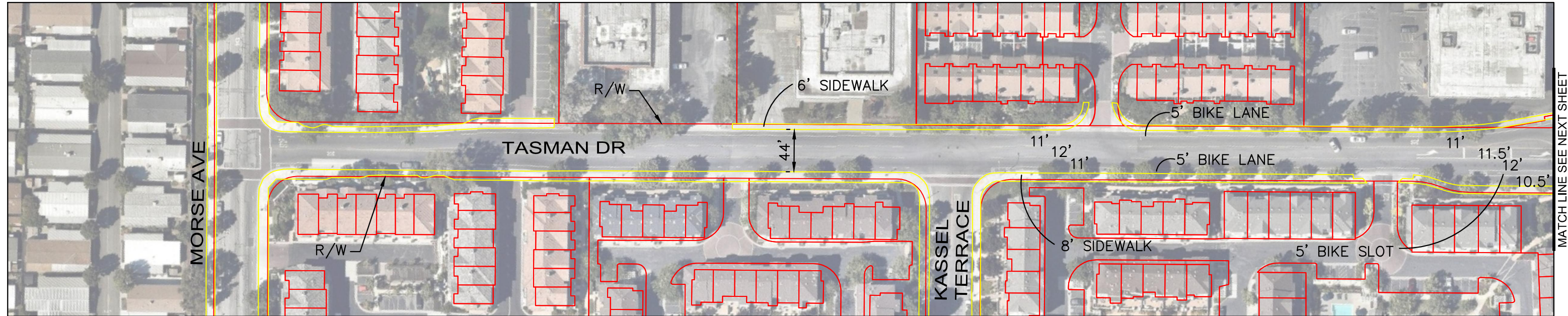

### LEGEND

- RIGHT OF WAY/PROPERTY LINE
- CURB/SIDEWALK
- - - CITY BOUNDARY

BASE MAP  
APRIL 2017  
SHEET 1 OF 28

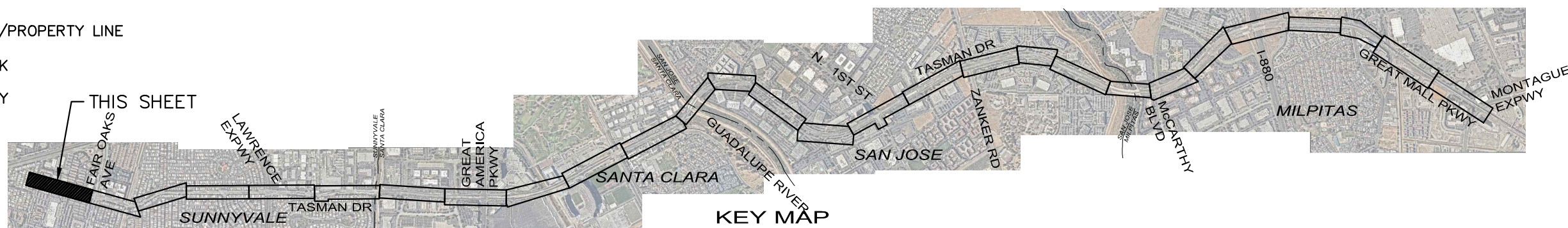

KEY MAP  
NOT TO SCALE

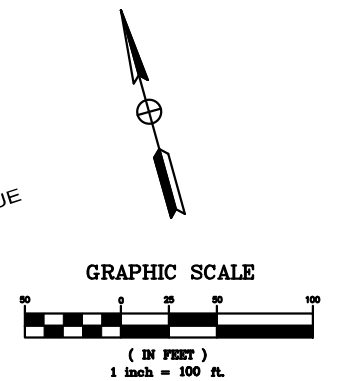



# Tasman Corridor

## COMPLETE STREETS STUDY

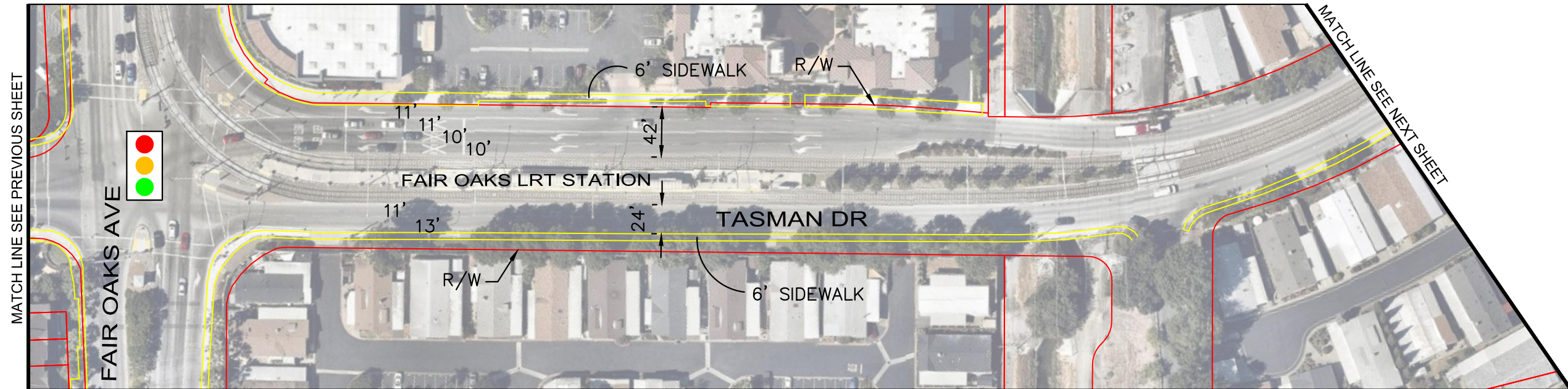

### LEGEND

- RIGHT OF WAY/PROPERTY LINE
- CURB/SIDEWALK
- - - CITY BOUNDARY

BASE MAP  
APRIL 2017  
SHEET 2 OF 28

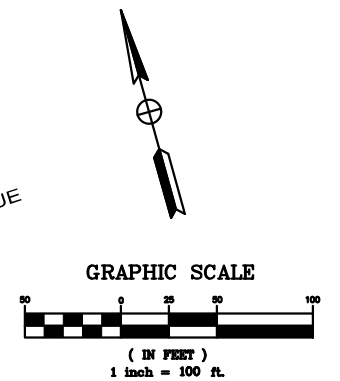
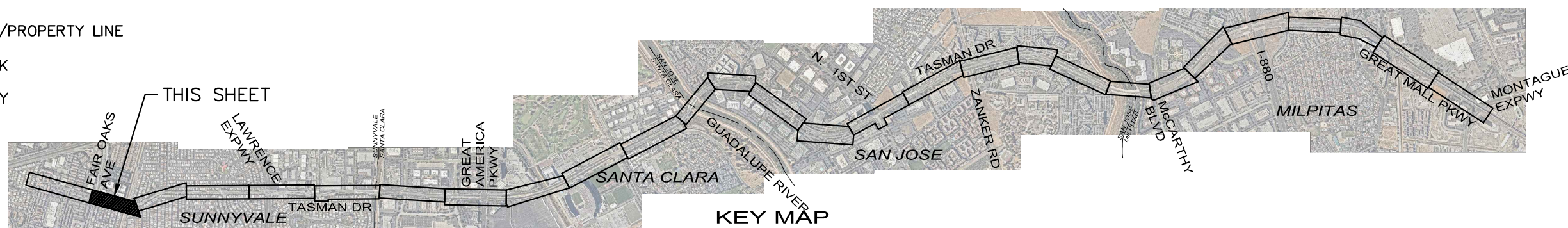



# Tasman Corridor

## COMPLETE STREETS STUDY

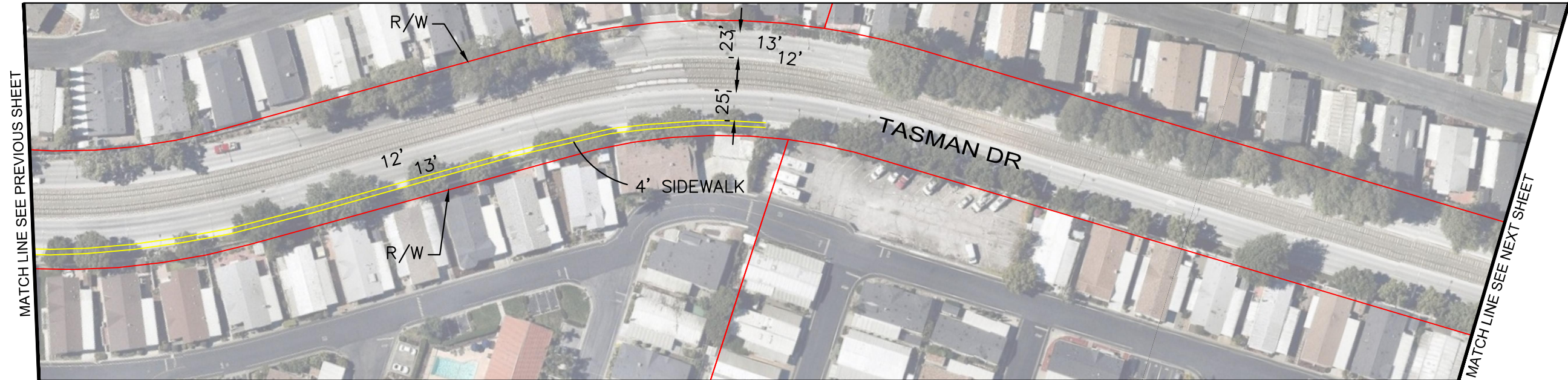

### LEGEND

- RIGHT OF WAY/PROPERTY LINE
- CURB/SIDEWALK
- CITY BOUNDARY

BASE MAP  
APRIL 2017  
SHEET 3 OF 28

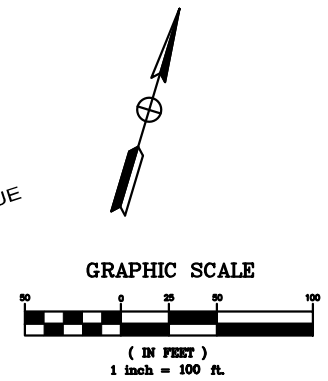
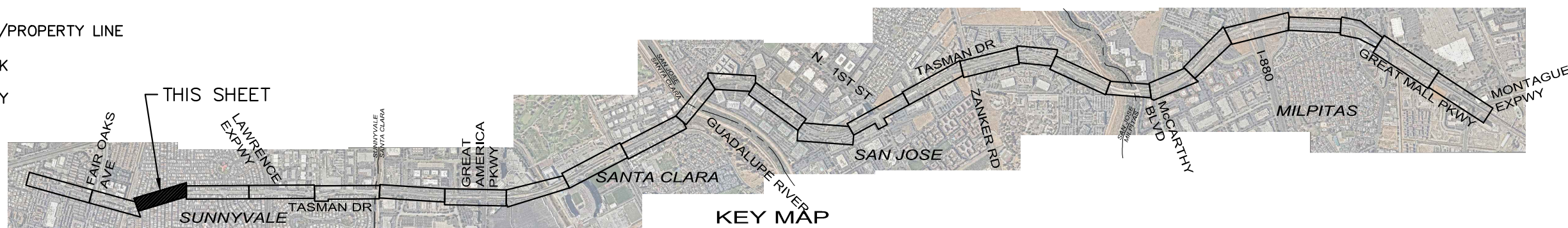



# Tasman Corridor COMPLETE STREETS STUDY

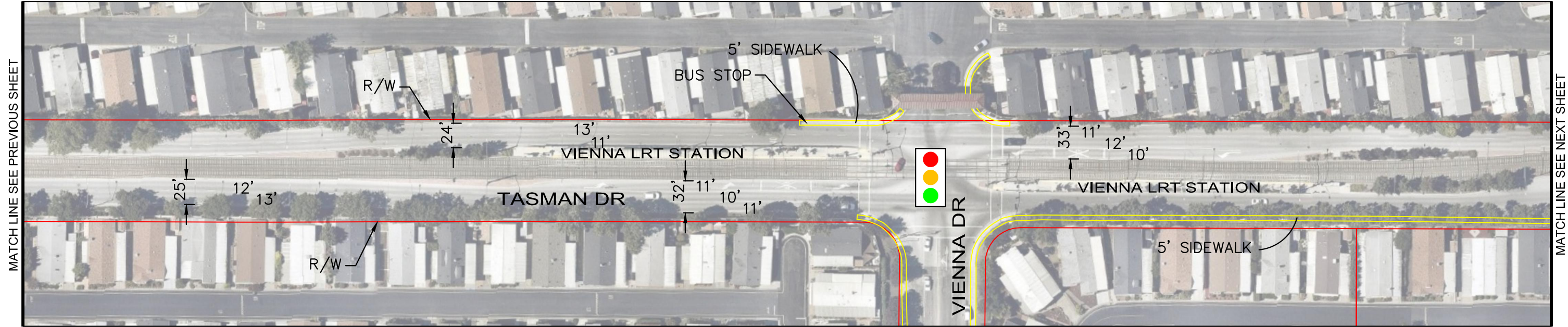

### LEGEND

- RIGHT OF WAY/PROPERTY LINE
- CURB/SIDEWALK
- CITY BOUNDARY

BASE MAP  
APRIL 2017  
SHEET 4 OF 28

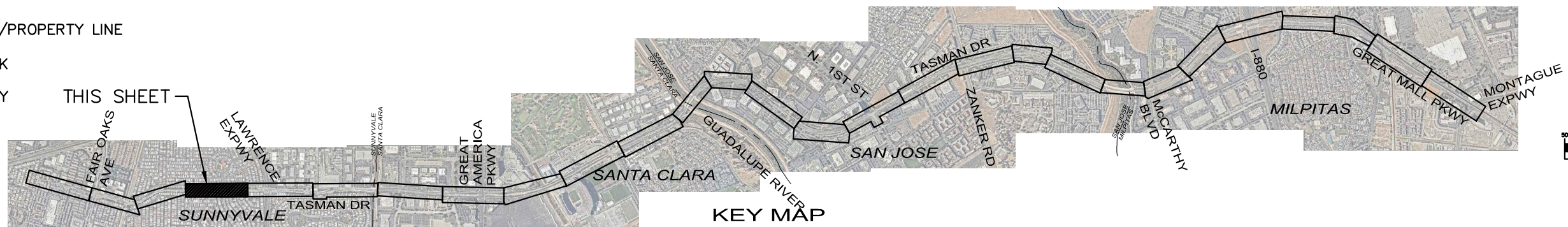

KEY MAP  
NOT TO SCALE

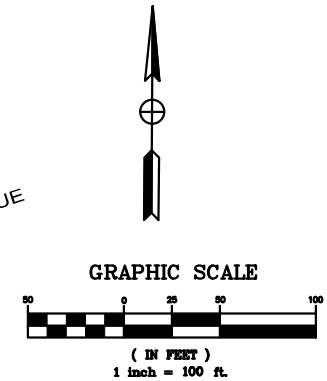



# Tasman Corridor

## COMPLETE STREETS STUDY

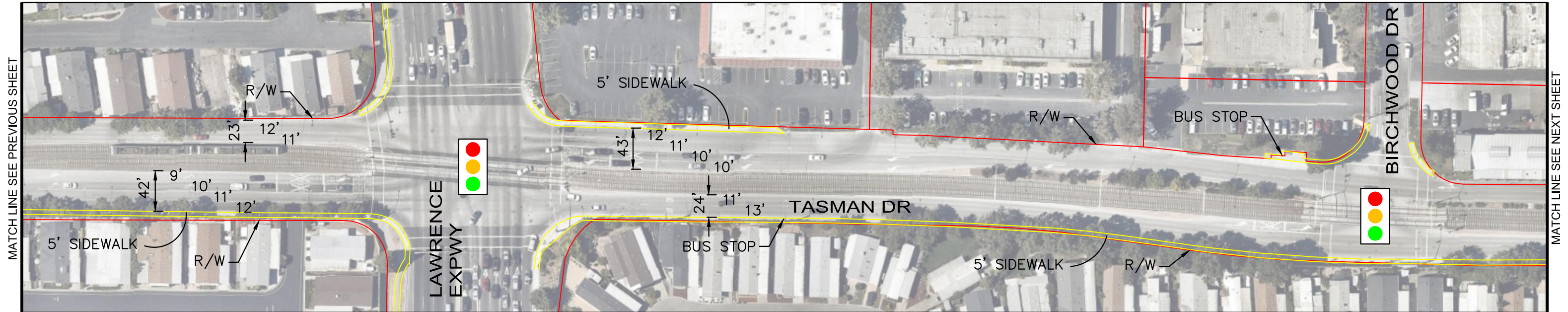

### LEGEND

- RIGHT OF WAY/PROPERTY LINE
- CURB/SIDEWALK
- - - CITY BOUNDARY

BASE MAP  
APRIL 2017  
SHEET 5 OF 28

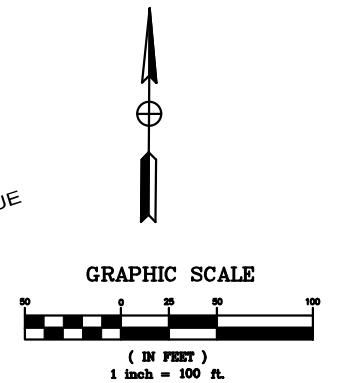
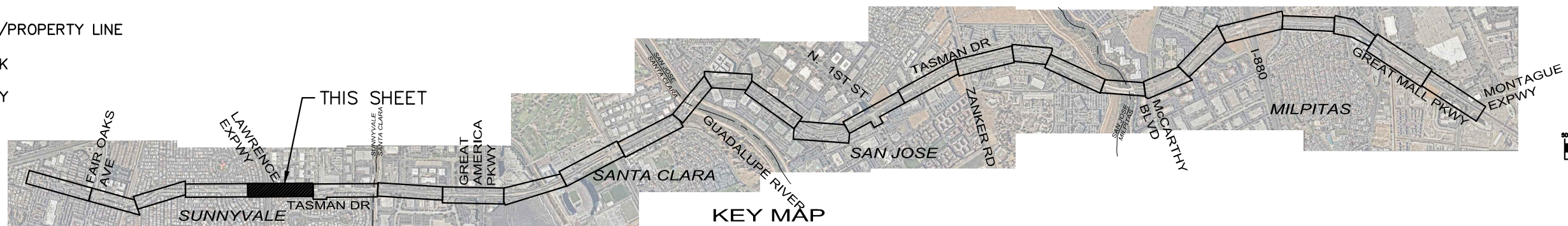



# Tasman Corridor

## COMPLETE STREETS STUDY

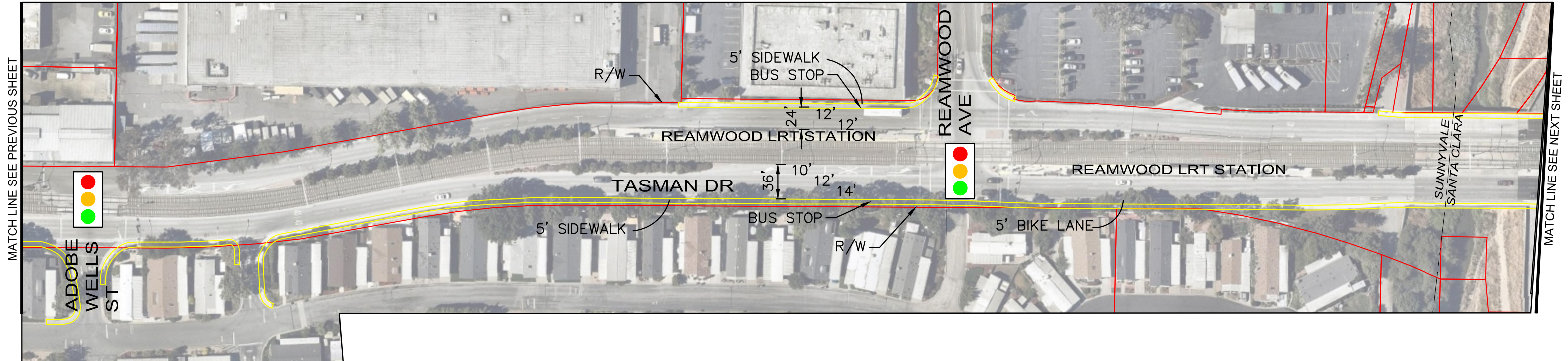

### LEGEND

- RIGHT OF WAY/PROPERTY LINE
- CURB/SIDEWALK
- - - CITY BOUNDARY

BASE MAP  
APRIL 2017  
SHEET 6 OF 28

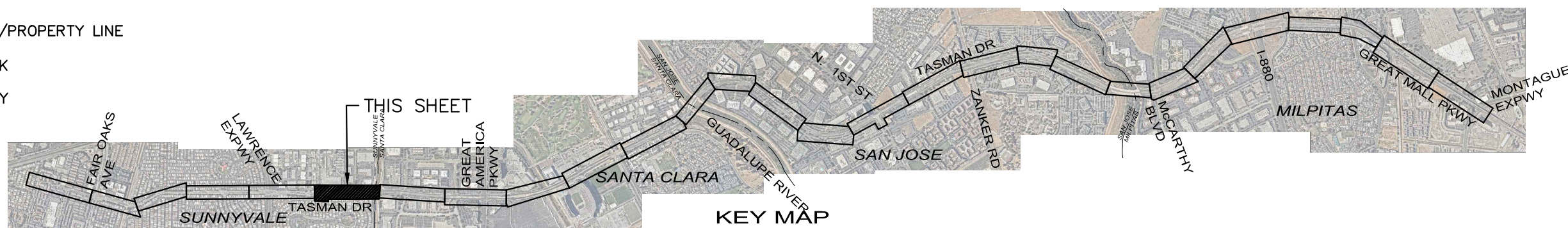

KEY MAP  
NOT TO SCALE

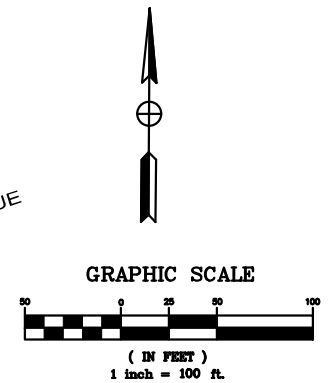



# Tasman Corridor COMPLETE STREETS STUDY

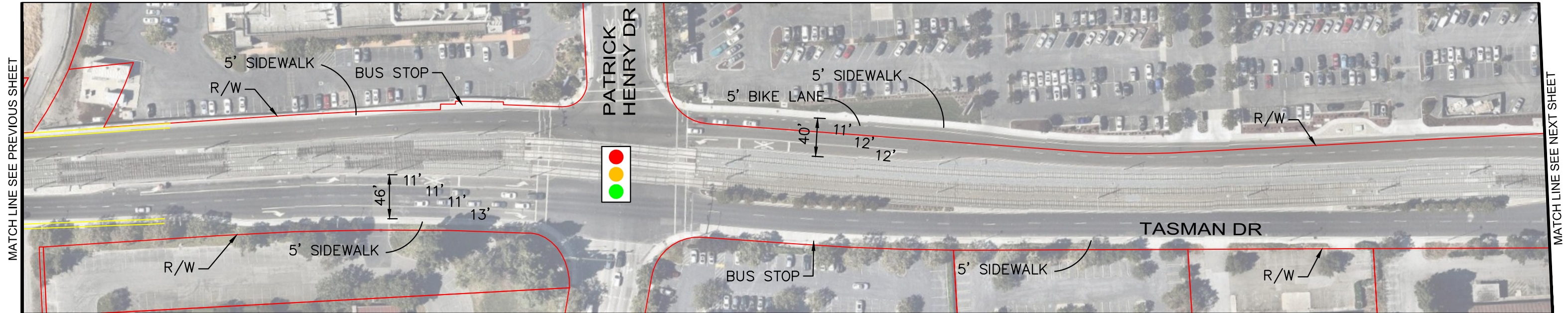

## LEGEND

- RIGHT OF WAY/PROPERTY LINE
- CURB/SIDEWALK
- - - CITY BOUNDARY

BASE MAP  
APRIL 2017  
SHEET 7 OF 28

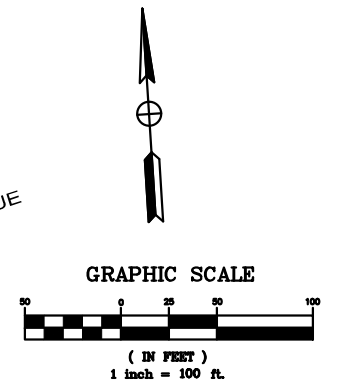
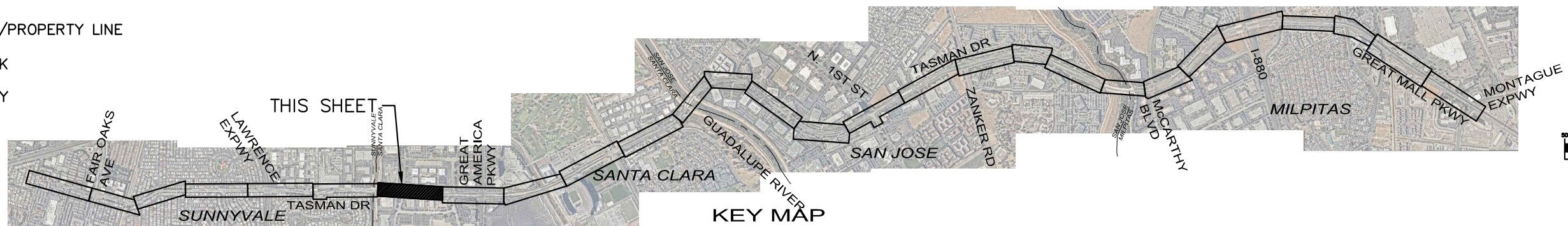



# Tasman Corridor COMPLETE STREETS STUDY

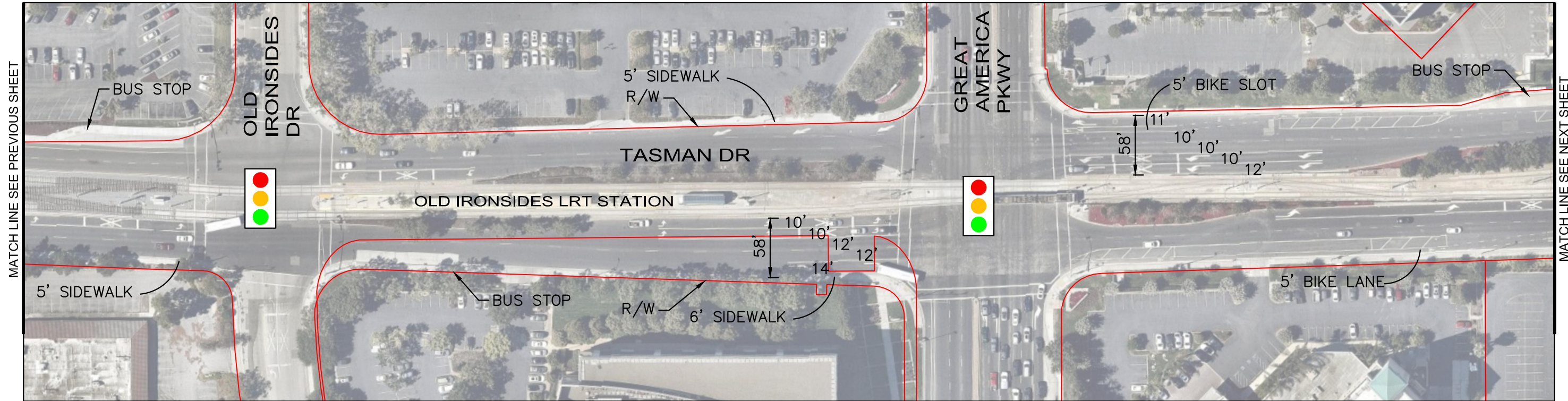

## LEGEND

- RIGHT OF WAY/PROPERTY LINE
- CURB/SIDEWALK
- - - CITY BOUNDARY

BASE MAP  
APRIL 2017  
SHEET 8 OF 28

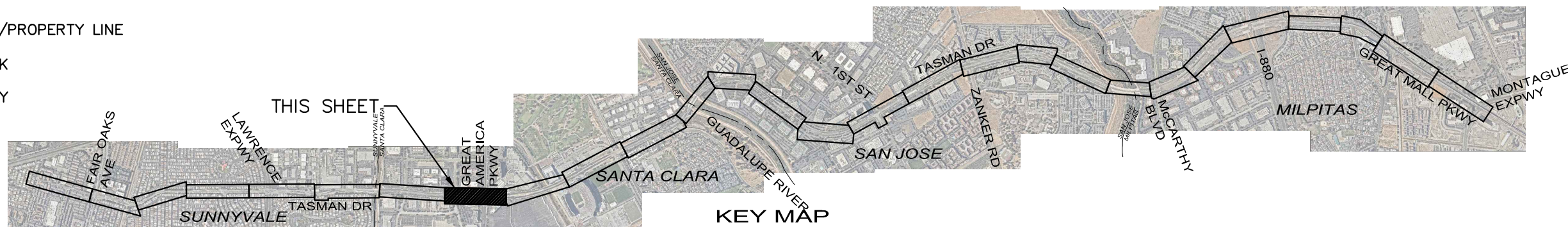

KEY MAP  
NOT TO SCALE

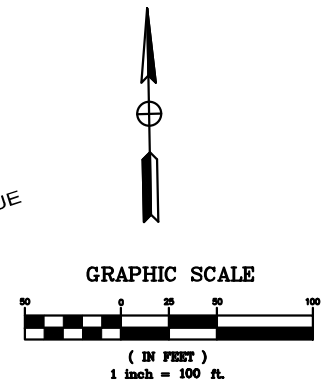



# Tasman Corridor

## COMPLETE STREETS STUDY

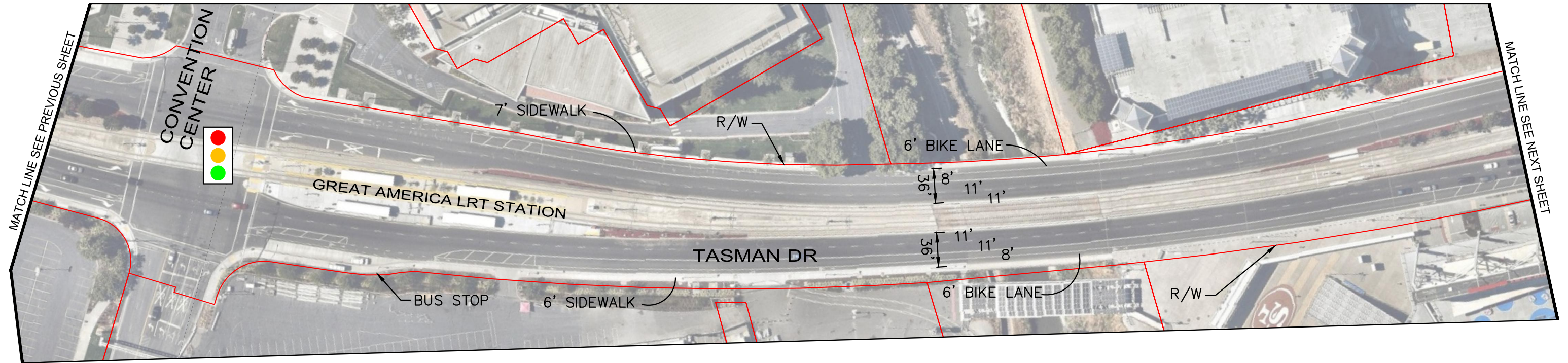

### LEGEND

- RIGHT OF WAY/PROPERTY LINE
- CURB/SIDEWALK
- - - CITY BOUNDARY

BASE MAP  
APRIL 2017  
SHEET 9 OF 28

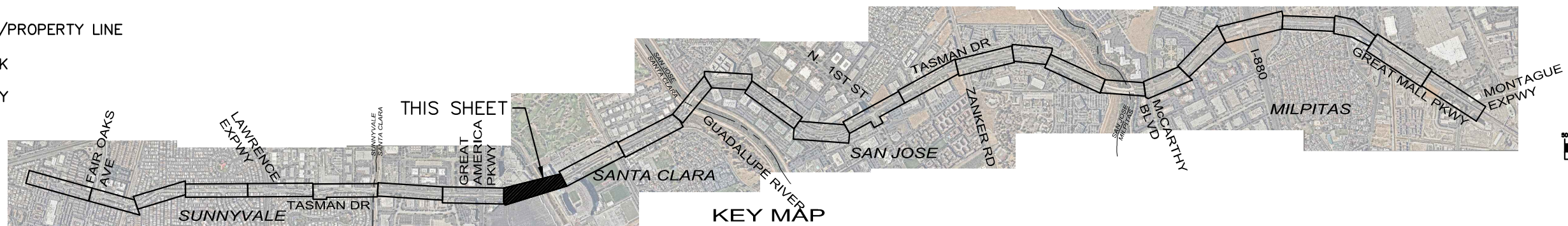

KEY MAP  
NOT TO SCALE

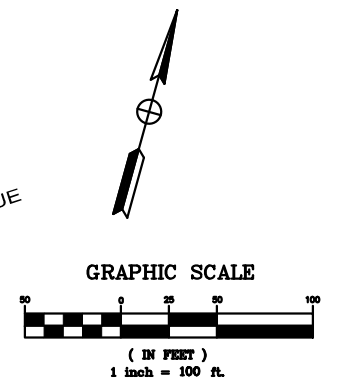



# Tasman Corridor

## COMPLETE STREETS STUDY

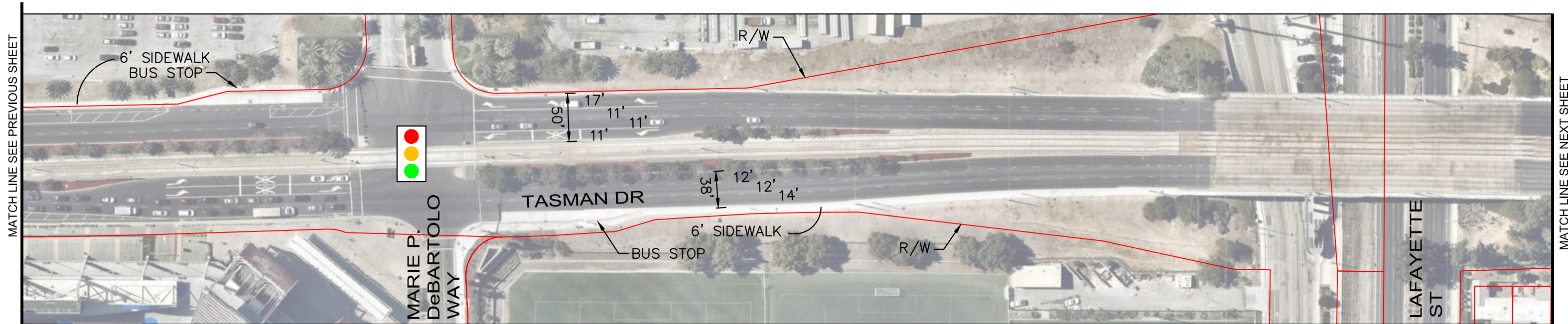

### LEGEND

- RIGHT OF WAY/PROPERTY LINE
- CURB/SIDEWALK
- - - CITY BOUNDARY

BASE MAP  
APRIL 2017  
SHEET 10 OF 28

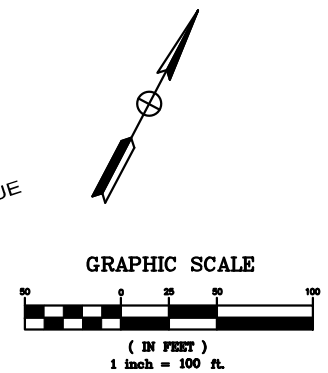
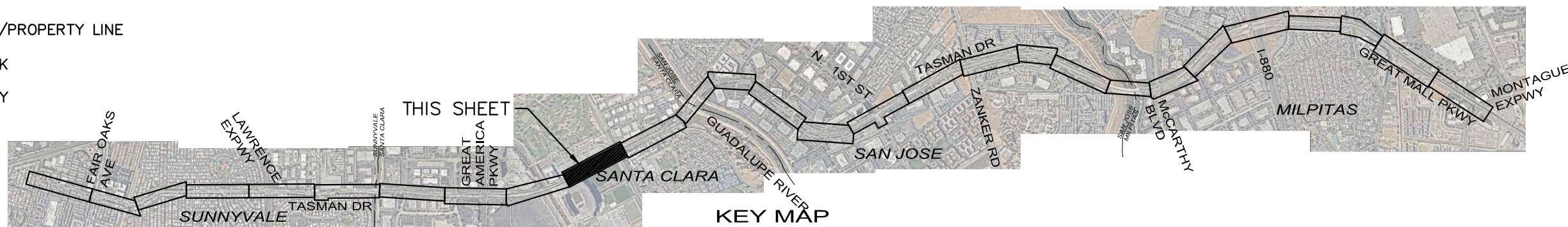



# Tasman Corridor COMPLETE STREETS STUDY

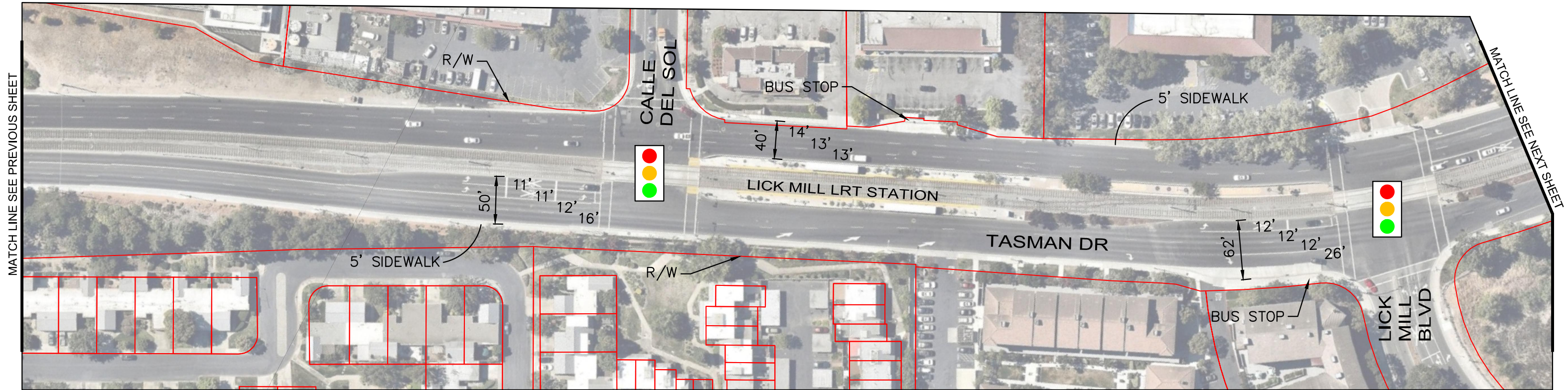

## LEGEND

- RIGHT OF WAY/PROPERTY LINE
- CURB/SIDEWALK
- - - CITY BOUNDARY

BASE MAP  
APRIL 2017  
SHEET 11 OF 28

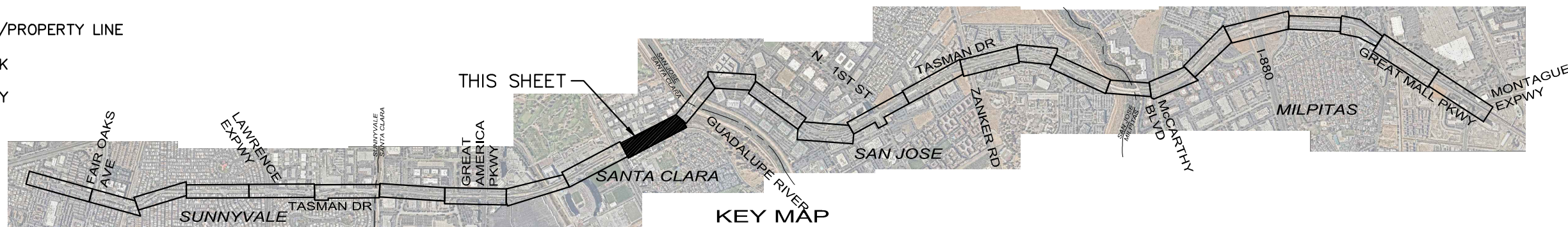

KEY MAP  
NOT TO SCALE

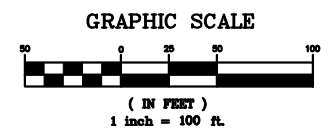
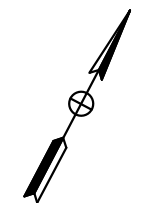



# Tasman Corridor

## COMPLETE STREETS STUDY

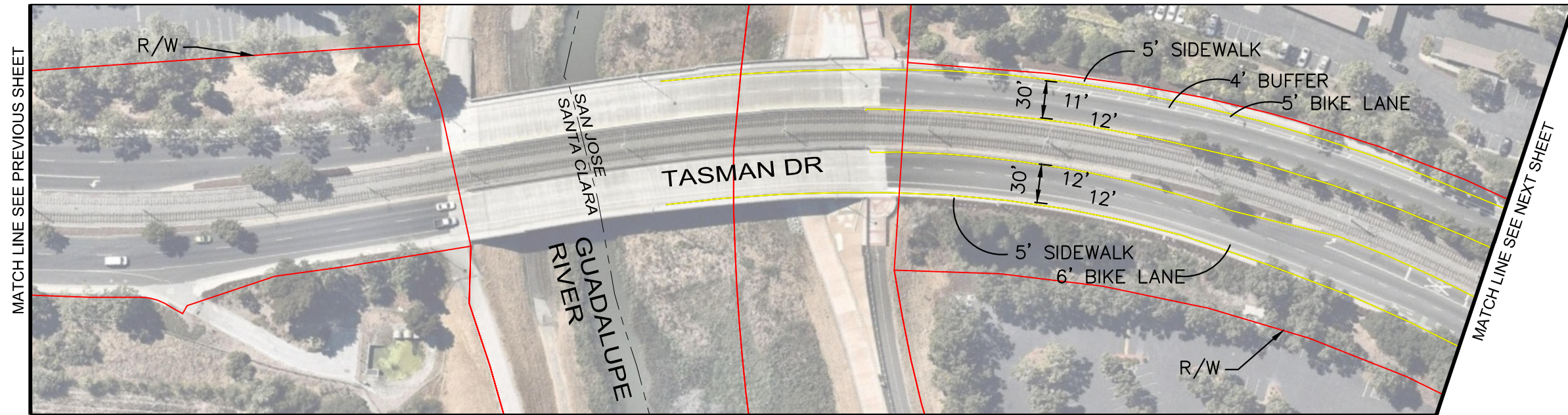

### LEGEND

- RIGHT OF WAY/PROPERTY LINE
- CURB/SIDEWALK
- - - CITY BOUNDARY

BASE MAP  
APRIL 2017  
SHEET 12 OF 28

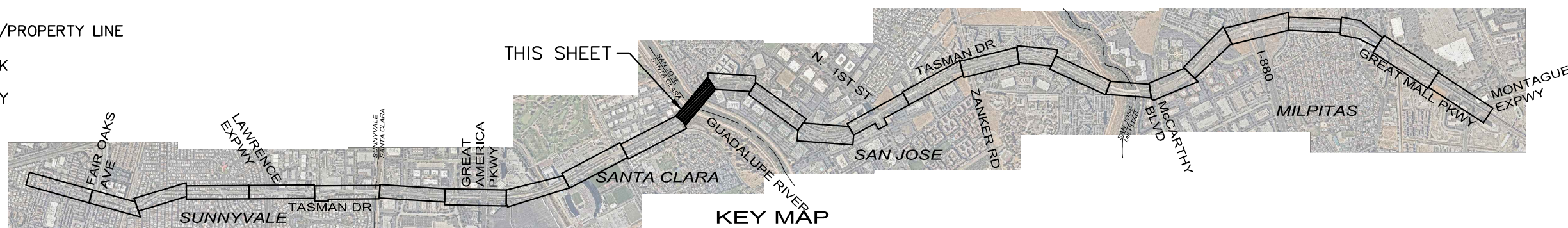

KEY MAP  
NOT TO SCALE

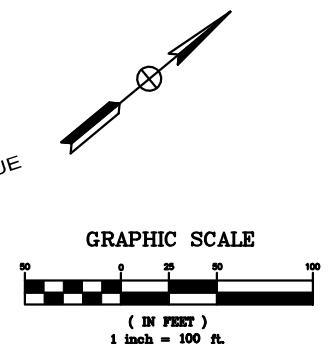



# Tasman Corridor

## COMPLETE STREETS STUDY

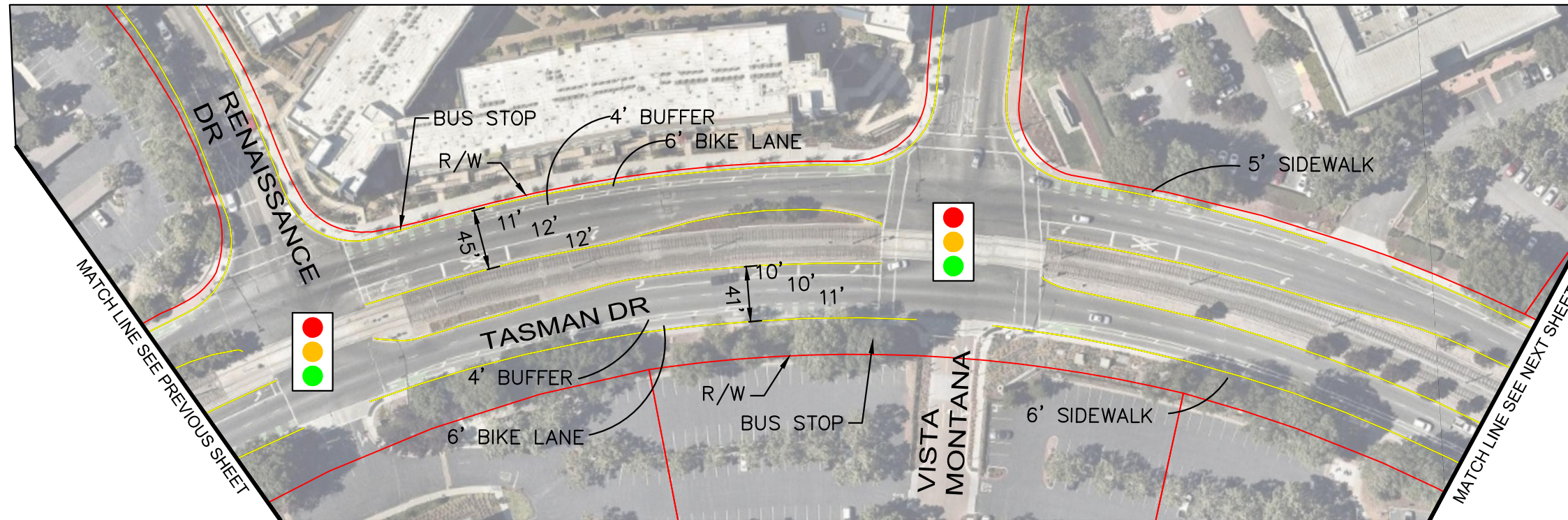

### LEGEND

- RIGHT OF WAY/PROPERTY LINE
- CURB/SIDEWALK
- - - CITY BOUNDARY

BASE MAP  
APRIL 2017  
SHEET 13 OF 28

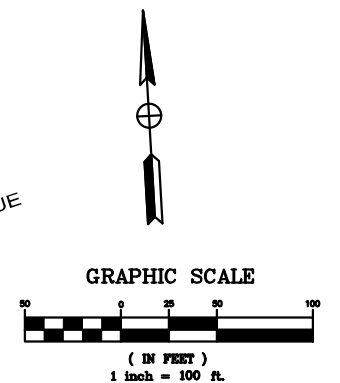
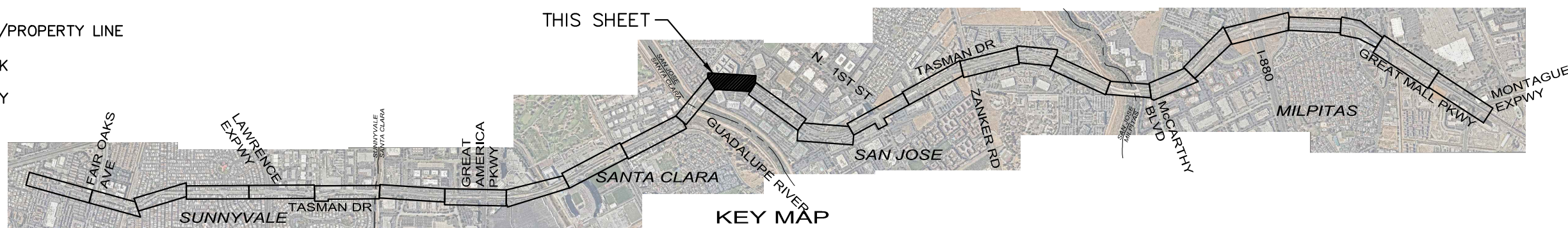



# Tasman Corridor

## COMPLETE STREETS STUDY

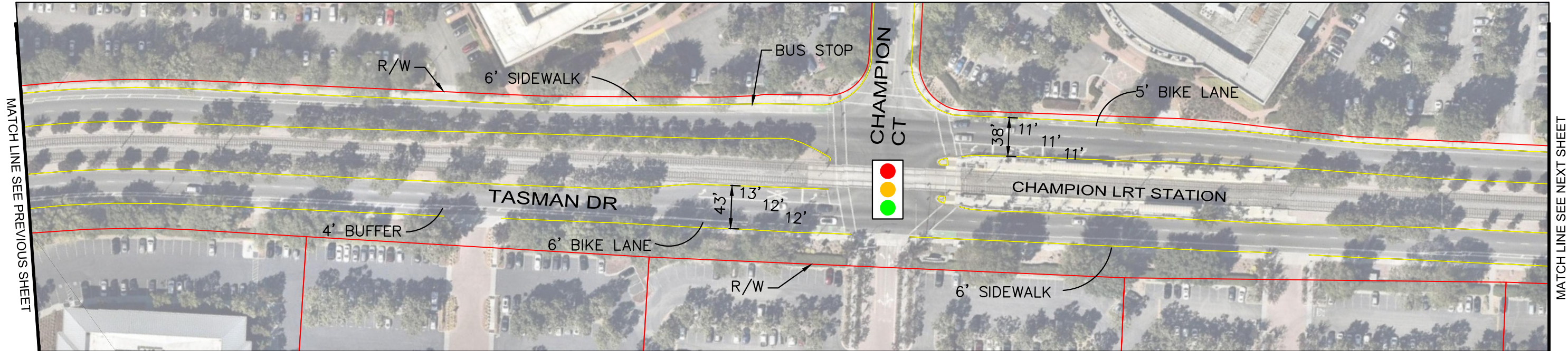

MATCH LINE SEE PREVIOUS SHEET

MATCH LINE SEE NEXT SHEET

### LEGEND

- RIGHT OF WAY/PROPERTY LINE
- CURB/SIDEWALK
- - - CITY BOUNDARY

BASE MAP  
APRIL 2017  
SHEET 14 OF 28

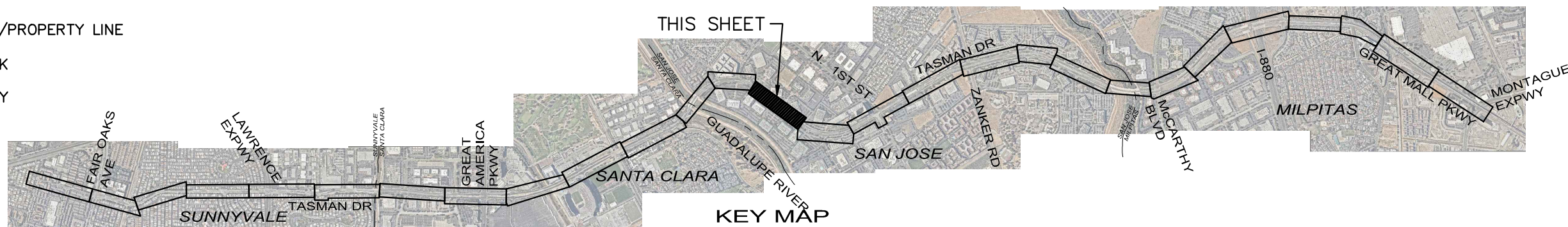

KEY MAP  
NOT TO SCALE

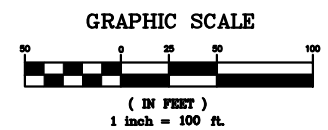
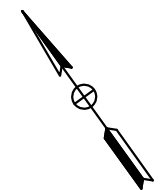



# Tasman Corridor COMPLETE STREETS STUDY

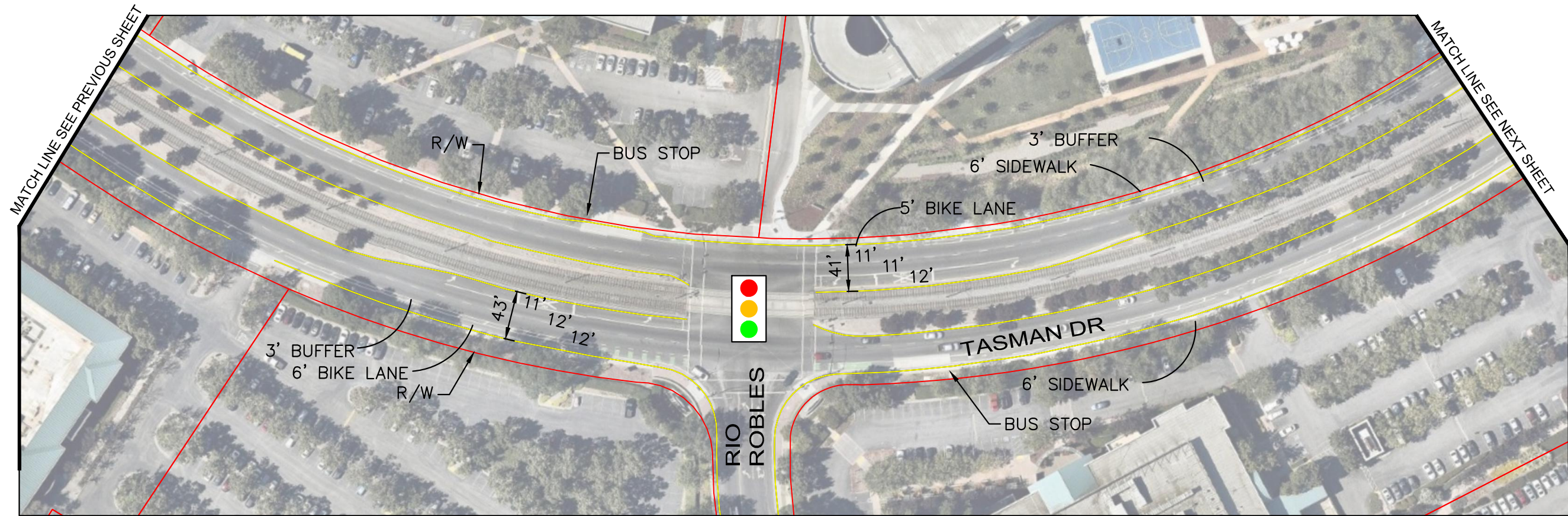

### LEGEND

- RIGHT OF WAY/PROPERTY LINE
- CURB/SIDEWALK
- - - CITY BOUNDARY

BASE MAP  
APRIL 2017  
SHEET 15 OF 28

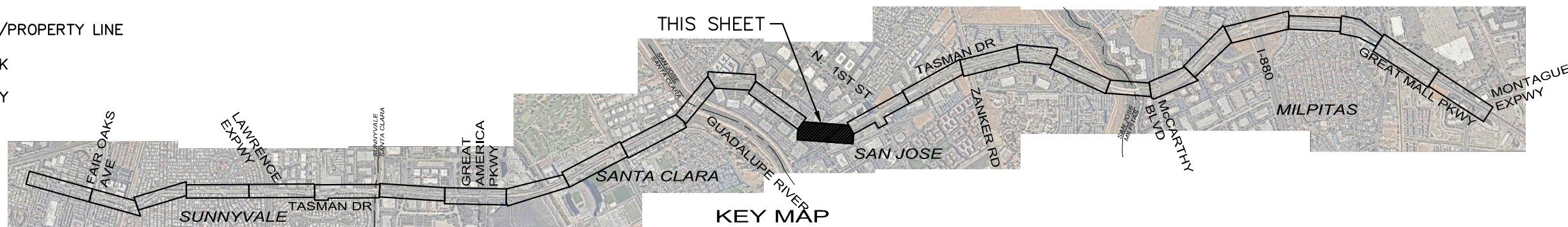

KEY MAP  
NOT TO SCALE

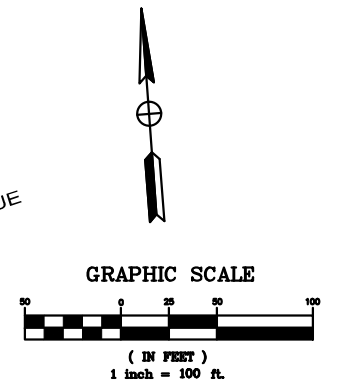



# Tasman Corridor

## COMPLETE STREETS STUDY

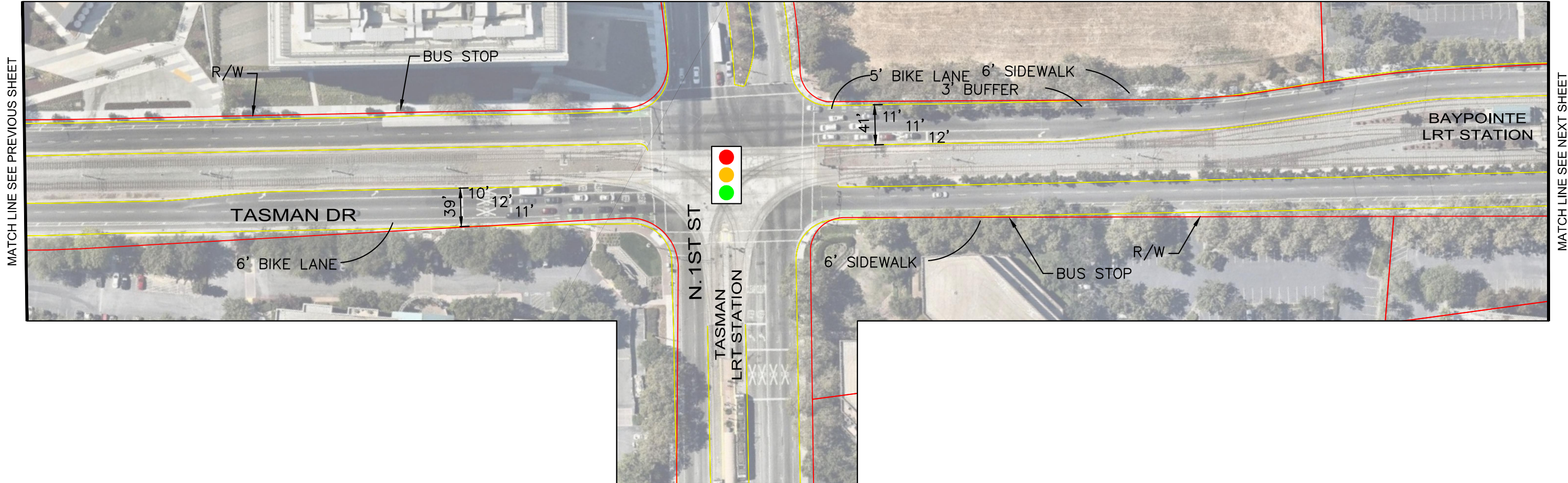

### LEGEND

- RIGHT OF WAY/PROPERTY LINE
- CURB/SIDEWALK
- - - CITY BOUNDARY

BASE MAP  
APRIL 2017  
SHEET 16 OF 28

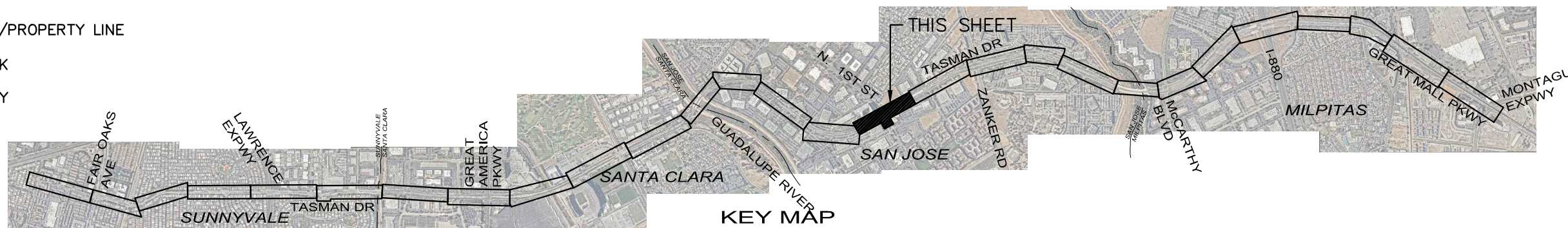

KEY MAP  
NOT TO SCALE

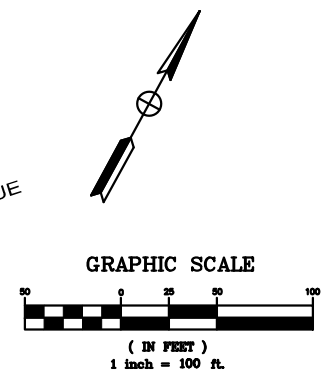



# Tasman Corridor

## COMPLETE STREETS STUDY

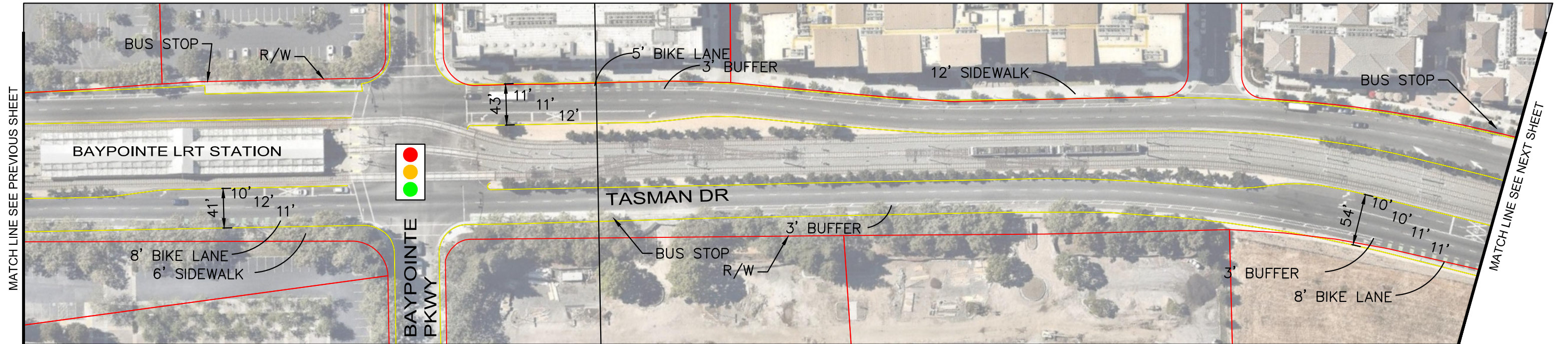

### LEGEND

- RIGHT OF WAY/PROPERTY LINE
- CURB/SIDEWALK
- - - CITY BOUNDARY

BASE MAP  
APRIL 2017  
SHEET 17 OF 28

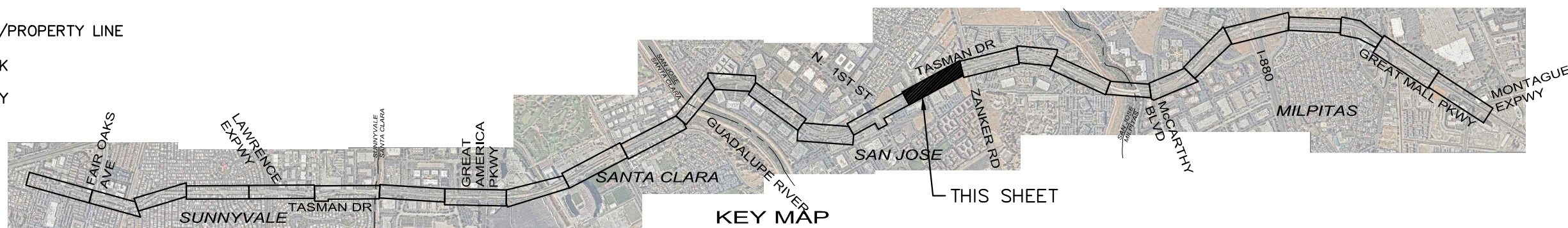

KEY MAP  
NOT TO SCALE

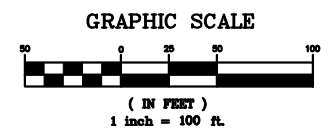
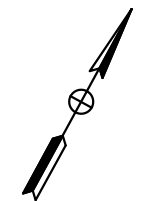



# Tasman Corridor COMPLETE STREETS STUDY

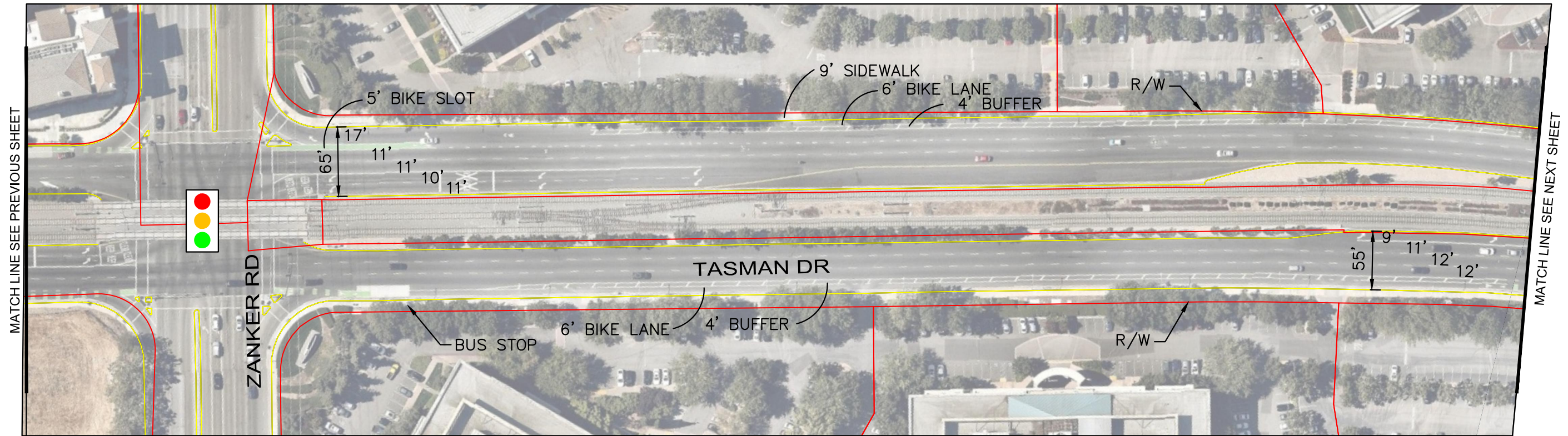

### LEGEND

- RIGHT OF WAY/PROPERTY LINE
- CURB/SIDEWALK
- - - CITY BOUNDARY

BASE MAP  
APRIL 2017  
SHEET 18 OF 28

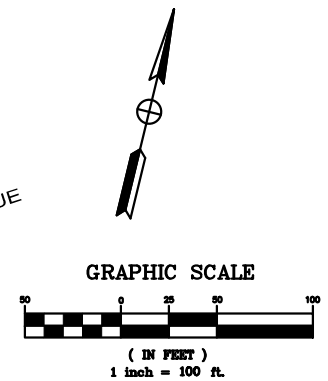
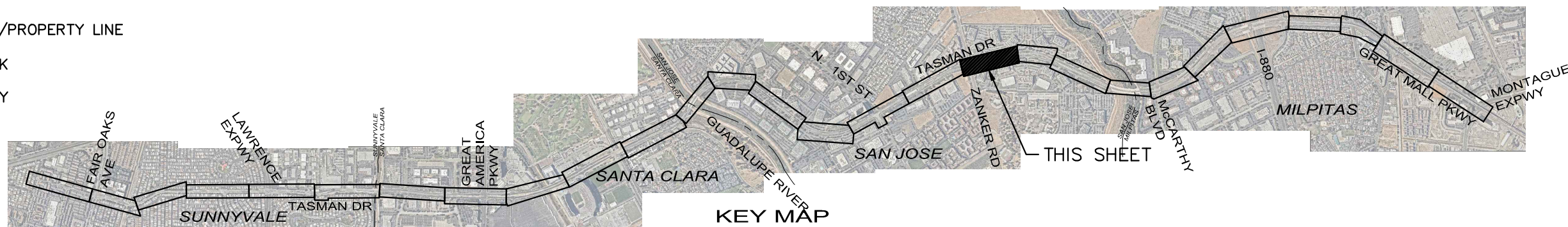



# Tasman Corridor COMPLETE STREETS STUDY

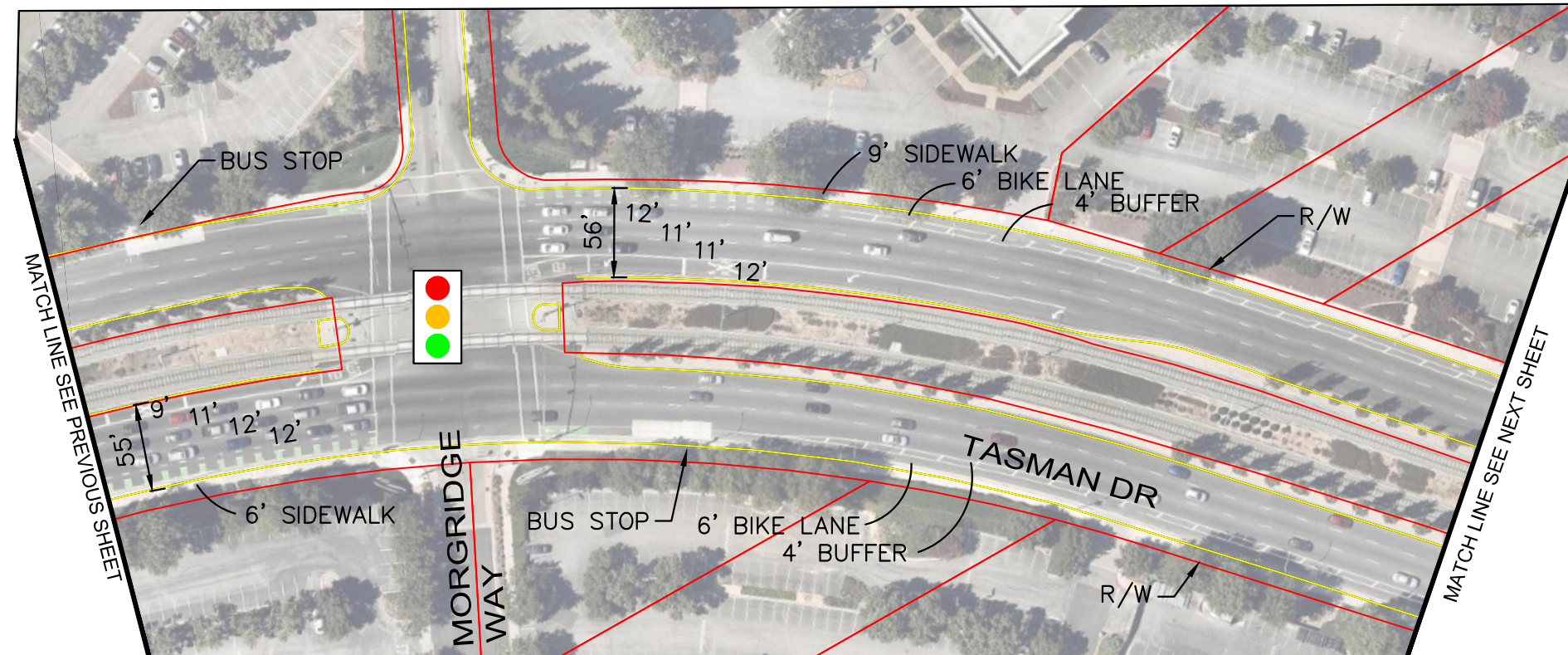

### LEGEND

- RIGHT OF WAY/PROPERTY LINE
- CURB/SIDEWALK
- - - CITY BOUNDARY

BASE MAP  
APRIL 2017  
SHEET 19 OF 28

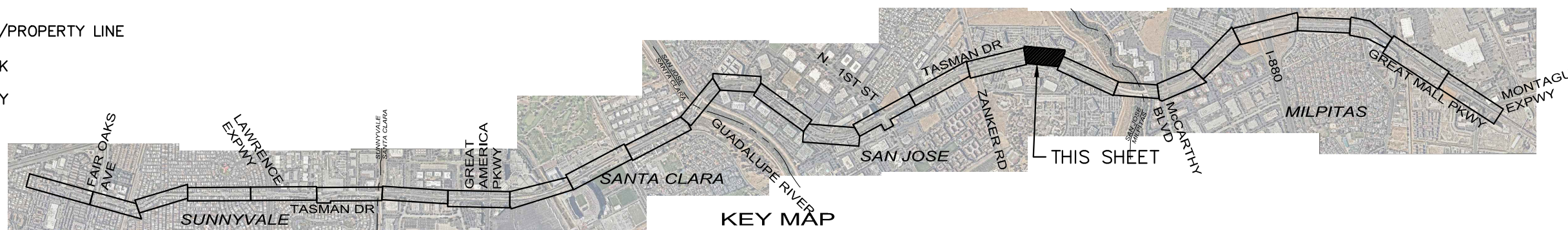

KEY MAP  
NOT TO SCALE

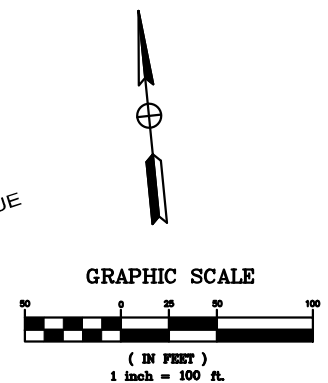



# Tasman Corridor

## COMPLETE STREETS STUDY

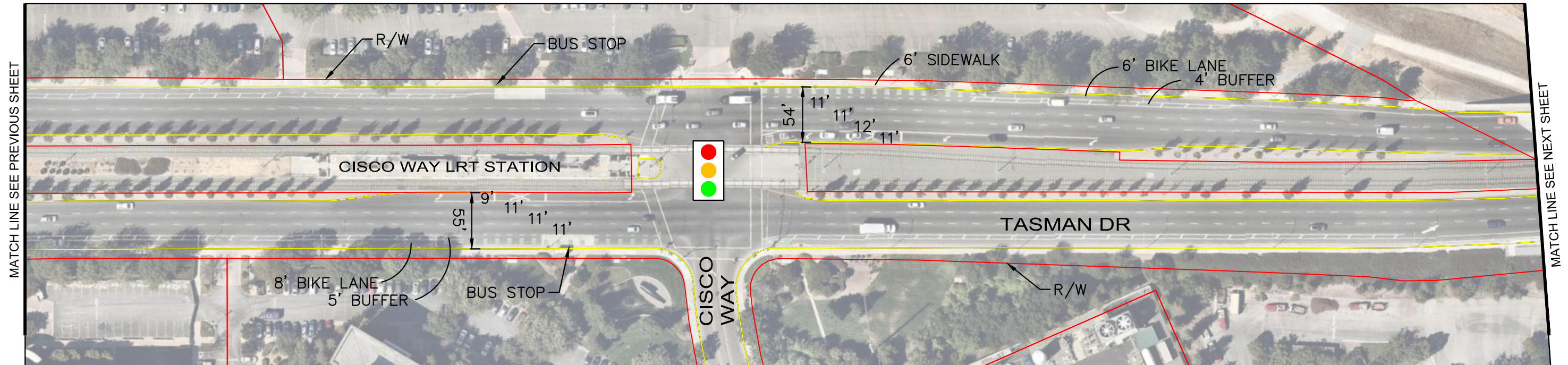

MATCH LINE SEE PREVIOUS SHEET

MATCH LINE SEE NEXT SHEET

### LEGEND

- RIGHT OF WAY/PROPERTY LINE
- CURB/SIDEWALK
- - - CITY BOUNDARY

BASE MAP  
APRIL 2017  
SHEET 20 OF 28

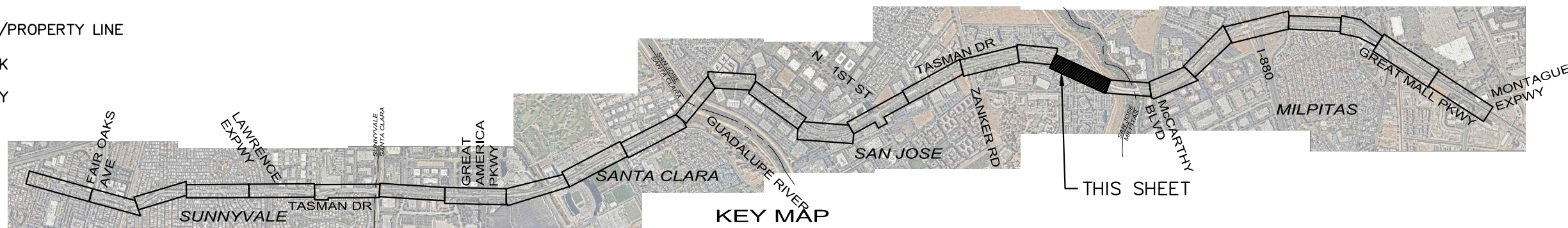

KEY MAP  
NOT TO SCALE

THIS SHEET

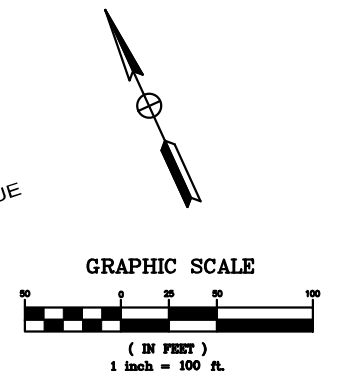



# Tasman Corridor

## COMPLETE STREETS STUDY

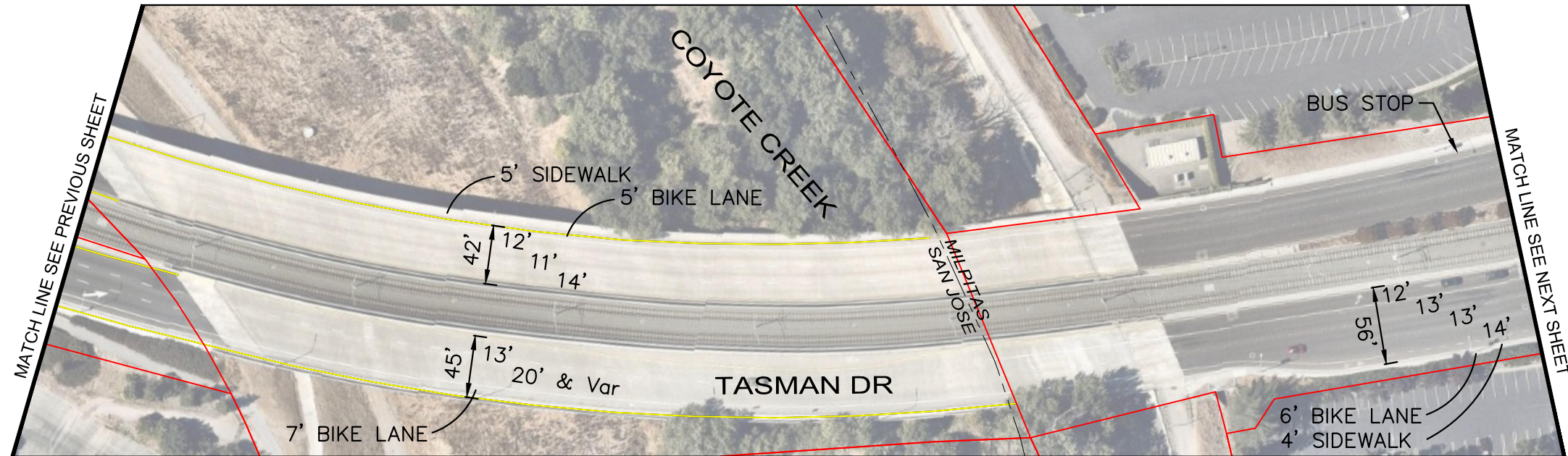

### LEGEND

- RIGHT OF WAY/PROPERTY LINE
- CURB/SIDEWALK
- - - CITY BOUNDARY

BASE MAP  
APRIL 2017  
SHEET 21 OF 28

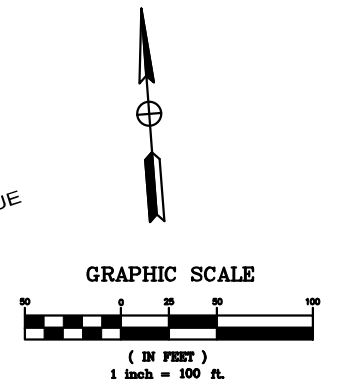
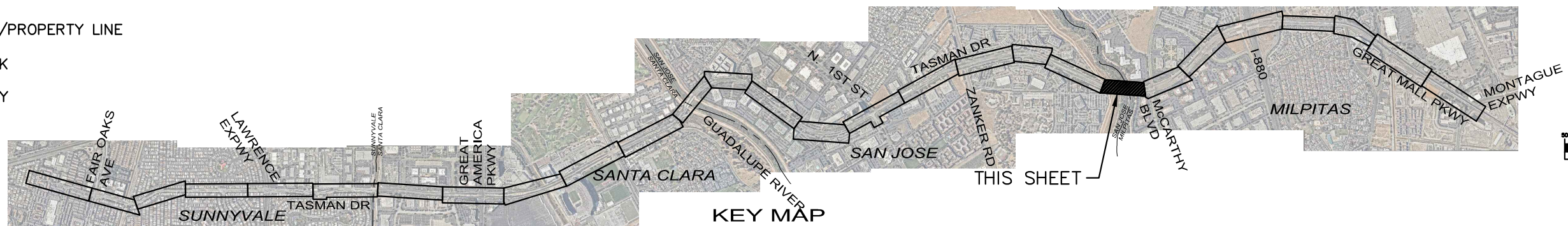



# Tasman Corridor COMPLETE STREETS STUDY

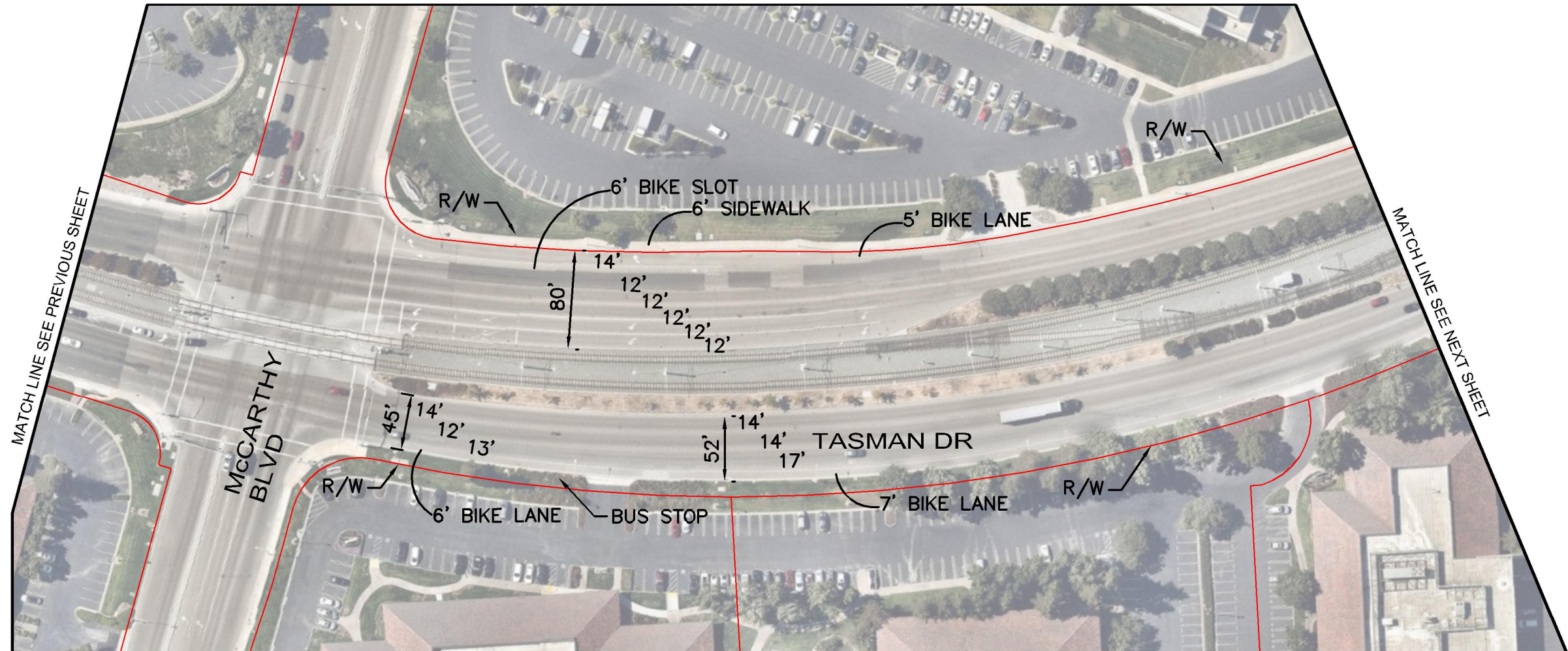

## LEGEND

- RIGHT OF WAY/PROPERTY LINE
- CURB/SIDEWALK
- CITY BOUNDARY

BASE MAP  
MAY 2017  
SHEET 22 OF 28

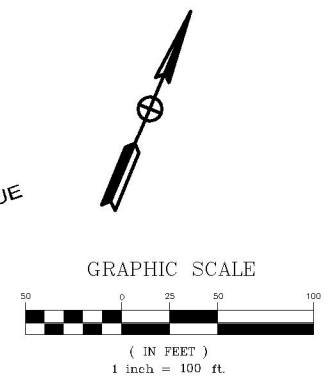
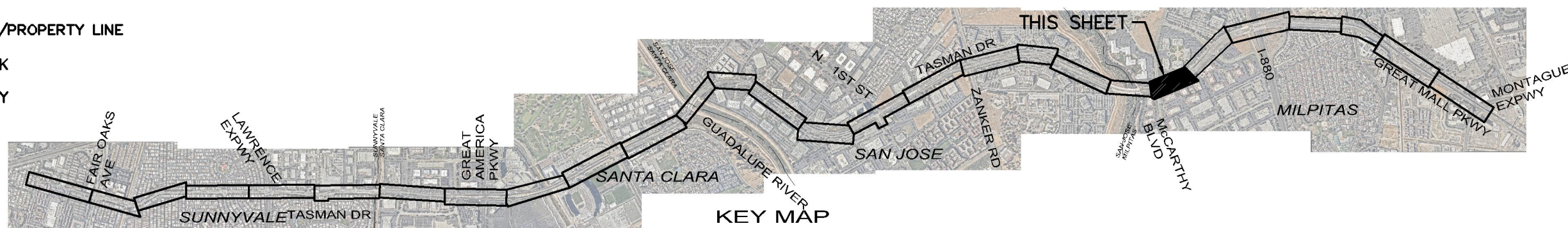



# Tasman Corridor

## COMPLETE STREETS STUDY

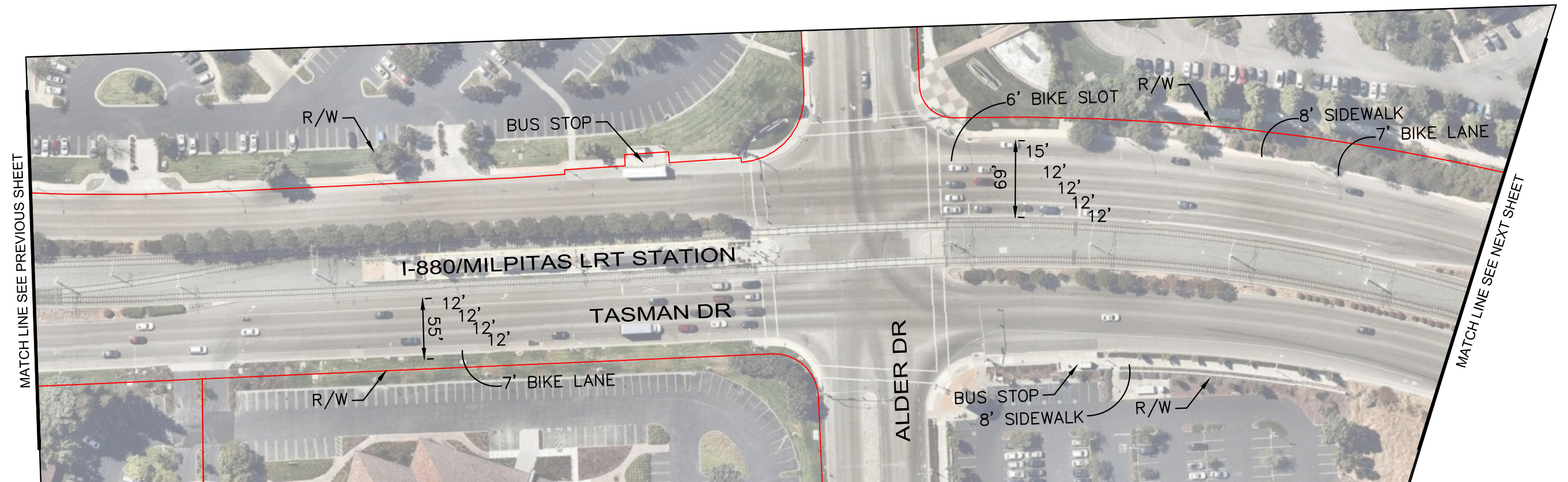

### LEGEND

- RIGHT OF WAY/PROPERTY LINE
- CURB/SIDEWALK
- - - CITY BOUNDARY

BASE MAP  
APRIL 2017  
SHEET 23 OF 28

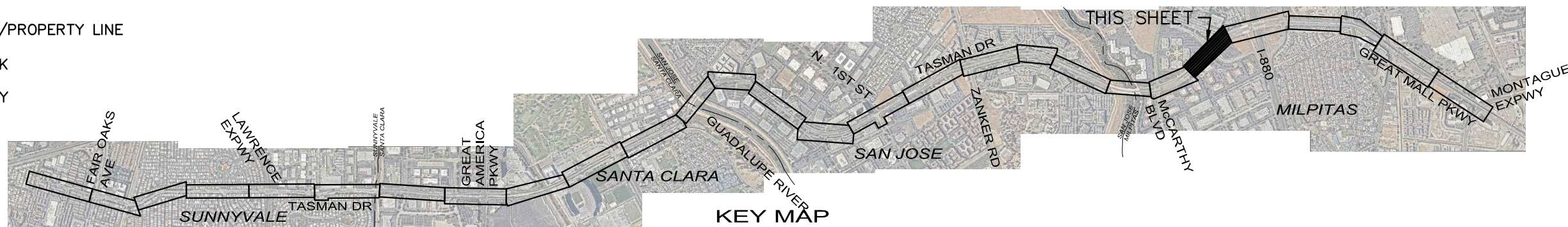

KEY MAP  
NOT TO SCALE

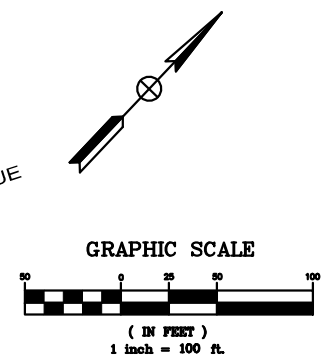







# Tasman Corridor COMPLETE STREETS STUDY

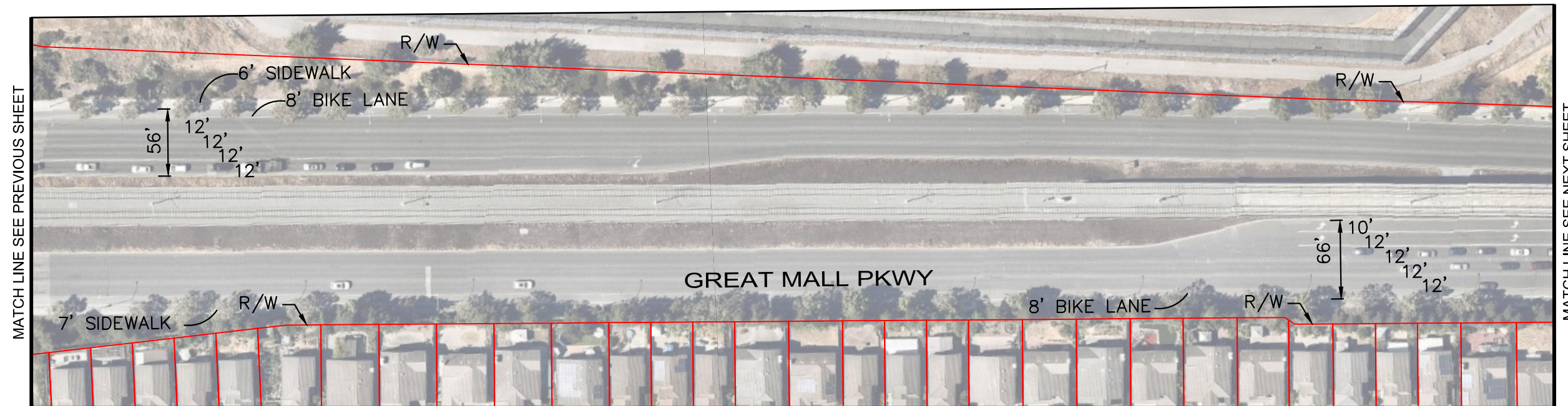

### LEGEND

- RIGHT OF WAY/PROPERTY LINE
- CURB/SIDEWALK
- - - CITY BOUNDARY

BASE MAP  
APRIL 2017  
SHEET 25 OF 28

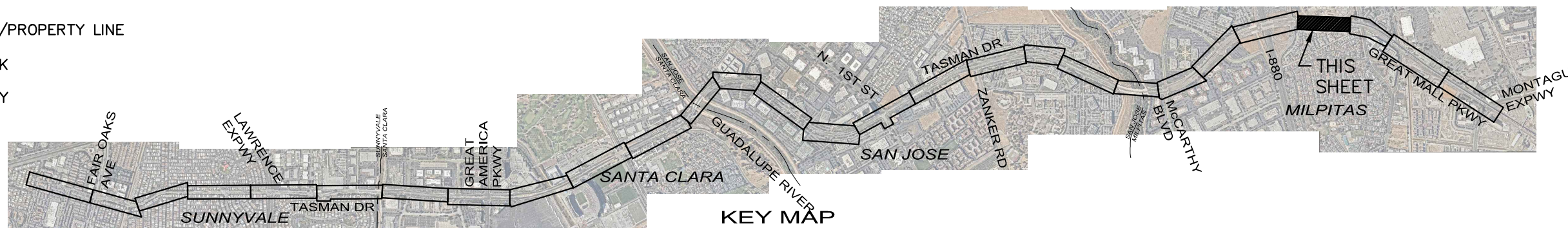

KEY MAP  
NOT TO SCALE

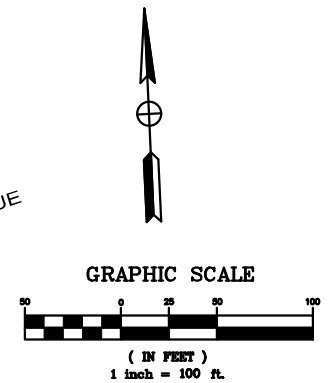

Kimley»Horn



# Tasman Corridor COMPLETE STREETS STUDY

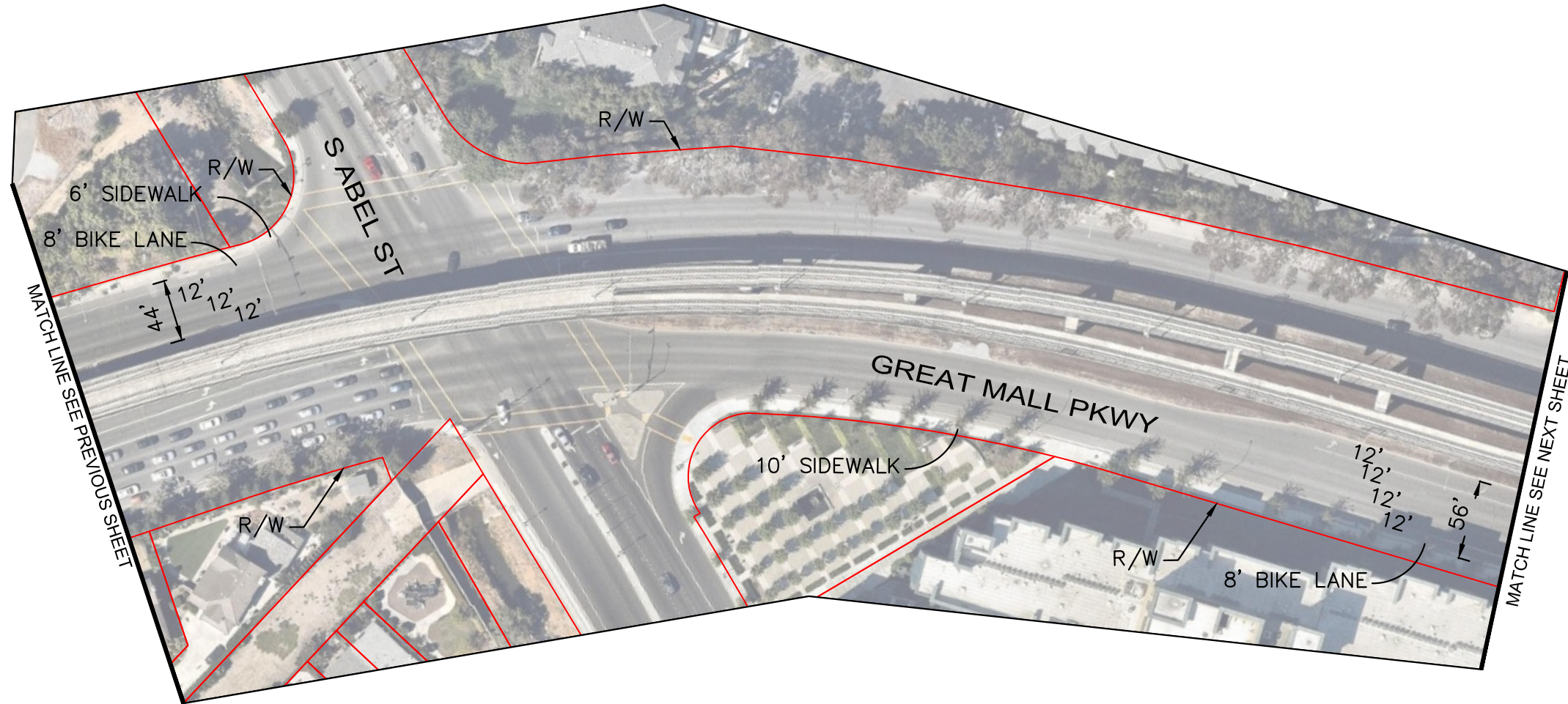

## LEGEND

- RIGHT OF WAY/PROPERTY LINE
- CURB/SIDEWALK
- - - CITY BOUNDARY

BASE MAP  
APRIL 2017  
SHEET 26 OF 28

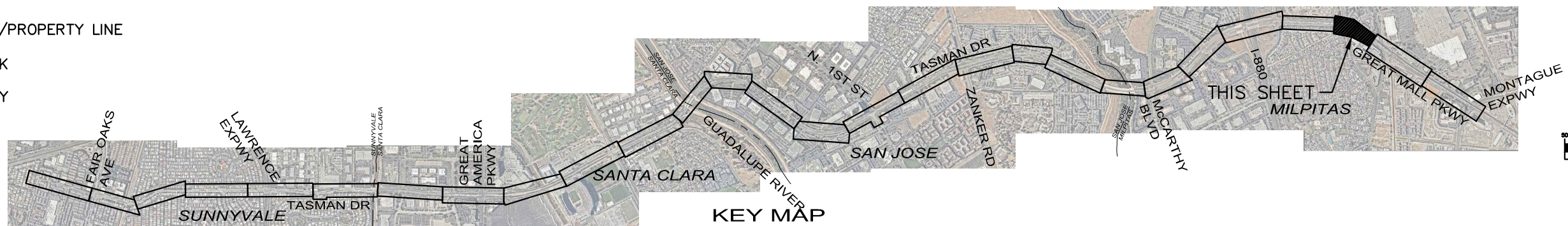

KEY MAP  
NOT TO SCALE

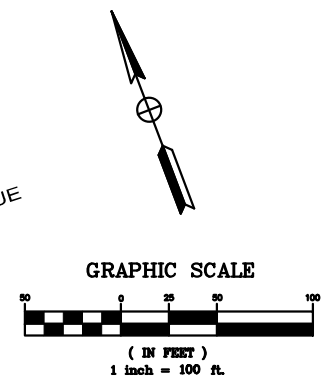



# Tasman Corridor COMPLETE STREETS STUDY

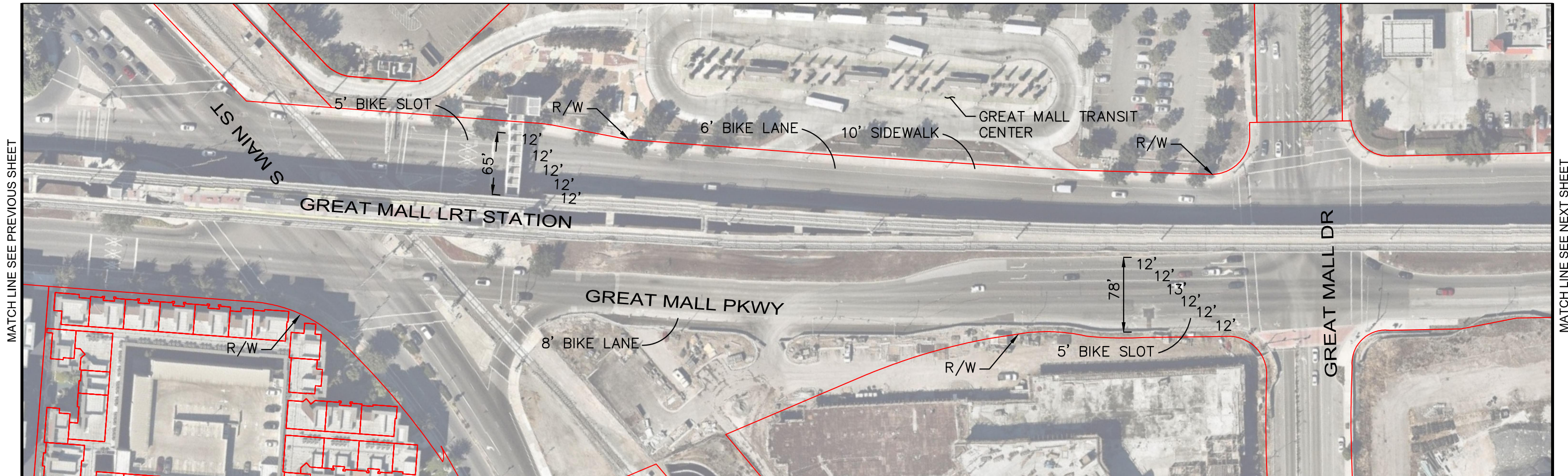

### LEGEND

- RIGHT OF WAY/PROPERTY LINE
- CURB/SIDEWALK
- - - CITY BOUNDARY

BASE MAP  
APRIL 2017  
SHEET 27 OF 28

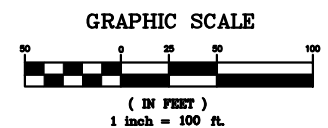
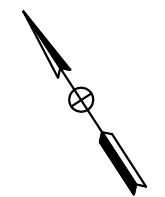
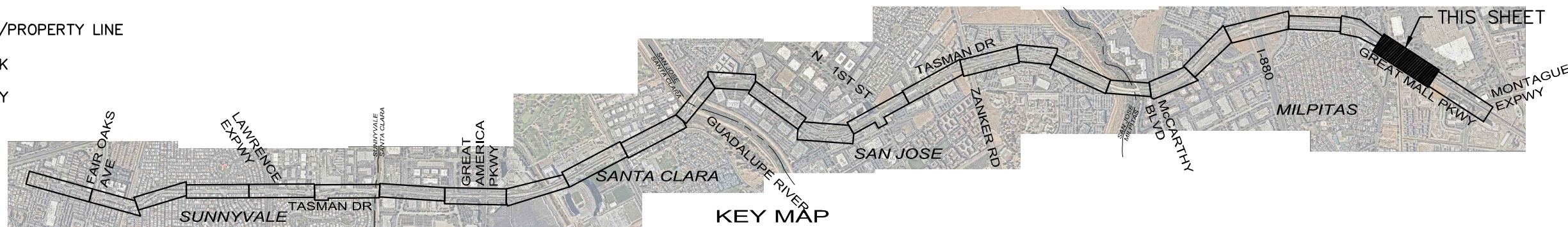



# Tasman Corridor COMPLETE STREETS STUDY

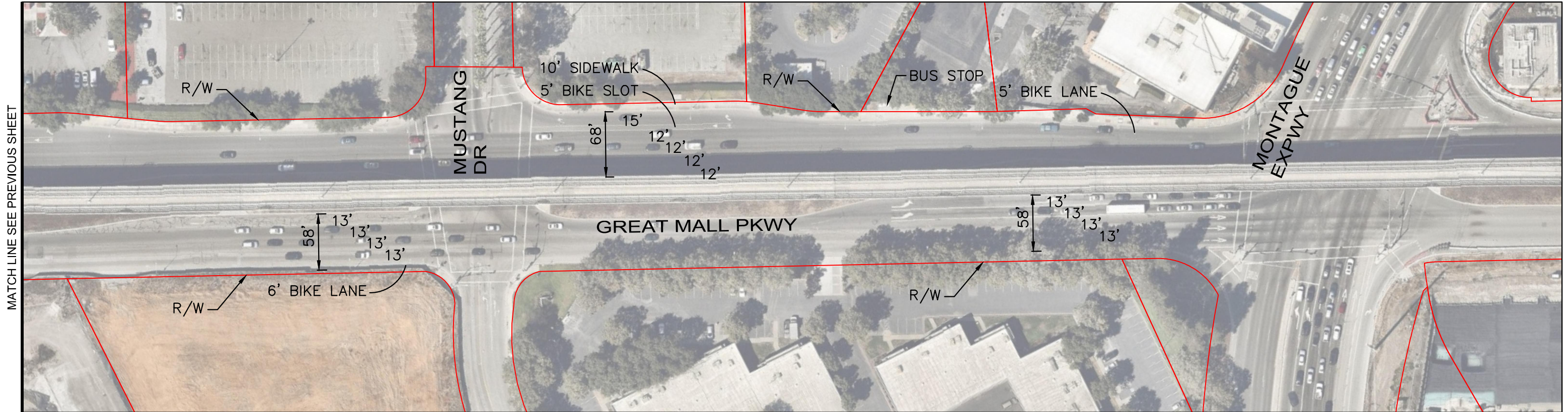

### LEGEND

- RIGHT OF WAY/PROPERTY LINE
- CURB/SIDEWALK
- - - CITY BOUNDARY

BASE MAP  
APRIL 2017  
SHEET 28 OF 28

